

D  
0  
0  
0  
3  
7  
8  
6  
9  
5  
1



UC SOUTHERN REGIONAL LIBRARY FACILITY



Maxwell  
of  
Herbounnell

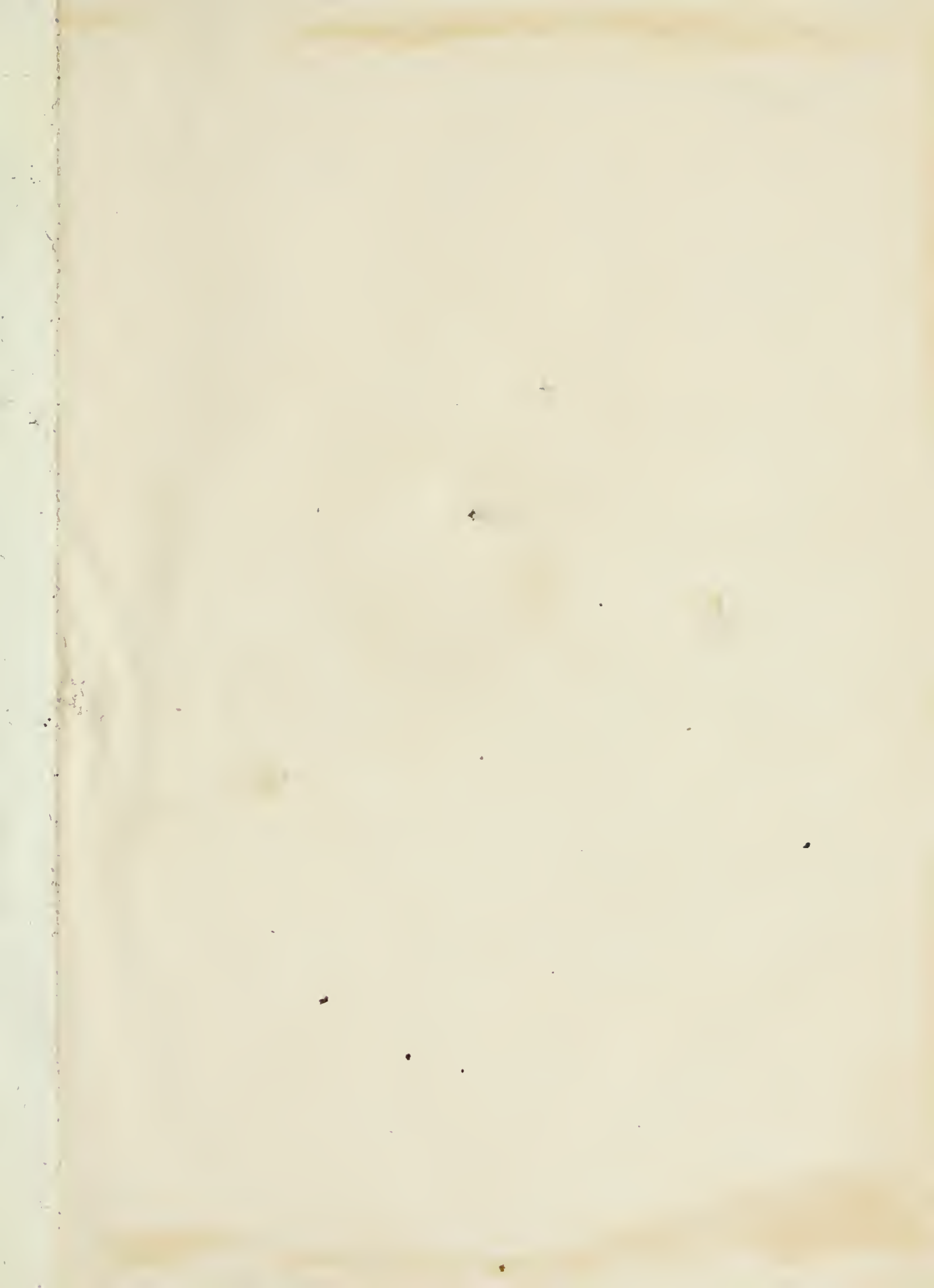







*ENCYCLOPÆDIA BRITANNICA;*  
OR, A  
D I C T I O N A R Y  
OF  
A R T S, S C I E N C E S,  
AND  
MISCELLANEOUS LITERATURE;

Constructed on a PLAN,

BY WHICH

THE DIFFERENT SCIENCES AND ARTS

Are digested into the FORM of Distinct

T R E A T I S E S O R S Y S T E M S,

COMPREHENDING

The HISTORY, THEORY, and PRACTICE, of each,  
according to the Latest Discoveries and Improvements;

AND FULL EXPLANATIONS GIVEN OF THE

VARIOUS DETACHED PARTS OF KNOWLEDGE,

WHETHER RELATING TO

NATURAL and ARTIFICIAL Objects, or to Matters ECCLESIASTICAL,  
CIVIL, MILITARY, COMMERCIAL, &c.

Including ELUCIDATIONS of the most important Topics relative to RELIGION, MORALS,  
MANNERS, and the OECONOMY of LIFE:

TOGETHER WITH

A DESCRIPTION of all the Countries, Cities, principal Mountains, Seas, Rivers, &c.  
throughout the WORLD;

A General HISTORY, *Ancient and Modern*, of the different Empires, Kingdoms, and States;

AND

An Account of the LIVES of the most Eminent Persons in every Nation,  
from the earliest ages down to the present times.

---

*Compiled from the writings of the best Authors, in several languages; the most approved Dictionaries, as well of general science as of its particular branches; the Transactions, Journals, and Memoirs, of Learned Societies, both at home and abroad; the MS. Lectures of Eminent Professors on different sciences; and a variety of Original Materials, furnished by an extensive Correspondence.*

---

THE THIRD EDITION, IN EIGHTEEN VOLUMES, GREATLY IMPROVED.

---

ILLUSTRATED WITH FIVE HUNDRED AND FORTY-TWO COPPERPLATES.

---

VOL. XVII.

---

INDOCTI DISCANT, ET AMENT MEMINISSE PERITI.

---

EDINBURGH.

PRINTED FOR A. BELL AND C. MACFARQUHAR,

MDCCCXCVII.

---

Entered in Stationers hall in Terms of the Act of Parliament.

---



# ENCYCLOPÆDIA BRITANNICA.

[History of SCOTLAND continued from the preceding Volume.]

S C O

S C O

Scotland.

Scotland.

**J**AMES could never forgive Henry for the loss of his brave officer. He sent to demand satisfaction; but all the answer he received was, that Barton and his crews were lawless pirates, and that what had been done against them ought never to have been repented amongst sovereign princes. James asserted, that Barton was no pirate, because he bore his commission; and that he ought to have been convicted of piratical acts before he was treated as being guilty of them. Henry intimated to James, that he was willing to accommodate the affair by way of negotiation; but James thought himself affronted by the proposal.

Various negotiations took place concerning this and other affairs till the year 1513; when James, though he had for some time before been fully resolved upon a war with England, thought it highly necessary that it should have the sanction of his parliament, which he assembled for that purpose. The young nobility were not only inspired with the sentiments of James, but had been won over by the French; and the majority of them, as well as of the clergy (which was somewhat extraordinary, as James was, in effect, to fight against the pope and his allies), were keen for a war with England. The old counsellors, on the other hand, who saw the flourishing state of Scotland, arising from a long peace and their commerce, which was protected by a fleet, dreaded the ruinous consequences of the war. The queen naturally headed this party; and she was joined by the earl of Angus and the wisest part of the nobility. Their arguments made no impression upon James, who had received a present from Louis of four ships laden with wine and flour, and two ships of war completely equipped, one of them carrying 34 pieces of brass ordnance. He promised to the French queen, upon his honour, that he would take the field against the English; and she had sent him a fresh letter, gently reproaching him for want of gallantry, and for not being so good as his word. In short, the reasonings of the wisest and best part of the nobility were over-ruled, and the expedition against England was resolved on.

Scotland.

360  
James resolves to invade England.

James was more exasperated than ever by this defeat, and continued his preparations for invading England with additional vigour. His queen did all that became a wife and prudent wife to divert him from his fatal purpose. She endeavoured to work upon his superstitious fears, by recounting to him her ominous dreams and boding apprehensions. James treating these as mere illusions and fictions of the brain, she had recourse to other arts. While James was waiting at Linlithgow for the arrival of his army from the north and the Highlands, he assisted one afternoon at the vespers in the church of St Michael. Being placed in one of the canon's seats, a venerable, comely man of about 52 years of age, entered, dressed in a long garment of an azure colour, and girded round with a towel or roll of linen, his forehead bald, and his yellow locks hanging down his shoulders; in short, he was dressed and

Scotland.

James was more exasperated than ever by this defeat, and continued his preparations for invading England with additional vigour. His queen did all that became a wife and prudent wife to divert him from his fatal purpose. She endeavoured to work upon his superstitious fears, by recounting to him her ominous dreams and boding apprehensions. James treating these as mere illusions and fictions of the brain, she had recourse to other arts. While James was waiting at Linlithgow for the arrival of his army from the north and the Highlands, he assisted one afternoon at the vespers in the church of St Michael. Being placed in one of the canon's seats, a venerable, comely man of about 52 years of age, entered, dressed in a long garment of an azure colour, and girded round with a towel or roll of linen, his forehead bald, and his yellow locks hanging down his shoulders; in short, he was dressed and

362  
The queen endeavours to dissuade James from his design.

363  
A phantom appears to him.

362  
The Scots defeated.

The earl of Hume, who was chamberlain of Scotland, was, at this juncture, at the head of 7000 or 8000 men, with whom he committed prodigious de-

Scotland.

formed to appear like St Andrew, the apostle of Scotland, as he is represented in painting and sculpture. The church being crowded, this personage, with some difficulty, made his way to the king's seat; and leaning over it, he spoke to the following purpose: "Sir (said he), I am sent hither to intreat you for this time to delay your expedition, and to proceed no farther in your intended journey: for if you do, you shall not prosper in your enterprize, nor any of your followers. I am further charged to warn you, if ye be so refractory as to go forward, not to use the acquaintance, company, or counsel of women, as ye tender your honour, life, and estate." After delivering those words, he retired through the crowd, and was no more seen, though, when the service was ended, James earnestly inquired after him.

That this scene was acted, seems to be past dispute; for Sir David Lindsay, who was then a young man, and present in the church, reported it both to Buchanan and Lindsay the historian. It is, however, equally certain, that the whole was a contrivance of the queen, to whose other afflictions the stings of jealousy were now added. In one of the Scotch inroads into England, one Heron, the proprietor of the castle of Ford, had been taken prisoner, and sent to Scotland; where he was detained on a charge of murder, of which he seems to have been innocent. The English historians mention this as having passed after James entered England: but from the latter part of the supposed phantom's speech, it is probable that it happened before; and that Heron's wife and beautiful daughter had been for some time soliciting James for his deliverance. Be that as it may, it is too probable that James was smitten with the charms of the daughter; and that her mother, who was a most artful woman, knew how to avail herself of the conquest. Pretending that she had interest enough to procure the release of the lord Johnston and Alexander Home, who were prisoners in England, she was permitted by James to keep a constant correspondence with the earl of Surry, to whom she is said to have betrayed all James's secrets and measures. The rendezvous of James's army was at the Burrow-moor, to which James repaired; and having given orders for the march of his artillery, he lodged at the abbey of Holyroodhouse. While he was there, another attempt was made to divert him from his purpose of invading England: but James, deaf to all the solicitations and inventions of his queen, mustered his army; and on the 22d of August he passed the Tweed, encamping that night near the banks of the Twissel. On his arrival at Twisselhaugh on the 14th, he called an assembly of his lords together, and made a declaration, that the heirs of all such as should die in the army, or be killed by the enemy during his stay in England, should have their wards, relief, and marriages of the king; who, upon that account, dispensed with their age. This is said to have been the crisis of that prince's fate. Abandoned to his passion for his English mistress, she prevailed with him, at her mother's instigation, to trifle away his time for some days; during which interval, the junction of the English army was formed. The earl of Surry, the English general, was then at Pomfret: but ordered the landholders of the neighbouring counties to certify to him in writing what number of men each could furnish, charging them to

be ready at an hour's warning; and he laid his plan so, as not to bring his army into the field till James had advanced so far into England as to render it very difficult for him to retire without a general battle. This precaution assisted the lady Ford (as she is called) in persuading James that there was no danger in the delay, because the English had not the face of an army in the field.

In the mean time, the earl of Surry ordered the governors of Berwick and Norham, the two strongest places on the frontiers of England, to prepare for a vigorous resistance in case they were attacked; and directed them to certify how long they could hold out, in hopes, that if they made a resolute defence, James would march on, and leave them in his rear. The governor of Norham's answer was, that his castle was so well provided, as to leave him no doubt, in case of a siege, to be able to defend it till king Henry should return from abroad, and relieve it in person. James, however, besieged it on the 25th of August, and battered it so furiously, that he took it by capitulation the sixth day after. James then proceeded to the castle of Etal belonging to the family of Manners (now duke of Rutland); which he took and demolished likewise, as he also did Wark, and arrived before the castle of Ford. The Scotch army is generally allowed to have consisted of at least 50,000 men when it passed the Tweed. At this time it was encamped on the heights of Cheviot, in the heart of a country naturally barren, and now desolate through the precautions taken by the English general. Being obliged to extend their quarters for the benefit of subsistence, the mercenary part of them had acquired a considerable plunder, with which, as usual, they retired to their own country, as many more did for want of subsistence. The earl of Surry knew their situation, and ordered the rendezvous of his army, first at Newcastle, and then near Norham, having certain intelligence of the vast desertions daily happening in the Scotch army, which had reduced it greatly. The wetness of the season rendered his march, especially that of the artillery, extremely difficult; but being joined by several parties of distinction, he marched on the 3d of September to Alnwick, where he was reinforced by 5000 hardy veteran troops, sent from the English army on the continent, under the command of his son the lord-admiral of England; so that the English authors admit his army to have consisted of 26,000 men, all completely armed and provided for the field. James having, in the manifesto which he dispersed on his entering England, given the death of Barton as one of the causes of his invasion, the lord-admiral had prevailed with Henry to send him upon this service; and he informed James by a letter, that he intended to justify the death of that pirate in the front of the English army.

By this time the army of James was, by desertion and other causes, reduced to less than half its numbers; but the chief misfortune attending it was his own conduct. His indolence and inactivity, joined to the scandalous examples of his amours, at such a season, had disgusted several of his greatest men and best friends; and some of them more than suspected a correspondence between the English lady and the earl of Surry. James was deaf to all their remonstrances; and the earl of Angus declared, that he was resolved to return home, as he foresaw that the ruin of the army was inevitable through

364  
James de-  
luded by  
his mistress.

Scotland.

365  
The Scots  
take the  
castles of  
Norham,  
Etal, and  
Wark.

366  
James dis-  
cuss feve-  
ral of his  
nobility.

*Scotland.* through the obstinacy of James. He accordingly withdrew to Scotland, but left behind him his two sons. The lord Hume and the earl of Huntley were likewise discontented. The former had brought his men into the field; but, according to some Scotch historians, with a design rather to betray than to serve James; but Huntley, though he disliked his master's conduct, remained firmly attached to his person.

The defection or backwardness of those great men seemed to make no impression upon James. He had chosen a strong camp in the neighbourhood of Ford, on the side of a mountain called Floddon-hill; and he was separated from the English army by the river Till. This advantageous situation put the earl of Surry under great difficulties; for it rendered the Scotch army inaccessible, as it was fortified by artillery, and was now well supplied with provisions by the change of its situation. The earl drew up a manifesto, with which he charged Rouge Croix herald, who was attended by a trumpet. It contained some proposals for an exchange of prisoners, which seems to have been calculated to give the lady Ford the more credit with James; but concluded with reproaches for his perfidious invasion of England, and a defiance to James to fight him in a general battle. The herald was farther charged with a verbal commission to acquaint James, that the earl of Surry had issued orders that no quarter should be given to any of the Scotch army but the king himself.

A council of war was called on this occasion; in which the earl of Huntley and others made strong remonstrances against a general engagement. They shewed how fatal it must be to Scotland, should it prove unsuccessful; and that the wisest course James could follow was to return home, where, if he was pursued by the enemy, he could fight to great advantage. The earl of Huntley, however, added, that his opinion should be determined by that of the king and council; and that he was equally ready to share in his majesty's danger as his glory.

Huntley and the other noblemen were opposed by the French ambassador, who represented a retreat as disgraceful to the nobility of Scotland and the arms of James; and used many romantic arguments of the same kind, which but too well suited with the king's disposition. According to Drummond, the council were of opinion, that the king should immediately besiege Berwick; but be that as it will, the majority of them were certainly of opinion, that it was beneath the dignity of James to fight the earl of Surry at that nobleman's requisition, and that James could lose no honour by returning home. Patrick lord Lindsay of Byres, mentioned on a former occasion, and who was president of the council, expressed himself so strongly on that head, that James, in a passion, is said by the historian Lindsay to have sworn, that if ever he lived to return to Scotland, he would hang that nobleman at his own gate. He ordered Rouge Croix to be called in; and after treating him with great politeness, he sent a message to the earl of Surry by one of his own heralds (Islay), importing, that he would give the English battle on the Friday following; and that had he received such a message from the earl even in his own castle of Edinburgh, he would have left that, and all other business, to have fought him. With this message,

a small manifesto, in vindication of James's conduct, was sent by the same herald.

*Scotland.*

The earl of Surry, who was then so infirm that he was carried about in a sedan or chariot, had foreseen that James would return an answer by one of his own heralds; but, unwilling that he should obtain any knowledge of the situation of the English camp, he ordered proper persons to receive him at two miles distance, where soon after he attended himself in person. Islay executed his commission without paying much respect to the person of the English general; who dismissed him, after bestowing great compliments upon the honour and courage of James. The earl then ordered his army to march in the line of battle towards Wollerhaugh. There he was joined by Rouge Croix, herald, who gave him an account of the strong situation of the Scottish camp; but the advanced posts of the English army were then within three miles of their enemies, and the earl of Surry found his difficulties daily increasing. The roads were broken up, the swelling of the rivers cut him off from the necessary communications for supplying his army, and nothing but a battle could save him either from being disbanded or destroyed.

James seems to have so far regarded the advice of his wisest counsellors, as not to abandon his strong situation. They endeavoured to persuade him, that it was a sufficient guard to his honour, if he did not decline the battle on the day appointed; and that his engagement did not bind him to fight upon disadvantageous ground. The Scots, at the same time, knew of their enemy's distresses; and, as Drummond elegantly expresses it, they remonstrated to their king, that he lacked nothing but patience to be victorious. The Scots thus lying on the defensive, the earl of Surry again sent Rouge Croix to inform James that he was ready to give him battle. James was sensibly nettled at this tacit imputation upon his honour, and perhaps was inwardly vexed for having followed the wise advice of his noblemen. It is certain, from the best authorities, that he neglected the necessary precautions for guarding the passages of the Till, which the English crossed, partly at a place where it was fordable, and partly at a bridge. We are told, not without a great appearance of probability, that while the English were passing the bridge, Borthwick, master of the Scotch artillery, fell upon his knees, and begged permission from James to point his cannon against the bridge; but that James answered him in a passion, that it must be at the peril of his (Borthwick's) head, and that he was resolved to see all his enemies that day on the plain before him in a body. The earl of Surry, after passing the Till, took possession of Braxton, which lay to the right of the Scotch camp; and by that situation he cut off the communication of his enemies with the Tweed, and commanded the Till below Eton-castle. The Scotch generals saw themselves now in danger of being reduced to the same straits in which their enemies had been involved two days before, and their country open to an invasion of the English army. James had secret intelligence that this was far from being the intention of the English general; and imagining that the latter's intention was to take possession of a strong camp upon a hill between him and the Tweed, which would give the English a farther command of the country, he resolved to be be-

367  
Encamps  
in an ad-  
vantageous  
situation.

368  
Resolves  
to fight,  
contrary to  
the opi-  
nion of all  
his officers.

369  
His im-  
den: c. un-  
duct.

<sup>Scotland.</sup> fore-hand with the earl, and gave orders for making large fires of green wood, that the smoke might cover his march along the height, to take advantage of that eminence. But while this stratagem concealed his march from the English, their movements were concealed from him: for when he came to the brow of the height over which he had marched, he found the enemy drawn up in order of battle on the plain, but so close to the height where he was, that his artillery, on which his great dependence was, must overshoot them.

370  
Account of  
the battle of  
Malden.

A battle was now not only unavoidable, but the only means of saving the Scotch army, which was probably far from being a disagreeable circumstance to James. His person was so dear to his troops, that many of them dressed themselves as nearly as they could in the same coats of armour and with the same distinctions that James wore that day. His generals had earnestly desired him to retire to a place of safety, where his person would be secure in all events: but he obstinately refused to follow their advice; and on the ninth of September, early in the morning, dispositions were ordered for the line of battle. The command of the van was allotted to the earl of Huntley; the earls of Lenox and Argyll commanded the Highlanders under James, who, some say, served only as a volunteer; and the earls of Crawford and Montrose led the body of reserve. The earl of Surry gave the command of his van to his son, the lord-admiral; his right wing was commanded by his other son, Sir Edward Howard; and his left by Sir Marmaduke Constable. The rear was commanded by the earl himself, lord Dacres, and Sir Edward Stanley. Under those leaders served the flower of all the nobility and gentry then in England. Other writers give different accounts of the disposition of the English army, but they may be reconciled by the different forms into which the battle was thrown before it was decided. The lord Hume is mentioned as serving under the earls of Crawford and Montrose, and Hepburn earl of Bothwell was in the rear.

The first motion of the English army was by the lord-admiral, who suddenly wheeled to the right, and seized a pass at Milford, where he planted his artillery so as to command the most sloping part of the ascent where the Scots were drawn up; and it did great execution. The Scots had not foreseen this manœuvre; and it put them into such disorder, that the earl of Huntley found it necessary to attack the lord-admiral; which he did with so much fury, that he drove him from his post; and the consequence must have been fatal to the English, had not his precipitate retreat been covered by some squadrons of horse under the lord Dacres, which gave the lord-admiral an opportunity of rallying and new-forming his men. The earl of Surry now found it necessary to advance to the front, so that the English army formed one continued line, which galled the Scots with perpetual discharges of their artillery and bows. The Highlanders, as usual, impatient to come to a close fight, and to share in the honour of the day, which they now thought their own, rushed down the declivity with their broad-swords, but without order or discipline, and before the rest of the army, particularly the division under lord Hume, advanced to support them. Their impetuosity, however, made a considerable impression upon the main battle of the English; and the king bringing up the earl of

<sup>Scotland.</sup> Bothwell's reserve, the battle became general and doubtful: but by this time the lord-admiral, having again formed his men, came to the assistance of his father, and charged the division under the earls of Crawford and Montrose, who were marching up to support the Highlanders, among whom the king and his attendants were now fighting on foot: while Stanley, making a circuit round the hill, attacked the Highlanders in the rear. Crawford and Montrose, not being seconded, according to the Scotch historians, by the Humes, were routed; and thus all that part of the Scotch army which was engaged under their king, was completely surrounded by the division of the English under Surry, Stanley, and the lord-admiral. In this terrible situation, James acted with a coolness not common to his temper. He drew up his men in a circular form, and their valour more than once opened the ranks of the English, or obliged them to stand aloof, and again have recourse to their bows and artillery. The chief of the Scotch nobility made fresh attempts to prevail with James to make his escape while it was practicable; but he obstinately continued the fight; and thereby became accessory to his own ruin, and that of his troops, whom the English would gladly have suffered to retreat. He saw the earls of Montrose, Crawford, Argyll, and Lenox, fall by his side, with the bravest of his men lying dead on the spot; and darkness now coming on, he himself was killed by an unknown hand. The English were ignorant of the victory they had gained; and had actually retreated from the field of battle, with a design of renewing it next morning.

371  
The Scots  
defeated,  
and their  
king killed.

This disaster was evidently owing to the romantic disposition of the king himself, and to the want of discipline among many of his soldiers; though some writers have ascribed it to the treachery of lord Hume. Many of James's domestics knew and mourned over his body; and it appeared that he had received two mortal wounds, one through the trunk with an arrow, and the other on the head with a ball. His coat of armour was presented to queen Catharine, who informed her husband, then in France, of the victory over the Scots. The loss on both sides, in this engagement, is far from being ascertained; though Polydore Virgil, who lived at the time, mentions the loss of the English at 5000, and that of the Scots at 10,000.

After the death of king James IV. the administration devolved on the queen-dowager; but she being big with a posthumous child, and unable to bear the weight of public business, accepted of Beaton archbishop of Glasgow and chancellor of Scotland, with the earls of Huntley, Angus, and Arran, to assist her in the affairs of government. Soon after her husband's death she had wrote an affecting letter to her brother the king of England, informing him of her pregnancy, setting forth the deplorable state of the kingdom, with her own condition, and imploring his friendship and protection for herself and her infant son. This letter seems never to have been communicated by Henry to his council; but he answered it, and informed his sister, that if the Scots would have peace, they should have peace, and war if they chose it. "He added (according to Drummond), that her husband had fallen by his own indiscreet rashness, and foolish kindness to France; that he regretted his death as his ally, and should be willing to prohibit all hostility against the country of Scotland during

372  
The queen-  
dowager as-  
sumes the  
government.

373  
Writes to  
the king of  
England.

Scotland. during the minority of her son. For a remedy of present evils, one year's truce and a day longer was yielded unto; in which time he had leisure to prosecute his designs against France, without fear of being disturbed or diverted by the incursions and inroads of the Scots upon his borders."

374  
The Scotch affairs in great confusion.

Thus far Drummond: but though Henry might grant this time to his sister's intreaty, yet it certainly did not become a national measure; for it appears by a letter dated two years after, from the Scots council to the king of France, published by Rymer, that the Scots never had desired a truce. So far from that, the French influence, joined to a desire of revenge, remained so strong in the kingdom, that after the meeting of the parliament, some of the members were so violent as to propose a renewal of the war. This motion was indeed over-ruled by the more moderate part of the assembly: but they could not be brought to make any advances towards Henry for a peace; and every day was now big with public calamity, which seems to have gathered strength while the queen was in child-bed. The archbishopric of St Andrew's being vacant, it was offered by universal consent to Elphinston bishop of Aberdeen; but being now old and infirm, he declined it. Three competitors for that high dignity then appeared. The first was Gawin Douglas, who was then abbot of Aberbrothwic, to which he was presented by the queen upon her recovery (having been brought to bed of a son) the very day before her marriage with his nephew the earl of Angus: and upon the death of bishop Elphinston in November following, she presented him likewise to the archbishopric of St Andrew's. The second competitor was John Hepburn, prior of St Andrew's; a bold, avaricious, restless, but shrewd and sensible priest. By his office he had received the rents of the see during its vacancy; and having prevailed with the canons, on pretence of ancient privileges, to elect him archbishop, without regard to the nomination either of the queen or pope, he drove Douglas's servants from the castle of St Andrew's, of which they had taken possession. The third and most powerful competitor was Forman bishop of Moray in Scotland, and archbishop of Bourges in France, a dignity to which he had been raised for his public services. He had in his interest not only the duke of Albany (son to the traitor duke) first prince of the blood, but also the court of Rome itself; and having received the pope's bull and nomination to the dignity, he was considered by the Scotch clergy in general, and by the principal tenants and dependents upon the see, as the legal archbishop.

The preference given to Forman discouraged Douglas from pursuing his pretensions; but Hepburn, being supported by the clan of his own name and by the Humes, made so formidable a head against his rivals, that none could be found daring enough to publish the papal bull in favour of Forman. The friends of the latter, however, having intimated to the earl of Hume, that his credit at the court of Rome could easily procure the rich abbey of Coldingham for his younger brother, the earl put himself at the head of his followers, and, notwithstanding all the opposition given by the Hepburns, he proclaimed the pope's bull over the cross of Edinburgh. This daring action plainly proved that the earl of Hume had more power than

the queen-regent herself; but Hepburn's resolution, and the greatness of his friends, obliged Forman to agree to a compromise. Hepburn was advanced to the see of Moray, without accounting for the revenues of the archbishopric, which he had received during its vacancy; and he gave Forman a present of three thousand crowns, to be divided among his friends and followers.

In April 1514, the posthumous son, of whom the queen had been delivered in Stirling castle, was by the bishop of Caithness baptized Alexander. On the 6th of August this year she was married to the earl of Angus; than which nothing could be accounted more impolitic. She had neither consulted her brother nor the states of Scotland in the match; and by her having accepted of a husband, she in fact resigned all claim to the regency under the late king's will. The Douglasses did not dispute her having divested herself of the regency: but they affirmed, that the states might lawfully reinstate her in it; and that the peace of the kingdom required it, as it was the only measure that could preserve the happy tranquillity which then subsisted between Scotland and England. The earl of Hume put himself at the head of the opposition to this proposal. He knew that he had enemies, and he dreaded that the farther aggrandizement of Angus must weaken his interest on the borders. He was joined by a number of the young nobility, who, though otherwise divided, united against Angus. In short, the general opinion was, that the Douglasses were already too great; and that, should the queen be reinstated in the regency, they must be absolute within the kingdom, and engross all places of power and profit. It was added by the earl of Hume, that he had, out of respect to the late king's memory, submitted to the queen's government; and that, now she had made a voluntary abdication of it by her marriage, it ought not to be renewed.

Scotland.  
375  
The queen-dowager married to the earl of Angus.

After some deliberations, the duke of Albany was chosen regent. He was a man possessed of all the qualities requisite for a good governor; nor did he deceive the expectations of the public. On his arrival at Glasgow, he took upon him the titles of earl of March, Marr, Garioch, lord of Annandale, and of the isle of Man, regent and protector of the kingdom of Scotland. On his arrival at Edinburgh he was received in form by the three estates of the kingdom, and the queen had met him at some distance from the town. The parliament then resumed its session, and the three estates took an oath of obedience, till the king, then an infant of four years old, should arrive at the years of maturity.

376  
The duke of Albany chosen regent.

The first thing at which the regent aimed, was the conciliating the differences amongst the various contending families in the kingdom; at the same time that he suppressed some during robbers; one of whom is said to have had no fewer than 800 attendants in his infamous profession. So great was his love of good order and decency, that he punished the lord Drummond with the loss of his estate for having struck Lyon king at arms, whose person, as the first herald in Scotland, ought to have been held sacred. Nay, it was at the earnest solicitation of Lyon himself, and many of the chief nobility, that a greater punishment was not inflicted. However, the forfeiture was afterwards remitted;

Scotland. remitted; but not before Drummond had, upon his knees, acknowledged his offence, and submitted himself before Lyon.

<sup>377</sup> He, burn becomes his chief favourite. The regent had not been long in office before he took into favour Hepburn the prior of St Andrew's, whom he consulted for information concerning the state of Scotland. Hepburn acquainted him with all the feuds and animosities which raged among the great families of Scotland, their ferocious character, and barbarous behaviour to their enemies. He represented the civil power as too weak to curb these potent chieftains; and gave it as his opinion that the regent's administration ought to be supported by foreign arms, meaning those of France.

Hepburn is said also to have gained an ascendancy over the regent by means of large sums of money laid out among his domestics, by a fawning and plausible address, and by well-directed flatteries; and he employed this ascendancy to destroy those who were obnoxious to himself. The earl of Hume, as being the first subject in rank and authority, became obnoxious to the regent through the insinuations of Hepburn; and as that nobleman had frequent occasion to be at court in virtue of his office of chamberlain, he soon perceived that neither he nor his friends were welcome guests there. Alarmed for his own safety, he resolved to form a party amongst with the queen-mother and her new husband against the regent. This was by no means a difficult task: for the queen naturally imagined that her new husband ought to have had some share in the government; and the earl of Angus readily concurred in the scheme. In the mean time, the regent was making a progress through Scotland, while bloody feuds were raging among the nobles: but before any remedy could be applied to these disorders, he was informed of the schemes laid by the queen-mother and her party; and that she had resolved to fly into England with her two infants. On this he instantly returned to Edinburgh; and, as no time was to be lost, set out at midnight that very night, and surpris'd the castle of Stirling, where he found the queen-mother and her two infants.

The regent, after this bold step, took care to show that the care of the royal infants was his chief study. As he himself was nearly allied to the crown, in order to remove all suspicions and calumnies on that account, he committed the care of the king and his brother to three noblemen of the most unexceptionable characters in the kingdom, but of whom we now know the name only of one, viz. the earl of Lenox. They were appointed to attend the princes by turns; to whom also a guard, consisting partly of French and partly of Scots, was assigned; and the queen-mother was left at liberty to reside where she pleased.

<sup>379</sup> Who is driven into England. The earl of Hume, finding his schemes thus abortive, retired to his own estate; from whence he was soon after drawn, and obliged to fly into England, by the earls of Arran and Lenox. The queen-mother retired to a monastery at Coldstream; and messengers were dispatched to the court of England, to know how Henry would have his sister disposed of. He ordered the lord Dacres, his warden of the marches, to attend her to Harbottle-castle in Northumberland; and here she was delivered of her daughter the Lady Mary Douglas, mother to Henry lord Darnley, father to James I.

of England. The regent dispatched ambassadors to Hen-<sup>Scotland,</sup>ry, in order to vindicate his own conduct. He likewise sent to assure the queen that she had nothing to fear in Scotland; and to invite her to return thither, where she should at all times be admitted to see her children. This offer, however, she declined; and set out for Lon-<sup>380</sup>The queen goes to England. don, where she was affectionately received and entertained by her brother. But in the mean time many disorders were committed throughout the kingdom by the party of the queen-mother; though, by the interposition of archbishop Foran, they were at present terminated without bloodshed, and some of the principal offenders were persuaded to return to their duty. Among these was the earl of Angus himself, the queen's <sup>381</sup>Her husband goes to the regent. husband; which when king Henry heard, he exclaimed, "That the earl, by deserting his wife, had acted like a Scot." Lord Hume refused to surrender himself, or to accept of the regent's terms; and was of consequence declared a traitor, and his estate confiscated. All this time he had been infesting the borders at the head of a lawless banditti; and now he began to commit such devastations, that the regent found it necessary to march against him at the head of 1000 disciplined troops. Hume being obliged to lay down his arms, was sent prisoner to Edinburgh castle; where the regent very unaccountably committed him to the charge of his brother-in-law the earl of Arran. Hume easily found means to gain over this near relation to his own party; and both of them, in the month of October 1515, escaped to the borders, where they soon renewed <sup>382</sup>Rebellion and commotions in different places. hostilities. Both the earls were now proclaimed traitors, but Hume was allowed fifteen days to surrender himself. This short interval the regent employed in quashing the rebellion, for which purpose the parliament had allowed him 15,000 men. He besieged the castle of Hamilton, the earl of Arran's chief seat, which was in no condition of defence; but he was prevailed upon by Arran's mother, daughter to James II. and aunt to the regent himself, to forbear further hostilities, and even to pardon her son, provided he should return to his duty. Arran accordingly submitted; but the public tranquillity was not by that means restored. An association, at the head of which was the earl of Moray, the king's natural brother, had been formed against the earl of Huntley. That nobleman was too well attended to fear any danger by day; but his enemies found means to introduce some armed troops in the nighttime into Edinburgh. On this a fierce skirmish ensued, in which some were killed on both sides; but farther bloodshed was prevented by the regent, who confined all the lords in prison till he had brought about a general reconciliation. One Hay, who had been very active in stirring up the quarrels, was banished to France; and only the earl of Hume now continued in arms.

In 1516 died the young duke of Rothesay: an event which brought the regent one degree nearer the crown, so that he was declared heir in case of the demise of young James. Negotiations were then entered into about prolonging the truce which at that time subsisted with England; but Henry insisting upon a removal of the regent from his place, they were for the present dropped. Finding, however, that he could neither prevail on the parliament as a body to dismiss the regent, nor form a party of any consequence against him,

Scotland. he at last consented to a prolongation of the truce for a year.

<sup>383</sup> The earl of Hume put to death. In 1517, the affairs of the regent requiring his presence in France, he resolved, before his departure, to remove the earl of Hume, who, as we have seen, alone continued to disturb the public tranquillity. Under pretence of settling some differences which still remained with England, he called a convention of the nobility; and sent special letters to the earl of Hume and his brother to attend, on account of their great knowledge in English affairs. Both of them imprudently obeyed the summons, and were seized and executed as soon as they arrived at Edinburgh. But whatever occasion there might be for this severity, it lost the affections of the people to such a degree, that the regent could scarce get the place filled up which Lord Hume had possessed. That of lord warden of the marches he at last gave to his French favourite La Beaute, called by historians Sir Anthony D'Arcy. The post of lord chamberlain was given to Lord Fleming. Soon after this, the regent levied an army, on pretence of repressing some disturbances on the borders. These being speedily quelled, he seized on his return upon the earl of Lenox, and forced him to deliver up his castle of Dumbarton; not choosing to leave it, during his intended absence in France, in the custody of a nobleman of suspected fidelity; and from similar motives, he afterwards took him along with him on his departure for the continent. He then procured himself to be nominated ambassador to France, in which character he left the kingdom; having committed the government to the archbishops of St Andrew's and Glasgow, the earls of Arran, Angus, Huntley, and Argyle, with the warden D'Arcy, on whom was his chief dependence.

<sup>384</sup> The regent goes to France, and the queen returns to Scotland. On the departure of the regent, the queen-mother left the English court; and arrived with a noble retinue at Berwick, on purpose to visit her son. Here she was received by her husband; for whom she had contracted an invincible aversion, either on account of his infidelities to her bed, or because he had deserted her in the manner already related. However, she suppressed her resentment for the present, and accompanied him to Edinburgh. Here, in consequence of the proposals made by the regent, she demanded access to her son; but was refused by D'Arcy. Lord Erskine, however, who was one of those to whom the care of the young king was committed, conveyed him to the castle of Craigmillar (where D'Arcy had no jurisdiction), on pretence that the plague was in Edinburgh; and there the queen was admitted; but this gave such offence to D'Arcy, that Lord Erskine was obliged to carry back the king to the castle of Edinburgh, where all further access was denied to his mother. In short, the behaviour of this favourite was on all occasions so haughty and violent, that he rendered himself universally odious; and was at last murdered, with all his attendants, in his way to Dunse, where he proposed to hold a court of justice.—His death was very little regretted; yet his murderers were prosecuted with the utmost severity, and several persons of distinction declared rebels on that account.

Meanwhile, the regent was treated with high marks of distinction in France. The king showed him the greatest respect, promised to assist in establishing his

authority in Scotland, and solemnly confirmed the ancient league between the two kingdoms. Soon after, the earl of Lenox arrived from France, with assurances of protection and assistance from the king, who was highly pleased at the zeal of the governors in punishing D'Arcy's murderers; and 500 soldiers arrived with him, to reinforce the garrisons, especially that of Dunbar.

All this time the queen-mother continued at Edinburgh, employing herself in attempts to procure a divorce from her husband, under pretence of his having been previously contracted to another. The affairs of the kingdom again began to fall into confusion, and many murders and commotions happened in different parts of the country. The earl of Arran had the chief direction in the state; but the earl of Angus, notwithstanding the difference with his wife, had still great interest, and waited every opportunity to oppose him. This emulation produced an encounter at Edinburgh; in which victory declared for Angus, and 72 of the routed party were killed. This skirmish was fought on the 30th of April 1519, and has been known in Scots history by the name of *Cleanse the Causeway*.

On the 19th of November 1521, the regent returned from France. He found the kingdom in great disorder. The earl of Angus domineered in the field, but his antagonists outvoted his party in the parliament. The queen mother, who had fixed her affections on a third husband, hated all parties almost equally; but joined the duke of Albany, in hopes of his depriving the other two of their power. This happened according to her expectation; and she was with the regent when he made a kind of triumphal entry into Edinburgh, attended by a number of persons of the first rank.—The earl of Angus was now summoned to appear as a criminal; but his wife interceded for him, not out of any remains of affection, but because he gave her no opposition in the process of divorce which was depending between them.—In the mean time, Henry VIII. of England, perceiving that the Scots were entirely devoted to the French interest, sent a letter full of accusations against the regent, and threats against the whole nation, if they did not renounce that alliance. No regard being paid to these requisitions, lord Dacres was ordered to proclaim upon the borders, that the Scots must stand to their peril if they did not fall in with his measures by the first of March 1522. This producing no effect, Henry seized the effects of all the Scots residing in England, and banished them his dominions, after marking them, according to bishop Lesley, with a cross, to distinguish them from his other subjects. A war was the unavoidable consequence of these proceedings; and, on the 30th of April, the earl of Shrewsbury, Henry's steward of the household, and knight of the garter, was appointed commander in chief of the army that was to act against the Scots; and, in the mean time, Lord Dacres made an inroad as far as Kelfo, plundering and burning wherever he came.

The regent ordered his army to rendezvous at Roslin; but the Scots, remembering the disaster at Flodden, showed an extreme aversion to the war, and even told the regent to his face, that though they would defend themselves in case they were attacked, they would not engage in a French quarrel. The regent remon-

Scotland.

<sup>385</sup> The queen attempts to divorce her husband.

<sup>386</sup> Skirmish between the followers of the earl of Arran and Angus.

<sup>387</sup> War with England.

<sup>388</sup> The Scots refuse to invade England.

strated;

Scotland.

rated, but without effect; and as the malecontents continued obstinate, he was in danger of being left by himself, when the queen-mother interposed, and prevailed upon Lord Dacres to agree to a conference, the event of which was a renewal of the negotiations for peace.

389  
The regent  
flies to  
France for  
assistance.

The regent perceiving, by the disgrace of this expedition, that he had lost his former popularity, determined to revenge himself; and therefore told those whom he could trust, that he was about to return to France, from whence he should bring such a force by sea and land, as should render it unnecessary for him to ask leave of the Scots any more to invade England. Accordingly he embarked for France on the 25th of October, but publicly gave out that he would return the ensuing August.

390  
The Eng-  
lish resolve  
to intercept  
him.

On the regent's arrival in France, he made a demand of 10,000 foot and 5000 horse for carrying on the war against England; but the situation of King Francis did not then allow him to spare so many at once, though he was daily sending over ships with men, ammunition, and money, for the French garrisons in Scotland. At last it was publicly known in England that the regent was about to return with a strong fleet, and 4000 of the best troops in France; upon which Henry determined, if possible, to intercept him. Sir William Fitz-Williams, with 36 large ships, was ordered to block up the French squadron in the harbour of Finhead; Sir Anthony Poyntz cruized with another in the western seas, as Sir Christopher Dow and Sir Henry Shireburn did in the northern with a third squadron. The duke of Albany, being unable to cope with Fitz-Williams, was obliged to set out from another port with 12 ships, having some troops on board. They fell in with Fitz-Williams's squadron; two of their ships were sunk, and the rest driven back to Dieppe. Fitz-Williams then made a descent at Treport, where he burnt 18 French ships, and returned to his station off Finhead. By this time the French had given the duke such a reinforcement as made him an overmatch for the English admiral, had the men been equally good; but the regent had no dependence upon French sailors when put in competition with the English. Instead of coming to an engagement, therefore, as soon as Fitz-Williams appeared, he disembarked his soldiers, as if he had intended to delay his expedition for that year; but a storm soon arising, which obliged the English fleet to return to the Downs, the regent took that opportunity of re-embarking his men, and, sailing by the western coasts, arrived safe in Scotland.

391  
He outwit-  
them, and  
lands in  
Scotland.

392  
Cruel devas-  
tations of  
the Eng-  
lish.

All this time the earl of Surry had been carrying on the most cruel and destructive war against Scotland; insomuch that, according to Cardinal Wolsey, "there was left neither house, fortress, village, tree, cattle, corn, nor other succour for man," in the countries of Tweeddale and March. The regent's return did not immediately put a stop to these devastations; for the intestine divisions in Scotland prevented him from taking the field. His party was weakened by his long absence, and the queen-mother had been very active in strengthening the English interest. A parliament was called in 1523, where it was debated, whether peace or war with England should be resolved on? and the determinations of this parliament were evidently on the worst side of the question. Henry was at this time so

Scotland.

well disposed to cultivate a friendship with Scotland, that he offered to James his eldest sister Mary in marriage; but the Scots, animated by the appearance of their French auxiliaries, and corrupted by their gold, rejected all terms, and resolved upon war. However, when the army was assembled, and had advanced to the borders, he found the same difficulty he had formerly experienced; for they flatly refused to enter England. With great difficulty he prevailed upon part of the army to pass the Tweed; but not meeting with success, he was obliged to return to Scotland, which at this time was divided into four factions. One of these was headed by the regent, another by the queen, a third by the earl of Arran, and a fourth by the earl of Angus, who had lived as an exile under Henry's protection. Had it been possible for the earl of Angus and his wife to have been reconciled to each other, it would have been much for the interest of the kingdom; but all the art even of Cardinal Wolsey could not effect this. At last, the duke of Albany, finding all parties united against him, resigned his office of regent of Scotland. On the 14th of March that year, he went on board one of his own ships for France, from whence he never returned to Scotland. He did not indeed make a formal abdication of his government; so far from that, he requested the nobility, whom he convened for that purpose, to enter into no alliance with England during his absence, which he said would continue no longer than the first of September following; to make no alteration in the government; and to keep the king at Stirling.

393  
Henry of-  
fers peace,  
which is  
rejected.

394  
The duke  
of Albany  
resigns his  
office of re-  
gent.

The nobility, who were impatient for the absence of the regent, readily promised whatever he required, but without any intention of performing it: nor, indeed, was it in their power to comply; for it had been previously determined that James himself should now take the administration into his own hands. According to Buchanan, the regent had no sooner returned to France than Scotland relapsed into all the miseries of anarchy. The queen-dowager had the management of public affairs, but her power was limited. The earl of Arran, apprehending danger from the English, entered into the views of the French party. The queen-mother's dislike to her husband continued as great as ever, which prevented an union among those who were in the English interest; and Wolsey took that opportunity of restoring the earl of Angus to all his importance in Scotland.—The queen-mother, therefore, had no other way left to keep herself in power, but to bring James himself into action. On the 29th of July, therefore, he removed from Stirling to the abbey of Holyroodhouse; where he took upon himself the exercise of government, by convoking the nobility, and obliging them to swear allegiance to his person a second time. The truce with England was now prolonged, and the queen's party carried all before them. On the very day in which the last truce was signed with England, the earl of Angus entered Scotland. He had been invited from his exile in France into England, where he was cared for by Henry, who disregarded all his sister's intreaties to send him back to France, and now resolved to support him in Scotland. Yet, though his declared intention in sending the earl to Scotland was, that the latter might balance the French party there, the king enjoined him to sue, in the most humble manner, for a reconciliation

595  
James takes  
upon him-  
self the gov-  
ernment.

396  
The earl of  
Angus re-  
turns to  
Scotland.

with



**Scotland.** with his wife, and to co-operate with the earl of Arran, who now acted as prime minister, as long as he should oppose the French party. On his return, however, he found himself excluded from all share in the government, but soon found means to form a strong party in opposition to Arran. In the mean time, ambassadors were sent to the court of England, in order to treat of a perpetual peace between the two nations. At the same time a match was proposed between the young king of Scotland and Henry's daughter. This had originally been a scheme of Henry himself; but the emperor Charles V. had resolved to outbid him, by offering James a princess of his own family, with an immense treasure. The ambassadors arrived at London on the 19th of December, and found Henry very much disposed both to the peace and to the match. Commissioners were appointed to treat of both; but they were instructed to demand by way of preliminary, that the Scots should absolutely renounce their league with France, and that James should be sent for education to England till he should be of a proper age for marriage. The Scottish commissioners declared, that they had no instructions on these points: but one of them, the earl of Cassils, offered to return to Scotland, and bring a definitive answer from the three states; and in the mean time the truce was prolonged to the 15th of May 1525.

**397** Negotiation for peace with England.  
**398** The earl of Angus comes into power.  
**399** Is proposed by the queen-mother.  
**400** Who is besieged in Edinburgh castle.

On his arrival at Edinburgh, he found the earl of Angus the leading man in parliament; by whose influence it was determined that the Scots should renounce their league with France, and substitute in place of it a similar league with England; and that the king should be brought up at the English court till he was of an age proper for marriage: but at the same time they required of Henry to break off all engagements with Charles V. who was the bitter enemy of Francis, and at that time detained him prisoner. To this the English monarch returned but a cold answer, being then engaged in a number of treaties with the emperor, among which one was concerning the marriage of the princess Mary with his imperial majesty himself; however, before Cassils returned, a truce of two years and a half was concluded between England and Scotland.

But now the queen-mother, though she had always been a warm advocate for an alliance between the two nations, yet disliked the means of bringing it about.— She saw her husband's party increasing every day in power; so that now she had no other resource than in keeping possession of the king's person, whom she removed to the castle of Edinburgh. Being now under the necessity of convening a parliament, it was resolved to hold it within the castle; which, being an unconstitutional measure, gave a great handle to the earl of Arran and his party to complain of the innovation. They began with remonstrances; but finding them ineffectual, they formed a blockade of the castle with 2000 men, and cut off all communication with the town by means of trenches. As no provisions could thus be got into the castle, the queen ordered some of the cannon to be turned against the town, in order to force the citizens to put an end to the blockade. Several shot were fired: but when all things appeared ready for a civil war, matters were compromised, though in such an imperfect manner as left very little room to hope for perfect tranquillity. It was agreed, that the king should remove out of the castle of Edinburgh to the palace of Holy-

**Scotland.** roodhouse; from whence he should repair with all possible magnificence to his parliament, in the house where it was commonly held; and there a finishing hand was to be put to all differences. This agreement was signed on the 25th of February 1526. The parliament accordingly met, and the king's marriage with the princess of England was confirmed; but no mention was made of the king's being sent for his education into that country; on the contrary, he was committed to the care of eight lords of parliament. These were to have the custody of the king's person, every one his month successively, and the whole to stand for the government of the state; yet with this limitation, "that the king, by their counsel, should not ordain or determine any thing in great affairs to which the queen, as princess and dowager, did not give her consent." This partition of power, by giving the queen a negative in all public matters, soon threw every thing into confusion. The earl of Angus, by leading the king into various scenes of pleasure and dissipation, so gained the ascendancy over him, that he became in a manner totally guided by him. The queen-mother, perceiving that she could not have access to her son, without at the same time being in company with her husband, whom she hated, retired suddenly with her domestics to Stirling. Thus the king was left under the sole tuition of the earl of Angus, who made a very bad use of his power, engrossing into his own hands, or those of his friends, all the places of honour or profit. The archbishop of St Andrew's, having now joined the king's party, advised her to make a formal demand upon her husband, that the order of government which had been settled last parliament should take place, and that under a penalty he should set the king at liberty. To this the earl answered by a kind of manifesto drawn up by his brother; in which he declared, that "the earl of Angus having been so highly favoured by his good uncle the king of England, and that James himself being under great obligations to him, neither the queen nor the other lords need be in any pain about him, as he chose to spend his time with the earl of Angus rather than with any lord in the kingdom." James himself, however, had discernment sufficient to perceive, that, notwithstanding all the fair pretences of the earl of Angus, he was in fact no better than his prisoner; and resolved to attempt the recovery of his liberty. The earls of Argyll and Arran had for some time retired from court, where they had no share in the administration, and were living on their own estates; but the earl of Lenox discerned his sentiments so well, that he was neither suspected by the earl of Angus, nor any of the Douglas family, who were his partisans. The king being gained upon by his insinuating behaviour, opened his mind to him, and requested his assistance against his treacherous keepers. At the same time he sent letters to his mother, and the heads of her party, by some of his domestics whom Lenox had pointed out, intreating them to remove him from the earl, and not suffer him any longer to remain under his imperious jurisdiction; adding, that if this could not be done by any other means, they should use force of arms.

On receiving this letter, the queen and her party assembled their forces at Stirling, and without loss of time began their march for Edinburgh. Angus, on the other hand, prepared to give them a warm reception,

Scotland. tion, but at the same time to carry along with him the king. This resolution being made known to the queen-mother, she was so much concerned for the safety of her son, that the whole party disbanded themselves; and thus the authority of the earl of Angus seemed to be more established than ever. Nothing, indeed, was now wanting to render him despotic but the possession of the great seal, which the archbishop of St Andrew's had carried with him to Dunfermline. As no deed of any consequence could be executed without this, he prevailed upon the king to demand it by a special message; in consequence of which, the archbishop was obliged to give it up. About this time the divorce which had been so long in agitation between the queen-mother and the earl of Angus actually took place; which, no doubt, increased the dislike of James to his confinement, while the imprudence of Angus gave every day fresh matter of disgust. As Angus knew that he had no firm support but in the attachment of his followers to his person, he suffered them to rob and plunder the estates of his opponents without mercy. These, again, did not fail to make reprisals; so that, towards the end of the year 1526, there was scarcely any appearance of civil government in Scotland. Thus the court became almost totally deserted; every nobleman being obliged to go home to defend his own estate. Even Angus himself shared in the common calamity, and hence was frequently obliged to leave the king to the custody of Lenox. To this nobleman the king now made the most grievous complaints, and charged him to contrive some plan for his escape. Lenox accordingly recommended to him the baron of Buccleugh, who was very powerful in the southern parts, and a violent enemy to Angus and the whole family of Douglas. To him he gave orders to foment the disorders in the southern parts to such a degree as to require the king's personal presence to compose them. Buccleugh was then to attack the party, and take the king by force from the Douglases. This scheme was put in execution, but Buccleugh had the misfortune to be defeated; so that the attempt proved abortive, and James found himself in a worse situation than ever. After this attempt, however, as the earl of Angus could not but know that Lenox had been accessory to it, the former behaved towards him with such visible indifference, that Lenox openly declared against him, and advised the king to form a friendship with the archbishop of St Andrew's, in order to effect his liberty. This was accordingly done; but the interest of the archbishop and Lenox was overbalanced by that of Arran and the Hamilton family, whom the earl of Angus now drew over to his party. However, the earl of Lenox, having received powers from the king for that purpose, suddenly retired from court; and published a manifesto, inviting all loyal subjects to assist him in delivering the king from confinement. In consequence of this he was soon joined by a numerous army, with whom he advanced towards Edinburgh. Angus did not fail to assemble his adherents; and sent orders to the inhabitants of Edinburgh to take the field, with the king at their head. The citizens immediately put themselves under arms; but James, pretending to be indisposed, Sir George Douglas, brother to the earl of Angus, made him the following speech: "Sir, rather than our enemies should take you from us, we will lay hold of your person;

and should you be torn in pieces in the struggle, we will carry off part of your body." Upon this speech, which James never forgot, he mounted his horse and set forward to Linlithgow, but with a very slow pace; inasmuch that Sir George Douglas, afraid of not coming in time to succour his brother, made use of many indecent expressions and actions to push James on to the field of battle. Three expresses arrived from the earl of Angus; the first informing his brother that he was about to engage with a superior army; the second, that Angus was engaged with a division of Lenox's army, commanded by the earl of Glencairn; and that Lenox himself was engaged with the Hamiltons. The third informed him that Lenox, if not actually defeated, was on the point of being so. Upon receiving this last news, James hastened to the field of battle, that he might save Lenox, and put an end to the bloodshed. But he came too late: for the royal party was already defeated with great slaughter; and Lenox himself, after being wounded and taken prisoner, was murdered by Sir James Hamilton.

On the night of the battle, the king was removed to Linlithgow; and though he was under the greatest grief for the fate of Lenox, the behaviour of the Douglases struck him with such terror that he disabled his sentiments. The earl of Angus led his victorious troops into Fife, in hopes of surprising the queen and the archbishop of St Andrew's. The queen, on the news of his approach, fled, with her new husband Henry Stuart, brother to lord Evandale, to Edinburgh, and both were admitted into the castle. The archbishop fled to the mountains, where he was obliged to keep cattle as a shepherd. Angus, after having plundered the castle of St Andrew's and the abbey of Dunfermline, returned in triumph to Edinburgh, where he prepared to besiege the castle; but the queen, hearing that her son was among the number of the besiegers, ordered the gates of the castle to be thrown open, and surrendered herself and her husband prisoners to James, who was advised to confine them to the castle. After these repeated successes, the earl of Angus established a kind of court of justice, in which he prosecuted those who had opposed him, among whom was the earl of Cassils. He was offered by Sir James Hamilton, natural son to the earl of Arran, the same who had murdered Lenox, an indemnity if he would own himself a vassal of that house; but this condition was rejected. Being called to his trial, and accused of having taken arms against the king, a gentleman of his name and family, who was his advocate, denied the charge, and offered to produce a letter under James's own hand, desiring him to assist in delivering him from his gaolers. This striking evidence confounded the prosecutor so much, that the earl was acquitted; but on his return home he was way-laid and murdered by one Hugh Campbell, at the instigation of Sir James Hamilton.

During these transactions in the south, many of the Highland clans were perpetrating the most horrid scenes of rapine and murder, which in some places reigned also in the Lowlands. The state of the borders was little better than that of the Highlands; but it engaged the attention of Angus more, as he had great interest in these parts. Marching, therefore, against the banditti which infested these parts, he soon reduced them to reason. His power seemed now to be firmly established,

404  
The queen-mother divorced her husband.

405  
The queen-mother divorced her husband.

406  
The baron of Buccleugh attempts to rescue the king, but is defeated.

407  
Another attempt by Lenox.

Scotland.

408  
Who is de- fated and killed.

409  
The queen-mother and archbishop obliged to fly.

410  
Trial and murder of the earl of Cassils.

Scotland.

Scotland.

411  
James  
escapes  
from his  
corfine-  
ment.

infomuch that the archbishop of St Andrew's began to treat with Sir George Douglas, to whom he offered lucrative leases and other emoluments if he would intercede with the regent, as Angus was called, in his favour. This was readily agreed to; and the archbishop was allowed to return in safety to his palace about the same time that Angus returned from his expedition against the borderers. Nothing was then seen at court but festivities of every kind, in which the queen-mother, who was now relieved from her confinement, took part: and she was afterwards suffered to depart to the castle of Stirling; which Angus, not attending to its value, had neglected to secure. In the mean time the archbishop invited the Douglasses to spend some days with him at his castle; which they accordingly did, and carried the king along with them. Here James dissembled so well, and seemed to be so enamoured of his new way of life, that Angus thought there could be no danger in leaving him in the hands of his friends till he should return to Lothian to settle some public as well as private affairs. Having taken leave of the king, he left him in the custody of his uncle Archibald, his brother Sir George, and one James Douglas of Parkhead, who was captain of the guards that watched his majesty on pretence of doing him honour. The earl was no sooner gone than the archbishop sent an invitation to Sir George Douglas, desiring him to come to St Andrew's, and there put the last hand to the leases, and finish the bargains that had been spoken of between them. This was so plausible, that he immediately set out for St Andrew's; while his uncle the treasurer went to Dundee, where he had an amour. James thinking this to be the best opportunity that ever presented to him for an escape, resolved to avail himself of it at all events; and found means, by a private message, to apprise his mother of his design. It was then the season for hunting and diversion, which James often followed in the park of Falkland; and calling for his forrester, he told him, that as the weather was fine, he intended to kill a stag next morning, ordering him at the same time to summon all the gentlemen in the neighbourhood to attend him with their best dogs. He then called for his chief domestics, and commanded them to get his supper early, because he intended to be in the field by day-break; and he talked with the captain of his guard of nothing but the excellent sport he expected next morning. In the mean time, he had engaged two young men, the one a page of his own, the other John Hart, a helper about his stables, to attend him in his flight, and to provide him with the dress of a groom for a disguise. Having formally taken leave of his attendants, charging them to be ready early in the morning, and being left alone, he stole softly out of his bed-chamber, went to the stable unperceived by the guards, dressed himself in his disguise; and he and his companions mounting the three best horses there, galloped to Stirling castle; into which, by the queen's appointment, he was admitted soon after day-break. He commanded all the gates to be secured; and the queen having previously prepared every thing for a vigorous defence, orders were given that none should be admitted into the castle without the king's permission.

About an hour after the king escaped from Falkland, Sir George Douglas returned; and being assured that his majesty was asleep, he went to bed. It appears

that James had been seen and known in his flight; for in the morning the bailiff of Abernethy came post-haste to inform Sir George that the king had passed Stirling bridge. They had, however, some glimmering hope that the king might be gone to Bambrigh: but that surmise was soon found to be false; and an express was dispatched, informing Angus of all that had happened. The earl quickly repaired to Falkland, where he and his friends came to a resolution of going to Stirling, and demanding access to the king.

James by this time had issued letters to the earls of Huntley, Argyle, Athol, Glencairn, Menteith, Rothes, and Eglinton; the lords Graham, Levingston, Lindsay, Sinclair, Ruthven, Drummond, Evandale, Maxwell, and Semple. Before all of them could arrive at Stirling, the earl of Angus and his friends were upon their journey to the same place; but were stopped by a herald at arms, commanding them on their allegiance not to approach within six miles of the king's residence. This order having sufficiently intimated what they were to expect, the earl deliberated with his party how to proceed. Some of them were for marching on and taking the castle by surprise: but that was found to be impracticable, especially as they had no artillery. The earl and his brother therefore resolved to make a show of submission to the king's order; and they accordingly went to Linlithgow. By this time all the nobility already mentioned, and many others, had assembled at Stirling; and James, calling them to council, inveighed against the tyranny of the Douglasses with an acrimony that sufficiently discovered what pain it must have given him when he was obliged to bear it in silence. He concluded his speech with these words: "Therefore I desire, my lords, that I may be satisfied of the said earl, his kin, and friends. For I vow that Scotland shall not hold us both, while I be revenged on him and his."

The result of the council's deliberation was, that proclamation should be made, renewing the order for the Douglasses not to approach the court, and divesting the earl of Angus and his brother of all their public employments. In the mean time, such was the moderation of the assembly, that by their advice James ordered the earl to retire to the north of the Spey till his pleasure should be known; but his brother was commanded to surrender himself a prisoner in the castle of Edinburgh, to take his trial in a very full parliament (all the members being summoned to attend), to be held in that city next September. The earl and his brother considered their compliance with those conditions as a prelude to their destruction; and resolved to justify their treasons by still greater excesses, in surprising the town of Edinburgh, and holding it against the king and parliament, before the latter could assemble. Historians have not done that justice to the proceedings of the royal party on this occasion which they deserve. The management of the king's escape, his reception into Stirling, the fortifying that castle, and the ready obedience of his great nobility, some of whom attended him with their followers before they received any summonses for that purpose, are proofs of wise and spirited deliberations. Their conduct at this time was equally consistent with the same plan of foresight.

It was naturally to be supposed that the Douglasses, who remained assembled in a numerous body, would

412  
He pre-  
pares to re-  
venge him-  
self.

Scotland.

413  
His ene-  
mies disap-  
pointed in  
their de-  
signs.

make the attempt already mentioned; but the royalists had the precaution to dispatch the Lord Maxwell and the baron of Lochinvar, with a body of troops, to take possession of the town, till James could arrive with 2000 forces to their relief. Maxwell and Lochinvar made such dispatch, that they were in possession of the town when the Douglasses appeared before it, and repulsed them; while a most terrible storm had scattered the troops under James before he could come to their assistance, so effectually, that, being left almost without attendants, his person might have been taken by the smallest party of the enemy. Upon the retreat of the Douglasses from Edinburgh, the parliament met; and none of them appearing in pursuance of their summons, the earl of Angus, his brother Sir George Douglas, his uncle Archibald Douglas, and Alexander Drummond of Carnock, with some of their chief dependents, were indicted and forfeited for the following offences: "The assembling of the king's lieges, with intention to have assailed his person; the detaining of the king against his will and pleasure, and contrary to the articles agreed upon, for the space of two years and more; all which time the king was in fear and danger of his life." We know of no advocate for the earl and his friends but one Baianthynne, who had the courage to plead their cause against those heinous charges; and so exasperated were both the king and parliament against them, that the former swore he never would forgive them, and the latter that they never would intercede for their pardon. Thus it was not deemed sufficient simply to declare their resolutions; but the solemnity of oaths was added with an intention to discourage the king of England from continuing the vigorous applications he was every day making, by letters and otherwise, for the pardon of Angus; and to shut out all hopes of that kind, James created his mother's third husband (to whom she had been married for some time) lord Methven, and gave him the direction of his artillery.

The disgrace and forfeiture of the Douglasses having created many vacancies in the state, Gavin Dunbar, archbishop of Glasgow, and tutor to the king, was nominated lord chancellor, though but indifferently qualified for a post that ought to have been filled by an able statesman; and Robert Carnaross, a person (says Buchanan) more eminent for wealth than virtue, was made treasurer: but this last was soon after displaced, being suspected of favouring the Douglasses; and Robert Barton, one of the king's favourites, was appointed to succeed him. The Douglasses still kept their arms; and being joined by a great number of outlaws and robbers in the south, they ravaged all the lands of their enemies, carrying their devastations to the very gates of Edinburgh. A commission of lieutenantancy was offered to the earl of Bothwell to act against those rebels: but he declining it, it was accepted by the earl of Argyll and lord Hume, who did great service in protecting the country from the outlaws. Several villages, however, in the neighbourhood of Edinburgh, were burnt; and all the provisions the Douglasses could find were carried off to their castle of Tantallon, which now served as their head-quarters, and was threatened with a siege.

It is remarkable, that the castle of Dunbar remained still in the hands of the duke of Albany's garrison, who recognised no master but him. The place was well

stored with artillery of all kinds; and lying in the neighbourhood of Tantallon, it was easy to transport them to the siege: but James thought he had no right to make use of them without the consent of one Maurice, governor of the castle. Having summoned, by proclamation, the inhabitants of Fife, Angus, Strathern, Stirlingshire, Lothian, Merse, and Teviotdale, to be ready to compare at Edinburgh on the 10th of December, with 40 days victuals, to assist in the siege, he sent three noblemen to borrow artillery from Maurice, and to remain as pledges for the safe redelivery of the same; and the several pieces required were accordingly sent him. This delicacy is the more remarkable, as we are told that the duke of Albany had given orders that every thing in his castle should be at the king's service. However unanimous the parliament might appear against the Douglasses, yet James was but ill-succeeded in this attempt. The unfortunate, if severely proceeded against, generally find friends; and the enemies of the Douglasses had impolitically rendered it treasonable for any person to shelter or protect the earl of Angus, his kinsmen, or followers. This proceeding, in a country where the Douglasses had so many connections, carried with it an appearance of cruelty and a thirst of revenge, especially as James had chosen such a season of the year for carrying on the siege. In short, after battering the place for some days, and losing one Falconer, his chief engineer, the king was obliged to abandon his enterprise, or rather to turn the siege into a blockade, with no great credit to his first essay in the field. Some historians intimate, that Angus found means to corrupt the other engineers; but we find, that before this time, a negotiation was going forward between James and the king of England; the nature of which proves that the former was now rendered more placable towards the Douglasses, and was the true reason why the siege was suspended.

The truce between Scotland and England was now near expiring; and Henry, under that pretence, gave a commission to the prior of Durham, Thomas Magnus, Sir Anthony Ughtred captain of the town and castle of Berwick, William Frankelyn chancellor of Durham, and Sir Thomas Tempest. James seems to have been in no haste to enter upon this negotiation, because he understood that the English commissioners were privately instructed to insist upon the Douglasses being restored to their estates and dignities. England was at that time the principal ally of Francis against the emperor; and this gave a handle for Francis to interpose so far in favour of the Douglasses, that he brought James to consent to a preliminary negotiation for their obtaining at least a secure retreat in England. This was at last complied with.

James being now delivered from all dread of the Douglasses, and under no controul from any party, showed excellent dispositions for government. Finding that the borderers were by no means pleased with the late treaty, and that they were renewing their depredations, he resolved to strike at the root of an evil which had so long proved disgraceful and dangerous to his ancestors, by giving no quarter to the chiefs of these robbers, whose principal residence was in Liddesdale. This was the more necessary, as their daring attempts had exasperated the English so much, that they had actually burnt a town in Teviotdale; and they had killed one Robert Kerr,

Scotland.

416  
James is  
disappoint-  
ed in his  
scheme of  
revenge.

414  
They are  
degraded  
and for-  
feited.

415  
They ra-  
vage the  
Southern  
parts.

417  
he Dou-  
glasses ob-  
tain a se-  
cure retreat  
in England.

418  
James re-  
duces the  
borderers.

Kerr,

<sup>Scotland.</sup> Kerr, a man of some consequence. Two of the chiefs of the Scotch borderers were Cockburn of Kenderlaw, and Adam Scot, commonly called *king of the thieves*. Both of them were barons; and had been so inured to the practice, that they thought there was no crime in robbing: they therefore appeared publicly in Edinburgh; where James ordered them to be apprehended, tried, and hanged. He next proceeded with great firmness against many noblemen and principal gentlemen, who were only suspected of being disaffected to the late peace. All of them had behaved with great loyalty, and some of them had done him the most important services. Of this number were the earl of Hume, the lord Maxwell, with the barons of Buccleugh, Farnherst, Polwart, Johnston, and Mark Kerr. Though we know nothing particularly of what was laid to the charge of those noblemen and gentlemen, yet so zealous was James for the impartial administration of justice, that he ordered them all, with many other chief gentlemen of the borders, to be sent to prison; where they lay till they entered into recognizances themselves, and found bail for their good behaviour.

Of all the party of the Douglasses, none of any note excepting Alexander Drummond of Carnock was suffered to return home, at the earnest request of the ambassadors and the treasurer Barton. This lenity was of very little consequence; for James having appointed the earl of Murray to be sole warden of the Scotch marches, with power to treat with the earl of Northumberland, their conferences had broken off on account of fresh violences happening every day; and some information he had received from them, had prevailed with James to imprison the noblemen and gentlemen we have already mentioned. He now resolved to attempt in person what his predecessors and he had so often failed in by their deputies. As he was known to be violently addicted to hunting, he summoned his nobility, even on the north of the Forth, to attend him with their horses and dogs; which they did in such numbers, that his hunting retinue consisted of above 8000 persons, two-thirds of whom were well armed. This preparation gave no suspicion to the borderers, as great hunting-matches in those days commonly consisted of some thousands; and James having set out upon his diversion, is said to have killed 540 deer. Among the other gentlemen who had been summoned to attend him, was John Armstrong of Gilnockhall. He was the head of a numerous clan, who lived with great pomp and splendour upon the contributions under which they laid the English on the borders. He was himself always attended by twenty-six gentlemen on horseback, well mounted and armed, as his body-guards. Having received the king's invitation, he was fond of displaying his magnificence to his sovereign; and attiring himself and his guard more pompously than usual, they presented themselves before James, from whom they expected some particular mark of distinction for their services against the English, and for the remarkable protection they had always given to their countrymen the Scots. On their first appearance, James, not knowing who he was, returned Armstrong's salute, imagining him to be some great no-

bleman; but upon hearing his name, he ordered him and his followers to be immediately apprehended, and sentenced them to be hanged upon the spot. It is said that James, turning to his attendants, asked them, pointing at Armstrong, "What does that knave want that a king should have, but a crown and a sword of honour?" Armstrong begged hard for his life; and offered to serve the king in the field with forty horsemen, besides making him large presents of jewels and money, with many other tempting offers. Finding the king inexorable, "Fool that I am (said he) to look for warm water under ice, by asking grace of a graces's face;" and then he and his followers submitted to their fate. Those and some other executions of the same kind restored peace to the borders.

HITHERTO we have considered only the civil transactions of Scotland; but henceforth religion will claim a considerable share of the historian's attention. The opinions of Luther had been propagated in Britain soon after his preaching in 1517. They had for some years insensibly gained ground; and, at the time the contentions began between James and his nobility, were become formidable to the established religion. We have seen how James escaped from the hands of his nobles by means of the archbishop of St Andrew's. To the clergy, therefore, he was naturally favourable; and as they of necessity opposed the reformation, James became a zealous persecutor of the reformed. On the other hand, the nobility having already opposed the king and clergy in civil affairs, did so likewise in those of religion. The clergy finding themselves unequal in argument, had recourse to more violent methods. Rigorous inquisitions were made after heretics, and fires were everywhere prepared for them.

The first person who was called upon to suffer for the reformed religion was Patrick Hamilton, abbot of Ferne. At an early period of life he had been appointed to this abbacy; and having imbibed a favourable idea of the doctrines of Luther, he had travelled into Germany, where, becoming acquainted with the most eminent reformers, he was fully confirmed in their opinions. Upon his return to Scotland, he ventured to expose the corruptions of the church, and to insist on the advantages of the tenets which he had embraced. A conduct so bold, and the avidity with which his discourses were received by the people, gave an alarm to the clergy. Under the pretence of a religious and friendly conference, he was seduced to St Andrew's by Alexander Campbell, a dominican friar, who was instructed to remonstrate with him on the subject of the reformation. The conversations they held only served to establish the abbot more firmly in his sentiments, and to inflame his zeal to propagate them. The archbishop of St Andrew's, the archbishop of Glasgow, and other dignitaries of the church, constituting a court, called him to appear before them.

The abbot neither lost his courage nor renounced his opinions. He was convicted accordingly of heretical pravity, delivered over to the secular arm, and executed in the year 1527 (N). This reformer had not attained the

(N) His tenets were of the following import, and are enumerated in the sentence pronounced against him.

<sup>Scotland.</sup> the 24th year of his age. His youth, his virtue, his magnanimity, and his sufferings, all operated in his favour with the people. To Alexander Campbell, who insulted him at the stake, he objected his treachery, and cited him to answer for his behaviour before the judgement-seat of Christ. And this persecutor, a few days after, being seized with a frenzy, and dying in that condition, it was believed with the greater sincerity and confidence, that Mr Hamilton was an innocent man and a true martyr.

<sup>423</sup> Excites general indignation  
A deed so affecting, from its novelty and in its circumstances, excited throughout the kingdom an universal curiosity and indignation. Minute and particular inquiries were made into the tenets of Mr Hamilton. Converts to the new opinions were multiplying in every quarter, and a partiality to them began to prevail even among the Romish clergy themselves. Alexander Seton, the king's confessor, took the liberty to inveigh against the errors and abuses of Popery; to neglect, in his discourses, all mention of purgatory, and pilgrimages, and saints; and to recommend the doctrines of the reformed. What he taught was impugned; and his boldness rising with contradiction, he defended warmly his opinions, and even ventured to affirm, that in Scotland there were no true and faithful bishops, if a judgement of men in this station is to be formed from the virtues which St Paul has required of them. A sarcasm so just, and so daring, inflamed the whole body of the prelacy with resentment. They studied to compass his destruction; and, as Mr Seton had given offence to the king, whom he had exhorted to a greater purity of life, they flattered themselves with the hope of conducting him to the stake; but, being apprehensive of danger, he made his escape into England.

<sup>414</sup> Henry Forest burnt;  
In 1533, Henry Forest, a benedictine friar, who discovered a propensity to the reformed doctrines, was not so fortunate. After having been imprisoned for some time in the tower of St Andrew's, he was brought to his trial, condemned, and led out to the flames. He had said, that Mr Hamilton was a pious man, and a martyr; and that the tenets for which he suffered might be vindicated. This guilt was aggravated by the discovery that friar Forest was in possession of a New Testament in the English language; for the priests esteemed a careful attention to the Scriptures to be an infallible symptom of heresy. A cruelty so repugnant to the common sense and feelings of mankind, while it pleased the insolent pride of the ecclesiastics, was destroying their importance, and exciting a general disposition in the people to adopt in the fullest latitude the principles and sentiments of the reformed.

The following year, James Beaton archbishop of St Andrew's, though remarkable for prudence and moderation, was overawed by his nephew and coadjutor David Beaton, and by the clergy. In his own person, or by commission granted by him, persecutions were carried on with violence. Many were driven into ba-

nishment, and many were forced to acknowledge what they did not believe. The more strenuous and resolute were delivered over to punishment. Among these were two private gentlemen, Norman Gourlay and David Straton. They were tried at Holyroodhouse before the bishop of Ross; and refusing to recant, were condemned. King James, who was present, appeared exceedingly solicitous that they should recant their opinions; and David Straton, upon being adjudged to the fire, having begged for his mercy, was about to receive it, when the priests proudly pronounced, that the grace of the sovereign could not be extended to a criminal whom their law and determination had doomed to suffer.

A few years after, the bishops having assembled at Edinburgh, two Dominican friars, Killor and Beverage, with Sir Duncan Sympfon a priest, Robert Forrester a gentleman of Stirling, and Thomas Forrest vicar of Doulour in Perthshire, were condemned to be consumed in the same fire.

At Glasgow, a similar scene was acted in 1539: Hieronymus Ruffel a gray-friar, and a young gentleman of the name of Kennedy, were accused of heresy before the bishop of that see. Ruffel, when brought to the stake, displaying a deliberate demeanour, reasoned gravely with his accusers, and was only answered with reproaches. Mr Kennedy, who was not yet 18 years of age, seemed disposed to disavow his opinions, and to sink under the weight of a cruel affliction; but the exhortation and example of Ruffel awakening his courage, his mind assumed a firmness and constancy, his countenance became cheerful, and he exclaimed with a joyful voice, "Now, I defy thee, Death; I praise my God, I am ready."

James Beaton, the archbishop of St Andrew's, having died about this time, the ambition of David Beaton, his coadjutor, was gratified in the fullest manner. He had before been created a cardinal of the Roman church, and he was now advanced into the possession of the primacy of Scotland. No Scottish ecclesiastic had been ever invested with greater authority; and the reformers had every thing to fear from so formidable an enemy. The natural violence of his temper had fixed itself in an overbearing insolence, from the success which had attended him. His youth had been passed in scenes of policy and intrigue, which, while they communicated to him address and the knowledge of men, corrupted altogether the simplicity and candour of his mind. He was dark, designing, and artificial. No principles of justice were any bar to his schemes; nor did his heart open to any impressions of pity. His ruling passion was an inordinate love of power; and the support of his consequence depending alone upon the church of Rome, he was animated to maintain its suppetitions with the warmest zeal. He seemed to take a delight in perdition and dissimulation: he had no religion; and he was stained with an inhuman cruelty, and

"Man hath no free-will. Man is in sin so long as he liveth. Children, incontinent after their baptism, are sinners. All Christians, that be worthie to be called Christians, do know that they are in grace. No man is justified by works, but by faith only. Good works make not a good man, but a good man doth make good works. And faith, hope, and charity, are so knit, that he that hath the one hath the rest; and he that wanteth the one of them wanteth the rest." *Keith, Hist. of the Church and State of Scotland, Appendix, p. 3.*

Scotland. and the most open profligacy of manners. In connection with these defects, he possessed a persevering obstinacy in pursuing his measures, the ability to perceive and to practise all the arts which were necessary to advance them, and the allurements of ostentation and prodigality.

He was scarcely invested in the primacy, when he exhibited an example of his taste for magnificence, and of his aversion to the reformed. He proceeded to St Andrew's with an uncommon pomp and parade. The earls of Huntley, Arran, Marischal, and Montrose, with the lords Fleming, Lindsey, Erskine, and Seton, honoured him with their attendance; and there appeared in his train, Gavin archbishop of Glasgow and lord high chancellor, four bishops, six abbots, a great many private gentlemen, and a vast multitude of the inferior clergy. In the cathedral church of St Andrew's, from a throne erected by his command, he harangued concerning the state of religion and the church, to this company, and to a crowd of other auditors. He lamented the increase of heretics; he insisted upon their audacity and contempt of order; he said, that even in the court of the sovereign too much attention was shown to them; and he urged the strong necessity of acting against them with the greatest rigour. He informed this assembly, that he had cited Sir John Borthwick to appear before it, for maintaining tenets of faith hostile to the church, and for dispersing heretical books; and he desired that he might be assisted in bringing him to justice. The articles of accusation (o) were accordingly read against him; but he neither appeared in his own person, nor by any agent or deputy. He was found, notwithstanding, to be guilty; and the cardinal, with a solemnity calculated to strike with awe and terror, pronounced sentence against him. His goods and estate were confiscated; a painted representation of him was burned publicly, in testimony of the malediction of the church, and as a memorial of his obstinacy and condemnation. It was ordained, that in the event of his being apprehended, he should suffer as a heretic, without hope of grace or mercy. All Christians, whether men or women, and of whatever degree or condition, were prohibited from affording him any harbour or sus-

tenance. It was declared, that every office of humanity, comfort, and solacement, extended to him, should be considered as criminal, and be punished with confiscations and forfeitures.

Sir John Borthwick having been apprised of his <sup>420</sup> danger, fled into England; where he was kindly received by Henry VIII. who employed him in negotiations with the Protestant princes of Germany. Cardinal Beaton perceived with concern that this act of severity did not terrify the people. New defections from the church were announced to him. Andrew Cunningham sen to the naster of Glencairn, James Hamilton brother to Patrick Hamilton the martyr, and the celebrated George Buchanan the historian, were imprisoned upon suspicions of heresy; and, if they had not found means to escape, must have died at the stake. In this declining condition of Popery, the cardinal held many mournful consultations with the bishops. All their intrigues and wisdom were employed to devise methods to support themselves. The project of an inquisitorial court was conceived, and exhibited a distant view of the extirpation of heretics. To erect this tribunal, they allured James V. with the hopes of the confiscation and spoils, which might enrich him, from the persecution and punishment of the reformed. He yielded himself to their solicitations, and gave them the sanction of his authority.

A formal commission was granted, constituting a court of inquiry after heretics, and nominating for its president <sup>437</sup> Sir James Hamilton of Fennard, natural brother to the earl of Arran. The officious assiduity of this man, his ambition, and his thirst of blood, were acceptable in a high degree to the clergy; and to this bad eminence their recommendation had promoted him. Upon the slightest suspicion he was allowed to call any person before him, to scrutinize into his creed, and to absolve or to condemn him. A tribunal so dreadful could not have found a director more suited to it. He was in haste to fill the prisons of the kingdom with culprits, and was marking down in lists the names of all those to whom heresy was imputed by popular report, and whom the arts of malicious men had represented as the objects of correction and punishment. But, while he was brooding

(o) They are preserved by archbishop Spotswood, and display great liberality of mind, in a period when philosophy may be said to have been unknown in Scotland. They are thus detailed by this judicious writer.

1. "That he held the pope to have no greater authority over Christians than any other bishop or prelate had.
2. "That indulgences and pardons granted by the pope were of no force nor effect, but devised to abuse people, and deceive poor ignorant souls.
3. "That bishops, priests, and other clergymen, may lawfully marry.
4. "That the heresies, commonly called *heresies of England*, and their new liturgy, were commendable, and to be embraced of all Christians.
5. "That the people of Scotland are blinded by their clergy, and professed not the true faith.
6. "That churchmen ought not to enjoy temporalities.
7. "That the king ought to convert the rents of the church into other pious uses.
8. "That the church of Scotland ought to be governed after the manner of the English.
9. "That the canons and decrees of the church were of no force, as being contrary to the law of God.
10. "That the orders of the friars and monks should be abolished, as had been done in England.
11. "That he did openly call the pope *simoniac*, for that he sold spiritual things.
12. "That he did read heretical books, and the New Testament in English, and some other treatises written by Melancthon, Occolampadius, and Erasmus, which he gave likewise unto others.
13. "The last and greatest point was, that he refused to acknowledge the authority of the Roman see, or be subject thereunto." *Hist. of the Church*, p. 70.

Scotland. ing over mischief, and multiplying in fancy the triumphs of his wickedness, an unexpected turn of affairs presented himself in the light of a criminal, and conducted him to the scaffold.

432  
Projects  
the ruin of  
Patrick  
Hamilton's  
brother.

The brother of Mr Hamilton the martyr, to avoid persecution, had been obliged to go into banishment; but, by the intercession of his friends, he was permitted to return for a short time to his own country, that he might regulate the affairs of his family. He was connected with Sir James Hamilton; and, trusting to the ties of blood, ventured to prolong his stay beyond the period allotted to him. This trespass was trivial. Sir James Hamilton, being willing to give a signal example of severity, and by this means to ingratiate himself the more with the priesthood, took the resolution to make his own relation the first victim of his power. Mr Hamilton, attentive to his personal security, and not unacquainted with the most private machinations of this inquisitor, dispatched his son to the king, who was about to pass the Forth in a barge, and intreated him to provide for his safety, as Sir James Hamilton had conspired with the house of Douglas to assassinate him. James V. being at variance with the house of Douglas, had reasons of suspicion, and was disposed to believe every thing that is most flagitious of Sir James Hamilton. He instructed the young gentleman to go with expedition to Edinburgh, and to open the matter to the privy-council; and that he might be treated with the greater respect, he furnished him with the ring which he was accustomed to send to them upon those important occasions which required their address and activity. Sir James Hamilton was apprehended and imprisoned. An accusation of having devised and attempted the king's death at different times, was preferred against him. His defence appeared to be weak and unsatisfactory. A jury, which consisted of men of rank and character, pronounced him guilty; and, being condemned to suffer the death of a traitor, he lost his head, and the quarters of his body were expofed upon the gates of the city of Edinburgh. The clergy, who could not prevent his trial and execution, regretted his death, but did not think of appointing a fuceeffor to him in their court of inquisition.

434  
Condemned  
and executed.

In other respects, however, James showed great concern for the welfare of his people. Being dissatisfied with the ordinary administration of justice, he had recourse to the parliament of Paris for a model of the like institution in Scotland. Great objections lay to juries in civil matters, and to ambulatory courts of justice. The authority of the heritable jurisdictions was almost exclusive of all law; for though the king might preside in them, yet he seldom did; and appeals before the council were disagreeable and expensive. The institution of the lords of articles threw too much weight into their scale, as no business could be transacted in parliament but what they allowed of and prepared; and it was always in the power of the crown to direct them as the king pleased. The true source of the public grievances, in matters of property, lay in the disregard shown to the excellent acts which had passed during the reigns of the three first James's, and which had not been sufficiently supported in the late reigns. The evil had gathered strength during the minority of James V.; and he resolved to establish a standing jury

435  
James regulates  
the courts of  
justice.

for all matters of law and equity (for, properly speaking, the court of session in Scotland is no other), with a president, who was to be the mouth of the assembly. On the 13th of May, this year, as we find by a curious manuscript in the British museum, the lords of the articles laid before the parliament the proposition for instituting this court, in the following words: "Item, anent (concerning) the second article concerning the order of justice; because our sovereign lord is maist desirous to have an permanent order of justice for the universal of all his liege; and therefore tendis to institute an college of cunning and wise men for doing and administration of justice in all civil actions: and therefore think to be chosen certain persons maist convenient and qualified yair (there), to the number of fifteen persons, half spiritual, half temporal, with an president."

Scotland.  
436  
Origin of  
the court  
of session.

In the year 1533, hostilities were recommenced with England; but after some slight incursions on both sides, a truce again took place. The most remarkable transactions of these years, however, next to the religious persecutions already mentioned, were the negotiations for the king's marriage. Indeed, there is scarce any monarch mentioned in history who seems to have had a greater variety of choices, or who was more difficult to be pleased. The situation of affairs on the continent of Europe, had rendered Scotland a kingdom of great consequence, as holding the balance between France, England, and the emperor of Germany; and each of the rival powers endeavoured to gain the favour of James, by giving him a wife.—In 1534, king Francis offered him his daughter; and the match was strongly recommended by the duke of Albany, who was still living in France, and served James with great fidelity. The same year the Imperial ambassador arrived in Scotland, and presented, in the name of his master, the order of the golden fleece to James, who had already been invested with that of St Michael by Francis. At the same time, he offered him his choice of three princesses; Mary of Austria, the emperor's sister, and widow of Lewis king of Hungary; Mary of Portugal, the daughter of his sister Eleonora of Austria; or Mary of England, the daughter of Catharine and Henry. Another condition, however, was annexed to this proposal, viz. that, to suppress the heresies of the time, a council should be held for obviating the calamities which threatened the Christian religion. Those proposals would have met with a more ready acceptance from James, had not his clergy, at this time, been disgusted with Charles, for allowing too great a latitude to the Protestants of Germany. James, in his answer, returned the emperor his acknowledgments in the most polite terms, for the splendid alliances he had offered him. He touched the proposal of the council as being a measure rather to be wished for than hoped, because it ought to be free and holy, and upon the model of the first councils; its members consisting of the most charitable, quiet, and disinterested part of the clergy. He said, that if such a council could be obtained, he would willingly send ecclesiastics to it; but if not, that every prince ought to reform the errors of doctrine, and the faults of the clergy, within his own dominions. He bewailed the obstinate conduct of his uncle in his divorce and marriage; and offered his best offices for effecting a reconciliation between him and the emperor,

437  
Negotiations  
for  
the king's  
marriage.

438  
Offers of  
the emperor  
of Germany.

439  
Which are  
rejected by  
James.

wishing



Scotland.

Scotland.

wishing that all the princes of Christendom would unite their arms against their common enemy the Turks. He hinted, very justly, that his Imperial majesty had offered more than he could perform, because his cousin, Mary of England, was not at his disposal. The ambassador replied, that his master, if persuasions failed, would compel Henry by force of arms to resign her. James answered this ridiculous declaration by observing, that the emperor then would be guilty of a breach of all laws both divine and human; that it would be impolitic to give a preference to any of the three princesses, all of them being so illustrious and deserving; but, to show how much he valued an alliance with his Imperial majesty, he would become a suppliant to that prince for his niece, daughter to Christiern king of Denmark, to become his bride. The ambassador's answer to this unexpected request was, that she was already betrothed to the count palatine, and that before that time the marriage was probably consummated.

440  
He marries  
the king of  
France's  
daughter,

But whether the Imperial ambassador had any right to offer the English princess or not, it is agreed by most historians, that he was offered either Mary or Elizabeth by their father Henry himself. To Mary of Bourbon, the daughter of the duke of Vendosme, he is said to have been contracted; but for some reason or other all these matches were broken off; and the king at last went to France, where he married Magdalen the eldest daughter of Francis. The nuptials were celebrated at Paris in the year 1537, with great magnificence; and among other things served up by way of desert at the marriage-feast, were a number of covered cups filled with pieces of gold and gold-dust, the native product of Scotland, which James distributed among the guests. This gold was found in the mines of Crawford-moor, which were then worked by the Germans. In the beginning of May, the royal pair embarked for Leith, under convoy of four large ships of war, and landed on the 28th of the same month. The joy of the Scots was inexpressible, but it was of short continuance; for the young queen died of a fever on the 22d of July the same year.

441  
Who dies  
soon after.

King James did not long remain a widower; for the same year he sent Beaton abbot of Arbroath, to treat of his second marriage with a French lady, Mary of Guise, duchess-dowager of Longueville. In this he was rivalled by his uncle Henry VIII. but not before James had been contracted to her. But this was nothing to Henry; for he not only insisted upon having this lady for his wife, but threw out some menaces against Francis, because he would not comply with this unjustifiable request. In January 1538, she was married to James, and escorted to Scotland by the admiral of France with a considerable squadron; both James and Francis being suspicious that Henry would make some attempt to intercept the royal bride. But nothing of this kind happened, and she landed safely at Fifeness; from whence she was conducted to the king at St Andrew's.

443  
Cruc. execu-  
tion of  
the heir of  
the house  
of Forbes.

But while James appeared thus to be giving himself up to the pleasures of love, he was in other respects showing himself a bloody tyrant. Some differences subsisted between the families of Gordon and Forbes in the north. The heir of the house last-mentioned had been educated in a loose dissipated manner, and kept

Vol. XVII. Part I.

company with a worthless fellow named *Strabin*. Having refused this favourite something he had asked, the latter attached himself to Gordon earl of Huntley, who, it is said, assisted him in forming a charge of treason against Forbes. He was accused of intending to restore the Douglases to their forfeited estates and honours; which improbable story being supported by some venal evidences, the unhappy young man was condemned and executed as a traitor. The king could not but see the injustice of this execution; and, in order to make some amends for it, banished Strahan the kingdom. The following execution, which happened a few days after, was much more inhuman, inasmuch that it would have itained the annals even of the most despotic tyrants. The earl of Angus, finding that he could not regain the favour of the king, had recourse to the method usual in those days, viz. the committing of depredations on the borders. This crime was sufficient with James to occasion the death of his innocent sister, the dowager-lady of Glamis. She had been courted by one Lyon, whom she had rejected in favour of a gentleman of the name of *Campbell*. Lyon, exasperated at his repulse, found means of admittance to James, whom he filled with the greatest terrors on account of the practices of the family of Angus; and at last charged the lady, her husband, and an old priest, with a design of poisoning the king in order to restore Angus. The parties were all remarkable for the quiet and innocent lives they led; and even this circumstance was by their diabolical accuser turned to their prejudice, by representing it as the effect of cunning or caution. In this reign an accusation of treason was always followed by condemnation. However, the evidence against the lady appeared so absurd and contradictory, that some of the judges were for dropping the prosecution, and others for recommending her case to the king: but the majority prevailed to have it determined by a jury, who brought her in guilty; and she was condemned to be burnt alive in the Cattle-hill of Edinburgh. The defence she made would have done honour to the ablest orator, and undeniably proved her innocence; but tho' it was reported to James, it was so far from mitigating her sentence, that it was aggravated by her husband being obliged to behold her execution. The unhappy husband himself endeavoured to make his way over the castle wall of Edinburgh; but the rope proving too short, he was dashed in pieces: and lord Glamis her son, though but a child, was imprisoned during the remainder of this reign. The old priest, though put to the torture, confessed nothing, and was freed. Lyon, like the other accuser already mentioned, was banished the kingdom.

444  
And of the  
dowager-  
lady of Glamis.

445  
Death of  
her husband.

Whether these and other cruelties had affected the king's conscience, or whether his brain had been touched by the distractions of the different parties, is unknown; but it is certain, that, in the year 1540, he began to live retired: his palace appeared like the cloistered retreat of monks; his sleep was haunted by the most frightful dreams, when he construed into apparitions; and the body of Sir James Hamilton, whose execution has already been mentioned, seemed continually present to his eyes. Perhaps the loss of his two sons, who died on the same day that Sir James was executed, might have contributed to bring this man more remark-

446  
The king  
seized with  
a kind of  
distracted.

C

ably

Scotland. ably to his remembrance. No doubt, it added to the gloom of his mind; and he now saw his court abandoned by almost all his nobility.

447  
Hostilities  
commence  
between  
Scotland  
and Eng-  
land.

At last James was in some degree roused from his inaction, by the preparations made against him by his uncle Henry VIII. of England. Some differences had already taken place; to accommodate which, Henry had desired a conference with James at York. But this the latter, by the advice of his parliament, had declined. The consequence was a rupture between the two courts, and the English had taken 20 of the Scots trading vessels. Henry threatened to revive the antiquated claim of the English superiority over Scotland, and had given orders for a formidable invasion of the Scotch borders. He complained that James had usurped his title of Defender of the Faith, to which he had added the word Christian, implying that Henry was an infidel: but the kings of Scotland had, some time before, been complimented by the papal see with that title. James, on the other hand, threw his eyes towards Ireland, the north part of which was actually peopled with inhabitants who owned no sovereign but the king of Scotland, and who offered to serve James against the English; some of their chiefs having actually repaired to Scotland, and done homage to James.

443  
The love-  
reign of  
Ireland  
claimed by  
both kings

Henry had, about this time, declared himself king of Ireland, of which he was before only styled the *lord*; and James roundly asserted, that he had a preferable claim to at least one half of that island, which had been peopled by the subjects of Scotland. Though the Scotch historians of this reign take very little notice of this incident, yet James appears to have been very tenacious of his title; and that there was a vast intercourse carried on between the subjects of Scotland and the northern Irish, who unanimously acknowledged James for their natural sovereign. Indeed, this was the only ground of quarrel that the king, with the least shadow of justice, could allege against Henry.

449  
An act of  
indemnity  
for crimes  
committed  
during the  
king's mi-  
nority.

His parliament being met, many public-spirited acts were passed; and before the assembly was dissolved, the members renewed the acts against leasing-making; by which is meant the misrepresenting of the king to his nobles, or the nobles to their king: and James, to dismiss them in good humour, passed an act of free grace for all crimes committed in his minority; the earl of Angus, and Sir George and Sir Archibald Douglas, being excepted.

450  
Prepara-  
tions of  
Henry.

Henry, after cutting off the head of his wife Catharine Howard, married and divorced the princess Anne of Cleves, and found himself either deserted or distrusted by all the princes on the continent, Protestant as well as Roman Catholic. James and his clergy relied greatly on this public odium incurred by Henry; but the emperor having again quarrelled with Francis, left Henry, whose dominions they had threatened jointly to invade, at liberty to continue his preparations against the Scots. He first ordered his fleet, then the most formidable of any in the world, to make fresh descents upon Scotland. At the same time, he appointed a very considerable army to rendezvous upon the borders, under the command of Sir Robert Bowes, one of his wardens, the earl of Angus, and his two brothers Sir George and Sir Archibald Douglas. James was every day expecting supplies of money, arms, and other necessaries from Francis; but these not arriving,

Scotland. he reassembled his parliament on the 14th of March, which gratified him in all his demands. Many excellent regulations were made for the internal government, peace, and security of the kingdom, and against the exportation of money instead of merchandize. Acts were passed for fortifying and embellishing the town of Edinburgh, and for better supplying the subjects with wine and all the other necessaries of life. The royal revenue was increased by many additional estates; and the lall hand was put to one of the best plans for a national militia that perhaps ever appeared. As yet, excepting in the disappointment which Henry met with from his nephew in not meeting him at York, he had no grounds for commencing hostilities. But it is here proper to observe, that the queen mother was then dead; and consequently the connection between James and Henry was weakened. Whatever her private character might have been, she was certainly a happy instrument of preventing bloodshed between the two kingdoms. She was buried with royal honours at Perth.

451  
Death of  
the queen-  
mother.

James, to all appearance, was at this time in a most desirable situation. His domain, by forfeitures and otherwise, far exceeded that of any of his predecessors. He could command the purses of his clergy; he had large sums of ready money in his exchequer; his forts were well stored and fortified; and he was now daily receiving remittances of money, arms, and ammunition from France. All this show of happiness was only in appearance; for the affections of his nobility, and the wiser part of his subjects, were now alienated from him more than ever, by the excessive attachment he showed to bigotry and persecution.

452  
James loses  
the affec-  
tions of his  
subjects.

He had nominated the earl of Huntley to command his army on the borders, consisting of 10,000 men; and his lieutenant-general was Sir Walter Lindfay of Torphichen, who had seen a great deal of foreign service, and was esteemed an excellent officer. Huntley acquitted himself admirably well in his commission; and was so well served by his spies, as to have certain intelligence that the English intended to surprise and burn Jedburgh and Kelso. The English army under Sir Robert Bowes and the Douglasses, with other northern Englishmen, continued still upon the borders; and one of the resolutions the Scotch nobility and gentry had come to, was, not to attack them on their own ground, nor to act offensively, unless their enemies invaded Scotland. Huntley being informed that the English had advanced, on the 24th of August, to a place called *Haldanrig*, and that they had destroyed great part of the Scotch and debateable lands, resolved to engage them; and the English were astonished, when at day-break they saw the Scotch army drawn up in order of battle. Neither party could now retreat without fighting; and Torphichen, who led the van, consisting of 2000 of the best troops of Scotland, charged the English so furiously, that Huntley gained a complete and an early victory. Above 2000 of the English were killed, and 600 taken prisoners; among whom were their general Sir Robert Bowes, Sir William Mowbray, and about 60 of the most distinguished northern barons; the earl of Angus escaping by the swiftness of his horse. The loss of the Scots was inconsiderable.

453  
The Eng-  
lish defeat-  
ed by the  
earl of  
Huntley.

In the meanwhile, the duke of Norfolk having raised

Scotland. fed a great army, had orders to march northwards, and to disperse a manifesto, complaining of James for having disappointed him of the interview at York, and reviving the ridiculous claim of his own and his ancestors superiority over the kingdom of Scotland. It was plain, from the words of this manifesto, that Henry was still placable towards James; and that he would easily have dropt that claim, if his nephew would have made any personal advances towards a reconciliation.

The condition of James was now deplorable. The few faithful counsellors he had about him, such as Kirkaldy of Grange, who was then lord treasurer, plainly intimated, that he could have no dependence upon his nobles, as he was devoted to the clergy; and James, sometimes, in a fit of distraction, would draw his dagger upon the cardinal and other ecclesiastics when they came to him with fresh propositions of murder and proscriptions, and drive them out of his presence. But he had no constancy of mind; and he certainly put into his pocket a bloody scroll that had been brought him by his priests, beginning with the earl of Arran, the first subject of the kingdom. In one of his cooler moments, he appointed the lord Erskine, and some others of his nobility, to make a fresh attempt to gain time; and Henry even condescended to order the duke of Norfolk (who was then advanced as far as York), the lord privy seal, the bishop of Durham, and others, to treat with him. The conferences were short and unsuccessful. The duke bitterly complained, that the Scots sought only to amuse him till the season for action was over. In short, he considered both them and Learmouth, who was ordered to attend him, as so many spies, and treated them accordingly. It was the 21st of October before he entered the east borders of Scotland. According to the Scotch historians, his army consisted of 40,000 men; but the English have fixed it at 20,000.

James affected to complain of this invasion as being unprovoked; but he lost no time in preparing to repel the danger. The situation of his nobility, who were pressed by a foreign invasion on the one hand, and domestic tyrants on the other, induced them to hold frequent consultations; and in one of them, they resolved to renew the scene that had been acted at Lawder bridge under James III. by hanging all his grandson's evil counsellors. The Scots historians say, that this resolution was not executed, because the nobility could not agree about the victims that were to be sacrificed; and that the king, who was encamped with his army at Fallamoor, having intelligence of their consultation, removed hastily to Edinburgh; from which he sent orders for his army to advance, and give battle to the duke of Norfolk, who appears as yet not to have entered the Scotch borders. The answer of the nobility was, that they were determined not to attack the duke upon English ground; but that if he invaded Scotland, they knew their duty. The earl of Huntley, who commanded the van of the Scottish army, consisting of 10,000 men, was of the same opinion: but no sooner did Norfolk pass the Tweed, than he harassed the English army, cut off their foraging parties, and distressed them in such a manner, that the duke agreed once more to a conference for peace; which was managed, on the part of the Scots, by the bishop of Orkney and Sir James Learmouth; but nothing was con-

cluded. The English general, finding it now impossible on many accounts to prosecute his invasion, repassed the Tweed; and was harassed in his march by the earl of Huntley, who desisted from the pursuit the moment his enemies gained English ground.

James, whose army at this time amounted to above 30,000 men, continued still at Edinburgh, from which he sent frequent messages to order his nobility and generals to follow the duke of Norfolk into England; but these were disregarded. James was flattered, that now he had it in his power to be revenged for all the indignities that had been offered by England to Scotland. In this he was encouraged by the French ambassador, and the high opinion he had of his own troops. About the beginning of November, he came to a resolution of reassembling his army, which was disbanded upon the duke of Norfolk's retreat. This project appeared so feasible and so promising, that several of the nobility are said to have fallen in with it, particularly the lord Maxwell, the earls of Arran, Cassils, and Glencairn, with the lords Fleming, Somerville, and Erskine: others repented, but in vain, that the arms of Scotland had already gained sufficient honour, by obliging the powerful army of the English, with their most experienced general at their head, to make a shameful retreat before a handful; that the force of Scotland was inferior to that of England; and that an honourable peace was still practicable. It was said, in reply to those considerations, that the state of the quarrel was now greatly altered; that Henry had in his manifesto declared his intention to enslave their country; that he treated the nobility as his vassals; that the duke of Norfolk had been guilty of burning the dwellings of the defenceless inhabitants, by laying above 20 villages and towns in ashes; and that no Scotchman, who was not corrupted by Henry's gold, would oppose the king's will. The last, perhaps, was the chief argument that prevailed on the lord Maxwell, a nobleman of great honour and courage, to agree to carry the war into England by Solway, provided he was at the head of 10,000 men. It was at last agreed that the earl of Arran and the cardinal should openly raise men, as if they intended to enter the east marches, where they were to make only a feint, while the lord Maxwell was to make the real attempt upon the west. Private letters were everywhere circulated to raise the men who were to serve under the lord Maxwell; among whom were the earls of Cassils and Glencairn, the lords Fleming, Somerville, Erskine, and many other persons of great consideration. James, who never was suspected of want of courage, probably would have put himself at the head of this expedition, had he not been dissuaded from it by his priests and minions, who reminded him of the consultations at Fallamoor, and the other treasonable practices of the nobility. They added, that most of them being corrupted by the English gold, he could not be too much on his guard. He was at last persuaded to repair to the castle of Lochmaben or Carlaverock, and there to wait the issue of the inroad.

It was probably at this place that James was prevailed on to come to the fatal resolution of appointing one Oliver Sinclair, a son of the house of Roslin, and a favourite minion at court, to command the army in chief; and his commission was made out accordingly.

Scotland.

458  
Th  
Sc  
to  
use  
to  
use

459  
Bu  
at  
last  
of  
f  
nt  
to  
vase  
England.

460  
L  
r  
Max  
well  
super  
e  
ed  
in  
the  
com  
n  
by  
Oliver  
Sin  
clair

Scotland.

454  
Distraction  
of James.

455  
The duke  
of Norfolk  
enters Scot  
land with  
formidable  
army.

456  
Conf. Tracy  
amongst  
James's fa  
vourites.

457  
The Eng  
lish oblige  
to retreat.

Scotland.

On the 23d of November, the Scots began their march at midnight; and having passed the Elk, all the adjacent villages were seen in flames by the break of day. Sir Thomas Wharton, the English warden of those marches, the bastard Daeres, and Musgrave, hastily raised a few troops, the whole not exceeding 500 men, and drew them up upon an advantageous ground; when Sinclair, ordering the royal banner to be displayed, and being mounted on the shoulders of two tall men, produced and read his commission. It is impossible to imagine the consternation into which the Scots were thrown upon this occasion; and their leaders setting the example, the whole army declared (according to the Scotch authors), that they would rather surrender themselves prisoners to the English, than submit to be commanded by such a general. In an instant, all order in the Scotch army was broken down; horse and foot, soldiers and scullions, noblemen and peasants, were intermingled. It was easy for the English general to perceive this confusion, and perhaps to guess at its cause. A hundred of his light horse happened to advance: they met no resistance: the nobles were the first who surrendered themselves prisoners; and the rest of the English advancing, they obtained a bloodless victory; for even the women and the boys made prisoners of Scotch soldiers, and few or none were killed. The lord Herbert relates the circumstances of this shameful affair with some immaterial differences; but agrees with the Scotch authorities upon the whole. He mentions, however, no more than 800 common soldiers having been made prisoners. The chief of the prisoners were the earls of Cassils and Glencairn, the lords Maxwell, Fleming, Somerville, Oliphant, and Gray, with above 200 gentlemen besides.

461  
The Scots  
shamefully  
defeated at  
Solway  
Mofs.

462  
James V.  
dies of  
grief.

James was then at Carlaveroch, which is about 12 miles distant from the place of action, depressed in his spirits, and anxious about the event of the expedition, which is to this day called the *Raid of Solway mofs*. When the news came to his ears, and that the earl of Arran and the cardinal were returned to Edinburgh, he was seized with an additional dejection of mind, which brought him to his grave. In such a situation every cruel action of his former life wounded his conscience; and he at last sunk into a sullen melancholy, which admitted of no consolation. From Carlaveroch he removed to Falkland; and was sometimes heard to express himself as if he thought that the whole body of his nobility were in a conspiracy against his person and dignity. The presence of the few attendants who were admitted into his chamber, and who were the wicked instruments of his misconduct, seemed to aggravate his sufferings, and he either could not or would not take any sustenance. His death being now inevitable, Beaton approached his bed-side with a paper, to which he is said to have directed the king's hand, pretending that it was his last will. On the 18th of December, while James was in this deplorable state, a messenger came from Linlithgow, with an account that the queen was brought to bed of a daughter; and the last words he was distinctly heard to say, were, "It will end as it began: the crown came by a woman, and it will go with one; many miseries approach this poor kingdom; king Henry will either master it by arms, or win it by marriage." He then turned his face to the wall, and in broken ejaculations pronounced the word

*Solway mofs*, and some faint expressions alluding to the disgrace he suffered. In this state he languished for some days; for it is certain he did not survive the 13th.

Scotland.

James V. was succeeded by his infant daughter Mary, whose birth we have already mentioned. James had taken no steps for the security of his kingdom, so that ambitious men had now another opportunity of throwing the public affairs into confusion. The situation of Scotland indeed at this time was very critical. Many of the nobility were prisoners in England, and those who remained at home were factious and turbulent. The nation was dispirited by an unsuccessful war. Commotions were daily excited on account of religion, and Henry VIII. had formed a design of adding Scotland to his other dominions. By a testamentary deed which cardinal Beaton had forged in the name of his sovereign, he was appointed tutor to the queen and governor of the realm, and three of the principal nobility were named to act as his counsellors in the administration. The nobility and the people, however, calling in question the authenticity of this deed, which he could not establish, the cardinal was degraded from the dignity he had assumed; and the estates of the kingdom advanced into the regency James Hamilton, earl of Arran, whom they judged to be entitled to this distinction, as the second person of the kingdom, and the nearest heir, after Mary, to the crown.

463  
succeeded  
by Ma-

464  
Critical si-  
tuation of  
affairs.

465  
Earl of Ar-  
ran ap-  
pointed re-  
gent.

The disgrace of cardinal Beaton might have proved the destruction of his party, if the earl of Arran had been endowed with vigour of mind and ability. But his views were circumscribed; and he did not compensate for this defect by any firmness of purpose. He was too indolent to gain partisans, and too irresolute to fix them. Slight difficulties filled him with embarrassment, and great ones overpowered him. His enemies, applying themselves to the vividity of his disposition, betrayed him into weaknesses; and the esteem which his gentleness had procured him in private life, was lost in the contempt attending his public conduct, which was feeble, fluctuating, and inconsistent.

466  
His charac-  
ter.

The attachment which the regent was known to profess for the reformed religion, drew to him the love of the people; his high birth, and the mildness of his virtues, conciliated their respect; and from the circumstance, that his name was at the head of the roll of heretics which the clergy had presented to the late king, a sentiment of tenderness was mingled with his popularity. His conduct corresponded, at first, with the impressions entertained in his favour. Thomas Guillaume and John Rough, two celebrated preachers, were invited to live in his house; and he permitted them to declaim openly against the errors of the church of Rome. They attacked and exposed the supremacy of the pope, the worship of images, and the invocation of saints. Cardinal Beaton and the prelates were exceedingly provoked, and indefatigably active to defend the established doctrines.

467  
He be-  
comes po-  
pular on  
account of  
his attach-  
ment to the  
reforma-  
tion.

This public function afforded to the reformation was of little consequence, however, when compared with a measure which was soon after adopted by Robert lord Maxwell. He proposed, that the liberty of reading the scriptures in the vulgar tongue should be permitted to the people; and that, for the future, no heretical guilt should

468  
The people  
permitted  
to read the  
scriptures  
in their  
mother-  
tongue.

Scotland. should be inferred against any person for having them in his possession, or for making use of them. The regent and the three estates acknowledged the propriety of this proposal. Gavin Dunbar archbishop of Glasgow, and chancellor of Scotland, protested, indeed, for himself and for the church, that no act on this subject should pass and be effectual, till a provincial council of all the clergy of the kingdom should consider and determine, whether there was a necessity that the people should consult and study the scriptures in the vulgar tongue. But his protestation being disregarded, the bill of the lord Maxwell was carried into a law, and the regent made it generally known by a proclamation.

From this period copies of the Bible were imported in great numbers from England; and men, allured by an appeal so flattering to their reason, were proud to recover from the supine ignorance in which they had been kept by an awful priesthood. To read became a common accomplishment: and books were multiplied in every quarter, which disclosed the pride, the tyranny, and the absurdities of the Romish church and superstitions.

<sup>469</sup> Henry VIII. proposes to unite the kingdoms by the marriage of Edward VI. with Mary. The death of James V. proved very favourable to the ambitious designs of Henry. He now proposed an union of the two kingdoms by the marriage of his son Edward VI. with Mary the young queen of Scotland. To promote this, he released the noblemen who had been taken prisoners at Solway, after having engaged them on oath, not only to concur in promoting the alliance, but to endeavour to procure him the charge and custody of the young queen, with the government of her kingdom, and the possession of her castles. The earl of Angus and his brother, who had been fifteen years in exile, accompanied them to Scotland, and brought letters from Henry recommending them to the restitution of their honours and estates. The regent was inclined to favour the demands of persons of such eminent station; but though the states were inclined to the marriage, they refused to permit the removal of the queen into England, and treated with contempt the idea of giving the government of Scotland and the care of the castles to the king of England. Sir Ralph Sadler, the English ambassador, exerted all his endeavours to induce the regent to comply with the requisitions of his master; but all his intrigues were unsuccessful; and Henry perceiving that he must depart from such extravagant conditions, at last authorized the commissioners to consent to treaties of amity and marriage, on the most favourable terms that could be procured. In consequence of these powers given to the commissioners, it was agreed that a firm peace and alliance should take place between the two nations, and that they should mutually defend and protect one another in case of an invasion. The queen was to remain within her own dominions till she was ten years of age; and Henry was not to claim any share in the government. Six nobles, or their apparent heirs, were to be surrendered to him in security for the conveyance of the young queen into England, and for her marriage with prince Edward, as soon as she was ten years of age. It was also stipulated, that though the queen should have issue by Edward, Scotland should retain not only its name, but its laws and liberties.

<sup>470</sup> He de- parts from some of his proposals.

<sup>471</sup> The regent opposed by cardinal Beaton,

These conditions, however advantageous to Scotland, yet did not give entire satisfaction Cardinal

Beaton, who had been imprisoned on pretence of treasonable schemes, and was now released from his confinement by the influence of the queen-dowager, took all opportunities of exclaiming against the alliance, as tending to destroy the independency of the kingdom. He pointed out to the churchmen the dangers which arose from the prevalence of heresy, and urged them to unanimity and zeal. Awakening all their fears and selfishness, they granted him a large sum of money with which he might gain partizans; the friars were instructed to preach against the treaties with England; and fanatical men were instructed to display their rage in offering indignities to Sir Ralph Sadler.

Cardinal Beaton was not the only antagonist the regent had to deal with. The Earls of Argyle, Huntley, Bothwell, and Murray, concurred in the opposition; and having collected some troops, and possessed themselves of the queen's person, they assumed all the authority. They were joined by the earl of Lenox, who was made to hope that he might espouse the queen-dowager and obtain the regency. He was also inclined to oppose the earl of Arran, from an ancient quarrel which had subsisted between their two families; and from a claim he had to supersede him, not only in the enjoyment of his personal estates, but in the succession to the crown. The regent, alarmed at such a powerful combination against him, inclined to attend to some advances which were made him by the queen-dowager and cardinal. To refuse to confirm the treaties, after he had brought them to a conclusion, was, however, a step so repugnant to probity, that he could not be prevailed upon to adopt it. He therefore, in a solemn manner, ratified them in the abbey-church of Holyroodhouse, and commanded the great seal of Scotland to be appended to them. The same day he went to St Andrew's, and issued a mandate to the cardinal, requiring him to return to his allegiance. To this the prelate refused to pay any attention, or to move from his castle; upon which the regent denounced him a rebel, and threatened to compel him to submission by military force. But in a few days after, the pusillanimous regent meeting with Beaton, forsook the interest of Henry VIII. and embraced that of the queen-dowager and of France. Being in haste also to reconcile himself to the church of Rome, he renounced publicly, at Stirling, the opinions of the reformed, and received absolution from the hands of the cardinal.

By this mean-spirited conduct the regent exposed himself to universal contempt, while cardinal Beaton usurped the whole authority. The earl of Lenox, finding that he had no hopes of success in his suit to the queen-dowager, engaged in negotiations with Henry, to place himself at the head of the Scottish lords who were in the English interest, and to assert the cause of the reformation. The consequence of all this was a rupture with England. Henry not only delayed to ratify the treaties on his part, but ordered all the Scottish ships in the harbours of England to be taken and confiscated. This violent proceeding inflamed the national disgusts against the English alliance; and the party of the cardinal and queen-dowager thus obtained an increase of popularity. Henry himself, however, was so much accustomed to acts of outrage and violence, that he seemed to think the step he had just now taken a matter of no moment; and therefore he demanded

Scotland.

<sup>472</sup> And by several noble men;

<sup>473</sup> But confirms the treaties of amity and marriage with England.

<sup>474</sup> He abandons the English interest, and renounces the Protestant religion.

<sup>475</sup> Henry's violent proceedings.

Scotland manded that the hostages, in terms of the treaty of marriage, should still be delivered up to him. But the cardinal and regent informed his ambassador, Sir Ralph Sadler, that from their own authority they could not command any of the nobles to be committed to him as hostages; and that the offensive strain of behaviour assumed by the English monarch might have altered the sentiments of the Scottish parliament with regard to a measure of such importance. After much altercation, the conferences were broken off; and as the lords who were released from captivity had promised to return prisoners to England, it now remained with them to fulfil their promise. None of them, however, had the courage to do so, excepting the earl of Cassils; and Henry, being struck with his punctilious sense of honour, dismissed him loaded with presents.

476  
The nego-  
ziation  
broken off

Cardinal Beaton being thus in possession of power, took measures to secure it. The solemnity of the coronation of the young queen was celebrated at Stirling. A council was chosen to direct and assist the regent in the greater affairs of state, at the head of which was the queen dowager. John Hamilton, the abbot of Paisley, who had acquired an ascendancy over the regent, was also promoted to the privy seal, and made treasurer of the kingdom; and cardinal Beaton, upon the request of the regent and the three estates, accepted the office of lord high chancellor.

477  
The queen  
crowned.

After the flatteries and the hopes with which the earl of Lenox had been amused, the cardinal had reason to dread the utmost warmth of his resentment. He had therefore written to Francis I. giving a detail of the critical situation of affairs in Scotland, and intreating him to recall to France the earl of Lenox, who was now interested to oppose the influence and operations of the queen-dowager. But the indignation with which the treachery of the cardinal had inflamed the earl of Lenox, precipitated him into immediate action, and defeated the intention of this artifice. In the hostile situation of his mind towards Scotland, an opportunity of commencing hostilities had presented itself. Five ships had arrived in the Clyde from France, loaded with warlike stores, and having on board the patriarch of Venice, Peter Contareni, legate from Paul III. with La Brosse, and James Mesnaye, ambassadors from France; and 50,000 crowns, which were to be employed in strengthening the French faction, and to be distributed by the queen dowager and the cardinal. Pre-vailling with the commanders of these vessels, who conceived him to be the fast friend of their monarch, he secured this money for his own use, and deposited the military stores in his castle of Dumbarton, under the care of George Stirling the deputy-governor, who at this time was entirely in his interests.

478  
Enmity be-  
tween car-  
dinal Be-  
ton and the  
earl of Le-  
nox.

479  
Hostilities  
commenced  
by the lat-  
ter.

By the successful application of this wealth, the earl of Lenox called forth the full exertion of his party in levying a formidable army, with which he threatened the destruction of the regent and the cardinal, offering them battle in the fields between Leith and Edinburgh. The regent, not being in a condition to accept the challenge of his rival, had recourse to negotiation. Cardinal Beaton and the earl of Huntley proposed terms of amity, and exerted themselves with so much address, that the earl of Lenox, losing the opportunity of chastising his enemies, consented to an accommodation, and indulged anew the hope of obtaining the queen-

480  
Lenox suf-  
fers himself  
to be accus-  
ed by his  
enemies.

dowager in marriage. His army was dismissed, and he threw himself at the feet of his mistress, by whom he was, in appearance, favourably received: but many of his friends were seduced from him under different pretences; and at last, apprehending his total ruin from some secret enterprise, he fled to Glasgow, and fortified himself in that city. The regent, collecting an army, marched against him; and having defeated his friend the earl of Glencairn in a bloody encounter, was able to reduce the place of strength in which he confided. In this ebb of his fortune, the earl of Lenox had no hope but from England.

Scottland.  
481  
Amble is  
obliged to  
fly.

The revolution produced in the political state of Scotland by the arts of cardinal Beaton, while it defeated the intrigues of Henry VIII. pointed all its strength against the progress of the reformation. After abandoning his old friends, the regent, in connection with the cardinal, was ambitious to undo all the services he had rendered to them. The three estates annulled the treaties of amity and marriage, and empowered commissioners to conclude an alliance with France. The regent discharged the two preachers Guillaume and Rough, whom he had invited to impugn the doctrines of the church. He drove back into England many pious persons, whose zeal had brought them to Scotland, to explain and advance the new opinions. He caressed with particular respect the legate whom the pope had sent to discourage the marriage of the young queen with the prince of Wales, and to promise his assistance against the enterprises of Henry VIII. He procured an act of parliament to be passed for the persecution of heretics; and, upon the foundation of this authority, the most rigorous proceedings were concerted against the reformed; when the arms of England, rousing the apprehensions of the nation, gave the tullest employment to the regent and his counsellors.

482  
The ce-  
leration  
with France  
on the 2d,  
and the  
prelates to  
be executed.

In the rage and anguish of disappointed ambition, the earl of Lenox made an offer to assist the views of the king of England; who, treating him as an ally, engaged, in the event of success, to give him in marriage his niece the lady Margaret Douglas, and to invest him in the regency of Scotland. To establish the reformation in Scotland, to acquire the superiority over it to Henry VIII. and to effectuate the marriage of the prince of Wales with the queen of Scots, were the great objects of their contederacy.

483  
Lenox en-  
gages in  
the English  
interest.

Henry, though engaged in a war with France, which required all his military force, could not resist the earliest opportunity in his power to execute his vengeance against Scotland. Edward Symour earl of Hartford was appointed to command 10,000 men; who were embarked at Tinnmouth, aboard a fleet of 200 ships, under the direction of Sir John Dudley lord Lisle. This army was landed without opposition near Leith; and the earl of Hartford made it known to Sir Adam Otterburn, the provost of Edinburgh, that his commission empowered him to lay the country waste and desolate, unless the regent should deliver up the young queen to the king of England. It was answered, that every extremity of distress would be endured, before the Scottish nation would submit to so ignominious a demand. Six thousand horse from Berwick, under the lord Evers, now joined the earl of Hartford. Leith and Edinburgh, after a feeble resistance, yielded to the English commander; who abandoned them to pillage, and

484  
An E. lisa  
t m v r n  
t r s Scot-  
land.

485  
Who com-  
mit or el-  
levations,  
and  
then sud-  
dly re-  
and tuc.

Scotland. and then set fire to them. A cruel devastation ensued in the surrounding villages and country, and an immense booty was conveyed on board the English fleet. But, while an extreme terror was everywhere excited, the earl of Hartford re-embarked a part of his troops, and ordered the remainder to march with expedition to the frontiers of England.

The regent, assisted by cardinal Beaton and the earls of Huntley, Argyle, Bothwell, and Murray, was active, in the mean time, to collect an army, and to provide for the security of the kingdom. He felt, therefore, the greatest surprise on being relieved so unexpectedly from the most imminent danger; and an expedition, conducted with so little discernment, did not advance the measures of Henry VIII. To accomplish the marriage of the young queen with the prince of Wales, to possess himself of her person, or to achieve a conquest over Scotland, were all circumstances apparently within the reach of the English commander: and yet, in the moment of victory, he neglected to prosecute his advantages; and having inflamed the animosities of the Scottish nation, by a display of the passions and cruelty of his master, left them to recover from their disaster, and to improve in their resources.

The earl of Lenox, taking the opportunity of the English fleet, went to consult with Henry VIII. upon the desperate state of his affairs. He renewed his engagements with this monarch; and received in marriage the lady Margaret Douglas, with possessions in England. Soon after, he arrived in the frith of Clyde, with 18 ships and 600 soldiers, that he might secure the castle of Dumbarton, and employ himself in plundering and devastation. But George Stirling, to whom the castle was intrusted, refused to surrender it; and even obliged him to re-embark his troops. After engaging in a few petty incursions and skirmishes, he returned to England.

In 1544, Henry consented to a truce; and Scotland, after having suffered the miseries of war, was subjected to the horrors of persecution. The regent had procured an act of parliament for the persecution of the reformed; and the cardinal, to draw to himself an additional splendour and power, had obtained from the pope the dignity of legate *à latere*. A visitation of his own diocese appeared to him the most proper method of commencing the proposed extirpation of heresy; and he carried with him in his train the regent, and many persons of distinction, to assist in his judicatories, and to share in his disgrace.

In the town of Perth a great many persons were accused and condemned. The most trifling offences were regarded as atrocious crimes, and made the subjects of persecution and punishment. Robert Lamb was hanged for affirming that the invocation of saints had no merit to save. William Anderson, James Reynolds, and James Finlayson, suffered the same death, for having abused an image of St Francis, by putting horns upon his head. James Hunter, having kept their company, was found to be equally guilty, and punished in the same manner. Helen Stirke, having refused, when in labour, to invoke the assistance of the Virgin, was drowned in a pool of water. Many of the burghesses of Perth, being suspected of heresy, were sent into banishment; and the lord Ruthven, the provost, was upon the same account dismissed from his office.

The cardinal was strenuous in persecuting heresy in other parts of his diocese. But the discontents and clamour attending the executions of men of inferior station were now lost in the fame of the martyrdom of George Wishart; a person who, while he was respectable by his birth, was highly eminent from the opinion entertained of his capacity and endowments. The historians of the Protestant persuasion have spoken of this reformer in terms of the highest admiration. They extol his learning as extensive, insist on the extreme candour of his disposition, and ascribe to him the utmost purity of morals. But while the strain of their panegyric is exposed to suspicion from its excess, they have ventured to impute to him the spirit of prophecy; so that we must necessarily receive their eulogiums with some abatement. It may be sufficient to affirm, that Mr Wishart was the most eminent preacher who had hitherto appeared in Scotland. His mind was certainly cultivated by reflection and study, and he was amply possessed of those abilities and qualifications which awaken and agitate the passions of the people. His ministry had been attended with the most flattering success; and his courage to encounter danger grew with his reputation. The day before he was apprehended, he said to John Knox, who attended him; "I am weary of the world, since I perceive that men are weary of God." He had already reconciled himself to that terrible death which awaited him. He was found in the house of Cockburn of Ormiston, in East Lothian, who refusing to deliver him to the servants of the regent, the earl of Bothwell, the sheriff of the county, required that he should be intrusted to his care, and promised that no injury should be done to him. But the authority of the regent and his counsellors obliged the earl to surrender his charge. He was conveyed to the cardinal's castle at St Andrew's, and his trial was hurried on with precipitation. The cardinal and the clergy proceeding in it without the concurrence of the secular power, adjudged him to be burnt alive. In the circumstances of his execution there appears a deliberate and most barbarous cruelty. When led out to the stake, he was met by priests, who, mocking his condition, called upon him to pray to the virgin, that she might intercede with her Son for mercy to him. "Forbear to tempt me, my brethren," was his mild reply to them. A black coat of linen was put upon him by one executioner, and bags of powder were fastened to his body by another. Some pieces of ordnance were pointed to the place of execution. He spoke to the spectators, intreating them to remember that he was to die for the true gospel of Christ. Fire was communicated to the faggots. From a balcony in a tower of his castle, which was hung with tapestry, the cardinal and the prelates, reclining upon rich cushions, beheld the inhuman scene. This insolent triumph, more than all his afflictions, affected the magnanimity of the sufferer. He exclaimed, that the enemy, who so proudly solaced himself, would perish in a few days, and be exposed ignominiously in the place which he now occupied.

Cardinal Beaton took a pleasure in receiving the congratulations of the clergy upon a deed, which, it was thought, would fill the enemies of the church with terror. But the indignation of the people was more excited than their fears. All ranks of men were dis-

Scotland;

489  
account of  
Mr George  
Wishart.486  
success  
the earl  
Knox.487  
succ  
cluded  
Eng.488  
by cruel  
utions  
cour.t  
li-

gusted.

Scotland.

493  
Cardinal  
Beaton af-  
filiated

gusted with an exercise of power which despised every boundary of moderation and justice. The prediction of Mr Wishart, suggested by the general odium which attended the cardinal, was considered by the disciples of this martyr as the effusion of a prophet; and perhaps gave occasion to the assassination that followed. Their complaints were attended to by Norman Lesly, the eldest son of the earl of Rothes, whom the cardinal had treated with indignity, though he had profited by his services. He consented to be their leader. The cardinal was in his castle at St Andrew's, which he was fortifying after the strongest fashion of that age. The conspirators, at different times, early in the morning, entered into it. The gates were secured; and appointing a guard, that no intimation of their proceedings might go to the cardinal, they dismissed from the castle all his workmen separately, to the number of 100, and all his domestics, who amounted to no fewer than 50 persons. The eldest son of the earl of Arran, whom he kept as an hostage for his father's behaviour, was alone detained by them. The prelate, alarmed with their noise, looked from his window, and was informed that his castle was taken by Norman Lesly. It was in vain that he endeavoured to secure the door of his chamber by bolts and chests. The conspirators brought fire, and were ready to apply it, when, admitting them into his presence, he implored their mercy. Two of them struck him hastily with their swords. But James Melvil, rebuking their passion, told them, that this work and judgment of God, though secret, ought to be done with gravity. He reminded the cardinal, in general terms, of the enormity of his sins, and reproached him in a more particular manner with the death of Mr Wishart. He swore, that no hopes of his riches, no dread of his power, and no hatred to his person, were any motives which actuated him; but that he was moved to accomplish his destruction, by the obstinacy and zeal manifested by him against Christ Jesus and his holy gospel. Waiting for no answer to his harangue, he thrust the cardinal three times through the body with his dagger, on the 29th of May 1546.

The rumour that the castle was taken giving an alarm to the inhabitants of St Andrew's, they came in crowds to gratify their curiosity, and to offer their assistance, according to the sentiments they entertained. The adherents and dependents of the cardinal were clamorous to see him; and the conspirators, carrying his dead body to the very place from which he had beheld the sufferings of Mr Wishart, exposed it to their view.

494  
Treaty of  
peace be-  
tween Eng-  
land,  
France, and  
Scotland.

The truce, in the mean time, which had been concluded with England was frequently interrupted; but no memorable battles were fought. Mutual depredations kept alive the hostile spirit of the two kingdoms; and while the regent was making military preparations, which gave the promise of important events, a treaty of peace was finished between England and France, in which Francis I. took care to comprehend the Scottish nation. In this treaty it was stipulated by Henry, that he was not to wage war against Scotland, unless he should be provoked by new and just causes of hostility.

But the murderers of cardinal Beaton, apprehensive of their safety, had dispatched messengers into England, with applications to Henry for assistance; and being joined by more than 120 of their friends, they took the resolution of keeping the castle, and of defending

themselves. Henry, notwithstanding his treaty with France, resolved to embrace this opportunity of augmenting the disturbances of Scotland. He hastened to collect troops; and the regent and his counsellors pressed France for supplies in men and money, and military stores and artillery.

The high places which the cardinal occupied were filled up immediately upon his death. John Hamilton abbot of Paisley was elected archbishop of St Andrew's, and George earl of Huntley was promoted to be chancellor. By these officers the regent was urged to proceed with vigour against the conspirators; and it was a matter of the greatest anxiety to him to recover his eldest son, whom they detained in custody. The clergy had, in the most solemn manner, pronounced them to be accursed; and agreed to furnish, for four months, a monthly subsidy of 3000 l. to detray the expence of reducing them to obedience. The queen dowager and the French faction were eager, at the same time, to concur in avenging the assassination of a man to whose counsels and services they were so greatly indebted. — And that no dangerous use might be made of the eldest son of the earl of Arran, who, after his father, was the heir of the monarchy, an act of parliament was passed, excluding him from his birthright while he remained in the possession of the enemies of his country, and substituting his brothers in his place, according to their seniority. The dark politics of Henry suggested the necessity of this expedient; and in its meaning and tendency there may be remarked the spirit and greatness of a free people.

A powerful army laid siege to the castle of St Andrew's, and continued their operations during four months; but no success attended the assailants. The fortifications were strong; and a communication with the besieged was open by sea to the king of England, who supplied them with arms and provisions. The garrison received his pay, and the principal conspirators had pensions from him. In return for his generosity, they were engaged to promote the marriage of his son with the young queen; to advance the reformation; and to keep in custody the eldest son of the regent. Negotiation succeeded to hostility; and as the regent expected assistance from France, and the conspirators had the prospect of support from an English army, both parties were disposed to gain time. A treaty was entered into and transacted, in which the regent engaged to procure from Rome an absolution to the conspirators, and to obtain to them from the three estates an exemption from prosecutions of every kind. Upon the part of the besieged, it was stipulated, that when these conditions were fulfilled, the castle should be surrendered, and the regent's son be delivered up to him. In the mean time Henry VIII. died; and a few weeks after Francis I. also paid his debt to nature. But the former, before his death, had recommended the prosecution of the Scottish war; and Henry II. the successor of Francis, was eager to show his attention to the ancient ally of his nation. When the absolution arrived from Rome, the conspirators refused to consider it as valid; and an expression used by the pope, implying an absurdity, furnished an apology for their conduct. They knew that the counsellors of Edward VI. were making vigorous preparations to invade Scotland; they were confident of their present ability to defend themselves; and the

Scotland.  
492  
Proceed-  
ings agai-  
nst the mur-  
ders of the  
cardinal.493  
Castle of  
St Andrew's  
besieged.494  
Death of  
Henry VIII.  
and Francis  
I.



Scotland. advocates for the reformation encouraged them with hopes and with flattery.

The favourers of the reformation, in the mean time, adopting the intolerant maxims of the Roman Catholics, were highly pleased with the assassination of Beaton; and many of them congratulated the conspirators upon what they called their godly deed and enterprise. John Rough, who had formerly been chaplain to the regent, entered the castle and joined them. At this time also John Knox began to distinguish himself in an eminent manner, both by his success in argument and the unbounded freedom of his discourse; while the Roman clergy, every where defeated and ashamed, implored the assistance of the regent and his council, who assured them that the laws against heretics should be put in execution.

495  
John Knox begins to distinguish himself.

In the mean time the castle of St Andrew's being invested by a fleet of 16 sail under admiral Strozzi from France, was obliged to capitulate. Honourable conditions were granted to the conspirators; but after being conveyed to France, they were cruelly used, from the hatred entertained by the Catholics against the Protestants. Many were confined in prisons; and others, among whom, says Dr Stuart, was John Knox, were sent to the galleys. The castle itself was rased to the ground.

496  
Castle of St Andrew's taken.

The same year, 1547, Scotland was invaded by an English army under the duke of Somerset, who had been chosen protector of England during the minority of Edward VI. The design of this invasion was to oblige the Scots to comply with the scheme of Henry VIII. and conclude a marriage between Edward and the young queen of Scotland. The English army consisted of 18,000 men; besides which the protector had a fleet of 60 sail, one half of which were ships of war, and the others consisted of vessels laden with provisions and military stores. On the other hand, the regent opposed him with an army of 40,000 men. Before the commencement of hostilities, however, the duke of Somerset addressed a letter or manifesto to the government, in which he pressed the marriage with such powerful arguments, and so clearly showed the benefits which would result from it to both nations, that the regent and his party, who were averse to peace, thought proper to suppress it, and to circulate a report that the English had come to force away the queen, and to reduce the kingdom to a state of dependence. All hopes of an accommodation being thus removed, the English army advanced in order to give battle to the Scots. They found the latter posted in the most advantageous situation, around the villages of Musselburgh, Inveresk, and Monckton; so that he could not force them to an action, at the same time that he found himself in danger of having his communication with his ships cut off, which would have totally deprived his army of the means of subsistence. In this dangerous situation he had again recourse to negotiation, and offered terms still more favourable than before. He now declared himself ready to retire into England, and to make ample compensation for the injuries committed by his army, if the Scottish government would promise that the queen should not be contracted to a foreign prince, but should be kept at home till she was of age to choose a husband for herself, with the consent of the nobility. These concessions increased the confidence of the regent so much, that,

VOL. XVII. Part I.

without taking advantage of the strength of his situation, he resolved to come to a general engagement.—

The protector moved towards Pinkey, a gentleman's house to the eastward of Musselburgh; and the regent, conceiving that he meant to take refuge in his fleet, changed the strong ground in which he was encamped. He commanded his army to pass the river Esk, and to approach the English forces, which were posted on the middle of Fafide-hill. The earl of Angus led on the van; the main body of the battle marched under the regent; and the earl of Huntley commanded in the rear. It was the regent's intention to seize the top of the hill. The lord Gray, to defeat this purpose, charged the earl of Angus, at the head of the English cavalry. They were received upon the points of the Scottish spears, which were longer than the lances of the English horsemen, and put to flight. The earl of Warwick, more successful with his command of infantry, advanced to the attack. The ordnance from the fleet assisted his operations; and a brisk fire from the English artillery, which was planted on a rising ground, served still more to intimidate the Scottish soldiery.— The remaining troops under the protector were moving slowly, and in the best order, to take a share in the engagement. The earl of Angus was not well supported by the regent and the earl of Huntley. A panic spread itself through the Scottish army. It fled in different ways, presenting a scene of the greatest havoc and confusion. Few perished in the fight; but the chase continuing in one direction to Edinburgh, and in another to Dalkeith, with the utmost fury, a prodigious slaughter was made. The loss of the conquerors did not amount to 500 men; but 10,000 soldiers perished on the side of the vanquished. A multitude of prisoners were taken; and among these the earl of Huntley, the lord high chancellor.

Scotland.  
498  
Battle of Pinkey.

Amidst the consternation of this decisive victory, the duke of Somerset had a full opportunity of effectuating the marriage and union projected by Henry VIII. and on the subject of which such fond anxiety was entertained by the English nation. But the cabals of his enemies threatening his destruction at home, he yielded to the necessities of his private ambition, and marched back into England. He took precautions, however, to secure an entry into Scotland, both by sea and land. A garrison of 200 men was placed in the isle of St Columba in the Forth, and two ships of war were left as a guard to it. A garrison was also stationed in the castle of Broughty, which was situated in the mouth of the Tay. When he passed through the Merse and Teviotdale, the leading men of these counties repaired to him; and taking an oath of allegiance to king Edward, surrendered their places of strength. Some of these he demolished, and to others he added new fortifications. Hume castle was garrisoned with 200 men, and intrusted to Sir Edward Dudley; and he posted 300 soldiers, with 200 pioneers, in the castle of Roxburgh, under the command of Sir Ralph Bulmer.

499  
The Scots defeated with great slaughter.

500  
Duke of Somerset returns to England.

The only resource of the regent now was the hope of assistance from France. The young queen was lodged in the castle of Dumbarton, under the care of the lords Erskine and Livingstone; and ambassadors were sent to Henry II. of France, acquainting him with the disaster at Pinkey, and imploring his assistance. The regent

D had

Scotland.  
501  
Farther  
successes  
of the  
English.

had asked permission from the protector to treat of peace, and the earl of Warwick was appointed to wait for them at Berwick; but none were ever sent on the part of Scotland. It was not long, therefore, before hostilities were recommenced by the English. Lord Gray led an army into Scotland, fortified the town of Haddington, took the castles of Yester and Dalkeith, laid waste the Merse, and the counties of East and Mid Lothian. On the other hand, in June 1548, Monsieur de Desse, a French officer of great reputation, landed at Leith with 6000 soldiers, and a formidable train of artillery.

In the mean time, the regent was in disgrace on account of the disaster at Pinkey; and the queen-dowager being disposed to supersede his authority, attempted to improve this circumstance to her own advantage. As she perceived that her power and interest could best be supported by France, she resolved to enter into the strictest alliance with that kingdom. It had been proposed that the dauphin of France should marry the queen of Scotland; and this proposal now met with many partizans, the hostilities of the English having lost a great number of friends to the cause of that country. It was resolved to send the queen immediately to France, which would remove the cause of the present contentions, and her subsequent marriage with the dauphin would in the fullest manner confirm the friendship betwixt the two nations. The French government also entered deeply into the scheme; and in order to promote it made presents of great value to many of the Scottish nobility. The regent himself was gained over by a pension of 12,000 livres, and the title of duke of Chatellerault. Monsieur de Villegagnon, who commanded four galleys in the harbour of Leith, making a feint as if he intended to proceed instantly to France, raked about to the north, and, sailing round the isles, received the queen at Dumbarton; whence he conveyed her to France, and delivered her to her uncles the princes of Lorraine, in the month of July 1548.

502  
The queen  
sent to  
France.

These transactions did not put an end to the military operations. The siege of Haddington had been undertaken as soon as the French auxiliaries arrived, and was now conducted with vigour. To reinforce the garrison, 1500 horse advanced from Berwick; but an ambuscade being laid for them, they were intercepted, and almost totally destroyed. Another body of English troops, however, which amounted only to 300 persons, was more successful. Eluding the vigilance of the Scots and the French, they were able to enter Haddington, and to supply the besieged with ammunition and provisions. The lord Scymour, high admiral of England, made a descent upon Fife with 1200 men, and some pieces of artillery; but was driven back to his ships with great slaughter by James Stuart, natural brother to the young queen, who opposed him at the head of the militia of the county. A second descent was made by him at Montrose; but being equally unsuccessful there, he was obliged to leave Scotland without performing any important or memorable achievement.

503  
The Eng-  
lish met  
with several  
checks.

Having collected an army of 17,000 men, and adding to it 3000 German Protestants, the protector put it under the direction of the earl of Shrewsbury. Upon the approach of the English, Desse, though he had

been reinforced with 15,000 Scots, thought it more prudent to retreat than to hazard a decisive battle. He raised the siege of Haddington, and marched to Edinburgh. The earl of Shrewsbury did not follow him to force an engagement; jealousies had arisen between the Scots and the French. The insolence and vanity of the latter, encouraged by their superior skill in military arts, had offended the quick and impatient spirit of the former. The fretfulness of the Scots was augmented by the calamities inseparable from war; and after the conveyance of the young queen to France, the efficacious and peculiar advantage conferred upon that kingdom by this transaction was fully understood, and appeared to them to be highly disgraceful and impolitic. In this state of their humour, Desse found not at Edinburgh the reception he expected. The quartering of his soldiers produced disputes, which ended in an insurrection of the inhabitants. The French fired among the citizens. Several persons of distinction fell, and among these were the provost of Edinburgh and his son. The national discontents and inquietudes were driven, by this event, to the most dangerous extremity; and Desse, who was a man of ability, thought of giving employment to his troops, and of flattering the people by the splendour of some martial exploit.

The earl of Shrewsbury, after supplying Haddington with troops, provisions, and military stores, retired with his army into England. Its garrison, in the enjoyment of security, and unsuspecting of danger, might be surpris'd and overpowered. Marching in the night, Desse reached this important post; and destroying a fort of observation, prepared to storm the main gates of the city, when the garrison took the alarm. A French deserter pointing a double cannon to the thickest ranks of the assailants, the shot was incredibly destructive, and threw them into confusion. In the height of their consternation, a vigorous sally was made by the besieged. Desse renewed the assault in the morning, and was again discomfited. He now turned his arms against Broughty castle; and, though

505  
Unsuccessful  
attempt  
on Had-  
dington.

unable to reduce it, he yet recovered the neighbouring town of Dundee, which had fallen into the possession of the enemy. Hume castle was retaken by stratagem. Desse entered Jedburgh, and put its garrison to the sword. Encouraged by this success, he ravaged the English borders in different incursions, and obtained several petty victories. Leith, which from a small village had grown into a town, was fortified by him; and the island of Inchkeith, which is nearly opposite to that harbour, being occupied by English troops, he undertook to expel them, and made them prisoners after a brisk encounter.

506  
Desse the  
French ge-  
neral gains  
some ad-  
vantages.

His activity and valour could not, however, compose the discontents of the Scottish nation; and the queen-dowager having written to Henry II. to recal him, he was succeeded in his command by Monsieur de Thermes, who was accompanied into Scotland by Monsieur bishop of Valence, a person highly esteemed for his address and ability. This ecclesiastic was designed to supply the loss of cardinal Beaton, and to discharge the office of lord high chancellor of Scotland. But the jealousies of the nation increasing, and the queen-dowager herself suspecting his ambition and turbulence, he attained not this dignity, and soon returned to his own country.

Scotland. De Thermes brought with him from France a reinforcement of 1000 foot, 2000 horse, and 100 men-at-arms. He erected a fort at Aberlady, to distress the garrison of Haddington, and to intercept its supplies of provision. At Coldingham he destroyed a troop of Spaniards in the English pay. Fast-castle was regained by surprize. Distractions in the English court did not permit the protector to act vigorously in the war. The earl of Warwick was diverted from marching an army into Scotland. An infectious distemper had broke out in the garrison at Haddington; and an apprehension prevailed, that it could not hold out for any length of time against the Scots. The earl of Rutland, therefore, with a body of troops, entered the town; and after setting fire to it, conducted the garrison and artillery to Berwick. The regent, in the possession of Haddington, was solicitous to recover the other places which were yet in the power of the English. De Thermes laid siege to Broughty castle, and took it. He then besieged Lawder; and the garrison was about to surrender at discretion, when the news arrived that a peace was concluded between France, England, and Scotland.

By this treaty Henry II. obtained the restitution of Boulogne and its dependencies, which had been taken from him by the king of England, and for which he paid 400,000 crowns. No opposition was to be given to the marriage of the queen of Scotland with the dauphin: the fortresses of Lawder and Douglas were to be restored to the Scots, and the English were to destroy the castles of Roxburgh and Eymouth.

509 The queen-dowager goes to France, and schemes against the regent. After the ratification of the articles, the queen-dowager embarked with Leon Strozzi for France, attended by many of the nobility. Having arrived there, she communicated to the king her design of assuming the government of Scotland, and he promised to assist her to the utmost of his power. But the jealousy which prevailed between the Scots and French rendered the accomplishment of this design very difficult. To remove the regent by an act of power might endanger the scheme altogether; but it might be possible to persuade him to resign his office voluntarily. For this purpose intrigues were immediately commenced; and indeed the regent himself contributed to promote their schemes by his violent persecution of the reformed. The peace was hardly proclaimed, when he provoked the public resentment by an action of sanguinary insolence. Adam

510 Adam Wallace suffers on account of religion Wallace, a man of simple manners, but of great zeal for the reformation, was accused of heresy, and brought to trial in the church of the Black Friars at Edinburgh. In the presence of the regent, the earls of Angus, Huntley, Glencairn, and other persons of distinction and rank, he was charged with preaching without any authority of law, with baptizing one of his own children, and with denying the doctrine of purgatory; and it was strenuously objected to him, that he accounted prayers to the saints and the dead to be an useless superstition, that he had pronounced the mass to be an idolatrous service, and that he had affirmed that the bread and wine in the sacrament of the altar, after the words of the consecration, do not change their nature, but continue to be bread and wine. These offences were esteemed too terrible to admit of any pardon.—The earl of Glencairn alone protested against his punishment. The pious sufferer bore with resignation the

contumelious insults of the clergy; and by his courage and patience at the stake gave a sanction to the opinions he had embraced.

Other acts of atrocity and violence stained the administration of the regent. In his own palace, William Crichton, a man of family and reputation, was assassinated by the lord Semple. No attempt was made to punish the murderer. His daughter was the concubine of the archbishop of St Andrew's, and her tears and intreaties were more powerful than justice. John Melvil, a person respectable by his birth and his fortune, had written to an English gentleman, recommending to his care a friend who at that time was a captive in England. This letter contained no improper information in matters of state, and no suspicion of any crime against Melvil could be inferred from it. Yet the regent brought him to trial upon a charge of high treason; and, for an act of humanity and friendship, he was condemned to lose his head. The estate of Melvil, forfeited to his family, was given to David the youngest son of the regent.

Amidst the pleasures and amusements of the French court, the queen-dowager was not inattentive to the scheme of ambition which she had projected. The earls of Huntley and Sutherland, Marischal and Cassilis, with the lord Maxwell, and other persons of eminence who had accompanied her to France, were gained over to her interests. Robert Carnegie of Kinnaird, David Panter bishop of Ross, and Gavin Hamilton commendator of Kilwinning, being also at this time in that kingdom, and having the greatest weight with the regent, were treated with a most punctilious respect. Henry declared to them his earnest wish that the queen-dowager might attain the government of Scotland. In case the regent should consent to this measure, he expressed a firm intention that no detriment should happen to his consequence and affairs; and he desired them to inform him, that he had already confirmed his title of *duke of Chatelherault*, had advanced his son to be captain of the Scots gendarmes in France, and was ready to tender other marks of favour to his family and relations. Upon this business, and with this message, Mr Carnegie was dispatched to Scotland; and a few days after, he was followed by the bishop of Ross. The bishop being a man of eloquence and authority, obtained, though with great difficulty, a promise from the regent to resign his high office; and for this service he received, as a recompense, an abbey in Poitou.

The queen-dowager, full of hopes, now prepared to return to Scotland, and in her way thither made use of a safe-conduct obtained from Edward VI. by the king of France. The English monarch, however, had not yet forgot the beautiful queen of Scotland; and did not fail to urge his superiority of claim to her over the dauphin. The queen-dowager did not seriously enter upon the business; only in general terms complained of the hostilities committed by the English; and two days after this conversation, she proceeded towards Scotland. where she was conducted by the earl of Bothwell, lord Hume, and some other noblemen, to Edinburgh, amidst the acclamations of the people. She had not long been returned to the capital, when the bad conduct of the regent afforded her an opportunity of exerting her influence and address to the advantage of her project. The regent having proposed a judicial circuit through

Scotland. the kingdom, under pretence of repressing crimes and disorders, molested the people by plunder and rapine. Great fines were levied for offences pretended as well as real; and the Protestants in particular seemed to be the objects of his displeasure and severity. In his progress he was accompanied by the queen-dowager; and as she affected to behave in a manner directly opposite, the most disagreeable comparisons were made between her and the regent. The bishop of Ross, to whom he had promised to resign his office, did not fail to put him in mind of his engagements; but he had now altered his mind, and wished still to continue in power. His resolution, however, failed him on the first intimation of a parliamentary inquiry into the errors of his administration. An agreement with the queen-dowager then took place; and it was stipulated, that he should succeed to the throne upon the death of the queen without issue; that his son should enjoy the command of the gendarmes; that no inquiry should be made into his expenditure of the royal treasures; that no scrutiny into his government should take place; and that he should enjoy in the most ample manner his duchy and his pension. These articles were ratified at an assembly of parliament, and the queen-dowager was formally invested with the regency.

Mary of Lorraine, the new regent, though she had with great difficulty attained the summit of her wishes, seemed to be much less versant in the arts of government than of intrigue. She was scarcely settled in her new office when she rendered herself unpopular in two respects; one was by her too great attachment to France, and the other by her persecution of the reformed religion. She was entirely guided by the councils of her brothers the duke of Guise and the cardinal of Lorraine; and paid by far too much attention to M. d'Oysel the French ambassador, whom they recommended to her as an able and faithful minister. Several high offices were filled with Frenchmen, which excited in the highest degree the resentment of the Scottish nobility; and the commonalty were instantly prejudiced against her by the partiality she showed to the Papists. At first, however, she enacted many salutary laws; and while she made a progress herself through the southern provinces of the kingdom to hold judiciary courts, she endeavoured to introduce order and law into the western counties and isles; first by the earl of Huntley, and afterwards by the earls of Argyle and Athole, to whom she granted commissions for this purpose with effectual powers. In another improvement, which the queen regent attempted by the advice of her French council, she found herself opposed by her own people. It was proposed that the possessions of every proprietor of land in the kingdom should be valued and entered into registers; and that a proportional payment should be made by each. The application of this fund was to maintain a regular and standing body of soldiers. This guard or army, it was urged, being at all times in readiness to march against an enemy, would protect effectually the frontiers; and there would no longer be any necessity for the nobles to be continually in motion on

every rumour of hostility or incursion from English invaders. No art, however, or argument, could recommend these measures. A perpetual tax and a standing army were conceived to be the genuine characteristics of despotism. All ranks of men considered themselves insulted and abused; and 300 tenants of the crown assembling at Edinburgh, and giving way to their indignation, sent their remonstrances to the queen-regent in such strong and expressive language, as induced her to abandon the scheme. Yet still the attempt which she had made left an impression in the minds of the people. They suspected her to be a secret enemy to their government and liberties; and they were convinced that Henry II. was engaging her in refinements and artifices, that he might reduce Scotland to be a province of France.

While an alarm about their civil rights was spreading itself among the people, the Protestants were rising daily in their spirit and in their hopes. John Knox (P), whose courage had been confirmed by misfortunes, and whose talents had improved by exercise, was at this time making a progress through Scotland. The characteristic peculiarities of Popery were the favourite topics of his declamation and censure. He treated the mass, in particular, with the most sovereign contempt, representing it as a remnant of idolatry. Many of the nobility and gentry afforded him countenance and protection. They invited him to preach at their houses, and they partook with him in the ordinances of religion after the reformed method. Religious societies and assemblies were held publicly, in defiance of the Papists; and celebrated preachers were courted with assiduity and bribes to reside and officiate in particular districts and towns. The clergy cited him to appear before them at Edinburgh, in the church of the Black-friars. On the appointed day he presented himself, with a numerous attendance of gentlemen, who were determined to exert themselves in his behalf. The priesthood did not choose to proceed in his prosecution; and Knox, encouraged by this symptom of their fear, took the resolution to explain and inculcate his doctrines repeatedly and openly in the capital city of Scotland. In 1556, the earl of Glencairn allured the earl Marischal to hear the exhortations of this celebrated preacher; and they were so much affected with his reasonings and rhetoric, that they requested him to address the queen-regent upon the subject of the reformation of religion. In compliance with this request, he wrote a letter in very disagreeable terms; and the earl of Glencairn delivered it with his own hand, in the expectation that some advantage might in this manner be obtained for the reformed. But the queen-regent was no less offended with the freedom of the nobleman than the preacher; and, after perusing the paper, she gave it to James Beaton archbishop of Glasgow, with an expression of disdain, "Here, my lord, is a pasquil."

Amidst these occupations, John Knox received an invitation to take the charge of the English congregation at Geneva; which he accepted. The clergy called up on him, in his absence, to appear before them, condemn-

514  
Rapacity  
and injustice  
of the  
regent.

515  
He resigns  
his office,  
which is  
given to  
the queen-  
dowager.

516  
She renders  
herself un-  
popular.

517  
Attempts  
in vain to  
establish a  
standing  
army.

Scotland.

518  
John Knox  
encourages  
the reform-  
ers.

519  
Writes an  
offensive  
letter to  
the queen-  
regent.

520  
Goes to  
Geneva,  
and is burnt  
in effigy.

(P) When he was sent to France (says Dr Stuart), with the conspirators against Cardinal Beaton, he was confined to the galleys; but had obtained his liberty in the latter end of the year 1549.

Scotland. ed him to death as a heretic, and ordered him to be burned in effigy.

<sup>521</sup> The injurious treatment of John Knox did not in the least obstruct the progress of the reformation. Desertions were made from Popery in every town and village; and even many members of the church, both secular and regular, were forward to embrace the new principles, and to atone for their past mistakes by the bitterest raileries against the corruptions and the folly of the Romish faith. The priests were treated in all places with ridicule and contempt. The images, crucifixes, and relics, which served to rouse the decaying fervours of superstition, were stolen from the churches, and trampled under foot. The bishops implored the assistance of the queen-regent. Citations were given to the preachers to appear in their defence. They obeyed; but with such a formidable retinue, that it was with difficulty she was permitted to apologise for her conduct. James Chalmers of Gaitgirth, pressing forward from the crowd, addressed himself to her: "We vow to God, that the devices of the prelates shall not be carried into execution. We are oppressed to maintain them in their idleness. They seek to undo and murder our preachers and us; and we are determined to submit no longer to this wickedness." The multitude, applauding his speech, put their hands to their daggers.

A trusty messenger was dispatched to Geneva, inviting John Knox to return to his own country. But in the infancy of their connection, the Protestants being apprehensive of one another, uncertain in their counsels, or being deserted by persons upon whom they had relied, it appeared to them that they had adopted this measure without a due preparation; and, by opposite dispatches, Knox was requested to delay his journey for some time.

To this zealous reformer their unsteadiness was a matter of serious affliction; and in the answer he transmitted to their letters, he rebuked them with severity: but amidst this correction, he intreated them not to faint under their purposes, from apprehensions of danger, which, he said, was to separate themselves from the favour of God, and to provoke his vengeance. To particular persons he wrote other addresses; and to all of them the greatest attention was paid. In 1557, a formal bond of agreement, which obtained the appellation of *the first covenant*, was entered into, and all the more eminent persons who favoured the reformation were invited to subscribe it. The earls of Argyle, Glencairn, and Morton, with the lord Lorn, and John Erskine of Dun, led the way, by giving it the sanction of their names. All the subscribers to this deed, renouncing the superstitions and idolatry of the church of Rome, promised to apply continually their whole power and wealth, and even to give up their lives, to forward and establish the word of God. They distinguished the reformed, by calling them the *Congregation of Christ*; and by the opprobrious title of the *Congregation of Satan*, they peculiarized the favourers of Popery.

<sup>523</sup> After the leaders of the reformation had subscribed the first covenant, they addressed letters to John Knox, urging in the strongest terms his return to Scotland; and that their hopes of his assistance might not be disappointed, they sent an address to John Calvin, the celebrated reformer, begging him to join his commands to their intreaties. The archbishop of St Andrew's, who

perceived the rising storm, was in a difficult situation. A powerful combination threatened ruin to the church; and he had separated himself from the politics of the queen-regent. The zeal of the Roman Catholics pointed out strong measures to him; and his dispositions were pacific. The clergy were offended with his remissness and neglect of duty. The reformers detested his looseness of principles, and were shocked with the dissolute depravity of his life and conversation. He resolved to try the force of address, and did not succeed. He then resolved to be severe, and was still more unsuccessful.

The earl of Argyle was the most powerful of the reformed leaders. To allure him from his party, the archbishop of St Andrew's employed the agency of Sir David Hamilton. But the kindness he affected, and the advices he bestowed, were no compliment to the understanding of this nobleman; and his threats were regarded with scorn. The reformers, instead of losing their courage, felt a sentiment of exultation and triumph; and the earl of Argyle happening to die about this time, he not only maintained the new doctrines in his last moments, but intreated his son to seek for honour in promoting the public preaching of the gospel and Jesus Christ, and in the utter ruin of superstition and idolatry.

It was determined by the archbishop and the prelates, that this disappointment should be succeeded by furious persecution of the reformed. Walter Mill, a priest, had neglected to officiate at the altar; and having been long under the suspicion of heresy, was carried to St Andrew's, committed to prison, and accused before the archbishop and his suffragans. He was in an extreme old age; and he had struggled all his life with poverty. He sunk not, however, under the hardness of his fate. To the articles of his accusation he replied with signal recollection and fortitude. The firmness of his mind, in the emaciated state of his body, excited admiration. The insults of his enemies, and their contempt, served to discover his superiority over them. When the clergy declared him a heretic, no temporal judge could be found to condemn him to the fire. He was repited to another day; and so great sympathy prevailed for his misfortunes, that it was necessary to allure one of the archbishop's domestics to supply the place of the civil power, and to pronounce the sentence of condemnation. When brought to the stake, the resolution of this sufferer did not forsake him. He praised God, that he had been called to seal up the truth with his life; and he conjured the people, as they would escape eternal death, not to be overcome by the errors and the artifices of monks and priests, abbots and bishops.

The barbarity of this execution affected the reformers with inexpressible horror. Subscriptions for mutual defence were taken. The leaders of the reformation, dispersing their emissaries to every quarter, encouraged the vehemence of the multitude. The covenant to establish a new form of religion extended far and wide. The sharp point of the sword, not the calm exertions of inquiry, was to decide the disputes of theology.

When the leaders of the reformation were apprised of the ardent zeal of the people, and considered the great number of subscriptions which had been collected in the different counties of the kingdom, they assembled

<sup>524</sup> The archbishop of St Andrew's attempts in vain to secure the earl of Argyle.

<sup>525</sup> Walter Mill executed on account of religion.

<sup>526</sup> The Protestants resolve to assert their rights.

Scotl:nd.  
527  
Petition  
the queen-  
regent.

to deliberate concerning the steps to be pursued. It was resolved, accordingly, that a public and common supplication of the whole body of the Protestants should be presented to the queen-regent; which, after complaining of the injuries they had suffered, should require her to bestow upon them her support and assistance, and urge her to proceed in the work of a reformation. To explain their full meaning, a schedule, containing particular demands, was at the same time to be presented to her scrutiny. To Sir James Sandilands of Calder they committed the important charge of their manifesto and articles of reformation; and in appointing him to this commission, they consulted the respect which was due both to the government and to themselves. His character was in the highest estimation. His services to his country were numerous; his integrity and honour were superior to all suspicion; and his age and experience gave him authority and reverence.

The petition or supplication of the Protestants was expressed in strong but respectful terms. They told the queen-regent, that though they had been provoked by great injuries, they had yet, during a long period, abstained from assembling themselves, and from making known to her their complaints. Banishment, confiscation of goods, and death in its most cruel shape, were evils with which the reformed had been afflicted; and they were still exposed to these dreadful calamities. Compelled by their sufferings, they presumed to ask a remedy against the tyranny of the prelates and the estate ecclesiastical. They had usurped an unlimited domination over the minds of men. Whatever they commanded, though without any sanction from the word of God, must be obeyed. Whatever they prohibited, tho' from their own authority only, it was necessary to avoid. All arguments and remonstrances were equally fruitless and vain. The fire, the faggot, and the sword, were the weapons with which the church enforced and vindicated her mandates. By these, of late years, many of their brethren had fallen; and upon this account they were troubled and wounded in their consciences. For conceiving themselves to be a part of that power which God had established in this kingdom, it was their duty to have defended them, or to have concurred with them in an open avowal of their common religion. They now take the opportunity to make this avowal. They break a silence which may be misinterpreted into a justification of the cruelties of their enemies. And disdaining all farther dissimulation in matters which concern the glory of God, their present happiness, and their future salvation, they demand, that the original purity of the Christian religion shall be restored, and that the government shall be so improved, as to afford to them a security in their persons, their opinions, and their property.

With this petition or supplication of the Protestants, Sir James Sandilands presented their schedule of demands, or the preliminary articles of the reformation. They were in the spirit of their supplication, and of the following tenor.

528  
Articles of  
the refor-  
mation.

I. It shall be lawful to the reformed to peruse the Scriptures in the vulgar tongue; and to employ also their native language in prayer publicly and in private.

II. It shall be permitted to any person qualified by knowledge, to interpret and explain the difficult passages in the Scriptures.

Scotland.

III. The election of ministers shall take place according to the rules of the primitive church; and those who elect shall inquire diligently into the lives and doctrines of the persons whom they admit to the clerical office.

IV. The holy sacrament of baptism shall be celebrated in the vulgar tongue, that its institution and nature may be the more generally understood.

V. The holy sacrament of the Lord's supper shall likewise be administered in the vulgar tongue; and in this communion, as well as in the ceremonial of baptism, a becoming respect shall be paid to the plain institution of Christ Jesus.

VI. The wicked and licentious lives of the bishops and estate ecclesiastical shall be reformed; and if they discharge not the duties of true and faithful pastors, they shall be compelled to desist from their ministry and functions.

The queen-regent now found it necessary to flatter the Protestants. She assured them by Sir James Sandilands, their orator or commissioner, that every thing they could legally desire should be granted to them; and that, in the mean time, they might, without molestation, employ the vulgar tongue in their prayers and religious exercises. But, upon the pretence that no encouragement might be given to tumults and riot, she requested that they would hold no public assemblies in Edinburgh or Leith. The Congregation, for this name was now assumed by the Protestants, were transported with these tender proofs of her regard; and while they sought to advance still higher in her esteem by the inoffensive quietness of their carriage, they were encouraged in the undertaking they had begun, and anxious to accomplish the work of the reformation.

Nor to the clergy, who at this time were holding a provincial council at Edinburgh, did the Congregation scruple to communicate the articles of the intended reformation. The clergy received their demands with a storm of rage, which died away in an innocent debility. Upon recovering from their passions, they offered to submit the controversy between them and the reformed to a public disputation. The Congregation did not refuse this mode of trial; and desired, as their only conditions, that the Scriptures might be considered as the standards of orthodoxy and truth, and that those of their brethren who were in exile and under persecution might be permitted to assist them. These requests, though reasonable in a high degree, were not complied with; and the church would allow no rule of right but the canon law and its own councils. Terms of reconciliation were then offered on the part of the estate ecclesiastical. It held out to the Protestants the liberty of praying and administering the sacraments in the vulgar tongue, if they would pay reverence to the mass, acknowledge purgatory, invoke the saints, and admit of petitions for the dead. To conditions so ineffectual and absurd the Congregation did not deign to return any answer.

The meeting of the parliament approached. The parties in contention were agitated with anxieties, apprehensions, and hopes. An expectation of a firm and open assistance from the queen-regent gave courage to the reformed; and, from the parliamentary influence of their friends in the greater and the lesser baronage, they expected the most important services. They drew up with eagerness the articles which they wished to be passed

519  
The Prote-  
stants flatter-  
ed by  
the queen-  
regent.

530  
They offer  
to dispute  
with the  
Romish  
clergy.

Scotland.  
531  
resent  
their arti-  
cles to the  
queen re-  
gent.

passed into a law; and as the spirit and sense of their transactions are to be gathered in the completest manner from the papers which were framed by themselves, it is proper to attend to them with a punctilious exactness. Their petitions were few and explicit.

I. They could not, in consequence of principles which they had embraced from a conviction of their truth, participate in the Romish religion. It was therefore their desire, that all the acts of parliament, giving authority to the church to proceed against them as heretics, should be abrogated; or, at least, that their power should be suspended till the disputes which had arisen were determined and brought to a conclusion.

II. They did not mean that all men should be at liberty to profess what religion they pleased, without the controul of authority. They consented that all transgressors in matters of faith should be carried before the temporal judge. But it was their wish that the clergy should have only the power to accuse; and they thought it conformable to justice, that a copy of the criminal charge should be lodged with the party upon trial, and that a competent time should be allowed him to defend himself.

III. They insisted, that every defence consistent with law should be permitted to the party accused; and that objections to witnesses, founded in truth and reason, should operate to his favour.

IV. They desired that the party accused should have permission to interpret and explain his own opinions; and that his declaration should carry a greater evidence than the deposition of any witness: as no person ought to be punished for religion, who is not obstinate in a wicked or damnable tenet.

V. In fine, they urged, that no Protestant should be condemned for heresy, without being convicted, by the word of God, of the want of that faith which is necessary to salvation.

The Congregation presented these articles to the queen-regent, expecting that she would not only propose them to the three estates assembled in parliament, but employ all her influence to recommend them. But finding themselves disappointed, they began to suspect her sincerity; and they were sensible that their petitions, though they should be carried in parliament, could not pass into a law without her consent. They therefore abstained from presenting them; but as their complaints and desires were fully known in parliament, they ordered a solemn declaration to be read there in their behalf, and demanded that it should be inserted in the records of the nation. In this declaration, after expressing their regret for having been disappointed in their scheme of reformation, they protested, that no blame should be imputed to them for continuing in their religion, which they believed to be founded in the word of God; that no danger of life, and no political pains, should be incurred by them, for disregarding statutes which support idolatry, and for violating rites which are of human invention; and that, if insurrections and tumults should disturb the realm, from the diversity of religious opinions, and if abuses should be corrected by violence, all the guilt, disorder, and inconvenience thence arising, instead of being applied to them, should be ascribed to those solely who had refused a timely redress of wrongs, and who had despised petitions presented with the humility of faithful subjects, and for the purposes of

532  
protest a-  
gainst her  
proceed-  
ings.

establishing the commandments of God, and a most just and salutary reformation.

The three estates received this formidable protest with attention and respect; but the intention of inserting it in the national records was abandoned by the Congregation, upon a formal promise from the queen-regent, that all the matters in controversy should speedily be brought by her to a fortunate issue.

While the Protestants were thus making the most vigorous exertions in behalf of their spiritual liberties, the queen-regent, in order to establish herself the more effectually, used every effort to promote the marriage of her daughter with the dauphin of France. In 1557, commissioners were appointed to negotiate this marriage; but while these negotiations were going on, the court of France acted in the most perfidious manner.

At the age of 15, after solemnly ratifying the independence of Scotland, and the succession of the crown in the house of Hamilton, queen Mary was influenced by the king and her uncles the princes of Lorraine to sign privately three extraordinary deeds or instruments. By the first she conveyed the kingdom of Scotland to the king of France and his heirs, in the default of children of her own body. By the second she assigned him, if she should die without children, the possession of Scotland, till he should receive a million of pieces of gold, or be amply recompensed for the sums expended by him in the education of the queen of Scotland in France. By the third she confirmed both these grants in an express declaration, that they contained the pure and genuine sentiments of her mind; and that any papers which might be obtained, either before or after her marriage, by means of the Scottish parliament, should be invalid, and of no force nor efficacy. On the 24th of April, the nuptials were celebrated; and the dauphin, Francis, was allowed to assume the title of king of Scotland. The French court demanded for him the crown and other ensigns of royalty belonging to Scot-

533  
Perfidious  
conduct of  
the court of  
France.

land; but the commissioners had no power to comply with their request. It was then desired, that when they returned home, they should use all their influence to procure the crown-matrimonial of Scotland for the dauphin. This also was refused; the court of France was disgusted; and four of the commissioners died, it was supposed of poison, given them by the princes of Lorraine. This subject, however, was pressed, on the return of the surviving commissioners, by the king of France himself, the queen of Scotland, and the queen-regent. The Protestants also joined their interest, hoping by that means to gain over the queen and queen-regent to their party; so that an act of parliament was at length passed, by which the crown-matrimonial was given to the dauphin during the time of his marriage with queen Mary; but without any prejudice to the liberties of the kingdom, to the heirs of her body, or to the order of succession. With so many restraints, it is difficult to see the advantages which could accrue from this gift so earnestly sought after; and it is very probable, that the usurpations of France in consequence of it, would have been productive of many disturbances; but these were prevented by the death of Francis in December 1560.

534  
Marriage  
of the  
queen of  
Scots with  
the dau-  
phin of  
France.

535  
He obtains  
the crown  
of Scot-  
land, but  
under cer-  
tain restric-  
tions.

But before this event took place, Scotland was, by the intrigues of France, involved in confusion on another account. After the death of Mary queen of Eng-

Scotland.

land,

land, and daughter to Henry VIII. the princes of Guise insisted on the claim of Mary queen of Scots to the crown of England, in preference to that of Elizabeth, whom they looked upon as illegitimate. This claim was supported by the king of France, who prevailed with the queen of Scots herself to assume the title of queen of England, and to stamp money under that character. The arms of England were quartered with those of France and Scotland; and employed as ornaments for the plate and furniture of Mary and the dauphin. Thus was laid the foundation of an irreconcilable quarrel between Elizabeth and Mary; and to this, in some measure, are we to ascribe the inveteracy with which the former persecuted the unhappy queen of Scotland, at every time she had it in her power.

536  
The queen of Scots claims the crown of England,  
537  
Which lays the foundation of a quarrel with Elizabeth.

538  
Scheme to destroy all the leaders of the Protestant party in Scotland.

539  
Treachery or behaviour of the queen-regent.

540  
Proceedings against the Protestants.

541  
They become formidable by their numbers.

But while they imprudently excited a quarrel with England, they yet more imprudently quarrelled also with the majority of the people of Scotland. As Elizabeth professed the Protestant religion, it was easily foreseen, that the *Congregation*, or body of the reformed in Scotland, would never consent to act against her in favour of a Popish power; and as they could not be gained, it was resolved to destroy them at once, by putting to death all their leaders. The queen-regent gave intimation of her design to re-establish Popery, by proclaiming a solemn observance of Easter, receiving the sacrament according to the Romish communion, herself, and commanding all her household to receive it in the same manner. She next expressed herself in a contemptuous manner against the reformed, affirmed that they had insulted the royal dignity, and declared her intention of restoring it to its ancient lustre. The preachers of the Congregation were next cited to appear at Stirling, to answer the charges which might be brought against them. Alexander earl of Glencairn, and Sir Hugh Campbell of Loudon, were deputed to admonish her not to persecute the preachers, unless they had been obnoxious by circulating erroneous doctrines, or disturbing the peace of government. The queen-regent in a passion told them, that the preachers should all be banished Scotland, though their doctrines were as sound as those of St Paul. The deputies urged her former kind behaviour and promises; but the queen-regent answered, that "the promises of princes ought not to be exacted with rigour, and that they were binding only when subservient to their convenience and pleasure." To this they replied, that in such a case they could not look upon her as their sovereign, and must renounce their allegiance as subjects.

Soon after this transaction, the queen-regent received the news that the reformation was established in Perth. Lord Ruthven the provost of the city was summoned to answer for this innovation; but his reply was, that he had no dominion over the minds and consciences of men. The provost of Dundee, being ordered to apprehend an eminent preacher, named *Paul Methven*, sent him intelligence of the order, that he might provide for his safety. The proclamation for observing Easter was everywhere despised and neglected, and people exclaimed against the mass as an idol. New citations, in the mean time, had been given to the preachers to appear at Stirling. They obeyed the summons; but attended by such multitudes, that the queen-regent, treading their power, though they were

without arms, intreated Mr Erskine of Dun, whom Scotland they had sent before as a deputy, to stop their march; assuring him that all proceedings against the preachers should be stopped. In consequence of this, the multitude dismissed; yet, when the day came on which the preachers should have appeared, the queen-regent, with unparalleled folly as well as treachery, caused them to be declared traitors, and proclaimed it criminal to afford them any subsistence.

Mr Erskine, exasperated by this shameful conduct, hastened to the Congregation, apologized for his conduct, and urged them to proceed to the last extremities. At this critical period also John Knox returned from Geneva, and joined the Congregation at Perth. The great provocations which the Protestants had already received, joined to the impetuous passions of the multitude, were now productive of the greatest disorders. Images were destroyed, monasteries pulled down, and their wealth either seized by the mob or given to the poor. The example of Perth was followed by Cupar in Fife; and similar insurrections being apprehended in other places, the queen-regent determined to punish the inhabitants of Perth in the most exemplary manner. With this view she collected an army; but being opposed with a formidable power by the Protestants, she thought proper to conclude an agreement. The Protestants, however, dreaded her insincerity; and therefore entered into a new covenant to stand by and defend one another. Their fears were not vain. The queen-regent violated the treaty almost as soon as made, and began to treat the Protestants with severity. The

earl of Argyle, and the prior of St Andrew's, who about this time began to take the title of *lord James Stuart*, now openly headed the Protestant party, and prepared to collect their whole strength. The queen-regent opposed them with what forces she had, and which indeed chiefly consisted of her French auxiliaries; but, being again afraid of coming to an engagement, she consented to a truce until commissioners should be sent to treat with the lords of an effectual peace. No commissioners, however, were sent on her part; and the nobles, provoked at such complicated and unceasing treachery, resolved to push matters to the utmost extremity. The first exploit of the reformed was the taking of the town of Perth, where the queen-regent had placed a French garrison. The multitude, elated with this achievement, destroyed the palace and abbey of Seone, in spite of all the endeavours of their leaders, even of John Knox himself, to save them. The queen-regent, apprehensive that the Congregation would commit farther ravages to the southward, resolved to throw a garrison into Stirling; but the earl of Argyle and lord James Stuart were too quick for her, and arrived there the very day after the demolition of the abbey and palace of Seone. The people, incapable of restraint, and provoked beyond measure by the perfidious behaviour of the Catholic party, demolished all the monasteries in the neighbourhood, together with the fine abbey of Cambuskenneth, situated on the north bank of the Forth. From Stirling they went to Linlithgow, where they committed their usual ravages; after which, they advanced to Edinburgh. The queen-regent, alarmed at their approach, fled to Dunbar; and the Protestants took up their residence in Edinburgh.

Having thus got possession of the capital, the Congregation

542  
John Knox returns to Scotland.

543  
Second covenant. Treachery of the queen-regent.

544  
Perth taken by the Protestants.

545  
The queen-regent flies to Dunbar, and the Protestants become masters of Edinburgh.



*Scotland.* gregation assumed to themselves the ruling power of the kingdom, appointed preachers in all the churches, and seized the mint, with all the instruments of coining. The queen-regent, unable to dispute the matter in the field, published a manifesto, in which she set forth their seditious behaviour, commanding them to leave Edinburgh within six hours, and enjoining her subjects to avoid their society under the pain of treason. The Congregation having already lost somewhat of their popularity by their violent proceedings, were now incapable of coping with government. As they had not established themselves in any regular body, or provided a fund for their support, they felt their strength decay, and multitudes of them returned to their habitations. Those who remained found themselves obliged to vindicate their conduct; and, in an address to the regent, to disclaim all treasonable intentions. Negotiations again took place, which ended as usual; the queen-regent, who had taken this opportunity of collecting her forces, marched against the Congregation on the 23d of July 1559. The Protestants now found themselves incapable of making head against their enemies; and therefore entered into a negociation, by which all differences were for the present accommodated. The terms of this treaty were, that the town of Edinburgh should be open to the queen-dowager and her attendants; that the palace of Holyroodhouse and the mint should be delivered up to her; that the Protestants should be subject to the laws, and abstain from molesting the Roman Catholics in the exercise of their religion. On the queen's part, it was agreed, that the Protestants should have the free exercise of their religion, and that no foreign troops should enter the city of Edinburgh.

Notwithstanding this treaty, however, the reformed had no confidence in the queen's sincerity. Having heard of the death of Henry II. of France, and the accession of Francis II. and Mary to that kingdom, they seem to have apprehended more danger than ever. They now entered into a third covenant; in which they engaged themselves to refuse attendance to the queen-dowager, in case of any message or letter; and that immediately on the receipt of any notice from her to any of their number, it should be communicated without reserve, and be made a common subject of scrutiny and deliberation. It was not long before they had occasion for all their constancy and strength. The queen-regent repented of the favourable terms she had granted the reformed; and being denied the favour which she requested of saying mass in the high-church of Edinburgh, she ordered them to be everywhere disturbed in the exercise of their religion.

In this imprudent measure, the queen-regent was confirmed by letters which now came from Francis and Mary, promising a powerful army to support her interests. The envoy who brought these dispatches also carried letters to the lord James Stuart, now the principal leader of the Protestants, and natural brother to the queen. The letters were filled with reproaches and menaces, mixed with intreaties; and along with them the envoy delivered a verbal message, that the king his master was resolved rather to expend all the treasures of France than not to be revenged on the rebellious nobles who had disturbed the peace of Scotland. The lord James Stuart was not to be frightened by these menaces.

*Scotland.* He returned a cool and deliberate answer, apologizing for the Protestants, and vindicating them from the charge of rebellion; but at the same time intimating his full resolution of continuing to head the reformed as he had already done.

The letters of Francis and Mary were soon followed by 1000 French soldiers, with money and military stores; and the commander was immediately dispatched again to France, to solicit the assistance of as many more soldiers, with four ships of war, and 100 men-at-arms. But before he could set out, La Brosse, another French commander, arrived with 2000 infantry; and that the Congregation might be defeated not only by arms but in dispute, the same ship brought three doctors of the Sorbonne, to show the pernicious tendency of the new doctrines. Thus matters were pushed on beyond all hopes of reconciliation. The nation was universally alarmed on account of the introduction of French troops, to which they saw no end. The queen-regent attempted to quiet the minds of the public by a proclamation; but their fears increased the more. The Congregation assembled at Stirling, where they were joined by the earl of Arran, and soon after by his father the duke of Chatelherault. They next deliberated on the measures to be followed with the queen-regent; and the result of their consultations was, that an expostulatory letter should be addressed to her. This was accordingly done; but as the queen behaved with her usual duplicity, the nobles called the people to arms. Mutual manifestos were now published; and both parties prepared to decide the contest by the sword. The Congregation having seized Broughty castle, marched from thence to Edinburgh. The queen-regent retired to Leith, which she had fortified and filled with French troops. Thither the nobles sent their last message to her, charging her with a design to overthrow the civil liberties of the kingdom. They requested her to command her Frenchmen and mercenaries to depart from Leith, and to make that place open and patent, not only to the inhabitants who had been dispossessed of their houses, but to all the inhabitants of Scotland. They declared, that her denial of this request should be considered by them as a proof of her intention to reduce the kingdom to slavery; in which case, they were determined to employ their utmost power to preserve its independency. Two days after this message, the queen-regent sent to them the lord Lyon, whom she enjoined to tell them, that she considered their demand not only as presumptuous, but as an encroachment on the royal authority; that it was an indignity to her to be dictated to by subjects; that Frenchmen were not to be treated as foreigners, being entitled to the same privileges with Scotsmen; and that she would neither disband her troops, nor command the town of Leith to be made open and patent. The lord Lyon then, in the name of the queen-regent, commanded the lords of the Congregation to depart from Edinburgh, and disperse themselves, under the pain of high treason. The Protestants, irritated by this answer, after some deliberation degraded the queen-regent; and to this purpose the nobility, barons, and burgeses, all agreed in subscribing an edict, which was sent to the principal cities in Scotland, and published in them.

The next step taken by the Congregation was to

*552* The nobles send their last message to the queen-regent.

*553* Receive an unfavourable answer.

*554* They degrade her from her office, and lay siege to Leith.

Scotland. <sup>555</sup> summon Leith to surrender; but meeting with defiance instead of submission, it was resolved to take the town by escalade. For this service ladders were framed in the church of St Giles; a business which, interrupting the preachers in the exercise of public worship, made them prognosticate misfortune and miscarriage to the Congregation. In the displeasure of the preachers, the common people found a source of complaint; and the emissaries of the queen-dowager acting with indefatigable industry to divide her adversaries, and to spread chagrin and dissatisfaction among them, discontent, animosity, and terror, came to prevail to a great degree. The duke of Chatelherault discouraged many by his example. Defection from the Protestants added strength to the queen-dowager. The most secret deliberations of the confederated lords were revealed to her. The soldiery were clamorous for pay; and it was very difficult to procure money to satisfy their claims. Attempts to soothe and appease them, discovering their consequence, engendered mutinies. They put to death a domestic of the earl of Argyle, who endeavoured to compose them to order: they insulted several persons of rank who discovered a solicitude to pacify them; and they even ventured to declare, that, for a proper reward, they were ready to suppress the reformation, and to re-establish the mass.

<sup>556</sup> They fall into distress and treat with queen Elizabeth.

It was absolutely necessary to give satisfaction to the Protestant soldiers. The lords and gentlemen of the Congregation collected a considerable sum among them; but it was not equal to the present exigency. The avarice of many taught them to withhold what they could afford, and the poverty of others did not permit them to indulge their generosity. It was resolved, that each nobleman should surrender his silver-plate to be struck into money. By the address, however, of the queen-dowager, the officers of the militia were bribed to conceal, or to convey to a distance, the stamps and instruments of coinage. A gloomy despair gave disquiet to the Congregation, and threatened their ruin. Queen Elizabeth, with whose ministers the confederated lords maintained a correspondence at this time, had frequently promised them her assistance; but they could not now wait the event of a deputation to the court of England. In an extremity so pressing, they therefore applied for a sum of money to Sir Ralph Sadler and Sir James Croft, the governors of Berwick; and Cockburn of Ormiston, who was entrusted with this commission, obtained from them an aid of 4000 crowns. Traitors, however, in the councils of the Congregation, having informed the queen-dowager of his errand and expedition, the earl of Bothwell, by her order, intercepted him upon his return, discomfited his retinue, and made a prize of the English subsidy.

<sup>557</sup> English subsidy taken by the queen-regent.

To rouse the spirit of the party, an attack was projected upon Leith, and some pieces of artillery were planted against it. But before any charge could be made, the French soldiers sallied out to give battle to the troops of the Congregation, possessed themselves of their cannon, and drove them back to Edinburgh. A report that the victors had entered this city with the fugitives, filled it with disorder and dismay. The earl of Argyle and his Highlanders hastened to recover the honour of the day, and harassed the French in their retreat. This petty conflict, while it elated the queen-

<sup>558</sup> The Protestants defeated.

dowager, served to augment the dependence of the Protestants.

Vain of their prowess, the French made a new sally from Leith, with a view to intercept a supply of provisions and stores for the Congregation. The earl of Arran and the lord James Stuart advanced to attack them, and obliged them to retire. But pursuing them with too much heat, a fresh body of French troops made its appearance. It was prudent to retreat, but difficult. An obstinate resistance was made. It was the object of the French to cut off the soldiery of the Congregation from Edinburgh, and by these means to divide the strength of that station. The earl of Arran and the lord James Stuart had occasion for all their address and courage. Though they were able, however, to effect their escape, their loss was considerable, and the victory was manifestly on the side of their adversaries.

<sup>559</sup> The Protestants again defeated.

About this time William Maitland of Lethington, secretary to the queen-dowager, withdrew secretly from Leith, and joined himself to the confederated nobles. He had been disgusted with the jealousies of the French counsellors, and was exposed to danger from having embraced the doctrines of the reformed. His reception was cordial, and corresponded to the opinion entertained of his wisdom and experience. He was skilled in business, adorned with literature, and accustomed to reflection. But as yet it was not known, that his want of integrity was in proportion to the greatness of his talents.

<sup>560</sup> Maitland, the queen-dowager's secretary, revolts to the Protestants.

The accession of this statesman to their party could not console the lords of the Congregation for the unpromising aspect of their affairs. The two discomfitures they had received sunk deeply into the minds of their followers. Those who affected prudence, retired privately from a cause which they accounted to be desperate; and the timorous fled with precipitation. The wailings and distrust of the brethren were melancholy and infectious; and by exciting the ridicule and scorn of the partisans of the queen-dowager, were augmented the more. A distress not to be comforted seemed to have invaded the Protestants; and the associated nobles consented to abandon the capital. A little after midnight, they retired from Edinburgh; and so great was the panic which prevailed, that they marched to Stirling without any stop or intermission.

<sup>561</sup> They retire from Edinburgh to Stirling.

John Knox, who had accompanied the Congregation to Stirling, anxious to recover their unanimity and courage, addressed them from the pulpit. He represented their misfortunes as the consequences of their sins; and intreating them to remember the goodness of their cause, assured them in the end of joy, honour, and victory. His popular eloquence corresponding to all their warmest wishes, diffused satisfaction and cheerfulness. They passed from despair to hope. A council was held, in which the confederated nobles determined to solicit, by a formal embassy, the aid of queen Elizabeth. Maitland of Lethington, and Robert Melvil, were chosen to negotiate this important transaction; and they received the fullest instructions concerning the state and difficulties of the Congregation, the tyrannical designs of the queen-dowager, and the danger which threatened England from the union of Scotland with France.

<sup>562</sup> John Knox encourages them.

The queen of England having maturely considered the

Scotland, the case, determined to assist the reformers; whose leaders now dispersed themselves, and went to different parts of the kingdom, in order to employ their activity there for the common cause. The queen-dowager, imagining that the lords were fled, conceived great hopes of being able to crush the reformed at once. Her sanguine hopes, however, were soon checked, on receiving certain intelligence that queen Elizabeth was resolved to give them assistance. She now took the best measures possible, as circumstances stood; and determined to crush her enemies before they could receive any assistance from England. Her French troops took the road to Stirling, and wasted in their march all the grounds which belonged to the favourers of the reformation. After renewing their depredations at Stirling, they passed the bridge there; and proceeding along the side of the river, exercised their cruelties and oppressions in a district which had distinguished itself by an ardent zeal against popery. While the terror of their arms was thus diffusing itself, they resolved to seize the town and castle of St Andrew's, which they considered as an important military station, and as a convenient place of reception for the auxiliaries they expected from France.

But the lord James Stuart employed himself to interrupt their progress and retard their attempts; and it was his object at the same time, to keep the force of the Congregation entire, to hazard no action of importance, and to wait the approach of the English army. A small advantage was obtained by the French at Petticur; and they possessed themselves of Kinghorn. The lord James Stuart, with 500 horse and 100 foot, entered Dyfart. With this inconsiderable strength he proposed to act against an army of 4000 men. His admirable skill in military affairs, and his heroic courage, were eminently displayed. During 20 days he prevented the march of the French to St Andrew's, intercepting their provisions, harassing them with skirmishes, and intimidating them by the address and the boldness of his stratagems.

Monsieur d'Oysel, enraged and ashamed to be disconcerted and opposed by a body of men so disproportioned to his army, exerted himself with vigour. The lord James Stuart was obliged to retire. Dyfart and Wemyss were given to the French troops to be pillaged; and when d'Oysel was in full march to St Andrew's, he discovered a powerful fleet bearing up the frith. It was concluded, that the supplies expected from France were arrived. Guns were fired by his soldiers, and their joy was indulged in all its extravagance. But this fleet having taken the vessels which contained their provisions, and the ordnance with which they intended to improve the fortifications of the castle at St Andrew's, a period was put to their rejoicings. Certain news was brought, that the fleet they observed was the navy of England, which had come to support the Congregation. A consternation, heightened by the giddiness of their preceding transports, invaded them. Monsieur d'Oysel perceived now the value and merit of the service which had been performed by the lord James Stuart; and thinking no more of St Andrew's and conquest, fled to Stirling, in his way to Leith, from which he dreaded to be intercepted; but he reached that important station after a march of three days.

A formal treaty was now concluded between the lords of the Congregation and queen Elizabeth; and in the mean time the queen-dowager was disappointed in her expectations from France. The violent administration of the house of Guise had involved that nation in troubles and distress. Its credit was greatly sunk, and its treasury was nearly exhausted. Persecutions, and the spirit of Calvinism, produced commotions and conspiracies; and amidst domestic and dangerous intrigues and struggles, Scotland failed to engage that particular distinction which had been promised to its affairs. It was not, however, neglected altogether. The count De Martigues had arrived at Leith with 1000 foot and a few horse. The marquis D'Elbeuf had embarked for it with another body of soldiers; but, after losing several ships in a furious tempest, was obliged to return to the haven from which he had sailed.

In this sad reverse of fortune many forsook the queen-dowager. It was now understood that the English army was upon its march to Scotland. The Scottish lords who had affected a neutrality, meditated an union with the Protestants. The earl of Huntley gave a solemn assurance that he would join them. Proclamations were issued throughout the kingdom, calling upon the subjects of Scotland to assemble in arms at Linlithgow, to re-establish their ancient freedom, and to assist in the utter expulsion of the French soldiery.

The English fleet, meanwhile, under Winter the vice-admiral, had taken and destroyed several ships, had landed some troops upon Inchkeith, and discomfited a body of French mercenaries. Upon the foundation of these acts of hostility, the princes of Lorraine dispatched the chevalier de Seur to queen Elizabeth, to make representations against this breach of the peace, and to urge the recal of her ships. This ambassador affected likewise to negotiate concerning the evacuation of Scotland by the French troops, and to propose methods by which the king of France might quarter the arms of England without doing a prejudice to queen Elizabeth. But to prevent the execution of vigorous resolutions against the queen-dowager, and to gain time, were the only objects he had in view. With familiar intentions, John Monluc bishop of Valence, a man of greater address and ability, and equally devoted to the house of Guise, was also sent at this time to the court of England. Queen Elizabeth, however, and her ministers, were too wise to be amused by artifice and dexterity.

The lord Grey entered Scotland with an army of 1200 horse and 6000 foot; and the lord Scroop, Sir James Croft, Sir Henry Percy, and Sir Francis Lake commanded under him. By an inclement policy, the queen-dowager had already wasted all the country around the capital. But the desolation she had made, while it was ruinous to the Scottish peasants, affected not the army of England. The leaders of the Congregation did not want penetration and foresight, and had provided themselves against this difficulty. The duke of Chatelherault, the earls of Argyle, Gleacairn, and Menteith, the lord James Stuart, and the lords Ruthven, Boyd, and Ochiltree, with a numerous and formidable force, joined the English commander at Preston.

Struck with the sad condition of her affairs, despairing of a timely and proper succour from France, and reminded by sickness of her mortality, the queen-dowager

Scotland, the case, determined to assist the reformers; whose leaders now dispersed themselves, and went to different parts of the kingdom, in order to employ their activity there for the common cause. The queen-dowager, imagining that the lords were fled, conceived great hopes of being able to crush the reformed at once. Her sanguine hopes, however, were soon checked, on receiving certain intelligence that queen Elizabeth was resolved to give them assistance. She now took the best measures possible, as circumstances stood; and determined to crush her enemies before they could receive any assistance from England. Her French troops took the road to Stirling, and wasted in their march all the grounds which belonged to the favourers of the reformation. After renewing their depredations at Stirling, they passed the bridge there; and proceeding along the side of the river, exercised their cruelties and oppressions in a district which had distinguished itself by an ardent zeal against popery. While the terror of their arms was thus diffusing itself, they resolved to seize the town and castle of St Andrew's, which they considered as an important military station, and as a convenient place of reception for the auxiliaries they expected from France.

563  
Elizabeth determines to assist the reformers.

564  
The French troops waste the estates of the reformed.

565  
They are opposed with success by lord James Stuart.

566  
Arrival of the English fleet.

567  
The French general dies.

Scotland, the case, determined to assist the reformers; whose leaders now dispersed themselves, and went to different parts of the kingdom, in order to employ their activity there for the common cause. The queen-dowager, imagining that the lords were fled, conceived great hopes of being able to crush the reformed at once. Her sanguine hopes, however, were soon checked, on receiving certain intelligence that queen Elizabeth was resolved to give them assistance. She now took the best measures possible, as circumstances stood; and determined to crush her enemies before they could receive any assistance from England. Her French troops took the road to Stirling, and wasted in their march all the grounds which belonged to the favourers of the reformation. After renewing their depredations at Stirling, they passed the bridge there; and proceeding along the side of the river, exercised their cruelties and oppressions in a district which had distinguished itself by an ardent zeal against popery. While the terror of their arms was thus diffusing itself, they resolved to seize the town and castle of St Andrew's, which they considered as an important military station, and as a convenient place of reception for the auxiliaries they expected from France.

563  
Treaty between Elizabeth and the Scots Protestants.

569  
The queen-regent disappointed in her expectations from France.

570  
She is deserted by great numbers of her subjects.

571  
The princes of Lorraine attempt to negotiate with queen Elizabeth in vain.

572  
An English army enters Scotland.

Scotland.

573  
The queen-dowager retires to Edinburgh castle.

retired from Leith to the castle of Edinburgh, and put herself under the protection of the lord Erskine. At the period when she was appointed to the regency, the lord Erskine had received from the three estates the charge of this important fortress, with the injunction to hold it till he should know their farther orders; and giving way to the solicitations of neither faction, he had kept it with fidelity. By admitting the queen-dowager, he yielded to sentiments of honour and humanity, and did not mean to depart from his duty. A few only of her domestics accompanied her, with the archbishop of St Andrew's, the bishop of Dunkeld, and the earl Marischal.

574  
The Protestants invite her to an accommodation.

The confederated nobles now assembled at Dalkeith to hold a council; and conforming to those maxims of prudence and equity which, upon the eve of hostilities, had been formerly exercised by them, they invited the queen-dowager to an amicable conclusion of the present troubles. In a letter which they wrote to her, they called to her remembrance the frequent manifestos and messages in which they had pressed her to dismiss the French soldiery, who had so long oppressed the lower ranks of the people, and who threatened to reduce the kingdom itself to servitude. The aversion, however, with which she had constantly received their suit and prayers, was so great, that they had given way to a strong necessity, and had intreated the assistance of the queen of England to expel these strangers by the force of arms. But though they had obtained the powerful protection of this princess, they were yet animated with a becoming respect for the mother of their sovereign; and, abhorring to stain the ground with Christian blood, were disposed once more to solicit the dismissal of these mercenaries, with their officers and captains. And that no just objection might remain against the grant of this their last request, they assured her, that a safe passage by land, to the ports of England, should be allowed to the French; or that, if they judged it more agreeable, the navy of queen Elizabeth should transport them to their own country. If these proposals should be rejected, they appealed and protested to God and to mankind, that it should be understood and believed, that no motive of malice, or hatred, or wickedness of any kind, had induced them to employ the fatal expedient of arms and battles; but that they had been compelled to this disagreeable and distressful remedy, for the preservation of their commonwealth, their religion, their persons, their estates, and their posterity. They begged her to weigh the equity of their petition, to consider the inconveniences of war, and to think of the rest and quiet which were necessary to relieve the afflictions of her daughter's kingdom; and they besought her to embalm her own memory, by an immortal deed of wisdom, humanity, and justice.

575  
She still behaves with insincerity.

To give authority and weight to the letter of the associated lords, the lord Grey directed Sir George Howard and Sir James Croft to wait upon the queen-dowager, and to stipulate the peaceable departure of the English troops, upon the condition that the French mercenaries were immediately dismissed from her service, and prohibited from residing in Scotland. Returning no direct answer to the applications made to her, she desired time to deliberate upon the resolution which it became her to adopt. This equivocal behaviour corre-

sponded with the spirit of intrigue which had uniformly distinguished the queen-dowager; and it is probable, that her engagements with France did not permit her to be open and explicit.

Scotland.

The combined armies marched towards Leith. A body of the French, posted upon a rising ground called *Hawk-hill*, disputed their progress. During five hours the conflict was maintained with obstinate valour. At length the Scottish horsemen charged the French with a fury which they were unable to resist. They fled to Leith with precipitation; and might have been cut off from it altogether, if the English cavalry had exerted themselves. Three hundred of the French soldiers perished in this action, and a few combatants only fell on the side of the Congregation.

576  
The French defeated by the Protestant allies,

Leith was invested. The pavilions and tents of the English and Scottish nobility were planted at Restalrig, and around it. Trenches were call; and the ordnance from the town annoying the combined armies, a mount was raised, upon which eight cannons were erected. A continued fire from these, against St Anthony's tower in South Leith, being kept up and managed with skill, the walls of this fabric were shaken, and the French found it necessary to dismount their artillery.—Negligent from security, and apprehensive of no attack, the English and Scottish officers occupied themselves in amusements, and permitted a relaxation of military discipline. The French, informed of this supineness and levity, made a sally from Leith. While some of the captains were diverting themselves at Edinburgh, and the soldiery were engaged at dice and cards, they entered the trenches unobserved, and, pushing their advantage, put 600 men to the sword. After this slaughter, the Protestants were more attentive to their affairs.—Mounts were built at proper distances, which, being fortified with ordnance, served as places of retreat and defence in the event of sudden incursions; and thus they continued the blockade in a more effectual manner.

577  
Who lay Leith.

578  
A party of them cut off.

The army under the marquis D'Elbeuf, promised so often to the queen-regent, was in vain expected by her; but she received, at this time, supplies in money and military stores; and Monlcu bishop of Valence, though defeated in dexterity by Elizabeth and her ministers, had arrived in Scotland to try anew the arts of delay and negotiation. Conferences were held by him with the queen-dowager, with the English commanders, and with the confederated nobles; but no contract or agreement could be concluded. His credentials neither extended to the demolition of Leith, nor to the recall of the French mercenaries: and though he obtained powers from his court to consent to the former of these measures, they were yet burdened with conditions which were disgraceful to the Congregation; who, in the present prosperous state of their fortunes, were not disposed to give up any of the objects for which they had struggled so long, and to the attainment of which they now looked forward with a settled hope and expectation.

579  
Fruitless negotiation with England.

Though the grave and measured orations of Monlcu could not overpower the plain and stubborn sense of the Congregation, yet as he affected to give them admonitions and warnings, and even ventured to insult them with menaces, they appear to have conceived a high indignation against him. Under this impulse, and that

<sup>Scotland.</sup> that in so advanced a stage of their affairs, they might exhibit the determined firmness of their resolutions, and bind to them by an indissoluble tie the earl of Huntley and the other persons who had joined them in consequence of the English alliance, they thought of the assurance and stability of a *new league and covenant*, more solemn, expressive, and resolute, than any which they had yet entered into and subscribed.

<sup>530</sup>  
The fourth covenant.

The nobles, barons, and inferior persons, who were parties to this bond and association, bound themselves in the presence of Almighty God, as a society, and as individuals, to advance and set forward the reformation of religion, and to procure, by every possible means, the true preaching of the gospel, with the proper administration of the sacraments, and the other ordinances in connection with it. Deeply affected, at the same time, with the misconduct of the French statesmen, who had been promoted to high offices; with the oppressions of the French mercenaries, whom the queen-dowager kept up and maintained under the colour of authority; with the tyranny of their captains; and with the manifest danger of conquest to which the country was exposed, by different fortifications upon the sea-coast, and by other dangerous innovations; they promised and engaged, generally and individually, to join with the queen of England's army, and to concur in an honest, plain, and unreserved resolution to expel all foreigners from the realm, as oppressors of public liberty; that, by recovering the ancient rights, privileges, and freedom of their nation, they might live for the future under the due obedience of their king and queen, be ruled by the laws and customs of the country, and by officers and statesmen born and educated among them. It was likewise contracted and agreed by the subscribers to this bond and covenant, that no private intelligence by writing or message, or communication of any kind, should be kept up with their adversaries; and that all persons who resisted the godly enterprise in which they were united, should be regarded as their enemies, and reduced to subjection and obedience.

<sup>582</sup>  
The queen-dowager gives herself up to despair.

When the strong and fervid sentiment and expression of this new association were communicated to the queen-dowager, she resigned herself to sorrow. Her mind, inclined to despondence by the increase of her malady, felt the more intensely the cruel distractions and disquiets into which the kingdom had been driven by the ambition of France, her own doating affection for the princes of Lorraine, and the vain prognostications of flatterers and courtiers. In the agony of passion, she besought the malediction and curse of God to alight upon all those who had counselled her to persecute the preachers, and to refuse the petitions of the most honourable portion of her subjects.

<sup>582</sup>  
The Protestants make an unsuccessful attack on Leith.

In the mean time the siege of Leith was prosecuted. But the strength of the garrison amounting to more than 4000 soldiers, the operations of the besiegers were slow and languid. An accidental fire in the town, which destroyed many houses and a great part of the public granary, afforded them an opportunity of playing their artillery with some advantage; and a few days after they made a general assault. But the scaling-ladders which were applied to the walls being too short, and Sir James Croft, who had been gained to the queen-dowager, having acted a treacherous part, the attempt

failed of success, and 1000 men were destroyed. The combined armies, however, did not lose their resolution or their hopes. The English and Scots animated the constancy of one another; and in the ratification of the treaty of Berwick, which was now made, a new source of cordiality opened itself. Letters also had come from the duke of Norfolk, promising a powerful reinforcement, giving the expectation of his taking upon him the command of the troops in person, and ordering his pavilion to be erected in the camp. Leith began to feel the misery of famine, and the French to give themselves to despair. The besiegers abounded in every thing; and the arrival of 2000 men, the expected reinforcement from England, gave them the most decisive superiority over their adversaries. Frequent sallies were made by the garrison, and they were always unsuccessful. Discouraged by defeats, depressed with the want of provisions, and languishing under the negligence of France, they were ready to submit themselves to the mercy of the Congregation.

<sup>583</sup>  
A reinforcement arrives from England.

Amidst this distress the queen-dowager, wasted with a lingering distemper and with grief, expired in the castle of Edinburgh. A few days before her death, she invited to her the duke of Chatelherault, the lord James Stuart, and the earls of Argyle, Glencairn, and Marischal, to bid them a last adieu. She expressed to her sorrow for the troubles of Scotland, and made it her earnest suit, that they would consult their constitutional liberties, by dismissing the French and English from their country; and that they would preserve a dutiful obedience to the queen their sovereign. She professed an unlimited forgiveness of all the injuries which had been done to her; and entreated their pardon for the offences she had committed against them. In token of her kindness and charity, she then embraced them by turns; and, while the tear started in her eye, presented to them a cheerful and smiling aspect. After this interview, the short portion of life which remained to her was dedicated to religion; and that she might allure the Congregation to be compassionate to her Popish subjects and her French adherents, she flattered them, by calling John Willocks, one of the most popular of their preachers, to assist and comfort her by his exhortations and prayers. He made long discourses to her about the abominations of the mass; but she appears to have died in the communion of the Romish church; and her body being transported to France, was deposited in the monastery of St Peter, at Rheims, in Champagne, where her sister Renée was an abbess.

<sup>584</sup>  
Death of the queen-regent.

The death of the queen-dowager, at a period so critical, broke altogether the spirit of the French troops. They were blocked up so completely, that it was almost impossible for any supplies to reach them either by sea or land; and France had delayed so long to fulfil its magnificent promises, that it was no longer in a capacity to take any steps towards their accomplishment. Its internal distress and disquiets were multiplying. The nobility, impoverished by wars, were courted the rewards of service, and struggling in hostility. The clergy were avaricious, ignorant, and vindictive. The populace, knowing no trade but arms, offered their swords to the factious. Francis II. the husband of Mary, was without dignity or understanding. Catharine de Medicis his mother was full of artifice and falsehood. Insurrections were dreaded in every province.

<sup>585</sup>  
The French troops submit.

Scotland. vince. The house of Guise was encompassed with difficulties, and trembling with apprehensions, so that they could not think of persisting in their views of distant conquests. It was necessary that they should abandon for a time all the proud projects they had formed for the extension of the French monarchy. It was chiefly in the exemption from foreign wars that they could hope to support their own greatness, and apply a remedy to the domestic disturbances of France.

586 Francis and Mary enter into a negotiation with Elizabeth. It appeared to Francis and Mary, that they could not treat in a direct method with the Congregation, whom they affected to consider as rebellious subjects, without derogating from their royal dignity. In negotiating a peace, they therefore addressed themselves to queen Elizabeth. It was by her offices and interference that they projected a reconciliation with the confederated lords, and that they meant to extinguish the animosities which, with so much violence, had agitated the Scottish nation. They granted their commission to John Monluc bishop of Valence, Nicholas Pelleve bishop of Amiens, Jacques de la Brosse, Henry Clentin sieur d'Oysel, and Charles de la Rochefaucault sieur de Randan; authorising them in a body, or by two of their number, to enter into accords and agreements with the queen of England. The English commissioners were Sir William Cecil principal secretary of state, Nicolas Wotton dean of Canterbury and York, Sir Ralph Sadler, Sir Henry Percy, and Sir Peter Crew; and the powers of treaty were to be exercised by them all in conjunction, or by four, three, or two of them.

587 The plenipotentiaries of France, though empowered only to treat with England, were yet, by a separate commission, entrusted to assure the Congregation, that, notwithstanding the heinous guilt incurred by them, Francis and Mary were inclined to receive them into favour, upon their repentance and return to obedience; and to abstain for ever from all inquiry into their conduct. They had full authority, at the same time, by this new deed, to hear, in conjunction with the commissioners of Elizabeth, the complaints of the Congregation, and to grant, with their consent, the relief which appeared to them to be the most proper and salutary.

The nobility and people of Scotland, choosing for their representatives the lord James Stuart, the lord Ruthven, and Maitland of Lethington, expressed their willingness to concur in reasonable measures for the re-establishment of the public union and tranquillity. By the mode of a formal petition, they enumerated their grievances, laid claim to a redress of them, and besought an uniform protection to their constitution and laws. To this petition the intercession of queen Elizabeth effected the friendly attention of Francis and Mary; and upon a foundation concerted with so much propriety, Monluc and Randan, Cecil and Wotton, the acting plenipotentiaries of England and France, drew up and authenticated the celebrated deed of relief and concession which does so much honour to the spirit, perseverance, and magnanimity of the Scottish nation.

589 Nature of their treaty with the Protestants. By this accord and agreement, Francis and Mary stipulated and consented, that no French soldiers and no foreign troops should ever be introduced into Scotland without the counsel and advice of the three estates. They concurred in the opinion, that the French mercenaries should be sent back into France, and that the

Scotland. fortifications of Leith should be demolished. They agreed that commissioners should be appointed to visit Dunbar, and to point out the works there which ought to be destroyed; and they bound and engaged themselves to build no new fortrefs or place of strength within the kingdom, and to repair no old one, without a parliamentary authority and sanction. They consented to extinguish all debts which had been contracted for the maintenance of the French and Scotch soldiery in their service. They appointed the estates of the realm to hold a parliament for the discussion of affairs of state; and they obliged themselves to consider the acts of this assembly as valid and effectual in every respect. They confirmed the ancient law of the country, which prohibited the princes of Scotland from making peace and war without the advice of the three estates. It was accorded and agreed by them, that the three estates, in concurrence with the queen, should elect a council for the administration of affairs during her majesty's absence. They became bound to employ the natives of Scotland in the management of justice both civil and criminal, in the offices of chancellor, keeper of the seals, treasurer, comptroller, and in other stations of a similar nature; and to abstain from the promotion of all foreigners to places of trust and honour, and from investing any clergyman in the charge of affairs of the revenue. They determined to establish an act of oblivion, and to forget and bury for ever the memory of all the late transactions of war and offence. It was concluded by them, that a general peace and reconciliation should take place among all parties. They expressed their determination, that no pretence should be assumed by them, from the late contentions, to deprive any of their subjects of their estates or offices. And they referred the reparation which might be proper to compensate the injuries that had been sustained by bishops and ecclesiastics, to the judgment of the three estates in parliament.

Upon the subject of the reformation, the plenipotentiaries of England and France did not choose to deliberate and decide, although articles with regard to it had been presented to them by the nobles and the people. They referred this delicate topic to the ensuing meeting of the parliament; and the leaders of the Congregation engaged, that deputies from the three estates should repair to the king and queen, to know their intention concerning matters of such high importance.

After having granted these concessions to the nobility and the people of Scotland, upon the part of their respective courts, Monluc and Randan, Cecil and Wotton, concluded another deed of treaty and agreement. By this convention it was determined, that the English and French troops should depart out of Scotland; that all warlike preparations should cease; that the fort of Eymouth should be razed to the ground, in terms of the treaty of Cambray; that Francis and Mary should abstain from bearing the title and arms of England or Ireland; that it should be considered, whether a farther compensation should be made to Elizabeth for the injuries committed against her; and that the king and queen of Scots should be fully and sincerely reconciled to the nobility and the people of their kingdom. The interests of England and France were the particular objects of this agreement. But though the concessions to the Protestants were not inserted in it at full length, an expressive

<sup>Scotland.</sup> expressive reference was made to them; and they received a confirmation in terms which could not be misunderstood or controverted. This deed recorded the clemency of Francis and Mary to their subjects of Scotland, the extreme willingness of the nobility and the people to return to their duty and allegiance, the representation they had offered of their grievances, and the request of queen Elizabeth that redress should be afforded to them; and it appealed to the consequent concessions which had been stipulated to their advantage.

By these important negotiations, the Protestants, while they humbled France, flattered queen Elizabeth; and while they acquired a power to act in the establishment of the reformation, restored its civil constitution to Scotland. The exclusion of foreigners from offices of state, the limitation of the Scottish princes with regard to peace and war, the advancement of the three estates to their ancient consequence, and the act of oblivion of all offences, were acquisitions most extensively great and useful; and, while they gave the fullest security to the reformed, gratified their most sanguine expectations.

<sup>591</sup>  
Peace proclaimed.

The peace, so fortunately concluded, was immediately proclaimed. The French mercenaries embarked for their own country, and the English army took the road to Berwick. Amidst events so joyful, the preachers exhorted the confederated nobles to command the solemnity of a thanksgiving. It was ordered accordingly; and after its celebration, the commissioners of the boroughs, with several of the nobility, and the tenants *in capite*, were appointed to choose and depute ministers to preach the gospel in the principal towns throughout the kingdom. John Knox was called to discharge the pastoral functions at Edinburgh, Christopher Goodman at St Andrew's, Adam Heriot at Aberdeen, John Row at Perth, Paul Methven at Jedburgh, William Christison at Dundee, David Ferguson at Dunfermline, and David Lindsey at Leith. That the business of the church, at the same time, might be managed with propriety, superintendants were elected to preside over the ecclesiastical affairs of particular provinces and districts. Mr John Spotswood was named the superintendant for the division of Lothian, Mr John Willocks for that of Glasgow, Mr John Winram for that of Fife, Mr John Erskine of Dun for that of Angus and Merns, and Mr John Carfwell for that of Argyle and the Isles. This inconsiderable number of ministers and superintendants gave a beginning to the reformed church of Scotland.

<sup>593</sup>  
The parliament meets.

Amidst the triumph and exultation of the Protestants, the meeting of the parliament approached. All persons who had a title from law, or from ancient custom, to attend the great council of the nation, were called to assemble there. While there was a full convention of the greater barons and the prelates, the inferior tenants *in capite*, or the lesser barons, upon an occasion so great, instead of appearing by representation, came in crowds to give personally their assistance and votes; and all the commissioners for the boroughs, without exception, presented themselves.

<sup>Scotland.</sup> It was objected to this parliament when it was assembled, that it could not be valid, since Francis and Mary were not present, and had not empowered any person to represent them. But by the terms of the late concessions to the nobility and the people, they had in effect dispensed with this formality; and the objection, after having been agitated with heat for some days, was rejected by a majority of voices. The lords of the articles were then chosen; and as the Protestant party were superior to the Popish faction, they were careful, in electing the members of this committee, to favour all those who were disposed to forward the work of the reformation. The first object which the lords of the articles held out to the parliament was the supplication of the nobility, gentry, and all the other persons who professed the new doctrines. It required, that the Romish church should be condemned and abolished. It reprobated the tenet of transubstantiation, the merit of works, papistical indulgences, purgatory, pilgrimages, and prayers to departed saints; and considering them as pestilent errors, and as fatal to salvation, it demanded, that all those who should teach and maintain them should be exposed to correction and punishment. It demanded, that a remedy should be applied against the profanation of the holy sacraments by the Roman Catholics, and that the ancient discipline of the church should be restored. In fine, it insisted, that the supremacy and authority of the pope should be abolished; and that the patrimony of the church should be employed in supporting the reformed ministry, in the provision of schools, and in the maintenance of the poor.

<sup>594</sup>  
Supplication of the Protestants.

This supplication of the Protestants was received in parliament with marks of the greatest deference and respect. The popish doctrines it censured, and the strong language it employed, excited no dispute or altercation. The nobility, however, and the lay members, did not think it expedient that the patrimony of the church, in all its extent, should be allotted to the reformed ministry, and the support of schools and the poor. Avoiding, therefore, any explicit scrutiny into this point, the parliament gave it in charge to the ministers and the leading men of the reformation, to draw up, under distinct heads, the substance and sense of those doctrines which ought to be established over the kingdom. Within four days this important business was accomplished. The writing or instrument to which the reformed committed their opinions was termed, "The Confession of Faith, professed and believed by the Protestants within the realm of Scotland (Q)." It was read first to the lords of the articles. It was then read to the parliament; and the prelates of the Romish church were commanded, in the name of God, to make publicly their objections to the doctrines it proposed. They preserved a profound silence. A new diet was appointed for concluding the transaction. The articles of the Confession were again read over in their order, and the votes of the parliament were called. Of the temporal nobility, three only refused to bestow upon it their authority. The earl of Athol, and the lords Somerville and Bothwell, protested,

<sup>595</sup>  
A Confession of Faith drawn up.

(Q) It is given at full length in Knox, in the collection of confessions of faith, vol. 2. and in the statute book, parl. 1567.

Scotland. ed, that "they would believe as their fathers had done before them." The bishops and the estate ecclesiastical, from a consciousness of the weakness of popery, seemed to have lost all power of speech. No dissent, no vote, was given by them. "It is long (said the earl Marischal), since I entertained a jealousy of the Romish faith, and an affection to the reformed doctrines. But this day has afforded me the completest conviction of the falshood of the one, and the truth of the other. The bishops, who do not conceive themselves to be deficient in learning, and whose zeal for the maintenance of the hierarchy cannot be doubted, have abandoned their religion, and their interest in it, as objects which admit of no defence or justification." All the other constituent members of this great council were zealous for the establishment of the reformation, and affirmed the propriety of its doctrines. Thus the high court of parliament, with great deliberation and solemnity, examined, voted, and ratified the confession of the reformed faith.

596  
Abolition  
of the mass.

A few days after the establishment of the Confession of Faith, the parliament passed an act against the mass and the exercise of the Romish worship. And it scrupled not to ordain, that all persons saying or hearing mass should, for the first offence, be exposed to the confiscation of their estates, and to a corporal chastisement, at the discretion of the magistrate; that for the second offence, they should be banished out of the kingdom; and that for the third offence they should incur and suffer the pains of death. This fierceness, it is to be acknowledged, did not suit the generosity of victory; and while an excuse is sought for it in the perfidiousness of the Romish priesthood, it escapes not the observation of the most superficial historians, that these feverities were exactly those of which the Protestants had complained so loudly, and with so much justice. By another ordination, the parliament, after having declared, that the pope, or bishop of Rome, had inflicted a deep wound and a humiliating injury upon the sovereignty and government of Scotland, by his frequent interferences and claims of power, commanded and decreed, that, for the future, his jurisdiction and authority should be dead and extinct; and that all persons maintaining the smallest connection with him, or with his sect, should be liable to the loss of honour and offices, proscription, and banishment.

597  
Persecuting  
spirit of the  
Protestants.

These memorable and decisive statutes produced the overthrow of the Romish religion. To obtain to these proceedings, and to its other ordinances, the approbation of Francis and Mary was an object of the greatest anxiety, and of infinite moment to the three estates. Sir James Sandilands lord St John was therefore appointed to go to France, and to express to the king and queen the affection and allegiance of their subjects, to explain what had been done in consequence of the late concessions and treaty, and to solicit their royal ratification of the transactions of the parliament. The spirited behaviour of the Congregation had, however, exceeded all the expectations of the princes of Lorraine; and the business of the embassy, and the ambassador himself, though a man of character and probity, were treated not only with ridicule, but with insult and contumely. He returned accordingly without any answer to his commission. Instead of submitting the heads

598  
Francis and  
Mary refuse  
to confirm  
the acts of  
this parlia-  
ment.

and topics of a reformation to Francis and Mary, by a petition or a narrative, the parliament had voted them into laws; and from this informality the validity of its proceedings has been suspected. But it is observable of the Protestants, that they had not concealed their views with regard to religion and the abolition of Popery; that in the grant of redress and concession, and in the deed of treaty, no actual prohibition was made to bar the establishment of the reformation; that a general authority was given to the parliament to decide in affairs of state; and that Francis and Mary were solemnly bound to authenticate its transactions. Though a formality was invaded, the spirit of the treaties was yet respected and maintained. The nation, of consequence, imputed the conduct of Francis and Mary to political reasons suggested by the princes of Lorraine, and to the artifices of the Popish clergy; and as Elizabeth did not refuse, upon her part, the ratification of the agreements, and solicited and pressed the French court in vain to adopt the same measure, a strength and force were thence communicated to this conclusion.

When the three estates dispatched Sir James Sandilands to France, they instructed the earls of Morton and Glencairn, with Maitland of Lethington, to repair to the court of England. By these ambassadors they presented to Elizabeth their sincere and respectful thanks, for the attention shown by her to Scotland, in her late most important services. And while they solicited the continuance of her favour and protection, intreated, in an earnest manner, that her majesty, for the establishment of a perpetual peace and amity, would be pleased to take in marriage the earl of Arran, the next heir after his father to the Scottish monarchy. The queen made new and fervent protestations of her regard and attachment; and gave the promise of her warmest aid when it should be necessary, in their just defence, upon any future occasion. She spoke in obliging terms of the earl of Arran; but as she found in herself no present disposition to marriage, she desired that he might consult his happiness in another alliance. She expressed a favourable opinion of the Scottish nobility; and as a demonstration of her affection and esteem, she took the liberty to remind them of the practices which had been employed to overturn their independency, and begged them to consider the unanimity and concord of their order as a necessary guard against the ambition and the artifice of the enemies of their nation.

The success of the Congregation, though great and illustrious, was not yet completely decisive. The refusal of Francis and Mary to ratify their proceedings opened a source of bitterness and inquietude. The Popish party, though humbled, was not annihilated: Under the royal protection it would soon be formidable. Political considerations might arise, not only to cool the amity of England, but even to provoke its resentment. And France, though it could now transport no army against Scotland, might soon be able to adopt that expedient. Cruel distractions and severe calamities were still to be dreaded. In the narrowness of their own resources they could find no solid and permanent security against the rage and weight of domestic faction, and the strenuous exertions of an extensive kingdom. All their fair achievements might



Scotland.

be blasted and overthrown. Popery might again build up her towers, and a sanguinary domination destroy alike their religious and civil liberties.

599  
Death of  
Francis II.

While the anguish of melancholy apprehensions pressed the triumph of the Congregation, the event which could operate most to their interests was announced to them. This event was the death of Francis II. The tie which knit Scotland to France was thus broken. A new scene of politics displays itself. Catharine de Medicis, the queen-mother, ruled Charles IX. and was the personal enemy of the queen of Scots. The power and the credit which Mary had lent to her uncles, and the frequent and humiliating disappointments which the queen-mother had suffered from her influence over Francis, were now repaid with a studied indifference and neglect. In the full perfection of her charms, with two crowns upon her head, and looking towards a third, she felt herself to be without grandeur and without consequence. Leaving a court where she had experienced all the enjoyments of which humanity is susceptible, she retired to Rheims, to indulge her sorrow.

In the humiliation of their queen, and in the change produced in the councils of France, the Protestants of Scotland found every possible encouragement to proceed with vigour in the full establishment of the reformed doctrines. After the dissolving of the parliament, they turned their thoughts and attention to the plan of policy which might suit best the tenets and religion for which they had contended. The three estates, amidst their other transactions, had granted a commission to Mr John Winram, Mr John Spottiswood, John Willocks, Mr John Douglas, Mr John Row, and John Knox, to frame and model a scheme or platform of ecclesiastical government. They were not long in complying with an order so agreeable to them, and composed what is termed the *First Book of Discipline*; in which they explained the uniformity and method which ought to be preserved concerning doctrine, the administration of the sacraments, the election and provision of ministers, and the policy of the church.

600  
Ecclesiastical govern-  
ment of  
Scotland  
re-  
newed.

A convention of the estates gave its sanction to the Presbyterian scheme of government. But while the Book of Discipline sketched out a policy beautiful for its simplicity, yet it required that the patrimony and the rich possessions of the ancient church should be allotted to the new establishment. The reformers, however, so successful in the doctrines and the policy they had proposed, were here very unfortunate. This convention of the estates did not pay a more respectful regard to this proposal than the celebrated parliament had done, which demolished the mass and the jurisdiction of the see of Rome. They affected to consider it as no better than a dream. The expression "a devout imagination" was applied to it in mockery; and it was not till after long and painful struggles, that the new establishment was able to procure to itself a becoming and necessary provision and support. The Romish clergy were strenuous to continue in their possessions, and to profit by them; and the nobles and the laity having seized upon great proportions of the property of the church, were no less anxious to retain the acquisitions they had made.

601  
The reve-  
nues of the  
ancient  
church re-  
fused to the  
reformed  
preachers.

The aversion entertained from bestowing riches upon

Vol. XVII. Part I.

the Presbyterian establishment, encouraged the ardour which prevailed for advancing all the other views and interests of the reformed. And this end was also promoted in no inconsiderable degree by the insidious policy of Catharine de Medicis. She was willing to increase and to foster all the difficulties and dangers in the situation of the queen of Scots and her subjects. Upon this account she had engaged Charles IX. to dispatch Monsieur Noailles to the Scotch parliament, to urge it in strong terms to renew the ancient league between the two kingdoms, to dissolve the alliance with England, and to re-establish over Scotland the Popish doctrines and the Popish clergy. A new meeting of the estates was assembled, which considered these strange requisitions, and treated them with the indignation they merited. Monsieur Noailles was instructed to inform his sovereign, that France having acted with cruelty and perfidiousness towards the Scots, by attacking their independency and liberties under the cover and pretence of amity and marriage, did not deserve to know them any longer as an ally; that principles of justice, a love of probity, and a high sense of gratitude, did not permit the Scottish parliament to break the confederacy with England, which had generously protected their country against the tyrannical views of the French court, and the treacherous machinations of the house of Guise; and that they were never to acknowledge the Popish clergy to be a distinct order of men, or the legal possessors of the patrimony of the church; since, having abolished the power of the pope, and renounced his doctrines, they could bestow no favour or countenance upon his vassals and servants.

Scotland.

To this council of the estates a new supplication was presented by the Protestants. They departed from the high claim which they had made for the riches and patrimony of the Popish church; and it was only requested by them, that a reasonable or decent provision should be allotted to the true preachers of the gospel. This application, however, no less than their former exorbitant demand, was treated with neglect and indifference. But amidst the anxiety manifested by the nobles and the tenants of the crown to hold the Presbyterian clergy in subjection and in poverty, they discovered the warmest zeal for the extension and continuance of the reformed opinions. For in this supplication of the Protestants, an ardent desire being intimated and urged, that all the monuments of idolatry which remained should be utterly destroyed, the fullest and most unbounded approbation was given to it. An act accordingly was passed, which commanded that every abbey-church, every cloister, and every memorial whatsoever of Popery, should be finally overthrown and demolished; and the care of this cruel, but popular employment, was committed to those persons who were most remarkable for their keenness and ardour in the work of the reformation. Its execution in the western counties was given in charge to the earls of Arran, Argyle, and Glencairn; the lord James Stuart attended to it in the more northern districts; and in the inland divisions of the country, it was intrusted to the barons in whom the Congregation had the greatest confidence. A dreadful devastation ensued. The populace, armed with authority, spread their ravages over the kingdom. It was deemed an execrable lenity to spare any fabric or place where idolatry had been exer-

602  
Final de-  
struction of  
monaste-  
ries and  
every mark  
of the Po-  
pish reli-  
gion in  
Scotland.

F

cised.

Scotland.

cised. The churches and religious houses were everywhere defaced, or pulled to the ground; and their furniture, utensils, and decorations, became the prizes and the property of the invader. Even the sepulchres of the dead were ransacked and violated. The libraries of the ecclesiastics, and the registers kept by them of their own transactions and of civil affairs, were gathered into heaps, and committed to the flames. Religious antipathy, the sanction of law, the exhortation of the clergy, the hope of spoil, and, above all, the ardour to put the last hand to the reformation, concurred to drive the rage of the people to its wildest fury; and, in the midst of havoc and calamity, the new establishment surveyed its importance and its power.

603

Mary solicited to return to her own country.

The death of Francis II. having left his queen, Mary, in a very disagreeable situation while she remained in France, it now became necessary for her to think on returning to her own country. To this she was solicited both by the Protestants and Papists; the former, that they might gain her over to their party; and the latter, hoping that, as Mary was of their own persuasion, Popery might once more be established in Scotland. For this deputation, the Protestants chose lord James Stuart, natural brother to the queen; and the Papists, John Lesly, official and vicar-general of the diocese of Aberdeen. The latter got the start of the Protestant ambassador, and thus had the opportunity of first delivering his message. He advised her strongly to beware of the lord James Stuart, whom he represented as a man of unbounded ambition, who had espoused the Protestant cause for no other reason than that he might advance himself to the highest employments in the state; nay, that he had already fixed his mind on the crown itself. For these reasons he advised that the lord James Stuart should be confined in France till the government of Scotland could be completely established. But if the queen was averse to this measure, he advised her to land in some of the northern districts of Scotland, where her friends were most numerous; in which case an army of 20,000 men would accompany her to Edinburgh, to restore the Popish religion, and to overawe her enemies. The next day the lord James Stuart waited upon her, and gave an advice very different from that of Lesly. The surest method of preventing insurrections, he said, was the establishment of the Protestant religion; that a standing army and foreign troops would certainly lose the affections of her subjects; for which reason he advised her to visit Scotland without guards and without soldiers, and he became solemnly bound to secure their obedience to her. To this advice Mary, though she distrusted its author, listened with attention; and lord James, imagining that she was prejudiced in his favour, took care to improve the favourable opportunity; by which means he obtained a promise of the earldom of Marre.

604

Her disputes with Elizabeth.

\* See Robertson's *History of Mary Queen of Scotland.*

Before Mary set out from France, she received an embassy from queen Elizabeth, pressing her to ratify the treaty of Edinburgh, in which she had taken care to get a clause inserted, that Francis and Mary should for ever abstain from assuming the title and arms of England and Ireland. But this was declined by the queen of Scotland, who, in her conference with the English ambassador, gave an eminent proof of her political abilities\*. Her refusal greatly augmented the

jealousies which already prevailed between her and Elizabeth, inasmuch that the latter refused her a safe passage through her dominions into Scotland. This was considered by Mary as a high indignity; she returned a very spirited answer, informing her rival, that she could return to her own dominions without any assistance from her, or indeed whether she would or not. In the month of August 1561, Mary set sail from Calais for Scotland. She left France with much regret; and at night ordered her couch to be brought upon deck, desiring the pilot to awaken her in the morning if the coast of France should be in view. The night proved calm, so that the queen had an opportunity once more of indulging herself with a sight of that beloved country. A favourable wind now sprung up, and a thick fog coming on, she escaped a squadron of men of war which Elizabeth had set out to intercept her; and on the 20th of the month she landed safely at Leith.

Scotland.

But though the Scots received their queen with the greatest demonstrations of joy, it was not long before an irreconcilable quarrel began to take place. The Protestant religion was now established all over the kingdom; and its professors had so far deviated from their own principles, or what ought to have been their principles, that they would grant no toleration to the opposite party, not even to the sovereign herself. In consequence of this, when the queen attempted to celebrate mass in her own chapel of Holyroodhouse, a violent mob assembled, and it was with the utmost difficulty that the lord James Stuart and some other persons of high distinction could appease the tumult. Mary attempted to allay these ferments by a proclamation, in which she promised to take the advice of the states in religious matters; and, in the mean time, declared it to be death for any person to attempt an innovation or alteration of the religion which she found generally established upon her arrival in Scotland. Against this proclamation the earl of Arran protested, and formally told the herald, the queen's proclamation should not protect her attendants and servants if they presumed to commit idolatry and to say mass. John Knox declared from the pulpit, that one mass was more terrible to him than if 10,000 armed enemies had landed in any part of the kingdom to re-establish Popery. The preachers everywhere declaimed against idolatry and the mass; keeping up, by their mistaken zeal, a spirit of discontent and sedition throughout the whole kingdom. John Knox was called before the queen to answer for the freedom of his speeches; but his unbounded boldness when there gave Mary much disquiet, as not knowing in what manner to deal with him. The freedoms, however, which were taken with the queen, could not induce her to depart from that plan of government which she had laid down in France. To the Protestants she resolved to pay the greatest attention; from among them she chose her privy-council, and heaped favours upon the lord James Stuart, who for his activity in promoting the reformation was the most popular man in the kingdom; while to her courtiers of the Roman Catholic persuasion she behaved with a distant formality.

605  
Mary lands in Scotland.

606  
Is insulted by the Protestants.

In the mean time, the difference between the two rival queens became every day greater. The queen of Scotland pressed Elizabeth to declare her the nearest

her

Scotland. heir to the crown of England, and Elizabeth pressed Mary to confirm the treaty of Edinburgh. With this the latter could not comply, as it would in fact have been renouncing for ever the title to that crown for which she was so earnestly contending. Endless negotiations were the consequence, and the hatred of Elizabeth to Mary continually increased. This year the queen of Scotland amused herself by making a circuit through part of her dominions. From Edinburgh she proceeded to Stirling; from thence to Perth, Dundee, and St Andrew's. Though received everywhere with the greatest acclamations and marks of affection, she could not but remark the rooted aversion which had universally taken place against Popery; and upon her return to Edinburgh, her attention was called to an exertion of this zeal, which may be considered as highly characteristic of the times. The magistrates of this city, after their election, enacted rules, according to custom, for the government of their borough. By one of these acts, which they published by proclamation, they commanded all monks, friars, and priests, together with all adulterers and fornicators, to depart from the town and its limits within 24 hours, under the pains of correction and punishment. Mary, justly interpreting this exertion of power to be an usurpation of the royal authority, and a violation of order, displaced the magistrates, commanded the citizens to elect others in their room, and granted by proclamation a plenary indulgence to all her subjects not convicted of any crime, to repair to and remain in her capital at their pleasure.

607

Bigotry of the magistrates of Edinburgh.

Besides these disturbances on account of religion, the kingdom was now in confusion on another account. The long continuance of civil wars had left a proneness to tumults and insurrections everywhere; and thefts, rapine, and licentiousness of every kind, threatened to subvert the foundations of civil society. Mary made considerable preparations for the suppression of these disorders, and appointed the lord James Stuart her chief justiciar and lieutenant. He was to hold two criminal courts, the one at Jedburgh, and the other at Dumfries. To assist his operations against the banditti, who were armed, and often associated into bodies, a military force was necessary; but as there were at present neither standing army nor regular troops in the kingdom, the county of Edinburgh, and ten others, were commanded to have their strength in readiness to assist him. The feudal tenants, and the allodial or free proprietors of these districts, in complete armour, and with provisions for 20 days, were appointed to be subservient to the purposes of his commission, and to obey his orders in establishing the public tranquillity. In this expedition he was attended with his usual success. He destroyed many of the strong-holds of the banditti; hanged 20 of the most notorious offenders; and ordered 50 more to be carried to Edinburgh, there to suffer the penalties of law on account of their rebellious behaviour. He entered into terms with the lord Grey and Sir John Foster, the wardens of the English borders, for the mutual benefit of the two nations; and he commanded the chiefs of the disorderly clans to submit to the queen, and to obey her orders with regard to the securing of the peace, and preventing insurrections and depredations for the future.

In the mean time the queen was in a very disagree-

able situation, being suspected and distrusted by both parties. From the concessions she had made to the Protestants, the Papists supposed that she had a design of renouncing their religion altogether; while, on the other hand, the Protestants could scarcely allow themselves to believe that they owed any allegiance to an idolater. Disquiets of another kind also now took place. The duke of Chatelherault, having left the Catholics to join the opposite party, was neglected by his sovereign. Being afraid of some danger to himself, he fortified the castle of Dumbarton, which he resolved to defend; and in case of necessity to put himself under the protection of the queen of England. — The earl of Arran was a man of very slender abilities, but of boundless ambition. The queen's beauty had made an impression on his heart, and his ambition made him fancy himself the fittest person in the kingdom for her husband. But his fanaticism, and the violence with which he had opposed the mass, disgusted her. He bore her dislike with an uneasiness that preyed upon his intellects and disordered them. It was even supposed that he had concerted a scheme to possess himself of her person by armed retainers; and the lords of her court were commanded to be in readiness to defeat any project of this sort. The earl of Bothwell was distinguished chiefly by his prodigalities and the licentiousness of his manners. The earl of Marischal had every thing that was honourable in his intentions, but was overwary and slow. The earl of Morton possessed penetration and ability, but was attached to no party or measures from any principles of rectitude: His own advantage and interests were the motives which governed him. The earl of Huntley the lord chancellor, was unquiet, variable, and vindictive: His passions, now fermenting with violence, were soon to break forth in the most dangerous practices. The earls of Glencairn and Menteith were deeply tinctured with fanaticism; and their inordinate zeal for the new opinions, not less than their poverty, recommended them to queen Elizabeth. Her ambassador Randolph, advised her to secure their service, by addressing herself to their necessities. Among courtiers of this description, it was difficult for Mary to make a selection of ministers in whom to confide. The consequence and popularity of the lord James Stuart, and of Maitland of Lethington, had early pointed them out to this distinction; and hitherto they had acted to her satisfaction. They were each of eminent capacity: but the former was suspected of aiming at the sovereignty; the latter was prone to refinement and duplicity; and both were more connected with Elizabeth than became them as the ministers and subjects of another sovereign.

Beside the policy of employing and trusting statesmen who were Protestants, and the precaution of maintaining a firm peace with England, Mary had it also at heart to enrich the crown with the revenues of the ancient church. A convention of estates was assembled to deliberate upon this measure. The bishops were alarmed with their perilous situation. It was made known to them, that the charge of the queen's household required an augmentation; and that as the rents of the church had flowed chiefly from the crown, it was expedient that a proper proportion of them should now be resumed to uphold its splendour. After long consultations, the prelates and estate ecclesiastical, consider-

Scotland.

610  
Mary distrustful by both parties.

611  
Character of her different courtiers.

612  
She obtains a part of the ecclesiastical revenues.

Scotland. ing that they existed merely by the favour of the queen, consented to resign to her the third part of their benefices, to be managed at her pleasure; with the reservation that they should be secured during their lives against all farther payments, and relieved from the burden of contributing to the maintenance of the reformed clergy. With this offer the queen and the convention of estates were satisfied. Rentals, accordingly, of all their benefices throughout the kingdom, were ordered to be produced by the ancient ecclesiastics; the reformed ministers, superintendants, elders, and deacons, were enjoined to make out registers of the grants or provisions necessary to support their establishment; and a supereminent power of judging in these matters was committed to the queen and the privy-council.

While the prelates and estate ecclesiastical submitted to this offer from the necessity of their affairs, it was by no means acceptable to the reformed clergy, who at this time were holding an assembly. It was their earnest wish to effect the entire destruction of the ancient establishment, to succeed to a large proportion of their emoluments, and to be altogether independent of the crown. But while the Protestant preachers were naturally and unanimously of these sentiments, the nobles and gentlemen who had promoted the reformation were disposed to think very differently. To give too much of the wealth of the church to the reformed clergy, was to invest them with a dangerous power. To give too great a proportion of it to the crown, was a step still more dangerous. At the same time it was equitable, that the ancient clergy should be maintained during their lives; and it consisted with the private interests of the noblemen and gentlemen, who had figured during the reformation, not to consent to any scheme that would deprive them of the spoils of which they had already possessed themselves out of the ruins of the church, or which they might still be enabled to acquire.

613  
Bad success  
of the de-  
mands of  
the Prote-  
stants.

Thus public as well as private considerations contributed to separate and divide the lay Protestants and the preachers. The general assembly, therefore, of the church, was not by any means successful in the views which had called them together at this time, and which they submitted to the convention of estates. Doubts were entertained whether the church had any title to assemble itself. The petition preferred for the complete abolition of idolatry, or for the utter prohibition of the mass, was rejected, notwithstanding all the zeal manifested by the brethren. The request that Mary should give authority to the book of discipline, was not only refused, but even treated with ridicule. The only point pressed by the church, which attracted any notice, was its requisition of a provision or a maintenance; but the measure invented for this end was in opposition to all its warmest desires.

This measure, however, so unpromising to the preachers in expectation, was found to be still more unsatisfactory upon trial. The wealth of the Romish church had been immense, but great invasions had been made upon it. The fears of the ecclesiastics, upon the overthrow of popery, induced them to engage in fraudulent transactions with their kinsmen and relations; in consequence of which many possessions were conveyed from the church into private hands. For valuable considerations, leases of church-lands, to endure for many years, or in perpetuity, were granted to strangers and adven-

Scotland. turers. Sales also of ecclesiastical property, to a great extent, had been made by the ancient incumbents; and a validity was supposed to be given to these transactions by confirmations from the pope, who was zealous to assist his votaries. Even the crown itself had contributed to make improper dispositions of the ecclesiastical revenues. Laymen had been presented to bishoprics and church-livings, with the power of disposing of the territory in connection with them. In this diffusion of the property of the church, many fair acquisitions, and much extensive domain, came to be invested in the nobles and the gentry.

From these causes, the grant of the third of their benefices, made by the ancient ecclesiastics to the queen, with the burden of maintaining the reformed clergy, was not near so considerable as might have been expected. But the direction of the scheme being lodged in the queen and the privy-council, the advantage to the crown was still greater than that bestowed upon the preachers. Yet the carrying the project into execution was not without its inconveniences. There were still many opportunities for artifice and corruption; and the full third of the ecclesiastical benefices, even after all the previous abstractions of them which had been made, could not be levied by any diligence. For the ecclesiastics often produced false rentals of their benefices; and the collectors for the crown were not always faithful to the trust reposed in them. The complete produce of the thirds did not amount to a great sum; and it was to operate to the expences of the queen, as well as to the support of the preachers. A scanty proportion went to the latter; and yet the persons who were chosen to fix and ascertain their particular stipends or provisions were the last friends of the reformation. For this business was committed in charge to the earls of Argyle and Morton, the lord James Stuart, and Maitland of Lethington, with James Mackgill the clerk-register, and Sir John Ballenden the justice-clerk. One hundred Scottish merks were deemed sufficient for a common minister. To the clergymen of greater interest or consideration, or who exercised their functions in more extensive parishes, 300 merks were allotted; and, excepting to superintendants, this sum was seldom exceeded. To the earl of Argyle, to the lord James Stuart, to Lord Erskine, who had large ecclesiastical revenues, their thirds were usually remitted by the queen; and upon the establishment of this fund or revenue, she also granted many pensions to persons about her court and of her household.

The complaints of the preachers were made with little decency, and did not contribute to better their condition. The coldness of the Protestant laity, and the humanity shown to the ancient clergy, were deep wounds both to their pride and to their interests. To a mean spirit of flattery to the reigning power, they imputed the defection of their friends; and against the queen they were animated with the bitterest animosity. The poverty in which they were suffered to remain inflamed all their passions. They industriously sought to indulge their rancour and turbulence; and inveterate habits of insult fortified them into a contempt of authority.

To the queen, whose temper was warm, the rudeness of the preachers was a painful and endless inquietude, which, while it fostered her religious prejudices, had the good effect to confirm her constancy to her friends,

and

614  
Provision  
made for  
the Prote-  
stant  
preachers.

615  
The whole  
party dis-  
satisfied.

and to keep alive her gratitude for their activity. The lord James Stuart, who was intitled to her respect and esteem from his abilities, and his proximity to her in blood, had merited rewards and honours by his public services and the vigour of his counsels. After his successful discharge of her commission as chief justiciar and lord lieutenant, she could not think of allowing him to descend from these offices, without bestowing upon him a solid and permanent mark of her favour. She advanced him into the rank of her nobility, by conferring upon him the earldom of Marre. At the same time she contributed to augment his consequence, by facilitating his marriage with Agnes the daughter of the earl of Marischal; and the ceremonial of this alliance was celebrated with a magnificence and ostentation so extravagant in that age, as to excite the fears of the preachers lest some avenging judgment or calamity should afflict the land. They exclaimed with violence against his riotous feasting and banquets; and the masquerades which were exhibited upon this occasion, attracting in a still greater degree their attention, as being a species of entertainment hitherto unknown in Scotland, and which was favourable to the profaneness of gallantry, they pointed against them the keenest strokes of their censure and indignation.

The abilities of the earl of Marre, the ascendancy he maintained in the councils or his sovereign, and the distinctions which he had acquired, did not fail to expose him to uncommon envy. The most desperate of his enemies, and the most formidable, was the earl of Huntley. In their rivalry for power, many causes of disgust had arisen. The one was at the head of the Protestants, the other was the leader of the Papists. Upon the death of Francis II. Huntley and the Popish faction had sent a deputation to Mary, inviting her to return to Scotland, and offering to support her with an army of 20,000 men. His advances were treated with attention and civility, but his offer was rejected. The invitation of the Protestants, presented by the earl of Marre, was more acceptable to her. Huntley had advised her to detain his rival in confinement in France till the Roman Catholic religion should be re-established in Scotland. This advice he not only disregarded, but cherished his enemy with particular civilities. Upon her arrival in her own country, Huntley renewed his advances, offering to her to set up the mass in all the northern counties. He even conversed in a pressing manner upon this subject with her uncles and the French courtiers who attended her. Still no real attention was paid to him. He came to her palace, and was received only with respect. He was lord high chancellor without influence, and a privy counsellor without trust. The earl of Marre had the confidence of his sovereign, and was drawing to him the authority of government. These were cruel mortifications to a man of high rank, inordinate ambition, immense wealth, and who commanded numerous and warlike retainers. But he was yet to feel a stroke still more severely exercising, and far more destructive of his consequence. The opulent estate of Marre, which Mary had erected into an earldom, and conferred upon his rival, had been lodged in his family for some time. He considered it as his property, and that it was never to be torn from his house. This blow was at once to insult most sensibly his pride, and to cut most fatally the sinews of his greatness.

After employing against the earl of Marre those arts of detraction and calumny which are so common in courts, he drew up and subscribed a formal memorial, in which he accused him of aiming at the sovereignty of Scotland. This paper he presented to the queen; but the arguments with which he supported his charge being weak and inconclusive, she was the more confirmed in her attachment to her minister. Huntley then addressing himself to the earl of Bothwell, a man disposed to desperate courses, engaged him to attempt to involve the earl of Marre and the house of Hamilton in open and violent contention. Bothwell represented to Marre the enmity which had long subsisted between him and the house of Hamilton. It was an obstacle to his greatness; and while its destruction might raise him to the highest pinnacle of power, it would be most acceptable to the queen, who, beside the hatred which princes naturally entertain to their successors, was animated by particular causes of offence against the duke of Chatelherault and the earl of Arran. He concluded his exhortation with making an unlimited offer of his most strenuous services in the execution of this flagitious enterprise. The earl of Marre, however, abhorring the baseness of the project, suspicious of the sincerity of the proposer, or satisfied that his eminence did not require the aid of such arts, rejected all his advances. Bothwell, disappointed upon one side, turned himself to the other. He practised with the house of Hamilton to assassinate the earl of Marre, whom they considered as their greatest enemy. The business, he said, might be performed with ease and expedition. The queen was in use to hunt the deer in the park of Falkland; and there the earl of Marre, unsuspecting any danger, and slenderly attended, might be overpowered and put to death. The person of the queen, at the same time, might be seized; and by detaining her in custody, a sanction and security might be given to their crime. The integrity of the earl of Arran revolting against this conspiracy, defeated its purposes. Dreading the perpetration of so cruel an action, and yet sensible of the resolute determination of his friends, he wrote privately to the earl of Marre, informing him of his danger. But the return of Marre to his letter, thanking him for his intelligence, being intercepted by the conspirators, Arran was confined by them under a guard in Kenneil-house. He effected notwithstanding his escape, and made a full discovery of the plot to the queen. Yet in a matter so dark he could produce no witnesses and no written vouchers to confirm his accusations. He therefore, according to the fashion of the times, offered to prove his information, by engaging Bothwell in single combat. And though, in his examinations before the privy council, his love to the queen, his attachment to the earl of Marre, the atrocity of the scheme he revealed, and, above all, his duty and concern for his father the duke of Chatelherault, threw him into a perturbation of mind which expressed itself violently in his speech, his countenance, and his actions; yet his declarations, in general, were so consistent and firm, that it was thought advisable to take the command of the castle of Dumbarton from the duke of Chatelherault, to confine the other conspirators to different prisons, and to wait the farther discoveries which might be made by accident and time.

Scotland.  
619  
He accuses the lord James Stuart of treason.

620  
And attempts to assassinate him.

621  
But fails in his attempt.

Scotland.

The earl of Huntley, inflamed by these disappointments, invented other devices. He excited a tumult while the queen and the earl of Marre were at St Andrew's with only a few attendants; imagining that the latter would fall forth to quell the insurgents, and that a convenient opportunity would thus be afforded for putting him to the sword without detection. The caution, however, of the earl of Marre, defeating this purpose, he ordered some of his retainers to attack him in the evening when he should leave the queen; but these assassins being surpris'd in their station, Huntley affected to excuse their being in arms in a suspicious place and at a late hour, by frivolous apologies, which, though admitted, could not be approved.

About this period, too, letters were received by Mary from the pope and the cardinal of Lorraine, in consequence of the intrigues of the earl of Huntley and the Roman Catholic faction. They press'd her to consider, that while this nobleman was the most powerful of her subjects, he was by far the most zealous in the interests of the church of Rome. They intreated her to flatter him with the hope of her marriage with Sir John Gordon his second son; held out to her magnificent promises of money and military supplies, if she would set herself seriously to recover to power and splendour the ancient religion of her country; and recommended it to her to take measures to destroy the more strenuous Protestants about her court, of whom a roll was transmitted to her, which included the name of her confident and minister the earl of Marre. These letters could not have reached her at a juncture more unfavourable for their success. The earl of Marre, to whom she communicated them, was encouraged to proceed with the greatest vigour in undermining the designs and the importance of his enemies.

New incidents exasperated the animosities of the enemies of the earl of Marre and his own. Sir John Gordon and the lord Ogilvie having a private dispute, happened to meet each other in the high street of Edinburgh. They immediately drew their swords; and the lord Ogilvie receiving a very dangerous wound, Sir John Gordon was committed to prison by the magistrates. The queen, at this time in Stirling, was informed by them of the riot; and while they expressed a fear lest the friends of the prisoner should rise up in arms to give him his liberty, they mentioned a suspicion which prevailed, that the partizans of the lord Ogilvie were to assemble themselves to vindicate his quarrel. The queen, in her reply, after commending their diligence, instructed them to continue to have a watch over their prisoner; made known her desire that the law should take its course; and counselled them to have no apprehensions of the kindred of the parties at variance, but to rely upon the earl of Marre for providing a sufficient force for their protection. Sir John Gordon, however, found the means to break from his confinement; and flying into Aberdeenshire, filled the retainers of his family with his complaints, and added to the disquiets of his father the earl of Huntley.

The queen, upon returning to Edinburgh, held a consultation upon affairs of state with her privy council; and soon after set out upon a progress to the northern parts of her kingdom. At Aberdeen she was met by the lady Huntley, a woman of deep dissi-

mulation and of refined address; who endeavoured to conciliate her affections, was prodigal of flattery, expressed her zeal for the Popish religion, and let fall insinuations of the great power of her husband. She then interceded with the queen for forgiveness to her son: and begged with a keen importunity, that he might be permitted to have the honour to kiss her hand. But Mary having told her, that the favour she had solicited could not possibly be granted till her son should return to the prison from which he had escaped, and submit to the justice of his country, the lady Huntley engaged that he should enter again into custody, and only intreated, that, instead of being confined at Edinburgh, he should be conducted to the castle of Stirling. This request was complied with; and in the prosecution of the business, a court of judicary being called, Sir John Gordon made his appearance, and acknowledged himself to be the queen's prisoner. The lord Glamis was appointed to conduct him to the castle of Stirling. But upon the road to this fortress, he deceived the vigilance of his guards, hastened back, and gathering 1000 horsemen among his retainers, entrusted his security to the sword.

In the mean time, the queen continued her progress. The earl of Huntley joined himself to her train. His anxiety to induce her to allow him to attend her to his house of Strathbogy was uncommon; his intreaties were even pressed beyond the bounds of propriety. The intelligence arrived of the escape and rebellion of Sir John Gordon. The behaviour of the father and the son awakened in her the most alarming suspicions. Assembling her privy-council, who, according to the fashion of those times, constituted her court, and attended her person in her progresses though her dominions; she, with their advice, commanded her heralds to charge Sir John Gordon and his adherents to return to their allegiance, and to surrender up to her their houses of strength and castles, under the pains of high treason and forfeiture. Disdaining now to go to the house of the earl of Huntley, where, as it afterwards appeared, that nobleman had made secret preparations to hold her in captivity, she advanced to Inverness by a different rout. In the castle of Inverness she proposed to take up her residence; but Alexander Gordon the deputy governor, a dependent of the family of Huntley, refused to admit her. She was terrified with the prospect of a certain and imminent danger. Her attendants were few in number, the town was without walls, and the inhabitants were suspected. In this extremity, some ships in the river were kept in readiness as a last refuge; and she issued a proclamation, commanding all her loyal subjects in those parts immediately to repair to her for her protection. The Frasers and Monroes came in crowds to make her the offer of their swords. The Clan Chattan, though called to arms by the earl of Huntley, forsook his standard for that of their sovereign, when they discovered that his intentions were hostile to her. She employed this strength in laying siege to the castle, which surrendered itself upon the first assault. The lives of the common soldiers were spared, but the deputy-governor was instantly executed. The queen, full of apprehensions, returned to Aberdeen.

To intimidate the earl of Huntley, to punish the troubles which his family had created to the queen, and to convince him that his utter ruin was at hand,

. a mea-

624  
And at-  
tempts to  
raise a re-  
bellion.622  
Sir John  
Gordon  
wounds  
lord Ogil-  
vie, and is  
apprehend-  
ed;623  
But escapes  
from pri-  
son,

Scotland. a measure infinitely humiliating was now concerted and put in practice. The earl of Marre resigned the rich estate of that name to the lord Erskine, who laid claim to it as his right; and received in recompense, after its erection into an earldom, the territory of Murray, which made an extensive portion of the possessions of the earl of Huntley.

The lady Huntley hastened to Aberdeen to throw herself at the feet of her sovereign, to make the offer of the most humble submissions on the part of her husband, and to avert by every possible means the downfall of his greatness. But all access to the queen was refused to her; and the earl of Huntley was summoned to appear in person before the privy council, to answer for his conduct, and to make a full resignation of all his castles and fortresses. He did not present himself, and was declared to be in open rebellion. A new proclamation was circulated by the queen to collect together a sufficient strength to subdue the insurgents. The command of her troops was given to the earl of Murray, who put them instantly into motion. Huntley advancing towards Aberdeen to give them battle, was informed of their approach. He halted at Corrichie, solacing himself with the hope of a decisive victory. The army of the queen was the most numerous; but there were several companies in it in whom little confidence could be placed. These the earl of Murray posted in the front of the battle, and commanded them to begin the attack. They recoiled upon him in disorder, according to his expectation; but a resolute band in whom he trusted, holding out their spears, obliged them to take a different course. Their confusion and flight made Huntley conceive that the day was his own. He therefore ordered his soldiers to throw aside their lances, and to rush upon the enemy sword in hand. His command was obeyed, but with no precaution or discipline. When his men came to the place where the earl of Murray had stationed himself, the points of the extended spears of his firm battalion put a termination to their progress. The panic communicated by this unexpected resistance was improved by the vigour with which he pressed the assailants. In their turn they took to flight. The companies of the queen's army which had given way in the beginning of the conflict were now disposed to atone for their misconduct; and taking a share in the battle, committed a signal slaughter upon the retainers of the earl of Huntley. This nobleman himself expired in the throng of the pursuit. His sons Sir John Gordon and Adam Gordon were made prisoners, with the principal gentlemen who had assisted him.

Mary, upon receiving the tidings of this success, discovered neither joy nor sorrow. The passions, however, of the earl of Murray and his party were not yet completely gratified. Sir John Gordon was brought immediately to trial, confessed his guilt, and was condemned to suffer as a traitor. The sentence accordingly was executed, amidst a multitude of spectators, whose feelings were deeply affected, while they considered his immature death, the manliness of his spirit, and the vigour of his form. Adam Gordon, upon account of his tender age, was pardoned; and fines were levied from the other captives of condition according to their wealth. The lord Gordon, after the battle of Corrichie, fled to his father-in-law the duke of Chatel-

herault, and put himself under his protection; but was delivered up by that nobleman, all whose endeavours in his favour were ineffectual. He was convicted of treason, and condemned; but the queen was satisfied with confining him in prison. The dead body of the earl of Huntley was carried to Edinburgh, and kept without burial, till a charge of high treason was preferred against him before the three estates. An ostentatious display was made of his criminal enterprises, and a verdict of parliament pronounced his guilt. His estates, hereditary and moveable, were forfeited; his dignity, name, and memory, were pronounced to be extinct; his ensigns armorial were torn from the book of arms; and his posterity were rendered unable to enjoy any offices, honour, or rank, within the realm.

While these scenes were transacting, Mary, who was sincerely solicitous to establish a secure amity between the two kingdoms, opened a negotiation to effectuate an interview with Elizabeth. Secretary Maitland, whom she employed in this business, met with a most gracious reception at the court of London. The city of York was appointed as the place where the two queens should express their mutual love and affection, and bind themselves to each other in an indissoluble union; the day of their meeting was fixed; the fashion and articles of their interview were adjusted; and a safe-conduct into England was granted to the queen of Scots by Elizabeth. But in this advanced state of the treaty it was unexpectedly interrupted. The disturbances in France, the persecution of the Protestants there, and the dangerous consequence which threatened the reformed countries, seemed to require Elizabeth to be particularly upon her guard, and to watch with eagerness against the machinations of the adversaries of her religion. Upon these pretences she declined for a season the projected interview; sending to Mary with this apology Sir Henry Sidney, a minister of ability, whom she instructed to dive into the secret views of the Scottish queen. This was a severe disappointment to Mary; but it is reasonable to believe, that Elizabeth acted in the negotiation without sincerity, and upon principles of policy. It was not her interest to admit into her kingdom a queen who had pretensions to her crown, and who might strengthen them; who might raise the expectations of her Roman Catholic subjects, and advance herself in their esteem; and who far surpassed her in beauty, and in the bewitching allurements of conversation and behaviour.

Amidst affairs of great moment, a matter of smaller consequence, but which is interesting in its circumstances, deserves to be recorded. Chatelard, a gentleman of family in Dauphiny, and a relation of the chevalier de Bayard, had been introduced to queen Mary by the sieur Damville, the heir of the house of Montmorency. Polished manners, vivacity, attention to please, the talent of making verses, and an agreeable figure, were recommendations to this man. In the court they drew attention to him. He made himself necessary in all parties of pleasure at the palace. His assiduities drew to him the notice of the queen; and, at different times, she did him the honour to dance with him. His complaisance became gradually more familiar. He entertained her with his wit and good-humour; he made verses upon her beauty and accomplishments; and her politeness and condescension insinuated

Scotland.

626

An interview proposed between Mary and Elizabeth, but in vain.

627

Chatelard falls in love with the queen.

Scotland. into him other sentiments than gratitude and reverence. He could not behold her charms without feeling their power: and instead of rising in its birth the most dangerous of all the passions, he encouraged its growth. In an unhappy moment, he entered her apartment; and, concealing himself under her bed, waited the approach of night. While the queen was undressing, her maids discovered his situation, and gave her the alarm. Chatelard was dismissed with disgrace; but soon after received her pardon. The frenzy, however, of his love compelling him to repeat his crime, it was no longer proper to show any compassion to him. The delicate situation of Mary, the noise of these adventures, which had gone abroad, and the rude suspicions of her subjects, required that he should be tried for his offences and punished. This imprudent man was accordingly condemned to lose his head; and the sentence was put in execution.

628  
Mary put to death.

629  
Mary inclines to a second marriage, and is addressed by a number of suitors.

The disagreeable circumstances in which Mary found herself involved by reason of her quarrel with Elizabeth, the excessive bigotry and overbearing spirit of her Protestant subjects, together with the adventure of Chatelard, and the calumnies propagated in consequence of it, determined her to think of a second marriage. Her beauty and expectations of the crown of England, joined to the kingdom which she already possessed, brought her many suitors. She was addressed by the king of Sweden, the king of Navarre, the prince of Condé, the duke of Ferrara, Don Carlos of Spain, the arch-duke Charles of Austria, and the duke of Anjou. Her own inclination was to give the preference, among these illustrious lovers, to the prince of Spain; but her determination, from the first moment, was to make her wishes bend to other considerations, and to render her decision upon this important point as agreeable as possible to queen Elizabeth, to the English nation, and to the Protestants in both kingdoms. Her succession to the crown of England was the object nearest her heart; and Elizabeth, who wished to prevent her from marrying altogether, contrived to impress upon her mind an opinion that any foreign alliance would greatly obstruct that much desired event. She therefore pitched upon two of her own subjects, whom she successively recommended as fit matches for the queen of Scots; and she promised, that upon her acceptance of either of them, her right of inheritance should be inquired into and declared. Lord Robert Dudley, afterwards earl of Leicester, was the first person proposed; and except a manly face and fine figure he had not one quality that could recommend him to the Scottish princess. Whilst Mary received this suitor with some degree of composure, she did not altogether repress her scorn. "She had heard good accounts (she owned) of the gentleman; but as queen Elizabeth had said, that in proposing a husband to her, she would consult her honour, she asked what honour there could be in marrying a subject?" The English queen then brought under the eye of Mary another suitor, lest her thoughts should return to a foreign alliance. This was lord Darnley, of the house of Stuart itself, whose birth was almost equal to her own, and whom the Scottish princess was induced to accept as a husband by motives which we have detailed elsewhere. (see MARY.) Elizabeth however was not more sincere in this proposal than in the former; for after permitting Darnley and his father the earl of Lenox to visit

630  
She makes choice of lord Darnley.

Scotland merely with the view of diverting the attention of the Queen from the continent, she threw every obstacle in the way of the marriage which art and violence could contrive. When she found Mary so much entangled, that she could hardly draw back, or make any other choice than that of Darnley, Elizabeth attempted to prevent her from going farther on; and now intimated her disapprobation of that marriage, which she herself had not only originally planned, but, in these latter stages, had forwarded by every means in her power. The whole council of Elizabeth declared against the marriage. Even from her own subjects Mary met with considerable opposition. An inveterate enmity had taken place between the duke of Chatelherault and the earl of Lenox, in consequence of which the former deserted the court, and very few of the Hamiltons repaired to it. The lord James Stuart, now earl of Murray, sought to promote the match with lord Dudley. In consequence of this he was treated openly with disrespect by the earl of Lenox; he lost the favour of his sovereign, and Darnley threatened him with his vengeance when he should be married to the queen. John Knox in the mean time behaved in the most furious manner, forgetting not only the meek and peaceable behaviour of a Christian, but the allegiance of a subject. This preacher even interfered with the marriage of his sovereign. He warned the nobility, that if they allowed a Papist or an infidel to obtain her person and the government of Scotland, they would be guilty, to the full extent of their power, of banishing Jesus Christ from the kingdom, of bringing down upon it the vengeance of God, of being a curse to themselves, and of depriving their queen of all comfort and consolation. As Darnley was a Papist, he was of consequence execrated by the whole body of Protestants, laity as well as clergy; while, on the other hand, he was supported by the ears of Athol and Caithness, the lords Ruthven and Hume, and the whole Popish faction.

631  
Extrava-gant behaviour of John Knox

It was exceedingly unfortunate for the queen, that neither lord Darnley himself, nor his father the earl of Lenox, had any talents for business; and as they naturally had the direction of the queen's affairs, it is no wonder that they were very ill managed. But a source of opposition, more violent than any imperfections of their own, rose up to them in the attachment which they discovered to a person upon whom the queen had of late bestowed her favour with an imprudent prodigality. David Rizzio from a mean origin raised himself to a distinguished eminence. He was born at Turin, where his father earned a subsistence as a musician. Varieties of situation and adventure, poverty, and misfortunes, had taught him experience. In the train of the count de Morette, the ambassador from the duke of Savoy, he had arrived in Scotland. The queen, desirous to complete her band of music, admitted him into her service. In this humble station he had the dexterity to attract her attention; and her French secretary falling into disgrace, from negligence and incapacity, he was promoted to discharge the duties of his office. A necessary and frequent admission to her company afforded him now the fullest opportunity to recommend himself to her; and while she approved his manners, she was sensible of his fidelity and his talents. His mind, however, was not sufficiently vigorous to bear with success and prosperity. Ambition grew upon him with preferment. He

632  
Account of David Rizzio.



interfered in affairs of moment, intruded himself into the conventions of the nobles at the palace, and was candidate for greatness. The queen consulted with him upon the most difficult and important business, and intrusted him with real power. The suppleness, servility, and unbounded complaisance which had characterised his former condition, were exchanged for insolence, ostentation, and pride. He exceeded the most potent barons in the stateliness of his demeanour, the sumptuousness of his apparel, and the splendour of his retinue. The nobles, while they despised the lowness of his birth, and detested him as a foreigner, and a favourite, were mortified with his grandeur, and insulted with his arrogance. Their anger and abhorrence were driven into fury; and while this undeserving minion, to uphold his power, courted Darnley, and with officious assiduities advanced his suit with the queen, he hastened not only his own ruin, but laid the foundation of cruel outrages and of public calamity.

<sup>633</sup> The earl of Murray lies the queen's favour. To the earl of Murray the exaltation of Rizzio, so offensive in general to the nation, was humiliating in a more particular degree. His interference for the earl of Leicester, the partiality he entertained for Elizabeth, his connections with secretary Cecil, and the favour he had shown to Knox, had all contributed to create in Mary a suspicion of his integrity. The practices of Darnley and Rizzio were thence the more effectual; and the fullest weight of their influence was employed to undermine his power. His passions and disgusts were violent; and in his mind he meditated revenge. Mary, aware of her critical situation, was solicitous to add to her strength. Bothwell, who had been imprisoned for conspiring against the life of the earl of Murray, and who had escaped from confinement, was recalled from France; the earl of Sutherland, an exile in Flanders, was invited home to receive his pardon; and George Gordon, the son of the earl of Huntley, was admitted to favour, and was soon to be reinstated in the wealth and honours of his family.

As soon as Bothwell arrived, the earl of Murray insisted that he should be brought to a trial for having plotted against his life, and for having broke from the place of his confinement. This was agreed to; and on the day of trial Murray made his appearance with 800 of his adherents. Bothwell did not chuse to contend with such a formidable enemy; he therefore fled to France, and a protestation was made, importing that his fear of violence had been the cause of his flight. The queen commanded the judge not to pronounce sentence. Murray complained loudly of her partiality, and engaged deeper and deeper in cabals with queen Elizabeth. Darnley, in the mean time, pressed his suit with eagerness. The queen used her utmost endeavours to cause Murray subscribe a paper expressing a consent to her marriage; but all was to no purpose. However, many of the nobility did subscribe this paper; and she ventured to summon a convention of the estates at Stirling, to whom she opened the business of the marriage; and who approved of her choice, provided the Protestant religion should continue to be the establishment.

In the mean time ambassadors arrived from England, with a message importing Elizabeth's entire disapprobation and disallowance of the queen's marriage with lord Darnley. But to these ambassadors Mary only

replied, that matters were gone too far to be recalled; and that Elizabeth had no solid cause of displeasure, since, by her advice, she had fixed her affections not upon a foreigner, but upon an Englishman; and since the person she favoured was descended of a distinguished lineage, and could boast of having in his veins the royal blood of both kingdoms. Immediately after this audience she created lord Darnley a lord and a knight. The oath of knighthood was administered to him. He was made a baron and a banneret, and called *lord Armonaygh*. He was belted earl of Ross. He then promoted 14 gentlemen to the honour of knighthood, and did homage to the queen, without any reservation of duty to the crown of England, where his family had for a long time resided. His advancement to be duke of Albany was delayed for a little time; and this was so much resented by him, that, when informed of it by the lord Ruthven, he threatened to stab that nobleman with his dagger.

In the mean time the day appointed for the assembly of parliament, which was finally to determine the subject of the marriage, was now approaching. The earl of Murray, encouraged by the apparent firmness of Elizabeth, goaded on by ambition, and alarmed with the approbation bestowed by the convention of the estates on the queen's choice of lord Darnley, perceived that the moment was at hand when a decisive blow should be struck. To inspirit the resentments of his friends, and to justify in some measure the violence of his projects, he affected to be under apprehensions of being assassinated by the lord Darnley. His fears were founded abroad; and he avoided to go to Perth, where he affirmed that the plot against him was to be carried into execution. He courted the enemies of Darnley with unceasing assiduity; and he united to him in a confederacy the duke of Chatellerault, and the earls of Argyle, Rothes, and Glencairn. It was not the sole object of their association to oppose the marriage. They engaged in more criminal enterprises. They meditated the death of the earl of Lenox and the lord Darnley; and while the queen was upon the road to Calder place to visit the lord Livingston, they proposed to intercept her and to hold her in captivity. In this state of her humiliation, Murray was to advance himself into the government of the kingdom, under the character of its regent. But Mary having received intelligence of their conspiracy, the earl of Athol and the lord Ruthven raised suddenly 300 men to protect her in her journey. Defeated in this scheme, the earl of Murray and his associates did not relinquish their cabals. They thought of new achievements; and the nation was filled with alarms, suspicions, and terror.

Amidst the arts employed by the Scottish malecontents to inflame the animosities of the nation, they forgot not to insist upon the dangers which threatened the Protestant religion from the advancement of lord Darnley, and from the rupture that must ensue with England. Letters were everywhere dispersed among the faithful, reminding them of what the eternal God had wrought for them in the abolition of idolatry, and admonishing them to oppose the restoration of the mass. A supplication was presented to the queen, complaining of idolaters, and insisting upon their punishment. In the present juncture of affairs it was received with unusual respect; and Mary instructed the Popish ecclesiastics to

Scotland.

<sup>634</sup> An association against the queen and Darnley.

<sup>635</sup> Disturbances raised by the Protestants.

Scotland.

abstain from giving offence of any kind to the Protestants. A priest, however, having celebrated the mass, was taken by the brethren, and exposed to the insults and fury of the populace at the market-place of Edinburgh, in the garments of his profession, and with the chalice in his hand; and the queen having given a check to this tumultuous proceeding, the Protestants, rising in their wrath, were the more confirmed in the belief that she meant to overthrow their religion. The most learned and able of the clergy held frequent consultations together; and while the nation was disturbed with dangerous ferments, the general assembly was called to deliberate upon the affairs of the church. Their hope of success being proportioned to the difficulties in the situation of the queen, they were the less scrupulous in forming their resolutions; and the commissioners, whom they deputed to her, were ordered to demand a parliamentary ratification of their desires.

636  
Their demands.

They insisted, that the mass, with every remain whatsoever of popery, should be universally suppressed throughout the kingdom; that in this reformation, the queen's person and household should be included; and that all Papists and idolaters should be punished upon conviction according to the laws. They contended, that persons of every description and degree should resort to the churches upon Sunday, to join in prayers, and to attend to exhortations and sermons; that an independent provision should be assigned for the support of the present clergy, and for their successors; that all vacant benefices should be conferred upon persons found to be qualified for the ministry, upon the trial and examination of the superintendants; that no bishopric, abbey, priory, deanery, or other living, having many churches, should be bestowed upon a single person; but that, the plurality of the foundation being dissolved, each church should be provided with a minister; that the glebes and manors should be allotted for the residence of the ministers, and for the reparation of churches; that no charge in schools or universities, and no care of education, either public or private, should be intrusted to any person who was not found able in doctrine, and who was not approved by the superintendants; that all lands which of old had been devoted to hospitality, should again be made subservient to it; that the lands and rents which formerly belonged to the monks of every order, with the annuities, alterages, obits, and the other emoluments which had appertained to priests, should be employed in the maintenance of the poor and the upholding of schools; that all horrible crimes, such as idolatry, blasphemy, breaking of the sabbath, witchcraft, sorcery, incantment, adultery, manifest whoredom, the keeping of brothels, murder, and oppression, should be punished with severity; that judges should be appointed in every district, with powers to pronounce sentences and to execute them; and, in fine, that for the ease of the labouring husbandmen, some order should be devised concerning a reasonable payment of the tythes.

637  
Moderation of the queen.

To these requisitions, the queen made an answer full of moderation and humanity. She was ready to agree with the three estates in establishing the reformed religion over the subjects of Scotland; and she was steadily resolved not to throw into hazard the life, the peace, or the fortune, of any person whatsoever upon account of his opinions. As to herself and her household, she was

persuaded that her people would not urge her to adopt tenets in contradiction to her own conscience, and thereby involve her in remorse and uneasiness. She had been nourished and brought up in the Romish faith; she conceived it to be founded on the word of God; and she was desirous to continue in it. But, setting aside her belief and religious duty, she ventured to assure them, that she was convinced from political reasons, that it was her interest to maintain herself firm in the Roman Catholic persuasion. By departing from it, she would forfeit the amity of the king of France, and that of other princes who were now strongly attached to her; and their disaffection could not be repaired or compensated by any new alliance. To her subjects she left the fullest liberty of conscience; and they could not surely refuse to their sovereign the same right and indulgence. With regard to the patronage of benefices, it was a prerogative and property which it would ill become her to violate. Her necessities, and the charge of her royal dignity, required her to retain in her hands the patrimony of the crown. After the purposes, however, of her station, and the exigencies of government, were satisfied, she could not object to a special assignment of revenue for the maintenance of the ministry; and, on the subject of the other articles which had been submitted to her, she was willing to be directed by the three estates of the kingdom, and to concur in the resolutions which should appear to them the most reasonable and expedient.

The clergy, in a new assembly or convention, expressed a high displeasure with this return to their address. They took the liberty to inform the queen, that the doctrines of the reformation which she refused to adopt, were the religion which had been revealed by Jesus Christ, and taught by the apostles. Popery was of all persuasions the least alluring, and had the fewest recommendations. In antiquity, consent of people, authority of princes, and number of proselytes, it was plainly inferior to Judaism. It did not even rest upon a foundation so solid as the doctrines of the alcoran. They required her, therefore, in the name of the eternal God, to embrace the means of attaining the truth, which were offered to her in the preaching of the word, or by the appointment of public disputations between them and their adversaries. The terrors of the mass were placed before her in all their deformity. The sayer of it, the action itself, and the opinions expressed in it, were all pronounced to be equally abominable. To hear the mass, or to gaze upon it, was to commit the complicated crimes of sacrilege, blasphemy, and idolatry. Her delicacy in not renouncing her opinions from the apprehension of offending the king of France and her other allies, they ridiculed as impertinent in the highest degree. They told her, that the true religion of Christ was the only means by which any confederacy could endure; and that it was far more precious than the alliance of any potentate whatsoever, as it would bring to her the friendship of the King of kings. As to patronages, being a portion of her patrimony, they intended not to defraud her of her rights: but it was their judgment, that the superintendants ought to make a trial of the qualifications of candidates for the ministry; and as it was the duty of the patron to present a person to the benefice, it was the business of the church to manage his institution or collation. For without this

Scotland.

638  
The Protestants are displeased with her answer.

restraint.

Scotland. restraint, there would be no security for the fitness of the incumbent; and if no trials or examinations of ministers took place, the church would be filled with mischief and ignorance. Nor was it right or just that her majesty should retain to herself any part of the revenue of benefices; as it ought to be all employed to the uses of the clergy, for the purposes of education, and for the support of the poor. And as to her opinion, that a suitable assignment should be made for them, they could not but thank her with reverence: but they begged to solicit and importune her to condescend upon the particulars of a proper scheme for this end, and to carry it into execution; and that, taking into a due consideration the other articles of their demands, she would study to comply with them, and to do justice to the religious establishment of her people.

639  
They rise  
in arms,  
but are  
soon quell-  
ed.

From the fears of the people about their religion, disturbances and insurrections were unavoidable; and before Mary had given her answer to the petitions or address of the clergy, the Protestants, to a formidable number, had marched to St Leonard's Craig; and, dividing themselves into companies, had chosen captains to command them. But the leaders of this tumult being apprehended and committed to close custody, it subsided by degrees; and the queen, upon the intercession of the magistrates of Edinburgh, instead of bringing them to trial, gave them a free pardon. To quiet, at the same time, the apprehensions which had gone abroad, and to controvert the insidious reports which had been industriously spread of her inclination to overturn the reformed doctrines, she repeatedly issued proclamations, assuring her subjects, that it was her fixed determination not to molest or disturb any person whatsoever upon account of his religion or conscience; and that she had never presumed even to think of any innovation that might endanger the tranquillity or do a prejudice to the happiness of the commonwealth.

640  
Intrigues of  
the rebel-  
lious noble-  
with Eliza-  
beth.

While Mary was conducting her affairs with discernment and ability, the earl of Murray and his confederates continued their consultations and their intrigues. After their disappointment in the conspiracy against the queen and the lord Darnley, they perceived that their only hope of success or security depended upon Elizabeth; and as Randolph had promised them her protection and assistance, they scrupled not to address a letter to her, explaining their views and situation. The pretences of their hostility to their sovereign upon which they affected to insist, were her settled design to overturn the Protestant religion, and her rooted desire to break all correspondence and amity with England. To prevent the accomplishment of these purposes, they said, was the object of their confederacy; and with her support and aid they did not doubt of being able to advance effectually the emolument and advantage of the two kingdoms. In the present state of their affairs, they applied not, however, for any supply of her troops. An aid from her treasury was now only necessary to them; and they engaged to bestow her bounty in the manner the most agreeable to her inclinations and her interests. The pleasure with which Elizabeth received their application was equal to the aversion she had conceived against the queen of Scots. She not only granted to them the relief they requested, but assured them by Randolph of her esteem and favour while they should continue to uphold the reformed religion and the

connection of the two nations. Flattered by her assurances and generosity, they were strenuous to gain partisans, and to disunite the friends of their sovereign; and while they were secretly preparing for rebellion, and for trying their strength in the field, they disseminated among the people the tenets, That a Papist could not legally be their king; that the queen was not at liberty of herself to make the choice of a husband; and that, in a matter so weighty, she ought to be entirely directed by the determination of the three estates assembled in parliament.

Scotland.

Elizabeth, at the same time, carrying her dissimulation to the most criminal extremity, commanded Randolph to ask an audience of Mary; and to counsel her to nourish no suspicions of the earl of Murray and his friends; to open her eyes to their sincerity and honour; and to call to mind, that as their services had hitherto preserved her kingdom in repose, her jealousies of them might kindle it into combustion, make the blood of her nobles to flow, and cast into hazard her person and her crown. Full of astonishment at a message so rude and so improper, the queen of Scots desired him to inform his mistress, that she required not her instructions to distinguish between patriotism and treachery; that she was fully sensible when her will or purpose was resisted or obeyed; and that she possessed a power which was more than sufficient to repress and to punish the enormities and the crimes of her subjects. The English resident went now to the earl of Lenox and the lord Darnley, and charged them to return to England. The former expressed an apprehension of the severity of his queen, and sought an assurance of her favour before he could venture to visit her dominions. The latter, exerting greater fortitude, told him, that he acknowledged no duty or obedience but to the queen of Scots. The resident treating this answer as disrespectful to Elizabeth, turned his back upon the lord Darnley, and retired without making any reverence, or bidding him an adieu.

641  
Treachery  
of Eliza-  
beth.

The behaviour of Elizabeth, so fierce and so perfidious, was well calculated to confirm all the intentions of Mary; and this, doubtless, was one of the motives with which she was actuated. But while the queen of Scots was eager to accomplish her marriage, she was not inattentive to the rising troubles of her country. The parliament which she had appointed could not now be held: it was therefore prorogued to a more distant day; and the violence of the times did not then permit it to assemble. By letters she invited to her, with all their retainers, the most powerful and the most eminent of her subjects. Bothwell was recalled anew from France; and by general proclamations she summoned to her standard the united force of her kingdom. The castle of Edinburgh was likewise provided amply with stores and ammunition, that, in the event of misfortunes, it might afford her a retreat and defence. The alacrity with which her subjects flocked to her from every quarter, informed her of her power and popularity; and while it struck Murray and his adherents with the danger to which they were exposed, it declared to them the opinion entertained by the nation of the iniquity and the selfishness of their proceedings.

On the 29th of July 1565, the ceremony of marriage between the queen and lord Darnley was performed. The latter had been previously created duke of Albany.

642  
Marriage  
of Mary  
with lord  
Darnley.

Scotland. Albany. The day before the marriage, a proclamation was published, commanding him to be styled *king of the realm*, and that all letters after their marriage should be directed in the names of her husband and herself. The day after it, a new proclamation was issued confirming this act: he was pronounced king by the sound of trumpets, and associated with the queen in her government. This measure seems to have been the effect of the extreme love the queen had for her husband, which did not permit her to see that it was an infringement of the constitution of the kingdom; though perhaps she might also be urged to it by the pressing eagerness of lord Darnley himself, and the partial counsels of David Rizzio. The earl of Murray made loud complaints, remonstrated, that a king was imposed upon the nation without the consent of the three estates, and called upon the nation to arm against the beginnings of tyranny. The malcontents accordingly were immediately in arms; but their success was not answerable to their wishes. The bulk of the nation were satisfied with the good intentions of their sovereign, and she herself took the earliest opportunity of crushing the rebellion in its infancy. The earl of Murray was declared a traitor; and similar steps were taken with others of the chiefs of the rebels. She then took the field against them at the head of a considerable army: and having driven them from place to place, obliged them at last to take refuge in England. Queen Elizabeth received them with that duplicity for which her conduct was so remarkable. Though she herself had countenanced, and even excited them to revolt, she refused to give an audience to their deputies. Nay, she even caused them to emit a public declaration, that neither she, nor any person in her name, had ever excited them to their rebellious practices. Yet, while the public behaviour of Elizabeth was so acrimonious, she afforded them a secure retreat in her kingdom, treated the earl of Murray in private with respect and kindness, and commanded the earl of Bedford to supply him with money. Mary, however, resolved to proceed against the rebels with an exemplary rigour. The submissions of the duke of Chatelherault alone, who had been less criminal than the rest, were attended to. But even the favour which he obtained was precarious and uncertain; for he was commanded to use the pretence of sickness, and to pass for some time into foreign countries. A parliament was called; and a summons of treason being executed against the earls of Argyle, Glencairn, and Rothes, with others

of the principal rebels, they were commanded to appear before the three estates; in default of which their lives and estates were declared to be forfeited.

In the mean time Throgmorton the English ambassador solicited the pardon of the rebels; which Mary was at first inclined to grant. However, by the persuasion of the court of France, she was not only induced to proceed against them with rigour, but acceded to the treaty of Bayonne, by which the destruction of the Protestants was determined. This measure filled the whole court with terror and dismay. The rebels were acquainted with the danger of their situation; and being now driven desperate, they were ready to engage in the most atrocious designs. Unhappily, the situation of affairs in Scotland rendered the accomplishment of their purposes but too easy. Violent disgusts had taken place between the queen and her husband. Her fondness had been excessive; but she soon perceived that the qualities of his mind were not proportioned to his personal accomplishments. He was proud, disdainful, and suspicious. No persuasions could correct his wilfulness; and he was at the same time giddy and obstinate, insolent and mean. The queen in consequence began to show an indifference towards him; which he took care to augment, by showing the like indifference towards her, and engaging in low intrigues and amours, indulging himself in dissipation and riot, &c. However, the desire of dominion was his ruling passion; and the queen, finding his total incapacity for exercising his power to any good purpose, had excluded him from it altogether. He was therefore at present a proper object for the machinations of the rebels, and readily entered into an agreement with them to depose the queen; vainly thinking by that means that he should secure the crown to himself. However, as the parliament was soon to assemble, in which the rebels had every reason to believe that they would be condemned for high treason, it was necessary that the kingdom should be thrown into disorder before that time came, otherwise their fate was inevitable. Practising on the imbecillity of Darnley, they persuaded him that a criminal correspondence subsisted between the queen and David Rizzio (R). For this reason the king resolved upon his destruction; and the conspirators hoped thereby not only to get an indemnity to themselves, but to effect a total revolution at court, and the entire humiliation of Bothwell, Huntley, and Athol, who were the associates of Rizzio. However, in order to save themselves,

643  
He is proclaimed king of Scotland.

644  
The rebellious nobles driven into England.

Scotland.

645  
Mary accedes to the treaty of Bayonne.

646  
Quarrels between the queen and her husband.

647  
The king conspires the destruction of David Rizzio, with the rebellious nobles.

(R) That there subsisted a criminal intercourse between Mary and Rizzio is a scandal which is now given up by her enemies. It seems to rest on the authority of Buchanan and Knox; and their evidence in this case is clearly of no weight, not only from their being the strenuous partisans of her adversaries, but from the multitude of falsehoods which they anxiously detail to calumniate her. The love she felt for Darnley was extreme, and their acquaintance commenced a month or two after the appointment of Rizzio to be her secretary for French affairs. She became pregnant soon after her marriage; and it was during her pregnancy that Rizzio was assassinated. These are striking presumptions in her favour. And what seems to put her innocence out of all question, is the silence of the spies and residents of Elizabeth with regard to this amour; for, if there had been any thing real in it, they could not have made their court to their queen more effectually than by declaring to her its peculiarities; and their want of delicacy, so observable in other circumstances, would have induced them upon this occasion to give the greatest foulness and deformity to their information.

It appears that Rizzio was ill-favoured, and of a disagreeable form. Buchanan says of him, "Non faciem cultus hoc estabat, sed facies cultum destruebat. Hist. Scot. lib. xvii. This expression is very strong; but it would have little weight if other authors had not concurred in giving a similar description of Rizzio. In a book intitled

Scotland. selves, they engaged the king to subscribe a bond, affirming that the project of assassinating Rizzio was altogether of his own devising; acknowledging that he had solicited them to take a part in it, from the apprehensions that resistance might be made to him; and agreeing, upon the woid and honour of a prince, to protect and secure them against every hazard and injury to which they might be exposed from the achievement of his enterprise. Having procured this security, and having allured the earl of Lenox the king's father to approve their measures, they adjusted the method of the projected murder; and dispatched a messenger to the English frontier, advertising the earl of Murray and the rebels of their intentions, and inviting them to return to the court.

648  
Rizzio  
murdered. Upon the 9th day of March, about 7 o'clock in the evening, armed men, to the number of 500, surrounded the palace of Holyroodhouse. The earl of Morton and the Lord Lindsay entered the court of the palace, with 100 persons. The queen was in her chamber at supper, having in her presence her natural sister the countess of Argyle, her natural brother Robert commendator of Holyroodhouse, Beton of Creich master of the household, Arthur Erskine, and David Rizzio. The king entering the apartment, seated himself by her side. He was followed by the Lord Ruthven, who being wasted with sickness, and cased in armour, exhibited an appearance that was hideous and terrible. Four ruffians attended him. In a hollow voice he commanded Rizzio to leave a place which did not become him. The queen, in astonishment and consternation, applied to the king to unfold to her this mysterious enterprise. He affected ignorance. She ordered Ruthven from her presence, under the pain of treason; declaring to him at the same time, that if Rizzio had committed any crime, she would produce him before the parliament, and punish him according to the laws. Ruthven drawing his dagger, advanced towards Rizzio. The queen rose to make an exertion of her authority. The unfortunate stranger laid hold of her garments, crying out for justice and mercy. Other conspirators rushing into the chamber, overturned the table, and increased the dismay and confusion. Loaded pistols were presented to the bosom of the queen. The king held her in his arms. George Douglas, snatching the dagger of his sovereign, plunged it into the body of Rizzio. The wounded and screaming victim was dragged into the antichamber; and so eager were the assassins

Scotland. to complete their work, that he was torn and mangled with 56 wounds.

While the queen was pressing the king to gratify her inquiries into the meaning of a deed to execrable, Ruthven returned into their presence. She gave a full vent to indignation and reproach. Ruthven, with an intolerable coldness and deliberation, informed her, that Rizzio had been put to death by the counsel of her husband, whom he had dishonoured; and that by the persuasion of this minion she had refused the crown-matrimonial to the king, had engaged to re-establish the ancient religion, had resolved to punish the earl of Murray and his friends, and had entrusted her confidence to Bothwell and Huntley, who were traitors. The king, taking the part of Ruthven, remonstrated against her proceedings, and complained that from the time of her familiarity with Rizzio, she had neither regarded, nor entertained, nor trusted him. His suspicions and ingratitude shocked and tortured her. His connection with the conspirators gave her an ominous anxiety. Apprehensions of outrages still more atrocious invaded her. In these agitated and miserable moments she did not lose herself in the helplessness of sorrow. The loftiness of her spirit communicated relief to her; and wiping away her tears, she exclaimed, that it was not now a season for lamentation, but for revenge.

The earls of Huntley, Bothwell, and Athol, the lords Fleming and Levington, and Sir James Balfour, who were obnoxious to the conspirators, and at this time in the palace, found all resistance to be vain. Some of them eluding the vigilance of Morton, made their escape; and others were allowed to retire. The provost and magistrates of Edinburgh getting intelligence of the tumult, ordered the alarm bell to be rung. The citizens, apprehensive and anxious, approached in crowds to inquire into the welfare of their sovereign; but she was not permitted to address herself to them. The conspirators told her, that if she presumed to make any harangue, they would "cut her in pieces, and cast her over the walls." The king called to the people that she was well, and commanded them to disperse. The queen was shut up in her chamber, uncertain of her fate, and without the consolation or attendance of her women.

In the morning a proclamation was issued by the king, without the knowledge of his queen, prohibiting the meeting of the parliament, and ordering the members to retire from the city. The rebellious lords now returned

intituled, "Le Livre de la Moite de la Reyne d'Ecoffe," and printed in the year 1587, he is said to be "disgracié de corps." Cauffin, ap. Jebb, p. 37. This work, too, while it records the unkindness of nature to his person, has observed, that he was in his old age when he made a figure in the court of Mary. "Elle traittoit ordinairement avec David Riccio son secretaire, homme aagé et prudent, qui possedoit son oreille." Ibid. And other authors give their testimonies to the same purpose.

It is probable that the panegyrist of Mary exaggerate somewhat the imperfections as well as the good qualities of Rizzio. But there seems in general to be no reason to doubt his fidelity and talents, any more than his ugliness and fenility. He had therefore a better title to be her secretary than her lover. It is an absurdity to think that a queen so young and beautiful would yield herself to deformity and old age. A common prostitute must be brought to endure this misfortune. The capacity of the man was a recommendation to him; and as he owed every thing to her bounty, and was a stranger, she had the greatest reason to rely upon his faithfulness. The perfidiousness and duplicity of her courtiers drew closer the tie of their connection; and as Rizzio was studious to make himself agreeable, and was skilful in games of hazard, he was always ready to be a party with her in those innocent amusements which fill up the listless intervals of life. Keith. Append. p. 124.

649  
The queen  
confined.  
and threat-  
ened.

Scotland.

650  
She endeavours in vain to gain the earl of Murray.

returned from England, and arrived at Edinburgh within 24 hours after the assassination of Rizzio. The queen, knowing of how much consequence it was for her to gain the earl of Murray, invited him to wait upon her. Notwithstanding the extreme provocation which she had met with, Mary to far commanded her passions, that she gave him a favourable reception. After informing him of the rudeness and severity of the treatment she had met with, the queen observed, that it he had remained in friendship with her at home, he would have protected her against such excesses of hardness and insult. Murray, with an hypocritical compassion, shed abundance of tears; while the queen seemed to entertain no doubt of his sincerity, but gave him room to hope for a full pardon of all his offences. In the mean time, however, the conspirators held frequent consultations together, in which it was debated, whether they should hold the queen in perpetual captivity, or put her to death; or whether they should content themselves with committing her to close custody in Stirling castle till they should obtain a parliamentary sanction to their proceedings, establish the Protestant religion by the total overthrow of the mass, and invest the king with the crown-matrimonial and the government of the kingdom.

651  
But prevails on the king to abandon the cause of the conspirators.

Mary now began to perceive the full extent of her wretchedness; and therefore, as her last resource, applied to the king, whom she treated with all those blandishments usually employed by the fair sex when they want to gain the ascendancy over the other. The king, who, with all his faults, had a natural facility of temper, was easily gained over. The conspirators were alarmed at his coldness, and endeavoured to fill his mind with fears concerning the duplicity of his wife; but, finding they could not gain their point, they at last began to treat of an accommodation. The king brought them a message, importing, that Mary was disposed to bury in oblivion all memory of their transgressions; and he offered to conduct them into her presence. The earls of Murray and Morton, with the lord Ruthven, attended him into her presence; and, falling on their knees before the queen, made their apologies and submissions. She commanded them to rise; and having desired them to recollect her abhorrence of cruelty and rapaciousness, she assured them with a gracious air, that instead of designing to forfeit their lives, and possess herself of their estates, she was inclined to receive them into favour, and to give a full pardon, not only to the nobles who had come from England, but to those who had assassinated David Rizzio. They were accordingly ordered to prepare the bonds for their security and forgiveness, which the queen promised to take the earliest opportunity of subscribing; but in the mean time the king observed, that the conspirators ought to remove the guards which they had placed around the queen, that all suspicion of restraint might be taken away. This measure could not with any propriety be opposed, and the guards were therefore dismissed; upon which the queen, that very night, left her palace at midnight, and took the road to Dunbar, accompanied by the king and a few attendants.

652  
And escape from them.

The news of the queen's escape threw the conspirators into the utmost consternation; as she immediately issued proclamations for her subjects to attend her in arms, and was powerfully supported. They sent there-

fore the lord Semple, requesting, with the utmost humility, her subscription to their deeds of pardon and security; but to this message she returned an unavourable answer, and advanced towards Edinburgh with an army of 8000 men. The conspirators now fled with the utmost precipitation. Even John Knox retired to Kyle till the storm should blow over. On the queen's arrival at Edinburgh, a privy council was instantly called, in which the conspirators were charged to appear as guilty of murder and treason; their places of strength were ordered to be rendered up to the officers of the crown; and their estates and possessions were made liable to confiscation and forfeiture.

Scotland.

653  
The rebellious nobles are declared traitors.

But while the queen was thus eager to punish the conspirators, she was sensible that so many of the nobility, by uniting in a common cause, might raise a powerful party in opposition to her; for which reason she endeavoured to detach the earl of Murray from the rest, by making him offers of pardon. Sir James Melvil accordingly pledged himself to produce his pardon and that of his adherents, if he would separate from Morton and the conspirators. He accordingly became cold and distant to them, and exclaimed against the murder as a most execrable action; but notwithstanding his affected anger, when the conspirators fled to England, he furnished them with letters of recommendation to the earl of Bedford. After the flight of the conspirators, the king thought it necessary for him to deny his having any share in the action. He therefore embraced an opportunity of declaring to the privy council his total ignorance of the conspiracy against Rizzio; and not satisfied with this, he, by public proclamations at the market-place of his capital, and over the whole kingdom, protested to the people at large that he had never bestowed upon it, in any degree, the sanction of his command, consent, assistance, or approbation.

654  
Shameful treachery declared the king.

In the mean time the queen granted a full and ample pardon to the earls of Murray, Argyle, Glencairn, and Rothes, and their adherents; but towards the conspirators she remained inexorable. This lenity, to Murray especially, proved a source of the greatest inquietude to the queen; for this nobleman, blind to every motive of action distinct from his own ambition, began to contrive new plots, which, though disappointed for a time, soon operated to the destruction of the queen, and almost to the ruin of the nation.

655  
Murray and some others of the rebels are pardoned.

In 1566, the queen was delivered of a prince, who received the name of *James*. This happy event, however, did not extinguish the quarrel betwixt her and the king. His desire to intrude himself into her authority, and to fix a stain upon her honour, his share in the murder of Rizzio, and his extreme meanness in publicly denying it afterwards, could not fail to impress her with the strongest sentiments of detestation and contempt. Unable, however, totally to divest herself of regard for him, her behaviour, though cold and distant, was yet decent and respectful. Castelnau, at this time ambassador extraordinary from France, conceived that a reconciliation might be effected, and employed himself some time in this friendly office. Nor were his endeavours altogether ineffectual. The king and queen spent two nights together; and proceeded, in company with each other, to Meggatland in Tweeddale, in order to enjoy the diversion of the chase, attended by the earls of Huntley, Bothwel, Murray, and other nobles. From

656  
Birth of James VI.

657  
A partial reconciliation between the king and queen.

thence they passed to Edinburgh, and then took the road to Stirling. Had the king been endowed with any prudence, he would have made the best use of this opportunity to have regained the affections of his queen; but, instead of this, finding that he was not immediately intrusted with power, his peevishness suggested to him a design of going abroad. To Monsieur du Croc, the French resident, who had attended Mary at Stirling, he ventured to communicate his chimerical project. This statesman represented to him its wildness and inefficacy; and could hardly believe that he was serious. To his father the earl of Lenox, who paid him a visit at this place immediately upon Mary's departure from it, he likewise communicated his intention; and all the intreaties, arguments, and remonstrances of this nobleman to make him drop his design, were without success. He provided a vessel, and kept it in readiness to carry him from his dominions. The earl of Lenox, after returning to Glasgow, where he usually resided, gave way to his paternal anxieties, and solicited the queen by letter to interfere with her authority and persuasions; and upon the evening of the day in which she received this dispatch, the king alighted at Holyroodhouse. But the names of the nobles who were with the queen being announced to him, he objected to three of them, and insisted that they should be ordered to depart, before he would enter within the gates of the palace. The queen, alarmed with a demeanour so rude and so unwarrantable, condescended to leave her company and her palace to meet him; and it was with great difficulty that she was able to entice him into her own apartment. There he remained with her during the night. She communicated to him his father's letter, and employed every art and blandishment to engage him to explain his perverse design. But he gave her no return or satisfaction. He was unmoved with her kindness; and his silence, dejection, and peevishness, augmented her distress. In the morning, she called her privy council to assemble in the palace, and invited to her Monsieur du Croc the French envoy. By the bishop of Ross she explained the intention of the king, and made known the dispatch of the earl of Lenox. The privy council were urgent to know the reasons of a voyage that appeared to them so inexplicable; and earnestly pressed the king to unbosom himself. If his resolution proceeded from discontent, and if there were persons in the kingdom who had given him causes of offence, they assured him, that they were ready, upon his information, to take the necessary steps to make him easy and happy. No quality or rank should exempt those from inquiry and punishment who had committed misdemeanors against him. This, they said, consisted with his honour, with the honour of the queen, and with their own. If, however, he had received no sufficient provocation to justify his behaviour, and if he had no title to complain of actual injuries, they admonished him to remember, that his flight from a queen so beautiful, and from a kingdom so ancient and noble, would expose him to the greatest ridicule and disgrace. They pointed out the happiness of his fortune, and counselled him not to part lightly with all its flattering advantages. The queen herself, taking his hand into hers, and pressing it with affection, besought him to say by what act or deed she had unfortunately induced him to conceive so fatal a purpose. Her memory did

not reproach her with any crime or indiferection which affected his honour or her integrity: yet if, without any design upon her part, she had incurred his displeasure, she was disposed to atone for it; and she begged him to speak with entire freedom, and not in any degree to spare her. Monsieur du Croc then addressed him, and employed his interest and persuasions to make him reveal his inquietudes. But all this respectful attention and ceremonious duty were ineffectual. Obstinately froward, he refused to confess that he intended any voyage, and made no mention of any reasons of discontent. He yet acknowledged with readiness, that he could not with justice accuse the queen of any injury or offence. Oppressed with uneasiness and perturbation, he prepared to retire; and, turning to her, said, "Adieu, Madam! you shall not see me for a long time." He then bowed to the French envoy, and to the lords of the privy council.

He hastened back to Stirling, leaving the queen and her council in surprise and astonishment. They resolved to watch his motions with anxiety, and could not conjecture what step he would take. Mary, to prevent the effect of rumours to her disadvantage, dispatched a courier to advertise the king of France and the queen-mother of his conduct. It was not possible that a prince so meanly endowed with ability could make any impression upon her allies. Nor did it appear to be in his power to excite any domestic insurrection or disturbance. He was universally odious; and, at this time, the queen was in the highest estimation with the great body of her subjects. After passing some days at Stirling, he addressed a letter to the queen, in which, after hinting at his design of going abroad, he insinuated his reasons of complaint. He was not trusted by her with authority, and she was no longer studious to advance him to honour. He was without attendants; and the nobility had deserted him. Her answer was sensible and temperate. She called to his remembrance the distinctions she had conferred upon him, the uses to which he had put the credit and reputation accruing from them, and the heinous offences he had encouraged in her subjects. Though the plotters against Rizzio had represented him as the leader of their enterprize, she had yet obtained from any accusation of him, and had even behaved as if she believed not his participation in the guilt of that project. As to the defects of his retinue, she had uniformly offered him the attendance of her own servants. As to the nobility, they were the supports of the throne, and independent of it. Their countenance was not to be commanded, but won. He had discovered too much stateliness to them; and they were the proper judges of the deportment that became them. If he wished for consequence, it was his duty to pay them court and attention; and whenever he should procure and conciliate their regard and commendation, she would be happy to give him all the importance that belonged to him.

In the mean time, the earls of Murray and Bothwell were industriously striving to widen the breach between the king and queen, and at the same time to foment the division between the king and his nobles. The earl of Morton excited disturbances on the borders; and as no settled peace had taken place there since Mary's marriage, there was the greatest reason to believe that he would succeed in his attempts. Pro-

clamations

Scotland.  
648  
which is  
taken off  
the  
king's im-  
pudent be-  
haviour.

Scotland.

Scotland.

650  
Mary falls  
sick, but  
recovers.

clamations were therefore issued by the queen to call her subjects to arms; and she proceeded to Jedburgh, to hold justice-courts, and to punish traitors and disorderly persons. In the course of this journey she was taken dangerously ill; inasmuch that, believing her death to be at hand, she called for the bishop of Ross, telling him to bear witness, that she had persevered in that religion in which she had been nourished and brought up; taking the promise of her nobles, that after her death they would open her last will and testament, and pay the respect to it that consisted with the laws; recommending to them the rights of her infant son, and the charge of educating him in such a manner as might enable him to rule the kingdom of his ancestors with honour; and intreating them to abstain from all cruelty and persecution of her Roman Catholic subjects. Notwithstanding her apprehensions, however, and the extreme violence of her distemper, the queen at last recovered perfect health. As soon as she was able to travel, she visited Kelso, Werk castle, Hume, Langton, and Wedderburn. The licentious borderers, on the first news of her recovery, laid down their arms. Being desirous to take a view of Berwick, the queen advanced to it with an attendance of 1000 horse. Sir John Forster, the deputy warden of the English marches, came forth with a numerous retinue, and conducted her to the most proper station for surveying it, and paid her all the honours in his power, by a full discharge of the artillery, and other demonstrations of joy. Continuing her journey, she passed to Eymouth, Dunbar, and Tantallon; proceeding thence to Craigmillar castle, where she proposed to remain till the time of the baptism of the prince, which was soon to be celebrated at Stirling.

660  
Unkindness  
of the king.

During the severe sickness of the queen, her husband kept himself at a distance: but when she was so far recovered as to be out of danger, he made his appearance; and being received with some coldness and formality, he retired suddenly to Stirling. This cruel neglect was a most sensible mortification to her; and while she suffered from his ingratitude and haughtiness, she was not without suspicions that he was attempting to disturb the tranquillity of her government. She was seized with a settled melancholy; and, in her anguish, often wished for death to put a period to her existence. Her nobles, who were caballing against her, remarked her condition, and took advantage of it. Bothwel, who had already recommended himself by his services, redoubled his efforts to heighten the favour which these services had induced her to conceive for him. At this time, it is probable, he sought to gain the affection of the queen, with a view to marry her himself, providing a divorce from her husband could be obtained, which was now become the subject of consultation by Murray and his associates. After much deliberation, the queen herself was acquainted with this project; and it was told her, that provided she would pardon the earl of Morton and his associates, the means should be found of effectuating the divorce. This was urged as a matter of state by the earls of Murray, Lethington, Argyle, and Huntley; and the queen was invited to consider it as an affair which might be managed without any interference on her part. The queen replied, that she would listen to them, upon condition that the divorce could be ob-

661  
A divorce  
is proposed.

tained according to the laws, and that it should not be any way prejudicial to her son: but if they meant to operate their purpose by a disregard to these points, they must not think any more of it; for rather than consent to their views, she would endure all the torments, and abide by all the perils, to which her situation exposed her.

Lethington upon this, in the name of the rest, engaged to make her quit of her husband, without prejudice to her son; words which could not be understood otherwise than as pointing at murder. Lord Murray (added he), who is here present, scrupulous as he is, will connive; and behold our proceedings without opening his lips. The queen immediately made answer, "I desire that you will do nothing from which any stain may be fixed upon my honour or conscience; and I therefore require the matter to rest as it is, till God of his goodness send relief: What you think to be of service to me may turn out to my displeasure and harm."

It appears, however, that from this moment a plot was formed by Murray, Bothwel, and Lethington, against the life of Darnley, and by some of them probably against the queen herself; and that Morton, who with the other conspirators against Rizzio had received a pardon, was closely associated with them in their nefarious designs. That profligate peer was, in his way to Scotland, met at Whittingham by Bothwel and the secretary. They proposed to him the murder of the king, and required his assistance, alleging that the queen herself consented to the deed; to which Morton by his own account replied, that he was disposed to concur, provided he were sure of acting under any authority from her; but Bothwel and Lethington having returned to Edinburgh, on purpose to obtain such an authority, sent him back a message, That the queen would not permit any conversation upon that matter.

In the mean time, preparations were made for the baptism of the young prince; to assist at which the queen left Craigmillar and went to Stirling. The ceremony was performed on the 17th of December 1666. After the baptismal rites were performed, the name and titles of the prince were three times proclaimed by the heralds to the sound of trumpets. He was called and designed, Charles James, James Charles, prince and Steward of Scotland, duke of Rothesay, earl of Carrick, lord of the Isles, and baron of Renfrew. Amidst the scenes of joy displayed on this occasion, the king showed his folly more than he had done before. As Elizabeth did not mean to acknowledge him in his sovereign capacity, it was neither consistent with the dignity of the queen, nor his own, that he should be present at the baptism. He did not indeed present himself either at the ceremony or the entertainments and masquerades with which it was accompanied. At this juncture, however, though he had often kept at a greater distance before, he took up his residence at Stirling, as if he had meant to offend the queen, and to expose their quarrels to the world. Du Croc, who was inclined to be favourable to him, was so struck with the impropriety of his behaviour, that he affected to have instructions from France to avoid all intercourse with him; and when the king proposed to pay him a visit, he took the liberty to inform him, that there were two passages in his chamber; and that if his majesty

662  
Absurd be-  
haviour of  
the king.



Scotland majesty should enter by the one, he should be constrained to go out by the other.

While he resided at Stirling, the king chiefly confined himself to his chamber. His strange behaviour to the queen did not give the public any favourable idea of him; and as the earl of Murray and his faction took care to augment the general odium, no court was paid to him by foreign ambassadors. His situation, therefore, was exceedingly uncomfortable; but though he must have been conscious of his imprudence and folly, he did not alter his conduct. In a sullen humour he left Stirling, and proceeded to Glasgow. Here he fell sick, with such symptoms as seemed to indicate poison. He was tormented with violent pains, and his body was all covered over with pustules of a bluish colour; so that his death was daily expected. Mary did not repay his coldness to her by negligence. She set out immediately for Glasgow, and waited on him with all the assiduity of an affectionate wife, until he recovered: after which she returned with him to Edinburgh; and as the low situation of the palace of Holyroodhouse was thought to render it unhealthy, the king was lodged in a house which had been appointed for the superior of the church, called *St Mary's in the Fields*. This house stood upon an high ground, and in a salubrious air; and here she staid with him some days. — Here the conspirators thought proper to finish their plot in the most execrable manner. On the 10th of February 1567, about two o'clock in the morning, the house where the king resided was blown up by gunpowder. The explosion alarming the inhabitants, excited a general curiosity, and brought multitudes to the place from whence it proceeded. The king was found dead and naked in an adjoining field, with a servant who used to sleep in the same apartment with him. On neither was there any mark of fire or other external injury.

The queen was in the palace of Holyroodhouse, taking the diversion of a masked ball, which was given to honour the marriage of a favourite domestic, when the news of the king's death was brought to her. She showed the utmost grief, and appeared exasperated to the last degree against the perpetrators of a deed at once so shocking and barbarous. The most express and peremptory orders were given to inquire after the perpetrators by every possible method. A proclamation was issued by the privy-council, assuring the people, that the queen and nobility would leave nothing undone to discover the murderers of the king. It offered the sum of 2000 l. and an annuity for life, to any person who should give information of the devisers, counsellors, and perpetrators of the murder; and it held out this reward, and the promise of a full pardon, to the conspirator who should make a free confession of his own guilt, and that of the confederates. On the fourth day after this proclamation was published, a placard was affixed to the gate of the city-prison, affirming, that the earl of Bothwell, James Balfour, David Chalmers, and black John Spence, were the murderers. No name, however, was subscribed to this intelligence, nor was any demand made for the proffered reward; so that it was difficult to know whether this advertisement had been dictated by a spirit of calumny or the love of justice.

In the mean time, the earl of Murray conducted

himself with his usual circumspection and artifice. Upon a pretence that his wife was dangerously sick at his castle in Fife, he, the day before the murder, obtained the queen's permission to pay a visit to her. By this means he proposed to prevent all suspicion whatever of his guilt. He was so full, however, of the intended project, that while he was proceeding on his journey, he observed to the person who accompanied him, "This night, before morning, the lord Darnley shall lose his life." When the blow was struck, he returned to Edinburgh to carry on his practices. Among foreign nations, the domestic disputes of the queen and her husband being fully known, it was with the greater ease that reports could be propagated to her disadvantage. To France letters were dispatched, expressing, in fervent terms, her participation in the murder. In England, the ministers and courtiers of Elizabeth could not flatter that princess more agreeably, than by industriously detracting from the honour and the virtue of the Scottish queen. Within her own dominions a similar spirit of outrage exerted itself, and not without success. As her reconciliation with her husband could not be unknown to her own subjects, it was interpreted to be dissimulation and treachery. The Protestant clergy, who were her most determined enemies, possessed a leading direction among the populace; and they were the friends and the partizans of the earl of Murray. Open declamations from the pulpit were made against Bothwell, and strong insinuations and biting surmises were thrown out against the queen. Papers were dispersed, making her a party with Bothwell in the murder. Every art was employed to provoke the frenzy of the people. Voices, interrupting the silence of the night, proclaimed the infamy of Bothwell; and portraits of the regicides were circulated over the kingdom.

The queen's determination, however, to scrutinize into the matter was unabated; and to the earl of Lennox, the king's father, she paid an attention which he could only have expected from her upon an emergency of this kind. Having pressed her by letter to the most diligent inquiry after the regicides, she returned an answer so completely to his wishes, that he was fully convinced of the sincerity and rigour with which she intended to proceed against them: and he urged her to assemble the three estates, that their advice might direct the order and manner of their trial. She wrote to him, that an assembly of the estates was already proclaimed; and that it was her earnest and determined will and purpose, that no step should be neglected that could conduce to the advancement and execution of justice. Yielding to his anxieties, he addressed her anew, intreating that the trial might not be delayed; observing, that it was not a matter of parliamentary inquiry; advising, that it would be more proper to proceed to it with the greatest expedition; and urging her to commit to prison all the persons who had been named and described in the papers and placards which had been set up in the public places of the city. The queen informed him, that although she had thought it expedient to call a meeting of the parliament at this juncture, it was not her meaning that the proceedings against the regicides should be delayed till it was actually assembled. As to the placards and papers to which he alluded, they were so numerous and contradictory,

663  
He falls  
sick,

664  
And is  
murdered.

665  
Attempts  
to discover  
the mur-  
derers.

Scotland.  
666  
Strong pre-  
sumption  
of the guilt  
of the earl  
of Murray.

667  
He accus-  
es the queen.

668  
The queen  
determines  
to find out  
and punish  
the mur-  
derers.

Scotland.

669  
Lenox ac-  
cuses several persons.

that she could not well determine upon which to act; but if he would condescend to mention the names which, in his opinion, were most suspicious, she would instantly command that those steps should be taken which the laws directed and authorised. He in return named the earl of Bothwel, James Balfour, David Chalmers, black John Spence, Francis Sebastian, John de Burdeaux, and Joseph the brother of David Rizzio; and assured her majesty, that his suspicions of these persons were weighty and strong. In reply to his information, Mary gave him her solemn promise, that the persons he had pointed out should abide and undergo their trial in conformity to the laws, and that they should be punished according to the measure of their guilt: and she invited him to leave immediately his retirement, and to meet her at her court, that he might witness the proceedings against them, and the zeal with which she was animated to perform the part that became her.

While the queen carried on this correspondence with the earl of Lenox, she resided partly at the palace of the lord Seton, at the distance of a few miles from her capital, and partly at Holyroodhouse. By the time that she sent her invitation to him, she was residing in her capital. She delayed not to confer with her counsellors, and to lay before them the letters of the earl of Lenox. Bothwel was earnest in his protestations of innocence; and he even expressed his wish for a trial, that he might establish his integrity. No facts pointed to his guilt; there had appeared no accuser but the earl of Lenox; and no witnesses had been found who could establish his criminality. Her privy-council seemed to her to be firmly persuaded that he was suffering under the malice of defamation. Murray, Morton, and Lethington, whatever might be their private machinations, were publicly his most strenuous defenders; and they explained the behaviour of the earl of Lenox to be the effect of hatred and jealousy against a nobleman who had outrun him so far in the career of ambition. But though all the arts of Murray and Bothwel, Morton and Lethington, were exerted to their utmost extent to mislead the queen, they were not able to withhold her from adopting the strain of conduct which was the most proper and the most honourable to her. It was her own ardent desire that the regicides should be punished; she had given her solemn promise to the earl of Lenox, that the persons whom he suspected should be prosecuted; and amidst all the appearances in favour of Bothwel, and all the influence employed to serve him, it is to be regarded as a striking proof of her honour, vigour, and ability, that she could accomplish this measure. An order, accordingly, of the privy-council was made, which directed, that the earl of Bothwel, and all the persons named by Lenox, should be brought to trial for the murder of the king, and that the laws of the land should be carried into full execution. The 12th of April was appointed for the trial. A general invitation was given to all persons whatsoever to prefer their accusations. The earl of Lenox was formally cited to do himself justice, by appearing in the high court of judicary, and by coming forward to make known the guilt of the culprits.

670  
And is invited to prove his accusations.

In the mean time, it was proper to repress that spirit of outrage that had manifested itself against the

queen. No discoveries, however, were made, except against James Murray, brother to Sir William Murray of Tullibardin, who at different times had published placards injurious to her. He was charged to appear before the privy-council: but refusing to obey its citation, it was made a capital offence for any commander of a vessel to convey him out of the kingdom; and the resolution was taken to punish him with an exemplary severity. Effecting, however, his escape, he avoided the punishment due to his repeated and detestable acts of calumny and treason.

The day for the trial of Bothwel approached. The conspirators, notwithstanding their power, were not without apprehensions. Their preparations, however, for their safety had been anxious; and, among other practices, they neglected not to attempt to throw a panic into the earl of Lenox. They were favoured by his consciousness of his unpopularity, and his want of strength, by his timidity and his spirit of jealousy. Suspicions of the queen's guilt were insinuated into him; and the dangers to which he might be exposed by insisting on the trial were set before him in the strongest colours. He was sensible of her aversion to him; and his weakness and the sovereign authority were contrasted. His friends concurred with his enemies to intimidate him, from the spirit of flattery, or from a real belief that his situation was critical. By the time he had reached Stirling, in his way to Edinburgh, his fears predominated. He made a full stop. He was no longer in haste to proceed against the regicides. He addressed a letter to the queen, in which he said he had fallen into such sickness, that he could not travel; and he affirmed, that he had not time to prepare for the trial and to assemble his friends. He complained, too, that Bothwel and his accomplices had not been committed to custody; he insisted, that this step should be taken; and he requested, that a day at a greater distance might be appointed for the trial. After the lengths to which matters had gone, this conduct was most improper; and it is only to be accounted for from terror or capriciousness. His indisposition was affected; he had been invited by Mary to wait upon her at Edinburgh at an early period, to concert his measures; and the delay he asked was in strong contradiction to his former intreaties. After the invitation sent to him, he might have relied with safety upon the protection of the queen, without any gathering of his friends; from the time of her private intimation to him, and of the legal citations of her officers, there had passed a period more than sufficient for the purpose of calling them together; and indeed to suppose that there was any necessity for their assistance, was an insult to government, and a matter of high indecency. There was more justice in the complaint, that the earl of Bothwel and his accomplices had not been taken into custody; and yet even in this peculiarity, he was himself to blame in a great degree. For he had not observed the precaution of that previous display of evidence, known in the Scottish law under the term of a precognition, which is common in all the grosser offences, and which the weighty circumstances of the present case rendered so necessary as a foundation for the confinement and conviction of the criminals.

Scotland

671  
He is intimidated.672  
And wishes to defer the trial.

Scotland.

673  
But his pe-  
cution is re-  
fused.

An application for the delay of a trial so important, upon the night immediately preceding the day slated for it, and reciting reasons of no conclusive force, could not with propriety be attended to. The privy-council refused the demand of the earl of Lenox. The court of justiciary was assembled. The earl of Argyll acted in his character of lord high justiciar; and was aided by four assessors, Robert Pitcairn, commendator of Dunfermline, and the lord Lindsay, with Mr James Macgill and Mr Henry Balnaves, two lords of the session. The indictment was read, and the earls of Bothwel and Lennox were called upon; the one as the defender, the other as the accuser. Bothwel, who had come to the court with an attendance of his vassals, and a band of mercenary soldiers, did not fail to present himself: but Lenox appeared only by his servant Robert Cunaynham; who, after apologizing for his absence, from the shortness of the time, and the want of the presence of his friends, desired that a new day should be appointed for the trial; and protested, that if the jury should now enter upon the business, they should incur the guilt of a wilful error, and their verdict be of no force or authority.

674  
Bothwel  
acquitted.

This remonstrance and protestation appeared not to the court of sufficient importance to interrupt the trial. They paid a greater respect to the letters of the earl of Lenox to the queen insisting upon an immediate prosecution, and to the order of the privy-council consequent upon them. The jury, who consisted of men of rank and condition, after considering and reasoning upon the indictment for a considerable time, were unanimous in acquitting Bothwel of all share and knowledge of the king's murder. The machinations however of Morton, which we have mentioned in the life of MARY, were so apparent, that the earl of Caithness, the chancellor of the assize, made a declaration in their name and his own, that no wilful error ought to be imputed to them for their verdict; no proof, vouchers, or evidence, to confirm or support the criminal charge having been submitted to them. At the same time, he offered a protestation for himself, that there was a mistake in the indictment, the 9th day of February instead of the 10th being expressed in it as the date of the murder. It is not to be doubted, but that this flaw in the indictment was a matter of design, and with a view to the advantage of Bothwel, if the earl of Lenox had made his appearance against him. And it has been remarked as most indecent and suspicious, that soldiers in arms should have accompanied him to the court of justice; that during the trial, the earl of Morton stood by his side to give him countenance and to assist him; and that the four assessors to the chief justiciar were warm and strenuous friends to the earl of Murray.

Immediately after his trial, Bothwel set up in a conspicuous place a writing, subscribed by him, challenging to single combat, any person of equal rank with himself, who should dare to affirm that he was guilty of the king's murder. To this challenge an answer was published, in which the defiance was accepted, upon the condition that security should be given for a fair and equal conflict: but no name being subscribed to this paper, it was not understood to correspond with the law of arms; and of consequence no step was

taken for the fighting of the duel. Two days after the parliament met, and there the party of Bothwel appeared equally formidable. The verdict in his favour was allowed to be true and just. He was continued in his high offices; and obtained a parliamentary ratification of the place of keeper of Dunbar castle, with the estates in connection with it; and other favours were conferred upon Murray, with the rest of the nobles suspected as accomplices in the murder.

Scotland.

A very short time after the final acquitment of Bothwel, he began to give a greater loose to his ambition, and conceived hopes of gaining the queen in marriage. It has been already remarked, that he had insidiously endeavoured to gain her affection during the lifetime of her husband; but though he might have succeeded in this, the recent death of the king in such a shocking manner, and the strong suspicions which must necessarily still rest upon him, notwithstanding the trial he had undergone, necessarily prevented him from making his address openly to her. He therefore endeavoured to gain the nobility over to his side; which having done one by one, by means of great promises, he invited them to an entertainment, where they agreed to ratify a deed pointing him out to the queen as a person worthy of her hand, and expressing their resolute determination to support him in his pretensions. This extraordinary bond was accordingly executed; and Murray's name was the first in the list of subscribers, in order to decoy others to sign after him; but that he might appear innocent of what he knew was to follow, he had, before any use was made of the bond, asked and obtained the queen's permission to go to France. In his way thither he visited the court of Elizabeth, where he did not fail to confirm all the reports which had arisen to the disadvantage of Mary; and he now circulated the intelligence that she was soon to be married to Bothwel. Her partizans in England were exceedingly alarmed; and even queen Elizabeth herself addressed a letter to her, in which she cautioned her not to afford such a mischievous handle to the malice of her enemies.

Mary, upon the dissolution of the parliament, had gone to Stirling to visit the young prince. Bothwel, armed with the bond of the nobles, assembled 1000 horse, under the pretence of protecting the borders, of which he was the warden; and meeting her upon her return to her capital, dismissed her attendants, and carried her to his castle of Dunbar. The arts which he used there to effect the accomplishment of his wishes we have mentioned under another article, (see MARY). But having been married only six months before to Lady Jane Gordon, sister to the earl of Huntley, it was necessary to procure a divorce before he could marry the queen. This was easily obtained. The parties were cousins within the prohibited degrees, and had not obtained a dispensation from Rome. Their marriage, therefore, in the opinion of the queen and her Roman Catholic subjects, was illicit, and a profane mockery of the sacrament of the church. The husband had also been unfaithful; so that two actions of divorce were instituted. The lady commenced a suit against him in the court of the commissaries, charging him as guilty of adultery with one of her maids. The earl himself brought a suit against his wife before the court of the archbishop of St Andrew's, upon the plea of consanguinity.

675  
He aspires  
at a mar-  
riage with  
the queen.676  
Is recom-  
mended by  
the nobility  
as a proper  
husband for  
her.677  
Schemes of  
the earl of  
Murray to  
hurt the  
queen.678  
Bothwel  
carries her  
off to Dun-  
bar.679  
Is divorced  
from his  
wife.

Scotland.

guinity. By both courts their marriage was decided to be void; and thus two sentences of divorce were pronounced.

Bothwel now conducted the queen from Dunbar to her capital. But instead of attending her to her palace of Holyrood house, his jealousy and apprehensions induced him to lodge her in the castle of Edinburgh, where he could hold her in security against any attempt of his enemies. To give satisfaction, however, to her people, and to convince them that she was no longer a prisoner, a public declaration upon her part appeared to be a measure of expediency. She presented herself, therefore, in the court of session; the lords chancellor and president, the judges, and other persons of distinction, being present. After observing that some stop had been put to the administration of justice upon account of her being detained at Dunbar against her will by the lord Bothwel, she declared, that though she had been highly offended with the outrage offered to her, she was yet inclined to forget it. His courteousness, the sense she entertained of his past services to the state, and the hope with which she was impressed of his zeal and activity for the future, compelled her to give him and his accomplices in her imprisonment a full and complete pardon. She at the same time desired them to take notice, that she was now at her freedom and liberty; and that she proposed, in consideration of his merits, to take an early opportunity of promoting him to new and distinguished honours.

650  
Banns of  
the mar-  
riage pro-  
claim.ed.

It was understood that the queen was immediately to advance him to be her husband. The order was given for the proclamation of the banns; and Mr John Craig, one of the ministers of Edinburgh, was desired to perform this business. But though the order was subscribed by the queen, he refused absolutely his compliance without the authority of the church. The brethren, after long reasonings, granted him permission to discharge this duty. His scruples, notwithstanding, and delicacy, were not yet removed. He protested, that, in obeying their desire, he should be allowed to speak his own sentiments concerning the marriage, and that his publishing the banns should infer no obligation in him to officiate in the solemnity. In his congregation, accordingly, before a crowded audience, and in the presence of several noblemen and privy counsellors, he declared that the marriage of the queen and the earl of Bothwel was unlawful, and that he was prepared to give his reasons for this opinion to the parties themselves. He added, that if leave to do this was denied him, he would either abstain altogether from proclaiming the banns, or take the liberty, after proclaiming them, to inform his people of the causes of his disapprobation of the marriage. He was carried before the lords of the privy-council; and the earl of Bothwel called upon him to explain his behaviour. He answered, that the church had prohibited the marriage of per-

681  
Fortitude  
of Mr John  
Craig.

sons separated for adultery; and that the divorce between him and his wife must have been owing to collusion; since the sentence had been given with precipitation, and since his new contract was so sudden; and he objected to him the abduction and ravishment of the queen, and the suspicion of his guilt in the king's murder. This bold language drew no reply from Bothwel that was satisfactory to Mr Craig, or that could intimidate him. He proclaimed in his church the banns of the marriage; but he told the congregation, that he discharged the suggestions of his conscience in pronouncing it to be a detestable and scandalous engagement. He expressed the sorrow he felt for the conduct of the nobility, who seemed to approve it from their flattery or silence; and addressing himself to the faithful, he besought them to pray to the Almighty that he would turn a resolution intended against law, reason, and religion, into a comfort and benefit to the church and the kingdom. These freedoms were too great to pass unnoticed. Mr Craig was ordered anew to attend the privy-council; and he was reprimanded with severity for exceeding the bounds of his commission. He had the courage to defend himself. His commission, he said, was founded in the word of God, positive law, and natural reason; and upon the foundation of these topics he was about to prove that the marriage must be universally foul and odious, when the earl of Bothwel commanded him to be silent. The privy-council, struck with the vigour of the man, and apprehensive of the public discontents, did not dare to inflict any punishment upon him; and this victory over Bothwel, while it heightened all the suspicions against him, served to encourage the enemies of the queen, and to undermine the respect of her subjects.

Mary, before she rendered her hand to Bothwel, created him duke of Orkney. The ceremony was performed in a private manner, after the rules of the Popish church; but, to gratify the people, it was likewise solemnized publicly according to the Protestant rites by Adam Bothwel bishop of Orkney, an ecclesiastic who had renounced the Episcopal order for the reformation. It was celebrated with little pomp and festivity. Many of the nobles had retired to their seats in the country; and those who attended were thoughtful and sad. Du Croc, the French ambassador, sensible that the match would be displeasing to his court, refused to give his countenance to the solemnity. There were no acclamations of the common people. Mary herself was not unconscious of the imprudence of the choice she had made, and looked back with surprise and sorrow to the train of circumstances which had conducted her to this fatal event. Forsaken by her nobles, and imprisoned at Dunbar, she was in so perilous a situation that no remedy could save her honour but death. Her marriage was the immediate and necessary consequence of that situation (s). It was the point

682.  
The mar-  
riage cele-  
brated.

(s) "The queen (says Melvil) could not but marry him; seeing he had ravished her and lain with her against her will." *Memoirs*, p. 159. In the following passage, from a writer of great authority, in our history, this topic is touched with no less exactness, but with greater delicacy. After Mary had remained a fortnight under the power of a daring profligate adventurer, says Lord Hailes, few foreign princes would have solicited her hand.

Scotland. point for which her enemies had laboured with a wicked and relentless policy.

Mary was unfortunate in her second marriage, but much more so in her third. Bothwel had neither talents for business nor affection for his wife. Ambitious and jealous to the last degree, he sought only to establish himself in power, while his fears and jealousies made him take the most improper means. The marriage had already thrown the nation into a ferment; and the least improper exercise of power, or indeed an appearance of it, even on the part of the queen, would be sufficient to ruin them both for ever. Perhaps the only thing which at this juncture could have pacified the people, would have been the total abolition of Popery, which they had often required. But this was not thought of. Instead of taking any step to please the people, Bothwel endeavoured to force the earl of Marre to deliver up the young prince to his custody.— This was sufficient to make the flame, which had hitherto been smothered, break out with all its violence.

It was universally believed that Bothwel, who had been the murderer of the father, designed to take away the life of the son also, and the queen was thought to participate in all his crimes. The earl of Murray now took advantage of the queen's unfortunate situation to aggrandize himself and effect her ruin. After having visited the English court, he proceeded to France, where he assiduously disseminated all the reports against the queen which were injurious to her reputation; and where, without being exposed to suspicion, he was able to maintain a close correspondence with his friends Morton and Lethington, and to inspire their machinations. His associates, true to his ambition and their own, had promoted all the schemes of Bothwel upon the queen with a power and influence which had insured their success. In confederacy with the earl of Murray himself, they had conspired with him to murder the king. Assisted with the weight of the earl of Murray, they had managed his trial, and operated the verdict which acquitted him. By the same arts, and with the same views, they had joined with him to procure the bond of the nobles recommending him to the queen as a husband, asserting his integrity and innocence, recounting his noble qualities, expressing an unalterable resolution to support the marriage against every opposer and adversary, and recording a wish that a defection from its objects and purposes should be branded with everlasting ignominy, and held out as a most faithless and perjured treachery. When the end, however, was accomplished for which they had been so zealous, and when the marriage of the queen was actually celebrated, they laid aside the pretence of friendship, and were in haste to entitle themselves to the ignominy which they had invited to fall upon them. The murder of the king, the guilt of Bothwel, his acquittal, his divorce, and his marriage, became the topics of their complaints and declamation. Upon the foundation of this hated

marriage, they even ventured privately to infer the privacy of the queen to all his iniquity and transactions; and this step seemed doubtless, to the mass of her own subjects and to more distant observers, a strong confirmation of all the former suspicions to her shame which had been circulated with so much artifice. Their imputations and devices excited against her, both at home and abroad, the most indignant and humiliating odium. Amidst the ruins of her fame, they thought to bury for ever her tranquillity and peace; and in the convulsions they had meditated, they already were anticipating the downfall of Bothwel, and snatching at the crown that tottered on her head.

But while this cabal were prosecuting their private ends, several noblemen, not less remarkable for their virtue than their rank, were eager to vindicate the national integrity and honour. The earl of Athol, upon the king's murder, had retired from the court, and was waiting for a proper season to take revenge upon the regicides. The earl of Marre, uneasy under the charge of the young prince, was solicitous to make himself strong, that he might guard him from injury. Motives so patriotic and honourable drew applause and partizans. It was sufficient to mention them. By private conference and debate, an association was insensibly formed to punish the murderers of the king, and to protect the person of the prince. Morton and Lethington encouraged and promoted a combination from which they might derive so much advantage. A convention accordingly was appointed at Stirling, for the purpose of consulting upon the measures which it was most expedient to pursue. They agreed to take an early opportunity to appear in the field; and when they separated, it was to collect their retainers, and to inspire their passions.

Of this confederacy, the leading men were the earls of Argyle, Athol, Morton, Marre, and Glencairn; the lords Hume, Semple, and Lindsay; the barons Kirkcaldy of Grange, Murray of Tullibardin, and Maitland of Lethington. The earl of Bothwel was sensible, that if he was to sit upon a throne, he must wade to it through blood. By his advice, two proclamations were issued in the name of the queen, under the pretence of suppressing insurrections and depredations upon the borders. By the former, she called together in arms, upon an early day, the earls, barons, and freeholders of the districts of Forfar and Perth, Strathern and Menteith, Clackmannan, Kinross, and Fife. By the latter she charged the greater and lesser baronage, with all the inferior proprietors of the shires of Linlithgow and Edinburgh, and the constabulary of Haddington and Berwick, to prepare immediately for war, and to keep themselves in readiness to march upon her order. These military preparations admonished the association to be firm and active, and added to the public inquietudes and discontents. The rumours against the queen were most violent and loud. It was said, that she meant to

over-

hand. Some of her subjects might still have sought that honour; but her compliance would have been humiliating beyond measure. It would have left her at the mercy of a capricious husband; it would have exposed her to the disgrace of being reproached, in some sullen hour, for the adventure at Dunbar. Mary was so situated, at this critical period, that she was reduced to this horrid alternative, either to remain in a friendless and hazardous celibacy, or to yield her hand to Bothwel." Remarks on the History of Scotland, p. 204.

*Scotland.* to overturn the constitution and the laws; that she had been careless of the health of her son, and was altogether indifferent about his preservation; that she had separated herself from the councils and assistance of her nobles; and that she wished to make her whim or discretion the only rule of her government. Agitated with the hazardous state of her affairs, she published a new proclamation, in which she employed herself to refute these accusations; and in which she took the opportunity to express, in a very forcible manner, not only her attachment to her people and the laws, but the fond affection that she bore to the prince, whom she considered as the chief joy of her life, and without whom all her days would be comfortless.

The declarations of the queen were treated with scorn. The nobles, abounding in vassals, and having the hearts of the people, were soon in a situation to take the field. They were advancing to the capital. The royal army was not yet assembled; and the queen and Bothwel suspected that the castle of Edinburgh would shut its gates upon them. The fidelity of Sir James Balfour the deputy-governor had been staggered by the practices of the earl of Marre and Sir James Melvil. Mary left her palace of Holyroodhouse, and was conducted to Borthwick castle. The associated lords, informed of her flight, took the road to this fortress with 2000 horse. The lord Hume, by a rapid march, presented himself before it with the division under his command: but being unable to guard all its avenues, the queen and Bothwel effected their escape to Dunbar; where the strength of the fortifications gave them a full security against a surprize.

Upon this second disappointment, the nobles resolved to enter Edinburgh, and to augment the strength by new partizans. The earl of Huntley and the lord Boyd were here on the side of the queen, with the archbishop of St Andrew's, the bishop of Rois, and the abbot of Kilwinning. They endeavoured to animate the inhabitants to defend their town and the cause of their sovereign. But the tide of popularity was favourable to the confederated lords. The magistrates ordered the gates of the city to be shut; but no farther resistance was intended. The lords, forcing St Mary's port, found an easy admittance, and took possession of the capital. The earl of Huntley and the queen's friends fled to the castle, to Sir James Balfour, who had been the confident of Bothwel, and who agreed to protect them, although he was now concluding a treaty with the insurgents.

The associated lords now formed themselves into a council, and circulated a proclamation. By this paper they declared, that the queen being detained in captivity, was neither able to govern her realm, nor to command a proper trial to be taken of the king's murder. In an emergency so pressing, they had not despaired of their country; but were determined to deliver the queen from bondage, to protect the person of the prince, to revenge the murder of the king, and to vindicate the nation from the infamy it had hitherto suffered through the impunity of the regicides. They therefore commanded in general all the subjects of Scotland whatsoever, and the burghesses and inhabitants of Edinburgh in particular, to take a part with them, and to join in the advancement of purposes so beneficial and salutary. The day after they had published this proclamation,

they issued another in terms that were stronger and more resolute. They definitively expressed their persuasion of Bothwel's guilt in the rape and seduction of the queen, and in his perpetration of the king's murder, in order to accomplish his marriage. They inculcated it as their firm opinion, that Bothwel was now instigated with a design to murder the young prince, and that he was collecting troops with this view. Addressing themselves, therefore, to all the subjects of the realm, whether they resided in counties or in boroughs, they invited them to come forward to their standard; and desired them to remember, that all persons who should presume to disobey them should be treated as enemies and traitors.

Bothwel, in the mean time, was not inactive; and the proclamations of the queen had brought many of her vassals to her assistance. Four thousand combatants ranged themselves on her side. This force might augment as she approached to her capital; and Bothwel was impatient to put his fortunes to the issue of a battle. He left the strong castle of Dunbar, where the nobles were not prepared to assail him, and where he might have remained in safety till they dispersed themselves. For their proclamations were not so successful as they had expected; their provisions and stores were scanty; and the zeal of the common people, unsupported by prosperity, would soon have abated. Impudent precipitation served them in a most effectual manner. When the queen had reached Gladsmuir, she ordered a manifesto to be read to her army, and to be circulated among her subjects. By this paper, she replied to the proclamations of the confederated nobles, and charged them with treachery and rebellion. She treated their reasons of hostility as mere pretences, and as inventions which could not bear to be examined. As to the king's murder, she protested, that she herself was fully determined to revenge it, if she could be so fortunate as to discover its perpetrators. With regard to the bondage from which they were so desirous to relieve her, she observed, that it was a falsehood so notorious, that the simplest of her subjects could confute it; for her marriage had been celebrated in a public manner, and the nobles could hardly have forgotten that they had subscribed a bond recommending Bothwel to be her husband. With regard to the industrious defamations of this nobleman, it was urged, that he had discovered the utmost sollicitude to establish his innocence. He had invited a scrutiny into his guilt; the justice of his country had absolved him; the three estates assembled in parliament were satisfied with the proceedings of his judges and jury; and he had offered to maintain his quarrel against any person whatsoever who was equal to him in rank and of an honest reputation. The nobles, she said, to give a fair appearance to their treason, pretended, that Bothwel had schemed the destruction of the prince, and that they were in arms to protect him. The prince, however, was actually in their own custody; the use they made of him was that of a screen to their perfidiously; and the real purposes with which they were animated, were the overthrow of her greatness, the ruin of her posterity, and the usurpation of the royal authority. She therefore intreated the aid of her faithful subjects; and as the prize of their valorous service, she held out to them the estates and possessions of the rebels.

687  
But is obliged to Dunbar.

688  
Proclamation by the rebellious nobles.

689  
Manifesto by the queen.

Scotland. The associated nobles, pleased at the approach of the queen, put themselves in motion. In the city of Edinburgh they had gathered an addition to their force; and it happened that the Scottish officer who commanded the companies, which, in this period, the king of Denmark was permitted to enlist in Scotland, had been gained to assist them. He had just completed his levies; and he turned them against the queen. The nobles, after advancing to Musselburgh, refreshed their troops. Intelligence was brought that the queen was upon her march. The two armies were nearly equal in numbers; but the preference, in point of valour and discipline, belonged decisively to the soldiers of the nobles. The queen posted herself on the top of Carberry hill. The lords, taking a circuit to humour the ground, seemed to be retreating to Dalkeith; but wheeling about, they approached to give her battle. They were ranged in two divisions. The one was commanded by the earl of Morton and the lord Hume. The other was directed by the earls of Athol, Marre, and Glencairn, with the lords Lindsay, Ruthven, Sempil, and Sanguhar. Bothwel was the leader of the royal forces; and there served under him the lords Seton, Yester, and Borthwick.

690  
he two  
nic- p-  
each  
ch other.

691  
u Croc  
g. dia'es  
h the  
bels.

It was not without apprehensions that Mary surveyed the formidable appearance of her enemies. Du Croc, the French ambassador, hastened to interpose his good offices, and to attempt an accommodation. He assured the nobles of the peaceful inclinations of the queen; and that the generosity of her nature disposed her not only to forgive their present insurrection, but to forget all their former transgressions. The earl of Morton informed him, that they had not armed themselves against the queen, but against the murderer of the late king; and that if she would surrender him up to them, or command him to leave her, they would consent to return to their duty. The earl of Glencairn desired him to observe, that the extremity to which they had proceeded might have instructed him that they meant not to ask pardon for any offences they had committed, but that they were resolved to take cognizance of injuries which had provoked their displeasure. This aspiring language confounded Du Croc, who had been accustomed to the worshipful submissions that are paid to a despot. He conceived that all negotiation was fruitless, and withdrew from the field in the expectation that the sword would immediately give its law and determine every difference.

Mary was full of perturbation and distress. The state into which she had been brought by Bothwel did not fail to engage her serious reflection. It was with infinite regret that she considered the consequences of her situation at Dunbar. Nor had his behaviour since her marriage contributed to allay her inquietudes. The violence of his passions, his suspicions, and his guilt, had induced him to surround her with his creatures, and to treat her with insult and indignity. She had been almost constantly in tears. His demeanor, which was generally rude and indecent, was often savage and brutal. At different times his provocations were so insulting, that she had even attempted to arm her hand against her life, and was desirous to relieve her wretchedness by spilling her blood. Upon his account, she was now encompassed with dangers. Her crown was in hazard. Under unhappy agitations, she rode through the ranks

of her army, and found her soldiers dispirited. Whatever respect they might entertain for her, they had none for her husband. His own retainers and dependents only were willing to fight for him. He endeavoured to awaken the royal army to valour, by throwing down the gauntlet of defiance against any of his adversaries who should dare to encounter him. His challenge was instantly accepted by Kirkaldy of Grange, and by Murray of Tullibardin. He objected that they were not peers. The lord Lindisay discovered the greatest impatience to engage him, and his offer was admitted; but the queen interposing her prerogative, prohibited the combat. All the pride and hopes of Bothwel sunk within him. His soldiers in small parties were secretly abandoning their standards. It was equally perilous to the queen to fight or to fly. The most prudent expedient for her was to capitulate. She desired to confer with Kirkaldy of Grange, who remonstrated to her against the guilt and wickedness of Bothwel, and counselled her to abandon him. She expressed her willingness to dismiss him upon the condition that the lords would acknowledge their allegiance and continue in it. Kirkaldy passed to the nobles, and received their authority to assure her that they would honour, serve, and obey her as their princess and sovereign. He communicated this intelligence to her. She advised Bothwel to provide for his safety by flight; and Kirkaldy admonished him not to neglect this opportunity of effecting his escape. Overwhelmed with shame, disappointment, terror, remorse, and despair, this miserable victim of ambition and guilt turned his eyes to her for the last time. To Kirkaldy of Grange she stretched out her hand: he kissed it; and taking the bridle of her horse, conducted her towards the nobles. They were approaching her with becoming reverence. She said to them, "I am come, my lords, to express my respect, and to conclude our agreement; I am ready to be instructed by the wisdom of your counsels; and I am confident that you will treat me as your sovereign." The earl of Morton, in the name of the confederacy, ratified their promises, and addressed her in these words: "Madam, you are here among us in your proper place; and we will pay to you as much honour, service, and obedience, as ever in any former period was offered by the nobility to the princes your predecessors."

This gleam of sunshine was soon overcast. She remained not many hours in the camp, till the common soldiers, instigated by her enemies, presumed to insult her with the most unseemly reproaches. They exclaimed indignantly against her as the murderer of her husband. They reviled her as a lewd adulteress in the most open manner, and in a language the most coarse and the most opprobrious. The nobility forgot their promises, and seemed to have neither honour nor humanity. She had changed one miserable scene for a distress that was deeper and more hopeless. They surrounded her with guards, and conducted her to her capital. She was carried along its streets, and shown to her people in captivity and sadness. She cried out to them to commiserate and protect her. They withheld their pity, and afforded her no protection. Even new insults were offered to her. The lowest of the populace, whom the declamations of the clergy had driven into rage and madness, vied with the soldiery in the li-

Scotland,

692  
Bot'wel  
challenged  
to single  
combat.693  
He is obli-  
ged to fly.694  
Mary sur-  
renders  
herself to  
the rebels,695  
By whom  
she is cruel-  
ly used.

centious

Scotland. centious outrage of invective and execration. She sought Maitland to solicit the lords to repress the insupportable atrocity of her treatment. She conjured him to let them know, that she would submit herself implicitly to the determination of the parliament. Her intreaties and her sufferings made no impression upon the nobles. They continued the savage cruelty of their demeanour. She implored, as the last request she would prefer to them, that they would lead her to her palace. This consolation, too, was refused to her. They wished to accustom her subjects to behold her in disgrace, and to teach them to triumph over her misfortunes. In the most mortifying and afflicting hour she had ever experienced, oppressed with fatigue, and disfigured with dust and sorrow, they shut her up in the house of the lord provost: leaving her to revolve in her anxious and agitated mind the indignities she had already endured, and to suffer in anticipation the calamities they might yet inflict upon her.

The malice of Morton and his adherents was still far from being gratified. In the morning, when the queen looked from the window of the apartment to which she had been confined, she perceived a white banner displayed in such a manner as to fix her attention. There was delineated upon it the body of the late king stretched at the foot of a tree, and the prince upon his knees before it, with a label from his mouth, containing this prayer, "Judge and revenge my cause, O Lord!" This abominable banner revived all the bitterness of her afflictions. The curiosity of the people drew them to a scene so new and so affecting. She exclaimed against the treachery of her nobles; and she begged the spectators to relieve her from their tyranny. The eventful story of the preceding day had thrown her capital into a ferment. The citizens of a better condition crowded to behold the degraded majesty of their sovereign. Her state of humiliation, so opposite to the grandeur from which she had fallen, moved them with compassion and sympathy. They heard her tale, and were filled with indignation. Her lamentations, her disorder, her beauty, all stimulated their ardour for her deliverance. It was announced to the nobles, that the tide of popular favour had turned towards the queen. They hastened to appear before her, and to assure her, with smiles and courtesy, that they were immediately to conduct her to her palace, and to reinstate her in her royalty. Imposing upon her credulous na-

ture, and that beautiful humanity which characterized her even in the most melancholy situations of her life, they prevailed with her to inform the people, that she was pacified, and that she wished them to disperse themselves. They separated in obedience to her desire. The nobles now conveyed her to Holyroodhouse. But nothing could be farther from their intentions than her re-establishment in liberty and grandeur. They held a council, in which they deliberated concerning the manner in which they ought to dispose of her. It was resolved, that she should be confined during her life in the fortrefs of Lochleven; and they subscribed an order for her commitment.

A resolution so sudden, so perfidious, and so tyrannical, filled Mary with the utmost astonishment, and drew from her the most bitter complaints and exclamations. Kirkaldy of Grange, perceiving with surprise the lengths to which the nobles had proceeded, felt his honour take the alarm for the part he had acted at their desire. He expostulated with them upon their breach of trust, and censured the extreme rigour of the queen's treatment. They counselled him to rely upon the integrity of their motives; spoke of her passion for Bothwell as most vehement, and insisted upon the danger of intrusting her with power. He was not convinced by their speeches; and earnestly recommended lenient and moderate measures. Discreet admonitions, he said, could not fail of impressing her with a full sense of the hazards and inconveniences of an improper passion, and a little time would cure her of it. They assured him, that when it appeared that she detested Bothwell, and had utterly abandoned his interests, they would think of kindness and moderation. But this, they urged, could hardly be expected; for they had recently intercepted a letter from her to this nobleman, in which she expressed, in the strongest terms, the warmth of her love, and her fixed purpose never to forsake him (r). Kirkaldy was desired to peruse this letter; and he pressed them no longer with his remonstrances. The queen, in the mean time, sent a message to this generous soldier, complaining of the cruelty of her nobles, and reminding him that they had violated their engagements. He instantly addressed an answer to it, recounting the reproaches he had made to them; stating his advice; describing the surprise with which he had read her intercepted letter; and conjuring her to renounce and forget a most wicked and flagitious man, and, by this victory over herself, to regain the love and respect of her

696  
The common people  
take her  
part;

Scotland.  
697  
But by the  
advice of  
the nobles,  
she desists  
from them.

698  
She is de-  
fended by  
Kirkaldy  
of Grange;

699  
But he is  
silenced by  
a forecry  
of the no-  
bles.

(r) "Mr Hume is candid enough to give up the authenticity of this letter; and indeed, so far as I have observed, there is not the slightest pretence of a reason for conceiving it to be genuine; (*Hist. of England*, Vol. V. p. 120.) It was not mentioned by the earl of Morton and his adherents to Throgmorton, when Elizabeth interfered in the affairs of Scotland upon the imprisonment of the queen in the castle of Lochleven: a period of time when these statesmen were desirous to throw out every imputation to her prejudice, and when in particular they were abusing her with vehemence for her attachment to Bothwell; (*Keith*, p. 419.) Nor was it made use of by Murray before the English commissioners. Mary, in the condition to which the nobles had reduced her, could not well think of a step of this sort, although her attachment to Bothwell had been as strong as they were pleased to pronounce it. For, not to speak of the greatness of her distress, she was guarded by them so strictly, as to make it vain for her to pretend to elude their vigilance. In regard, too, to her love of Bothwell, it is not clear that it was ever real. While the king was alive, there are no traces of their improper intercourse. The affair of Dunbar was a criminal seduction. The arts of a profligate man overcame her. There was no sentiment of love upon either side. After her marriage, his rudeness extinguished in her altogether any remnant of kindness and respect; and hence the coldness with which she parted with him." *Stuart's History of Scotland*, Vol. 1. p. 253. note.



her subjects. The device of a letter from her to Bothwell completed the amazement of the queen. So unprincipled a contempt of every thing that is most sacred, so barbarous a perseverance in perfidiousness and injustice, extinguished every sentiment of hope in her bosom. She conceived that she was doomed to inevitable destruction, and sunk under a pang of unutterable anguish.

The Lords Ruthven and Lindsay arrived in this paroxysm of her distress, to inform her, that they were commanded to put in execution the order for her commitment. They charged her women to take from her all her ornaments and her royal attire. A mean dress was put upon her; and in this disguise they conveyed her with precipitation to the prison appointed for her. The Lords Seton, Yester, and Borthwick, endeavoured to rescue her, but failed in the attempt. She was delivered over to William Douglas the governor of the castle of Lochleven, who had married the mother of the earl of Murray, and was himself nearly related to the earl of Mortou. See MARY.

Upon the same day on which the nobles subscribed the order for the imprisonment of the queen, they entered into a bond of concurrence or confederacy. By this deed they bound and cemented themselves into a body for the strenuous prosecution of their quarrel; and it detailed the purposes which they were to forward and pursue. They proposed to punish the murderers of the king, to examine into the queen's rape, to dissolve her marriage, to preserve her from the bondage of Bothwel, to protect the person of the prince, and to restore justice to the realm. The sanction of a most solemn oath confirmed their reliance upon one another; and in advancing their measures, they engaged to expose and employ their lives, kindred, and fortunes.

It is easy to see, notwithstanding all the pretended patriotism of the rebels, that nothing was farther from their intentions than to prosecute Bothwel and restore the queen to her dignity. They had already treated her in the vilest manner, and allowed Bothwel to escape when they might easily have apprehended and brought him to any trial they thought proper. To exalt themselves was their only aim. Eleven days after the capitulation at Carberry hill, they held a convention, in which they very properly assumed the name of *lords of the secret council*, and issued a proclamation for apprehending Bothwel as the murderer of the king; offering a reward of 1000 crowns to any person who should bring him to Edinburgh. A search had been made for the murderers of the king that very night in which the queen was confined in Lochleven castle. One Sebastian a Frenchman, and captain Blackader, were then apprehended; and soon after James Edmondstone, John Blackader, and Mynart Fraser, were taken up and imprisoned. The people expected full and satisfactory proofs of the guilt of Bothwel, but were disappointed. The affirmation of the nobles, that they were possessed of evidence which could condemn him, appeared to be no better than a pretence or artifice. Sebastian found means to escape; the other persons were put to the torture, and sustained it without making any confession that the nobles could publish. They were condemned, however, and executed, as being concerned in the murder. In their dying moments they protested their innocence.

VOL. XVII. Part I.

A sanguine hope was entertained that captain Blackader would reveal the whole secret at the place of execution, and a vast multitude of spectators were present. No information, however, could be derived from what he said with regard to the regicides; but while he solemnly protested that his life was unjustly taken away, he averred it as his belief that the earls of Murray and Morton were the contrivers of the king's murder.

The lords of the secret council now proceeded to the greatest enormities. They robbed the palace of Holyroodhouse of its furniture and decorations; converted the queen's plate into coin; and possessed themselves of her jewels, which were of great value; and while the faction at large committed these acts of robbery, the earl of Glencairn with solemn hypocrisy demolished the altar in the queen's chapel, and defaced and destroyed all its pictures and ornaments. These excessive outrages, however, lost them the favour of the people, and an association was formed in favour of the queen. The court of France, as soon as the news of Mary's imprisonment arrived, dispatched M. de Villeroy to condole with her upon her misfortunes: but the lords of the secret council would not admit him to see her, upon which he immediately returned to his own country. The earl of Murray, however, was at this time in France; and to the promises of this ambitious and treacherous wretch the king trusted, imagining him to be a steady friend to the unfortunate queen. Elizabeth also pretended friendship, and threatened the associated lords; but as they had every reason to doubt her sincerity, they paid no regard to her threats, and even refused to admit her ambassador to Mary's presence.

From all these appearances of friendship Mary neither did nor could derive any real assistance. On the 24th of July 1567, the lord Lindsay, whose imperious behaviour, says Dr Stuart, approached to insanity, was ordered by the lords to wait upon the queen at Lochleven. He carried with him three deeds or instruments, and was instructed not to be sparing in rudeness and menaces in order to compel her to subscribe them. By the first, she was to resign her crown to her infant-son; by the second, she appointed the earl of Murray regent of Scotland; and by the third, she constituted a council to direct the prince till this nobleman should arrive in Scotland, or in the event of his death or refusal of the office. On the part of the queen all resistance was vain. Sir Robert Melvil assured her, that her best friends were of opinion, that what she did by compulsion, and in a prison, could have no power to bind her; and of this she was also assured by Throgmorton, the English ambassador, in a letter which Sir Robert Melvil brought in the scabbard of his sword. Mary therefore, forlorn and helpless, could not resist the barbarous rudeness with which Lindsay pressed the subscription of the papers, though she would not read them. Five days after, the lords of the secret council met at Stirling, for the coronation of the young prince, and considered themselves as representing the three estates of the kingdom. A protestation was made in the name of the duke of Chatelleraut, that this solemnity should neither prejudice his rights of succession nor those of the other princes of the blood. The young prince being presented to them, the lords Lindsay and Ruthven appeared, and in the name of the queen renounced in his favour her right and title to the crown, gave up the

Scotland.

703  
But they  
make no  
confession.

704  
Robberies  
and out-  
rages of the  
confederated  
lords.

705  
Mary com-  
pelled to  
sign a re-  
signation  
of her  
crown.

706  
Coronation  
of James  
VI.

Scotland. papers she had subscribed, and surrendered the sword, sceptre, and royal crown. After the papers were read, the earls of Morton, Athol, Glencairn, Marre, and Menteith, with the master of Graham, the lord Hume, and Bothwel bishop of Orkney, received the queen's resignation in favour of her son in the name of the three estates. After this formality, the earl of Morton, bending his body, and laying his hand upon the Scriptures, took the coronation-oath for the prince, engaging that he should rule according to the laws, and root out all heretics and enemies to the word of God. Adam Bothwel then anointed the prince king of Scotland; a ceremony with which John Knox was displeas'd, as believing it to be of Jewish invention. This prelate next delivered to him the sword and the sceptre, and finally put the crown upon his head. In the procession to the castle from the church, where the inauguration was performed, and where John Knox preached the inauguration sermon, the earl of Athol carried the crown, Morton the sceptre, Glencairn the sword, and the earl of Marre carried the prince in his arms. These solemnities received no countenance from Elizabeth; and Throgmorton, by her express command, was not present at them.

707  
Disappro-  
ved by  
Elizabeth.

708  
Murray re-  
turns from  
France.

709  
He pays a  
visit to the  
queen at  
Lochleven,

Soon after this ceremony, the earl of Murray returned from France; and his presence gave such a strength and firmness to his faction, that very little opposition could be given by the partisans of Mary, who were unsettled and desponding for want of a leader. A little time after his arrival, this monstrous hypocrite and traitor waited upon his distressed and insulted sovereign at Lochleven. His design was to get her to desire him to accept of the regency, which he otherwise pretended to decline. The queen, unsuspecting of the deepness of his arts, conscious of the gratitude he owed to her, and trusting to his natural affection, and their tie of a common father, received him with a tender welcome. She was in haste to pour forth her soul to him; and with tears and lamentations related her condition and her sufferings. He heard her with attention: and turned occasionally his discourse to the topics which might lead her to open to him her mind without disguise in those situations in which he was most anxious to observe it. His eye and his penetration were fully employed; but her distress awakened not his tenderness. He seemed to be in suspense; and from the guardedness of his conversation she could gather neither hope nor fear. She begged him to be free with her, as he was her only friend. He yielded to her intreaties as if with pain and reluctance; and taking a comprehensive survey of her conduct, described it with all the severity that could affect her most. He could discover no apology for her misgovernment and disorders; and, with a mortifying plainness, he pressed upon her conscience and her honour. At times she wept bitterly. Some errors she confessed; and against calumnies she warmly vindicated herself. But all she could urge in her behalf made no impression upon him; and he spoke to her of the mercy of God as her chief refuge. She was torn with apprehensions, and nearly distracted with despair. He dropped some words of consolation; and after expressing an attachment to her interests, gave her his promise to employ all his consequence to secure her life. As to her liberty, he told her, that to achieve it was beyond all his efforts; and that it was not good for her

to desire it. Starting from her seat, she took him in her arms, and kissing him as her deliverer from the scaffold, solicited his immediate acceptance of the regency. He declared he had many reasons to refuse the regency. She implored and conjured him not to abandon her in the extremity of her wretchedness. There was no other method, she said, by which she herself could be saved, her son protected, and her realm rightly governed. He gave way to her anxiety and solicitations. She besought him to make the most unbounded use of her name and authority, desired him to keep for her the jewels that yet remained with her, and recommended it to him to get an early possession of all the forts of her kingdom. He now took his leave of her, and embracing anew this pious traitor, she sent her blessing with him to the prince her son.

In the mean time the wretched earl of Bothwel was struggling with the greatest difficulties. Sir William Murray and Kirkaldy of Grange had put to sea in search of him. He had been obliged to exercise piracy in order to subsist himself and his followers. His pursuers came upon him unexpectedly at the Orkney islands, and took three of his ships; but he himself made his escape. Soon after, having seized a Turkish trader on the coast of Norway, two ships of war belonging to the king of Denmark gave chase to him as a pirate. An engagement ensued, in which Bothwel was taken. His officers and mariners were hanged in Denmark; but Bothwel himself, being known by some Scottish merchants, had his life spared. He was thrown, however, into a dungeon, where he remained ten years; and at last died melancholy and distracted. The regent sent commissioners to the king of Denmark to demand him as a prisoner; but that prince, considering him as a traitor and usurper, totally disregarded his request.

The dreadful fate of Bothwel did not make any alteration in the situation of the queen. Her enemies, bent on calumniating her, produced letters, which they said were written and sent by her to that licentious nobleman during the life of the king. These letters are now universally admitted to have been forged by the rebels themselves, who practised likewise upon some servants of Bothwel to accuse the queen of the murder of her husband. The letters for some time gained credit; but the confessions of the servants were all in her favour. When on the scaffold, they addressed themselves to the people; and after having solemnly declared the innocence of the queen, they protested before God and his angels, that the earl of Bothwel had informed them that the earls of Murray and Morton were the contrivers of the king's murder.

It was impossible that such transactions as these could advance the popularity of the regent. His unbounded ambition and cruelty to his sovereign began at last to open the eyes of the nation; and a party was forming itself in favour of the queen. She herself had been often meditating her escape from her prison; and she at last effected it by means of a young gentleman George Douglas, brother to her keeper, who had fallen in love with her. On the 2d day of May 1568, about seven o'clock in the evening, when her keeper was at supper with his family, George Douglas, possessing himself of the keys of the castle, hastened to her apartment, and conducted her out of prison. Having locked the gates

Scotland.  
710  
And in-  
duces her  
to press  
him to ac-  
cept of the  
regency.

711  
Miserable  
fate of  
Bothwel.

712  
Letters  
forged  
between  
Mary and  
Bothwel.

713  
Servants of  
Bothwel  
executed,  
who declar-  
ed the inno-  
cence of the  
queen.

714  
The queen  
escapes  
from pri-  
son.

Scotland. of the castle, they immediately entered a boat which waited for them; and being rowed across the lake, the lord Seton received the queen with a chosen band of horsemen in complete armour. That night he conveyed her to his house of Niddrie in West Lothian; where having rested a few hours, she set out for Hamilton.

The escape of the queen threw her enemies into the greatest consternation. Many forsook the regent openly; and still more made their submissions privately, or concealed themselves. He did not, however, despond; but resolved to defend himself by force of arms. The queen soon found herself at the head of 6000 men, and the regent opposed her with 4000. Mary, however, did not think it proper to risk a battle; knowing the capacity of the regent as a general, and that his officers were all men of approved valour and experience. But in this prudent resolution she was over-ruled by the impetuosity of her troops. A battle was fought on the 13th of May 1568, at Langside near Glasgow; in which Mary's army was defeated, and her last hopes blasted. The unfortunate queen fled towards Kirkcudbright; where finding a place of safety, she deliberated on the plan she should afterwards follow. The result of her deliberations, as frequently happens in cases of perplexity, led her to take the worst step possible. Notwithstanding all the perfidy which she had found in Elizabeth, Mary could not think that she would now refuse to afford her a refuge in her dominions; and therefore determined to retire into England. To this she had been solicited by Elizabeth herself during her confinement in Lochleven castle; and she now resolved, in opposition to the advice of her most faithful counsellors, to make the fatal experiment.

In obedience to her order, the lord Herries addressed a letter to Mr Lander, the deputy-commander at Carlisle; and after detailing her defeat at Langside, desired to know if she might trust herself upon English ground. This officer wrote instantly an answer, in which he said, that the lord Serp the warden of the frontiers being absent, he could not of his private authority give a formal assurance in a matter which concerned the state of a queen: but that he would send by post to his court to know the pleasure of his sovereign; and that if in the mean time any necessity should force Mary to Carlisle, he would receive her with joy, and protect her against her enemies. Mary, however, before the messenger could return, had embarked in a fishing boat with sixteen attendants. In a few hours she landed at Wirkington in Cumberland; and from thence she proceeded to Cockermouth, where she continued till Mr Lander, having assembled the gentlemen of the country, conducted her with the greatest respect to the castle of Carlisle.

To Elizabeth she announced her arrival in a dispatch, which described her late misfortunes in general and pathetic terms, and in which she expressed an earnest solicitude to pay her a visit at her court, and the deep sense she entertained of her friendship and generosity. The queen of England, by obliging and polite letters, condoled with her upon her situation, and gave her assurances of all the favour and protection that were due to the justice of her cause. But as they were not accompanied with an invitation to London, Mary took the alarm. She thought it expedient to instruct lord

Fleming to repair to France; and she intrusted lord Herries with a most pressing remonstrance to Elizabeth. Her anxiety for an interview in order to vindicate her conduct, her ability to do so in the most satisfactory manner, and her power to explain the ingratitude, the crimes, and the perfidy of her enemies, were urged to this princess. A delay in the state of her affairs was represented as nearly equivalent to absolute destruction. An immediate proof was therefore requested from Elizabeth of the sincerity of her professions. If she was unwilling to admit into her presence a queen, a relation, and a friend, she was reminded, that as Mary's entrance into her dominions had been voluntary, her departure ought to be equally free and unrestrained. She valued the protection of the queen of England above that of every other potentate upon earth; but if it could not be granted, she would solicit the amity, and implore the aid, of powers who would commiserate her afflictions, and be forward to relieve them. Amidst remonstrances, however, which were so just and so natural, Mary failed not to give thanks to Elizabeth for the courtesy with which she had hitherto been treated in the castle of Carlisle. She took the opportunity also to beg of this princess to avert the cruelty of the regent from her adherents, and to engage him not to waste her kingdom with hostility and ravages; and she had the prudence to pay her compliments in an affectionate letter to secretary Cecil, and to court his kind offices in extricating her from her difficulties and troubles.

But the queen of England was not to be moved by remonstrances. The voluntary offer of Mary to plead her cause in the presence of Elizabeth, and to satisfy all her scruples, was rejected. Her disasters were rather a matter of exultation than of pity. The deliberations of the English queen, and those of her statesmen, were not directed by maxims of equity, of compassion, or of generosity. They considered the flight of Mary into England as an incident that was fortunate and favourable to them; and they were solicitous to adopt those measures which would enable them to draw from it the greatest profit and advantage. If the queens of Scots were allowed to return to her own dominions, it was probable that she would soon be in a condition to destroy the earl of Murray and his faction, who were the friends of England. The house of Hamilton, who were now zealous in the interests of France, would rise into consideration and power. England would be kept in perpetual turmoils upon the frontiers; Ireland would receive molestation from the Scots, and its disturbances grow important and dangerous. Mary would renew with redoubled ardour her designs against the Protestant religion; and a French army would again be introduced into Scotland. For these reasons, Elizabeth and her ministers determining not to restore the queen of Scots to her throne, considered what would be the probable consequences of permitting her to remain at liberty in England. In this situation, she would augment the number of her partizans, send to every quarter her emissaries, and inculcate her title to the crown. Foreign ambassadors would afford her aid, and take a share in her intrigues; and Scotland, where there was so high an object to be gained, would enter with cordiality into her views. This plan being also hazardous, it was deliberated whether the

Scotland.  
745  
And presses  
her for an  
interview.

727  
Delibera-  
tions of  
Elizabeth  
and her  
statesmen  
concerning  
Mary.

Scotland.

queen of Scots might not be allowed to take a voyage into France. But all the pretensions which had hitherto threatened the crown of Elizabeth would in this case be revived. A strong resentment to her would even urge Mary and Charles IX. to the boldest and most desperate enterprizes. The party of the queen of Scots in England, strong from motives of religion and affection, and from discontents and the love of change, would stimulate their anger and ambition. England had now no territories in France. A war with that country and with Scotland would involve the greatest dangers. Upon revolving these measures and topics, Elizabeth and her counsellors were induced to conclude, that it was by far the wisest expedient to keep the queen of Scots in confinement, to invent methods to augment her distress, to give countenance to the regent, and to hold her kingdom in dependence and subjection.

722  
They resolve to confine her for life.

723  
Elizabeth refuses to admit the queen into her presence.

In consequence of this cruel and unjust resolution, Mary was acquainted, that she could not be admitted into Elizabeth's presence till she had cleared herself of the crimes imputed to her; she was warned not to think of introducing French troops into Scotland; and it was hinted, that for the more security she ought to be removed farther from the frontier. This message at once showed Mary the imprudence of her conduct in trusting herself to Elizabeth. But the error could not now be remedied. She was watched to prevent her escape, and all her remonstrances were vain. The earl of Murray had offered to accuse her; and it was at last concluded that Elizabeth could not, consistently with her own honour and the tranquillity of her government, suffer the queen of Scots to come into her presence, to depart out of England, or to be restored to her dignity, till her cause should be tried and decided. An order was given to remove her from Carlisle castle to a place of strength at a greater distance from the borders, to confine her more closely, and to guard against all possibility of an escape.

724  
Mary is removed from Carlisle, and closely guarded.

In consequence of these extraordinary transactions, a trial took place, perhaps the most remarkable for its injustice and partiality of any recorded in history. Mary, confined and apprehensive, submitted to be tried as they thought proper. The regent, who was to be the accuser, was summoned into England, and commissioners were appointed on both sides. On the 4th of October, the commissioners met at York; and four days after, the deputies of the queen of Scots were called to make known their complaints. They related the most material circumstances of the cruel usage she had received. Their accusations were an alarming introduction to the business in which the regent had embarked; and notwithstanding the encouragement shown to him by Elizabeth, he was assaulted by apprehensions. The artifices of Maitland added to his alarms. Instead of proceeding instantly to defend himself, or to accuse the queen, he sought permission to relate his doubts and scruples to the English commissioners. In his own name, and with the concurrence of his associates, he demanded to know whether they had sufficient authority from Elizabeth to pronounce, in the case of the murder, guilty or not guilty, according to the evidence that should be laid before them; whether they would actually exercise this power; whether, in the event of her criminality, their sovereign should be deli-

725  
Commissioners for her trial meet at York.

726  
Infamous behaviour of Murray.

vered to him and his friends, or detained in England in such a way as that no danger should ensue from her activity; and whether, upon her conviction, the queen of England would allow his proceedings, and those of his party, to be proper, maintain the government of the young king, and support him in the regency in the terms of the act of parliament which had confirmed him in that office. To these requisitions, it was answered, upon the part of the English deputies, that their commission was so ample, that they could enter into and proceed with the controversy; and that they had liberty to declare, that their sovereign would not restore the queen of Scots to her crown, if satisfactory proofs of her crime should be produced; but that they knew not, and were not instructed to say, in what manner she would finally conduct herself as to her person and punishment. With regard to the sovereignty of the prince, and the regency of the earl of Murray, they were points, they observed, which might be canvassed in a future period. These replies did not please the regent and his associates; and they requested the English commissioners to transmit their doubts and scruples to be examined and answered by Elizabeth.

Scotland.

But while the regent discovered in this manner his apprehensions, he yet affirmed that he was able to answer the charges imputed to him and his faction; and this being in a great measure a distinct matter from the controversy of the murder, he was desired to proceed in it. It was contended, that Bothwell, who had the chief concern in the murder of lord Darnley, possessed such credit with the queen, that within three months after that horrible event, he seized her person and led her captive to Dunbar, obtained a divorce from his wife, and married her: that the nobility, being moved with his crimes, did confederate to punish him; to relieve her from the tyranny of a man who had ravished her, and who could not be her husband; and to preserve the life of the prince: that having taken arms for these purposes, the earl marched against them; but that, proposing to decide the quarrel by single combat, his challenge was accepted: that he declined, notwithstanding, to enter the lists, and fled: that the queen, preferring his impunity to her own honour, favoured his escape by going over to the nobility: that they conducted her to Edinburgh, where they informed her of the motives of their proceedings, requested her to take the proper steps against him and the other regicides, and intreated her to dissolve her pretended marriage, to take care of her son, and to consult the tranquillity of her realm: that this treatment being offensive to her, she menaced them with vengeance, and offered to surrender her crown if they would permit her to possess the murderer of her husband: that her inflexible mind, and the necessities of the state, compelled them to keep her at a distance from him, and out of the way of a communication with his adherents: that during her confinement, finding herself fatigued with the troubles of royalty, and unfit for them from vexation of spirit and the weakness of her body and intellect, she freely and of her own will resigned her crown to her son, and constituted the earl of Murray to the regency; that the king accordingly had been crowned, and Murray admitted to the regency; that the sanction of the three estates assembled in parliament having confirmed these appointments, an uni-

727  
His accusation against Mary.

versal.

Scotland.

verfal obedience of the people had enfued, and a ready administration of justice had taken place: that certain persons, however, envious of the public order and peace, had brought her out of prison, and had engaged to subvert the government; that they had been disappointed in their wicked attempts; and that it was most just and equitable, that the king and the regent should be supported in power, in opposition to a rebellious and turbulent faction.

728  
Confuted  
by the de-  
puties of  
Mary.

This apology, so imperfect, so impudent, and so irreconcilable with history, received a complete confutation from the deputies of the queen of Scots. To take arms against her because Bothwel had her favour, was, they said, a lame justification of the earl of Murray and his friends; since it had never been properly manifested to her that he was the murderer of her husband. He had indeed been suspected of this crime; but had been tried by his peers, and acquitted. His acquittal had been ratified in parliament, and had obtained the express approbation of the party who were now so loud in accusing him, and who had conspired against her authority. These rebels had even urged her to accomplish her marriage with him, had recommended him as the fittest person to govern the realm, and had subscribed a bond asserting his innocence, and binding themselves to challenge and punish all his adversaries and opponents. They had never, either before or after the marriage, like true subjects, advertised the queen of his guilt, till, having experience of their strength, they secretly took arms, and invested her in Borthwick castle. The first mark of their displeasure was the sound of a trumpet in hostility, and the display of warlike banners. She made her escape to Dunbar; and they returning to Edinaburgh, levied troops, issued proclamations, took the field against her, under the pretence of delivering her from his tyranny, and got possession of her person. She was willing to prevent the effusion of blood, and was very far from preferring his impunity to her honour. Kirkaldy of Grange, in obedience to instructions from them, desired her to cause him to retire, and invited her to pass to them under the promise of being served and obeyed as their sovereign. She consented, and Kirkaldy taking Bothwel by the hand, recommended it to him to depart, and assured him that no man would pursue him. It was by their own contrivance that he fled; and it was in their power to have taken him; but they showed not the smallest desire to make him their prisoner. He remained, too, for some time in the kingdom, and was unmolested by them; and it was not till he was upon the seas that they affected to go in search of him. When she surrendered herself in the sight of their army, the earl of Morton ratified the stipulations of Kirkaldy, made obedience to her in their names, and promised her all the service and honour which had ever been paid to any of her predecessors. They were not slaves, however, to their engagements. They carried her to Edinaburgh, but did not lodge her in her palace. She was committed to the house of a burghers, and treated with the vilest indignities. She indeed broke out into menaces, and threatened them; nor was this a matter either of blame or of wonder. But it was utterly false that she had ever made any offer to give away her crown, if she might possess Bothwel. In the midst of her sufferings, she had even required them by

Scotland.

secretary Maitland to specify their complaints, and besought them to allow her to appear in parliament, and to join and assist in seeking a remedy to them from the wisdom of the three estates. This overture, however, so salutary and submissive, they absolutely rejected.— They were animated by purposes of ambition, and had not in view a relief from grievances. They forced her from her capital in the night, and imprisoned her in Lochleven; and there, they affirm, being exhausted with the toils of government and the languors of sickness, she, without constraint or sollicitation, resigned her crown to her son, and appointed the earl of Murray to be regent during his minority. This indeed was to assume an unlimited power over facts; but the truth could neither be concealed, nor overturned, nor palliated. She was in the vigour of youth, unassailed by maladies, and without any infirmity that could induce her to surrender the government of her kingdom. Nor was it unknown to them that the earl of Athol and the barons Tullibardin and Lethington, principal men of their council, dispatched Sir Robert Melvil to her with a ring and presents, with a recommendation to subscribe whatever papers should be laid before her, as the only means in her power to save her life, and with an assurance that what she did under captivity could not operate any injury to her. Melvil, too, communicated to her an intimation in writing from Sir Nicholas Throgmorton, which gave her the same advice and the same assurance. To Sir Nicholas Throgmorton she sent an answer, informing him that she would follow his counsel; and enjoining him to declare to his mistress her hapless state, and that her resignation of her crown was constrained. Nor did this ambassador neglect her commission; and it was a popular persuasion that Elizabeth would have marched an army to her relief, if she had not been intimidated by the threat of the rebels, that the blood of the queen of Scots would be the wages of her soldiers.. It was also not to be contradicted, that when the lord Lindsay presented to his sovereign the instruments of resignation, he menaced her with a closer prison and a speedy death if she should refuse to subscribe them. It was under an extreme terror, and with many tears, that she put her name to them. She did not consider them as her deeds; did not read them; and protested, that when she was at liberty, she would disavow subscriptions which had been extorted from her. Even Douglas, the keeper of Lochleven, could not endure to be a witness of the violence employed against her. He departed out of her presence, that he might not see her surrender her rights against her will; and he sought and obtained from her a certificate, that he was not accessory to this compulsion and outrage. Nor did it consist with the slightest probability or reason, that she would, of her own will and accord, execute a resignation of her royal estate, and retain no provision for her future maintenance. Yet by these extraordinary deeds, the condition to which she was reduced was most miserable and wretched. For no portion whatever of her revenue was reserved to her, and no security of any kind was granted either for her liberty or her life. As to the coronation of the prince, it could have no validity, as being founded in a pretended and forced resignation. It was also defective in its form; for there were in Scotland more than an hundred earls, bishops, and lords; and of these the whole, or at least the major part, ought

Scotland.

to concur in matters of importance. Now there did not assist in it more than four earls, six lords, one bishop, and two or three abbots. Protestations, too, were openly made, that nothing transacted at that period should be any prejudice to the queen, her estate, and the blood-royal of Scotland. Neither could it be rightly conceived, that if the queen had willingly surrendered her dignities, she would have named the earl of Murray to the regency in preference to the duke of Chatterault, who had a natural and proper claim to it, and who had deserved well of her country by discharging that high office during her minority. As to the ratification of the investiture of the young prince, and the regency of the earl of Murray by the estates, it was observable, that this was done in an illegal parliament. It was an invalid confirmation of deeds which in themselves had no inherent power or efficacy. The principal nobility, too, objected in this parliament to this ratification. Protestations were made before the lords of the articles, as well as before the three estates, to interrupt and defeat transactions which were in a wild hostility to the constitution and the laws. Neither was it true that the government of the king and the regent was universally obeyed, and administered with equity and approbation; for a great division of the nobility never acknowledged any authority but that of the queen, and never held any courts but in her name; and it was notorious, that the administration of the usurpers had been marked and distinguished by enormous cruelties and oppressions. Many honourable families and loyal subjects had been persecuted to ruin, and plundered of their wealth, to gratify the retainers and soldiers who upheld this insolent domination; and murder and bloodshed, theft and rapine, were prevalent to a degree unheard of for many ages. Upon all these accounts, it was inferred, that Elizabeth ought to support the queen of Scots, to restore her to her crown, and to overthrow the power of a most unnatural and rebellious faction.

719  
The regent  
unable to  
reply.

To these facts the regent did not pretend to make any objection; and though required by the English commissioners to produce sounder and better reasons for his treatment of the queen, he did not advance any thing in his own behalf. He even allowed the charges of treason and usurpation to be pressed against him, without presuming to answer. This surprising behaviour, which might readily have been construed into an acknowledgment of his guilt, it seems, proceeded from some conferences which he had with the duke of Norfolk. This nobleman was a zealous partizan for the succession of Mary to the English crown. He was strongly possessed with the opinion, that his mistress, while she was disposed to gratify her animosity and jealousies against the queen of Scots, was secretly resolved, by fixing a stain upon her, to exclude her altogether from the succession, and to involve her son in her disgrace. He was eager to defeat a purpose, which he conceived to be not only unjust in itself, but highly detrimental to his country. It was in his power to act with this view; and he observed with pleasure, that Maitland of Lethington was favourable to Mary. To this statesman, accordingly, he ventured to express his surprise, that the regent could be allured to think of an attempt so blameable as that of criminating his sovereign. If Mary had really given offence by misfear-

riage and mistakes, it yet was not the business of a good subject industriously to hold her out to scorn. Anxious and repeated conferences were held by them; and at length it was formally agreed, that the regent should not accuse the queen of Scots; and that the duke in return should protect him in the favour of Elizabeth, and secure him in the possession of his regency.

But while the regent engaged himself in this intrigue with the duke of Norfolk, he was desirous notwithstanding of gratifying the resentments of Elizabeth, and of advancing his own interests by undermining secretly the fame and reputation of his sovereign. He instructed Maitland, George Buchanan, James Macgill, and John Wood, to go to the duke of Norfolk, the earl of Sussex, and Sir Ralph Sadler, and to communicate to them as private persons, and not in their character of commissioners, the letters to Bothwell, and the other proofs upon which he affirmed the guilt of the queen of Scots. It was his desire that they would examine these papers, give their opinion of them to Elizabeth, and inform him whether she judged them sufficient evidences of Mary's concern in the murder of her husband. If this should be her opinion, he testified his own readiness, and that of his associates, to swear that the papers were genuine, and of the hand-writing of the queen. By this operation, he was solicitous to establish his vouchers as incontestable, and as testimonies of record. The commissioners examined his papers, and heard the comments of Buchanan and his other assistants; but they do not seem to have bestowed the fullest credit upon them. They described them, however, to Elizabeth; pointed out the places of them which were strongest against Mary; and allowed that their force and meaning were very great, if their genuineness could be demonstrated. But of their genuineness they acknowledged that they had no other evidence than stout assertions, and the offer of oaths. The earl of Sussex, in a private dispatch to secretary Cecil, does more than insinuate\*, that he thought Mary would be able to prove the letters palpable forgeries; and with respect to the murder of the king, he declares in plain terms, that from all he could learn, Murray and his faction would, upon a judicial trial, be found by "proofs hardly to be denied," more criminal in that charge than the queen herself. Elizabeth and her ministers, upon the receipt of such dispatches, did not think it expedient to empower them to adopt a method of proof so palpably suspicious, and in which she could not openly concur, without grossly violating even the appearance of probity. The regent had before attempted to engage her in a direct assurance of the validity of his papers, when he submitted copies of them to her inspection by his secretary Mr Wood. His attempt at this juncture was of a similar kind; and it could not recommend him to the English commissioners.

Nor were these the only transactions which took place during the continuance of the commissioners at York. The inventive and reasoning genius of Lethington had suggested to him a project, which he communicated in confidence to the bishop of Ross. It received the warm approbation of this ecclesiastic; and they determined to put it to a trial. While they attended the duke of Norfolk to the diversion of hawking, they insinuated into him the notion of his allying himself with the queen of Scots. Her beauty, her accomplish-

Scotland.

730  
His extreme in-  
dignities  
and hypocris-  
y.

\* Robertson  
of Nat-  
mer's His-  
tory, &c.  
book 4.

Scotland. ments, and her kingdom, were high allurements to this nobleman; and as he was the greatest subject of England, and perhaps of Europe, he seemed not to be unworthy of them. The proposal was very flattering to the admiration he entertained of Mary, to his ambition, and to his patriotism. The more he thought of it, he was the more convinced of its propriety. His access to be informed of the practices of the regent, destroyed in him the operation of these slanders by which her enemies were so active to traduce her. In this state of his mind, the lady Scroop, his sister, who resided at Bolton Castle with Mary, completely confirmed his resolution. For from her he learned the orderly carriage and the amiable dispositions of the queen of Scots. He was now impatient to have a fit season to make her formally the offer of his hand.

Elizabeth in the mean time was thrown into confusion by the refusal of the regent to accuse the queen of Scots. To give a positive answer to his doubts and scruples was not consistent with her honour; and yet, without this concession, she was assured that the Scottish deputies would not exhibit their charge or crimination. Having deceived Mary therefore with fair promises, she was active in gaining over the regent to her views; which having done, he consented at last to prefer his accusation against Mary before the commissioners, who now met at Westminster by the command of Elizabeth. The charge was expressed in general and presumptive terms. It affirmed, that as James earl of Bothwell was the chief executor of the murder of king Henry, so the queen was his persuader and counsel in the device; that she was a maintainer and fortifier of this unnatural deed, by stopping the inquisition into it and its punishment, and by taking in marriage the principal regicide; that they had begun to exercise a cruel tyranny in the commonwealth, and had formed a resolution of destroying the innocent prince, and of transferring the crown from the true line of its kings to a bloody murderer and a godless tyrant; and that the estates of the realm, finding her unworthy to reign, had ordered her to resign the crown, her son to be crowned, and the earl of Murray to be established in the regency. Before this accusation was preferred, the earl of Lenox presented himself before the English commissioners; made a lamentable declaration of his griefs, and produced to them the letters which had passed between him and Mary concerning the murder, with a writing which contained a direct affirmation of her guilt.

732 Rejoinders of the Scots deputies. The deputies of Mary were astonished at this accusation, being a violent infringement of a protestation which they had formerly given in, and which had been accepted, namely, that the crown, estate, person, and honour of the queen of Scots, should be guarded against every assault and injury; yet in all these particulars she was touched and affected. It was understood that no judicial proceedings should take place against her; yet she was actually arraigned as a criminal, and her deputies were called upon to defend her. They discovered not, however, any apprehension of the validity of the charge; and while they fully explained the motives which actuated the earl of Murray and his faction in their proceedings, they imputed to persons among themselves the guilt of the king's murder. They affirmed, that the queen's adversaries were the accomplices of Both-

Scotland. wel; that they had subscribed a bond conspiring the death of the king; and that their guilt had been attested in the sight of 10,000 spectators by those of their confederates who had already been executed. They exclaimed against the enormous ingratitude, and the unparalleled audacity of men, who could forget so completely all the obligations which they owed to their sovereign; and who, not satisfied with usurping her power, could even charge her with a murder which they themselves had committed. They represented the strong necessity which had arisen for the fullest vindication of their mistress; and they said, that in so weighty an extremity, they could not possibly suppose that she would be restrained from appearing in her own defence. They had her instructions, if her honour was touched, to make this requisition; and till it was granted, they insisted, that all proceedings in the conference should be at an end. A refusal of this liberty, in the situation to which she was driven, would be an infallible proof that no good was intended to her. It was their wish to deal with sincerity and uprightnes; and they were persuaded, that without a proper freedom of defence, their queen would necessarily fall a victim to partiality and injustice. They therefore earnestly pressed the English commissioners, that she might be permitted to present herself before Elizabeth, the nobles of England, and the ambassadors of foreign nations, in order to manifest to the world the injuries she had suffered, and her innocence.

After having made these spirited representations to the English commissioners, the deputies of Mary desired to have access to the queen of England. They were admitted accordingly to an audience; and in a formal address or petition they detailed what had happened, insisted that the liberty of personal defence should be allowed to their mistress, and demanded that the earl of Murray and his associates should be taken into custody, till they should answer to such charges as should be preferred against them. She desired to have some time to turn her thoughts to matters of such high importance; and told them, that they might soon expect to hear from her.

733 They are admitted to an audience by Elizabeth. The bishop of Ross, and the other deputies of Mary, in the mean time, struck with the perfidious management of the conference, convinced of the jealousies and passions of Elizabeth, sensible that her power over her commissioners was unlimited, and anxious for the deliverance of their mistress, made an overture for an accommodation to the earl of Leicester and Sir William Cecil. They proposed, that the original meaning of the conference should still be adhered to, notwithstanding the accusation which had been presented by the earl of Murray; and that Elizabeth, disregarding it as an effort of faction, should proceed to a good agreement between Mary and her subjects. For this scheme, which is so expressive of their suspicions of Elizabeth and of her commissioners, they had no authority from their mistress. They acknowledged accordingly, that it was made without her instructions, and intimated that they were moved to it by their anxiety for peace and the re-establishment of the affairs of the Scottish nation. They were introduced at Hampton-court to Elizabeth; who listened to their motion, and was averse from it. They then repeated the desires of the petition they had presented to her; but she did not think

Scotland.  
735  
Shameful  
conduct of  
Elizabeth.

think it right that the queen of Scots should yet have the liberty to defend herself in person. She confessed, indeed, that it was reasonable that Mary should be heard in her own cause; but she affirmed, that she was at a loss at what time she should appear, in what place, and to whom she should address herself. While she let fall, however, the hope that Mary might obtain the permission so repeatedly and so earnestly requested, she expressed her resolution that the earl of Murray should first be heard in support of his charge, and that she should attend to the proofs which he affirmed himself in readiness to produce. After this business should be transacted, she told the deputies of Mary that she would again confer with them. It was to no purpose that they objected to a procedure so strange and so improper. An accusation, said they, is given; the person accused is anxious to defend herself; this privilege is denied to her; and yet a demand is to be made for the vouchers of her guilt. What is this but an open violation of justice? It did not become them to dispute her pleasure in her own dominions; but they would not, they informed her, consent to a measure which was so alarming to the interests of their queen; and if it was adopted, she might expect that a protest against its validity would be lodged with her commissioners.

736  
Altercation  
between  
the com-  
missioners.

The English commissioners resumed the conference, and were about to demand from the earl of Murray the proofs with which he could support his accusation. The bishop of Ross and his associates being admitted to them, expressed themselves in conformity to the conversation they had held with Elizabeth. They declared, that it was unnatural and preposterous in their sovereign to think of receiving proofs of the guilt of the queen of Scots before she was heard in her own defence; and they protested, that in the event of this proceeding, the negotiation should be dissolved, and Elizabeth be disarmed of all power to do any prejudice to her honour, person, crown, and estate. The commissioners of the English queen were affected with this protestation, and felt more for the honour of their mistresses than for their own. They refused to receive it, because there were engrossed in it the words of the refusal which Elizabeth had given to the petition for Mary. They did not choose to authenticate the terms of this refusal by their subscriptions; and were solicitous to suppress so palpable a memorial of her iniquity. They alleged, that the language of her refusal had not been taken down with accuracy; and they pressed Mary's deputies to present a simpler form of protestation. The bishop of Ross and his colleagues yielded not, however, immediately to their insidious importunity; but, repeating anew their protestation as they had at first planned it, included the express words of Elizabeth; and, when compelled by the power of the commissioners to expunge the language of the English queen, they still insisted upon their protestation. An interruption was thus given to the validity of any future proceedings which might affect the reputation of the queen of Scots. The earls of Murray and Morton, with their friends, were very much disappointed. For they had solaced themselves with the hope of a triumph before there was a victory; and thought of obtaining a decree from Elizabeth, which, while it should pronounce the queen of Scots to be an

adulteress and a murderer, would exalt them into the station and character of virtuous men and honourable subjects.

Scotland.

737  
Elizabeth  
demands  
vouchers of  
the crimes  
laid to Ma-  
ry's charge.

Though the conference ought naturally to have terminated upon this protestation of the deputies of Mary against the injustice of Elizabeth, yet it did not satisfy the latter princess that the accusation only had been delivered to her commissioners: she was seriously disposed to operate a judicial production of its vouchers. The charge would thus have a more regular aspect, and be a sounder foundation upon which to build, not only the intamy of the Scottish queen, but her own justification for the part she had acted. Her commissioners accordingly, after the bishop of Ross and his colleagues had retired, disregarding their protestation, called upon the earl of Murray and his associates to make their appearance. The pretence, however, employed for drawing from him his papers was sufficiently artful, and bears the marks of that systematic duplicity which so shamefully characterizes all the transactions of Elizabeth at this period. Sir Nicholas Bacon the lord keeper addressed himself to the earl of Murray. He said, that, in the opinion of the queen of England, it was a matter surprising and strange, that he should accuse his sovereign of a crime most horrible, odious to God and man, against law and nature; and which, if proved to be true, would render her infamous in all the kingdoms of the world. But though he had so widely forgot his duty, yet had not Elizabeth renounced her love of a good sister, a good neighbour, and a good friend; and it was her will, that he and his company should produce the papers by which they imagined they were able to maintain their accusation. The earl of Murray, in his turn, was not wanting in dissimulation. He expressed himself to be very sorry for the high-displeasure he had given to Elizabeth by his charge against Mary, and for the obliquity of the Scottish queen and her deputies, which made it necessary for him to vindicate himself by discovering her dishonour. Under the load of this double and affected sorrow, he made an actual and formal exhibition of the vouchers by which he pretended to fix and establish her criminality. A particular account and examination of these vouchers, the reader will find in our life of MARY, and in the works to which we have there referred.

To enumerate all the shifts to which Elizabeth and the adversaries of Mary were put, in order to make the strange evidence that was produced wear some degree of plausibility, would far exceed our bounds. It is sufficient to say, that after having wearied themselves with prevarication and falsehood; after having pressed Mary to abdicate her crown, a requisition with which she never would comply; and after having finally refused to hear her in her own defence; Elizabeth, on the 10th of January 1569, gave leave to the earl of Murray and his accomplices to depart her dominions; telling them, that since they came into England, nothing had been objected to them which could hurt their honour as men, or affect their allegiance as subjects. At the same time she told them, that they had produced no information or evidence by which she was entitled to conceive any bad opinion of the queen of Scots. It was therefore her pleasure to allow the affairs of Scotland to continue precisely in the condition in which they were situated at the beginning of the conference. Three days

738  
Con-  
clusion  
of Mary's  
trial.



Scotland. days after this, they formally took their leave of the queen of England. The deputies of Mary remonstrated, protested, and argued, to no purpose; the English privy-council, with the most provoking indifference, told them, that "the earl of Murray had promised to return to England at any time she should call upon him." But, in the mean time, the queen of Scots could not, for many strong reasons, be suffered to take her departure out of England. As to her deputies, they would move Elizabeth to allow them to return to Scotland; and they believed that she would not detain them."

Mary was exceedingly disappointed and chagrined by this singular issue of her cause. Her friends during this period had increased, and the cruel and inurious treatment she had met with was so flagrant, that the earl of Murray and his faction were apprehensive of a sudden reverse of fortune. The earls of Argyre and Huntley protested against the injustice of their proceedings, at the same time that they openly accused the earl of Murray and Maitland of Lethington as the associates of Bothwell in the murder of the king. This charge, according to the custom of the times, they offered to prove as true and certain by the law of arms; and they protested, that if their adversaries should delay to answer their challenge, they should be held as confessing themselves guilty of the murder. Elizabeth, however, foreseeing something of this kind, had dismissed Murray and his adherents with precipitation, so that there could now be no formal production of it before the English commissioners. However, it was known and published in the court of Elizabeth. Murray made an evasive reply, and Lethington made none at all.

This, however, afforded no relief to the unhappy queen of Scotland. Her inveterate and treacherous enemy held her fast, and endeavoured by every method in her power to render her life miserable. Mary, on the other hand, never lost either her spirit or her dignity. She attempted to rouse in the minds of her nobles that passion for liberty which had once so much distinguished the Scottish nation, but which now seemed to be exchanged for a servile subjection to the queen of England. But some dispatches which pressed these topics being intercepted, Mary was removed from Bolton to Tutbury castle, where she was intrusted to the earl of Shrewsbury, and committed to closer confinement than she had yet experienced; while Elizabeth dispersed manifestoes all over the northern counties of England, complaining of reports injurious to her honour, and disclaiming all hostile intentions towards the liberties of Scotland.

In the mean time Murray returned to Scotland, where he took every method to establish himself in his ill-acquired power. Mary had commanded the duke of Chatelherault to return to Scotland, in order to raise forces for her behoof; but this nobleman had been long detained in England by the artifices of Elizabeth, so that Murray had arrived there before him. The duke, however, began to raise forces, and might have proved a troublesome antagonist, had not Murray deceived him by a pretended negotiation, and got him into his power; immediately after which he imprisoned him, and forced most of the other lords who were on that side to submit.

VOL. XVII. Part I.

Scotland. When the news of this important event reached the queen of Scots, she instructed the bishop of Ross to repair to Elizabeth, and to make remonstrances in their behalf. By the agency of this ecclesiastic, whom she had constituted her ambassador, she meant to conduct her transactions with the queen of England; and from the conclusion of the conferences, she had been meditating a proper plan upon which to accomplish her liberty and restoration. The bishop of Ross, after complaining loudly of the rigorous proceedings of the regent, and intimating the general belief which prevailed that he was supported by the English court, pressed the propriety of a final settlement of the affairs of his mistress. With this view, he was admitted by Elizabeth and her privy-counsellors to frequent conferences; and they even desired him to present to them in writing the articles which he was commanded to propose as the foundation of a treaty. He failed not to comply with this injunction; and it was the import of his schedule of agreement, that Mary should engage never to molest Elizabeth, and the lawful heirs of her body, respecting the succession to the crown of England and Ireland, if she could obtain sufficient security that upon their demise her rights would be respected; that a new treaty of alliance and friendship should be concluded between the two queens, by the advice of the estates of both kingdoms; that this league should be ratified by their oaths and seals, and confirmed by parliamentary acts; and, if any farther assurance should be deemed necessary on the part of Mary, that she would procure the kings of France and Spain to be the guaranties of her punctuality and concord; that in compliance with the pleasure of Elizabeth, she would extend her clemency to all her subjects who had offended her, under the provision that they would submit to her sovereignty, deliver up the prince her son, restore her castles, give back her jewels, and surrender to her friends and servants the estates and possessions of which they had been deprived; that the murder of the king should be punished against all the actors in it without delay, and according to the laws; that, to prevent Bothwell from returning to Scotland, and to please those who imagined that it was in his power to excite ferment and trouble, she would be bound to institute a process of divorce against him; and that these articles being adjusted, the queen of England should allow her to proceed to Scotland, under a safe and honourable convoy, to be re-established by the three estates in her realm and government, and to be gratified with the dissolution of all the acts and statutes which had been passed to her prejudice.

These heads of alliance were received with a respect and cordiality which were not usually paid to the transactions of Mary in the court of Elizabeth; and the bishop of Ross was elated with expectation. Their justice, however, was not the sole, or even the chief, cause of this attention and complaisance. A combination of the English nobles had taken place against Cecil, whose power and credit were objects of indignation and jealousy; and the duke of Norfolk had been active and successful in promoting the scheme of his marriage with the queen of Scots. Taking advantage of the condition of parties, he had practised with the principal nobility to encourage his pretensions to Mary; and he secretly communicated to them the promises of

K

support

Scotland.

742  
Negotiations in England.

739  
Earl of Murray, &c. charged with the king's murder, and challenged to single combat.

740  
Mary committed to closer confinement.

741  
The regent secures himself in power.

743  
Advances are made in the projected marriage of Mary with the duke of Norfolk.

Scotland.

support he had received from the earl of Murray. By the advice and influence of Sir Nicholas Throgmorton, he engaged in his behalf the earl of Leicester; and this nobleman imparted the matter to the earls of Pembroke and Arundel. The duke himself was able to conciliate the favour of the earls of Derby, Bedford, Shrewsbury, Southampton, Northampton, Northumberland, Westmoreland, and Suffex. In the mean time, he was eagerly pressing Mary herself with his suit and importunities; and had mutually exchanged the tokens of a constant and sincere love. It was in this forward state of the match, that the bishop of Ross drew up the schedule of articles for the accommodation of the rival queens.

744  
The English nobles propose articles to Mary.

At the desire of Elizabeth, her privy-council conferred with the bishop upon these articles at different times; and they expressed themselves to be highly pleased with their general import and meaning. Little doubt was entertained of their success; and the earl of Leicester, in order to complete the business, and to serve the duke of Norfolk, undertook to give them a more special force, and to improve them by the introduction of a stipulation about the marriage of the queen of Scots. According to his scheme of argeement, it was required of Mary, that she should be a party to no attempt against the rights and titles of the queen of England, or her heirs; that she should consent to a perpetual league, offensive and defensive, between the two kingdoms; that she should finally establish the Protestant religion in Scotland; that she should admit to her favour those of her subjects who had appeared against her; that if she had made any assignment of her kingdom to the duke of Anjou, in the expectation of a marriage to be contracted between them, it should be dissolved; and that instead of looking to a foreign prince, whose alliance would be dangerous, not only to the religion but to the liberty of the two realms, she would agree to marry the duke of Norfolk, the first peer of England. These articles being communicated to the bishop of Ross, he was desired to transmit them to Mary; but, as they touched upon some points concerning which he had no instructions, he declined this office, and recommended the propriety of their employing a special messenger of their own in a commission of such high importance. They accordingly appointed Mr Candish to go with them to the queen of Scots, and, in a formal dispatch, they extolled the merits of the duke of Norfolk; assured her of the general favour and support of the English nobility, if she should approve of his love; and intimated their belief that Elizabeth would not be averse from a marriage which gave the certain promise of tranquillity and happiness to the two kingdoms. This dispatch was in the handwriting of Leicester; and it was subscribed by this nobleman, and the earls of Arundel and Pembroke, and the lord Lumley.

745  
Mary agrees to the treaty proposed to her.

Mary, in the solitude of her prison, received this application with pleasure. By the lord Boyd she returned a very favourable answer to it; but took the liberty to admonish them of the necessity of their securing the good-will of Elizabeth, lest her dislike of the treaty of the marriage should excite new disasters and misfortunes, and involve the duke of Norfolk in inconveniency and danger. This advice, the suggestion of her delicacy and prudence, [did not draw sufficiently

their attention. The duke of Norfolk was now impatient to conclude this great transaction, in which he had engaged himself; and admitted into his councils many nobles whom he had hitherto neglected to court, and many gentlemen who were considerable from their distinction and fortunes. The countenance and consent of the kings of France and Spain were thought necessary to the measures in agitation, and were solicited and obtained. In the universality of the applause with which they were honoured, it was supposed that Elizabeth would be allured into a cordial acknowledgment of their propriety, or be compelled to afford them a reluctant approbation; and so ardent a belief prevailed of their fortunate termination, that the marriage-contract was actually intrusted to the keeping of M. Fenelon the French ambassador.

The activity of the duke of Norfolk with the English nobles did not so much engross his attention as to make him forget the regent. He kept up with him a close correspondence in consequence of the concert into which they had entered, and received the most ample assurances of his fidelity and service. The most sanguine and seducing hopes elated him. The regent, while he stipulated for terms of favour and security to himself and his faction, appeared to be full of the marriage, as a measure from which the greatest advantages would arise to the two kingdoms, to the two queens, and to the true religion. The match, in the meanwhile, was anxiously concealed from Elizabeth; but she was zealously pressed to conclude an accommodation with Mary, on the foundation of the schedule of agreement presented by the bishop of Ross. After having had many conferences with her privy-council, she seemed inclined to treat definitively for the restoration of the queen of Scots, and actually agreed to open the transaction to the regent. The lord Boyd was sent into Scotland upon this business; and while he carried her letters, he was intrusted with dispatches from Mary, the duke of Norfolk, and Sir Nicholas Throgmorton.

As the regent was returning from his northern expedition, he was saluted at Elgin by the lord Boyd, who immediately laid before him the dispatches and instructions with which he had been charged. The queen of England, in her letters, made three propositions in behalf of Mary, and intimated a desire that one of them should be accepted. The queen of Scots, she said, might be restored fully and absolutely to her royal estate: she might be associated in the government with her son, have the title of *queen*, and, till the prince should attain the age of 17 years, the administration might continue in the regent; or she might be permitted to return to Scotland in a private station, and have an honourable appointment to maintain her in a safe and happy obscurity. The dispatches from Mary to the regent desired, that judges might immediately be allowed to inquire into the legality of her marriage with Bothwell: and that, if it was found to have been concluded in opposition to the laws, it should be declared void, and that the liberty be granted to her of entering anew into a matrimonial engagement. The duke of Norfolk expressed to the regent the gratitude he felt for his friendship; promised him the command of the fullest exertions of his consequence and power; intreated him to proceed expeditiously in promoting

Scotland.

746  
The proposals of Elizabeth.

747  
The requests of Mary.

748  
Importunities of Norfolk.

Scotland. promoting the business of the marriage, and referred him to the instructions of lord Boyd for a satisfactory answer to any doubts which might give him disgust or uneasiness. By the letters of Throgmorton, the regent was advertised that the marriage of the queen of Scots with the duke of Norfolk was a certain and decided point; and he was counselled to concur heartily and expeditiously in this transaction, that his consent might not seem to have been extorted. Maitland of Lethington was recommended to him by this statesman, as the person whom he should choose to represent him in the English court, as he could negotiate best the terms and mode of his security and of that of his party. In fine, Throgmorton intreated him not to be troubled with any precise scruples or objections, for that his overthrow, if he resisted, would be inevitable; and, in the view of his services and cordiality, he assured him, that no man's friendship would be accepted with greater affection, and no man's estimation be higher or more fortunate. The zeal of Throgmorton induced him also, upon this occasion, to address to Maitland a dispatch, in which he was infinitely importunate to hasten his expedition to England, in the character to which he recommended him. He complimented him as the fittest person to open the match to the English queen, on the part of the regent and the Scottish nobility; and he represented the success of the scheme to be infallible, as Elizabeth would never be so unwise as to put her own safety, the peace of her kingdom, and the preservation of her people, in competition with the partial devices that might proceed from the vanity and the passions of any person whatsoever. He enumerated the names of the English nobility who had condescended to promote the marriage. He enlarged upon, it as an expedient full of wisdom, and as advantageous in the highest degree to religion and the state. He pointed out the lasting and inseparable connection of England and Scotland, as its happy and undoubted consequence. For, if James VI. should die, the sceptres of the two kingdoms might devolve to an English prince; and if he should attain to manhood, he might marry the daughter of the duke of Norfolk, and unite, in his person, the two crowns.

749  
Deliberation of the estates on the restoration, &c. of the queen.

These weighty dispatches employed fully the thoughts of the regent. The calls of justice and humanity were loud in the behalf of Mary; his engagements to Norfolk were precise and definitive; and the commission of Elizabeth afforded him the command of the most important services. But, on the other hand, the restoration of Mary, and her marriage, would put an end for ever to his greatness; and, amidst all the stipulations which could be made for his protection, the enormity of his guilt was still haunting him with suspicions and terror. His ambition and his selfish sensibilities were an overmatch for his virtue. He practised with his partisans to throw obstacles in the way of the treaty and the marriage; and, on the pretence of deliberating concerning the restoration of Mary, and on her divorce from Bothwel, a convention of the estates was summoned by him to assemble at Perth. To this assembly the letters of Elizabeth were recited; and her propositions were considered in their order. The full restoration of Mary to her dignity was accented injurious to the authority of the king, and her association with her son in the government was judged improper

Scotland. and dangerous; but it was thought that her deliverance from prison, and her reduction to a private station, were reasonable expedients. No definitive decree, however, was pronounced. The letters of Mary were then communicated to this council, and gave rise to vehement debates. She had written and subscribed them in her character of queen of Scotland. This carriage was termed *insolent* and *imperious* by the friends of the regent. They also held it unsafe to examine her requests, till they should be communicated to Elizabeth; and they insinuated, that some inclement and partial device was concealed under the purpose of her divorce from the earl of Bothwel. The favourers of Mary endeavoured to apologize for the form of the letters, by throwing the blame upon her secretaries; and engaged, that while the commissaries, or judges, were proceeding in the business of the divorce, new dispatches in the proper method should be applied for and procured. They were heard with evident symptoms of displeasure; and exclaimed, "that it was wonderful to them, that those very persons who lately had been so violent for the separation of the queen and Bothwel should now be so averse from it." The partisans of the regent replied, "that if the queen was so eagerly solicitous to procure the divorce, she might apply to the king of Denmark to execute Bothwel as the murderer of her husband; and that then she might marry the person who was most agreeable to her." The passions of the two factions were inflamed to a most indecent extremity, and the convention broke up with strong and unequivocal marks of hostility and anger.

Notwithstanding the caution with which Mary and Norfolk carried on their intrigues, intimations of them had come to Elizabeth. Norfolk himself, by the advice of the earl of Pembroke, had ventured to disclose his secret to Sir William Cecil, who affected to be friendly to him. The regent, in answer to her letters, transmitted to her the proceedings of the convention at Perth. The application of Mary for a divorce was a key to the ambitious hopes of the duke of Norfolk. She commanded Sir William Cecil to apply himself to discover the conspiracy. This statesman betrayed the confidence with which he had been entrusted; and Elizabeth, while the duke was attending her at Farnham, discovering a mixture of pleasantry and passion, admonished him to be careful on what pillow he reposed his head. The earl of Leicester, alarmed by his fears, revealed to her at Titchfield the whole proceedings of the duke of Norfolk and his friends. Her fury was ungovernable; and at different times she loaded Norfolk with the severest reproaches and continually, for presuming to think of a marriage with the queen of Scots without the sanction of her concurrence. Insulted with her discourse and her looks, abandoned by Leicester, and avoided by other nobles in whom he had confided, he felt his courage to forsake him. He left the court at Southampton without taking his leave, and went to London to the earl of Pembroke. New intimations of her displeasure were announced to him, and he retired to his seat at Kinninghall in Norfolk. His friends pressed him to take the field, and to commit his safety to the sword; but having no inclination to involve his country in the miseries of war, he rejected their advice; and addressing an apology to E-

Scotland. Elizabeth, protested that he never meant to depart from the fidelity which he owed to her; and that it was his fixed resolution to have applied for her consent to his marriage with the queen of Scots. In return, she ordered him to repair to her court at Windsor; and, as he appeared to be irresolute, a messenger was dispatched to take him into custody. He was first confined to the house of Paul Wentworth, at Burnham, in the neighbourhood of Windsor, and then committed to the Tower. The earls of Pembroke and Arundel, the lord Lumley, Sir Nicholas Throgmorton, and the bishop of Ross, were also apprehended and confined.

751  
Mary exposed to new indignities.

Elizabeth, amidst the ferment of her inquietudes, forgot not to gratify her revenge by insulting the queen of Scots. The name of Mary was sufficient to convulse her with anger. The earl of Huntingdon, who affected to have pretensions to the crown of England that were preferable to those of the Scottish princess, was joined with the earl of Shrewsbury in the office of guarding her. His instructions were rigorous, and he was disposed to exceed them. The earl of Shrewsbury considered it as an indignity to have an associate who was a declared enemy to his charge, who had an interest in her death, and who was remarkable for a natural ferocity of disposition. Mary exclaimed against the indelicacy and rudeness of Elizabeth, and protested that all her intentions were commendable and innocent. Huntingdon took a delight in her sufferings. He ransacked her coffers with a view of making discoveries; but her prudence had induced her to destroy all the evidences of her transactions with the duke of Norfolk; and the officious assiduity of this jailor was only rewarded with two cyphers which he could not comprehend. The domestics whom she favoured were suspected and dismissed. Her train of attendants was diminished. An unrelenting watch was kept upon her. No couriers were allowed to carry her dispatches. No messengers were admitted to her presence; and all the letters from her friends were ordered to be intercepted, and to be conveyed to the queen of England.

752  
Norfolk betrayed by the regent.

The proceedings of the convention at Perth were afflicting to Elizabeth, to Mary, and to the duke of Norfolk. In the former they created suspicions of the regent; and they were a certain annunciation to the latter, that he was resolved to support himself in the government of Scotland. Uncertain rumours had reached Elizabeth of the interviews he had held with Norfolk in the business of the marriage. Her surprise and indignation were infinite. Mr Wood, who brought from the regent his answer to her letter, was treated with disrespect. Secretary Cecil dispatched instructions to the lord Hunsdon, the governor of Berwick, to watch his operations with a jealous eye. Elizabeth, by a special envoy, required from him an explanation of his ambiguous carriage. The regent, true to his interests, apologized to her for his connections with the duke of Norfolk, by laying open the design of that nobleman to cut him off, in his way to Scotland, by a full communication of whatever had passed between them in relation to Mary, and by offers of an unlimited submission and obedience.

753  
Insurrection in England.

While the duke of Norfolk was carrying on his intrigues with Mary, the scheme of an insurrection for her deliverance was advancing under the direction of

the earls of Northumberland and Westmoreland. Motives of religion were the chief foundation of this conspiracy; and the more zealous Catholics over England were concerned in it. Mary, however, by the advice of the duke of Norfolk, who was afraid of her matching with a foreign prince, did not enter into it with cordiality. It advanced notwithstanding; and the agents of the pope were lavish of exhortations and donations. The duke of Alva, by the order of his master the king of Spain, encouraged the conspirators with the offer of 20,000 men from the Netherlands; and, under the pretence of adjusting commercial disputes, he sent into England Chiapini Vitelli marquis of Celona, an officer of ability, that he might be at hand, and prepare to take the command of them.—The report of an insurrection was universal. Elizabeth kept an army of 15,000 men near her person. The queen of Scots was removed to Coventry, a place of great strength; and if a superior and commanding force should appear before it, her ferocious keeper, it is said, had orders to assassinate her. Repeated commands were sent to the earls of Northumberland and Westmoreland, to repair to court. But the imprisonment of the duke of Norfolk and his friends had struck a panic into them. They conceived that their conspiracy was discovered; and putting themselves at the head of their followers, they issued their manifesto. The restoration of Popery, the establishment of the titles of Mary to the English crown, and the reformation of abuses in the commonwealth, were the avowed objects of their enterprise. But they had embarked in a business for which they were altogether unequal. Their efforts were feeble and desultory. The duke of Alva forgot his promises. Wherever the peace was disturbed by insurgents, there were troops to oppose them. The vigilance of Elizabeth disconcerted with ease the operations of men whom no resources or popularity could have conducted to greatness, and who could neither conquer nor die. The earl of Westmoreland, after concealing himself for some time in Scotland, effected an escape into Flanders, where he passed a miserable and useless existence; and the earl of Northumberland being taken by the regent, was imprisoned in the castle of Lochleven.

As the fury of Elizabeth abated, her resentment to the duke of Norfolk lost its power; and she failed not to distinguish between the intrigues of an honourable ambition, and the practices of an obstinate superstition. It was the result of the examination of this nobleman, and of the confessions of the other prisoners, that Lethington had schemed the business of the marriage, and that the earl of Murray had encouraged it; that her consent was understood to be necessary to its completion; and that Mary herself had warmly recommended the expedient of consulting her pleasure. Upon receiving proper admonitions, the earls of Pembroke, Arundel, the lord Lumley, Sir Nicholas Throgmorton, and the bishop of Ross, were released from confinement; and, after a more tedious imprisonment, the duke of Norfolk himself was admitted to his liberty. This favour, however, was not extended to him till he had not only submissively acknowledged his presumption in the business of the marriage; but had fully revealed whatever had passed between Mary and him, and solemnly engaged himself never more to think of this alliance,

Scotland.

754  
Elizabeth liberates Norfolk and his friends.

otland. liance, and never more to take any concern whatsoever in her affairs.

<sup>755</sup> island  
Lething-  
accused  
Darn-  
's mur-  
The regent, in the meanwhile, was very anxious to recover the good opinion of Elizabeth. Her treatment of Mr Wood, and her discovery of his practices, had excited his apprehensions. He therefore assembled at Stirling a convention of the estates; and taking her letters a second time into consideration, returned her a reply to them by Robert Pitcairn abbot of Dunfermline, in a style suited to her temper and jealousies, and from which she could decisively infer, that no favour of any kind would be shown to the queen of Scots. But this base condescension, though assisted by his treachery to the duke of Norfolk, not being sufficient, in his opinion, to draw completely to him the cordiality of the queen of England, he was preparing to gratify her with another sacrifice. The partiality of Maitland to Mary, and his intrigues with Norfolk and the English malcontents, had rendered him uncommonly obnoxious to Elizabeth and her ministry. The late commotions had been chiefly ascribed to his arts; and it was natural to dread new calamities and tumults from the fruitful spring of his invention. Under the pretence of employing his service in dispatches to England, the regent invited him to Stirling. He was then with the earl of Athol at Perth; and suspecting some improper device, he obeyed the summons with reluctance. When he took his place in the privy-council, Captain Crawford, the minion of the earl of Lenox, who had distinguished himself in the trial of Mary, accused him, in direct terms, of being a party in the murder of the late king. The regent affected astonishment, but permitted him to be taken into custody. He was soon after sent to Edinburgh under a guard, and admonished to prepare for his trial. Upon similar charges, the lord Seton and Sir James Balfour were seized upon and imprisoned.

<sup>756</sup> is pro-  
ted by  
rkaldy of  
ange.  
Kirkaldy of Grange, the governor of the castle of Edinburgh, who was warmly attached to Maitland, after having remonstrated in vain with the regent on the violence of his conduct, employed address and stratagem in the service of his friend. Under the cover of night, he went with a guard of soldiers to the lodging where Maitland was confined; and showing a forged warrant for taking his person into keeping, got possession of him. Kirkaldy had now in his castle the duke of Chatelherault, the lord Herries, and Maitland. The regent sent for him to a conference; but he refused to obey his message. He put himself and his fortrefs under the direction of his prisoners. The regent, condescending to pay him a visit, was more lavish than usual of his promises and kindness. His arts, however, only excited the disdain of this generous soldier. Since he could not lead out Maitland to the block, he instituted a process of treason against him, in order to forfeit his estates. Kirkaldy, by the mouth of a trumpeter, desired him to commence similar actions against the earl of Morton and Mr Archibald Douglas, as it was notorious that they were parties to the king's murder. This messenger was likewise charged with delivering a challenge from him to Mr Archibald Douglas, and another from the lord Herries to the earl of Morton. This disappointment, and these indignities, made a deep impression upon the regent; and, in a thoughtful dissatisfied humour, a-

Scotlan l.  
about this time, he made a short progress towards the English border, courting popularity, and deserving it, by an attention to order and justice.

<sup>757</sup> Elizabe h  
agree to  
deliver up  
Mary to  
the regent.  
Elizabeth, flattered by his submissive advances, and pleased with his ambition, was now disposed to gratify his fullest wishes; and she perceived, that by delivering to him the queen of Scots, she would effectually relieve herself of a prisoner whose vigour and intrigues were a constant interruption to her repose. A treaty for this purpose was entered into and concluded. The regent was to march an army to the English frontiers, and to receive from her his sovereign into her own dominions, the victim of his power, and the sport of his passions. No hostages and no security were stipulated for her entertainment and good usage. His authority over her was to be without any limits. Upon his part, he was to deliver to Elizabeth the young prince, to put her in possession of the principal forts of Scotland, and to assist her with troops in the event of a war with France. This treaty, so fatal to Mary, and so ruinous to the independence of Scotland, escaped not the vigilance of the bishop of Ross. He complained of it in the strongest terms to Elizabeth; and declared it to be equivalent to a sentence of death against his mistress. The ambassadors of France and Spain were also strenuous in their remonstrances to her upon this subject. All resistance, however, was unavailing; and the execution of the treaty seemed inevitable. Yet how vain are the loftiest schemes of human pride! The career of the regent was hastening to its termination; and the hand of an assassin put a period to his dream of royalty. Scotland did not lose its liberties; but Mary continued to be unfortunate.

<sup>758</sup> Dea h of  
the regent.  
James Hamilton of Bothwellhaugh, who had been taken a prisoner at the battle of Langside, obtained his liberty and life; but his estates were forfeited.— His wife, the heiress of Woodhouslie, retired upon this emergency to her paternal inheritance, in the hope that it might escape the rapacity of the regent. He had, however, given it away in a gift to one of his favourites, Sir James Ballenden; and the instruments of his power having the inhumanity to strip her of her garments, and to turn her naked out of her house, in a cold and dark night, she became distracted before the morning. Hamilton vowed revenge; and the regent made a mockery of his threats. This contempt inspired his passions; and the humiliation of the house of Hamilton, to which he was nearly allied, fostered the eagerness of his discontents. The madness of party fermented in him with the atrociousness of rage. His mind reconciled itself to assassination. After watching for some time a proper opportunity to commit his horrible purpose, he found it at Linlithgow. The regent was to pass through this town in his way from Stirling to Edinburgh. Intimations reached him that Hamilton was now to perpetrate his design: and he unaccountably neglected them. The assassin, in a house that belonged to the archbishop of St Andrew's, waited deliberately his approach; and firing his musket from a window, shot him through the body. The wound, when examined, was not judged to be mortal; but the regent finding its pain to increase, prepared himself for death; and in a few hours after he expired. A fleet horse of the abbot of Arbroath's carried the assassin to the palace of Hamilton; and  
6 from

Scotland. from thence he soon after effected his escape into France.

759  
Lenox  
chosen to  
succeed  
him.

The death of the earl of Murray made no favourable alteration in the affairs of Mary. Confusion and disorder prevailed throughout the kingdom; and though the friends of the queen were promised assistance from France, nothing effectual was done for them. At last the regency was conferred upon the earl of Lenox; an enemy to his queen, and who treated her friends with the utmost rigour. At the same time Elizabeth continued to amuse with negotiations her unhappy rival. She granted liberty to the bishop of Ross to repair to the queen of Scots, who had been removed to Chatsworth, and to confer with her on the subject of the intended accord and treaty. Mary, conforming to the advances of Elizabeth, authorised the lord Levingston to pass to her dominions, and to desire her friends to appoint a deputation of their number to give their assistance in promoting the salutary purpose of establishing the tranquillity of their country: and after meeting with some interruptions upon the English borders from the earl of Suffex, this nobleman executed successfully his commission. The queen's lords gave powers to ten nobles to act in a body, or by two of their number, in the intended negociation: and a safe-conduct from Elizabeth allowed them to enter the English realm, and to remain in it during the space of six months.

760  
Articles of  
agreement  
proposed to  
Mary by  
Elizabeth.

While the lord Levingston was consulting the interests of Mary with her friends in Scotland, the bishop of Ross was making earnest suit with Elizabeth to proceed in the projected negociation. His solicitations were not ineffectual; and Sir William Cecil and Sir Walter Mildmay received the instructions of their mistress to wait upon the queen of Scots at Chatsworth. The heads of accommodation which they proposed were explicit and particular; and the rigour they discovered towards the Scottish princess seemed to vouch their sincerity. It was proposed, that a perfect amity should take place between the two queens; that all the treaties which had formerly been concluded by the two nations should receive an ample confirmation; that the queen of Scots should ratify the treaty of Edinburgh, and forbear from advancing any title or claim to the crown of England during the life of Elizabeth, or to the prejudice of the heirs of her body; that in case of foreign invasions, the two realms should mutually assist each other; that all foreign soldiers should be ordered to depart out of Scotland; that in the future, strangers of the profession of arms should be prohibited from repairing to it, and from taking up their residence in any of its castles or houses of strength; that Mary should hold no correspondence, directly or indirectly, with any subject of England, without the permission of the English queen; that the earl of Northumberland, and the English rebels in Scotland, should be delivered up to Elizabeth; that redress should be given to the subjects of England for the spoils committed upon them by the Scottish borderers; that the murderers of the lord Darnley and the earl of Murray should be duly and effectually punished; that before the queen of Scots should be set at liberty, the young prince her son should be brought into England, and that he should continue in the keeping of Elizabeth till the death of his mother, or till her resignation to him of her crown on at-

taining his majority; that the queen of Scots should not enter into a negociation for her marriage without the knowledge of the queen of England, nor conclude it without her approbation, or that of the greatest part of the Scottish nobility; that none of the subjects of Scotland should be suffered to go to Ireland without the safe-conduct of Elizabeth; and that Mary should deliver to her sister all the testimonies and writings which had been sent from France, renouncing and disavowing the pretended marriage between her and the duke of Anjou. Besides these articles of agreement, it was proposed by another treaty to adjust the differences of the queen of Scots and her subjects; and Sir William Cecil and Sir Walter Mildmay embraced the present opportunity of conferring with her upon this business, under the pretence of facilitating its management in the future stages of its progress.

During their stay at Chatsworth, these statesmen were completely satisfied with the behaviour of the queen of Scots. The candour, sincerity, and moderation, which she displayed, were full assurances to them that upon her part there was no occasion to apprehend any improper policy or art; and the calamities of her condition were a still securer pledge of her compliance. Elizabeth, upon hearing their report, affected to be highly pleased with her sister, and sent a message to the earl of Lenox, instructing him in the conditions which had been submitted to Mary; and desiring him to dispatch commissioners into England to deliberate in the treaty, and to consult his interest and that of his faction. Nor did Mary neglect to transmit to her friends in Scotland the proposed terms of agreement; and the bishop of Ross, who had assisted her in the conferences with Sir William Cecil and Sir Walter Mildmay, conveyed intimations of them to the pope, the king of France, and the duke of Alva; besought their advice, and informed these princes, that unless an effectual relief could be expected from their favour, the necessities of her condition would compel her to subscribe to the hard and humiliating dictates of the queen of England.

But while Mary and her friends were indulging the hope of a termination to her troubles, Elizabeth was secretly giving comfort to her adversaries, and encouraging them to throw obstacles in the way of the treaty. Sir William Cecil wrote to the regent, expressing his disapprobation of the negociations at Chatsworth; desiring him not to be apprehensive of the boastings of the adherents of the queen of Scots; and advising him to make choice of commissioners, in the name of the king, in whose constancy and fortitude he could rely, and whom no address could allure from his interest, or from the common cause in which he and his friends were embarked. The earl of Suffex also sent him dispatches, in which he admonished him to turn his anxious attention to the approaching negociation, and to insist on secure stipulations for the preservation of the prince, for his own safety, and for a general indemnity to the nobles and their adherents, whose party he had espoused. In every event, he represented it as proper for him to pay the greatest respect to Elizabeth; and, if no treaty should be concluded, he advised him to be prepared for reducing the friends of Mary to obedience, and for defending himself against invasions from abroad. By these artifices, the regent and his faction

Scotland.

761  
Mary is de  
scribed to  
negociate.

762  
The insin-  
cerity of  
Elizabeth.

land. faction were inclined to intimate to Elizabeth their warm dissatisfaction with the terms of agreement which she had proposed to Mary; and Pitcairn abbot of Dunfermline, who had been appointed secretary of state in the room of Maidland of Lethington, was deputed to her upon this business. He exclaimed against the treaty as wild and impolitic; and contended, that no stipulations could bind Mary, whose religion taught her to keep no faith with heretics; that her claims to the English crown, and her resentment against the queen of England, as well as her own subjects, would immediately upon her restoration, involve the two kingdoms in blood; and that no peace or quiet could be expected or enjoyed, but by adhering to the salutary maxim of detaining her in a sure and close captivity. Elizabeth did not discourage these inclement sentiments; and Pitcairn was assured by her, that from her natural love to the king, and her regard to the nobles who upheld his authority, she would faithfully provide for their security; and that if justice should appear decisively upon their side, she would even strenuously maintain their quarrel and their consequence.

Mary had been carried to Sheffield, and was recovering from a feverish indisposition. To this place the bishop of Galloway and the lord Levingston, who had been selected by her friends to be her acting deputies in England, repaired in order to impart to her the state of affairs in Scotland, and to receive her commands. After repeated conferences on the subject of the approaching treaty, she gave them her commission and instructions, and joining them to the bishop of Ross, sent them to Elizabeth. They claimed an audience of this princess, and were admitted to it at Hampton-court. Having presented their credentials, they informed her, that they were ready to conclude a treaty of concord and agreement, upon principles the most extensive and liberal; and, representing to her the impoverished and tumultuous state of their country, they begged her to proceed in the business with expedition. The orders, they said, which they had received, and their own inclinations, disposed them to follow her advice and counsel in all points which were honourable and consistent with reason; and as her protection was the only refuge of the adversaries of their queen, they took the liberty to observe, that it was completely in her power to put a period to all disturbances and animosity, and to accomplish an accord, which would not only confer upon her the highest reputation, but be of the most signal utility to the two kingdoms. Elizabeth declared, that it would please and flatter her in no common degree to advance in the negotiation; and that it was a pain to her that the regent, by his delay in sending commissioners, should discover any aversion from it. This answer was deemed very favourable by the bishop of Ross and his associates; and they obtained her authority to dispatch a messenger to the regent to hasten his operations.

In the mean time, Mary received dispatches from the pope, the king of France, and the duke of Alva; and they concurred in recommending it to her to accept of the articles of accommodation which were offered by Elizabeth. The Turk was giving employment to the pope and the king of Spain; Charles IX. already enfeebled by the obstinate valour of the Huguenots, was busy in deceiving them with appearances of peace, and

in plotting their overthrow; and the duke of Alva felt himself insecure in his government of the Netherlands. But while they strongly advised Mary to conclude an agreement with the queen of England, they were yet lavish to her of their expressions of a constant amity; and if the treaty should miscarry, they promised to make the most strenuous exertions in her behalf, and to assist her adherents with money, ammunition, and troops.

The earl of Morton, the abbot of Dunfermline, and Mr James Macgill, had been appointed by the regent and his faction to be their commissioners in the name of the king; and at length their arrival was announced to Elizabeth. Conforming to the spirit of their party, the earl of Morton and his colleagues took an early opportunity to justify to her the deposition of the queen of Scots, and by this means to interrupt the progress of the treaty. In an elaborate memorial, they affected to consider Mary as unworthy to reign, and asserted the constitutional power of the people to curb her ambition, and to throw her down from royalty. They endeavoured to intrench themselves within the authority of laws, civil, canon, and municipal; and they recited opinions to her prejudice by many pious divines. But though the general position, that the people have a title to resist the domination of the sovereign is clear and undubitable; yet their application of it to the queen of Scots was wildly precarious and improper. To speak of her tyranny, and her violation of the rights of her people, was even a wanton mockery of truth and justice; for instead of having assumed an illegal exorbitancy of power, she had suffered in her own person and rights, and had been treated by her subjects with the most cruel and tyrannical insolence. Elizabeth, who was unwilling and afraid to enter anew into the conduct of Mary, who was fully sensible of the insolence of her adversaries, and who did not approve of any maxims that pressed against the majesty of princes, received their memorial with surprise and indignation. She perceived not, she told them, any reason that could vindicate the severity which had been shown to the queen of Scots by her enemies; and advised them to consider, that in the present negotiation it was their proper business to consult the security of the king and of their faction.

Upon the part of Elizabeth, the commissioners were the lord keeper Bacon, the earls of Suffolk and Leicester, the lord Clynton, the lord chamberlain, Sir William Cecil, who about this time was created lord Burleigh, Sir Francis Knollys, Sir James Croft, Sir Walter of the Mildmay, and Sir Thomas Smith. The deputies of Mary were invited to meet with the English commissioners in the house of the lord keeper; and after he had stated the general purposes of the treaty, he intimated to them, that there were two points which required a particular discussion. A proper security, he said, ought to be given by the queen of Scots for her due performance of the stipulations of the agreement with Elizabeth; and it was expedient to concert the mode of the pardon and indemnity which she was to extend to the subjects of Scotland who had offended her. As an assurance of the accommodation with his mistress, he demanded, that the duke of Chatelherault, the earls of Huntly and Argyle, the lords Hume and Herries, with another person of high rank, should be surrendered to her,

Scotland.

765

The regent and his faction attempt to justify the deposition of Mary.

766

Elizabeth's commissioners hold conferences with those of Scots.

Scotland. her, and remain in England for three years; that the castles of Dumbarton and Hume should be in her possession during the same period; and as to the article concerning the delivery of the prince into her custody, he observed, that it would be required from the regent, the queen of Scots not having the power of its performance. The deputies of Mary, surpris'd with this language, intreated the English delegates to reflect, that their queen, if deprived of the most faithful of her nobles, and of her strongest forts, could have little desire or ambition to return to her own kingdom; for she would thus be unable to protect herself against the turbulence of her subjects, and be a sovereign without friends, and without strength. They were inclined, they said, to put their commission and powers to the fullest stretch, in order to gratify Elizabeth; and they would agree, that two earls and two barons should be surrendered for two years, as hostages of the fidelity of their sovereign; under the restriction, that they might be exchanged every six months for persons of an equal condition, if they should be desirous of returning to their own country. As to the giving up of any forts or castles, they would not agree to it, because among the other inconveniences of this measure, similar claims would be competent to the king of France, by the spirit of the treaty of Edinburgh, which stipulated, that no French or English troops should be admitted into Scotland. The lord keeper Bacon, resuming his discourse, told them, that the whole realm of Scotland, its prince, nobles, and castles, were an inadequate pledge to the queen of England; and that, if his advice would be followed, the queen of Scots should not obtain her liberty upon any kind of security which could be granted by the Scottish nation. In all public treaties, said the delegates of Mary, no further assurance can be required from a sovereign than what consists with his safety; and when exactions are pressed from a contracting party in a league which are ruinous and impossible, it is understood that a foundation is sought to break off the negociation. The English commissioners, now interfering in a body, declared upon their honour, that it was the meaning of Elizabeth to agree to the restoration of the queen of Scots to her crown and realm upon receiving sufficient assurances for the articles of the accommodation; that the security offered for her acceptance, should be submitted to her deliberation; and that they would immediately proceed to confer with the deputies for the king of Scots.

767  
And with  
the king's  
deputies

The English commissioners were not unacquainted with the sentiments of the earl of Morton and his colleagues; and it was from this quarter that they expected a resolute and definitive interruption to the treaty. Nor did these delegates disappoint the expectations conceived of them. After affecting to take a comprehensive view of the articles under debate, they declared, that their commission gave them authority to treat about the amity of the two kingdoms, and the maintenance of the true religion; but that it conferred upon them no power to receive their queen into Scotland, or to surrender to Elizabeth the person of their king. They therefore begged not to be urged to accede to a league which, in some future period, might expose them to a charge of high treason.

768  
Elizabeth  
obstructs  
the treaty.

This singular declaration was considered to be solid and weighty by the English commissioners; and, in a

new conference, it was communicated by them to the deputies of Mary. The bishop of Ross and his associates were disgusted with this formal impertinence. They did not hesitate to pronounce the plea of an insufficient commission from the king to his delegates to be an unworthy and most frivolous subterfuge. The authors, they said, of the deposition of their sovereign did not need any authority but their own to fetter her at liberty; the prince was not yet five years of age, and could give them no instructions: and the regent was wholly dependent upon the will and pleasure of the queen of England. It was represented in return by the English delegates, that the commission of king James to his deputies, having been perused by Elizabeth, was accounted by her to be insufficient; and that it was her opinion, that the earl of Morton should return to Scotland to hold a parliament for obtaining new powers. The bishop of Ross exclaimed, that the queen of Scots had been amused with deceitful promises, that the prudence of Elizabeth had been corrupted by partial counsels, and that the allegations and pretences held out for interrupting the negociation were affected and unreal. The instructions, he said, from his sovereign to her commissioners, were to negotiate and to conclude, and not to trifle; and they would not by any means consent to protract, by artificial delays, a treaty which the queen of England, if her intentions were sincere and right, could immediately terminate upon reasonable and honourable terms. His speech and his demeanour he acknowledged to be free and open; and he besought them to excuse him, since, having been made an instrument to abuse his mistress with false hopes, he could not but resent the indignity, and express what he knew and what he felt. The English deputies, addressing him and his colleagues, observed, that as the friends of Mary, and those of the king her son, could not come to an agreement, and as their queen was refused the assurance she expected, they held their commission to be at an end, and were no longer at liberty to negotiate.

The insincerity of Elizabeth, and the failure of the league or agreement, filled Mary with resentment and complaints. Her animosities, and those of Elizabeth, were increased and fortified. She was in haste to communicate to her allies the unworthy treatment she had received; and she sent her commands to her adherents in Scotland to rise up in arms, to repose no trust in truces which were prejudicial and treacherous, and to employ all their resources and strength in the humiliation of the regent and his faction. Elizabeth, who by this time apprehended no enterprise or danger from Charles IX. or the duke of Alva, resolved, on the other hand, to give a strong and effectual support to the king's friends, and to disunite by stratagem, and oppress by power, the partizans of the Scottish princefs. The zeal of the bishop of Ross having raised her anger, she commanded him to depart from London; and Mary, in contempt of her mandate, ordered him to remain there under the privilege of her ambassador. The high and unbroken spirit of the Scottish queen, in the midst of her misfortunes, never once awakened the generous admiration of Elizabeth. While it uniformly inflamed her rage, it seems also to have excited her terror. With a puillanimous meanness, she sent a dispatch to the earl of Shrewsbury, instructing him to keep his charge in the closest

769  
The agita-  
ted condi-  
tion of the  
two queens



Scotland. closest confinement, and to be incessantly on his guard to prevent her escape. He obeyed, and regretted her severity. The expence, retinue, and domestics, of the queen of Scots, were diminished and reduced, and every probable means by which she might endeavour to obtain her liberty were removed from her. The rigours, however, that invaded her person could not reach her mind; and she pitied the tyrant that could add contumely to oppression, and deny her even the comforts of a prison.

770  
readful  
confusion in  
Scotland.  
All this time Scotland was involved in the miseries of civil war. The friends of Mary were everywhere punished with fines and forfeiture. Private families took the opportunity of the public confusion to revenge their quarrels against each other. Individuals of every denomination ranged themselves on the side either of the regent or of the queen, and took a share in the hostilities of their country. Fathers divided against sons, and sons against their fathers. Acts of outrage and violence were committed in every quarter, while, amidst the general confusion, religion was made the pretence by both parties.

771  
the regent  
taken prisoner,  
and put  
to death.  
In the mean time, though many encounters took place between the two factions, yet neither party seems to have been conducted by leaders of any ability or skill in military affairs. This year, in one of these skirmishes, the regent himself was taken prisoner by a party of the queen's faction, and put to death. But this event made little alteration in the affairs of the nation. The earl of Marre, another of the queen's enemies, was chosen to the regency: but though he proposed to act against her party with rigour, he was baffled before Edinburgh castle, which was still held by her friends; and some bloody skirmishes were fought in the north, where victory declared in favour of the queen. These advantages, however, were more than compensated to the other party by the following event.

772  
Norfolk's  
conspiracy.  
While the negociations with Elizabeth for Mary's restoration were depending, the scheme of a conspiracy for her deliverance was communicated to her by Robert Ridolphi a Florentine, who lived in London many years as a merchant, and who was secretly an agent for the court of Rome. But to his letters, while the fate of the treaty was uncertain, she returned no reply. Its miscarriage, through the duplicity of Elizabeth, recalled them forcibly to her attention, and stimulated her to seek the accomplishment of her liberty by measures bolder and more arduous than any which had been hitherto employed by her. She drew up in cipher an ample discourse of his communications and of her situation, and dispatched it to the bishop of Ross, together with letters for the duke of Norfolk. Her instructions to this ecclesiastic were to convey the discourse and letters expeditiously to Norfolk, and to concert an interview between that nobleman and Ridolphi. The confidential servants by whom the duke acted with the bishop of Ross were Bannister and Barker; and having received from them the discourse and the letters, they were deciphered by Hickford his secretary. Having considered them maturely, he delivered them to Hickford, with orders to commit them to the flames. His orders, however, were disobeyed; and Hickford deposited them, with other papers of consequence, under the mats of the duke's bed-chamber. The contents of the discourse and the let-

Scotland. ters awakening the hope and ambition of Norfolk, he was impatient to see Ridolphi; and the bishop of Ross soon brought them together. Ridolphi, whose ability was inspirited by motives of religion and interest, exerted all his eloquence and address to engage the duke to put himself at the head of a rebellion against his sovereign. He represented to him, that there could not be a season more proper than the present for achieving the overthrow of Elizabeth. Many persons who had enjoyed authority and credit under her predecessor were much disgusted; the Roman Catholics were numerous and incensed; the younger sons of the gentry were languishing in poverty and inaction in every quarter of the kingdom; and there were multitudes disposed to insurrection from restlessness, the love of change, and the ardour of enterprise. He insinuated to him, that his rank, popularity, and fortune, enabled him to take the command of such persons with infinite advantage. He insisted upon his imprisonment and the outrages he had sustained from Elizabeth; represented the contempt to which he would expose himself by a tame submission to wrongs; extolled the propriety with which he might give way to his indignation and revenge; and painted out the glory he might purchase by the humiliation of his enemies, and by the full accomplishment of his marriage with the queen of Scots. To give a strength and confirmation to these topics, he produced a long list of the names of noblemen and gentlemen with whom he had practised, and whom he affirmed to be ready to hazard their lives and riches for a revolution in the state, if the duke would enter into it with cordiality. To fix decisively the duke, he now opened to him the expectations with which he might flatter himself from abroad. The pope, he assured him, had already provided 100,000 crowns for the enterprise; and if Popery should be advanced in England, he would cheerfully depay the whole charges of the war. The king of Spain would supply 4000 horse and 6000 foot, which might be landed at Harwich. Charles IX. was devotedly attached to the queen of Scots, notwithstanding the treaty which had been entered upon with Elizabeth for her marriage with his brother the duke of Anjou: and when he should discover that, on the part of the English princeps, this matrimonial scheme was no better than a device or a mockery, he would renounce the appearance of friendship he had assumed, and return to his natural sentiments of disdain and hatred with redoubled violence. In fine, he urged, that while he might depend on the assistance and arms of the greatest princes of Christendom, he would intitle himself to the admiration of all of them by his magnanimous efforts and generous gallantry in the cause of a queen so beautiful and so unfortunate.

773  
Discovered  
by the ministers  
of Elizabeth.  
The duke of Norfolk, allured by appearances so plausible and flattering, did not scruple to forget the duties of a subject, and the submissive obligation in which he had bound himself to Elizabeth never more to interfere in the affairs of the Scottish princeps. Ridolphi, in this forward state of the business, advised him to address letters to the Pope, the king of Spain, and the duke of Alva, expressive of his concurrence in the design, and inspiriting their activity and resolutions. He even produced dispatches framed for this purpose; and while he intreated the duke to subscribe them, he offered to carry them himself to Flanders,

L

Rome,

Scotland. Rome, and Spain. The duke of Norfolk, who was ambitious and timid, disposed to treason, and unfit for it, hesitated whether he should subscribe the letters; and at length refused to proceed to that extremity. He yet allowed the bishop of Rofs, and Barker his servant, to go to the Spanish ambassador to express his approbation of the measures of Ridolphi, to acknowledge that the letters were according to his mind, and to empower this statesman to certify their authenticity to his court. Ridolphi, full of hopes, set out to execute his commission. He passed first to the duke of Alva, to whom he communicated the transactions in which he had been engaged, and with whom he held many conferences. There was at this time at Bruxelles Charles Bailly, a servant of the queen of Scots; and Ridolphi, after disclosing to him his proceedings with Alva, entrusted him with letters to her to the duke of Norfolk, the Spanish ambassador, and the bishop of Rofs. When this messenger reached Calais, a letter was delivered to him from the bishop of Rofs, desiring him to leave his dispatches with the governor of that place. From inexperience and vanity he neglected this notice; and being searched at Dover, his letters, books, and clothes were seized, and he himself was sent to London, and imprisoned in the Marshalsea. The bishop of Rofs, full of apprehensions, applied to lord Cobham, the warden of the cinque ports, who was friendly to the duke of Norfolk; and obtaining by his means the packet of dispatches from Ridolphi, he substituted another in its place, which contained letters of no danger or usefulness. He had also the dexterity to convey intelligence of this trick to Bailly, and to admonish him to preserve a profound silence, and not to be afraid. This simple and unpractised agent had, however, excited suspicions by the symptoms of terror he had exhibited upon being taken, and by exclaiming, that the dispatches he brought would involve his own destruction and that of others. At his first examination he confessed nothing: but being sent to the tower, and put upon the rack, he revealed his conversations with Ridolphi, and declared, that the dispatches which he had brought had been delivered to the bishop of Rofs. An order was granted for taking the bishop into custody. Having been aware, however, of his perilous situation, his house was searched in vain for treasonable papers; and he thought to screen himself from answering any interrogatories under the sanctity of his character as the ambassador of an independent princess.

<sup>774</sup> An unexpected incident excited, in the meanwhile, new suspicions and alarms. Mary being desirous of transmitting 2000 crowns to the lord Herries to advance her interests in Scotland, the duke of Norfolk undertook to convey it to him with safety. He intrusted it to the charge of his confidants Hickford and Barker, who putting it into a bag with dispatches from their master to lord Herries, ordered a servant called *Brown* to carry it to Bannister; who, being at this time on the border, could forward it to Scotland. Brown, suspicious or corrupted, instead of proceeding on his errand, carried the bag and its contents to Sir William Cecil, now lord Burleigh. The privy-council, deeming it treason to send money out of the realm for the use of the friends of Mary, whom they affected to consider as enemies, ordered Hickford and Barker to be

Scotland. apprehended. The rack extorted from them whatsoever they knew to the prejudice of their master. Hickford gave intelligence of the fatal discourse and the letters from Mary, which he had preserved in opposition to the orders given to him. All the proceedings between the queen of Scots, the duke of Norfolk, the bishop of Rofs, and Ridolphi, were brought to light. A guard was placed upon the house of the duke of Norfolk, in order to prevent his escape. Sir Ralph Sadler, Sir Thomas Smith, Sir Henry Nevil, and Dr Wilson, were commissioned to examine him; and being impressed with the belief that the discourse and the letters had been destroyed, he positively denied that he had any concern in the affairs of the queen of Scots, or any knowledge of them whatsoever. He was committed to the tower a close prisoner. Bannister by this time was taken; and he confirmed the relations of Hickford and Barker. In the course of their discoveries, there appeared reasons of suspicion against many persons of rank and distinction. The earls of Arundel and Southampton, the lord Cobham, Mr Thomas Cobham his brother, Sir Thomas Stanley, Sir Henry Percy, and other gentlemen who were friendly to the queen of Scots and the duke of Norfolk, were ordered to be lodged in different prisons; and the rack, and the expectation of a pardon, drew from them the fullest confessions. The duke was altogether unable to defend himself. The concurring testimonies of his friends and servants, with the discourse and the letters, which he fondly imagined had been committed to the flames, were communicated to him. He was overwhelmed with amazement and distress; and exclaimed, that he had been betrayed and undone. He made ample acknowledgments of his guilt, and had no foundation of hope but in the mercy of his sovereign.

By the confession of the duke himself, and from all the inquiries which had been made by the ministers of Elizabeth, it appeared obvious beyond a doubt, that the bishop of Rofs had been the principal contriver of the conspiracy. Ridolphi had acted under his direction, and he had inspired the duke of Norfolk. He had even proceeded to the extremity of advising that nobleman to put himself at the head of a select band of adherents, and to seize boldly the person of Elizabeth. In his examinations he was treated with great rigour and insult. But he made an able defence, and peremptorily refused to make any answer to interrogatories. The counsellors of Elizabeth were disturbed with his obstinacy; and having certified him, that the rack would soon render him more pliant, he was ordered into close keeping in a dark apartment of the tower.— When he had remained a few days in this melancholy situation, four privy-counsellors, the lord admiral, the lord Burleigh, Sir Francis Knollys, and Sir Thomas Smith, went to the tower, and caused him to be brought to them to the lieutenant's lodging. After having assured him that he was charged by all the prisoners as the principal contriver of the conspiracy, they insisted, in the name of their sovereign, that he should explain fully the part he had acted. The confessions of the duke of Norfolk and his servants, of the lord Lumley, Sir Thomas Stanley, and other gentlemen, with the discourse and dispatches of the queen of Scots, were set before him. They now protested

<sup>775</sup> Dangerous and perplexing condition of bishop Lestly.

Scotland. upon their honour, that if he would make a free and open declaration of his proceedings, it should neither be employed against himself, nor against any other person; but that if he should continue to be resolute in refusing to give this satisfaction to their queen, who was anxious to search the matter to the bottom, they were instructed to let him know, that she would absolutely consider him as a private person, and order him to be tried and executed as a traitor. In this extremity he accepted the conditions held out to him, and disclosed minutely all the transactions of the principal parties in the conspiracy. But while he described the offences of his mistresses, the duke of Norfolk, and himself, he could not avoid to detract from their blame by apologies. It was natural, he said, for the queen of Scots to exert the most strenuous endeavours in her power to recover her freedom and crown; and the methods she adopted to obtain her purposes ought to be considered in connection with the arts of Elizabeth, who pertinaciously denied her access to her presence, who kept her a close prisoner in contempt of all the principles of humanity and justice, and who afforded an open and powerful assistance to her enemies. The duke of Norfolk he was earnest to excuse on the foundation of the advances which had been made in his marriage with the queen of Scots. Their plighted love, and their engagements, did not allow him to forsake her. As for himself, he was her ambassador and her servant; and being highly indebted to her generosity and kindness, he could not abandon her in captivity and distress without incurring the guilt of the most sinful treachery and ingratitude. The daring proposal he had made to seize the person of Elizabeth was the point, he observed, which seemed to press upon him the most severely; and he intreated them to believe, that he had moved it only with the view of trying the courage of the duke of Norfolk.— The privy-counsellors of Elizabeth were now in possession of all the evidence they could expect in this important business. Norfolk was admonished to prepare for his trial; and bishop Lesly perceived, that though he might escape with his life, he would never more be permitted to reside in England, and to act there as the ambassador, the minister, and the friend of the queen of Scots.

726  
Mary's infamy ruined the faith of Norfolk's conspiracy,  
The defeat of the duke of Norfolk's conspiracy was a blow to Mary which she could never recover. Her most faithful friends were languishing in prisons upon her account; she had no longer the counsels of the bishop of Ross; and the Spanish ambassador, who had entered into her concerns with an unscrupulous cordiality, had been ordered to withdraw from England. The trial and condemnation of Norfolk soon followed, and plunged her into the most calamitous distress.

777  
The massacre of the Protestants at Paris in 1572 proved also extremely detrimental to her. It was interpreted to be a consequence of the confederacy which had been formed at Bayonne for the extermination of the reformed. The Protestants were everywhere transported with rage against the Papists. Elizabeth prepared herself against an attack from the Roman Catholic powers; and was haunted with the notion that they meant to invade her kingdom, and to give it to the queen of Scots. Her ambassador at Paris, Sir Francis Walsingham, augmented her apprehensions and terror. He compared her weakness with the strength of her ene-

mies, and assured her that if they should possess themselves of Scotland, she would soon cease to be a queen. He represented Mary as the great cause of the perils that threatened her personal safety and the tranquillity of her kingdom; and as violent diseases required violent remedies, he scrupled not to counsel her to unite Scotland to her dominions, and to put to death a rival whose life was inconsistent with her security. The more bigotted Protestants of Scotland differed not very widely in their sentiments from Sir Francis Walsingham; while those of them who were more moderate were still more attached to their religion than to Mary; and amidst the indignation and horror into which the subjects of Scotland were thrown by the sanguinary outrages of Charles IX. and Catharine de Medicis, they surveyed the sufferings of their sovereign with a diminished sympathy.

779  
The regent dies, and is succeeded by Morton,  
This year the regent, finding himself beset with difficulties which he could not overcome, and the affairs of the nation involved in confusion from which he could not extricate them, died of melancholy, and was succeeded by the earl of Morton.

780  
Epicopacy introduced into Scotland.  
During the regency of the earl of Marre, a remarkable innovation took place in the church, which deserves to be particularly explained, being no less than the introduction of Episcopacy instead of the Presbyterian form of worship. While the earl of Lenox was regent, the archbishop of St Andrew's was put to death, because he was strongly suspected to have had a concern in the death of the earl of Murray; after which the earl of Morton procured a grant of the temporalities of that see. Out of these he allotted a stipend to Mr John Douglas, a Protestant clergyman, who took upon him the title of archbishop. This violence excited censure and murmurs. In the language of the times, it was pronounced to be a profanation of the kirk, and a high contempt of God; and it underwent the scrutiny of the ministry in applications and complaints to the regent. The matter was doubtless of too much importance to be overlooked; and a commission of privy-counsellors and clergymen was appointed in the name of the king to inquire into it, and to reform and improve the policy of the church. This commission, upon the part of the privy-council, consisted of the earl of Morton, the lord Ruthven, Robert abbot of Dunfermline, Mr James Macgill, Sir John Ballenden, and Colin Campbell of Glenorchie; and upon the part of the church there were named John Erskine of Dun, and Mr John Winram, Mr Hay, Mr Lindfay, Mr Pont, and Mr John Craig. The consultations and debates were long; and the influence and management of the earl of Morton directed their determinations. It was resolved, that till the majority of the king, or till the wisdom of the three estates should be consulted, the titles of archbishop and bishop should continue as in the times which preceded the reformation; and that a chapter of learned ministers should be annexed to every metropolitan or cathedral seat. It was determined that the sees, as they became vacant, should be given to those of the Protestant ministry who were most eminent for their qualifications; that the archbishops and bishops should exercise no higher jurisdiction than what was permitted to superintendants; and that they should be subject to the controul of the general assemblies of the church. It was agreed, that all abbots, priors, and

Scotland

other inferior prelates presented to benefices, should be examined by the bishop or superintendent of the diocese or precinct where the preferment was situated; and that their fitness to represent the church in parliament should be duly inquired into. It was judged that the king and the regent should recommend qualified persons to vacant bishoprics, and that the elections of them should be made by the chapters of the respective cathedrals. It was ordered that all benefices with cure under prelaties should only be disposed of to officiating ministers; that every minister should receive ordination from the bishop of the diocese, or the superintendent of the province; and that the bishops and superintendants, upon the ordination of ministers, should exact an oath from them to recognize the authority of the king, and to pay canonical obedience to their ordinary in all things that were lawful.

By these artificial regulations the earl of Morton did not mean solely to consult his own rapacity or that of the nobles. The exaltation of the Protestant church to be one of the three states was a consequence of them; and the clergy being the strenuous enemies of Mary, he might by their means secure a decided influence in parliament. The earl of Marre, as regent, giving his sanction to the proceedings of the commission, they were carried into practice. The delusive expectation of wealth, which this revival of Episcopacy held out to the ministry, was flattering to them; and they bore with tolerable patience this severe blow that was struck against the religious policy of Geneva. Mr John Douglas was desired to give a specimen of his gifts in preaching; and his election took effect, notwithstanding the opposition that was made to it by John Knox and other ecclesiastics, who stood up for the rules and forms which had been established at the reformation. He was inaugurated in his office by the bishop of Caithness, Mr John Spotswood superintendent of Lothian, and Mr David Lindsay, who violating the book of discipline, communicated to him his character and admission by the imposition of hands. This was a singular triumph to Episcopacy; and the exaltation of Douglas included other peculiarities remarkable and offensive. He denied that he had made any simoniacal agreement with the earl of Morton; yet it was known that the revenues of the archbishopric were almost wholly ingrossed by that nobleman. He had promised to resign, upon his insalment, the office of rector which he held in the university of St Andrew's: yet he refused to execute this engagement. He was in a very advanced age; and his mental qualifications, which had never been eminent, were in a state of decay.

A general assembly, which was holden at St Andrew's, considering the high moment of the new regulations introduced into the church, appointed commissioners to go to John Knox, who was at this time indisposed, and to consult with him deliberately in his house, whether they were agreeable to the word of God. But from the arts of the nobles, or from the sickness of Knox, it happened that this conference was not carried into execution. In a general assembly, however, which met at Perth, the new polity was reported and examined. The names of archbishop, dean, arch-deacon, chancellor, and chapter, were excepted against as Popish distinctions, and as slanderous to the ears of pious Christians. A wish was expressed that they might

be exchanged for titles less profane and superstitious; and an unanimous protestation was made, that the new polity was merely a temporary expedient, and should only continue and prevail till a more perfect order should be obtained from the king, the regent, and the nobility. This tolerating resolution left the new polity in its full force; and a colourable foundation was now established for the laity to partake in the profits of bishoprics. The simoniacal passion of Morton and Douglas was not long a matter of singularity. Mr James Boyd was appointed to the archbishopric of Glasgow, Mr James Paton to the bishopric of Dunkeld, and Mr Andrew Graham to the see of Dumblain; and these compromising ecclesiastics, upon being allowed competencies to themselves, gratified their noble friends with the greatest proportion of their revenues. The virtue of the common people approved not this spirit of traffic; and the bishops of the new polity were treated openly with reproach or with ridicule.

The year 1572 is also remarkable for the death of John Knox, whose mistaken zeal had contributed not a little to bring upon the queen those misfortunes with which she was now oppressed. Neither by his death, however, nor by the change of the regency, could she now be relieved. The earl of Morton was so much devoted to Elizabeth, that he received particular instructions from her how to guide the young king. His elevation, indeed, gave the finishing stroke to the queen's affairs. He employed himself with success in dividing her party among themselves, and by his means the duke of Chatelherault and the earl of Huntley were induced to forsake her. As for Elizabeth, she was bent on putting Mary to death; but as no crime could be alleged against her in England, she thought it proper that she should be carried back to her death in her own dominions. This proposal, however, was rejected; and the friends who remained true to Mary once more began to indulge themselves in hopes of succours from France. New misfortunes, however, awaited them.—The castle of Edinburgh, which had hitherto been held for the queen by Kirkaldy of Grange, was obliged to surrender to an English army commanded by Sir William Drury. Kirkaldy was solemnly assured by the English commander of his life and liberty; but Elizabeth violated this capitulation, and commanded him to be delivered up to the regent. An hundred of his relations offered to become vassals to Morton, and to pay him 3000 merks yearly, if he would spare his life; but in vain: Kirkaldy and his brother Sir James were hanged at Edinburgh. Maitland of Lethington, who was taken at the same time, was poisoned in the prison-house of Leith.

The jealousy of Elizabeth did not diminish with the decline of Mary's cause. She now treated her with more rigour than ever, and patronised Morton in all the enormities which he committed against her friends. Lesly bishop of Ross had been long imprisoned in England, on account of his concern in the duke of Norfolk's conspiracy. Morton earnestly solicited the queen to deliver him up, and would undoubtedly have put him to death; but as he had acted in the character of ambassador from Mary, this was judged impolitic, and the prelate was suffered to depart for France. When he arrived there, he endeavoured in vain to stir up the emperor, the pope, and the duke of Alva, to exert themselves

Scotland

781

Death of John Knox.

782

Elizabeth received on putting Mary to death.

783

The castle of Edinburgh taken by the English party.

784

Mary treated with greater rigour than ever.

Scotland. selves in behalf of the queen of Scotland; and, in 1574, the misfortunes of his royal mistress were farther aggravated by the death of Charles IX. of France, and her uncle the cardinal of Lorraine. The regent, in the mean time, ruled with the most despotic sway. He twice coined base money in the name of his sovereign; and after putting it into circulation the second time, he issued orders for its passing only for its intrinsic value. The duke of Chatellerault happening to die this year, the regent took every method of ruining all those of his name and family. He committed to prison all the Hamiltons, and every person of distinction who had fought for the queen at the battle of Langside, and compelled them to buy their liberty at an exorbitant price. He instigated Douglas of Lochleven to assassinate lord Arbroath, and it was with difficulty that the latter escaped the ambush that was laid for him. Reid, the bishop of Orkney, having left his citate to pious and charitable uses, the regent prohibited the execution of the will, and took upon himself the administration. To be rich was a sufficient crime to excite his vengeance. He entered the warehouses of merchants, and confiscated their property; and if he wanted a pretence to justify his conduct, the judges and lawyers were ready at his call.

796  
Oppression  
and violence  
of  
Morton.

797  
Opposition  
to Episco-  
pacy.

In this disastrous period the clergy augmented the general confusion. Mr Andrew Melvil had lately returned from Geneva; and the discipline of its assembly being considered by him as the most perfect model of ecclesiastical policy, he was infinitely offended with the introduction of Episcopacy into Scotland. His learning was considerable, and his skill in languages was profound. He was fond of disputation, hot, violent, and pertinacious. The Scottish clergy were in a humour to attend to him; and his merit was sufficient to excite their admiration. Instigated by his practices, John Drury, one of the ministers of Edinburgh, called in question, in a general assembly, the lawfulness of the bishops, and the authority of chapters in electing them. Melvil, after commending his zeal and his motion, declaimed concerning the flourishing state of the establishment of Geneva; and having recited the opinions of Calvin and Beza upon ecclesiastical government, maintained, that there should be no office-bearers in the church whose titles were not seen in the book of God. He affirmed, that the term *bishop* was nowhere to be found in it in the sense in which it was commonly understood, as Christ allowed not any superiority among ministers. He contended that Christ was the only lord of his church, and that the ministers of the word were all equal in degree and power. He urged, that the estate of the bishops, beside being unlawful, had grown unseemly with corruptions; and that if they were not removed out of the church, it would fall into decay, and endanger the interests of religion. His sentiments were received with flattering approbation; and though the archbishop of Glasgow, with the bishops of Dunkeld, Galloway, Brechin, Dumblain, and the Isles, were present in this assembly, they ventured not to defend their vocation. It was resolved, that the name of

*bishop* conferred no distinction or rank; that the office Scotland. was not more honourable than that of the other ministers; and that by the word of God their functions consisted in preaching, in administering the sacraments, and in exercising ecclesiastical discipline with the consent of the elders. The Episcopal estate, in the meanwhile, was watched with anxious observation; and the faults and demerits of every kind, which were found in individuals, were charged upon the order with rudeness and asperity. In a new assembly this subject was again canvassed. It was moved, whether bishops, as constituted in Scotland, had any authority for their functions from the Scriptures? After long debates, it was thought prudent to avoid an explicit determination of this important question. But a confirmation was bestowed upon the resolution of the former assembly; and it was established as a rule, that every bishop should make choice of a particular church within his diocese, and should actually discharge the duties of a minister.

The regent, disturbed with these proceedings of the brethren, was disposed to amuse and to deceive them. He sent a messenger to advise them not to intrude and disfigure the established forms; and to admonish them, that if their aversion from Episcopacy was insurmountable, it would become them to think of some mode of ecclesiastical government to which they could adhere with constancy. The assembly taking the advantage of this message, made a formal intimation to him, that they would diligently frame a lasting platform of polity, and submit it to the privy-council. They appointed, accordingly, a committee of the brethren for this purpose. The business was too agreeable to be neglected; and in a short time Mr David Lindsay, Mr James Lawson, and Mr Robert Pont, were deputed to wait upon the regent with a new scheme of ecclesiastical government. After reminding him, that he had been a notable instrument in purging the realm of Popery, and begging that he would consult with them upon any of its articles which he thought improper or incomplete, they informed him, that they did not account it to be a perfect work to which nothing could be added, or from which nothing could be taken away; for that they would alter and improve it, as the Almighty God might farther reveal his will unto them. The regent, taking from them their schedule, replied, that he would appoint certain persons of the privy-council to confer with them. A conference was even begun upon the subject of their new establishment; but from his arts, or from the troubles of the times, no advances were made in it.

788  
Death of  
Bothwell.

This year the earl of Bothwell died in Denmark; and in his last moments, being stung with remorse, he confessed that he had been guilty of the king's murder, revealed the names of the persons who were his accomplices, and with the most solemn protestations declared the honour and innocence of the queen. His confession was transmitted to Elizabeth by the king of Denmark; but was suppressed by her with an anxious solicitude.

789  
Morton is  
compelled  
to resign his  
office of re-  
gent.

The regent still continued his enormities, till having rendered

(v) Jebb, Vol. II. p. 227. It has never been published. Keith and other historians have preserved what they call the earl of Bothwell's declaration at his death, and account it to be genuine. Their partiality for Mary induced them the more easily to fall into this mistake. The paper they give is demonstratively a forgery; and the want of the real confession of Bothwell is still a deficiency in our history.

Scotland

rendered himself obnoxious to the best part of the nobility, he was, in 1577, compelled to resign his office into the hands of James VI. ; but as his majesty was then only twelve years of age, a general council of twelve peers was appointed to assist him in the administration. Next year, however, the earl of Morton having found means to gain the favour of the young king, procured the dissolution of this council; and thus being left the sole adviser of the king, he hoped once more to be raised to his former greatness. This could not be done, however, without keeping the king in a kind of captivity, so that nobody could have access to him but himself. The king, sensible of his situation, sent a dispatch to the earls of Argyle and Athole, intreating them to relieve him. An army for this purpose was soon raised; and Morton's partisans were in danger of being defeated, had not the opposite party dreaded the vengeance of Elizabeth, who was resolved to support the earl of Morton. In consequence of this a negotiation was entered into, by which it was agreed, that the earl of Argyle, with some others, should be admitted into the king's council; and that four noblemen should be chosen by each party to consider of some proper method of preserving tranquillity in the nation.

790  
He poisoned  
the earl of  
Athole.

This pacification did not greatly diminish the power of Morton. He soon got rid of one of his principal antagonists, the earl of Athole, by poisoning him at an entertainment; after which he again gave a loose rein to his resentments against the house of Hamilton, whom he persecuted in the most cruel manner. By these means, however, he drew upon himself a general hatred; and he was supplanted in the king's favour by the lord d'Aubigny, who came from France in the year 1579, and was created earl of Lenox. The next year Morton was suspected of an intention to deliver up the king to Elizabeth, and a guard was appointed to prevent any attempts of this kind. The queen of England endeavoured to support her zealous partisan; but without effect. He was tried, condemned, and executed, as being concerned in the murder of Darnley. At the place of execution, it is said that he confessed his guilt; but of this the evidence is not quite satisfactory. It is however certain that he acknowledged himself privy to the plot formed against the life of the king; and when one of the clergymen attending him before his execution observed, that by his own confession he merited death in foreknowing and concealing the murder, he replied "Ay but, Sir, had I been as innocent as St Stephen, or as guilty as Judas, I must have come to the scaffold. Pray, what ought I to have done in this matter? You knew not the king's weakness, Sir. If I had informed him of the plot against his life, he would have revealed it even to his enemies and those concerned in the design; and I would, it may be, have lost my own life, for endeavouring to preserve his to no purpose."

792  
Monstrous  
cruelty of  
Elizabeth  
to Mary.

The elevation of king James, and the total overthrow of Morton, produced no beneficial consequences to the unfortunate Mary. In the year 1581, she addressed a letter to Castelnau the French ambassador, in which she complained that her body was so weak, and her limbs so feeble, that she was unable to walk. Castelnau therefore intreated Elizabeth to mitigate a little the rigours of Mary's confinement; which being refused, the latter had thoughts of resigning her claims to

the crown both of England and Scotland into the hands of her son, and even of advising him to use every effort in his power to establish his claim to the English crown as preferable to that of Elizabeth. But being apprehensive of danger from this violent method, she again contented herself with sending to the court of England ineffectual memorials and remonstrances. Elizabeth, instead of taking compassion on her miserable situation, assiduously encouraged every kind of disorder in the kingdom, on purpose to have the queen more and more in her power. Thus the Scottish malcontents finding themselves always supported, a conspiracy was at last entered into, the design of which was to hold James in captivity, and to overthrow the authority of Arran and Lenox, who were now the principal persons in the kingdom. The chief actors in this conspiracy were the earls of Gowrie, Marre, and Glencairn, the lords Lindsay and Boyd, with the mailers of Glamis and Oliphant. By reason of the youth and imbecillity of the king, they easily accomplished their purpose; and having got him in their power, they promised him his liberty, provided he would command Lenox to depart the kingdom. This was accordingly done; but the king found himself as much a prisoner as before. The more effectually to detain him in custody, the rebels contrained him to issue a proclamation, wherein he declared himself to be at perfect liberty. Lenox was preparing to advance to the king's relief with a considerable body of forces, when he was disconcerted by the king's peremptory command to leave Scotland; upon which he retired to Dumbarton, in order to wait for a more favourable opportunity. The earl of Arran, being more forward, was committed to close custody for some time, but afterwards confined only in his house of Kinneil. The rebels took upon them the title of "lords for the reformation of the state."

The clergy, who had all this time been exceedingly averse to Episcopacy, now gave open countenance to the lords of the reformation. On the 13th of October 1582, they made a solemn act, by which the *raid of Ruthven*, as the capture of the king was called, was deemed a service most acceptable to all who feared God, respected the true religion, and were anxious for the preservation of the king and state; and every minister was commanded to declaim from his pulpit upon the expediency of this measure, and to exhort the people to concur with the lords in prosecuting the full deliverance of the church, and the perfect reformation of the commonwealth. Not satisfied with this approbation of the clergy, the conspirators got their proceedings approved by the states of Scotland, as "a good, a thankful, and a necessary service to the king." At the same time it was enacted, that no suit civil or criminal of any kind should ever be instituted against the persons concerned in it. Soon after this, Lenox took his leave of Scotland, and sailed for France, where he died.

The unfortunate Mary was driven to despair when she heard that her son was taken prisoner by rebels who had been instigated by Elizabeth. In this distress, she addressed a most spirited letter to Elizabeth, in which she at once asserted her own innocence, and set forth the conduct of Elizabeth herself in such language as must have put the most impudent of her adversaries to the

793  
The king  
taken pri-  
soner.

794  
Which is  
approved  
of by the  
clergy.

795  
Mary  
writes to  
Elizabeth.

Scotland  
796  
who acts  
with her  
usual per-  
ty.

the blush. Elizabeth could not reply, and therefore had recourse to her usual arts of treacherous negotiation. New terms were proposed to Mary, who would gladly have submitted almost to any thing, provided she could procure her freedom. It was proposed, as had often been done before, to associate the queen of Scots with her son in the government; but as this was to be referred to the king, who was in the hands of Elizabeth's friends, and to the parliament, who were under the power of the same faction, it is easy to see that no such association ever could take place, or indeed was ever intended.

797  
rench an  
affairs  
sulted in  
cotland.

After the death of Lenox, the conspirators apprehended no further danger, little supposing that a prince so young and unexperienced could deliver himself from captivity. This, however, in the year 1583, he effected in the following manner. A convention of the estates had been summoned to meet at St Andrew's. James, whom the earl of Arran, notwithstanding his confinement at Kinneil, had found means to instruct and advise, pretended a desire of visiting his grand-uncle the earl of March, who resided at St Andrew's, and was for that purpose permitted to repair thither a few days before the convention. The better to deceive the earls of Gowrie, Angus, and Marre, who attended him, he took up his lodgings in an old inn, which was quite open and defenceless. But having expressed a desire to see the castle of St Andrew's, he was admitted into it; and colonel Stuart, who commanded the castle, after admitting a few of his retinue, ordered the gates to be shut. The earls of Argyle, Marischal, Montrose, and Røthes, who were in concert with the king, hastened to make him an offer of their swords. The opposite faction, being unprepared for hostilities, were filled with consternation. Of all the conspirators, the earl of Gowrie alone was admitted into the king's presence, by the favour of colonel Stuart, and received his pardon. The earls of March, Argyle, Gowrie, Marischal, and Røthes, were appointed to be a council for assisting the king in the management of his affairs; and soon after this James set out for Edinburgh. The king no sooner found himself at liberty, than, by the advice of his privy council, he issued a proclamation of mercy to the conspirators; but they, flattering themselves with the hopes of support from Elizabeth, obstinately refused to accept of his pardon. In consequence of this, they were denounced rebels. Elizabeth failed not to give them underhand all the encouragement she could, and the clergy uttered the most seditious discourses against the king and government; and while they railed against Popery, they themselves maintained openly the very characteristic and distinguishing mark of Popery, namely, that the clerical was entirely independent of the civil power.

799  
Earl of  
Gowrie  
condemned  
and execu-  
ed.

At last the rebels broke forth into open hostilities; but by the vigilance of Arran, the earl of Gowrie, who had again begun his treasonable practices, was committed to custody; while the rest, unable to oppose the king, who appeared against them with a formidable army, were obliged to fly into England, where Elizabeth, with her usual treachery, protected them.

The earl of Gowrie suffered as a traitor; but the severity exercised against him did not intimidate the clergy. They still continued their rebellious practices, until the king being informed that they were engaged

in a correspondence with some of the fugitive lords, citations were given to their leaders to appear before the privy-council. The clergymen, not daring to appear, fled to England; and on the 20th of May 1584, the king summoned a convention of the estates, on purpose to humble the pride of the church in an effectual manner. In this assembly the raid of Ruthven was declared to be rebellion, according to a declaration which had formerly been made by the king. And, as it had grown into a custom with the promoters of sedition and the enemies of order, to decline the judgment of the king and the council, when called before them to answer for rebellious or contumelious speeches, uttered from the pulpit or in public places, an ordination was made, asserting that they had complete powers to judge concerning persons of every degree and function; and declaring, that every act of opposition to their jurisdiction should be accounted to be treason. It was enacted, that the authority of the parliament, as constituted by the free votes of the three estates, was full and supreme; and that every attempt to diminish, alter, or infringe, its power, dignity, and jurisdiction, should be held and punished as treason. All jurisdictions and judgments, all assemblies and conventions, not approved of by the king and the three estates, were condemned as unlawful, and prohibited. It was ordained, that the king might appoint commissioners, with powers to examine into the delinquencies of clergymen, and, if proper, to deprive them of their benefices. It was commanded, that clergymen should not for the future be admitted to the dignity of lords of the session, or to the administration of any judicature civil or criminal. An ordination was made, which subjected to capital punishment all persons who should inquire into the affairs of state with a malicious curiosity, or who should utter false and slanderous speeches in sermons, declamations, or familiar discourse, to the reproach and contempt of the king, his parents, and progenitors. It was ordered that a guard, consisting of 40 gentlemen, with a yearly allowance to each of 200l. should continually attend upon the king. This parliament, which was full of zeal for the crown, did not overlook the history of Buchanan, which about this time was exciting a very general attention. It commanded, that all persons who were possessed of copies of his chronicle, and of his treatise on the Scottish government, should surrender them within 40 days, under the penalty of 200l. in order that they might be purged of the offensive and extraordinary matters they contained. This stroke of tyranny was furious and ineffectual. Foreign nations, as well as his own countrymen, were filled with the highest admiration of the genius of Buchanan. It was not permitted that his writings should suffer mutilation; they were multiplied in every quarter; and the severity exercised against them only served the more to excite curiosity, and to diffuse his reputation.

Scotland.  
800  
Proceed-  
ings against  
the clergy,

801  
Attempts  
to suppress  
Buchanan's  
history.

While the parliamentary acts, which struck against the importance of the church, were in agitation, the ministers deputed Mr David Lindsay to solicit the king that no statutes should pass which affected the ecclesiastical establishment, without the consultation of the general assembly. But the earl of Arran having intelligence of this commission, defeated it, by committing Mr Lindsay to prison as a spy for the discontented nobles. Upon the publication, however, of these acts

802  
The clergy  
endeavour  
to support  
themselves  
against the  
civil power.

Scotland

by the heralds, Mr Robert Pont minister of St Cuthbert's, and one of the senators of the court of session, with Mr Walter Balcanqual, protested formally in the name of the church, that it dissented from them, and that they were consequently invalid. Having made this protestation, they instantly fled, and were proclaimed traitors. By letters and pamphlets, which were artfully spread among the people, their passions were roused against the king and his council. The ministers of Edinburgh took the resolution to forsake their flocks, and to retire to England. And in an apology circulated by their management, they anxiously endeavoured to awaken commiseration and pity. They magnified the dangers which threatened them; and they held out, in vindication of their conduct, the example of the prophets, the apostles, the martyrs, and of Christ himself, who all concurred, they said, in opposing the ordinations of men, when contradictory to the will of heaven, and in declining the rage of the enemies of God. The king appointed his own chaplains and the archbishop of St Andrew's to perform the ministerial functions in his capital. The clergy over Scotland were commanded to subscribe a declaration, which imparted the supremacy of the king over the church, and their submission to the authority of the bishops. The national ferments still increased in violence. Many ministers refused to subscribe this declaration, and were deprived of their livings. It was contended, that to make the king supreme over the church was no better than to set up a new pope, and to commit treason against Jesus Christ. It was urged, that to overthrow assemblies and presbyteries, and to give dominion to bishops, was not only to overturn the established polity of the church, but to destroy religion itself. For the bishops were the slaves of the court, were schismatical in their opinions, and depraved in their lives. It was affirmed, that heresy, atheism, and popery, would strike a deep root, and grow into strength. And the people were taught to believe, that the bishops would corrupt the nation into a resemblance with themselves; and that there everywhere prevailed dissimulation and blasphemy, persecution and obscenity, the profanation of the scriptures, and the breach of faith, covetousness, perjury, and sacrilege. It was reported abroad, that the ministers alone were entrusted with ecclesiastical functions, and with the sword of the word; and that it was most wicked and profane to imagine, that Jesus Christ had ever committed the keys of the kingdom of heaven to civil magistrates and their servants or deputies.

While the clergy were thus impotently venting their wrath, Elizabeth, alarmed beyond measure at this sudden revolution, and terrified by a confession extorted by the rack from one Francis Throgmorton, concerning a combination of the Catholic princes to invade England, began to treat with Mary in a more sincere manner than usual; but having gained over to her side the earl of Arran, the only man of activity in Scotland, she resolved to proceed to extremities with the queen of Scots. The Roman Catholics, both at home and abroad, were inflamed against her with a boundless and implacable rage. There prevailed many rumours of plots and conspiracies against her kingdom and her life. Books were published, which detailed her cruelties and injustice to Mary in the most indignant lan-

guage of reproach, and which recommended her assassination as a most meritorious act. The earl of Arran had explained to her the practices of the queen of Scots with her son, and had discovered the intrigues of the Catholic princes to gain him to their views. While her sensibilities and fears were severely excruciating to her, circumstances happened which confirmed them in their strength, and provoked her to give the fullest scope to the malignity of her passions. Crichton, a Scottish Jesuit, passing into his own country, was taken by Netherland pirates; and some papers which he had torn in pieces and thrown into the sea being recovered, were transmitted to England. Sir William Wade put them together with dexterity; and they demonstrated beyond a doubt, that the invasion of England was concerted by the Pope, the king of Spain, and the duke of Guise. About this time, too, a remarkable letter was intercepted from Mary to Sir Francis Englefield. She complained in it that she could have no reliance upon the integrity of Elizabeth, and that she expected no happy issue to any treaty which might be opened for her restoration and liberty. She urged the advancement of the "great plot;" she intimated, that the prince her son was favourable to the "designment," and disposed to be directed by her advice; she intreated, that every delicacy with regard to her own state and condition should be laid aside without scruple; and she assured him, that she would most willingly suffer perils and dangers, and even death itself, to give relief to the oppressed children of the church. These discoveries, so exasperating to the inquietudes and distresses of Elizabeth, were followed by a deep and general consternation. The terror of an invasion spread itself with rapidity over England; and the Protestants, while they trembled for the life of their champion, were still more alarmed with the dangers which threatened their religion.

In this state of perplexity and distraction, the counsellors of Elizabeth did not forget that they had been her instruments in persecuting the queen of Scots, and of the severities with which she had treated the Roman Catholics. They were fully sensible, that her greatness and safety were intimately connected with their own; and they concurred in indulging her fears, jealousies, and resentment. It was resolved that Mary should perish. An association was formed, to which persons of every condition and degree were invited. The professed business of this association or society was the preservation of the life of Elizabeth, which it was affirmed was in danger, from a conspiracy to advance some pretended title to the crown; and its members vowed and protested, by the majesty of God, to employ their whole power, their bodies, lives, and goods, in her service; to withstand, as well by force of arms as by other methods of revenge, all persons, of whatsoever nation or rank, who should attempt in any form to invade and injure her safety or her life, and never to desist from the forcible pursuit of them till they should be completely exterminated. They also vowed and protested, in the presence of the eternal God, to prosecute to destruction any pretended successor by whom, or for whom, the detestable deed of the assassination of Elizabeth should be attempted or committed. The earl of Leicester was in a particular manner the patron of this association; and the whole influence of Elizabeth and her

Scotland

801  
Intended  
invasion of  
England  
discovered.804  
Remarkable  
letter  
from Mary  
intercepted  
by Elizabeth.805  
Her death  
is resolved



*Scotland.* ministers was exerted to multiply the subscriptions to a bond or league which was to prepare the way, and to be a foundation for accomplishing the full destruction and ruin of the Scottish queen.

A combination so resolute and so fierce, which pointed to the death of Mary, which threatened her titles to the crown of England, and which might defeat the succession of her son, could not fail to excite in her bosom the bitterest anxieties and perturbation. Weary of her sad and long captivity, broken down with calamities, dreading afflictions still more cruel, and willing to take away from Elizabeth every possible pretence of severity, she now framed a scheme of accommodation, to which no decent or reasonable objection could be made. By Naw, her secretary, she presented it to Elizabeth and her privy-council. She protested in it, that if her liberty should be granted to her, she would enter into the closest amity with Elizabeth, and pay an obsequance to her above every other prince of Christendom; that she would forget all the injuries with which she had been loaded, acknowledge Elizabeth to be the rightful queen of England, abstain from any claim to her crown during her life, renounce the title and arms of England, which she had usurped by the command of her husband the king of France, and reprobate the bull from Rome which had deposed the English queen. She likewise protested, that she would enter into the association which had been formed for the security of Elizabeth; and that she would conclude a defensive league with her, provided that it should not be prejudicial to the ancient alliance between Scotland and France; and that nothing should be done during the life of the English queen, or after her death, which should invalidate her titles to the crown of England, or those of her son. As a confirmation of these articles, she professed that she would consent to stay in England for some time as an hostage; and that if she was permitted to retire from the dominions of Elizabeth, she would surrender proper and acceptable persons as sureties. She also protested, that she would make no alterations in Scotland; and that, upon the repeal of what had been enacted there to her disgrace, she would bury in oblivion all the injuries she had received from her subjects: that she would recommend to the king her son those counsellors who were most attached to England, and that she would employ herself to reconcile him to the fugitive nobles: that she would take no steps about his marriage without acquainting the queen of England; and that, to give the greater firmness to the proposed accommodation, it was her desire that he should be called as a party to it: and, in fine, she affirmed, that she would procure the king of France and the princes of Lorraine to be guarantees for the performance of her engagements. Elizabeth, who was skilful in hypocrisy, discovered the most decisive symp-

VOL. XVII. Part I.

*Scotland.* toms of satisfaction and joy when these overtures were communicated to her. She made no advances, however, to conclude an accommodation with Mary; and her ministers and courtiers exclaimed against lenient and pacific measures. It was loudly insisted, that the liberty of Mary would be the death of Elizabeth; that her association with her son would be the ruin both of England and Scotland; and that her elevation to power would extend the empire of Popery, and give a deadly blow to the doctrines of the reformation.

In the mean time, an act of attainder had passed against the fugitive nobles, and their estates and honours were forfeited to the king; who, not satisfied with this, sent Patrick master of Gray to demand a surrender of their persons from the queen of England. As this ambassador had resided some time in France, and been intimate with the duke of Guise, he was recommended to Mary: but being a man of no principles, he easily suffered himself to be corrupted by Elizabeth; and while he pretended friendship to the unfortunate queen, he discovered all that he knew of the intentions of her and her son. The most scandalous falsehoods were forged against Mary; and the less she was apparently able to execute, the more she was said to delign. That an unhappy woman, confined and guarded with the utmost vigilance, who had not for many years sufficient interest to procure a decent treatment for herself, should be able to carry on such close and powerful negociations with different princes as were imputed to her, is an absurdity which it must for ever be impossible to reconcile. That she had an amour with her keeper the earl of Shrewsbury, as was now reported, might be; though of this there is no proof. This, however, could scarce be treason against Elizabeth (x): yet, on account of this, Mary was committed to the charge of Sir Amias Paulet and Sir Druce Drury, zealous puritans, and who, it was hoped, would treat her with such severity as might drive her to despair, and induce her to commit some rash action. — The earl of Leicester, said to be Elizabeth's paramour, even ventured to send assassins, on purpose, by the murder of Mary, at once to deliver his mistress from her fears. But the new keepers of the castle, though religious bigots, were men of strict probity, and rejected with scorn such an infamous transaction. In 1585, Mary began to feel all the rigours of a severe imprisonment. She had been removed from Sheffield to the castle of Tutbury; and under her new keepers she experienced a treatment which was in the highest degree unjust, disrespectful, and acrimonious. Two apartments or chambers only were allotted to her, and they were small and inconvenient, meanly furnished, and full of apertures and chinks, that they could not protect her against the inclemencies of the weather. The liberty of going abroad for pleasure or exercise was de-

M  
nied

(x) Amidst the infamous calumnies which this princess was solicitous to fix upon the queen of Scots, it must excite the highest indignation to consider her own contempt of chastity, and the unprincipled licentiousness of her private life. See Haynes's Collect. of State Papers, p. 99, &c. — Even when palled with age, she was yet burning with unquenchable desires; and vain of her haggard and cadaverous form, sought to allure to her many lovers. See Murdin, p. 558, 560, 657, 718, 719. and the discoveries of a writer, whose pen, elegant, poignant, inquisitive, and polite, improves and embellishes every topic that it canvasses; Walpole, Catalogue of royal and noble Authors, vol. i. p. 126. [Stuart. vol. ii. p. 282, note.]

Scotland.

nied to her. She was assailed by rheumatisms and other maladies; and her physician would not undertake to effect a cure, or even to procure her any ease, unless she should be removed to a more commodious dwelling. Applications for this purpose were frequently made, and uniformly rejected. Here, however, her own afflictions did not extinguish in her mind her sensibility for the misfortunes of others; and she often indulged herself in the satisfaction of employing a servant to go through the village of Tutbury in search of objects of distress, to whom she might deal out her charity. But her inhuman keepers, envying her this pleasure, commanded her to abstain from it. Imputing their rigour to a suspicious fidelity, she desired that her servant might, on these occasions, be accompanied by one of the soldiers of their guard, or by the constable of the village. But they would not alter their prohibition. They refused to her the exercise of the Christian duty of dispensing an alms; and they would not allow her the soft consolation of moistening her eye with sorrows not her own. To insult her the more, the castle of Tutbury was converted into a common jail. A young man, whose crime was the profession of the Romish religion, was committed to a chamber which was opposite to her window, in order that he might be persecuted in her sight with a peililent cruelty. Notwithstanding his cries and resistance, he was dragged every morning to hear prayers, and to join in the Protestant worship; and after enduring several weeks this extraordinary violence to his conscience, he was unmercifully strangled without any form of law or justice. Mary remonstrated with warmth to Elizabeth against indignities so shocking and so horrible; but instead of obtaining consolation or relief, she was involved more deeply in wo, and exposed to still harder inventions of malice and of anger.

811  
Elizabeth  
sows dis-  
sension be-  
tween Ma-  
ry and her  
son.

In the midst of her misfortunes, Mary had still solaced herself with hope; and from the exertions of her son she naturally expected a superlative advantage. He had hitherto behaved with a becoming cordiality; and in the negotiation which she had opened with him for her association in the government, he had been studious to please and flatter her. He had informed her by a particular dispatch, that he found the greatest comfort in her maternal tenderness, and that he would accomplish her commands with humility and expedition; that he would not fail to ratify her union and association with him in the government; that it would be his most earnest endeavour to reconcile their common subjects to that measure; and that she might expect from him, during his life, every satisfaction and duty which a good mother could promise to herself from an affectionate and obedient son. But these fair blossoms of kindness and love were all blasted by the treacherous arts of Elizabeth. By the master of Gray, who had obtained an ascendant over James, she turned from Mary his affections. He delayed to ratify her association in the government; and he even appeared to be unwilling to press Elizabeth on the subject of her liberty. The master of Gray had convinced him, that if any favour was shown to Mary by the queen of England, it would terminate in his humiliation. He assured him, that if his mother were again to mount the Scottish throne, her zeal for Popery would induce her to seek a husband in the house of Aultria; that

Scotland.

she would dissolve his association with her in the government, on the pretence of his attachment to the reformed doctrines; and that he would not only lose the glory of his present power, but endanger his prospects of succession. Mary expostulated with him by letter upon the timidity and coldness of his behaviour; and he returned her an answer full of disrespect, in which he intimated his resolution to consider her in no other character than as queen-mother. Her amazement, indignation, and grief, were infinite. She wrote to Castelnau the French ambassador to inform him of her inquietudes and anguish. "My son (said she) is ungrateful; and I desire that the king your master shall consider him no longer as a sovereign. In your future dispatches, abstain from giving him the title of king. I am his queen and his sovereign; and while I live, and continue at variance with him, he can at the best be but an usurper. From him I derive no lustre; and without me he could only have been lord Darnley or the earl of Lenox; for I raised his father from being my subject to be my husband. I ask from him nothing that is his; what I claim is my own; and if he persists in his course of impiety and ingratitude, I will bestow upon him my malediction, and deprive him not only of all right to Scotland, but of all the dignity and grandeur to which he may succeed through me. My enemies shall not enjoy the advantages they expect from him. For to the king of Spain I will convey, in the amplest form, my claims, titles, and greatness."

Elizabeth having thus found means to sow dissension between the queen of Scots and her son, did not fail to make the best use she could of the quarrel for her own advantage. The Pope, the duke of Guise, and the king of Spain, had concluded an alliance, called the *holy league*, for the extirpation of the Protestant religion all over Europe. Elizabeth was thrown into the greatest consternation on this account; and the idea of a counter association among the Protestant princes of Europe immediately suggested itself. Sir Edward Wotton was deputed to Scotland; and so completely gained upon the imbecility of James, that he concluded a firm alliance with Elizabeth, without making any stipulation in favour of his mother. Nay, so far was he the dupe of this ambassador and his mistress, that he allowed himself to be persuaded to take into his favour Mr Archibald Douglas, one of the murderers of Lord Darnley; and, as if all this had not been sufficient, he appointed this assassin to be his ambassador for England.

812  
Alliance of  
the Popish  
powers a-  
gainst Eli-  
zabeth.

Mary, thus abandoned by all the world, in the hands of her most inveterate and cruel enemy, fell a victim to her resentment and treachery in the year 1587. A plot of assassination had been formed in the spring of the year 1586 against the English queen; partly with a view to rescue the Scottish prince; but chiefly from a motive to serve the interests of the Roman Catholic religion. This conspiracy, which originated with Roman Catholic priests and persons of little note, was soon imparted to Mr Babington, a person of great fortune, of many accomplishments, and who had before that time discovered himself to be a zealous friend of queen Mary. That she had corresponded with Babington there is no doubt; but it was some years previous to the formation of the plot. A long silence had taken place between them; and Morgan,

813  
Mean and  
shameful  
behaviour  
of James.

814  
Account of  
Babington's  
conspiracy a-  
gainst Eli-  
zabeth.

Scotland. one of the English fugitives in France, and a warm friend of Mary's, in the month of May 1586, wrote a letter to her, repeatedly and in the most pressing manner recommending a revival of that correspondence. In consequence of which, in her answer to Morgan, dated the 27th day of July, she informed him, that she had made all apologies in her power to Babington, for not having written to him for so long a space; that he had generously offered himself and all his fortune in her cause; and that, agreeably to Morgan's advice, she would do her best to retain him in her interests; but she throws out no hint of her knowledge of the intended assassination. On the very same day she wrote likewise to Paget, another of her most confidential friends; but not a word in it with respect to Babington's scheme of cutting off the English queen. To Morgan and to Paget she certainly would have communicated her mind, more readily and more particularly than to Babington, and have consulted them about the plot, had she been accessory to it. Indeed it seems to have been part of the policy of Mary's friends to keep her a stranger to all clandestine and hazardous undertakings in her favour. To be convinced of this, we have only to recollect, that Morgan, in a letter of the fourth of July, expressly, and in the strongest terms, recommended to have no intelligence at all with Ballard\*, who was one of the original contrivers of the plot, and who was the very person who communicated it to Babington. The queen, in consequence of this, shut the door against all correspondence, if it should be offered, with that person †. At the same time, Morgan assigned no particular reasons for that advice; so cautious was he about giving the queen any information upon the subject: What he said was generally and studiously obscure: "Ballard (said he, only) is intent on some matters of consequence, the issue of which is uncertain." He even went farther, and charged Ballard himself to abstain in anywise from opening his views to the queen of Scots.

Murkin,  
27.

Hil. 534.

The conspiracy which goes under the name of *Babington* was completely detected by the court in the month of June: The names, proceedings, and residences, of those engaged in it were then known: The blow might be soon struck: The life of Elizabeth was in imminent hazard. The conspirators, however, were not apprehended; they were permitted to enjoy complete liberty; treated as if there were not the least suspicion against them; and in this free and quiet state, were they suffered to continue till the beginning of August, for a period it should seem of near two months. What could be the reasons for such a conduct? From what causes did the council of England suspend the

Scotland. just vengeance of the laws, and leave their queen's life still in jeopardy? Was it on purpose to procure more conspirators, and involve others in the crime?

Mary queen of Scots continued still detached from Babington and his associates. Their destruction was a small matter compared with her's. Could she be decoyed into the plot, things would put on a very new face: Babington's conspiracy, which in reality occasioned little dread, as it was early found out, and well guarded against, would prove one of the most grateful incidents in queen Elizabeth's reign. Elizabeth's ministers, too, knew how much they had rendered themselves justly obnoxious to the Scottish princess: Should she come to mount the throne of England, their downfall was inevitable; from which, it should seem, is to be explained, why they were even more zealous than their mistress to accomplish her ruin.

Of these, Sir Francis Walsingham secretary of state appears to have taken upon himself the chief management in concerting a plan of operations against the queen of Scots; and as a model, he seems to have had in his eye that which was pursued upon a former occasion by the earl of Murray. His spies having early got into the confidence of the lower sort of the conspirators, he now employed the very agency of the latter for his purposes. Learning that a packet from France was intended to be conveyed by them to queen Mary, and by the hands of one Gilbert Gifford a priest, whom he had secretly gained over from their association, he wrote a letter to Sir Amias Paulet, who had now the custody of the Scottish queen, requesting that one of his domestics might be permitted to take a bribe for conveying that packet to the captive princess. This was on purpose to communicate to her a letter forged in the name of Babington, in which that conspirator was made to impart to the Scottish queen his scheme of assassination, and to claim rewards to the perpetrators of the deed. Paulet, however, to his honour, refused to comply with the request of Walsingham; upon which Gifford corrupted a brewer in the neighbourhood, who put his letters to Mary in a hole in the castle-wall. By the same conveyance it was thought that Mary would answer the letters; but it appears that she never saw them, and that of course no return was made (v). It was then contrived that answers, in the name of the queen of Scots to Gifford, should be found in the hole of the wall. Walsingham, to whom these letters were carried, proceeded formally to decipher them by the help of one Thomas Philips, a person skilled in these matters; and after exact copies were taken of them, it is said that they were all artfully sealed and sent off to the persons to whom they were directed.

815  
Art and  
treachery  
of Eliza-  
beth and  
her minis-  
ters.

M 2

(v) Dr Robertson of Dalmeny, who, in his History of Mary queen of Scots, has thrown much light upon those dark transactions of Elizabeth's nefarious ministers, thinks it not improbable that an answer to Babington's letter was written by the Scottish queen's secretaries. Although they could not communicate that letter to herself, on account of her known abhorrence of assassination, they perhaps wrote a dispatch in her name, approving of it; tempted by the prospect of escaping from imprisonment, and of their mistress being seated on the throne of England. This dispatch being conveyed through the same chink of the wall, was carried by Gifford to Walsingham; opened; deciphered, and copied by him; and then sent to Babington. Camden informs us, that Walsingham actually forged a postscript in the same cipher to this dispatch; in which queen Mary was made to request of Babington to inform her particularly of the names of his accomplices, and of others who were friends to the cause.

Scotland.

directed. It appears, however, that only the letters directed to Babington were sent to him; and the answers which he made to the queen's supposed letters were carried directly to Walsingham. A foundation for criminating Mary being thus laid, the conspirators were quickly discovered, as being already known, and suffered the death of traitors. The unhappy princess, eagerly watched by Paulet, and unacquainted with the late occurrences, received a visit from Sir Thomas Gorges. This envoy, as intrusted by Elizabeth, surprised her when she had mounted her horse to take the pleasure of the chase. His salutation was abrupt and unceremonious; and after informing her of the discovery and circumstances of the conspiracy of Babington, he rudely charged her with a concern in it. Her astonishment was great, and she desired to return to her chamber: but this favour was refused to her; and after being carried from one house to another, in an anxious and perplexing uncertainty, she was committed to Fotheringay castle in Northamptonshire. Naw and Curl, her two secretaries, the former a Frenchman, the latter a native of Scotland, were taken into custody. Paulet breaking open the doors of her private closet, possessed himself of her money, which amounted not to more than 7000 crowns. Her cabinets were carefully sealed up; and being sent to London, were examined in the presence of Elizabeth. They contained many dispatches from persons beyond the sea, copies of letters which had been dictated by her, and about 60 tables of ciphers and characters. There were also discovered in them many dispatches to her from English noblemen, which were full of admiration and respect. These Elizabeth concealed; but their authors suspecting that they were known, sought to purchase her forgiveness by the most abject professions of an attachment to her person, and by the exercise of the most inveterate enmity to the queen of Scots. Naw and Curl declared, that the copies of her letters were in their handwriting. They had been dictated by her in the French language to Naw, translated into English by Curl, and then put into cipher. They contained not, however, any matters with which she could be reproached or criminated. It was upon the foundation of the letters which Gifford had communicated to Walsingham that her guilt was to be inferred; and with copies of these, and with an attested account of the conspiracy of Babington and his associates, Sir Edward Wotton was now dispatched into France to accuse her to Henry III. and to explain to him the dangers to which Elizabeth was exposed from the machinations and practices of the English exiles.

817  
Deliberations on the method of proceeding against her

The privy-counsellors of Elizabeth deliberated upon the most proper method of proceeding against Mary. To some it appeared, that as she was only accessory to the plot, and not the designer of it, the most eligible severity to be exercised against her was a closer and more rigorous confinement; and they endeavoured to fortify this opinion, by observing, that she was sickly, and could not live long. By others who were haunted by the terrors of Popery, it was urged, that she ought to be put instantly to death by the formalities of the law. The earl of Leicester recommended it as most prudent to dispatch her secretly by poison. But this counsel was rejected as mean, disgraceful, and violent. The lawyers were of opinion, that she might be tried upon

Scotland. the statute of Edward III.; by which it was enacted to be treason to imagine the destruction of the sovereign, to make war against his kingdom, or to adhere to his enemies. Elizabeth, however, and her ministers had provided a more plausible foundation for her trial. This was a parliamentary statute approving the act of association. As it had been passed while Mary was in England, it was argued, that she was bound by it in a local allegiance to Elizabeth. The next point of debate was the designation under which it was most advisable to arraign her. To employ a foreign name and title as directly descriptive of her, was not judged to be consistent with the law of England. It was therefore resolved to design her "Mary, daughter and heir of James V. king of Scotland, and commonly called queen of Scots, and dowager of France."

This resolution being once taken, Elizabeth next appointed above 40 peers or privy-counsellors, and five judges, bestowing upon them in a body, or upon the greater part of them, absolute power and authority to inquire into the matters compassed and imagined against her by the Scottish princess, and to pass sentence according to the spirit and tenor of the act which had been passed. Of these commissioners a great majority proceeded to the castle of Fotheringay; and the day after their arrival, they deputed to Mary, Sir Walter Mildmay, Sir Amias Paulet, and Edward Barker a public notary, to deliver to her a letter from Elizabeth. In this letter the English queen gratified her unhappy passions, and after reproaching Mary with her crimes, informed her that commissioners were appointed to take cognizance of them. The Scottish princess, though astonished with the project of being brought to a public trial, was able to preserve her dignity, and addressed them with a composed manner and air. "It is a matter (said she) altogether uncommon and strange, that Elizabeth should command me to submit to a trial, as if I were her subject. I am an independent sovereign; and will not tarnish by any meanness my high birth, the princes my predecessors, and my son. Misfortunes and misery have not yet so involved me in dejection, as that I am to taint and sink under this new calamity and insult. I desire that you will remember what I formerly protested to Bromley, who is now lord-chancellor, and to the lord La War. To speak to me of commissioners, is a vain mockery of my rank. Kings alone can be my peers. The laws of England are unknown to me; and I have no counsellors to whose wisdom I can apply for instruction. My papers and commentaries have been taken from me; and no person can have the perilous courage to appear as my advocate. I have indeed recommended myself and my condition to foreign princes; but I am clear of the guilt of having conspired the destruction of Elizabeth, or of having incited any person whatsoever to destroy her. It is only by my own words and writings that an imputation of this kind can be supported; and I am conscious beyond the possibility of a doubt, that these evidences cannot be employed against me." The day after she had in this manner refused to allow the jurisdiction of the commissioners, Paulet and Barker returned to her, and informed her that they had put her speech into writing, and desired to know if she would abide by it. She heard it read distinctly, acknowledged it to be rightly taken, and avowed her readiness to persist in the sentiments she had delivered.

818  
Commissioners appointed to try her.

819  
She objects to their jurisdiction.

Scotland. delivered. But she added, there was a circumstance to which she had omitted to speak. "Your queen (said she) affects in her letter to observe, that I am subject to the laws of England, because I have lived under their protection. This sentiment and mode of thinking are very surprising to me. I came into England to crave her assistance and aid; and, ever since, I have been confined to a prison. The miseries of captivity cannot be called a protection, and the treatment I have suffered is a violation of all law."

This afflicted but undaunted princess, after having thus scorned the competency and repelled the pretences of the commissioners, was induced at last, by arguments under the insidious mask of candour and friendship, to depart from the proper and dignified ground which she had taken, and consent to that mode of the trial which had been proposed. It was represented to her by Hatton the vice-chamberlain, that by rejecting a trial, she injured her own reputation and interests, and deprived herself of the only opportunity of setting her innocence in a clear light to the present and to future times. Imposed upon by this artifice, she consented to make her appearance before the judges; at the same time, however, she still protested against the jurisdiction of the court, and the validity of all their proceedings.

After various formalities, the lord-chancellor opened the case; and was followed by Serjeant Gawdry, who proceeded to explain the above statute, and endeavoured to demonstrate that she had offended against it. He then entered into a detail of Babington's conspiracy; and concluded with affirming, "That Mary knew it, had approved it, had promised her assistance, and had pointed out the means to effect it." Proofs of this charge were exhibited against her, and displayed with great art. The letters were read which Sir Francis Walsingham had forged, in concert with Gifford, &c. and her secretaries Naw and Curl. The three spies had afforded all the necessary intelligence about the conspiracy, upon which to frame a correspondence between Mary and Babington, and upon which dispatches might be fabricated in her name to her foreign friends; and the ciphers were furnished by her two secretaries. But beside these pretended letters, another species of evidence was held out against her. Babington, proud of the dispatch sent to him in her name by Walsingham and Gifford, returned an answer to it; and a reply from her by the same agency was transmitted to him. Deluded, and in toils, he communicated these marks of her attention to Savage and Ballard, the most confidential of his associates. His confession and theirs became thus of importance. Nor were her letters and the confessions of these conspirators deemed sufficient vouchers of her guilt. Her two secretaries, therefore, who had lately forsaken her, were engaged to subscribe a declaration, that the dispatches in her name were written by them at her command, and according to her instructions. These branches of evidence, put together with skill, and heightened with all the imposing colours of eloquence, were pressed upon Mary. Though she had been long accustomed to the perfidious inhumanity of her enemies, her amazement was infinite. She lost not, however, her courage; and her defence was alike expressive of her penetration and magnanimity.

Scotland. "The accusation preferred to my prejudice is a most detestable calumny. I was not engaged with Babington in his conspiracy; and I am altogether innocent of having plotted the death of Elizabeth. The copies of Babington's letters which have been produced, may indeed be taken from originals which are genuine; but it is impossible to prove that I ever received them. Nor did he receive from me the dispatches addressed to him in my name. His confession, and those of his associates, which have been urged to establish the authority of my letters to him, are imperfect and vain. If these conspirators could have testified any circumstances to my hurt, they would not so soon have been deprived of their lives. Tortures, or the fear of the rack, extorted improper confessions from them; and then they were executed. Their mouths were opened to utter false criminations; and were immediately shut for ever, that the truth might be buried in their graves. It was no difficult matter to obtain ciphers which I had employed; and my adversaries are known to be superior to scruples. I am informed, that Sir Francis Walsingham has been earnest to recommend himself to his sovereign by practices both against my life and that of my son; and the fabrication of papers, by which to effectuate my ruin, is a business not unworthy of his ambition. An evidence, the most clear and incontrollable, is necessary to overthrow my integrity; but proofs, the most feeble and suspicious, are held out against me. Let one letter be exhibited, written in my hand, or that bears my superscription, and I will instantly acknowledge that the charge against me is sufficiently supported. The declaration of my secretaries is the effect of rewards or of terror. They are strangers; and to overcome their virtue was an easy achievement to a queen whose power is absolute, whose riches are immense, and whose ministers are profound and daring in intrigues and treachery. I have often had occasion to suspect the integrity of Naw; and Curl, whose capacity is more limited, was always most obsequious to him. They may have written many letters in my name without my knowledge or participation; and it is not fit that I should bear the blame of their inconsiderate boldness. They may have put many things into dispatches which are prejudicial to Elizabeth; and they may even have subscribed their declaration to my prejudice, under the prepossession that the guilt which would utterly overwhelm them might be pardoned in me. I have never dictated any letter to them which can be made to correspond with their testimony. And what, let me ask, would become of the grandeur, the virtue, and the safety of princes, if they depended upon the writings and declarations of secretaries? Nor let it be forgotten, that by acting in hostility to the duty and allegiance which they solemnly swore to observe to me, they have utterly incapacitated themselves from obtaining any credit. The violation of their oath of fidelity is an open perjury; and of such men the protestations are nothing. But, if they are yet in life, let them be brought before me. The matters they declare are so important as to require that they should be examined in my presence. It argues not the fairness of the proceedings against me, that this formality is neglected. I am also without the assistance of an advocate; and, that I might be defenceless and weak in the greatest degree, I have been robbed of my papers and commentaries.

Scotland.

821  
Mary's defence.

Stuart.

Scotland.

mentaries. As to the copies of the dispatches which are said to have been written by my direction to Mendoza, the lord Paget, Charles Paget, the archbishop of Glasgow, and Sir Francis Inglesfield, they are most unprofitable forgeries. For they tend only to show that I was employed in encouraging my friends to invade England. Now, if I should allow that these dispatches were genuine, it could not be inferred from them that I had conspired the death of Elizabeth. I will even confess, that I have yielded to the strong impulses of nature; and that, like a human creature, encompassed with dangers and insulted with wrongs, I have exerted myself to recover my greatness and my liberty. The efforts I have made can excite no blushes in me; for the voice of mankind must applaud them. Religion, in her sternest moments of severity, cannot look to them with reproach; and to consider them as crimes, is to despise the sanctimonious reverence of humanity, and to give way to the suspicious wretchedness of despotism. I have fought by every art of concession and friendship to engage my sister to put a period to my sufferings. Invited by her smiles, I ventured into her kingdom, in the pride and gaiety of my youth; and, under her anger and the miseries of captivity, I have grown into age. During a calamitous confinement of 20 years, my youth, my health, my happiness, are for ever gone. To her tenderness and generosity I have been indebted as little as to her justice; and, oppressed and agonizing with unmerited afflictions and hardships, I scrupled not to beseech the princes my allies to employ their armies to relieve me. Nor will I deny, that I have endeavoured to promote the advantage and interest of the persecuted Catholics of England. My intreaties in their behalf have been even offered with earnestness to queen Elizabeth herself. But the attainment of my kingdom, the recovery of my liberty, and the advancement of that religion which I love, could not induce me to stain myself with the crimes that are objected to me. I would disdain to purchase a crown by the assassination of the meanest of the human race. To accuse me of scheming the death of the queen my sister, is to brand me with the infamy which I abhor most. It is my nature to employ the devotions of Esther, and not the sword of Judith. Elizabeth herself will attest, that I have often admonished her not to draw upon her head the resentment of my friends by the enormity of her cruelties to me. My innocence cannot sincerely be doubted; and it is known to the Almighty God, that I could not possibly think to forego his mercy, and to ruin my soul, in order to compass a transgression so horrible as that of her murder. But amidst the inclement and unprincipled pretences which my adversaries are pleased to invent to overwhelm me with calamities and anguish, I can trace and discover with ease the real causes of their hostility and provocation. My crimes are, my birth, the injuries I have been compelled to endure, and my religion. I am proud of the first; I can forgive the second; and the third is a source to me of such comfort and hope, that for its glory I will be contented that my blood shall flow upon the scaffold."

To the defence of Mary, no returns were made beside stout and unsupported affirmations of the truth of the evidence produced to her prejudice. In the course of the trial, however, there occurred some incidents which deserve to be related. My lord Burleigh, who

was willing to discompose her, charged her with a fixed resolution of conveying her claims and titles to England to the king of Spain. But though, in a discontented humour with her son, she had threatened to disinheritor him, and had even corresponded on the subject with her select friends, it appears that this project is to be considered as only a transient effect of resentment and passion. She indeed acknowledged, that the Spaniard professed to have pretensions to the kingdom of England, and that a book in justification of them had been communicated to her. She declared, however, that she had incurred the displeasure of many by disapproving of this book; and that no conveyance of her titles to the Spaniard had been ever executed.

The trial continued during the space of two days; but the commissioners avoided to deliver their opinions. My lord Burleigh, in whose management Elizabeth chiefly confided, and whom the Scottish queen discomposed in no common degree by her ability and vigour, being eager to conclude the business, demanded to know if she had any thing to add to what she had urged in her defence. She informed him, that she would be infinitely pleased and gratified, if it should be permitted to her to be heard in her justification before a full meeting of the parliament, or before the queen and her privy-council. This intimation was unexpected; and the request implied in it was rejected. The court, in consequence of previous instructions from Elizabeth, adjourned to a farther day, and appointed that the place of its convention should be the star-chamber at Westminster. It accordingly assembled there; and Naw and Curl, who had not been produced at Fotheringay-castle, were now called before the commissioners. An oath to declare the truth was put to them; and they definitely affirmed and protested that the declaration they had subscribed was in every respect just and faithful. Nothing farther remained but to pronounce sentence against Mary. The commissioners unanimously concurred in delivering it as their verdict or judgment, that she "was a party to the conspiracy of Babington; and that she had compassed and imagined matters within the realm of England tending to the hurt, death, and destruction, of the royal person of Elizabeth, in opposition to the statute framed for her protection." Upon the same day in which this extraordinary sentence was given, the commissioners and the judges of England issued a declaration, which imported, that it was not to derogate in any degree from the titles and honour of the king of Scots.

The sentence against Mary was very soon afterwards ratified by the English parliament. King James was struck with horror at hearing of the execution of his mother; but that spiritless prince could show his resentment no farther than by unavailing embassies and remonstrances. France interposed in the same ineffectual manner; and on the 6th of December 1586, Elizabeth caused the sentence of the commissioners against her to be proclaimed. After this she was made acquainted with her fate, and received the news with the greatest composure, and even apparent satisfaction. Her keepers now refused to treat her with any reverence or respect. They entered her apartment with their heads covered, and made no obeisance to her. They took down her canopy of state, and deprived her of all the badges of royalty. By these insulting mortifications

Scotland.

822  
She desires  
to be heard  
before the  
parliament,  
or before  
the queen.

823  
Judgment  
given a-  
gainst her.

824  
The sen-  
tence rat-  
ified by the  
English  
parliament

they

land. they meant to inform her, that she had sunk from the dignity of a princess to the abject state of a criminal. She smiled, and said, "In despite of your sovereign and her subservient judges, I will live and die a queen. My royal character is indelible; and I will surrender it with my spirit to the Almighty God, from whom I received it, and to whom my honour and my innocence are fully known." In this melancholy situation Mary addressed a magnanimous letter to Elizabeth, in which, without making the least solicitation for her life, she only requested that her body might be carried to France; that she might be publicly executed; that her servants might be permitted to depart out of England unmolested, and enjoy the legacies which she bequeathed them. But to this letter no answer was given.

5  
sibility  
ness,  
x-  
info.  
and  
ry of  
ERGY.

In the mean time James, who had neither address nor courage to attempt any thing in behalf of his mother, announced her situation to his bigotted subjects, and ordered prayers to be said for her in all the churches. The form of the petition he prescribed was framed with delicacy and caution, that the clergy might have no objection to it. He enjoined them to pray, "that it might please God to enlighten Mary with the light of his truth, and to protect her from the danger which was hanging over her." His own chaplains, and Mr David Lindsay minister of Leith, observed his command. But all the other clergy refused to prostitute their pulpits by preferring any petitions to the Almighty for a Papist. James, shocked with their spirit of intolerance and sedition, appointed a new day for prayers to be said for Mary, and issued a stricter injunction to the clergy to obey him; and that he might be free himself from any insult, he commanded the archbishop of St Andrew's to preach before him. The ecclesiastics, disgusted with his injunction, persuaded Mr John Cowper, a probationer in divinity, to occupy the pulpit designed for the archbishop. When the king entered the church, he testified his surprise, but told Cowper, that if he would obey his injunction, he might proceed to officiate. Cowper replied, "that he would do as the spirit of God would direct him." The king commanded him to retire, and the captain of his guard advanced to compel him to obedience. The enraged probationer exclaimed, that this violence "would witness against the king in the great day of the Lord;" and denounced a curse against the spectators for not exerting themselves in his defence. The archbishop now ascending the pulpit, performed with propriety the function to which he had been called, and took the opportunity to recommend moderation and charity to the audience. In the afternoon Cowper was cited before the privy-council; and was accompanied there by Mr Walter Balcanqual and Mr William Watson, two ministers remarkable for their zeal. As a punishment for his audacious petulance, he was committed to the castle of Blackness; and his attendants having distinguished themselves by an impudent vindication of him, were prohibited from preaching during the pleasure of the king.

6  
beth  
some  
rse;

Elizabeth, in the meanwhile, felt the torment and disquiet of unhappy and miserable passions. At times she courted the sadness of solitude, and refused to be consoled or to speak. In other seasons her sighs were frequent, and she broke out into loud and wild exclamations expressive of the state of her mind. Her subjects waited the determination of her will under a dis-

traucing agitation and uncertainty. Her ministers, who knew that it is the nature of fear to exclude pity, were industrious in inventing terrifying intelligence, and in circulating it through the kingdom. There were rumours that the Spanish fleet had arrived at Milford-haven; that a formidable army of Scottish combatants was advancing to the capital; that the duke of Guise had disembarked many troops of veteran soldiers in Sussex; that Mary had escaped out of prison, and was collecting the English Catholics; that the northern counties had thrown aside their allegiance; and that there was a new plot to kill Elizabeth, and to reduce London to ashes. An actual conspiracy was even maliciously charged upon L'Aubespine the French resident; and he was forced to withdraw from England in disgrace. From the panic terrors which the ministers of Elizabeth were so studious to excite, they scrupled not loudly and invariably to infer, that the peace and tranquillity of the kingdom could alone be re-established by the speedy execution of the Scottish queen.

827

While the nation was thus artfully prepared for the destruction of Mary, Elizabeth ordered secretary Davidson to bring to her the warrant for her death. Having perused it with deliberation, she observed that it was extended in proper terms, and gave it the authority of her subscription. She was in a humour somewhat gay, and demanded of him if he was not sorry for what she had done. He replied, that it was afflicting to him to think of the state of public affairs; but that he greatly preferred her life to that of the Scottish princess. She enjoined him to be secret, and desired, that before he should deliver the warrant to the chancellor, he should carry it to Walsingham. "I fear much (said she, in a merry tone), that the grief of it will kill him."

828

This levity was momentary; and fears and anxieties succeeded it. Though she earnestly desired the death of Mary, she was yet terrified to encounter its infamy. She was solicitous to accomplish this base transaction by some method which would conceal her consent to it. After intimating to Mr Davidson an anxious wish that its blame should be removed from her, she counselled him to join with Walsingham in addressing a letter to Sir Amias Paulet and Sir Drue Drury, recommending it to them to manifest their love to her by shedding privately the blood of her adversary. The unlawfulness of this deed affected Davidson, and he objected to it. She repeated resolutely her injunctions, and he departed to execute them. A letter under his name and that of Walsingham was dispatched to Mary's keepers, communicating to them her purpose. Corrupted by her passions, and lost to the sensibilities of virtue, Elizabeth had now reached the last extremity of human wickedness. Though a sovereign princess, and entrusted with the cares of a great nation, she blushed not to give in charge to her ministers to enjoin a murder; and this murder was connected with every circumstance that could make it most frightful and horrid. The victim for whose blood she thirsted was a woman, a queen, a relation, who was splendid with beauty, eminent in abilities, magnanimous under misfortunes, and smiling with innocence. Sir Amias Paulet and Sir Drue Drury, tho' the slaves of religious prejudices, felt an elevation of mind which reflected the greatest disgrace upon the sovereign. They considered themselves as grossly in-

Scotland.  
Stuart.

Bar Stuart  
the war-  
runt for  
Mary's  
death.

828  
Wishes to  
have her  
privately  
murdered;

829  
Which her  
keepers re-  
fuse.

sulted

Scotland.  
Stuart.

sulted by the purpose proposed to them; and in the return they made to Walsingham, they assured him, that the queen might command their lives and their property, but that they would never consent to part with their honour, and to stain themselves and their posterity with the guilt of an assassination. When Davidson carried their dispatch to her, she broke out into anger. "Their scrupulous delicacy, she said, was a dainty infringement of their oath of association; and they were nice, precise, and perjured traitors, who could give great promises in words, and achieve nothing. She told him, that the business could be performed without them; and recommended one Wingfield to his notice, who would not hesitate to strike the blow. The astonished secretary exclaimed with warmth against a mode of proceeding so dangerous and unwarrantable. He protested, that if she should take upon herself the blame of this deed, it would pollute her with the blackest dishonour; and that, if she should disavow it, she would overthrow for ever the reputation, the estates, and the children, of the persons who should assist in it. She heard him with pain, and withdrew from him with precipitation.

830  
The warrant affixed the great seal.

The warrant, after having been communicated to Walsingham, was carried to the chancellor, who put the great seal to it. This formality was hardly concluded, when a message from Elizabeth prohibited Davidson from waiting upon herself the chancellor till he should receive farther instructions. Within an hour after, he received a second message to the same purpose. He hastened to court; and Elizabeth asked eagerly, if he had seen the chancellor. He answered in the affirmative; and she exclaimed with bitterness against his haste. He said, that he had acted exactly as she had directed him. She continued to express warmly her displeasure; but gave no command to stop the operation of the warrant. In a state of uneasiness and apprehension, he communicated her behaviour to the chancellor and the privy-council. These courtiers, however, who were well acquainted with the arts of their mistress, and who knew how to flatter her, paid no attention to him. They perceived, or were secretly informed, that she desired to have a pretence upon which to complain of the secretary, and to deny that he had obeyed her instructions. They observed to him, that by subscribing the warrant, she had performed whatever the law required of her; and that it was not proper to delay the execution any longer. While they were anxious to please Elizabeth, they were conscious of their own cruelty to Mary, and did not imagine they could be in perfect security while she lived. They dispatched the warrant to the earls of Shrewsbury and Kent, with instructions to them to fulfil its purpose.

831  
Mary is acquainted with her fate.

When the two earls and their retinue reached Fotheringay-castle, they found that Mary was sick, and reposing upon her bed. They insisted, notwithstanding, to be introduced to her. Being informed by her servants that the message they brought was important and pressing, she prepared to receive them. They were conducted into her presence by Sir Amias Paulet and Sir Drue Drury; and with little formality they told her, that Elizabeth had consented to her death, and that she was to suffer the next morning at eight o'clock. Then Beale, one of the clerks of the privy-council, who accompanied them, read over the warrant, which she heard with pious composure and unshaken fortitude.

They then affected to justify their mistress by entering into details concerning the conspiracy of Babington. She put her hand upon the Scriptures, which lay upon a table near her, and swore in the most solemn manner, that she never devised, consented to, or pursued the death of Elizabeth in any shape whatsoever. The earl of Kent, unwisely zealous for the Protestant religion, excepted against her oath, as being made upon a Popish Bible. She replied to him mildly, "It is for this very reason, my lord, to be relied upon with the greater security; for I esteem the Popish version of the Scriptures to be the most authentic." Indulging his puritanical fervour, he declaimed against popery, counselled her to renounce its errors, and recommended to her attention Dr Fletcher dean of Peterborough. She heard him with some impatience; and discovered no anxiety to be converted by this ecclesiastic, whom he represented as a most learned divine. Rising into passion, he exclaimed, that "her life would be the death of their religion, and that her death would be its life." After informing him that she was unalterably fixed in her religious sentiments, she desired that her confessor might have the liberty to repair to her. The two earls concurred in observing, that their consciences did not allow them to grant this request. She intimated to them the favours for which she had applied by her letter to Elizabeth, and expressed a wish to know if her sister had attended to them. They answered, that these were points upon which they had received no instructions. She made inquiries concerning her secretaries Naw and Curl; and asked, whether it had ever been heard of, in the wickedest times of the most unprincipled nation, that the servants of a sovereign princess had been suborned for the purpose of destroying her. They looked to one another, and were silent. Bourgoin her physician, who with her other domestics was present at this interview, seeing the two earls ready to depart, besought them with an emphatic earnestness to reflect upon the short and inadequate portion of time that they had allotted to his mistress to prepare herself for death. He insisted, that a respect for her high rank, and the multiplicity and importance of her concerns, required at least a period of some days. They pretended, however, not to understand the propriety of his petition, and refused it.

Upon the departure of the two earls, her domestics gave a full vent to their afflictions; and while she experienced a melancholy pleasure in their tears, lamentations, and kindness, she endeavoured to console them. Their grief, she said, was altogether unavailing, and could neither better her condition nor their own. Her cause had every thing about it that was most honourable; and the miseries from which she was to be relieved were the most hopeless and the most afflicting. Instead of dejection and sadness, she therefore enjoined them to be contented and happy. That she might have the more leisure to settle her affairs, she supped early, and, according to her usual custom, she eat little. While at table, she remarked to Bourgoin her physician, that the force of truth was insurmountable; for that the earl of Kent, notwithstanding the pretence of her having conspired against Elizabeth, had plainly informed her, that her death would be the security of their religion. When supper was over, she ordered all her servants to appear before her, and treated them with

832  
She prepared for death.



Scotland. the kindness which we have mentioned in her life. Having settled these attentions, she entered her bedchamber with her women; and, according to her uniform practice, employed herself in religious duties, and in reading in the Lives of the Saints. At her accustomed time she went to sleep; and after enjoying some hours of sound rest, she awaked. She then indulged in pious meditation, and partook of the sacrament by the means of a consecrated host, which a melancholy presentiment of her calamities had induced her to obtain from Pius V.

833  
ccount of  
e execu-  
on.

Stuart.

At the break of day she arrayed herself in rich, but becoming apparel; and calling together her servants, she ordered her will to be read, and apologised for the smallness of her legacies from her inability to be more generous. Following the arrangement she had previously made, she then dealt out to them her goods, wardrobe, and jewels. To Bourgein her physician she committed the care of her will, with a charge that he would deliver it to her principal executor the duke of Guise. She also entrusted him with tokens of her affection for the king of France, the queen-mother, and her relations of the house of Lorraine. Bidding now an adieu to all worldly concerns, she retired to her oratory, where she was seen sometimes kneeling at the altar, and sometimes standing motionless with her hands joined, and her eyes directed to the heavens. In these tender and agitated moments, she was dwelling upon the memory of her sufferings and her virtues, reposing her weaknesses in the bosom of her God, and lifting and solacing her spirit in the contemplation of his perfections and his mercy. While she was thus engaged, Thomas Andrews, the high sheriff of the county, announced to her, that the hour for her execution was arrived. She came forth dressed in a gown of black silk; her petticoat was bordered with crimson-velvet; a veil of lawn bowed out with wire, and edged with bone-lace, was fastened to her caul, and hung down to the ground: an Agnus Dei was suspended from her neck by a pomander chain; her beads were fixed to her girdle; and she bore in her hand a crucifix of ivory. Amidst the screams and lamentations of her women she descended the stairs; and in the porch she was received by the earls of Kent and Shrewsbury with their attendants.— Here, too, she met Sir Andrew Melvil the master of her household, whom her keepers had debarred from her presence during many days. Throwing himself at her feet, and weeping aloud, he deplored his sad destiny, and the sorrowful tidings he was to carry into Scotland.

After she had spoken to Melvil, she besought the two earls that her servants might be treated with civility, that they might enjoy the presents she had bestowed upon them, and that they might receive a safe conduct to depart out of the dominions of Elizabeth. These slight favours were readily granted to her. She then begged that they might be permitted to attend her to the scaffold, in order that they might be witnesses of her behaviour at her death. To this request the earl of Kent discovered a strong reluctance. He said that they would behave with an intemperate passion; and that they would practise superstitious formalities, and dip their handkerchiefs in her blood. She replied, that she was sure that none of their actions would be blameable;

VOL. XVII. Part I.

Scotland. and that it was but decent that some of her women should be about her. The earl still hesitating, she was affected with the insolent and stupid indignity of his malice, and exclaimed, "I am cousin to your mistress, and descended from Henry VII. I am a dowager of France, and the anointed queen of Scotland." The earl of Shrewsbury interposing, it was agreed that she should select two of her women who might assist her in her last moments, and a few of her men-servants, who might behold her demeanour, and report it.

Stuart.

She entered the hall where she was to suffer, and advanced with an air of grace and majesty to the scaffold, which was built at its farthest extremity. The spectators were numerous. Her magnanimous carriage, her beauty, of which the lustre was yet dazzling, and her matchless misfortunes, affected them. They gave way to contending emotions of awe, admiration, and pity. She ascended the scaffold with a firm step and a serene aspect, and turned her eye to the block, the axe, and the executioners. The spectators were dissolved in tears. A chair was placed for her, in which she seated herself. Silence was commanded; and Beale read aloud the warrant for her death. She heard it attentively, yet with a manner from which it might be gathered that her thoughts were employed upon a subject more important. Dr Fletcher dean of Peterborough taking his station opposite to her without the rails of the scaffold, began a discourse upon her life, past, present, and to come. He affected to enumerate her trespasses against Elizabeth, and to describe the love and tenderness which that princess had shown to her. He counselled her to repent of her crimes; and while he inveighed against her attachment to Popery, he threatened her with everlasting fire if she should delay to renounce its errors. His behaviour was indecent and coarse in the greatest degree; and while he meant to insult her, he insulted still more the religion which he professed, and the sovereign whom he flattered. Twice she interrupted him with great gentleness. But he pertinaciously continued his exhortations. Raising her voice, she commanded him with a resolute tone to withhold his indignities and menaces, and not to trouble her any more about her faith. "I was born (said she) in the Roman Catholic religion; I have experienced its comforts during my life, in the trying seasons of sickness, calamity, and sorrow; and I am resolved to die in it." The two earls, ashamed of the savage obstinacy of his deportment, admonished him to desist from his speeches, and to content himself with praying for her conversion. He entered upon a long prayer; and Mary falling upon her knees, and disregarding him altogether, employed herself in devotions from the office of the Virgin.

After having performed all her devotions, her women assisted her to disrobe; and the executioners offering their aid, she repressed their forwardness by observing, that she was not accustomed to be attended by such servants, nor to be undressed before so large an assembly. Her upper garments being laid aside, she drew upon her arms a pair of silk gloves. Her women and men servants burst out into loud lamentations. She put her finger to her mouth to admonish them to be silent, and then bade them a final adieu with a smile that seemed to console, but that plunged them into deeper wo. She kneeled resolutely before the block,

N

and

Scotland

and said, "In thee, O Lord! do I trust, let me never be confounded." She covered her eyes with a linen handkerchief in which the eucharist had been inclosed; and stretching forth her body with great tranquillity, and sitting her neck for the fatal stroke, she called out, "Into thy hands, O God! I commit my spirit." The executioner, from design, from unskillfulness, or from inquietude, struck three blows before he separated her head from her body. He held it up mangled with wounds, and streaming with blood; and her hair being discompos'd, was discovered to be already grey with afflictions and anxieties. The dean of Peterborough alone cried out, "So let the enemies of Elizabeth perish." The earl of Kent alone, in a low voice, answered, "Amen." All the other spectators were melted into the tenderest sympathy and sorrow.

Her women hastened to protect her dead body from the curiosity of the spectators; and solaced themselves with the thoughts of mourning over it undisturbed when they should retire, and of laying it out in its funeral garb. But the two earls prohibited them from discharging these melancholy yet pleasing offices to their departed mistress, and drove them from the hall with indignity. Bourgoin her physician applied to them that he might be permitted to take out her heart for the purpose of preserving it, and of carrying it with him to France. But they refused his intreaty with disdain and anger. Her remains were touched by the rude hands of the executioners, who carried them into an adjoining apartment; and who, tearing a cloth from an old billiard-table, covered that form, once so beautiful. The block, the cushion, the scaffold, and the garments, which were stained with her blood, were consumed with fire. Her body, after being embalmed and committed to a leaden coffin, was buried with royal splendour and pomp in the cathedral of Peterborough. Elizabeth, who had treated her like a criminal while she lived, seemed dispos'd to acknowledge her for a queen when she was dead.

334  
Infamous  
dissimula-  
tion in  
Elizabeth,  
and indiffe-  
rence in  
James.

On the death of his mother, the full government of the kingdom devolved on James her son. Elizabeth, apprehensive of his resentment for her treatment of his mother, wrote him a letter, in which she disclaimed all knowledge of the fact. James had received intelligence of the murder before the arrival of this letter, which was sent by one Cary. The messenger was stopped at Berwick by an order from the king, telling him, that, if Mary had been executed, he should proceed at his peril. James shut himself up in Dalkeith castle, in order to indulge himself in grief; but the natural levity and imbecility of his mind prevented him from acting in any degree as became him. Instead of resolutely adhering to his first determination of not allowing Cary to set foot in Scotland, he in a few days gave his consent that he should be admitted to an audience of certain members of his privy-council, who took a journey to the borders on purpose to wait upon him. In this conference, Cary demanded that the league of amity between the two kingdoms should be inviolably observed. He said that his mistress was grieved at the death of Mary, which had happen'd without her consent; and, in Elizabeth's name, offered any satisfaction that James could demand. The Scots commissioners treated Cary's speech and proposal with becoming disdain. They ob-

Scotland

served, that they amounted to no more than to know whether James was dispos'd to sell his mother's blood; adding, that the Scottish nobility and people were determined to revenge it, and to interest in their quarrel the other princes of Europe. Upon this Cary deliver'd to them the letter from Elizabeth, together with a declaration of his own concerning the murder of the queen; and it does not appear that he proceeded farther.

This reception of her ambassador threw Elizabeth into the utmost consternation. She was apprehensive that James would join his force to that of Spain, and entirely overwhelm her; and had the resentment or the spirit of the king been equal to that of the nation, it is probable that the haughty English princess would have been made severely to repent her perfidy and cruelty. It doth not, however, appear, that James had any serious intention of calling Elizabeth to an account for the murder of his mother; for which, perhaps, his natural imbecility may be urged as an excuse, though it is more probable that his own necessity for money had swallowed up every other consideration. By the league formerly concluded with England, it had been agreed that Elizabeth should pay an annual pension to the king of Scotland. James had neither economy to make his own revenue answer his purposes, nor address to get it increased. He was therefore always in want; and as Elizabeth had plenty to spare, her friendship became a valuable acquisition. To this consideration, joined to his view of ascending the English throne, must chiefly be ascribed the little resentment shown by him to the atrocious conduct of Elizabeth.

Elizabeth was not wanting in the arts of dissimulation and treachery now more than formerly. She prosecuted and fined secretary Davidson and lord Burleigh for the active part they had taken in Mary's death. Their punishment was indeed much less than they deserved, but they certainly did not merit such treatment at her hands. Walsingham, though equally guilty, yet escap'd by pretending indisposition, or perhaps escap'd because the queen had now occasion for his services. By her command he drew up a long letter addressed to lord Thirston, king James's prime minister; in which he showed the necessity of putting Mary to death, and the folly of attempting to revenge it. He boasted of the superior force of England to that of Scotland; strewed James that he would for ever ruin his pretensions to the English crown, by involving the two nations in a war; that he ought not to trust to foreign alliances; that the Roman Catholic party were to be divided among themselves, that he could receive little or no assistance from them, even supposing him so ill advised as to change his own religion for Popery, and that they would not trust his sincerity. Lastly, he attempted to show, that James had already discharged all the duty towards his mother and his own reputation that could be expected from an affectionate son and a wise king; that his interceding for her with a concern so becoming nature, had endeared him to the kingdom of England; but that it would be madness to push his resentment farther.

This letter had all the effect that could be desired. James gave an audience to the English ambassador; and being assured that his blood was *not tainted* by the execution of his mother for treason against Elizabeth, but that

835  
Secretary  
Davidson  
and lord  
Burleigh  
punished.

Scotland that he was still capable of succeeding to the crown of England, he consented to make up matters, and to address the murderer of his mother by the title of loving and affectionate sister.

The reign of James, till his accession to the crown of England by Elizabeth's death in 1603, affords little matter of moment. His scandalous concessions to Elizabeth, and his constant applications to her for money, filled up the measure of Scottish meanness. Ever since the expulsion of Mary, the country had in fact been reduced to the condition of an English province. The sovereign had been tried by the queen of England, and executed for treason; a crime, in the very nature of the thing impossible, had not Scotland been in subjection to England; and to complete all, the contemptible successor of Mary thought himself well off that he was not a traitor too, to his sovereign the queen of England we must suppose, for the case will admit of no other supposition.

836  
Disturbances during the reign of James.  
During the reign of James, the religious disturbances which began at the reformation, and that violent struggle of the clergy for power which never ceased till the revolution in 1688, went on with great violence. Continual clamours were raised against Popery, at the same time that the very fundamental principles of Popery were held, nay urged in the most insolent manner, as the effects of immediate inspiration. These were the total independence of the clergy on every earthly power, at the same time that all earthly powers were to be subject to them. Their fantastic decrees were supposed to be binding in heaven; and they took care that they should be binding on earth, for whoever had offended so far as to fall under a sentence of excommunication was declared an outlaw.

837  
is of perfection and unity.  
It is easy to see that this circumstance must have contributed to disturb the public tranquillity in a great degree. But besides this, the weakness of James's government was such, that, under the name of peace, the whole kingdom was involved in the miseries of civil war; the feudal animosities revived, and slaughter and murder prevailed all over the country. James, fitted only for pedantry, disputed, argued, modelled, and re-modelled, the constitution to no purpose. The clergy continued their insolence, and the laity their violences upon one another; at the same time that the king, by his unhap-

py credulity in the operation of demons and witches, declared a most inhuman and bloody war against the poor old women, many of whom were burnt for the imaginary crime of conversing with the devil.

In autumn 1600 happened a remarkable conspiracy against the liberty, if not the life, of the king. The attainer and execution of the earl of Gowrie for the part he acted in the raid of Ruthven and for subsequent practices of treason have been already mentioned. His son, however, had been restored to his paternal dignity and estates, and had in consequence professed gratitude and attachment to the king. But the Presbyterian clergy continued to express their approbation of the raid of Ruthven, and to declare on every occasion that in their opinion the earl of Gowrie had suffered by an unjust sentence. One of the most eminent and popular of that order of men was preceptor to the younger Gowrie and his brothers, who, from their frequent conversations with him, must have been deeply impressed with the belief that their father was murdered. The passion of revenge took possession of their breasts; and having invited the king from Falkland to the earl of Gowrie's house at Perth, under the pretence of showing him a secret treasure of foreign gold, which he might lawfully appropriate to his own use, an attempt was made to keep him a close prisoner, with threats of putting him to instant death if he should make any attempt to regain his liberty.

The reality of this conspiracy has been questioned by many writers, for no other reason, as it would appear, but because they could not assign a rational motive for Gowrie's engaging in so hazardous an enterprise; and some have even insinuated that the conspiracy was entered into by the king against Gowrie in order to get possession of his large estates. It has been shown however by Arnot, in his Criminal Trials, with a force of evidence which leaves no room for doubt, that the conspiracy was the earl's, who seems to have intended that the king should be cut off by the hand of an assassin; and the same acute and discriminating writer has made it appear highly probable, that he entertained hopes, in the then distracted state of the nation not ill founded, of being able to mount the throne of his murdered sovereign (z). From this imminent danger James was rescued by his attendants the duke of Lennox, the earl of

N 2  
Marre,

(z) The family of Ruthven had long been looked upon as the head of that party which was attached to England and the reformation; and the accomplishments of the latter Gowrie qualified him to be the leader of an enterprising faction. The importance he derived from aristocratic influence over his extensive domains, and from the attachment of a powerful party in church and state, was embellished with the lustre of a regal descent. Thus ambition, as well as revenge, might stimulate him to his daring enterprise. Indeed, if his attempt was to be directed against the life of the king, it could no longer be safe for him to remain in the condition of a subject: and the indecent and malicious imputation of bastardy, with which the fanatics reproached king James, might afford a plausible pretext for securing the royal offspring. The family of Hamilton, next heir to the crown, had long lost its popularity, and the earl of Arran, its head, had lost his judgment; and, though there undoubtedly were several families interposed between Gowrie and the crown in the strict line of succession, none of them probably possessed power and popularity to support their right. But as Gowrie and his brother were really endowed with those personal accomplishments which have been so highly extolled, and which made their countrymen conceive the most sanguine hopes of their early virtues; it is absurd to suppose lord Gowrie to have flattered himself, that in a country where the church was in danger, where the trumpet of sedition was sounded by the ministers, who fortified the chief block-house of the Lord's Jerusalem, his piety, popularity, and bravery, should supply the defect in title, and make him be called, while there were nearer heirs to the crown; as has since happened in the same country, on a similar occasion.

Scotland. Marre, Sir Thomas Erskine afterwards earl of Kellie, and Sir John Ramsay who was likewise ennobled; and though Gowrie and his brother fell in the struggle, they were attainted by an act of parliament, which decerned their name, memory, and dignity, to be extinguished; their arms to be cancelled; their whole estates to be forfeited and annexed to the crown; the name of Ruthven to be abolished; and their posterity and surviving brethren to be incapable of succeeding to, or of holding, any offices, honours, or possessions.

838  
The Western Islanders civilized.

The most memorable transaction of James's reign, and that most to his honour, is the civilizing of the western islanders. For this purpose, he instituted a company of gentlemen adventurers, to whom he gave large privileges for reforming them. The method he proposed was to transport numbers of them to his low countries in Scotland, and to give their islands, which were very improveable, in fee to his lowland subjects who should choose to reside in the islands. The experiment was to be made upon the Leves, a long range of the Ebrudæ; from whence the adventurers expelled Murdoch Macleod, the tyrant of the inhabitants. Macleod, however, kept the sea; and intercepting a ship which carried one of the chief adventurers, he lent him prisoner to Orkney, after putting the crew to the sword. Macleod was soon after betrayed by his own brother, and hanged at St Andrew's. The history of this new undertaking is rather dark; and the settlers themselves seem to have been defective in the arts of civilization. The arrangements they made were considered by the inhabitants as very oppressive; and one Norman, of the Macleod family, attacked and subdued them so effectually, that they not only consented to yield the property of the islands to him, but engaged to obtain the king's pardon for what he had done.

839  
James succeeds to the crown of England.

In 1603 James was called to the throne of England by the death of Elizabeth, and the same year took a final leave of Scotland (A). From this period the history of Scotland, being blended with that of England, is included in the article BRITAIN; to which therefore we refer the reader, and shall proceed to give a general account of the country.

840  
General description of Scotland.

The first and great division of Scotland is into the Highlands and Lowlands. The former engross more than one half of Scotland; extending from Dumbar-tonshire to the most northern part of the island, a space of 200 miles in length, and in breadth from 50 to 100. This tract, however, includes several extensive districts of low, fruitful ground, inhabited by people who are in all respects different from the mountaineers. Nothing can be more savage and tremendous to the eye of a stranger, than the appearance of the Highlands, composed of blue rocks and dusky mountains heaped upon one another even above the clouds, their interstices rendered impassable by bogs, their sides embrowned with heath, and their summits covered with snow, which lies all the year unthawed, pouring from their jagged sides a thousand torrents and roaring cataracts

that fall into gloomy vales or glens below, some of them so narrow, deep, and dismal, as to be altogether impenetrable by the rays of the sun; yet even these mountains are in some places sloped into agreeable green hills fit for pasture, and skirted or interspersed with pleasant fraths or valleys capable of cultivation. It may be unnecessary to observe, that the Lowlanders of Scotland speak an ancient dialect of the English language, interlarded with many terms and idioms which they borrowed immediately from France, in a long course of correspondence with that kingdom: they likewise copy their southern neighbours in their houses, equipage, habit, industry, and application to commerce. As to the inhabitants of the mountains, see the article HIGHLANDERS. They are, all, however, comprehended under the name of Scots, governed by the same laws, and tried by the same judges; and, whatever may be their dissensions at home, they always, when abroad, acknowledge and assist one another as friends and countrymen. Some authors have divided Scotland into that part which lies to the southward of the Frith, and that which lies to the northward; but the true division is, like that of England, into shires, counties, stewartries or bailiwicks, of which there are above 40 within the kingdom of Scotland.

The face of this country exhibits a very mountainous appearance, especially to the west and northward; but, at the same time, it displays many large and long tracts of plain ground fit for all the purposes of agriculture. It is divided from east to west by a chain of huge mountains, known by the name of *Grant's bain* or the *Grampian hills*. There is another chain called the *Pentland hills*, which run through Lothian, and join the mountains of Tweeddale; a third, called *Lammer-muir*, rising near the eastern coast, runs westward through the Merse: but besides these, there is a vast number of detached hills and mountains, remarkable for their stupendous height and steepness. There is no country in the world better supplied than Scotland with rivers, lakes, rivulets, and fountains. Over and above the principal rivers of Tweed, Forth, Clyde, Tay, and Spey, there is an infinity of smaller streams that contribute to the beauty, convenience, and advantage of the kingdom. Tweed takes its rise from the borders of Annandale; serves as a boundary between Scotland and England; and, after a long serpentine course, discharges itself into the sea at Berwick. Forth rises in Monteith near Callendar, passes by Stirling, and after a course of 25 leagues, runs into the arm of the sea called the *Frith of Forth*, which divides the coast of Lothian from Fife. Clyde takes its rise from Errick hill, in the shire of Lanerk; traverses the shire of Clydesdale, to which it gives name; washes the city of Glasgow, widens in its passage to the castle of Dumbarton, and forms the frith of Clyde adjoining to the Irish sea. Tay, the largest river in Scotland, derives its source from Loch-Tay in Breadalbane; and, after a south-east course, discharges itself into

841  
Principal mountains, &c.

(A) In 1589 James was married to Anne princess of Denmark, for whom he made a voyage on purpose to that country. This princess seems to have intermeddled very little with state-affairs, since we find her scarce ever mentioned either by Scots or English historians. In her private conduct she is said to have been unprincipled, vindictive, and unfaithful to her husband.

Scotland. into the sea below Dundee. Spay, or Spey, issues from a lake of the same name in Badenoch; and, running a north-easterly course, falls into the German ocean, at Speymouth. Some of the fresh-water lakes are beautiful pieces of water, incredibly deep, and surprisingly extended. There are several large forests of fir in Scotland, and a great number of woods; which, however, produce very little timber of any consequence: but the country, in general, is rather bare of trees; and in many places neither tree, shrub, nor any kind of plantation, is to be seen. The case has been otherwise of old; for huge trunks of trees are often dug from under ground in almost every part of the kingdom.

842  
Climate and  
Soil. In the north of Scotland, the day at midsummer is lengthened out to 18 hours and 5 minutes; so that the shortest night does not exceed 5 hours and 35 minutes: the night and day, in winter, are in the same proportion. The air of this kingdom is generally moist and temperate, except upon the tops of high mountains covered with eternal snow, where it is cold, keen, and piercing. In other parts it is tempered by warm vapours from the sea, which environs it on three sides, and runs far up into the land by friths, inlets, and indentations. This neighbourhood of the sea, and the frequency of hills and mountains, produce a constant undulation in the air, and many hard gales, that purify the climate, which is for the most part agreeable and healthy. Scotland affords a great variety of soil in different parts of the country, which, being hilly, is in general well adapted to pasturage: not but that the Lowlands are as fertile, and, when properly inclosed and manured, yield as good crops of wheat as any grounds in the island of Great Britain. The water in Scotland is remarkably pure, light, and agreeable to the stomach: but, ever and above that which is used for the ordinary purposes of life, here are many medicinal springs of great note.

Scotland abounds with quarries of free-stone easily worked, which enable the people to build elegant houses, both in town and country, at a small expence, especially as they have plenty of lime-stone, and labour very cheap. The east, west, and northern parts of the country produce excellent coal; and where this is wanting, the natives burn turf and peat for fuel. Crystals, variegated pebbles, and precious stones, are found in many parts of Scotland; tale, flint, and sea shells, fuller's earth, potter's clay, and metals in great plenty. The country produces iron and copper ore, a prodigious quantity of lead, mixed with a large proportion of silver; and in some places little bits of solid gold are gathered in brooks immediately after torrents.

The Lowlands of Scotland, as has been observed when duly cultivated, yield rich harvests of wheat; and indeed it must be owned that many parts of this kingdom rival the best spots of England in agriculture: but these improvements have not yet advanced into the western and northern extremities of the island, where we see nothing but scanty harvests of oats, rye, and barley. The Highlands are so defective even in these, that it is necessary to import supplies of oatmeal from Ireland and Liverpool. This scarcity, however, we must not impute to the barrenness of the soil, so much as to the sloth and poverty of the tenants, oppressed by rapacious landlords, who refuse to grant such leases as would encourage the husbandman to improve his farm

and make himself better acquainted with the science of agriculture. This is perfectly well understood in the Lothians, where we see substantial inclosures, plantations, meadows for hay and pasture, wide extended fields of wheat, the fruits of skill and industry, and meet with farmers who rent lands to the amount of 400 l. or 500 l. a-year. Of plants this country produces an immense variety, growing wild, exclusive of those that are raised by the hands of the husbandman and gardener. Their farm-grounds are well stocked with wheat, rye, barley, oats, hemp, and flax: their gardens produce great plenty of kitchen-roots, salads, and greens; among which last we reckon the colewort, known by the name of *Scotch kail*: their orchards bear a variety of apples, pears, cherries, plums, strawberries, gooseberries, raspberries, and currants: here also apricots, nectarines, peaches, and sometimes grapes, are brought to maturity. In a word, there is nothing, whether shrub, fruit, or flower, that grows in any part of South Britain, which may not, with a little pains, be brought to the same perfection in the middle of Scotland. Among the trees and shrubs which are the national growth of this country, we may reckon the oak, the fir, the birch, the poplar, the alder, willow, elder, hazle, mountain-ash, crab-tree, and juniper; which last abounds to such a degree in some parts of the Highlands, that in the space of a few miles many tons of the berries might be yearly gathered: besides these, we find the hawthorn, the sloe, the dog-rose, furze, broom, fern, and whole tracts of land and mountains covered with strong heath. This affords shelter for the myrtillis, the fruit of which, called *bilberries*, is here found in great abundance, as well as the brambleberry, cranberry, and wild strawberry. The ash, the elm, the sycamore, lime and walnut-tree, are chiefly planted about the houses of gentlemen; but even the inclosures of quickset appear naked for want of such hedge-rows as adorn the country of England. Indeed, great part of this kingdom lies naked and exposed like a common; and other parts have no other inclosure than a paltry wall huddled up of loose stones, which yields a bleak and mean prospect, and serves no other purpose than that of keeping out the cattle. All the sea-coast is covered with *alga marina*, dulce, and other marine plants.

The Highlands are well stocked with red deer, and the smaller species called the *roe-buck*, as well as with hares, rabbits, foxes, wild cats, and badgers; and they abound with all sorts of game. The rivers and lakes pour forth a profusion of salmon, trout, jack, and eels; the sea-coast swarms with all the productions of the ocean. The hills and mountains are covered with sheep and black cattle for exportation, as well as domestic use. These are of small size, as are also the horses bred in the Highlands; but the Lowlanders use the large breed, which came originally from England.

*New SCOTLAND.* See *NOVA SCOTIA.*

SCOTOMIA, in medicine, a vertigo accompanied with dimness of sight, frequently the forerunner of an apoplexy.

SCOTT (John), an eminent English divine, was born in 1638, and became minister of St Thomas's in Southwark. In 1684 he was collated to a prebend in the cathedral of St Paul's. Dr Hickee tells us, that, after the revolution, "he first refused the bishopric of Chester, because he would not take the oath of ho-

Scotus,  
Scougal

mage; and afterwards another bishopric, the deanery of Worcester, and a prebend of the church of Windfor, because they were all places of deprived men." He published several excellent works, particularly 'The Christian Life, &c. and died in 1695. He was eminent for his humanity, affability, sincerity, and readiness to do good; and his talent for preaching was extraordinary.

SCOTUS (Duns). See DUNS.

SCOTUS (John). See ERIGENA.

SCOUAL (Henry), second son of Patrick Scougal bishop of Aberdeen, was born, June 1650, at Salton in East Lothian, where his father, the immediate predecessor of Bishop Burnet, was rector. His father, designing him for the sacred ministry, watched over his infant mind with peculiar care; nor was his care bestowed in vain. He had soon the satisfaction of perceiving the most amiable dispositions unfold themselves, and his understanding rise at once into the vigour of manhood. Relinquishing the amusements of youth, young Scougal applied to his studies with ardour; and, agreeable to his father's wish, at an early period he directed his thoughts to sacred literature. He perused the historical parts of the bible with peculiar pleasure, and then began to examine its contents with the eye of a philosopher. He was struck with the peculiarities of the Jewish dispensation, and felt an anxiety to understand the reason why its rites and ceremonies were abolished. The nature and evidences of the Christian religion also occupied his mind. He perused sermons with pleasure, committed to writing those passages which most affected him, and could comprehend and remember their whole scope. Nor was he inattentive to polite literature. He read the Roman classics, and made considerable proficiency in the Greek, in the Hebrew, and other oriental languages. He was also well versed in history and mathematics. His diversions were of a manly kind. After becoming acquainted with the Roman history, in concert with some of his companions he formed a little senate where orations of their own composition were delivered.

At the age of fifteen he entered the university, where he behaved with great modesty, sobriety, and diligence. He disliked the philosophy then taught, and applied himself to the study of natural philosophy; that philosophy which has now happily got such footing in the world, and tends to enlarge the faculties. In consequence of this, we may here observe, that when he was yet about eighteen years of age, he wrote the reflections and short essays since published; which tho' written in his youth, and some of them left unfinished, breathe forth so much devotion, and such an exalted soul, as must convince us his conversation was in heaven.

In all the public meetings of the students he was unanimously chosen president, and had a singular deference paid to his judgment. No sooner had he finished his courses, but he was promoted to a professorship in the university of Aberdeen, where he conscientiously performed his duty in training up the youth under his care in such principles of learning and virtue as might render them ornaments to church and state. When any divisions and animosities happened in the society, he was very instrumental in reconciling and bringing them to a good understanding. He maintain-

ed his authority among the students in such a way as to keep them in awe, and at the same time to gain their love and esteem. Sunday evenings were spent with his scholars in discoursing against vice and impiety of all kinds, and encouraging religion in principle and practice. He allotted a considerable part of his yearly income for the poor; and many indigent families, of different persuasions, were relieved in their straits by his bounty; though so secretly that they knew not whence their supply came.

Having been a professor of philosophy for four years, he was at the age of twenty-three ordained a minister, and settled at Auchterless, a small village about twenty miles from Aberdeen. Here his zeal and ability for his great Master's service were eminently displayed. He catechised with great plainness and affection, and used the most endearing methods to recommend religion to his hearers. He endeavoured to bring them to a close attendance on public worship, and joined with them himself at the beginning of it. He revived the use of lectures, looking on it as very edifying to comment upon and expound large portions of scripture. And though he endured several outward inconveniences, yet he bore them with patience and meekness. But as God had designed him for an eminent station, where he could be of more universal use in his church, he was removed from his private charge to that of training up youth for the holy ministry and the care of souls. In the twenty-fifth year of his age he was admitted professor of divinity in the king's college, Aberdeen; and though he was unanimously chosen, yet he declined a station of such importance, from a modest sense of his unfitness for it: And as he had been an ornament to his other stations of life, so in a particular manner he applied himself to the exercise of this office. After he had guarded his students against the common artifices of the Romish missionaries in making profelytes, he proposed two subjects for public exercises; the one, of the pastoral care; the other, of casuistical divinity: but there were no debates he was more cautious to meddle with than the decrees of God; sensible that secret things belong to God; and to us things revealed.

The inward dispositions of this excellent man are best seen in his writings; and the whole of his outward behaviour and conversation was the constant practice of what he preached; as we are assured by the concurring testimony of several respectable persons who knew him. How unsuitable then would panegyric be, where the subject was full of humility? and therefore let it suffice to say, that after he began to appear publicly, you see him as a professor, earnest at once to improve his scholars in human and sacred learning; as a pastor, he ceased not to preach the word, to exhort, to reprove, and to rebuke with all authority: and as a professor of divinity, he bestowed the utmost pains to convince the candidates for the ministry of the weight and importance of that high office; that it was not to be followed for lucre, but purely to promote the worship of God and the salvation of men. Again, if we consider his private life, how meek, how charitable, and how self-denied! how disinterested in all things, how resigned to the divine will! and above all, how refined his sentiments with regard to the love of God! How amiable must he then appear! How

worthy

Scougal

Scougal  
||  
Screw.

worthy of imitation, and of the universal regret at his death! In this light we see clearly that the memory of the just is blessed.

At length his health began to be impaired by incessant study, and about the twenty-seventh year of his age he fell into a consumption, which wasted him by slow degrees. But during the whole time of his sickness he behaved with the utmost resignation, nor did he ever show the least impatience.

When his friends came to visit him, he would say, "he had reason to bless God it was no worse with him than it was. And (says he) when you have the charity to remember me in your prayers, do not think me a better man than I am; but look on me, as indeed I am, a miserable sinner." Upon the twentieth day of June 1678 he died, in the greatest calmness, in the twenty-eighth year of his age, and was buried in the King's College Church in Old Aberdeen. The principal work of Scougal is a small treatise intitled, *The Life of God in the Soul of Man*. This book is not only valuable for the sublime spirit of piety which it breathes, but for the purity and elegance of its style; qualities for which few English writers were distinguished before the Revolution.

SCOUTS, in a military sense, are generally horsemen sent out before, and on the wings of an army, at the distance of a mile or two, to discover the enemy, and give the general an account of what they see.

SCRATCH-PANS, in the English salt-works, a name given to certain leaden pans, which are usually made about a foot and an half long, a foot broad, and three inches deep, with a bow or circular handle of iron, by which they may be drawn out with a hook when the liquor in the pan is boiling. Their use is to receive a saline matter, known by the name of *soft scratch*, which falls during the evaporation of the salt-water. See the article *Sea Salt*.

SCRATCHES, in fariery. See there, § xxxvii.

SCREED, with plasters, is the floated work behind a cornice, and is only necessary when a cornice is to be executed without bracketing.

SCREW, one of the six mechanical powers. A screw is a cylinder cut into several concave surfaces, or rather a channel or groove made in a cylinder, by carrying on two spiral planes the whole length of the screw, in such a manner that they may be always equally inclined to the axis of the cylinder in their whole progress, and also inclined to the base of it in the same angle. See MECHANICS, n 30

N<sup>o</sup> 1. *To construct a common, or one-threaded Screw.*—Make a parallelogram of paper equal in length to the cylinder which is to be screwed, and equal in breadth to the circumference of that cylinder. Divide the side of the parallelogram, which is equal to the circumference of the cylinder, into two equal parts. Divide the other side of the parallelogram, which is equal in length to the cylinder, into as many parts as the thickness or breadth of the intended thread will run over. Then join the second point on the circumference side to the second point on the length-side of the parallelogram, and so join all the succeeding points as you see in the figure.

N<sup>o</sup> 2. *To make a four-threaded Screw, or that which is commonly used for the letter-press.*—Make a parallel-

ogram, as described before; divide that side which is equal to the circumference of the cylinder into eight equal parts, or twice the number of threads. Divide the other side into as many parts as the distance between two threads will run over, then join the points as in n<sup>o</sup> 1. (fig. 1).

COROLLARY. *To make a left-handed screw.*—Make the parallels to the right instead of the left, as expressed by the figures, n<sup>o</sup> 3.

This is the true and only practicable way of making all kinds of screws that are cut on a cylinder.

*Archimedes's SCREW.* See HYDROSTATICS, n 40.

*Endless or Perpetual SCREW,* one so fitted in a compound machine as to turn a dented wheel: so called, because it may be turned for ever without coming to an end.

If in the endless or perpetual screw, A B (n<sup>o</sup> 2), whose threads take the teeth of the wheel CD, you take the distance of two threads, according to the length of the axis AB; or the distance of two teeth in the wheel CD, in the direction of the circumference; and if a weight W act at the circumference of the wheel: then, if the power D be to the weight W, as that distance of the teeth or threads, to the length described by the power P in one revolution, the power and weight will be in equilibrio; because in one revolution of P, the wheel DC, with the weight W, has moved only the distance of one tooth.

SCRIBE, in Hebrew *סופר* *sopher*, is very common in scripture, and has several significations. It signifies,

1. A clerk, writer, or secretary. This was a very considerable employment in the court of the kings of Judah, in which the scripture often mentions the secretaries as the first officers of the crown. Seraiah was scribe or secretary to king David (2 Sam. viii. 17). Shevah and Shemaiah exercised the same office under the same prince (2 Sam. xx. 25). In Solomon's time we find Elihoreph and Ahiah secretaries to that prince (1 Kings iv. 4). Shebna under Hezekiah (2 Kings xix. 2). And Shaphan under Josiah (2 Kings xxii. 8). As there were but few in those times that could write well, the employment of a scribe or writer was very considerable.

2. A scribe is put for a commissary or muster-master of an army, who makes the review of the troops, keeps the list or roll, and calls them over. Under the reign of Uziah king of Judah, there is found Jeil the scribe who had under his hand the king's armies (2 Chr. xxvi. 11). And at the time of the captivity, it is said the captain of the guard, among other considerable persons, took the principal scribe of the host, or secretary at war, which mulctured the people of the land (2 Kings xxv. 19).

3. Scribe is put for an able and skilful man, a doctor of the law, a man of learning that understands affairs. Jonathan, David's uncle by the father's side, was a counsellor, a wise man, and a scribe (1 Chr. xxvii. 3). Baruch, the disciple and secretary to Jeremiah, is called a *scribe* (Jer. xxxvi. 26). And Ezra is celebrated as a skilful scribe in the law of his God (Ezra vii. 6). The scribes of the people, who are frequently mentioned in the Gospel, were public writers and professed doctors of the law, which they read and explained to the people. Some place the original of scribes under

Screw,  
Scribe.

Plate  
ccccxviii.

Scribe  
||  
Scrimzeor.

der Moses: but their name does not appear till under the judges. It is said, that in the wars of Barak against Sifera, "out of Machir came down governors, and out of Zebulun they that handle the pen of the writer." (Judges v. 14). Others think that David first instituted them, when he established the several classes of the priests and Levites. The scribes were of the tribe of Levi; and at the time that David is said to have made the regulations in that tribe, we read that 6000 men of them were constituted officers and judges (1 Chr. xxiii. 4.); among whom it is reasonable to think the scribes were included. For in 2 Chr. xxiv. 6. we read of Shemaiah the scribe, one of the Levites; and in 2 Chr. xxxiv. 13. we find it written, "Of the Levites that were scribes and officers."

The scribes and doctors of the law, in the scripture phrase, mean the same thing; and he that in Mat. xxii. 35. is called a *doctor of the law*, or a *lawyer*, in Mark xii. 28. is named a *scribe*, or *one of the scribes*. And as the whole religion of the Jews at that time chiefly consisted in pharisaical traditions, and in the use that was made of them to explain the scripture; the greatest number of the doctors of the law, or of the scribes, were pharisees; and we almost always find them joined together in scripture. Each of them valued themselves upon their knowledge of the law, upon their studying and teaching it (Mat. xxii. 52.): they had the key of knowledge, and sat in Moses's chair (Mat. xxiii. 2). Epiphanius, and the author of the *Recognitions* imputed to St Clement, reckon the scribes among the sects of the Jews; but it is certain they made no sect by themselves; they were only distinguished by their study of the law.

SCRIBONIUS (Largus), an ancient physician in the reign of Augustus or Tiberius, was the author of several works; the best edition of which is that of John Rhodius.

SCRIMZEOR or SCRIMGEOUR (Henry), an eminent restorer of learning, was born at Dundee in the year 1506. He traced his descent from the ancient family of the Scrimzeours of Didupe, who obtained the office of hereditary standard-bearers to the kings of Scotland in 1057.

At the grammar-school of Dundee our author acquired the Greek and Latin languages to an uncommon degree of perfection, and that in a shorter space of time than many scholars before him. At the university of St Andrew's his successful application to philosophy gained him great applause. The next scene of his studies was the university of Paris, and their more particular object the civil law. Two of the most famous civilians of that age, Eguinard Baron and Francis Duaren (A), were then giving their lectures to crowded circles at Bourges. The fame of these professors occasioned his removal from Paris; and for a considerable time he prosecuted his studies under their direction.

At Bourges he had an opportunity of becoming acquainted with the celebrated James Amiot, Greek professor in that city, well known in the learned world by his translation of Plutarch's Lives, and distinguished afterwards by his advancement to great honours in the church, and finally to the rank of cardinal.

Through the recommendation of this eminent person, Mr Scrimzeor engaged in the education of two young gentlemen of the name of Bucherel, whom he instructed in the belles lettres, and other branches of literature, calculated to accomplish them for their station in life.

This connection introduced him to Bernard Bornelet bishop of Rennes, a person famed in the political world for having served the state in many honourable embassies. Accepting an invitation from this prelate to accompany him to Italy, Mr Scrimzeor greatly enlarged the sphere of his literary acquaintance, by his conversation and connection with most of the distinguished scholars of that country. The death of Francis Spira (B) happened during his visit at Padua; and as the character and conduct of this remarkable person at that time engaged the attention of the world, Mr Scrimzeor is said to have collected memoirs of him in a publication entitled, "The Life of Francis Spira, by Henry of Scotland." This performance, however, does not appear in the catalogue of his works.

After he had stored his mind with the literature of foreign countries, and satisfied his curiosity as a traveller,

(A) "Francis Duaren was the first of the French civilians who purged the chair in the civil law schools from the barbarisms of the Glossaries, in order to introduce the pure sources of the ancient jurisprudence. As he did not desire to share that glory with any one, he looked with an envious eye on the reputation of his colleague Eguinard Baron, who also mixed good literature with the knowledge of the law. This jealousy put him upon composing a work, wherein he endeavoured to lessen the esteem that people had for his colleague. The maxim, '*Pascitur in vivis livor; post fata quiescit.*' was verified remarkably in him; for after the death of Baron, he showed himself most zealous to eternize his memory, and was at the expence of a monument to the honour of the deceased." From the Translation of Bayle's Dict. of 1710, p. 1143-4.

(B) Francis Spira was a lawyer of great reputation at Cittadella in the Venetian state, at the beginning of the 16th century. He had imbibed the principles of the Reformation, and was accused before John de la Casa, archbishop of Benevento, the pope's nuncio at Venice. He made some concessions, and asked pardon of the papal minister for his errors. But the nuncio insisted upon a public recantation. Spira was exceedingly averse to this measure; but at the pressing instances of his wife and his friends, who represented to him that he must lose his practice and ruin his affairs by persisting against it, he at last complied. Shortly after he fell into a deep melancholy, lost his health, and was removed to Padua for the advice of physicians and divines; but his disorders augmented. The recantation, which he said he had made from cowardice and interest, filled his mind with continual horror and remorse; inasmuch that he sometimes imagined that he felt the torments of the damned. No means being found to restore either his health or his peace of mind, in 1548 he fell a victim to his miserable situation. See Collyer's Dict.—Spira.



ler, it was his intention to have revisited Scotland. He might without vanity have entertained hopes, that the various knowledge which he had treasured would have won him a partial reception among his countrymen. An ambition of being usefully distinguished among them as a man of letters is justly supposed the principal motive of his desire to return: but the most sanguine projects of life are often strangely diverted by accident, or rather perhaps are invisibly turned by Providence, from their purposed course. Mr Scrimzeor, on his journey homewards, was to pass through Geneva. His fame had long forerun his footsteps. The syndics and other magistrates, upon his arrival, requested him to set up the profession of philosophy in that city; promising a compensation suitable to the exertion of his talents. He accepted the proposal, and established the philosophical chair.

After he had taught for some time at Geneva, a fire broke out in his neighbourhood, by which his house was consumed, and he himself reduced to great distress. His late pupils, the Bucherels, had not forgotten their obligations to him, and sent a considerable sum of money to his relief.

At this time flourished at Augsburg that famous mercantile family (c), the Fuggers. Ulric Fugger was then its representative; a man possessed of prodigious wealth, passionately fond of literature, a great collector of books and manuscripts, and a munificent patron of learned men. Being informed by means of his literary correspondence of the misfortune which had befallen Mr Scrimzeor in the burning of his house, he immediately sent him a pressing invitation to accept an asylum beneath his roof till his affairs could be re-established. Mr Scrimzeor, gladly availing himself of such a hospitable kindness, lost no time in going to Germany.

Whilst residing at Augsburg with Mr Fugger, he was much employed in augmenting his patron's library by vast collections, purchased from every corner of Europe. Manuscripts of the Greek and Latin authors were then of inestimable value, and seem to have been more particularly the object of Mr Scrimzeor's researches.

He did not lead a life of yawning indolence amidst these treasures, and, like a mere unfeeling collector, leave them unenjoyed. As librarian, he was not contented to act the part of a black eunuch to his literary seraglio. He seems to have forgotten that he was not its Grand Sultan, and accordingly ranged at will among surrounding beauties. He composed many works of great learning and ingenuity, whilst he continued in a situation so peculiarly agreeable to the views and habits of a scholar.

When his manuscripts were ready for the press, he was desirous of returning to Geneva to print them. His patron, Fugger, recommended him for this purpose to the very learned Henry Stephens, one of his pensioners, and at that time one of the most celebrated printers in Europe.

Vol. XVII. Part I.

Immediately on his arrival at Geneva, 1563, he was earnestly solicited by the magistrates to resume the chair of philosophy. Notwithstanding his compliance, and in consequence of it the dedication of much of his time to the study of physics, he, two years afterwards, instituted a course of lectures in the civil law, and had the honour of being its first founder and professor at Geneva.

As soon as he was settled again in this city, he hoped, amidst his other occupations, to prosecute the great object of his literary fame, the printing of his various works. But a suspicion which Henry Stephens entertained, that it was his intention to set up a rival press at Geneva, occasioned great dissensions between them. The result of the quarrel was, that the republic of letters, during Mr Scrimzeor's life, was deprived of his valuable productions. They fell most of them at his death into the hands of Isaac Casaubon, who has been accused of publishing considerable portions of them as his own.

Some account of Mr Scrimzeor's several performances will give an idea of his extensive erudition.

He wrote critical and explanatory notes upon Athenæus's (D) *Deipnosophists*, or Table-conversations of Philosophers and Learned Men of Antiquity; having first collated several manuscripts of his author. This work Casaubon published at Leyden in 1600; but without distinguishing his own notes from those of Scrimzeor.

A Commentary and Emendations of the Geography of Strabo were among our author's literary remains. These were published in Casaubon's Parisian edition of Strabo, 1620. Henry Stephens, from an idea of justice due to Scrimzeor's literary fame, notwithstanding the violent animosity which had subsisted betwixt them, reproaches Casaubon for adopting our Scottish critic's lucubrations on Strabo without acknowledgment.—Dempster assures us, that Scrimzeor, in his manuscript letters, mentions his design of publishing this performance; whence, it is probable, that his work appeared to himself of considerable consequence, and had taken up much of his attention. Although Casaubon, in his ample notes exhibited at the foot of Strabo's text, makes no confession of having derived any thing from Scrimzeor, it must not be concealed, that in an epistle to Sir Peter Young, our critic's nephew, through whom the Commentary and Emendations of Strabo came into his hands, Casaubon acknowledges how very useful to him they might be made; for speaking there of his intended edition of Strabo, he says, "It cannot be expressed how much assistance I may obtain from your notes of Scrimzeor."

Edward Herrison, a Scottish author, in his Commentary on Plutarch's Book concerning the Inconsistencies of the Stoics, informs us, that Scrimzeor collated different manuscripts of all the works of Plutarch. This undertaking appears sufficient to have occupied half the life of an ordinary critic. Every one knows how voluminous an author was the philosopher, the historian, and orator of Chæroneæ. Whether our learned

O

critic

(c) They were ennobled by the emperor in 1510, under the title of Barons of Kirkberg and Weissenborn.

(D) Athenæus was a grammarian of Naucrates in Egypt, and lived in the second century. His *Deipnosophistæ* is a very curious and learned work, in 15 books. It is full of interesting anecdotes and descriptions of ancient manners, and has preserved many relics of Grecian poetry not to be found elsewhere.

Scrimzeor. critic had meant to publish an edition of Plutarch's works is not known; but such an intention should seem highly probable from this laborious enterprise of collating them.

The 10 books of Diogenes Laertius on the Lives, Opinions, and Apophthegms of the Philosophers, were collated from various manuscripts by Scrimzeor. His corrected text of this author, with notes full of erudition, came also into Casaubon's possession, and is supposed to have contributed much to the value of his edition of the Grecian Biographer, printed at Paris in 1593.

The works of Phornutus and Palæphatus were also among the collations of Mr Scrimzeor. To the latter of these authors he made such considerable additions, that the work became partly his own. These were two ancient authors who explain the fables of the heathen deities. The former wrote *De Natura Deorum, seu de Fabularum Poeticarum Allegoriis Speculatio*, "On the Nature of the Gods, or the Allegorical Fictions of the Poets." The latter entitled his book *Ἄγισα, Sive de falsis Narrationibus*, "Things incredible, or concerning false Relations." These works were printed at Basil, 1570; whether in Greek or Latin is uncertain. They have been published since in both languages.

The manuscripts of them were for some time preserved in the library of Sir Peter Young, after that of his uncle Scrimzeor, which was brought into Scotland in 1573, had been added to it. What became of this valuable bequest at the death of the former, is uncertain.

Our learned philologer left also behind him in manuscript the orations of Demosthenes, Æschines, and Cicero, and the Ecclesiastical History of Eusebius, all carefully collated.

Among his literary remains was a collection of his Latin epistles. The men of letters in the 15th and 16th centuries seem to have kept their republic, as it is called, more united and compact than it is at present, by an epistolary intercourse in the Latin language, then the universal medium of literature and science. This general spirit of communication could not but contribute greatly to the advancement of learning, as well as to the pleasure, and, we may add, to the importance, of those who were engaged in its pursuit. The intercourse and union of enlightened men, able and disposed to promote the happiness of their fellow-creatures, cannot be too close. From such intellectual combination alone it is, that uniformity of religious, moral, and political principles, to its greatest attainable degree, can ever be expected; or, in other words, the greatest possible benefit derived from the cultivation of letters.

Of the many performances which had exercised his pen, it does not appear that any were immediately published by himself but his Translation of Justinian's Novels into Greek. This was printed at Paris in 1558, and again with Holoander's Latin version at Antwerp in 1575. This work has been highly extolled, both for the purity of its language and the accuracy of its execution, and is likely, according to some respectable opinions, to hold its estimation as long as any use or memory of the civil law shall exist.

A Latin translation of the *Basilica*, or Basilics, as they are called by our civilians, is the last we have to

mention of this author's performances. This is a collection of Roman Laws, which the eastern emperors Basil and Leo, who reigned in the fifth century, commanded to be translated into Greek, and which preferred their authority till the dissolution of the eastern empire. The Basilics comprehend the institutes, digests, code, and novels, and some of the edicts of Justinian and other emperors. Of 60 original books, 41 only remain. Mr Scrimzeor collated them with various manuscripts, probably before he commenced his translation.

From the foregoing recital of the learned labours of this profound scholar and critic, it will be concluded, that almost the whole of his life, although long, was spent in his library, and that the biographer, having now terminated the catalogue of his writings, is probably not distant from the conclusion of his life. Different years have been assigned for the time of his death; but it appears most likely, from a comparison of the different accounts of this event, that it happened very near the expiration of 1571, or at the beginning of the succeeding year, about the 66th year of his age. He died in the city of Geneva.

The characteristic features of Scrimzeor are few, but they are prominent and striking, and remote posterity may regard him with no inferior degree of respect. His industry and perseverance in the pursuit of knowledge and erudition were equalled only by the exquisite judgement which he displayed in his critical annotations and commentaries on the errors and obscurities of ancient books and manuscripts.

His acquisitions in the Greek, Latin, and oriental languages, were reckoned much beyond those of most of the professed linguists of his time. The great Cujacius used to say, "That he never quitted Mr Scrimzeor's conversation without having learned something new." But that which lent peculiar grace to such superiority, was the amiable modesty which upon all occasions was observed to accompany it. From the commendation given him by the illustrious civilian just mentioned, it will be concluded, that he did not brood, with a jealous reserve, over unlocked treasures of erudition; but that, conscious of possessing stores too ample to be soon exhausted, at the same time that he avoided an ostentatious profusion of them, he obliged and delighted his friends by a liberal communication. From the period at which he lived, considered with the nature and extent of his studies, and his abilities in prosecuting them, he may deservedly be ranked among those eminent characters who have most successfully contributed their exertions to the revival of letters in Europe.

SCRIPTURE is a word derived from the Latin *Scriptura*, and in its original sense is of the same import with *writing*, signifying "any thing written." It is, however, commonly used to denote the writings of the Old and New Testaments; which are called sometimes *the Scriptures*, sometimes the *sacred* or *holy Scriptures*, and sometimes *canonical Scripture*. These books are called *the Scriptures* by way of eminence, as they are the most important of all writings; they are said to be *holy* or *sacred* on account of the sacred doctrines which they teach; and they are termed *canonical*, because when their number and authenticity were ascertained, their names were inserted in ecclesiastical *canons*, to distinguish

Scripture. 2  
e au-  
tenticity  
the Old  
Testament  
ved  
3  
om the  
character  
the Jews,

guish them from other books; which, being of no authority, were kept as it were out of sight, and therefore styled *apocryphal* (A).

The authenticity of the Old Testament may be proved from the character of the Jews, from internal evidence, and from testimony.

1. The character of the Jews affords a strong presumptive evidence that they have not forged or corrupted the Old Testament. Were a person brought before a court of justice on a suspicion of forgery, and yet no presumption or positive evidence of his guilt could be produced, it would be allowed by all that he ought to be acquitted. But farther, if the forgery alleged were inconsistent with the character of the accused; if it tended to expose to disgrace and reproach his general principles and conduct; or if we were assured that he considered forgery as an impious and abominable crime—it would require very strong testimony to establish his guilt. The case now mentioned corresponds exactly with the character and situation of the Jews. If a Jew had forged any book of the Old Testament, he must have been impelled to so bold and dangerous an enterprise by some very powerful motive. It could not be national pride, for there is scarcely one of these books which does not severely censure the national manners. It could not be the love of fame; for that passion would have taught him to flatter and extol the national character; and the punishment, if detected, would have been infamy and death. The love of wealth could not produce such a forgery; for no wealth was to be gained.

The Jews were selected from the other nations of the world, and preserved a distinct people from the time of their emigration from Egypt to the Babylonish captivity, a period of 892 years. The principal purposes for which they were selected was to preserve in a world running headlong into idolatry the knowledge and worship of the one true God, and to be the guardians of those sacred books that contained the prophecies which were to prove to future ages the divine mission of the Redeemer of mankind. To fit them for these important trusts, the spirit of their laws and the rites of their religion had the strongest tendency. Miracles were openly performed, to convince them that the God of Israel was the God of all the earth, and that he alone was to be worshipped. Public calamities always befel them when they became apostates to their God; yet they continued violently attached to idolatry till their captivity in Babylon made them for ever renounce it.

The Jews then had two opposite characters at different periods of their history: At first they were addicted to idolatry; afterwards they acquired a strong antipathy against it.

Had any books of the Old Testament been forged before the Babylonish captivity, when the Jews were devoted to idolatry, is it to be conceived that the impostor would have inveighed so strongly against this vice, and so often imputed to it the calamities of the state; since by such conduct he knew that he would render himself obnoxious to the people and to those idolatrous monarchs who persecuted the prophets?

Scripture.

But it may next be supposed, that “the sacred books were forged after the Babylonish captivity, when the principles of the Jews would lead them to inveigh against the worship of idols. But these principles would surely never lead them to expose the character of their ancestors, and to detail their follies and their crimes. Never had any people more national pride, or a higher veneration for their ancestors, than the Jews. Miracles and prophecies ceased soon after their return to Jerusalem; and from that period their respect for the sacred books approached to superstition. They preserved them with pious care, they read them often in their synagogues, and they considered every attempt to alter the text as an act of sacrilege. Is it possible that such men could be guilty of forgery, or could false writings be easily imposed on them?

2. There is an internal evidence in the books of the Old Testament that proves them to have been written by different persons, and at distant periods; and enables us with precision to ascertain a time at or before which they must have been composed. It is an undeniable fact that Hebrew ceased to be the living language of the Jews during the Babylonish captivity, and that the Jewish productions after that period were in general written either in Chaldee or in Greek. The Jews of Palestine, some ages before the coming of our Saviour, were unable, without the assistance of a Chaldee paraphrase, to understand the Hebrew original. It necessarily follows, therefore, that every book which is written in pure Hebrew was composed either before or about the time of the Babylonish captivity. This being admitted, we may advance a step farther, and contend that the period which elapsed between the composition of the most ancient and the most modern book of the Old Testament was very considerable; or, in other words, that the most ancient books of the Old Testament were written many ages before the Babylonish captivity.

No language continues stationary; and the Hebrew, like other tongues, passed through the several stages of infancy, youth, manhood, and old age. If therefore, on comparison, the several parts of the Hebrew Bible are found to differ not only in regard to style, but also in regard to character and cultivation, we have strong internal marks that they were composed at different and distant periods. No classical scholar would believe, independent of the Grecian history, that the poems ascribed to Homer were written in the age of Demosthenes, the Orations of Demosthenes in the time of Origen, or the Commentaries of Origen in the time of Lascaris and Chrysoloras. For the very same reason, it is certain that the five books which are ascribed to Moses were not written in the time of David, the Psalms of David in the age of Isaiah, nor the prophecies of Isaiah in the time of Malachi; and since the Hebrew became a dead language about the time of the Babylonish captivity, the book of Malachi could not have been written much later. Before that period therefore were written the prophecies of Isaiah, still earlier the Psalms of David, and much earlier than these the books which are ascribed to Moses.

O 2

3. Let

(A) From ἀποκρύπτω, to put out of sight.

Scripture.

From testi-  
mony.

3. Let us now consider the evidence of testimony for the authenticity of the Old Testament. As the Jews were a more ancient people than the Greeks or Romans, and for many ages totally unconnected with them, it is not to be expected that we should derive much evidence from the historians of those nations: it is to the Jews alone we must look for information. But it has unfortunately happened that few of their works except the Scriptures themselves have been preserved to posterity. Josephus is the most ancient of the Jewish historians to whom we can appeal. He informs us, that the Old Testament was divided into three parts, the Law, the Prophets, and the Hagiographa or poetical books. No man, says he, hath ever dared to add or take away from them. He tells us also, that other books were written after the time of Artaxerxes; but as they were not composed by prophets, they were not reckoned worthy of the same credit.

Since the promulgation of the Christian religion, it is impossible that any material alterations or corruptions could have taken place in the books of the Old Testament; for they have been in the hands both of Jews and Christians from that period. Had the Jews attempted to make any alterations, the Christians would have detected and exposed them; nor would the Jews have been less severe against the Christians if they had corrupted the sacred text. But the copies in the hands of Jews and Christians agree; and therefore we justly conclude, that the Old Testament is still pure and uncorrupted.

The division mentioned by our Saviour into the Law, the Prophets, and the Psalms, corresponds with that of Josephus. We have therefore sufficient evidence, it is hoped, to convince even a deist, that the Old Testament existed at that time. And if the deist will only allow, that Jesus Christ was a personage of a virtuous and irreproachable character, he will acknowledge that we draw a fair conclusion when we assert that the Scriptures were not corrupted in his time: for when he accused the Pharisees of making the law of no effect by their traditions, and when he enjoined his hearers to search the Scriptures, he could not have failed to mention the corruptions or forgeries of Scripture, if any in that age had existed. But we are assured, by very respectable authority, that the canon of the Old Testament was fixed some centuries before the birth of Jesus Christ. Jesus the son of Sirach, the author of Ecclesiasticus, makes evident references to the prophecies of Isaiah \*, Jeremiah †, and Ezekiel ‡, and mentions these prophets by name. He speaks also of the twelve minor prophets §. It appears also from the prologue, that the law and the prophets, and other ancient books, existed at the same period. The book of Ecclesiasticus, according to the calculations of the best chronologers, was written in Syriac about A. M. 3772, that is, 232 years before the Christian era, and was translated into Greek in the next century by the grandson of the author. The prologue was added by the translator: but this circumstance does not diminish the evidence for the antiquity of Scripture; for he informs us, that the law and the prophets, and the other books of their fathers, were studied by his grandfather: a sufficient proof that they existed in his time. As no authentic books of a more ancient date, except the sacred writings them-

\* Ecclesi-  
asticus  
xlviii. 22.  
† xlix. 6.  
‡ xlix. 8.  
§ xlix. 10.

elves, have reached our time, we can ascend no higher in search of testimony.

There is, however, one remarkable historical fact, which proves the existence of the law of Moses at the dissolution of the kingdom of Israel, when the ten tribes were carried captive to Assyria by Salmanser, and dispersed among the provinces of that extensive empire; that is, about 741 years before Christ. It was about that time the Samaritans were transported from Assyria to repopulate the country, which the ten captive tribes of Israel had formerly inhabited. The posterity of the Samaritans still inhabit the land of their fathers, and have preserved copies of the Pentateuch, two or three of which were brought to this country in the last century. The Samaritan Pentateuch is written in old Hebrew characters (see PHILOLOGY, n° 28), and therefore must have existed before the time of Ezra. But so violent were the animosities which subsisted between the Jews and Samaritans, that in no period of their history would the one nation have received any books from the other. They must therefore have received them at their first settlement in Samaria from the captive priest whom the Assyrian monarch sent to teach them how they should fear the Lord (2 Kings xvii.)

The canon of the Old Testament, as both Jewish and Christian writers agree, was completed by Ezra and some of his immediate successors (see BIBLE). In our copies the sacred books are divided into 39. The Jews reckoned only 22, corresponding to the number of letters in the Hebrew alphabet. They united the books of Judges and Ruth; they joined the two books of Samuel; the books of Kings and Chronicles were reckoned one; Ezra and Nehemiah one; the Prophecies and Lamentations of Jeremiah were taken under the same head; and the 12 minor prophets were considered as one book—so that the whole number of books in the Jewish canon amounted to 22.

The Pentateuch consists of the five books Genesis, Exodus, Leviticus, Numbers, and Deuteronomy. Several observations have been already made respecting the authenticity of these under the article PENTATEUCH; but several additional remarks have occurred, which may not improperly be given in this place. For many of these we acknowledge ourselves indebted to a sermon published by the reverend Mr Marsh, whose research and learning and critical accuracy will be acknowledged by every reader of discernment.

One of the strongest arguments that have occurred to us in support of the authenticity of the Pentateuch, and the inspiration of the writer, has already been given under the article RELIGION, n° 14, &c. which see: But we shall in this place present two arguments of a different kind, which would be sufficient to prove at least the former of these conclusions. We argue from the language and contents of the Mosaic writings, and from the testimony of the other books of Scripture.

From the contents and language of the Pentateuch there arises a very strong presumption that Moses was its author. The very mode of writing in the four last books discovers an author contemporary with the events which he relates; every description, both religious and political, is a proof that the writer was present at each respective scene; and the legislative and historical parts

Scripture.

6  
The canon  
of the Old  
Testament  
settled.

7  
The Pen-  
tateuch  
written by  
Moses,

8  
Proved by  
internal  
evidence,

Scripture. are so interwoven with each other, that neither of them could have been written by a man who lived in a later age. The account which is given in the book of Exodus of the conduct of Pharaoh towards the children of Israel, is such as might be expected from a writer who was not only acquainted with the country at large, but had frequent access to the court of its sovereign: and the minute geographical description of the passage thro' Arabia is such, as could have been given only by a man like Moses, who had spent 40 years in the land of Midian. The language itself is a proof of its high antiquity, which appears partly from the great simplicity of the style, and partly from the use of archaisms or antiquated expressions, which in the days even of David and Solomon were obsolete (b). But the strongest argument that can be produced to show that the Pentateuch was written by a man born and educated in Egypt, is the use of Egyptian words; words which never were, or ever could have been, used by a native of Palestine: and it is a remarkable circumstance, that the very same thing which Moses had expressed by a word that is pure Egyptian, Isaiah, as might be expected from his birth and education, has expressed by a word that is purely Hebrew (c).

That Moses was the author of the Pentateuch is proved also from the evidence of testimony. We do not here quote the authority of Diodorus Siculus, of Longinus, or Strabo, because their information must have been derived from the Jews. We shall seek no authority but that of the succeeding sacred books themselves, which bear internal evidence that they were written in different ages, and therefore could not be forged unless we were to adopt the absurd opinion that there was a succession of impostors among the Jews who united together in the same fraud. The Jews were certainly best qualified to judge of the authenticity of their own books. They could judge of the truth of the facts recorded, and they could have no interest in adopting a forgery. Indeed, to suppose a whole nation combined in committing a forgery, and that this combination should continue for many hundred years, would be the most chimerical supposition that ever entered into the mind of man. Yet we must make this supposition, if we reject the historical facts of the Old Testament. No one will deny that the Pentateuch existed in the time of Christ and his apostles; for they not only mention it, but quote it. "This we admit," reply the advocates for the hypothesis which we are now combating; "but you cannot therefore conclude that Moses was the author; for there is reason to believe it was composed by Ezra." But unfortunately for men of this opinion, both Ezra and Nehemiah ascribe the book of the law to Moses †. 2. The Pentateuch was in the possession of the Samaritans before the time of Ezra. 3. It existed in the reign of Amaziah king of Judah, A. C. 839

years †. 4. It was in public use in the reign of Jehosaphat, A. C. 912; for that virtuous prince appointed Levites and priests who taught in Judah, and had the book of the law of the Lord with them, and went about throughout all the cities of Judah and taught the people †. 5. It is referred to by David in his dying admonitions to Solomon †. The same royal bard makes many allusions to it in the book of Psalms, and sometimes quotes it \*. There remains therefore only one resource to those who contend that Moses was not the author, viz. that it was written in the period which elapsed between the age of Joshua and that of David. But the whole history of the Jews from their settlement in Canaan to the building of the temple presupposes that the book of the law was written by Moses. 6. We have satisfactory evidence that it existed in the time of Joshua. One passage may be quoted where this fact is stated. The Divine Being makes use of these words to Joshua: "Only be thou strong, and very courageous, that thou mayest observe to do all according to the law which Moses my servant commanded thee: turn not from it to the right hand or to the left, that thou mayest prosper whithersoever thou goest. *This book of the law shall not depart out of thy mouth; and thou shalt meditate therein day and night, that thou mayest observe to do according to all that is written therein †.*"

To the foregoing demonstration objections may be stated. "We will admit the force of your arguments, and grant that Moses actually wrote a work called the book of the law; but how can we be certain that it was the very work which is now current under his name? And unless you can show this to be at least probable, your whole evidence is of no value." To illustrate the force or weakness of this objection, let us apply it to some ancient Greek author, and see whether a classical scholar would allow it to be of weight. "It is true that the Greek writers speak of Homer as an ancient and celebrated poet; it is true also that they have quoted from the works which they ascribe to him various passages that we find at present in the Iliad and Odyssey: yet still there is a possibility that the poems which were written by Homer, and those which we call the Iliad and Odyssey, were totally distinct productions." Now an advocate for Greek literature would reply to this objection, not with a serious answer, but with a smile of contempt; and he would think it beneath his dignity to silence an opponent who appeared to be deaf to the clearest conviction. But still more may be said in defence of Moses than in defence of Homer; for the writings of the latter were not deposited in any temple or sacred archive, in order to secure them from the devastations of time; whereas the copy of the book of the law, as written by Moses, was intrusted to the priests and the elders, preserved in the ark of the covenant,

Scripture. † 2 Chron. xxv. 4. † Kings xiv. 6. † 2 Chron. xvii. 8, 9. † 1 Kings ii. 3. \* Comp. Psalm ciii. 7, 8. with Exod. xxxiv. 6. in the original, where the words are the very same. † Joshua i. 7, 8. viii. 31. xxiii. 6. 10 General objections answered.

Ezra iii. viii. 14. them. ii. 1.

(b) For instance, מלל *ille*, and נער *puer*, which are used in both genders by no other writer than Moses. See Gen. xxiv. 14. 16. 28. 55. 57. xxxviii. 21. 25.

(c) For instance, מר (perhaps written originally מר, and the *v* lengthened into *y* by mistake), written by the Seventy αχι or αχις, Gen. xli. 2. and מר, written by the Seventy Δικη or Δικης. See *La Croze Lexicon Aegyptiacum*, art. AXI and ΘΗΒΙ

The same thing which Moses expresses by מר, Gen. xli. 2. Isaiah xix. 7. expresses by מר, for the Seventy have translated both of these words by αχι.

Scripture.

and read to the people every seventh year (D). Sufficient care therefore was taken not only for the preservation of the original record, but that no spurious production should be substituted in its stead. And that no spurious production ever has been substituted in the stead of the original composition of Moses, appears from the evidence both of the Greek and the Samaritan Pentateuch. For as these agree with the Hebrew, except in some trifling variations (E), to which every work is exposed by length of time, it is absolutely certain that the five books which we now ascribe to Moses are one and the same work with that which was translated into Greek in the time of the Ptolemies, and, what is of still greater importance, with that which existed in the time of Solomon. And as the Jews could have had no motive whatsoever, during that period which elapsed between the age of Joshua and that of Solomon, for substituting a spurious production instead of the original as written by Moses, and, even had they been inclined to attempt the imposture, would have been prevented by the care which had been taken by their lawgiver, we must conclude that our present Pentateuch is the very identical work that was delivered by Moses.

11  
Particular  
objections  
obviated.

The positive evidence being now produced, we shall endeavour to answer some particular objections that have been urged. But as most of these occur in the book of Genesis, we shall reserve them for separate examination, and shall here only consider the objections peculiar to the four last books. They may be comprised under one head, viz. expressions and passages in these books which could not have been written by Moses. 1. The account of the death of Moses, in the last chapter of Deuteronomy, we allow must have been added by some succeeding writer; but this can never prove that the book of Deuteronomy is spurious. What is more common among ourselves than to see an account of the life and death of an author subjoined to his works, without informing us by whom the narrative was written? 2. It has been objected, that Moses always speaks of himself in the third person. This is the objection of foolish ignorance, and therefore scarcely deserves an answer. We suspect that such persons have never read the classics, particularly Cæsar's Commentaries, where the author uniformly speaks of himself in the third person, as every writer of correct taste will do who reflects on the absurdity of employing the pronoun of the first person

in a work intended to be read long after his death. (See GRAMMAR, n<sup>o</sup> 33.) 3. As to the objection, that in some places the text is defective, as in Exodus xv. 8. it is not directed against the author, but against some transcriber; for what is wanting in the Hebrew is inserted in the Samaritan. 4. The only other objection that deserves notice is made from two passages. It is said in one place that the bed of Og is at Ramah *unto this day*; and in another (Deut. iii. 14.), "Jair the son of Manasseh took all the country of Argob unto the coasts of Geshuri and Maacathi, and called them after his own name, Bashan-havoth-jair, *unto this day*." The last clause in both these passages could not have been written by Moses, but it was probably placed in the margin by some transcriber by way of explanation, and was afterwards by mistake inserted in the text. Whoever doubts the truth of this assertion may have recourse to the manuscripts of the Greek Testament, and he will find that the spurious additions in the texts of some manuscripts are actually written in the margin of others (F).  
That the Pentateuch, therefore, at least the four last books of it, was written by Moses, we have very satisfactory evidence; which, indeed, at the distance of 3000 years is wonderful, and which cannot be affirmed of any profane history written at a much later period.  
The book of Genesis was evidently not written by a person who was contemporary with the facts which he records; for it contains the history of 2369 years, a period comprehending almost twice as many years as all the rest of the historical books of the Old Testament put together. Moses has been acknowledged as the author of this book by all the ancient Jews and Christians; but it has been a matter of dispute from what source he derived his materials; some affirming that all the facts were revealed by inspiration, and others maintaining that he procured them from tradition.  
Some who have looked upon themselves as profound philosophers, have rejected many parts of the book of Genesis as fabulous and absurd: but it cannot be the wisdom of philosophy, but the vanity of ignorance, that could lead to such an opinion. In fact, the book of Genesis affords a key to many difficulties in philosophy which cannot otherwise be explained. It has been supposed that the diversities among mankind prove that they are not descended from one pair; but it has been fully

Scripture.

12  
Authenticity of the  
book of  
Genesis.

(D) "And Moses wrote this law, and delivered it unto the priests the sons of Levi, which bare the ark of the covenant of the Lord, and unto all the elders of Israel. And Moses commanded them, saying, At the end of every seven years, in the solemnity of the year of release, in the feast of tabernacles, when all Israel is come to appear before the Lord thy God, in the place which he shall choose, thou shalt read this law before all Israel in their hearing. And it came to pass, when Moses had made an end of writing the words of this law in a book until they were finished, that Moses commanded the Levites, which bare the ark of the covenant of the Lord, saying, Take this book of the law, and put it in the side of the ark of the covenant of the Lord your God." Deut. xxxi. 9—11. 24—26. There is a passage to the same purpose in Josephus: *Δηλοῦται δὴ τῶν ἀνακείμενων ἐν τῷ βιβλίῳ τῆς ἀρχαίας, Josephi Antiquitat. Lib. V. c. 1. § 17. ed. Hudson.*

(E) See the collation of the Hebrew and Samaritan Pentateuch, in the 6th vol. of the *London Polyglot*. p. 19. of the *Animadversiones Samariticae*.

(F) To mention only two examples. 1. The common reading, 1 Cor. xvi. 2. is *οὐκ ἔστι βιβλίον*; but the Codex Pitavianus 3. has *τὴν ἀρχαίαν* in the margin; and in one of the manuscripts which Beza used, this marginal addition has been obtruded in the text. See his note on this passage. 2. Another instance is, 1 John ii. 27. where the genuine reading is *χρῆσμα*; but Wetstein quotes two manuscripts, in which *πνεῦμα* is written in the margin; and this marginal reading has found its way not only into the Codex Covellii 2. but into the Coptic and Ethiopic versions.

Scripture. fully shewn that all these diversities may be accounted for by natural causes. It has been reckoned a great difficulty to explain how fossil shells were introduced into the bowels of the earth; but the deluge explains this fact better than all the romantic theories of philosophers. It is impossible to account for the origin of such a variety of languages in a more satisfactory manner than is done in the account of the confusion of tongues which took place at Babel. It would be no easy matter to shew why the sea of Sodom is so different from every other sea on the globe which has yet been explored, if we had not possessed the scriptural account of the miraculous destruction of Sodom and Gomorrah. It is saturated with bitumen and salt, and contains no fishes. These are very singular facts, which have been fully established by late travellers. The book of Genesis, too, has been treated with contempt, because it makes the world less ancient than is necessary to support the theories of modern philosophers, and because it is difficult to reconcile the chronologies of several nations with the opinion that the world is not above 6000 or 7000 years old. The Chaldeans, in the time of Cicero, reckoned up 470,000 years. The Egyptians pretend that they have records extending 50,000 years back; and the Hindoos go beyond all bounds of probability, erring back their chronology, according to Halhed, more than 7,000,000 of years.

13  
faic  
onology  
dicatd.

An attempt has been made by M. Bailly, lately mayor of Paris, to reconcile these magnified calculations with the chronology of the Septuagint, which is justly preferred to the Hebrew. (See SEPTUAGINT.) He informs us, that the Hindoos, as well as the Chaldeans and Egyptians, had years of arbitrary determination. They had months of 15 days, and years of 60 days, or two months. A month is a night and day of the patriarchs; a year is a night and day of the gods; four thousand years of the gods are as many hundred years of men. By attention to such modes of computation, the age of the world will be found very nearly the same in the writings of Moses, and in the calculations and traditions of the Bramins. With these also we have a remarkable coincidence with the Persian chronology. Bailly has established these remarkable epochs from the Creation to the Deluge.

The Septuagint gives	- - -	2256 years.
The Chaldeans	- - -	2222
The Egyptians	- - -	2340
The Persians	- - -	2000
The Hindoos	- - -	2000
The Chinese	- - -	2300

The same author has also shewn the singular coincidence of the age of the world as given by four distinct and distant situated people.

The ancient Egyptians,	- - -	5544 years.
The Hindoos,	- - -	5502
The Persians	- - -	5501
The Jews, according to Josephus,	- - -	5555

Having made these few remarks, to shew that the facts recorded in Genesis are not inconsistent with truth, we shall now, by a few observations, confirm the evidence, from testimony, that Moses was the author, and answer the objections that seem strongest.

There arises a great probability, from the book of Genesis itself, that the author lived near the time of Joseph; for as we advance towards the end of that book,

the facts gradually become more minute. The materials of the antediluvian history are very scanty. The account of Abraham is more complete; but the history of Jacob and his family is still more fully detailed. This is indeed the case with every history. In the early part, the relation is very short and general; but when the historian approaches his own time, his materials accumulate. It is certain, too, that the book of Genesis must have been written before the rest of the Pentateuch; for the allusions in the last four books to the history of Abraham, of Isaac, and Jacob, are very frequent. The simplicity of the style shows it to be one of the most ancient of the sacred books; and perhaps its similarity to the style of Moses would determine a critic to ascribe it to him. It will be allowed, that no man was better qualified than Moses to compose the history of his ancestors. He was learned in all the wisdom of the Egyptians, the most enlightened nation of his time, and he had the best opportunities of obtaining accurate information. The short account of the antediluvian world could easily be remembered by Abraham, who might obtain it from Shem, who was his contemporary. To Shem it might be conveyed by Methuselah, who was 340 years old when Adam died. From Abraham to Moses, the interval was less than 400 years. The splendid promises made to that patriarch would certainly be carefully communicated to each generation, with the concomitant facts: and thus the history might be conveyed to Moses by the most distinguished persons. The accounts respecting Jacob and his son Joseph might be given to Moses by his grandfather Kohath, who must have been born long before the descent to Egypt; and Kohath might have heard all the facts respecting Abraham and Isaac from Jacob himself. Thus we can easily point out how Moses might derive the materials of the book of Genesis, and especially of the last 38 chapters, from the most authentic source.

It will now be necessary to consider very shortly the objections that have been supposed to prove that Genesis could not have been written by Moses. 1. It is objected, that the author of the first chapters of Genesis must have lived in Mesopotamia, as he discovers a knowledge of the rivers that watered Paradise, of the cities Babyion, Erech, Resen, and Calneh; of the gold of Pison; of the bdellium and onyx stone. But if he could not derive this knowledge from the wisdom of the Egyptians, which is far from being improbable, he might surely obtain it by tradition from Abraham, who was born and brought up beyond the Euphrates. 2. In Genesis xiv. 14. it is said, Abraham pursued the four confederate kings to Dan, yet that name was not given till after the conquest of Palestine\*. We answer, this might be inserted by a transcriber. But such a supposition is not necessary; for though we are told in the book of Judges that a city originally called Laish received then the name of Dan, this does not prove that Laish was the same city with the Dan which is mentioned in Genesis. The same answer may be given to the objection which is brought from Genesis xxxv. 21. where the tower of Edar is mentioned, which the objectors say was the name of a tower over one of the gates of Jerusalem. But the tower of Edar signifies the tower of the flocks, which in the pastoral country of Canaan might be a very common name. 3. The most formidable objection is derived from these two passages, Gen. xii. 6.

Scripture.

14  
Objections  
to the au-  
thenticity  
of the book  
of Genesis  
obviated.

\* Judges,  
chap. xviii.  
22.

And.

Scripture. "And the Canaanite was then in the land." Gen. xxxvi. 21. "These are the kings that reigned over the land of Edom, before there reigned any king over the children of Israel." Now, it is certain that neither of these passages could be written by Moses. We allow they were added by a later writer; but this circumstance cannot invalidate the evidence which has been already produced. It does not prove that Moses was not the author of the book of Genesis, but only that the book of Genesis has received two alterations since his death.

According to Rivet, our Saviour and his Apostles have cited 27 passages verbatim from the book of Genesis, and have made 38 allusions to the sense.

15  
The book of Exodus.

The book of Exodus contains the history of the Israelites for about 145 years. It gives an account of the slavery of the Israelites in Egypt; of the miracles by which they were delivered; of their passage through the Red Sea, and journey through the wilderness; of the solemn promulgation of the Decalogue on Mount Sinai, and of the building and furniture of the Tabernacle. This book is cited by David, by Daniel, and other sacred writers. Twenty-five passages are quoted by our Saviour and his apostles in express words, and they make 19 allusions to the sense.

16  
Leviticus.

The book of Leviticus contains the history of the Israelites for one month. It consists chiefly of laws. Indeed, properly speaking, it is the code of the Jewish ceremonial and political laws. It describes the consecration of Aaron and his sons, the daring impiety and exemplary punishment of Nadab and Abihu. It reveals also some predictions respecting the punishment of the Israelites in case of apostacy; and contains an assurance that every sixth year should produce abundance to support them during the seventh or sabbatical year. This book is quoted as the production of Moses in several books of scripture \*.

\* 2 Chron xxx. 10.  
Jerem vii. 22, 23.  
ix. 16.  
Ezek. xx. 17.  
Matth. vii. 4.  
Rom. x. 5.  
xiii. 9.  
2 Cor. vi. 16.  
Gal. iii. 12  
1 Pet. i. 10

The book of Numbers comprehends the history of the Israelites for a period of about 38 years, reckoning from the first day of the second month after their departure from Egypt. It contains an account of two numberings of the people; the first in the beginning of the second year of their emigration, the second in the plains of Moab towards the conclusion of their journey in the wilderness †. It describes the ceremonies employed at the consecration of the tabernacle, gives an exact journal of the marches and encampments of the Israelites, relates the appointment of the 70 elders, the miraculous cure performed by the brazen serpent, and the misconduct of Moses when he was commanded to bring water from the rock. There is also added an account of the death of Aaron, of the conquest of Sihon and Og, and the story of Balaam, with his celebrated prophecy concerning the Messiah §.

17  
Numbers.  
† Numb. i. xxvi.

The book of Numbers is quoted as the work of Moses in several parts of Scripture \*.

§ Numb. xxiv. 17, 19.

\* Joshua iv. 12.  
2 Chron. xlix. 11.  
xxx. 1.  
Ezek. x. 13.  
xlv. 27.  
Matth. xii. 5.  
John vi. 31. ix. 36.

The book of Deuteronomy comprehends a period of nearly two months. It consists of an interesting address to the Israelites, in which Moses recalls to their remembrance the many instances of divine favour which they had experienced, and reproaches them for their ingratitude. He lays before them, in a compendious form, the laws which he had formerly delivered, and makes some explanatory additions. This was the more necessary, because the Israelites, to whom they had been originally promulgated, and who had seen the miracles in Egypt, at the Red Sea, and Mount Sinai, had died in

18  
Deute-  
o-  
lomy.

the wilderness. The divine origin of these laws, and the miracles by which they were sanctioned, must already have been well known to them; yet a solemn recapitulation of these by the man who had miraculously fed the present generation from their infancy, who by the lifting up of his hands had procured them victory in the day of battle, and who was going to leave the world to give an account of his conduct to the God of Israel, could not but make a deep and lasting impression on the minds of all who heard him. He inculcates these laws by the most powerful motives. He presents before them the most animating rewards, and denounces the severest punishments to the rebellious. The prophecies of Moses towards the end of this book, concerning the fate of the Jews, their dispersions and calamities, the conquest of Jerusalem by the Romans, the miseries of the besieged, and the present state of the Jewish nation, cannot be read without astonishment. They are perspicuous and minute, and have been literally accomplished.

This book is cited as the production of Moses by Christ and his apostles \*.

4. The historical books are 12 in number, Joshua, Judges, Ruth, Samuel I. and II. Kings I. and II. Chronicles, Ezra, Nehemiah, Esther. These, if considered distinctly from the Pentateuch, and the writings more properly styled prophetic, contain a compendium of the Jewish history from the death of Moses, A. M. 2552, to the reformation established by Nehemiah after the return from the captivity, A. M. 3595, comprehending a period of 1043 years.

\* Matth. iv. 4.  
John i. 45.  
Act. iii. 22.  
Gal. iii. 13.

To enable us to discover the authors of these books, we have no guide to conduct us but conjecture, internal evidence, or the authority of the modern Jews. From the frequent references in Scripture, and from the testimony of Josephus, it appears that the Jews were in possession of many historical records which might have thrown much light upon this subject if they had still been preserved. But during the calamities which befel that insatuated nation in their wars with the Romans, and the dispersion which followed, these writings have perished. But though we can produce no testimony more ancient than the age of our Saviour to authenticate the historical books, yet there are some facts respecting the mode of their preservation which entitle them to credit. The very circumstance itself, that the Jews have preserved them in the sacred volume to this day, while their other ancient books have been lost, is a proof that they considered them as the genuine records of their nation. Josephus †, whose authority is of great importance, informs us, that it was the peculiar province of the prophets and priests to commit to writing the annals of the nation, and to preserve them to posterity. That these might be faithfully preserved, the sacerdotal function was made hereditary, and the greatest care was observed to prevent intermarriages either with foreigners or with the other tribes. No man could officiate as a priest who could not prove his descent in a right line by unquestionable evidence ‡. Registers were kept in Jerusalem, which at the end of every war were regularly revised by the surviving priests; and new ones were then composed. As a proof that this has been faithfully performed, Josephus adds, that the names of all the Jewish priests, in an uninterrupted succession from father to son, had been registered for 2000 years; that is, from the time of Aaron to the age of Josephus.

19  
The histo-  
ric books,

20  
Deserving  
of the full-  
est credit.

† Contra-  
Apion,  
lib. 1.

‡ Ezra ii. 61, 62.



Scripture.

The national records were not allowed to be written by any man who might think himself fit for the office; and if a priest falsified them, he was excluded from the altar and deposed from his office. Thus we are assured, the Jewish records were committed to the charge of the priests; and as they may be considered as the same family from Aaron to the Babylonish captivity and downwards, the same credit is due to them that would be due to family records, which by antiquarians are esteemed the most authentic sources of information.

21  
written  
of the  
Hebrew  
records.

Of the 22 books which Josephus reckoned himself bound to believe, the historical books from the death of Moses to the reign of Artaxerxes, he informs us, were written by contemporary prophets. It appears, then, that the prophets were the composers, and the priests the hereditary keepers, of the national records. Thus, the best provision possible was made that they should be written accurately, and be preserved uncorrupted. The principal office of these prophets was to instruct the people in their duty to God, and occasionally to communicate the predictions of future events. For this purpose they were educated in the schools of the prophets, or in academies where sacred learning was taught. The prophets were therefore the learned men of their time, and consequently were best qualified for the office of historians. It may be objected, that the prophets, in concert with the priests, might have forged any writings they pleased. But before we suspect that they have done so in the historical books of the Old Testament, we must find out some motive which could induce them to commit so daring a crime. But this is impossible. No encomiums are made either upon the prophets or the priests; no adulation to the reigning monarch appears, nor is the favour of the populace courted. The faults of all ranks are delineated without reserve. Indeed there is no history extant that has more the appearance of impartiality. We are presented with a simple detail of facts, and are left to discover the motives and intentions of the several characters; and when a character is drawn, it is done in a few words, without exaggerating the vices or amplifying the virtues.

It is of no real consequence, therefore, whether we can ascertain the authors of the different books or not. From Josephus we know that they existed in his time; and from his account of the manner in which they were preserved we are assured they were not in danger of being corrupted. They existed also when the Septuagint translation was made. Frequent references are made to them in the writings of the later prophets; sometimes the same facts are related in detail. In short, there is such a coincidence between the historical books and the writings of those prophets who were contemporary, that it is impossible to suppose the latter true without receiving the former.

Indeed, to suppose that the Jews could have received and preserved with such care for so many hundred years false records, which it must have been in the power of every person to disprove, and which at the same time do so little credit to the character of their nation,

Vol. XVII. Part I.

is to suppose one of the greatest absurdities in the world: it is to suppose that a whole nation could act contrary to all those principles which have always predominated in the human mind, and which must always predominate till human nature undergo a total revolution.

The book which immediately follows the Pentateuch has been generally ascribed to Joshua the successor of Moses. It contains, however, some things which must have been inserted after the death of Joshua. It is necessary to remark, that there is some accidental derangement in the order of the chapters of this book, which was probably occasioned by the ancient mode of fixing together a number of rolls. If chronologically placed, they should be read thus, 1st chapter to the 10th verse, then the 2d chapter; then from the 10th verse to the end of the 1st chapter; afterwards should follow the vi. vii. viii. ix. x. and xi. chapters; then the xxii.; and lastly the xii. and xiii. chapters to the 24th verse of the latter.

The facts mentioned in this book are referred to by many of the sacred writers. In the book of Kings xvi. 34. the words of Joshua are said to be the words of God. See JOSHUA.

By whom the book of Judges was written is uncertain; but as it contains the history of the Jewish republic for 317 years, the materials must have been furnished by different persons. The book, however, seems to be the composition of one individual (G), who lived after the regal government was established, but before the accession of David: for it is said in the 21st verse of the 1st chapter, that the Jebusites were still in Jerusalem; who, we know, were dispossessed of that city early in the reign of David. We have reason, therefore, to ascribe this book to Samuel.

The history of this book may be divided into two parts: the first contains an account of the Judges from Othniel to Samson, ending at the 16th chap. The second part relates several remarkable transactions which occurred soon after the death of Joshua; but are thrown to the end of the book, that they might not interrupt the course of the history. See JUDGES.

The book of Ruth is a kind of supplement to the book of Judges, and an introduction to the history of David, as it is related in the books of Samuel. Since the genealogy which it contains descends to David, it must have been written after the birth of that prince, but not at any considerable time after it; for the history of Boaz and Ruth, the great-grandfather and great-grandmother of David, could not be remembered above two or three generations. As the elder brothers of David and their sons are omitted, and none of his own children are mentioned in the genealogy, it is evident that the book was composed in honour of the Hebrew monarch, after he was anointed king by Samuel, and before any of his children were born; and consequently in the reign of Saul. The Jews ascribe it to Samuel; and indeed there is no person of that age to whom it may be attributed with more propriety. We are informed (1 Sam. x. 25.) that Samuel was a writer,

P

and

(G) In support of this opinion, it may be observed, that the author, chap. ii. 10, &c. lays before us the contents of the book.

Scripture. and are assured that no person in the reign of Saul was so well acquainted with the splendid prospects of David as the prophet Samuel.

<sup>25</sup>  
The two book of Samuel  
The Greeks denominate the books of Samuel, which follow next in order, *The Books of Kingdoms*; and the Latins, *The Books of Kings I. and II.* Anciently there were but two books of Kings; the first was the two books of Samuel, and the second was what we now call the two books of Kings. According to the present division, these two books are four, viz. the first and second books of *Samuel*, and the first and second books of *Kings*.

Concerning the author of the two books of Samuel there are different opinions. Some think that Samuel wrote only twenty or twenty-four chapters of the first book, and that the history was continued by Nathan and Gad. This opinion they ground on the following passage in *Chronicles* §, "Now the acts of David the king, first and last, behold they are written in the book of Samuel the *seer*, and in the book of Nathan the *prophet*, and Gad the *seer*." Others think they were compiled by Ezra from ancient records; but it is evident that the books of Samuel were written before the books of Kings and Chronicles; for on comparison it will be found, that in the last mentioned books many circumstances are taken from the former. The first book carries down the history of the Israelites from the birth of Samuel to the fatal battle of Gilboa, comprehending a period of about 80 years. The second relates the history of David from his succession to the throne of Israel till within a year or two of his death, containing 40 years. There are two beautiful passages in these books which every man of sentiment and taste must feel and admire, the lamentation or elegy on Saul and Jonathan, and the parable of Nathan. The impartiality of the historian is fully attested by the candour and freedom with which the actions of Saul and David are related. There are some remarks interspersed which were probably added by Ezra.

<sup>26</sup>  
Of Kings.  
When the two books of Kings were written, or by whom they were compiled, is uncertain. Some have supposed that *David*, *Solomon*, and *Hezekiah*, wrote the history of their own times. Others have been of opinion that the prophets, viz. *Isaiah*, *Jeremiah*, *Gad*, and *Nathan*, each of them wrote the history of the reign in which he lived. But it is generally believed that *Ezra* wrote these two books, and published them in the form in which we have them at present. There can be no doubt but the prophets drew up the lives of the kings who reigned in their times; for the names and writings of those prophets are frequently mentioned, and cited. Still, however, it is evident that the two books of Kings are but an abridgment of a larger work, the substance of which is contained in the books before us. In support of the opinion that Ezra is the author of these books, it is said, 'That in the time of the penman, the ten tribes were captives in Assyria, whither they had been carried as a punishment for their sins: That in the second of these books the author makes some reflections on the calamities of Israel and Judah, which demonstrate that he lived after that event. But to this it is objected, That the author of these books expresses himself throughout as a contemporary, and as one would have done who had been an eye and ear witness of what he related. To this objection it is answered,

That Ezra compiled these books from the prophetic writings which he had in his possession; that he copied them exactly, narrating the facts in order as they happened, and interspersed in his history some reflections and remarks arising from the subjects which he handled.

The first book comprises a period of 126 years, from the death of David to that of Jehoshaphat. The second book records the transactions of many kings of Judah and Israel for the space of about 300 years, from the death of Jehoshaphat to the destruction of Jerusalem and the temple, A. M. 3416. A. C. 588.

The Hebrews style the two books of *Chronicles* *De-beri Inim* §, i. e. *Words of days*, journals or diaries, in allusion to those ancient journals which appear to have been kept among the Jews. The Greeks call them *Paralipomena* ¶, which signifies *things omitted*; as if these two books were a kind of supplement to inform us what had been omitted or too much abridged in the books of *Kings*. The two books of *Chronicles* contain indeed several particulars which are not to be met with in the other books of scripture: but it is not therefore to be supposed that they are the records of the kings of Judah and Israel, so often referred to in the books of *Kings*. Those ancient registers were apparently much more copious than the books before us; and the compiler of the books of *Chronicles* often refers to them, and makes long extracts from them.

Some suppose that the author of these two books was the same with that of the two books of *Kings*. The Jews say that they were written by *Ezra*, after the return from the captivity, assisted by *Zechariah* and *Haggai*, who were then alive. But events are mentioned in them of so late a date as to show that he could not have written them in their present form; and there is another objection to his being their author, which is little less forcible: between the books of *Kings* and *Chronicles* there is a great number of variations both in dates and facts, which could not have happened if *Ezra* had been the author of them, or indeed if they had been the work of any one person.

The books of *Chronicles* are not to be considered merely as an abridgment of former histories with some useful additions, but as books written with a particular view; which seems to have been to furnish a genealogical register of the twelve tribes, deduced from the earliest times, in order to point out those distinctions which were necessary to discriminate the mixed multitude that returned from Babylon; to ascertain the lineage of Judah; and to re-establish on their ancient footing the pretensions and functions of each individual tribe.

The book of *Ezra*, and also that of *Nehemiah*, are attributed by the ancients to the former of these prophets; and they called them the 1st and 2d books of *Esdras*; which title is still kept up by the Latin church. It is indeed highly probable that the former of these books, which comprises the history of the Jews from the time that Cyrus made the decree for their return until the twentieth year of Artaxerxes Longimanus (which was about 100 years, or as others think 79 years), was all composed by *Ezra*, except the first six chapters, which contain an account of the first return of the Jews upon the decree of Cyrus; whereas *Ezra* did not return till the time of Artaxerxes. It is of this second return therefore that he writes the account; and adding

Scripture adding it to the other, which he found ready composed to his hand, he made it a complete history of the Jewish restoration.

This book is written in Chaldee from chap. iv. 8. to chap. vii. 27. As this part of the work chiefly contains letters, conversations, and decrees expressed in that language, the fidelity of the historian has probably induced him to take down the very words which were used. The people, too, had been accustomed to the Chaldee during the captivity, and probably understood it better than Hebrew; for it appears from Nehemiah's account, chap. viii. 2, 8. that all could not understand the law.

<sup>29</sup> of Nehemiah. The book of Nehemiah, as has been already observed, bears, in the Latin bibles, the title of the *second book of Esdras*; the ancient canons likewise give it the same name, because, perhaps, it was considered as a sequel to the book of Ezra. In the Hebrew bibles it has the name of *Nehemiah* prefixed to it; which name is retained in the English bible. But though that chief is by the writer of the second book of Maccabees affirmed to have been the author of it, there cannot, we think, be a doubt but that either it was written at a later period, or had additions made to it after Nehemiah's death.

With the book of Nehemiah the history of the Old Testament concludes. This is supposed to have taken place about A. M. 3574. A. C. 434. But Prideaux with more probability has fixed it at A. M. 3595. See NEHEMIAH.

<sup>30</sup> of Esther. It is uncertain who was the author of the book of Esther. *Clement* of Alexandria, and many commentators, have ascribed it to *Mordecai*; and the book itself seems to favour this opinion; for we are told in chap. ix. 20. that "Mordecai wrote these things." Others have supposed that *Ezra* was the author; but the more

probable opinion of the Talmudists is, that the great Synagogue (see SYNAGOGUE), to perpetuate the memory of the deliverance of the Jews from the conspiracy of *Haman*, and to account for the origin of the feast of *Purim*, ordered this book to be composed, very likely of materials left by *Mordecai*, and afterwards approved and admitted it into the sacred canon. The time when the events which it relates happened, is supposed by some to have been in the reign of *Artaxerxes Longimanus*, and by others in that of *Darius the son of Hystaspes*, called by the sacred penman *Ahasuerus*.

Concerning the author of the book of Job there are <sup>31</sup> Of Job. many different opinions. Some have supposed that *Job* himself wrote it in *Syriac* or *Arabic*, and that it was afterwards translated by *Moses*. Others have thought that *Elihu* wrote it; and by others it is ascribed to *Moses*, to *Solomon*, to *Isaiah*, and to *Ezra*. To give even an abridgment of the arguments brought in support of these various opinions would fill a volume, and at last leave the reader in his present uncertainty. He who has leisure and inclination to weigh them may study the second section of the sixth book of *Warburton's Divine Legation of Moses*, together with the several works there referred to; but the question at issue is of very little importance to us. The book of *Job*, by whomsoever it was written, and whether it be a real history, or a dramatical poem founded on history, has been always esteemed a portion of canonical scripture, and is one of the most sublime compositions in the sacred volume.

The book of *Job* appears to stand single and unparalleled in the sacred volume. It seems to have little connection with the other writings of the Hebrews, and no relation whatever to the affairs of the Israelites. The scene is laid in *Idumæa* (H); the history of an inhabitant of that country is the basis of the narrative;

P 2

the

(H) "The information which the learned have endeavoured to collect from the writings and geography of the Greeks concerning the country and residence of *Job* and his friends, appears to me (says *Dr Lowth*) so very inconclusive, that I am inclined to take a quite different method for the solution of this question, by applying solely to the Sacred Writings: the hints with which they have furnished me towards the illustration of this subject, I shall explain as briefly as possible.

"The land of *Uz*, or *Gauz*, is evidently *Idumæa*, as appears from *Lam. iv. 21. Uz* was the grandson of *Seir* the Horite, *Gen. xxxvii. 20, 21, 28. 1. Chron. i. 38, 42.* *Seir* inhabited that mountainous tract which was called by his name antecedent to the time of *Abraham*; but his posterity being expelled, it was occupied by the *Idumæans*: *Gen. xiv. 6. Deut. ii. 12.* Two other men are mentioned of the name *Uz*; one the grandson of *Shem*, the other the son of *Nachor*, the brother of *Abraham*; but whether any district was called after their name is not clear. *Idumæa* is a part of *Arabia Petræa*, situated on the southern extremity of the tribe of *Judah*: *Numb. xxxiv. 3. Josh. xv. 1, 21.* The land of *Uz* therefore appears to have been between *Egypt* and *Philistia*, *Jer. xxv. 20.* where the order of the places seems to have been accurately observed in reviewing the different nations from *Egypt* to *Babylon*; and the same people seem again to be described in exactly the same situations, *Jer. xlvi. 1.*

"*Children of the East*, or *Eastern people*, seems to have been the general appellation for that mingled race of people (as they are called, *Jer. xxv. 20.*) who inhabited between *Egypt* and the *Euphrates*, bordering upon *Judea* from the south to the east; the *Idumæans*, the *Amalekites*, the *Midianites*, the *Moabites*, the *Ammonites*. See *Judges vi. 3. and Isa. xi. 14.* Of these the *Idumæans* and *Amalekites* certainly possessed the southern parts. See *Numb. xxxiv. 3, xiii. 29. 1. Sam. xxvii. 8, 10.* This appears to be the true state of the case: The whole region between *Egypt* and *Euphrates* was called the *East*, at first in respect to *Egypt* (where the learned *Joi. Mede* thinks the *Israelites* acquired this mode of speaking. *Mede's Works*, p. 580.), and afterwards absolutely and without any relation to situation or circumstances. *Abraham* is said to have sent the sons of his concubines, *Hagar* and *Keturah*, "eastward, to the country which is commonly called the *East*." *Gen. xxv. 6.* where the name of the region seems to have been derived from the same situation. *Solomon* is reported "to have excelled in wisdom all the *Eastern people*, and all *Egypt*," *1. Kings iv. 30.*; that is, all the neighbouring people on that quarter: for there

*Sci. Litt.* the characters who speak are Idumæans, or at least Arabians of the adjacent country, all originally of the race of Abraham. The language is pure Hebrew, although the author appears to be an Idumæan; for it is not improbable that all the posterity of Abraham, Israelites, Idumæans, and Arabians, whether of the family of Keturah or Ishmael, spoke for a considerable length of time one common language. That the Idumæans, however, and the Temanites in particular, were eminent for the reputation of wisdom, appears by the testimony of the prophets Jeremiah and Obadiah ¶: Baruch also particularly mentions them among "the authors (or expounders) of fables, and searchers out of understanding &c."

¶ Jer xlix.  
7. Ob. 8.

§ Baruch  
iii. 22, 23.

<sup>32</sup>  
The character of  
Job.

The principal personage in this poem is Job; and in his character is meant to be exhibited (as far as is consistent with human infirmity) an example of perfect virtue. This is intimated in the argument or introduction, but is still more eminently displayed by his

own actions and sentiments. He is holy, devout, and most piously and reverently impressed with the sacred awe of his divine Creator; he is also upright, and conscious of his own integrity; he is patient of evil, and yet very remote from that insensibility or rather stupidity to which the Stoic school pretended. Oppressed therefore with unparalleled misfortunes, he laments his misery, and even wishes a release by death; in other words, he obeys, and gives place to the dictates of nature. Irritated, however, by the unjust insinuations and the severe reproaches of his pretended friends, he is more vehemently exasperated, and the too great confidence in his own righteousness leads him to expostulate with God in terms scarcely consistent with piety and strict decorum.

It must be observed, that the first speech of Job, though it bursts forth with all the vehemence of passion, consists wholly of complaint, "the words and sentiments of a despairing person, empty as the wind\*;" *Job vi. 26.*  
which

there were people beyond the boundaries of Egypt, and bordering on the south of Judea, who were famous for wisdom, namely, the Idumæans (see Jer. xlix. 7. Ob. 8.), to whom we may well believe this passage might have some relation. Thus Jehovah addresses the Babylonians; "Arise, ascend unto Kedar, and lay waste the children of the East," (Jer. xlix. 28). notwithstanding these were really situated to the west of Babylon. Although Job, therefore, be accounted one of the orientals, it by no means follows that his residence must be in Arabia Deserta.

"*Eliphaz the Temanite* was the son of Esau, and Teman the son of Eliphaz, (Gen. xxxvi. 10, 11.). The Eliphaz of Job was without a doubt of this race. Teman is certainly a city of Idumæa, (Jer. xlix. 7, 20. Ezek. xxv. 13. Amos i. 11, 12. Ob. 8, 9.).

"*Bilda: the Shubite*: *Shuab* was one of the sons of Abraham by Keturah, whose posterity were numbered among the people of the East, and his situation was probably contiguous to that of his brother Midian, and of his nephews Shebah and Dedan, (see Gen. xxv. 2. and 3.) Dedan is a city of Idumæa (Jer. xlix. 8.), and seems to have been situated on the eastern side, as Teman was on the west, (Ezek. xxv. 13.). From Sheba originated the Sabæans in the passage from Arabia Felix to the Red Sea: Sheba is united to Midian (Ira. lx. 6.); it is in the same region however with Midian, and not far from Mount Horeb, (Exod. ii. 15. iii. 1.)

"*Zophar the Naamathite*: among the cities which by lot fell to the tribe of Judah, in the neighbourhood of Idumæa, Naama is enumerated, (Josh. xv. 21, 41.) Nor does this name elsewhere occur; this probably was the country of Zophar.

"*Elihu the Buzite*: Buz occurs but once as the name of a place or country (Jer. xxv. 29.), where it is mentioned along with Dedan and Thema: Dedan, as was just now demonstrated, is a city of Idumæa; Thema belonged to the children of Ishmael, who are said to have inhabited from Havilah, even to Shur, which is in the district of Egypt, (Gen. xxv. 15. 18.) Saul, however, is said to have smitten the Amalekites from Havilah even to Shur, which is in the district of Egypt, (1 Sam. xv. 7.) Havilah cannot, therefore, be very far from the boundaries of the Amalekites; but the Amalekites never exceeded the boundaries of Arabia Petræa. (See *Reland Palestin. lib. i. c. xiv.*) Thema, therefore, lay somewhere between Havilah and the desert of Shur, to the southward of Judea. Thema is also mentioned in connection with Sheba, (Job vi. 19.)

"Upon a fair review of these facts, I think we may venture to conclude, still with that modesty which such a question demands, that Job was an inhabitant of Arabia Petræa, as well as his friends, or at least of that neighbourhood. To this solution one objection may be raised: it may be asked, How the Chaldeans, who lived on the borders of the Euphrates, could make depredations on the camels of Job, who lived in Idumæa at so great a distance? This too is thought a sufficient cause for assigning Job a situation in Arabia Deserta, and not far from the Euphrates. But what should prevent the Chaldeans, as well as the Sabæans, a people addicted to rapine, and roving about at immense distances for the sake of plunder, from wandering through these defenceless regions, which were divided into tribes and families rather than into nations, and pervading from Euphrates even to Egypt? Further, I would ask on the other hand, whether it be probable that all the friends of Job who lived in Idumæa and its neighbourhood, should instantly be informed of all that could happen to Job in the desert of Arabia and on the confines of Chaldea, and immediately repair thither? Or whether it be reasonable to think, that some of them being inhabitants of Arabia Deserta, it should be concerted among them to meet at the residence of Job; since it is evident, that Eliphaz lived at Thema, in the extreme parts of Idumæa? With respect to the *Afutas* of Ptolemy (for so it is written, and not *Aufitas*) it has no agreement, not so much as in a single letter with the Hebrew *Gutz*. The LXX indeed call that country by the name *Aufitida*, but they describe it as situated in Idumæa; and they account Job himself an Idumæan, and a descendant of Esau." See the Appendix of the LXX to the book of Job, and *Hyde Not. in Peritzol. chap. xi. Lowth on Hebrew Poetry.*

*Scripture* which is indeed the apology that he immediately makes for his conduct; intimating, that he is far from presuming to plead with God, far from daring to call in question the divine decrees, or even to mention his own innocence in the presence of his all-just Creator: nor is there any good reason for the censure which has been passed by some commentators upon this passage. The poet seems, with great judgment and ingenuity, to have performed in this what the nature of his work required.

He has depicted the affliction and anguish of Job, as flowing from his wounded heart in a manner so agreeable to human nature (and certainly so far venial), that it may be truly said, "in all this Job sinned not with his lips." It is, nevertheless, embellished by such affecting imagery, and inspired with such a warmth and force of sentiment, that we find it afforded ample scope for calumny; nor did the unkind witnesses of his sufferings permit so fair an opportunity to escape. The occasion is eagerly embraced by Eliphaz to rebuke the impatience of Job; and, not satisfied with this, he proceeds to accuse him in direct terms of wanting fortitude, and obliquely to insinuate something of a deeper dye. Though deeply hurt with the coarse reproaches of Eliphaz, still, however, when Job afterwards complains of the severity of God, he cautiously refrains from violent expostulations with his Creator, and, contented with the simple expression of affliction, he humbly confesses himself a sinner ¶. Hence it is evident, that those vehement and perverse attestations of his innocence, those murmurs against the divine Providence, which his tottering virtue afterwards permits, are to be considered merely as the consequences of momentary passion, and not as the ordinary effects of his settled character or manners. They prove him at the very worst not an irreligious man, but a man possessed of integrity, and too confident of it; a man oppressed with almost every imaginable evil, both corporal and mental, and hurried beyond the limits of virtue by the strong influence of pain and affliction. When, on the contrary, his importunate visitors abandon by silence the cause which they had so wantonly and so maliciously maintained, and cease unjustly to load him with unmerited imputations; though he defends his argument with scarcely less obstinacy, yet the vehemence of his grief appears gradually to subside; he returns to himself, and explains his sentiments with more candour and sedateness: and however we may blame him for assuming rather too much of arrogance in his appeals to the Almighty, certainly his defence against the accusations of Eliphaz is no more than the occasion will strictly justify. Observe, in the first place, how admirably the confidence and perseverance of Job is displayed in replying to the slander of his false friends:

May mine enemy be as the impious man,  
And he that riseth up against me as the wicked ¶.

But how magnificent, how noble, how inviting and beautiful is that image of virtue in which he delineates his past life! What dignity and authority does he seem to possess!

If I came out to the gate, nigh the place of public resort,

If I took up my seat in the street;  
The young men saw me, and they hid themselves:  
Nay, the very old men rose up and stood.  
The princes refrained talking,  
Nay, they laid their hands on their mouths.

The nobles held their peace,  
And their tongue cleaved to the roof of their mouth ¶. ¶ Chap.

What liberality! what a promptitude in beneficence!

Because the ear heard, therefore it blessed me;  
The eye also saw, therefore it bare testimony for me.  
That I delivered the poor who cried,  
The orphan also, and him who had no helper.  
The blessing of him who was ready to perish came upon me,

And I caused the heart of the widow to sing for joy ¶. ¶ Chap.

What sanctity, what integrity in a judicial capacity!

I put on righteousness, and it clothed me like a robe;  
My justice also was a diadem.  
I was a father to the poor,  
And the controversy which I knew not, I searched it out.

Then brake I the grinders of the oppressor,  
And I plucked the prey out of his teeth ¶.

But what can be more engaging than the purity of his devotion, and his reverence for the Supreme Being, founded upon the best and most philosophical principles? Besides that through the whole there runs a strain of the most amiable tenderness and humanity:

For what is the portion which God distributeth from above,  
And the inheritance of the Almighty from on high?  
Is it not destruction to the wicked,  
And banishment from their country to the doers of iniquity?

Doth he not see my ways?  
And numbereth he not all my steps?  
If I should despise the cause of my servant,  
Or my maid, when they had a controversy with me,  
What then should I do when God ariseth,  
And when he visiteth, what answer could I make him?  
Did not he who formed me in the belly form him,  
And did not one fashion us in the womb ¶?

The three friends are exactly such characters as the nature of the poem required. They are severe, irritable, malignant censurers, readily and with apparent satisfaction deviating from the purpose of consolation into of his three reproof and contumely. Even from the very first they manifest this evil propensity, and indicate what is to be expected from them. The first of them, indeed, in the opening of his harangue, assumes an air of candour:

Wouldst thou take it unkindly that one should essay to speak to thee ¶?

Indignation

*Scripture.*

¶ Chap. xxvii. 2—7.

¶. ¶ Chap. xxix. 7—16.

¶. ¶ Chap. xxxix. 11—13.

¶ Chap. xxxix. 14—16.

¶ Chap. xxxi. 2—4.

34 Characters of his three friends.

¶ Chap. iv. 2.

See chap. 20.

33 s confidence and fervor.

Scripture. Indignation is, however, instantly predominant :

But a few words who can forbear ?

The second flames forth at once :

How long wilt thou trifle in this manner ?

How long shall the words of thy mouth be as a mighty wind || ?

¶ Chap. vii. 2.

But remark the third :

Shall not the master of words be answered ?

Or shall a man be acquitted for his fine speeches ?

Shall thy prevarications make men silent ?

Shalt thou even scoff, and there be no one to make thee ashamed \* ?

• Chap.

xi. 2, 3.

35

Of Elihu.

The lenity and moderation of Elihu serves as a beautiful contrast to the intemperance and asperity of the other three. He is pious, mild, and equitable; equally free from adulation and severity; and endued with singular wisdom, which he attributes entirely to the inspiration of God: and his modesty, moderation, and wisdom, are the more entitled to commendation when we consider his unripe youth. As the characters of his detractors were in all respects calculated to inflame the mind of Job, that of this arbitrator is admirably adapted to sooth and compose it: to this point the whole drift of the argument tends, and on this the very purport of it seems to depend.

Another circumstance deserving particular attention in a poem of this kind, is the sentiment; which must be agreeable to the subject, and embellished with proper expression. It is by Aristotle enumerated among the essentials of a dramatic poem; not indeed as peculiar to that species of poetry alone, but as common, and of the greatest importance, to all. Manners or character are essential only to that poetry in which living persons are introduced; and all such poems must afford an exact representation of human manners: but sentiment is essential to every poem, indeed to every composition whatever. It respects both persons and things. As far as it regards persons, it is particularly concerned in the delineation of the manners and passions: and those instances to which we have just been adverting are sentiments expressive of manners. Those which relate to the delineation of the passions, and to the description of other objects, yet remain unnoticed.

36  
Sentiments  
of the  
poem of  
Job.

The poem of Job abounds chiefly in the more vehement passions, grief and anger, indignation and violent contention. It is adapted in every respect to the incitement of terror; and, as the specimens already quoted will sufficiently prove, is universally animated with the true spirit of sublimity. It is however not wanting in the gentler affections. The following complaints, for instance, are replete with an affecting spirit of melancholy :

Man, the offspring of a woman,  
Is of few days, and full of inquietude ;  
He springeth up, and is cut off like a flower ;  
He fleeteth like a shadow, and doth not abide ;  
Upon such a creature dost thou open thine eyes ?  
And wilt thou bring even me into judgment with thee ?

Turn thy look from him, that he may have some respite,

Till he shall, like a hircling, have completed his day ||.

1. Chap. xiv. 1, 2, 3, 6.

The whole passage abounds with the most beautiful imagery, and is a most perfect specimen of the Elegiac. His grief afterwards becomes more fervent; but is at the same time soft and querimonious.

Scripture.

How long will ye vex my soul,

And tire me with vain harangues ?

These ten times have ye loaded me with reproaches,

Are ye not ashamed that ye are so obdurate against me ?

Pity me, O pity me, ye are my friends,

For the hand of God hath smitten me.

Why will you be my persecutors as well as God,

And therefore will ye not be satisfied with my flesh ¶ ? ¶ Chap. xiv. 2, 3.

The ardour and alacrity of the war-horse, and his eagerness for battle, is painted with a masterly hand : ¶ his subli- 37 mty.

For eagerness and fury he devoureth the very ground :

He believeth it not when he heareth the trumpet.

When the trumpet soundeth, he saith, ahah !

Yea he scenteth the battle from afar,

The thunder of the chieftains and their shouts ¶.

¶ Chap. xxxix. 24, 25.

The following sublime description of the creation is admirable :

Where wast thou when I laid the foundations of the earth ?

If thou knowest, declare.

Say, who fixed the proportions of it, for surely thou knowest ?

Or who stretched out the line upon it ?

Upon what were its foundations fixed ?

Or who laid the corner-stone thereof ?

When the morning-stars sung together,

And all the sons of God shouted for joy ;

When the sea was shut up with doors ;

When it burst forth as an infant that cometh out of the womb ;

When I placed the cloud for its robe,

And thick darkness for its swadling-band ;

When I fixed my boundary against it,

When I placed a bar and gates ;

When I said, Thus far shalt thou come, and not advance,

And here shall a stop be put to the pride of thy waves †. † Job xxxviii. 4-11.

Let it suffice to say, that the dignity of the style is answerable to that of the subject; its force and energy, to the greatness of those passions which it describes: and as this production excels all the other remains of the Hebrew poetry in economy and arrangement, so it yields to none in sublimity of style and in every grace and excellence of composition. Among the principal of these may be accounted the accurate and perfectly poetical conformation of the sentences, which is indeed generally most observable in the most ancient of the poetical compositions of the Hebrews. Here, however, as is natural and proper in a poem of so great length and sublimity, the writer's skill is displayed in the proper adjustment of the period, and in the accurate distribution of the members, rather than in the antithesis of words, or in any laboured adaptation of the parallelisms.

The word *Psalms* is a Greek term, and signifies *Songs*. The book of Psalms The Hebrews call it *Seper Tebellim*, that is, "the Book of Praises;" and in the Gospel it is styled the Book of Psalms. Great veneration has always been paid to this collection

38  
The book  
of Psalms  
ספר תהלים

Scripture collection of divine songs. The Christian church has from the beginning made them a principal part of her holy services; and in the primitive times it was almost a general rule that every bishop, priest, and religious person, should have the psalter by heart.

50, 60, 64, 69, 73, 75, 77, 80, 84, 86, 88, 89, 90, 92, 93, 94, 95, 99, 120, 121, 123, 130, 131, 132. Scripture.

Lastly, Those hymns of joy and thanksgiving, written upon the release from the Babylonish captivity, and at the building and dedication of the temple. These are, 122, 61, 63, 124, 23, 87, 85, 46, 47, 48, from 96 to 117 inclusive, 126, 133 to 137 inclusive, 149, 150, 146, 147, 148, 59, 65, 66, 67, 118, 125, 127, 128, 129, 138.—According to this distribution, only 45 are positively assigned to David.

Josephus, and most of the ancient writers, assert, that the Psalms were composed in numbers: little, however, respecting the nature and principles of the Hebrew versification is known.

There existed a certain kind of poetry among the Hebrews, principally intended, it should seem, for the assistance of the memory; in which, when there was little connection between the sentiments, a sort of order or method was preserved, by the initial letters of each line or stanza following the order of the alphabet. Of this there are several examples extant among the sacred poems (1); and in these examples the verses are so exactly marked and defined, that it is impossible to mistake them for prose; and particularly if we attentively consider the verses, and compare them with one another, since they are in general so regularly accommodated, that word answers to word, and almost syllable to syllable. This being the case, though an appeal can scarcely be made to the ear on this occasion, the eye itself will distinguish the poetic division and arrangement, and also that some labour and accuracy has been employed in adapting the words to the measure.

The Hebrew poetry has likewise another property altogether peculiar to metrical composition. It admits foreign words and certain particles, which seldom occur in prose composition, and thus forms a distinct poetical dialect. One or two of the peculiarities also of the Hebrew versification it may be proper to remark, which as they are very observable in those poems in which the verses are defined by the initial letters, may at least be reasonably conjectured of the rest. The first of these is, that the verses are very unequal in length; the shortest consisting of six or seven syllables; the longest extending to about twice that number: the same poem is, however, generally continued throughout in verses not very unequal to each other. It must also be observed, that the close of the verse generally falls where the members of the sentences are divided.

But although nothing certain can be defined concerning the metre of the particular verses, there is yet another artifice of poetry to be remarked of them when in a collective state, when several of them are taken together. In the Hebrew poetry, as is before remarked, there may be observed a certain conformation of the sentences; the nature of which is, that a complete sense is almost equally infused into every component part, and that every member constitutes an entire verse. So that as the poems divide themselves in a manner spontaneously into periods, for the most part equal; so the periods themselves are divided into verses, most commonly

Many learned fathers, and not a few of the moderns, have maintained that David was the author of them all. Several are of a different opinion, and insist that David wrote only 72 of them; and that those without titles are to be ascribed to the authors of the preceding psalms, whose names are affixed to them. Those who suppose that David alone was the author, contend, that in the New Testament, and in the language of the church universal, they are expressly called the *Psalms of David*. That David was the principal author of these hymns is universally acknowledged, and therefore the whole collection may properly enough go under his name; but that he wrote them all, is a palpable mistake. Nothing certain can be gathered from the titles of the psalms; for although unquestionably very ancient, yet authors are not agreed as to their authority, and they differ as much about their signification. The Hebrew doctors generally agree that the 92d psalm was composed by Adam; an opinion which for many reasons we are not inclined to adopt. There seems, however, to be no doubt but that some of them were written by Moses; that Solomon was the author of the 49th; and that others were occasioned by events long posterior to the flourishing era of the kingdom of Judah. The 137th particularly is one of those which mentions the captivity of Babylon.

The following arrangement of the Psalms, after a careful and judicious examination, has been adopted by Calmet.

1. Eight Psalms of which the date is uncertain, viz. 1, 4, 19, 81, 91, 110, 139, 145. The first of these was composed by David or Ezra, and was sung in the temple at the feast of trumpets held in the beginning of the year and at the feast of tabernacles. The 81st is attributed to Asaph, and 110th to David. The authors of the rest are unknown.

2. The Psalms composed by David during the persecution of Saul. These are seventeen, 11, 31, 34, 56, 16, 54, 52, 109, 17, 22, 35, 57, 58, 142, 140, 141, 7.

3. The Psalms composed by David at the beginning of his reign, and after the death of Saul. These are fifteen, 2, 9, 24, 63, 101, 29, 20, 21, 28, 39, 40, 41, 6, 51, 32, 33.

4. The Psalms written by David during the rebellion of Absalom are eight in number; 3, 4, 55, 62, 70, 71, 143, 144.

5. The Psalms written between the death of Absalom and the captivity, which are ten, 18, 30, 72, 45, 78, 82, 83, 76, 74, 79: of these David wrote only three; 18, 30, and 72.

6. The Psalms composed during the captivity, which amount to forty. These were chiefly composed by the descendants of Asaph and Korah: they are, 10, 12, 13, 14, 53, 15, 25, 26, 27, 28, 36, 37, 42, 43, 44, 49,

(1) Psalms xxv. xxxiv. xxxvii. cxi. cxii. cxix. cxlv. Prov. xxxi. from the 10th verse to the end. The whole of the Lamentations of Jeremiah except the last chapter.

Scripture. ly couplets, though frequently of greater length. This is chiefly observable in those passages which frequently occur in the Hebrew poetry, in which they treat one subject in many different ways, and dwell upon the same sentiment; when they express the same thing in different words, or different things in a similar form of words; when equals refer to equals, and opposites to opposites: and since this artifice of composition seldom fails to produce even in prose an agreeable and measured cadence—we can scarcely doubt that it must have imparted to their poetry, were we masters of the versification, an exquisite degree of beauty and grace.

41  
Peculiarities of it.

The elegant and ingenious Dr Lowth has with great acuteness examined the peculiarities of Hebrew poetry, and has arranged them under general divisions. The correspondence of one verse or line with another he calls *parallelism*. When a proposition is delivered, and a second is subjoined to it, equivalent or contrasted with it in sense, or similar to it in the form of grammatical construction, these he calls *parallel lines*; and the words or phrases answering one to another in the corresponding lines, *parallel terms*. Parallel lines he reduces to three sorts; parallels synonymous, parallels antithetic, and parallels synthetic. Of each of these we shall present a few examples.

First, of parallel lines synonymous, which correspond one to another by expressing the same sense in different but equivalent terms.

O-Jehovah, in-thy-strength the-king shall-rejoice;  
And-in-thy-salvation how-greatly shall-he-exult!  
The-desire-of-his-heart thou-hast-granted unto-him;  
And-the-request-of-his-lips thou-hast-not denied.  
Pſ. xxi. 1. 2.

Because I-called, and-ye-refused;  
I-stretched-out my-hand, and-no-one regarded;  
But-ye-have-defeated all my-counsel;  
And-would-not incline to-my-reproof;  
I also will-laugh at-your-calamity;  
I-will-mock, when-what-you-feared cometh;  
When-what-you-feared cometh like-a devastation;  
And-your-calamity advanceth like-a tempest;  
When distress-and-anguish come upon-you:  
Then shall they-call-upon-me, but-I-will-not answer;  
They-shall-see-me-early, but-they-shall-not find-me:  
Because they-hated knowledge;  
And-did-not choose the-fear-of-Jehovah;  
Did-not incline to-my-counsel;  
Contemptuously-rejected all my-reproof;  
Therefore-shall-they-eat-of-the-fruit-of-their-ways;  
And-shall be-fatiated with-their-own-devices.  
For the-defection-of-the-simple shall-slay-them;  
And-the-security-of-fools shall-destroy-them.

Prov. i. 24—32.

Seek-ye Jehovah, while-he-may-be-found;  
Call-ye-upon-him, while-he-is near:  
Let-the-wicked forsake his-way;  
And-the-unrighteous man his-thoughts:  
And-let-him-return to Jehovah, and-he-will-compassionate-him;  
And unto our-God, for he-aboundeth in-forgiveness (κ).

Isaiah lv. 6. 7.

These synonymous parallels sometimes consist of two,

of three, or more synonymous terms. Sometimes they are formed by a repetition of part of the first sentence:

As,  
What shall I do unto thee, O Ephraim!  
What shall I do unto thee, O Judah!  
For your goodness is as the morning cloud,  
And as the early dew it passeth away.

Hosea vi. 4.

The following is a beautiful instance of a parallel triplet, when three lines correspond and form a kind of stanza, of which two only are synonymous.

That day, let it become darkness;  
Let not God from above inquire after it;  
Nor let the shining light radiate upon it.  
That night, let utter darkness seize it;  
Let it not be united with the days of the year;  
Let it not come into the number of the months.  
Let the stars of its twilight be darkened:  
Let it look for light, and may there be none;  
And let it not behold the eyelids of the morning.

Job iii. 4, 6, 9.

The second sort of parallels are the antithetic, when two lines correspond with one another by an opposition of terms and sentiments; when the second is contrasted with the first, sometimes in expressions, sometimes in sense only. Accordingly the degrees of antithesis are various: from an exact contraposition of word to word through the whole sentence, down to a general disparity, with something of a contrariety, in the two propositions. Thus in the following examples:

A wife son rejoiceth his father;  
But a foolish son is the grief of his mother.

Prov. x. 1.

Where every word hath its opposite: for the terms *father* and *mother* are, as the logicians say, relatively opposite.

The memory of the just is a blessing;  
But the name of the wicked shall rot.

Prov. x. 7.

Here there are only two antithetic terms: for *memory* and *name* are synonyms.

There is that scattereth, and still increaseth;  
And that is unreasonably sparing, yet groweth poor.

Prov. xi. 24.

Here there is a kind of double antithesis; one between the two lines themselves; and likewise a subordinate opposition between the two parts of each.

These in chariots, and those in horses;  
But we in the name of Jehovah our God will be strong.  
They are bowed down, and fallen;  
But we are risen, and maintain ourselves firm.

Pſ. xx. 7, 8.

For his wrath is but for a moment, his favour for life;  
Sorrow may lodge for the evening, but in the morning gladness.

Pſ. xxx. 5.

Yet a little while, and the wicked shall be no more;  
Thou shalt look at his place, and he shall not be found:  
But the meek shall inherit the land;  
And delight themselves in abundant prosperity.

Pſ. xxxvii. 10, 11.

In



In the last example the opposition lies between the two parts of a stanza of four lines, the latter distich being opposed to the former. So likewise the following :

For the mountains shall be removed ;  
And the hills shall be overthrown ;  
But my kindness from thee shall not be removed ;  
And the covenant of my peace shall not be overthrown.  
Isaiah liv. 10.

Isaiah by means of the antithetic parallelism, without departing from his usual dignity, adds greatly to the sweetness of his composition in the following instances :

In a little anger have I forsaken thee ;  
But with great mercies will I receive thee again ;  
In a short wrath I hid my face for a moment from thee ;  
But with everlasting kindness will I have mercy on thee.  
Isaiah liv. 7, 8.  
Behold my servants shall eat, but ye shall be famished ;  
Behold my servants shall drink, but ye shall be thirsty ;  
Behold my servants shall rejoice, but ye shall be con-  
founded ;  
Behold my servants shall sing aloud, for gladness of  
heart,  
But ye shall cry aloud for grief of heart ;  
And in the anguish of a broken spirit shall ye howl.  
Isaiah lxxv. 13, 14.

Frequently one line or member contains two senti-  
ments :

The nations raged ; the kingdoms were moved ;  
He uttered a voice ; the earth was dissolved ;  
Be still, and know that I am God :  
I will be exalted in the nations, I will be exalted in the  
earth. Pf. xlvi. 6. 10.  
When thou passest through waters I am with thee ;  
And through rivers, they shall not overwhelm thee :  
When thou walkest in the fire thou shalt not be scorched ;  
And the flame shall not cleave to thee.  
Isaiah xliii. 2.

The third sort of parallels is the synthetic or con-  
structive : where the parallelism consists only in the sim-  
ilar form of construction ; in which word does not  
answer to word, and sentence to sentence, as equivalent  
or opposite ; but there is a correspondence and equality  
between different propositions, in respect of the shape  
and turn of the whole sentence, and of the constructive  
parts ; such as noun answering to noun, verb to verb,  
member to member, negative to negative, interrogative  
to interrogative.

Lo ! he withholdeth the waters, and they are dried up :  
And he sendeth them forth, and they overturn the earth.  
With him is strength, and perfect existence ;  
The deceived, and the deceiver, are his.

Job xii. 13—16.  
Is such then the fast which I choose ?  
That a man should afflict his soul for a day ?  
Is it, that he should bow down his head like a bulrush,  
And spread sackcloth and ashes for his couch ?  
Shall this be called a fast,  
And a day acceptable to Jehovah ?  
Is not this the fast that I choose ?  
To dissolve the bands of wickedness ;  
To loosen the oppressive burthens ;  
To deliver those that are crushed by violence ;

VOL. XVII. Part I.

And that ye should break asunder every yoke ?  
Is it not to distribute thy bread to the hungry ;  
And to bring the wandering poor into thy house ?  
When thou feest the naked, that thou clothe him ;  
And that thou hide not thyself from thine own flesh ?  
Then shall thy light break forth like the morning ;  
And thy wounds shall speedily be healed over :  
And thy righteousness shall go before thee ;  
And the glory of Jehovah shall bring up thy rear."  
Isaiah lviii. 5—8.

We shall produce another example of this species of  
parallelism from Pf. xix. 8—11. from Dr Lowth :

The law of Jehovah is perfect, restoring the soul ;  
The testimony of Jehovah is sure, making wise the  
simple :  
The precepts of Jehovah are right, rejoicing the heart ;  
The commandment of Jehovah is clear, enlightening  
the eyes :  
The fear of Jehovah is pure, enduring for ever ;  
The judgments of Jehovah are truth, they are just alto-  
gether.  
More desirable than gold, or than much fine gold ;  
And sweeter than honey, or the dropping of honey-  
combs.

Synonymous parallels have the appearance of art and  
concinnity, and a studied elegance ; they prevail chiefly  
in shorter poems ; in many of the Psalms ; in Balaam's  
prophecies ; frequently in those of Isaiah, which are  
most of them distinct poems of no great length. The  
antithetic parallelism gives an acuteness and force to  
adages and moral sentences ; and therefore abounds in  
Solomon's Proverbs, and elsewhere is not often to be  
met with. The poem of Job, being on a large plan,  
and in a high tragic style, though very exact in the di-  
vision of the lines and in the parallelism, and affording  
many fine examples of the synonymous kind, yet con-  
sists chiefly of the constructive. A happy mixture of  
the several sorts gives an agreeable variety : and they  
serve mutually to recommend and set off one another.

The reader will perceive that we have derived every  
thing we have said relating to Hebrew poetry from the  
elegant Lectures of Dr Lowth, which are beautifully  
translated by Mr Gregory, a distinguished author as  
well as translator.

The book of Proverbs has always been accounted ca-<sup>42</sup> The book  
nonical. The Hebrew title of it is *Mishle*\*, which sig-<sup>of Pro-</sup>  
nifies " similitudes." It has always been ascribed to So-<sup>verbs.</sup>  
lomon, whose name it bears, though some have doubted  
whether he really was the author of every one of the  
maxims which it contains. Those in chap. xxx. are in-  
deed called *the words of Agur* the son of *Jahob*, and  
the title of the 31st or last chapter is *the words of*  
*King Lemuel*. It seems certain that the collection call-  
ed the *Proverbs of Solomon* was digested in the order in  
which we now have it by different hands ; but it is  
not, therefore, to be concluded that they are not the  
work of Solomon. Several persons might have made  
collections of them : Hezekiah, among others, as men-  
tioned chapter xxv. Agur and Ezra might have done  
the same. From these several collections the work was  
compiled which we have now in our hands.

The book of Proverbs may be considered under five  
divisions. 1. The first, which is a kind of preface, ex-  
tends

Scripture. tends to the 10th chapter. This contains general cautions and exhortations for a teacher to his pupil, expressed in elegant language, duly connected in its parts, illustrated with beautiful description, and well contrived to engage and interest the attention.

2. The second part extends from the beginning of chap. x. to chap. xxii. 17. and consists of what may strictly and properly be called proverbs, viz. unconnected sentences, expressed with much neatness and simplicity. They are truly, to use the language of their sage author, "apples of gold in pictures of silver."

3. In the third part, which is included between chapter xxii. 16. and chapter xxv. the tutor drops the sententious style, addresses his pupil as present, and delivers his advices in a connected manner.

4. The proverbs which are included between chapters xxv. and chapter xxx. are supposed to have been selected by the men of Hezekiah from some larger collection of Solomon, that is, by the prophets whom he employed to restore the service and writings of the church. Some of the proverbs which Solomon had introduced into the former part of the book are here repeated.

5. The prudent admonitions which Agur delivered to his pupils Ithiel and Ucal are contained in the 30th chapter, and in the 31st are recorded the precepts which the mother of Lemuel delivered to her son.

Several references are evidently made to the book of

\* Rom. xii. Proverbs by the writers of the New Testament \*.

16, 20.  
1 Pet. iv.  
8. v. 5.  
James iv.  
6.

The Proverbs of Solomon afford specimens of the didactic poetry of the Hebrews. They abound with antithetic parallels; for this form is peculiarly adapted to that kind of writing, to adages, aphorisms, and detached sentences. Indeed, the elegance, acuteness, and force of a great number of Solomon's wise sayings arise in a great measure from the antithetic form, the opposition of diction and sentiment. Take the following examples:

The blows of a friend are faithful;  
But the kisses of an enemy are treacherous.  
The cloyed will trample upon a honeycomb;  
But to the hungry every bitter thing is sweet.  
There is who maketh himself rich, and wanteth all things;  
Who maketh himself poor, yet hath much wealth.  
The rich man is wise in his own eyes,  
But the poor man that hath discernment to trace him out will despise him\*.

\* Proverbs  
xxvii. 6, 7.  
xxiii. 7.  
xxviii. 11.  
47  
Ecclesiastes.

The Hebrew title of the book which we call Ecclesiastes is *Keleth*, that is, the *Gatherer* or *Collector*; and it is so called, either because the work itself is a collection of maxims, or because it was delivered to an assembly gathered together to hear them. The Greek term *Ecclesiastes* is of the same import, signifying one who gathers together a congregation, or who discourses or preaches to an assembly convened. That Solomon was the author of this book is beyond all doubt; the beautiful description of the phenomena in the natural world, and their causes; of the circulation of the blood, as some think\*, and the economy of the human frame, shews it to be the work of a philosopher. At what period of his life it was written may be easily found out. The affecting account of the infirmities of old age which it contains, is a strong indication that the author knew by experience what they were; and his

\* See Horsey's Sermon before the Humane Society.

complete conviction of the vanity of all earthly enjoyments proves it to have been the work of a penitent. Some passages in it seem, indeed, to express an Epicurean notion of Providence. But it is to be observed, that the author, in an academic way, disputes on both sides of the question; and at last concludes properly, that to "fear God and keep his commandments is the whole duty of man; for God (says he) will bring every work to judgment, and every secret thing, whether it be good, or whether it be evil."

The general tenor and style of Ecclesiastes is very different from the book of Proverbs, though there are many detached sentiments and proverbs interspersed. For the whole work is uniform, and confined to one subject, namely, the vanity of the world exemplified by the experience of Solomon, who is introduced in the character of a person investigating a very difficult question, examining the arguments on either side, and at length disengaging himself from an anxious and doubtful disputation. It would be very difficult to distinguish the parts and arrangement of this production; the order of the subject, and the connection of the arguments, are involved in so much obscurity, that scarcely any two commentators have agreed concerning the plan of the work, and the accurate division of it into parts or sections. The truth is, the laws of methodical composition and arrangement were neither known by the Hebrews nor regarded in their didactic writings. They uniformly retained the old sententious manner, nor did they submit to method, even where the occasion appeared to demand it. The style of this work is, however, singular; the language is generally low; it is frequently loose, unconnected, approaching to the incorrectness of conversation; and possesses very little of the poetical character, even in the composition and structure of the periods: which peculiarity may possibly be accounted for from the nature of the subject. Contrary to the opinion of the Rabbies, Ecclesiastes has been classed among the poetical books; though, if their authority and opinions were of any weight or importance, they might perhaps on this occasion deserve some attention.

Lowth's Hebrew Poetry.

The Song of Solomon, in the opinion of Dr Lowth, <sup>44</sup> Song of Solomon. is an *epithalamium* or nuptial dialogue, in which the principal characters are Solomon, his bride, and a chorus of virgins. Some are of opinion that it is to be taken altogether in a literal sense; but the generality of Jews and Christians have esteemed it wholly allegorical, expressing the union of Jesus Christ and the church. Dr Lowth has supported the common opinion, by showing that the sacred writers often apply metaphors to God and his people derived from the conjugal state. Our Saviour is styled a *bridegroom* by John the Baptist (John iii.), and is represented in the same character in the parable of the ten virgins. Michaelis, on the other hand, rejects the argument drawn from analogy as inconclusive, and the opinion of Jews and Christians as of no greater authority than the opinion of the moderns.

The second of those great divisions under which the Jews classed the books of the Old Testament was that of the Prophets, which formerly comprehended 16 books.

The Prophets were 16 in number: Isaiah, Jeremiah, Ezekiel, Daniel, Hosea, Joel, Amos, Obadiah, Jonah, Micah, Nahum, Habakkuk, Zephaniah, Haggai, Zechariah,

Scripture. *chariah, Malachi.* The four first are called the *greater* prophets; the other twelve are denominated the *minor* prophets.

<sup>45</sup> Writings of the prophets. The writings of the Prophets are to Christians the most interesting part of the Old Testament; for they afford one of the most powerful arguments for the divine origin of the Christian religion. If we could only prove, therefore, that these prophecies were uttered a single century before the events took place to which they relate, their claim to inspiration would be unquestionable. But we can prove that the interval between their enunciation and accomplishment extended much farther, even to 500 and 1000 years, and in some cases much more.

<sup>46</sup> Their authenticity. The books of the prophets are mentioned by Josephus, and therefore surely existed in his time; they are also quoted by our Saviour, under the general denomination of the *Prophets*. We are informed by Tacitus and Suetonius, that about 60 years before the birth of our Saviour, there was an universal expectation in the east of a great personage who was to arise; and the source of this expectation is traced by the same writers to the sacred books of the Jews. They existed also in the time of Antiochus Epiphanes, A. C. 166; for when that tyrant prohibited the reading of the law, the books of the Prophets were substituted in its place, and were continued as a part of the daily service after the interdiction against the law of Moses was taken off. We formerly remarked, that references are made by the author of *Ecclesiasticus*, A. C. 200, to the writings of Isaiah, Jeremiah, and Ezekiel, and that he mentions the 12 Prophets. We can ascend still higher, and assert from the language of the Prophets, that all their writings must have been composed before the Babylonish captivity, or within a century after it; for all of them, except Daniel and Ezra, are composed in Hebrew, and even in them long passages are found in that language: but it is a well known fact, that all the books written by Jews about two centuries after that era are composed in the Syriac, or Chaldaic, or Greek language. "Let any man (says Michaelis) compare what was written in Hebrew after the Babylonish exile, and, I apprehend, he will perceive no less evident marks of decay than in the Latin language." Even in the time of Ezra, the common people, from their long residence in Babylonia, had forgotten the Hebrew, and it was necessary for the learned to interpret the law of Moses to them. We can therefore ascertain with very considerable precision the date of the prophetic writings; which indeed is the only important point to be determined: For whether we can discover the authors or not, if we can only establish their ancient date, we shall be fully entitled to draw this conclusion, that the predictions of the Prophets are inspired.

<sup>47</sup> And in prediction. Much has been written to explain the nature of inspiration, and to show by what methods God imparted to the prophets that divine knowledge which they were commanded to publish to their countrymen. Attempts have been made to disclose the nature of dreams and visions, and to describe the ecstasy or rapture to which the prophets were supposed to be raised while they uttered their predictions. Not to mention the degrading and indecent comparison which this last circumstance suggests, we shall only inform those who expect here an explanation of the prophetic dreams and

visions, that *we shall not attempt to be wiser above what is written.* The manner in which the allwise and unseen God may think proper to operate upon the minds of his creatures, we might expect *à priori* to be mysterious and inexplicable. Indeed such an inquiry, though it were successful, would only gratify curiosity, without being in the least degree conducive to useful knowledge.

The business of philosophy is not to inquire how almighty power produced the frame of nature, and bestowed upon it that beauty and grandeur which is everywhere conspicuous, but to discover those marks of intelligence and design, and the various purposes to which the works of nature are subservient. Philosophy has of late been directed to theology and the study of the Scriptures with the happiest effects; but it is not permitted to enter within the veil which the Lord of Nature has thrown over his councils. Its province, which is sufficiently extensive, is to examine the language of the prophecies, and to discover their application.

The character of the prophetic style varies according to the genius, the education, and mode of living of the respective authors; but there are some peculiarities which run through the whole prophetic books. A plain unadorned style would not have suited those men who were to wrap the mysteries of futurity in a veil, which was not to be penetrated till the events themselves should be accomplished. For it was never the intention of prophecy to unfold futurity to our view, as many of the rash interpreters of prophecy fondly imagine; for this would be inconsistent with the free agency of man. It was therefore agreeable to the wisdom of God that prophecies should be couched in a language which would render them unintelligible till the period of their completion; yet such a language as is distinct, regular, and would be easily explained when the events themselves should have taken place. This is precisely the character of the prophetic language. It is partly derived from the hieroglyphical symbols of Egypt, to which the Israelites during their servitude were familiarized, and partly from that analogy which subsists between natural objects and those which are moral and political.

The prophets borrowed their imagery from the most splendid and sublime natural objects, from the host of heaven, from seas and mountains, from storms and earthquakes, and from the most striking revolutions in nature. The *celestial bodies* they used as symbols to express thrones and dignities, and those who enjoyed them. *Earth* was the symbol for men of low estate. *Hades* represents the miserable. *Ascending to heaven*, and *descending to earth*, are phrases which express rising to power, or falling from it. *Great earthquakes*, the *shaking of heaven and earth*, denote the commotions and overthrow of kingdoms. The *sun* represents the whole race of kings shining with regal power and glory. The *moon* is the symbol of the common people. The *stars* are subordinate princes and great men. *Light* denotes glory, truth, or knowledge. *Darkness* expresses obscurity of condition, error, and ignorance. The *darkening of the sun*, the *turning of the moon into blood*, and the *falling of the stars*, signify the destruction or desolation of a kingdom. *New moons*, the returning of a nation from a dispersed state. *Conflagration of the earth*, is the sym-

Scripture. bol for destruction by war. The *ascent of smoke* from any thing burning for ever, denotes the continuance of a people under slavery. *Riding in the clouds*, signifies reigning over many subjects. *Tempestuous winds*, or *motion of the clouds*, denote wars. *Thunder* denotes the noise of multitudes. *Fountains of waters* express cities. *Mountains and islands*, cities with the territories belonging to them. *Houses and ships* stand for families, assemblies, and towns. A *forest* is put for a kingdom. A *wilderness* for a nation much diminished in its numbers.

50  
And fr. m hieroglyphics.  
Animals, as a *lion, bear, leopard, goat*, are put for kingdoms or political communities corresponding to their respective characters. When a man or beast is put for a kingdom, the head represents those who govern; the *tail* those who are governed; the *horns* denote the number of military powers or states that rise from the head. *Seeing* signifies understanding; *eyes* men of understanding; the *mouth* denotes a lawgiver; the *arm of a man* is put for power, or for the people by whose strength his power is exercised; *feet* represent the lowest of the people.

Such is the precision and regularity of the prophetic language, which we learn to interpret by comparing prophecies which are accomplished with the facts to which they correspond. So far is the study of it carried already, that a dictionary has been composed to explain it; and it is probable, that in a short time it may be so fully understood, that we shall find little difficulty in explaining any prophecy. But let us not from this expect, that the prophecies will enable us to penetrate the dark clouds of futurity: No! The difficulty of applying prophecies to their corresponding events, before completion, will still remain unsurmountable. Those men, therefore, however pious and well-meaning they may be, who attempt to explain and apply prophecies which are not yet accomplished, and who delude the credulous multitude by their own romantic conjectures, cannot be acquitted of rashness and presumption.

51  
Is also poetical.  
The predictions of the prophets, according to the opinion of Dr Lowth, are written in a poetic style. They possess indeed all the characteristics of Hebrew poetry, with the single exception, that none of them are alphabetical or acrostic, which is an artificial ar-

rangement utterly repugnant to the nature of pro-Scripture. pechy.

The other arguments, however, ought to be particularly adverted to upon this subject: the poetic dialect, for instance, the diction so totally different from the language of common life, and other similar circumstances, which an attentive reader will easily discover, but which cannot be explained by a few examples; for circumstances which, taken separately, appear but of small account, are in a united view frequently of the greatest importance. To these we may add the artificial conformation of the sentences; which are a necessary concomitant of metrical composition, the only one indeed which is now apparent, as it has always appeared to us.

The order in which the books of the minor prophets are placed is not the same in the Septuagint as in the Hebrew\*. According to the latter, they stand as in our translation; but in the Greek, the series is altered as to the six first, to the following arrangement: Hosea, Amos, Micah, Joel, Obadiah, Jonah. This change, however, is of no consequence, since neither in the original, nor in the Septuagint, are they placed with exact regard to the time in which their sacred authors respectively flourished.

The order in which they should stand, if chronologically arranged, is by Blair and others supposed to be as follows: Jonah, Amos, Hosea, Micah, Nahum, Joel, Zephaniah, Habbakuk, Obadiah, Haggai, Zechariah, Malachi. And this order will be found to be generally consistent with the periods to which the Prophets will be respectively assigned in the following pages, except in the instance of Joel, who probably flourished rather earlier than he is placed by these chronologers. The precise period of this prophet, however, cannot be ascertained; and some disputes might be maintained concerning the priority of others also, when they were nearly contemporaries, as Amos and Hosea; and when the first prophecies of a later prophet were delivered at the same time with, or previous to, those of a prophet who was called earlier to the sacred office. The following scheme, however, in which also the greater prophets will be introduced, may enable the reader more accurately to comprehend the actual and relative periods in which they severally prophesied.

The PROPHETS in their supposed Order of Time, arranged according to Blair's Tables \* with but little Variation.

	Before Christ.	Kings of Judah.	Kings of Israel.
Jonah,	Between 856 and 784.		Jehu, and Jehoahaz, according to Lloyd; but Joash and Jeroboam the Second according to Blair.
Amos,	Between 810 and 785.	Uzziah, ch. i. 1.	Jeroboam the Second, chap. i. 1.
Hosea,	Between 810 and 725.	Uzziah, Jotham, Ahaz, the third year of Hczekiah.	Jeroboam the Second, chap. i. 1.

\* Bishop Newcome's Version of Minor Prophets, Preface, p. 43.

	Before Christ.	Kings of Judah.	Kings of Israel.
Isaiah,	Between 810 and 698.	Uzziah, Jotham, Ahaz, and Hezekiah, chap. i. 1. and perhaps Manasseh.	
Joel,	Between 810 and 660, or later.	Uzziah, or possibly Manasseh.	
Micah,	Between 758 and 699.	Jotham, Ahaz, and Hezekiah, chap. i. 1.	Pekah and Hofea.
Nahum,	Between 720 and 698.	Probably towards the close of Hezekiah's reign.	
Zephaniah,	Between 640 and 609.	In the reign of Josiah, chap. i. 1.	
Jeremiah,	Between 628 and 586.	In the thirteenth year of Josiah.	
Habakkuk,	Between 612 and 598.	Probably in the reign of Jehoiakim.	
Daniel,	Between 606 and 534.	During all the Captivity.	
Obadiah,	Between 588 and 583.	Between the taking of Jerusalem by Nebuchadnezzar and the destruction of the Edomites by him.	
Ezekiel,	Between 595 and 536.	During part of the Captivity.	
Haggai,	About 520 to 518.	After the return from Babylon.	
Zechariah,	From 520 to 518, or longer.		
Malachi,	Between 436 and 397.		

<sup>52</sup> Isaiah. Isaiah is supposed to have entered upon the prophetic office in the last year of the reign of Uzziah, about 758 years before Christ: and it is certain that he lived to the 15th or 16th years of Hezekiah. This makes the least possible term of the duration of his prophetic office about 48 years. The Jews have a tradition that Isaiah was put to death in the reign of Manasseh, being sawn asunder with a wooden saw by the command of that tyrant: but when we recollect how much the traditions of the Jews were condemned by our Saviour, we will not be disposed to give them much credit. The time of the delivery of some of his prophecies is either expressly marked, or sufficiently clear from the history to which they relate. The date of a few others may with some probability be deduced from internal marks; from expressions, descriptions, and circumstances interwoven.

<sup>53</sup> character. Isaiah, the first of the prophets both in order and his style, dignity, abounds in such transcendent excellencies, that

he may be properly said to afford the most perfect model of the prophetic poetry. He is at once elegant and sublime, forcible and ornamented; he unites energy with copiousness, and dignity with variety. In his sentiments there is uncommon elevation and majesty; in his imagery the utmost propriety, elegance, dignity, and diversity; in his language uncommon beauty and energy; and, notwithstanding the obscurity of his subjects, a surprising degree of clearness and simplicity. To these we may add, there is such sweetness in the poetical composition of his sentences, whether it proceed from art or genius, that if the Hebrew poetry at present is possessed of any remains of its native grace and harmony, we shall chiefly find them in the writings of Isaiah: so that the saying of Ezekiel may most justly be applied to this prophet:

Thou art the confirmed exemplar of measures,  
Full of wisdom, and perfect in beauty\*.

\* Ezekiel  
xxviii. 12.

Isaiah

Scripture Isaiah greatly excels too in all the graces of method, order, connection, and arrangement: though in asserting this we must not forget the nature of the prophetic impulse, which bears away the mind with irresistible violence, and frequently in rapid transitions from near to remote objects, from human to divine; we must also be careful in remarking the limits of particular predictions, since, as they are now extant, they are often improperly connected, without any marks of discrimination; which injudicious arrangement, on some occasions, creates almost insuperable difficulties. It is, in fact, a body or collection of different prophecies, nearly allied to each other as to the subject, which, for that reason, having a sort of connection, are not to be separated but with the utmost difficulty. The general subject is the restoration of the church. Its deliverance from captivity; the destruction of idolatry; the vindication of the divine power and truth; the consolation of the Israelites, the divine invitation which is extended to them, their incredulity, impiety, and rejection; the calling in of the Gentiles; the restoration of the chosen people; the glory and felicity of the church in its perfect state; and the ultimate destruction of the wicked—are all set forth with a sufficient respect to order and method. If we read these passages with attention, and duly regard the nature and genius of the mystical allegory, at the same time remembering that all these points have been frequently touched upon in other prophecies promulgated at different times, we shall neither find any irregularity in the arrangement of the whole, nor any want of order and connection as to matter or sentiment in the different parts. Dr Lowth esteems the whole book of Isaiah to be poetical, a few passages excepted, which, if brought together, would not at most exceed the bulk of five or six chapters.

54  
Unparalleled  
sublimity of the  
14th chapter.

The 14th chapter of Isaiah is one of the most sublime odes in the Scripture, and contains one of the noblest personifications to be found in the records of poetry.

The prophet, after predicting the liberation of the Jews from their severe captivity in Babylon, and their restoration to their own country, introduces them as reciting a kind of triumphal song upon the fall of the Babylonish monarch, replete with imagery, and with the most elegant and animated personifications. A sudden exclamation, expressive of their joy and admiration on the unexpected revolution in their affairs, and the destruction of their tyrants, forms the exordium of the poem. The earth itself triumphs with the inhabitants thereof; the fir-trees and the cedars of Lebanon (under which images the parabolic style frequently delineates the kings and princes of the Gentiles) exult with joy, and persecute with contemptuous reproaches the humbled power of a ferocious enemy:

The whole earth is at rest, is quiet; they burst forth into a joyful shout:

Even the fir-trees rejoice over thee, the cedars of Lebanon:

Since thou art fallen, no feller hath come up against us.

This is followed by a bold and animated personification of Hades, or the infernal regions:

Hades from beneath is moved because of thee, to meet thee at thy coming:

He rouseth for thee the mighty dead, all the great chiefs of the earth;

He maketh to rise up from their thrones all the kings of the nations.

Hades excites his inhabitants, the ghosts of princes, and the departed spirits of kings: they rise immediately from their seats, and proceed to meet the monarch of Babylon; they insult and deride him, and comfort themselves with the view of his calamity:

Art thou, even thou too, become weak as we? art thou made like unto us?

Is then thy pride brought down to the grave; the found of thy 'prightly instruments?

Is the vermin become thy couch, and the earthworm thy covering?

Again, the Jewish people are the speakers, in an exclamation after the manner of a funeral lamentation, which indeed the whole form of this composition exactly imitates. The remarkable fall of this powerful monarch is thus beautifully illustrated:

How art thou fallen from heaven, O Lucifer, son of the morning!

Art cut down from earth, thou that didst subdue the nations!

Yet thou didst say in thy heart, I will ascend the heavens;

Above the stars of God I will exalt my throne;

And I will sit upon the mount of the divine presence, on the sides of the north:

I will ascend above the heights of the clouds; I will be like the most High.

But thou shalt be brought down to the grave, to the sides of the pit.

He himself is at length brought upon the stage, boasting in the most pompous terms of his own power; which furnishes the poet with an excellent opportunity of displaying the unparalleled misery of his downfall. Some persons are introduced, who find the dead carcass of the king of Babylon cast out and exposed; they attentively contemplate it, and at last scarcely know it to be his:

Is this the man that made the earth to tremble, that shook the kingdoms?

That made the world like a desert, that destroyed the cities?

That never dismissed his captives to their own home?

All the kings of the nations, all of them,

Lie down in glory, each in his own sepulchre:

But thou art cast out of the grave, as the tree abominated;

Clothed with the slain, with the pierced by the sword, With them that go down to the stones of the pit; as a trodden carcass.

Thou shalt not be joined unto them in burial;

Because thou hast destroyed thy country, thou hast slain thy people:

The seed of evil doers shall never be renowned.

They reproach him with being denied the common rites of sepulture, on account of the cruelty and atrocity of his conduct; they execrate his name, his offspring, and their posterity. A solemn address, as of the Deity himself,

Scripture. self, closes the scene, and he denounces against the king of Babylon, his posterity, and even against the city which was the seat of their cruelty, perpetual destruction, and confirms the immutability of his own counsels by the solemnity of an oath.

What has occasioned this transposition cannot now be determined. It is generally maintained, that if we consult their dates, they ought to be thus placed:

In the reign of Josiah the first 12 chapters.

In the reign of Jehoiakim, chapters xiii. xx. xxi. v. 11, 14.; xxii. xxiii, xxv. xxvi. xxxv. xxxvi. xlv.—xlix. 1—33.

In the reign of Zedekiah, chap. xxi. 1—16. xxiv. xxvii. xxxiv. xxxvii. xxxix. xlix. 34—39. l. and li.

Under the government of Gedaliah, chapters xl. xlv. The prophecies which related to the Gentiles were contained in the 46th and five following chapters, being placed at the end, as in some measure unconnected with the rest. But in some copies of the Septuagint these six chapters follow immediately after the 13th verse of the 25th chapter.

How forcible is this imagery, how diversified, how sublime! how elevated the diction, the figures, the sentiments!—The Jewish nation, the cedars of Lebanon, the ghosts of departed kings, the Babylonish monarch, the travellers who find his corpse, and last of all Jehovah himself, are the characters which support this beautiful lyric drama. One continued action is kept up, or rather a series of interesting actions are connected together in an incomparable whole. This, indeed, is the principal and distinguished excellence of the sublimer ode, and is displayed in its utmost perfection in this poem of Isaiah, which may be considered as one of the most ancient, and certainly the most finished, specimen of that species of composition which has been transmitted to us. The personifications here are frequent, yet not confused; bold, yet not improbable: a free, elevated, and truly divine spirit, pervades the whole; nor is there any thing wanting in this ode to defeat its claim to the character of perfect beauty and sublimity. “If (says Dr Lowth) I may be indulged in the free declaration of my own sentiments on this occasion, I do not know a single instance in the whole compass of Greek and Roman poetry, which, in every excellence of composition, can be said to equal, or even approach it.”

Jeremiah was called to the prophetic office in the 13th year of the reign of Josiah the son of Amon, A. M. 3376, A. C. 628, and continued to prophecy upwards of 40 years, during the reigns of the degenerate princes of Judah, to whom he boldly threatened those marks of the divine vengeance which their rebellious conduct drew on themselves and their country. After the destruction of Jerusalem by the Chaldeans, he was suffered by Nebuchadnezzar to remain in the desolate land of Judea to lament the calamities of his infatuated countrymen. He was afterwards, as he himself informs us, carried with his disciple Baruch into Egypt, by Jehanah the son of Kareah.

It appears from several passages that Jeremiah committed his prophecies to writing. In the 36th chapter we are informed, that the prophet was commanded to write upon a roll all the prophecies which he had uttered; and when the roll was destroyed by Jehoiakim the king, Jeremiah dictated the same prophecies to Baruch, who wrote them together with many additional circumstances. The works of Jeremiah extend to the last verse of the 51st chapter; in which we have these words, “Thus far are the words of Jeremiah.” The 52d chapter was therefore added by some other writer. It is, however, a very important supplement, as it illustrates the accomplishment of Jeremiah’s prophecies respecting the fate of Zedekiah.

The prophecies of Jeremiah are not arranged in the chronological order in which they were delivered.

Jeremiah, though deficient neither in elegance nor sublimity, must give place in both to Isaiah. Jerome seems to object against him a sort of rusticity of language, no vestige of which Dr Lowth was able to discover. His sentiments, it is true, are not always the most elevated, nor are his periods always neat and compact; but these are faults common to those writers whose principal aim is to excite the gentler affections, and to call forth the tear of sympathy or sorrow. This observation is very strongly exemplified in the Lamentations, where these are the prevailing passions; it is, however, frequently instanced in the prophecies of this author, and most of all in the beginning of the book (L), which is chiefly poetical. The middle of it is almost entirely historical. The latter part, again, consisting of the six last chapters, is altogether poetical (M); it contains several different predictions, which are distinctly marked; and in these the prophet approaches very near the sublimity of Isaiah. On the whole, however, not above half the book of Jeremiah is poetical.

The book of Lamentations, as we are informed in the title, was composed by Jeremiah. We shall present to our reader an account of this elegiac poem from the elegant pen of Dr Lowth.

The Lamentations of Jeremiah (for the title is properly and significantly plural) consist of a number of plaintive effusions, composed upon the plan of the funeral dirges, all upon the same subject, and uttered without connection as they rose in the mind, in a long course of separateanzas. These have afterwards been put together, and formed into a collection or correspondent whole. If any reader, however, should expect to find in them an artificial and methodical arrangement of the general subject, a regular disposition of the parts, a perfect connection and orderly succession in the matter, and with all this an uninterrupted series of elegance and correctness, he will really expect what was foreign to the prophet’s design. In the character of a mourner, he celebrates in plaintive strains the obsequies of his ruined country: whatever presented itself to his mind in the midst of desolation and misery, whatever struck him as particularly wretched and calamitous, whatever the instant sentiment of sorrow dictated, he pours forth:

12

(L) See the whole of chap. ix. chap. xiv. 17, &c. xx. 14—18.

(M) Chap. xlvii.—li. to ver. 59. Chap. liii. properly belongs to the Lamentations, to which it serves as an exordium.

*Scripture.* in a kind of spontaneous effusion. He frequently pauses, and, as it were, ruminates upon the same object; frequently varies and illustrates the same thought with different imagery, and a different choice of language; so that the whole bears rather the appearance of an accumulation of corresponding sentiments, than an accurate and connected series of different ideas, arranged in the form of a regular treatise. There is, however, no wild incoherency in the poem; the translations are easy and elegant.

58  
How divided.

The work is divided into five parts; in the first, second, and fourth chapters, the prophet addresses the people in his own person, or introduces Jerusalem as speaking. In the third chapter a chorus of the Jews is presented. In the fifth the whole captive Jews pour forth their united complaints to Almighty God. Each of these five parts is distributed into 22 stanzas, according to the number of the letters of the alphabet. In the three first chapters these stanzas consist of three lines. In the four first chapters the initial letter of each period follows the order of the alphabet; and in the third chapter each verse of the same stanza begins with the same letter. In the fourth chapter all the stanzas are evidently distichs, as also in the fifth, which is not acrostic. The intention of the acrostic was to assist the memory to retain sentences not much connected. It deserves to be remarked, that the verses of the first four chapters are longer by almost one half than Hebrew verses generally are: The length of them seems to be on an average about 12 syllables. The prophet appears to have chosen this measure as being solemn and melancholy.

*Lowth.*  
59  
The subject and beauty of it.

\* *Josephus, Jerome, L'Herminier, &c.*

“That the subject of the Lamentations is the destruction of the holy city and temple, the overthrow of the state, the extermination of the people; and that these events are described as actually accomplished, and not in the style of prediction merely, must be evident to every reader; though some authors of considerable reputation \* have imagined this poem to have been composed on the death of king Josiah. The prophet, indeed, has so copiously, so tenderly, and poetically, bewailed the misfortunes of his country, that he seems completely to have fulfilled the office and duty of a mourner. In my opinion, there is not extant any poem which displays such a happy and splendid selection of imagery in so concentrated a state. What can be more elegant and poetical, than the description of that once flourishing city, lately chief among the nations, sitting in the character of a female solitary, afflicted, in a state of widowhood, deserted by her friends, betrayed by her dearest connections, imploring relief, and seeking consolation in vain? What a beautiful personification is that of “the ways of Sion mourning because none are come to her solemn feasts?” How tender and pathetic are the following complaints?

Chap. i.  
r2, 16.

Is this nothing to all you who pass along the way? behold and see,  
If there be any sorrow, like unto my sorrow, which is inflicted on me;  
Which Jehovah inflicted on me in the day of the violence of his wrath.  
For these things I weep, my eyes stream with water;  
Because the comforter is far away, that should tranquilize my soul:  
My children are desolate, because the enemy was strong.

But to detail its beauties would be to transcribe the entire poem.”

*Scripture.*

Ezekiel was carried to Babylon as a captive, and received the first revelations from heaven, in the fifth year of Jehoiakim's captivity, A. C. 595. The book of Ezekiel is sometimes distributed under different heads. In the three first chapters the commission of the prophet is described. From the fourth to the thirty-second chapter inclusive, the calamities that befel the enemies of the Jews are predicted, viz. the Ammonites, the Moabites, and Philistines. The ruin of Tyre and of Sidon, and the fall of Egypt, are particularly foretold; prophecies which have been fulfilled in the most literal and astonishing manner, as we have been often assured by the relation of historians and travellers. From the 32d chapter to the 40th he inveighs against the hypocrisy and murmuring spirit of his countrymen, admonishing them to resignation by promises of deliverance. In the 38th and 39th chapters he undoubtedly predicts the final return of the Jews from their dispersion in the latter days, but in a language so obscure that it cannot be understood till the event take place. The nine last chapters of this book furnish the description of a very remarkable vision of a new temple and city, of a new religion and polity.

60  
Ezekiel.

“Ezekiel is much inferior to Jeremiah in elegance; in sublimity he is not even excelled by Isaiah: but his sublimity is of a totally different kind. He is deep, vehement, tragical; the only sensation he affects to excite is the terrible: his sentiments are elevated, fervid, full of fire, indignant; his imagery is crowded, magnificent, terrific, sometimes almost to disgust: his language is pompous, solemn, austere, rough, and at times unpolished: he employs frequent repetitions, not for the sake of grace or elegance, but from the vehemence of passion and indignation. Whatever subject he treats of, that he sedulously pursues, from that he rarely departs, but cleaves as it were to it; whence the connection is in general evident and well preserved. In many respects he is perhaps excelled by the other prophets; but in that species of composition to which he seems by nature adapted, the forcible, the impetuous, the great and solemn, not one of the sacred writers is superior to him. His diction is sufficiently perspicuous; all his obscurity consists in the nature of the subject. Visions (as for instance, among others, those of Hosea, Amos, and Jeremiah) are necessarily dark and confused. The greater part of Ezekiel, towards the middle of the book especially, is poetical, whether we regard the matter or the diction. His periods, however, are frequently so rude and incompact, that I am often at a loss how to pronounce concerning his performance in this respect.

61  
Character as a writer.

*Lowth.*

“Isaiah, Jeremiah, and Ezekiel, as far as relates to style, may be said to hold the same rank among the Hebrews, as Homer, Simonides, and Æschylus among the Greeks.”

So full an account of Daniel and his writings has been already given under the article DANIEL, that little remains to be said on that subject. Daniel flourished during the successive reigns of several Babylonish and Median kings to the conquest of Babylon by Cyrus. The events recorded in the 6th chapter were contemporary with Darius the Mede; but in the 7th and 8th chapters Daniel returns to an earlier period, to relate

62  
Daniel.



the visions which he beheld in the three first years of Belshazzar's reign; and those which follow in the four last chapters were revealed to him in the reign of Darius. The six last chapters are composed of prophecies delivered at different times; all of which are in some degree connected as parts of one great scheme. They extend through many ages, and furnish the most striking description of the fall of successive kingdoms, which were to be introductory to the establishment of the Messiah's reign. They characterize in descriptive terms the four great monarchies of the world to be succeeded by "that kingdom which should not be destroyed."

The whole book of Daniel being no more than a plain relation of facts, partly past and partly future, must be excluded the class of poetical prophecy. Much indeed of the parabolic imagery is introduced in that book; but the author introduces it as a prophet only; as visionary and allegorical symbols of objects and events, totally untinged with the true poetical colouring. The Jews, indeed, would refuse to Daniel even the character of a prophet: but the arguments under which they shelter this opinion are very futile; for those points which they maintain concerning the conditions on which the gift of prophecy is imparted, the different gradations, and the discrimination between the true prophecy and mere inspiration, are all trifling and absurd, without any foundation in the nature of things, and totally destitute of scriptural authority. They add, that Daniel was neither originally educated in the prophetic discipline and precepts, nor afterwards lived conformably to the manner of the prophets. It is not, however, easy to comprehend how this can diminish his claim to a divine mission and inspiration; it may possibly enable us, indeed, to assign a reason for the dissimilarity between the style of Daniel and that of the other prophets, and for its possessing so little of the diction and character of poetry, which the rest seem to have imbibed in common from the schools and discipline in which they were educated.

The prophecies of Daniel appear so plain and intelligible after their accomplishment, that Porphyry, who wrote in the 3d century, affirms, that they were written after the events to which they refer took place. A little reflection will show the absurdity of this supposition. Some of the prophecies of Daniel clearly refer to Antiochus Epiphanes, with whose oppressions the Jews were too well acquainted. Had the book of Daniel not made its appearance till after the death of Epiphanes, every Jew who read it must have discovered the forgery. And what motive could induce them to receive it among their sacred books? It is impossible to conceive one. Their character was quite the reverse: their respect for the Scriptures had degenerated into superstition. But we are not left to determine this important point from the character of the Jews; we have access to more decisive evidence; we are sure that the book of Daniel contains prophecies, for some of them have been accomplished since the time of Porphyry; particularly those respecting Antichrist: now, if it contains any prophecies, who will take upon him to affirm that the divine Spirit, which dictated these many centuries before they were fulfilled, could not also have delivered prophecies concerning Antiochus Epiphanes?

The language in which the book of Daniel is composed proves that it was written about the time of the

Babylonish captivity. Part of it is pure Hebrew; a language in which none of the Jewish books were composed after the age of Epiphanes. These are arguments to a deist. To a Christian the internal marks of the book itself will show the time in which it was written, and the testimony of Ezekiel will prove Daniel to be at least his contemporary\*.

The twelve minor prophets were so called, not from any supposed inferiority in their writings, but on account of the small size of their works. Perhaps it was for this reason that the Jews joined them together, and considered them as one volume. These 12 prophets present in scattered hints a lively sketch of many particulars relative to the history of Judah and of Israel, as well as of other kingdoms: they prophesy with historical exactness the fate of Babylon, of Nineveh, of Tyre, of Sidon, and of Damascus. The three last prophets especially illustrate many circumstances at a period when the historical pages of Scripture are closed, and when profane writers are entirely wanting. At first the Jewish prophets appeared only as single lights, and followed each other in individual succession; but they became more numerous about the time of the captivity. The light of inspiration was collected into one blaze, previous to its suspension; and it served to keep alive the expectations of the Jews during the awful interval which prevailed between the expiration of prophecy and its grand completion on the advent of Christ.

Hosea has been supposed the most ancient of the 12 minor prophets. He flourished in the reign of Jeroboam II. king of Israel, and during the successive reigns of Uzziah, Jotham, Ahaz, and Hezekiah, kings of Judah. He was therefore nearly contemporary with Isaiah, Amos, and Jonah. The prophecies of Hosea being scattered through the book without date or connection, cannot with any certainty be chronologically arranged.

Hosea is the first in order of the minor prophets, and is perhaps, Jonah excepted, the most ancient of them all. His style exhibits the appearance of very remote antiquity; it is pointed, energetic, and concise. It bears a distinguished mark of poetical composition, in that pristine brevity and condensation which is observable in the sentences, and which later writers have in some measure neglected. This peculiarity has not escaped the observation of Jerome: "He is altogether (says he, speaking of this prophet) laconic and sententious." But this very circumstance, which anciently was supposed no doubt to impart uncommon force and elegance, in the present ruinous state of the Hebrew literature is productive of so much obscurity, that although the general subject of this writer be sufficiently obvious, he is the most difficult and perplexed of all the prophets. There is, however, another reason for the obscurity of his style: Hosea prophesied during the reigns of the four kings of Judah, Uzziah, Jotham, Ahaz, and Hezekiah. The duration of his ministry, therefore, in whatever manner we calculate, must include a very considerable space of time. We have now only a small volume of his remaining, which seems to contain his principal prophecies; and these are extant in a continued series, with no marks of distinction as to the times in which they were published, or the subjects of which they treat. There is therefore no cause to wonder if, in perusing the prophecies of Hosea, we sometimes find

\*Ezek. xiv.

14. xxviii. 3.

65  
Twelve  
minor prophets.Gray's Key  
to the Old  
Testament.

66

Prophecies  
of Hosea.

67

Character  
of his  
style.

*Scripture.* ourselves in a similar predicament with those who consulted the scattered leaves of the Sibyl.

As a specimen of Hosea's style, we select the following beautiful pathetic passage :

How shall I resign thee, O Ephraim !  
 How shall I deliver thee up, O Israel !  
 How shall I resign thee as Admah !  
 How shall I make thee as Zeboim !  
 My heart is changed within me ;  
 I am warmed also with repentance towards thee.  
 I will not do according to the fervour of my wrath ;  
 I will not return to destroy Ephraim :  
 For I am God, and not man ;  
 Holy in the midst of thee, though I inhabit not thy cities.

68  
*Prophecies of Joel.* Concerning the date of the prophecy of Joel there are various conjectures. The book itself affords nothing by which we can discover when the author lived, or upon what occasion it was written. Joel speaks of a great famine, and of mischiefs that happened in consequence of an inundation of locusts ; but nothing can be gathered from such general observations to enable us to fix the period of his prophecy. St Jerome thinks (and it is the general opinion) that Joel was contemporary with Hosea. This is possibly true ; but the foundation on which the opinion rests is very precarious, *viz.* That when there is no proof of the time in which a prophet lived, we are to be guided in our conjectures respecting it by that of the preceding prophet whose epoch is better known. As this rule is not infallible, it therefore ought not to hinder us from adopting any other opinion that comes recommended by good reasons. Father Calmet places him under the reign of Josiah, at the same time with Jeremiah, and thinks it probable that the famine to which Joel alludes, is the same with that which Jeremiah predicted ch. viii. 13.

69  
*Character of their style.* The style of Joel is essentially different from that of Hosea ; but the general character of his diction, though of a different kind, is not less poetical. He is elegant, perspicuous, copious, and fluent ; he is also sublime, animated, and energetic. In the first and second chapters he displays the full force of the prophetic poetry, and shows how naturally it inclines to the use of metaphors, allegories, and comparisons. Nor is the connection of the matter less clear and evident than the complexion of the style : this is exemplified in the display of the impending evils which gave rise to the prophecy ; the exhortation to repentance ; the promises of happiness and success both terrestrial and eternal to those who become truly penitent ; the restoration of the Israelites ; and the vengeance to be taken of their adversaries. But while we allow this just commendation to his perspicuity both in language and arrangement, we must not deny that there is sometimes great obscurity observable in his subject, and particularly in the latter part of the prophecy.

The following prophecy of a plague of locusts is described with great sublimity of expression :

For a nation hath gone up on my land,  
 Who are strong, and without number :  
 They have destroyed my vine, and have made my fig-tree a broken branch.

They have made it quite bare, and cast it away : the branches thereof are made white.

\* Joel i. 6,  
 7, 10, &c. The field is laid waste ; the ground mourneth\*.

Amos was contemporary with Hosea. They both *Scripture* began to prophesy during the reigns of Uzziah over Judah, and of Jeroboam II. over Israel. Amos saw <sup>70</sup> his first vision two years before the earthquake, which *Prophecies of Amos.* Zechariah informs us happened in the days of Uzziah. See AMOS.

Amos was a herdsman of Tckoa, a small town in the territory of Judah, and a gatherer of sycamore fruit. In the simplicity of former times, and in the happy climates of the East, these were not considered as dishonourable occupations. He was no prophet (as he informed Amaziah †), neither was he a prophet's son, † *Amos vi.* that is, he had no regular education in the schools of the prophets.

The prophecies of Amos consist of several distinct discourses, which chiefly respect the kingdom of Israel ; yet sometimes the prophet inveighs against Judah, and threatens the adjacent nations, the Syrians, Philistines, Tyrians, Edomites, Ammonites, and Moabites.

Jerome calls Amos "rude in speech, but not in <sup>71</sup> Their style knowledge † ;" applying to him what St Paul modestly *Proam.* professes of himself §. "Many (says Dr Lowth) have *Comment. in* followed the authority of Jerome in speaking of this *Amos.* prophet, as if he were indeed quite rude, ineloquent, *2 Cor. xi.* and destitute of all the embellishments of composition. The matter is, however, far otherwise. Let any person who has candour and perspicacity enough to judge, not from the man but from his writings, open the volume of his predictions, and he will, I think, agree with me, that our shepherd 'is not a whit behind the very chief of the prophets ||.' He will agree, that as in sublimity || *2 Cor. xi.* and magnificence he is almost equal to the greatest, so in splendour of diction and elegance of expression he is scarcely inferior to any. The same celestial Spirit indeed actuated Isaiah and Daniel in the court and Amos in the sheep-folds ; constantly selecting such interpreters of the divine will as were best adapted to the occasion, and sometimes 'from the mouth of babes and sucklings perfecting praise :' occasionally employing the natural eloquence of some, and occasionally making others eloquent."

Mr Locke has observed, that the comparisons of this prophet are chiefly drawn from lions and other animals with which he was most accustomed ; but the finest images and allusions are drawn from scenes of nature. There are many beautiful passages in the writings of Amos, of which we shall present one specimen :

Wo to them that are at ease in Zion,  
 And trust in the mountains of Samaria ;  
 Who are named chief of the nations,  
 To whom the house of Israel came :  
 Pass ye unto Calneh and see,  
 And from thence go to Hamath the Great ;  
 Then go down to Gath of the Philistines ;  
 Are they better than these kingdoms ?  
 Or their borders greater than their borders ?  
 Ye that put far away the evil day,  
 And cause the seat of violence to come near ;  
 That lie upon beds of ivory,  
 And stretch yourselves upon couches ;  
 That eat the lambs out of the flock,  
 And the calves out of the midst of the stall ;  
 That chant to the sound of the viol,  
 And like David devise instruments of music ;

That

pture. That drink wine in bowls,  
And anoint yourselves with chief ointments;  
vi. 1 *But are not grieved for the affliction of Joseph* ||.

<sup>72</sup>badiah. The writings of Obadiah, which consist of one chapter, are composed with much beauty, and unfold a very interesting scene of prophecy. Of this prophet little can be said, as the specimen of his genius is so short, and the greater part of it included in one of the prophecies of Jeremiah. Compare Ob. 1—9. with Jer. xlix. 14, 15, 16. See OBADIAH.

<sup>73</sup>onah. Though Jonah be placed the sixth in the order of the minor prophets both in the Hebrew and Septuagint, he is generally considered as the most ancient of all the prophets, not excepting Hosea. He lived in the kingdom of Israel, and prophesied to the ten tribes under the reign of Jotham and Jeroboam. The book of Jonah is chiefly historical, and contains nothing of poetry but the prayer of the prophet. The sacred writers, and our Lord himself, speaks of Jonah as a prophet of considerable eminence\*. See JONAH.

<sup>25.</sup> Micah began to prophesy soon after Isaiah, Hosea, Joel, and Amos; and he prophesied between A. M. 3246, when Jotham began to reign, and A. M. 3305, when Hezekiah died. One of his predictions is said † to have saved the life of Jeremiah, who under the reign of Jehoiakim would have been put to death for prophesying the destruction of the temple, had it not appeared that Micah had foretold the same thing under Hezekiah above 100 years before ‡. Micah is mentioned as a prophet in the book of Jeremiah and in the New Testament ||. He is imitated by succeeding prophets (N), as he himself had borrowed expressions from his predecessors (O). Our Saviour himself spoke in the language of this prophet (P).

<sup>75</sup>style. The style of Micah is for the most part close, forcible, pointed, and concise; sometimes approaching the obscurity of Hosea; in many parts animated and sublime; and in general truly poetical. In his prophecies there is an elegant poem, which Dr Lowth thinks is a citation from the answer of Balaam to the king of the Moabites:

Wherewith shall I come before Jehovah?  
Wherewith shall I bow myself unto the High God?  
Shall I come before him with burnt-offerings,  
With calves of a year old?  
Will Jehovah be pleased with thousands of rams?  
With ten thousands of rivers of oil?  
Shall I give my first-born for my transgression?  
The fruit of my body for the sin of my soul?  
He hath showed thee, O man, what is good:  
And what doth Jehovah require of thee,  
But to do justice, and to love mercy,  
And to be humble in walking with thy God?

<sup>76</sup>Nahum. Josephus asserts, that Nahum lived in the time of Jotham king of Judah; in which case he may be supposed to have prophesied against Nineveh when Tiglath-Pileser

king of Assyria carried captive the natives of Galilee and other parts about A. M. 3264. It is, however, probable, that his prophecies were delivered in the reign of Hezekiah; for he appears to speak of the taking of No-Ammon a city of Egypt, and of the insolent messengers of Sennacherib, as of things past; and he likewise describes the people of Judah as still in their own country, and desirous of celebrating their festivals.

While Jerusalem was threatened by Sennacherib, Nahum promised deliverance to Hezekiah, and predicted that Judah would soon celebrate her solemn feasts secure from invasion, as her enemy would no more disturb her peace. In the second and third chapters Nahum foretells the downfall of the Assyrian empire and the final destruction of Nineveh, which was probably accomplished by the Medes and Babylonians, whose combined forces overpowered the Assyrians by surprise “while they were folded together as thorns, and while they were drunken as drunkards,” when the gates of the river were opened, the palace demolished, and an “over-running flood” assisted the conquerors in their devastation; who took an endless store of spoil of gold and silver, making an utter end of the place of Nineveh, of that vast and populous city, whose walls were 100 feet high, and so broad that three chariots could pass abreast. Yet so completely was this celebrated city destroyed, that even in the 2d century the spot on which it stood could not be ascertained, every vestige of it being gone.

It is impossible to read of the exact accomplishment of the prophetic denunciations against the enemies of the Jews, without reflecting on the astonishing proofs which that nation enjoyed of the divine origin of their religion. From the Babylonish captivity to the time of Christ they had numberless instances of the fulfilment of their prophecies.

The character of Nahum as a writer is thus described by Dr Lowth: “None of the minor prophets seem to equal Nahum in boldness, ardour, and sublimity. His prophecy, too, forms a regular and perfect poem; the exordium is not merely magnificent, it is truly majestic; the preparation for the destruction of Nineveh, and the description of its downfall and desolation, are expressed in the most vivid colours, and are bold and luminous in the highest degree.”

As the prophet Habakkuk makes no mention of the Assyrians, and speaks of the Chaldean invasions as near at hand, he probably lived after the destruction of the Assyrian empire in the fall of Nineveh A. M. 3392, and not long before the devastation of Judæa by Nebuchadnezzar. Habakkuk was then nearly contemporary with Jeremiah, and predicted the same events. A general account of Habakkuk's prophecies have already been given under the word *НАВАККУК*, which may be consulted. We would, however, farther observe, that the prayer in the third chapter is a most beautiful and perfect ode, possessing all the fire of poetry and the profound reverence of religion.

R 2

God

(N) Compare Zephan. iii. 19. with Micah iv. 7. and Ezek. xxii. 27. with Micah iii. 11.

(O) Compare Micah iv. 1—3. and Isaiah ii. 2—4. Micah iv. 23. with Isaiah xli. 15.

(P) Compare Micah vii. 6. with Matt. x. 35, 36.

Scripture. God came from Teman,  
 And the Holy One from mount Paran :  
 His glory covered the heavens,  
 And the earth was full of his praise.  
 His brightness was as the light ;  
 Beams of glory issued from his side ;  
 And there was the hiding of his power.  
 Before him went the pestilence ;  
 And burning coals went forth at his feet.  
 He stood and measured the earth ;  
 He beheld and drove asunder the nations ;  
 The everlasting mountains were scattered ;  
 The perpetual hills did bow.

The prophet illustrates this subject throughout with equal sublimity ; selecting from such an assemblage of miraculous incidents the most noble and important, displaying them in the most splendid colours, and embellishing them with the sublimest imagery, figures, and diction ; the dignity of which is so heightened and recommended by the superior elegance of the conclusion, that were it not for a few shades which the hand of time has apparently cast over it in two or three passages, no composition of the kind would appear more elegant or more perfect than this poem.

Habakkuk is imitated by succeeding prophets, and his words are borrowed by the evangelical writers ||.

|| Heb. x.  
 37, 38.  
 Rom. i. 17.  
 Gal. iii. 2.  
 Acts xiii.  
 41. compar.  
 with Hab.  
 i. 5.

78  
 Prophecies  
 of Zephaniah

Zephaniah, who was contemporary with Jeremiah, prophesied in the reign of Josiah king of Judah ; and from the idolatry which he describes as prevailing at that time, it is probable that his prophecies were delivered before the last reformation made by that pious prince A. M. 3381.

The account which Zephaniah and Jeremiah give of the idolatries of their age is so similar, that St Theodore asserts, that Zephaniah abridged the descriptions of Jeremiah. But it is more probable that the prophecies of Zephaniah were written some years before those of his contemporary ; for Jeremiah seems to represent the abuses as partly removed which Zephaniah describes as flagrant and excessive (q).

In the first chapter Zephaniah denounces the wrath of God against the idolaters who worshipped Baal and the host of heaven, and against the violent and deceitful. In the second chapter the prophet threatens destruction to the Philistines, the Moabites, the Ammonites, and Ethiopians ; and describes the fate of Nineveh in emphatic terms : " Flocks shall lie down in the midst of her ; all the beasts of the nations, both the cormorant and bittern, shall lodge in her ; their voice shall sing in the windows ; desolation shall be in the thresholds." In the third chapter the prophet inveighs against the pollutions and oppressions of the Jews ; and concludes with the promise, " That a remnant would be saved, and that multiplied blessings would be bestowed upon the penitent." The style of Zephaniah is poetical, but is not distinguished by any peculiar elegance or beauty, though generally animated and impressive.

79  
 of Haggai.

Haggai, the tenth of the minor prophets, was the first who flourished among the Jews after the Babylonish captivity. He began to prophesy in the second

year of Darius Hystaspes, about 520 years before Christ.

The intention of the prophecy of Haggai was to encourage the dispirited Jews to proceed with the building of the temple. The only prediction mentioned refers to the Messiah, whom the prophet assures his countrymen would fill the new temple with glory. So well was this prediction understood by the Jews, that they looked with earnest expectation for the Messiah's appearing in this temple till it was destroyed by the Romans. But as the victorious Messiah, whom they expected, did not then appear, they have since applied the prophecy to a third temple, which they hope to see reared in some future period.

The style of Haggai, in the opinion of Dr Lowth, is prosaic. Dr Newcome thinks that a great part of it is poetical.

Zechariah was undoubtedly a contemporary of Haggai, and began to prophesy two months after him, in the eighth month of the second year of Darius Hystaspes, A. M. 3484, being commissioned as well as Haggai to exhort the Jews to proceed in the building of the temple after the interruption which the work had suffered. We are informed by Ezra (vi. 14.), that the Jews prospered through the prophesying of Zechariah and Haggai.

Zechariah begins with general exhortations to his countrymen, exciting them to repent from the evil ways of their fathers, whom the prophets had admonished in vain. He describes angels of the Lord interceding for mercy on Jerusalem and the desolate cities of Judah, which had experienced the indignation of the Most High for 70 years while the neighbouring nations were at peace. He declares, that the house of the Lord should be built in Jerusalem, and that Zion should be comforted. The prophet then represents the increase and prosperity of the Jews under several typical figures. He describes the establishment of the Jewish government and the coming of the Messiah. He admonishes those who observed solemn fasts without due contrition, to execute justice, mercy, and compassion, every man to his brother ; not to oppress the widow nor the fatherless, the stranger nor the poor. He promises, that God would again show favour to Jerusalem ; that their mournful fasts should be turned into cheerful feasts ; and that the church of the Lord should be enlarged by the accession of many nations.

The 12th verse of the 11th chapter of this book, which exhibits a prophetic description of some circumstances afterwards fulfilled in our Saviour, appears to be cited by St Matthew (xxvii. 9, 10.) as spoken by Jeremiah ; and as the 11th, 12th, and 13th chapters have been thought to contain some particulars more suitable to the age of Jeremiah than to that of Zechariah, some learned writers are of opinion that they were written by the former prophet, and have been from similarity of subject joined by mistake to those of Zechariah. But others are of opinion, that St Matthew might allude to some traditional prophecy of Jeremiah, or, what is more probable, that the name of Jeremiah was substituted by mistake in place of Zechariah.

The

**Scripture.** The 12th, 13th, and 14th chapters contain prophecies which refer entirely to the Christian dispensation; the circumstances attending which he describes with a clearness which indicated their near approach.

The style of Zechariah is so similar to that of Jeremiah, that the Jews were accustomed to remark that the spirit of Jeremiah had passed into him. He is generally prosaic till towards the conclusion of his work, when he becomes more elevated and poetical. The whole is beautifully connected by easy transitions, and present and future scenes are blended with the greatest delicacy.

**81 Malachi.** Malachi was the last prophet that flourished under the Jewish dispensation; but neither the time in which he lived, nor any particulars of his history, can now be ascertained. It is even uncertain whether the word *Malachi* be a proper name, or denote, as the Septuagint have rendered it, *his angel* (α), that is, "the angel of the Lord." Origen supposed, that Malachi was an angel incarnate, and not a man. The ancient Hebrews, the Chaldee paraphrast, and St Jerome, are of opinion he was the same person with Ezra: but if this was the case, they ought to have assigned some reason for giving two different names to the same person.

As it appears from the concurring testimony of all the ancient Jewish and Christian writers, that the light of prophecy expired in Malachi, we may suppose that the termination of his ministry coincided with the accomplishment of the first seven weeks of Daniel's prophecy, which was the period appointed for sealing the vision and prophecy. This, according to Prideaux's account, took place in A. M. 3595; but, according to the calculations of Bishop Lloyd, to A. M. 3607, twelve years later. Whatever reckoning we prefer, it must be allowed that Malachi completed the canon of the Old Testament about 400 years before the birth of Christ.

It appears certain that Malachi prophesied under Nehemiah, and after Haggai and Zechariah, at a time when great disorders reigned among the priests and people of Judah, which are reproved by Malachi. He inveighs against the priests (i. 6, &c. ii. 1, 2, &c.); he reproaches the people with having taken strange wives (ii. 11.); he reproves them for their inhumanity towards their brethren (ii. 10. iii. 5.); their too frequently divorcing their wives; their neglect of paying their tithes and first-fruits (Mal. iii. 13.) He seems to allude to the covenant that Nehemiah renewed with the Lord (iii. 10. and ii. 4, 5, &c.), assisted by the priests and the chief of the nation. He speaks of the sacrifice of the new law, and of the abolition of those of the old, in these words (i. 10, 11, 12, 13.): "I have no pleasure in you, saith the Lord of hosts, neither will I accept an offering at your hand. For from the rising of the sun, even unto the going down of the same, my name shall be great among the Gentiles, and in every place incense shall be offered unto my name, and a pure offering: for my name shall be great among the Heathen, saith the Lord of hosts." He declares that the Lord was weary with the impiety of Israel; and assures them, that the Lord whom they sought

should suddenly come to his temple preceded by the messenger of the covenant, who was to prepare his way; that the Lord when he appeared should purify the sons of Levi from their unrighteousness, and refine them as metal from the dross; and that then the offering of Judah, the spiritual sacrifice of the heart, should be pleasant to the Lord. The prophet, like one who was delivering a last message, denounces destruction against the impenitent in emphatic and alarming words. He encourages those who feared the name of the Lord with the animating promise, that the "Sun of righteousness should arise with salvation in his rays," and render them triumphant over the wicked. And now that prophecy was to cease, and miracles were no more to be performed till the coming of the Messiah; now that the Jews were to be left to the guidance of their own reason, and the written instructions of their prophets—Malachi exhorts them to remember the law of Moses, which the Lord had revealed from Horeb for the sake of all Israel. At length he seals up the prophecies of the Old Testament, by predicting the commencement of the new dispensation, which should be ushered in by John the Baptist with the power and spirit of Elijah; who should turn the hearts of fathers and children to repentance; but if his admonitions should be rejected, that the Lord would smite the land with a curse.

**82** THE collection of writings composed after the ascension of Christ, and acknowledged by his followers to be divine, is known in general by the name of *NEW TESTAMENT*. This title, though neither given by divine command, nor applied to these writings by the apostles, was adopted in a very early age, though the precise time of its introduction is uncertain, it being justified by several passages in Scripture †, and warranted by the authority of St Paul in particular, who calls the sacred books before the time of Christ *αἱ ἀρχαὶ διαθηκῆς* †. Even long before that period, either the whole of the Old Testament, or the five books of Moses, were entitled *βιβλία διαθηκῆς*, or book of the covenant †.

As the word *διαθηκῆς* admits of a two-fold interpretation, we may translate this title either the *New Covenant* or the *New Testament*. The former translation must be adopted, if respect be had to the texts of Scripture, from which the name is borrowed, since those passages evidently convey the idea of a covenant; and, besides, a being incapable of death can neither have made an old nor make a new testament. It is likewise probable, that the earliest Greek disciples, who made use of this expression, had no other notion in view than that of covenant. We, on the contrary, are accustomed to give this sacred collection the name of *Testament*; and since it would be not only improper, but even absurd, to speak of the Testament of God, we commonly understand the Testament of Christ; an explanation which removes but half the difficulty, since the new only, and not the old, had Christ for its testator.

**83** In stating the evidence for the truth of Christianity, there is nothing more worthy of consideration than the authenticity of the books of the New Testament. This is the foundation on which all other arguments rest; and books.

(α) מלאכי *Malachi* signifies properly *my angel*.

*Scripture.* and if it is solid, the Christian religion is fully established. The proofs for the authenticity of the New Testament have this peculiar advantage, that they are plain and simple, and involve no metaphysical subtilties.—Every man who can distinguish truth from falsehood must see their force; and if there are any so blinded by prejudice, or corrupted by licentiousness, as to attempt by sophistry to elude them, their sophistry will be easily detected by every man of common understanding, who has read the historical evidence with candour and attention. Instead, therefore, of declaiming against the infidel, we solicit his attention to this subject, convinced, that where truth resides, it will shine with so constant and clear a light, that the combined ingenuity of all the deists since the beginning of the world will never be able to extinguish or to obscure it. If the books of the New Testament are really genuine, opposition will incite the Christian to bring forward the evidence; and thus by the united efforts of the deist and the Christian, the arguments will be stated with all the clearness and accuracy of which they are susceptible in so remarkable a degree.

It is surprising that the adversaries of Christianity have not always made their first attacks in this quarter; for if they admit that the writings of the New Testament are as ancient as we affirm, and composed by the persons to whom they are ascribed, they must allow, if they reason fairly, that the Christian religion is true.

The apostles allude frequently in their epistles to the gift of miracles, which they had communicated to the Christian converts by the imposition of hands, in confirmation of the doctrine delivered in their speeches and writings, and sometimes to miracles which they themselves had performed. Now if these epistles are really genuine, it is hardly possible to deny those miracles to be true. The case is here entirely different from that of an historian, who relates extraordinary events in the course of his narrative, since either credulity or an actual intention to deceive may induce him to describe as true a series of falsehoods respecting a foreign land or distant period. Even to the Evangelists might an adversary of the Christian religion make this objection: but to write to persons with whom we stand in the nearest connection, "I have not only performed miracles in your presence, but have likewise communicated to you the same extraordinary endowments," to write in this manner, if nothing of the kind had ever happened, would require such an incredible degree of effrontery, that he who possessed it would not only expose himself to the utmost ridicule, but by giving his adversaries the fairest opportunity to detect his imposture, would ruin the cause which he attempted to support.

St Paul's First Epistle to the Thessalonians is addressed to a community to which he had preached the gospel only three Sabbath days, when he was forced to quit it by the persecution of the populace. In this epistle he appeals to the miracles which he had performed, and to the gifts of the Holy Spirit which he had communicated. Now, is it possible, without forfeiting all pretensions to common sense, that, in writing to a community which he had lately established, he could speak of miracles performed, and gifts of the Holy

*Scripture.* Ghost communicated, if no member of the society had seen the one, or received the other?

To suppose that an impostor could write to the converts or adversaries of the new religion such epistles as these, with a degree of triumph over his opponents, and yet maintain his authority, implies ignorance and stupidity hardly to be believed. Credulous as the Christians have been in later ages, and even so early as the third century, no less severe were they in their inquiries, and guarded against deception, at the introduction of Christianity. This character is given them even by Lucian, a writer of the second century, who vented his satire not only against certain Christians\*, who had supplied Peregrinus with the means of subsistence, but also against heathen oracles and pretended wonders. He relates of his impostor (Pseudomantis), that he attempted nothing supernatural in the presence of the Christians and Epicureans. This Pseudomantis exclaims before the whole assembly, "Away with the Christians, away with the Epicureans, and let those only remain who believe in the Deity!" (οὐκ ἔστιν οὐδὲν ἄλλο) upon which the populace took up stones to drive away the suspicious; while the other philosophers, Pythagoreans, Platonists, and Stoics, as credulous friends and protectors of the cause, were permitted to remain §.

It is readily acknowledged, that the arguments drawn from the authenticity of the New Testament only establish the truth of the miracles performed by the apostles, and are not applicable to the miracles of our Saviour; yet, if we admit the three first gospels to be genuine, the truth of the Christian religion will be proved from the prophecies of Jesus. For if these gospels were composed by Matthew, Mark, and Luke, at the time in which all the primitive Christians affirm, that is, previous to the destruction of Jerusalem, they must be inspired; for they contain a circumstantial prophecy of the destruction of Jerusalem, and determine the period at which it was accomplished. Now it was impossible that human sagacity could foresee that event; for when it was predicted nothing was more improbable. The Jews were resolved to avoid an open rebellion, well knowing the greatness of their danger, and submitted to the oppressions of their governors in the hope of obtaining redress from the court of Rome.—The circumstance which gave birth to these misfortunes is so trifling in itself, that, independent of its consequences, it would not deserve to be recorded. In the narrow entrance to a synagogue in Cæsarea, some person had made an offering of birds merely with a view to irritate the Jews. The insult excited their indignation, and occasioned the shedding of blood. Without this trifling accident, which no human wisdom could foresee even the day before it happened, it is possible that the prophecy of Jesus would never have been fulfilled. But Florus, who was then procurator of Judea, converted this private quarrel into public hostilities, and compelled the Jewish nation to rebel contrary to its wish and resolution, in order to avoid what the Jews had threatened, an impeachment before the Roman emperor for his excessive cruelties. But even after this rebellion had broken out, the destruction of the temple was a very improbable event. It was not the practice of the Romans to destroy the magnificent edifices

*Michaelis's  
Introduction  
to the New  
Testament.*

\* *De morte  
Peregrini,*  
§ 12, 13, 16.  
*Ed. Reitz,*  
1. om. iii. p.  
314—338.

§ *Alexander  
seu Pseudo-  
mantis,* § 25.  
38. Tom. ii.  
p. 232, 233,  
244, 245.

edifices of the nations which they subdued; and of all the Roman generals, none was more unlikely to demolish so ancient and august a building as Titus Vespasian.

ably be expected. 5. When events are recorded which happen later than the time of the pretended author. 6. When opinions are advanced which contradict those he is known to maintain in his other writings. Though this latter argument alone leads to no positive conclusion, since every man is liable to change his opinion, or through forgetfulness to vary in the circumstances of the same relation, of which Josephus, in his Antiquities and War of the Jews, affords a striking example.

Scriptures

So important then is the question, Whether the books of the New Testament be genuine? that the arguments which prove their authenticity, prove also the truth of the Christian religion. Let us now consider the evidence which proves the authenticity of the New Testament.

We receive the books of the New Testament as the genuine works of Matthew, Mark, Luke, John, and Paul, for the same reason that we receive the writings of Xenophon, of Polybius, of Plutarch, of Cæsar, and of Livy. We have the uninterrupted testimony of all ages, and we have no reason to suspect imposition. This argument is much stronger when applied to the books of the New Testament than when applied to any other writings; for they were addressed to large societies, were often read in their presence, and acknowledged by them to be the writings of the apostles.—Whereas, the most eminent profane writings which still remain were addressed only to individuals, or to no persons at all: and we have no authority to affirm that they were read in public; on the contrary, we know that a liberal education was uncommon; books were scarce, and the knowledge of them was confined to a few individuals in every nation.

1. But it cannot be shown that any one doubted of its authenticity in the period in which it first appeared. 2. No ancient accounts are on record whence we may conclude it to be spurious. 3. No considerable period elapsed after the death of the apostles, in which the New Testament was unknown; but, on the contrary, it is mentioned by their very contemporaries, and the accounts of it in the second century are still more numerous. 4. No argument can be brought in its disfavour from the nature of the style, it being exactly such as might be expected from the apostles, not Attic but Jewish Greek. 5. No facts are recorded which happened after their death. 6. No doctrines are maintained which contradict the known tenets of the authors, since, beside the New Testament, no writings of the apostles exist. But, to the honour of the New Testament be it spoken, it contains numerous contradictions to the tenets and doctrines of the fathers in the second and third century, whose morality was different from that of the gospel, which recommends fortitude and submission to unavoidable evils, but not that enthusiastic ardour for martyrdom for which those centuries are distinguished; it alludes to ceremonies which in the following ages were either in disuse or totally unknown; all which circumstances infallibly demonstrate that the New Testament is not a production of either of those centuries.

88  
D not ap-  
ly to the  
New Testa-  
ment.

The New Testament was read over three quarters of the world, while profane writers were limited to one nation or to one country. An uninterrupted succession of writers from the apostolic ages to the present time quote the sacred writings, or make allusions to them: and these quotations and allusions are made not only by friends but by enemies. This cannot be asserted of even the best classic authors. And it is highly probable, that the translations of the New Testament were made so early as the second century; and in a century or two after, they became very numerous. After this period, it was impossible to forge new writings, or to corrupt the sacred text, unless we can suppose that men of different nations, of different sentiments and different languages, and often exceedingly hostile to one another, should all agree in one forgery. This argument is so strong, that if we deny the authenticity of the New Testament, we may with a thousand times more propriety reject all the other writings in the world: we may even throw aside human testimony itself. But as this subject is of great importance, we shall consider it at more length; and to enable our readers to judge with the greater accuracy, we shall state, from the valuable work of Michaelis, as translated by the judicious and learned Mr Marsh, the reasons which may induce a critic to suspect a work to be spurious.

We shall now consider the positive evidence for the authenticity of the New Testament. These may be arranged under the three following heads;

89  
Positively.

1. The impossibility of a forgery, arising from the nature of the thing itself. 2. The ancient Christian, Jewish, and Heathen testimony in its favour. 3. Its own internal evidence.

1. The impossibility of a forgery arising from the nature of the thing itself is evident. It is impossible to establish forged writings as authentic in any place where there are persons strongly inclined and well qualified to detect the fraud. Now the Jews were the most violent enemies of Christianity. They put the founder of it to death; they persecuted his disciples with implacable fury; and they were anxious to stifle the new religion in its birth. If the writings of the New Testament had been forged, would not the Jews have detected the imposture? Is there a single instance on record where a few individuals have imposed a history upon the world against the testimony of a whole nation? Would the inhabitants of Palestine have received the gospels, if they had not had sufficient evidence that Jesus Christ really appeared among them, and performed the miracles ascribed to him? Or would the churches of Rome or of Corinth have acknowledged the epistles addressed to them as the genuine works of Paul, if Paul had never preached among them? We might as well think to prove, that the history of the Reformation is the invention:

90  
Impossibili-  
ty of a for-  
gery arising  
from the  
nature of  
the thing.

1. When doubts have been made from its first appearance in the world, whether it proceeded from the author to whom it is ascribed. 2. When the immediate friends of the pretended author, who were able to decide upon the subject, have denied it to be his production. 3. When a long series of years has elapsed after his death, in which the book was unknown, and in which it must unavoidably have been mentioned and quoted, had it really existed. 4. When the style is different from that of his other writings, or, in case no other remain, different from that which might reason-

85  
eir au-  
thenticity  
ved.

86  
gaively  
87  
e reason  
t would  
ve a  
k to be  
rious

Scripture. vention of historians; and that no revolution happened in Great Britain during the last century.

91  
From testi-  
mony.

2. The second kind of evidence which we produce to prove the authenticity of the New Testament, is the testimony of ancient writers, Christians, Jews, and Heathens.

In reviewing the evidence of testimony, it will not be expected that we should begin at the present age, and trace backwards the authors who have written on this subject to the first ages of Christianity. This indeed, though a laborious task, could be performed in the most complete manner; the whole series of authors, numerous in every age, who have quoted from the books of the New Testament, written commentaries upon them, translated them into different languages, or who have drawn up a list of them, could be exhibited so as to form such a perfect body of evidence, that we imagine even a jury of deists would find it impossible, upon a deliberate and candid examination, to reject or disbelieve it. We do not, however, suppose that scepticism has yet arrived at so great a height as to render such a tedious and circumstantial evidence necessary. Passing over the intermediate space, therefore, we shall ascend at once to the fourth century, when the evidence for the authenticity of the New Testament was fully established, and trace it back from that period to the age of the apostles. We hope that this method of stating the evidence will appear more natural, and will afford more satisfaction, than that which has been usually adopted.

It is surely more natural, when we investigate the truth of any fact which depends on a series of testimony, to begin with those witnesses who lived nearest the present age, and whose characters are best established. In this way we shall learn from themselves the foundation of their belief, and the characters of those from whom they derived it; and thus we ascend till we arrive at its origin. This mode of investigation will give more satisfaction to the deist than the usual way; and we believe no Christian, who is confident of the goodness of his cause, will be unwilling to grant any proper concessions. The deist will thus have an opportunity of examining, separately, what he will consider as the weakest parts of the evidence, those which are exhibited by the earliest Christian writers, consisting of expressions, and not quotations, taken from the New Testament. The Christian, on the other hand, ought to wish, that these apparently weak parts of the evidence were distinctly examined, for they will afford an irrefragable proof that the New Testament was not forged: and should the deist reject the evidence of those early writers, it will be incumbent on him to account for the origin of the Christian religion, which he will find more difficult than to admit the common hypothesis.

In the fourth century we could produce the testimonies of numerous witnesses to prove that the books of the New Testament existed at that time; but it will be sufficient to mention their names, the time in which they wrote, and the substance of their evidence. This we shall present in a concise form in the following table, which is taken from Jones's New and Full Method of establishing the canon of the New Testament.

The Names of the Writers.	The times in which they lived.	The variation or agreement of their catalogues with ours now received.	The books in which these catalogues are received.
I. Athanasius bishop of Alexandria.	A. C. 315.	The same perfectly with ours now received.	<i>Fragm. Epist. Testal. tom. 2. &amp; in Synops. tom. 1.</i>
II. Cyril bishop of Jerusalem.	340.	The same with ours, only the Revelation is omitted.	<i>Catech. IV. § ult. p. 101.</i>
III. The bishops assembled in the council of Laodicea.	364.	The Revelation is omitted.	<i>Canon. LIX. N. B. The Canons of this council were not long afterwards received into the body of the canons of the universal church.</i>
IV. Epiphanius bishop of Salamis in Cyprus.	370.	The same with ours now received.	<i>Heres. 76. cont. Anom. p. 399.</i>
V. Gregory Nazianzen bishop of Constantinople.	375.	Omits the Revelation.	<i>Carm. de veris &amp; genuin. Scriptur.</i>
VI. Philastrius bishop of Brixia in Venice.	380.	The same with ours now received; except that he mentions only 13 of St Paul's epistles (omitting very probably the Epistle to the Hebrews), and leaves out the Revelation.	<i>Lib. de Heres. Numb. 87.</i>
VII. Jerome.	382.	The same with ours; except that he speaks dubiously of the Epistle to the Hebrews; tho' in other parts of his writings he receives it as canonical.	<i>Ep. ad Paulin. 83. Tract. 6. p. 2. Also commonly prefixed to the Latin vulgar.</i>
VIII. Rufinus presbyter of Aquilegium.	390.	It perfectly agrees with ours.	<i>Expos. in Symb. Apostol. § 36. int. Ep. Hieron. Par. 1. Trac. 3. p. 110. &amp; inter Op. Cypr. p. 575.</i>
IX. Austin bishop of Hippo in Africa.	394.	It perfectly agrees with ours.	<i>De Doctrin. Christ. l. 2. c. 8. Tom. Op. 3. p. 25.</i>
X. The XLIV bishops assembled in the third council of Carthage.	St Austin was present at it.	It perfectly agrees with ours.	<i>Vid. Canon. XLVII. &amp; cap. ult.</i>

Scripture.



Scripture. We now go back to Eusebius, who wrote about the year 315, and whose catalogue of the books of the New Testament we shall mention at more length. "Let us observe (says he) the writings of the apostle John, which are *uncontradicted*; and, first of all, must be mentioned, as acknowledged of all, the gospel, according to him, well known to all the churches under heaven."

The author then proceeds to relate the occasions of writing the gospels, and the reasons for placing St John's the last, manifestly speaking of all the four as equal in their authority, and in the certainty of their original. The second passage is taken from a chapter, the title of which is, "Of the Scriptures universally acknowledged, and of those that are not such."

Eusebius begins his enumeration in the following manner: "In the first place, are to be ranked the sacred four Gospels, then the book of the Acts of the Apostles; after that are to be reckoned the Epistles of Paul: in the next place, that called the first Epistle of John and the Epistle of Peter are to be esteemed authentic: after this is to be placed, if it be thought fit, the Revelation of John; about which we shall observe the different opinions at proper seasons. Of the controverted, but yet well known or approved by the most, are that called the Epistle of James and that of Jude, the second of Peter, and the second and third of John, whether they were written by the evangelist or by another of the same name." He then proceeds to reckon up five others, not in our canon, which he calls in one place *spurious*, in another *controverted*; evidently meaning the same thing by these two words (s).

A. D. 290, Victorin bishop of Pettaw in Germany, in a commentary upon this text of the Revelation, "The first was like a lion, the second was like a calf, the third like a man, and the fourth like a flying eagle," makes out, that by the four creatures are intended the four gospels; and to show the propriety of the symbols, he recites the subject with which each evangelist opens his history. The explication is fanciful, but the testimony positive. He also expressly cites the Acts of the Apostles.

A. D. 230, Cyprian bishop of Carthage gives the following testimony: "The church (says this father) is watered like Paradise by four rivers, that is, by four gospels." The Acts of the Apostles are also frequently quoted by Cyprian under that name, and under the name of the *Divine Scriptures*." In his various writings are such frequent and copious citations of Scripture, as to place this part of the testimony beyond controversy. Nor is there, in the works of this eminent African bishop, one quotation of a spurious or apocryphal Christian writing.

A. D. 210, Origen is a most important evidence. Nothing can be more peremptory upon the subject now under consideration, and, from a writer of his learning and information, nothing more satisfactory, than the declaration of Origen, preserved in an extract of his works by Eusebius: "That the four gospels alone are received without dispute by the whole church of God under heaven:" to which declaration is immediately subjoined

VOL. XVII. Part. I.

a brief history of the respective authors, to whom they were then, as they are now, ascribed. The sentiments expressed concerning the gospels in all the works of Origen which remain, entirely correspond with the testimony here cited. His attestation to the Acts of the Apostles is no less positive: "And Luke also once more sounds the trumpet relating the Acts of the Apostles." That the Scriptures were then universally read, is plainly affirmed by this writer in a passage in which he is repelling the objections of Celsus, "That it is not in private books, or such as are read by few only, and those studious persons, but in books read by every body, that it is written, the invisible things of God from the creation of the world are clearly seen, being understood by things that are made." It is to no purpose to single out quotations of Scripture from such a writer as this. We might as well make a selection of the quotations of Scripture in Dr Clarke's sermons. They are so thickly sown in the works of Origen, that Dr Mill says, "If we had all his works remaining, we should have before us almost the whole text of the Bible."

A. D. 194, Tertullian exhibits the number of the <sup>97</sup>gospels then received, the names of the evangelists, and their proper designations, in one short sentence.—

"Among the apostles, John and Matthew teach us the faith; among apostolical men, Luke and Mark refresh it." The next passage to be taken from Tertullian affords as complete an attestation to the authenticity of the gospels as can be well imagined. After enumerating the churches which had been founded by Paul at Corinth, in Galatia, at Philippi, Thessalonica, and Ephesus, the church of Rome established by Peter and Paul, and other churches derived from John, he proceeds thus: "I say then, that with them, but not with them only which are apostolical, but with all who have fellowship with them in the same faith, is that gospel of Luke received from its first publication, which we so zealously maintain;" and presently afterwards adds, "The same authority of the apostolical churches will support the other gospels, which we have from them, and according to them, I mean John's and Matthew's, although that likewise which Mark published may be said to be Peter's, whose interpreter Mark was." In another place Tertullian affirms, that the three other gospels, as well as St Luke's, were in the hands of the churches from the beginning. This noble testimony proves incontestably the antiquity of the gospels, and that they were universally received; that they were in the hands of all, and had been so from the first. And this evidence appears not more than 150 years after the publication of the books. Dr Lardner observes, "that there are more and larger quotations of the small volume of the New Testament in this one Christian author, than there are of all the works of Cicero, in writers of all characters, for several ages."

A. D. 178, Irenæus was bishop of Lyons, and is <sup>98</sup>mentioned by Tertullian, Eusebius, Jerome, and Photius. In his youth he had been a disciple of Polycarp, who was a disciple of John. He asserts of himself and his contemporaries, that they were able to rec-

S

kon

(s) That Eusebius could not intend, by the word rendered *spurious*, what we at present mean by it, is evident from a clause in this very chapter, where, speaking of the Gospels of Peter and Thomas, and Matthias and some others, he says, "They are not so much as to be reckoned among the *spurious*, but are to be rejected as altogether absurd and impious." *Lard. Cred.* vol. viii. p. 98.

**Scripture.** kon up in all the principal churches the succession of bishops to their first institution. His testimony to the four gospels and Acts of the Apostles is express and positive. "We have not received," says Irenæus, "the knowledge of the way of our salvation by any others than those by whom the gospel has been brought to us. Which gospel they first preached, and afterwards, by the will of God, committed to writing, that it might be for time to come the foundation and pillar of our faith. For after that our Lord rose from the dead, and they (the apostles) were endowed from above with the power of the Holy Ghost coming down upon them, they received a perfect knowledge of all things. They then went forth to all the ends of the earth, declaring to men the blessing of heavenly peace, having all of them, and every one alike, the gospel of God. Matthew then, among the Jews, wrote a gospel in their own language, while Peter and Paul were preaching the gospel at Rome, and founding a church there. And after their exit, Mark also, the disciple and interpreter of Peter, delivered to us in writing the things that had been preached by Peter. And Luke, the companion of Paul, put down in a book the gospel preached by him (Paul). Afterwards John, the disciple of the Lord, who also leaned upon his breast, likewise published a gospel while he dwelt at Ephesus in Asia." Irenæus then relates how Matthew begins his gospel, how Mark begins and ends his, and gives the supposed reasons for doing so. He enumerates at length all the passages of Christ's history in Luke, which are not found in any of the other evangelists. He states the particular design with which St John composed his gospel, and accounts for the doctrinal declarations which precede the narrative. If any modern divine should write a book upon the genuineness of the gospels, he could not assert it more expressly, or state their original more distinctly, than Irenæus hath done within little more than 100 years after they were published.

Respecting the book of the Acts of the Apostles, and its author, the testimony of Irenæus is no less explicit. Referring to the account of St Paul's conversion and vocation, in the ninth chapter of that book, "Nor can they (says he, meaning the parties with whom he argues show) that he is not to be credited, who has related to us the truth with the greatest exactness." In another place, he has actually collected the several texts, in which the writer of the history is represented as accompanying St Paul, which led him to exhibit a summary of almost the whole of the last twelve chapters of the book.

According to Lardner, Irenæus quotes twelve of Paul's epistles, naming their author; also the first epistle of Peter, the two first epistles of John, and the Revelation. The epistles of Paul which he omits are those addressed to Philemon and the Hebrews. Eusebius says, that he quotes the epistle to the Hebrews, though he does not ascribe it to Paul. The work, however, is lost.

<sup>99</sup>  
**Of Tatian.** A. D. 172, Tatian, who is spoken of by Clemens Alexandrinus, Origen, Eusebius, and Jerome, composed a harmony of the four gospels, which he called *Diateffaron* of the four. This title, as well as the work, is remarkable, because it shows that then as well as now there were four, and only four, gospels in general use among Christians.

A. D. 170, the churches of Lyons and Vienne in

**Scripture.** France sent an account of the sufferings of their martyrs to the churches of Asia and Phrygia, which has been preserved entire by Eusebius. And what carries in some measure the testimony of these churches to a higher age is, that they had now for their bishop Pothinus, who was 90 years old, and whose early life consequently must have immediately followed the times of the apostles. In this epistle are exact references to the gospels of Luke and John, and to the Acts of the Apostles. The form of reference is the same as in all the preceding articles. That from St John is in these words: "Then was fulfilled that which was spoken by the Lord, that whosoever killeth you, will think that he doth God service\*."

Distinct references are also made to other books, viz. Acts, Romans, Ephesians, Philippians, 1. Timothy, 1 Peter, 1 John, Revelation.

A. D. 140, Justin Martyr composed several books, which are mentioned by his disciple Tatian, by Tertullian, Methodius, Eusebius, Jerome, Epiphanius, and Photius. In his writings between 20 and 30 quotations from the gospels and Acts of the Apostles are reckoned up, which are clear, distinct, and copious; if each verse be counted separately, a much greater number; if each expression, still more. Jones, in his book on the Canon of the New Testament, ventures to affirm that he cites the books of which it consists, particularly the four gospels, above 200 times.

We meet with quotations of three of the gospels within the compass of half a page; "and in other words, he says, Depart from me into outer darkness, which the Father hath prepared for Satan and his Angels," (which is from Matthew xxv. 41.) "And again he said in other words, I give unto you power to tread upon serpents and scorpions, and venomous beasts, and upon all the power of the enemy." (This from Luke x. 19.) "And, before he was crucified, he said, The son of man must suffer many things, and be rejected of the Scribes and Pharisees, and be crucified, and rise again the third day; (this from Mark viii. 31.)

All the references in Justin are made without mentioning the author; which proves that these books were perfectly well known, and that there were no other accounts of Christ then extant, or, at least, no others so received and credited as to make it necessary to add any marks of distinction. But although Justin mentions not the authors names, he calls the books *Memoirs composed by the Apostles; Memoirs composed by the Apostles and their Companions*; which descriptions, the latter especially, exactly suit the titles which the Gospels and Acts of the Apostles now bear.

He informs us, in his first apology, that *the memoirs of the Apostles*, or the writings of the prophets, are read according as the time allows; and, when the reader has ended, the president makes a discourse, exhorting to the imitation of such excellent things.

A few short observations will show the value of this testimony. 1. The *Memoirs of the Apostles*, Justin in another place expressly tells us are what are called *gospels*. And that they were the gospels which we now use is made certain by Justin's numerous quotations of them, and his silence about any others. 2. He describes the general usage of the Christian church. 3. He does not speak of it as recent or newly instituted, but in the terms in which men speak of established customs.

**Scripture.** Justin also makes such allusions to the following books as shows that he had read them : Romans, 1 Corinthians, Galatians, Ephesians, Philippians, Colossians, 2 Thessalonians, Hebrews, 2 Peter ; and he ascribes the Revelation to John the Apostle of Christ.

**101**  
**Of Papias.** A. D. 116, Papias, a hearer of John, and companion of Polycarp, as Irenæus attests, and of the apostolical age as all agree, in a passage quoted by Eusebius, from a work now lost, expressly ascribes the two first gospels to Matthew and Mark ; and in a manner which proves that these gospels must have publicly borne the names of these authors at that time, and probably long before ; for Papias does not say, that one gospel was written by Matthew, and another by Mark ; but, assuming this as perfectly well known, he tells us from what materials Mark collected his account, viz. from Peter's preaching, and in what language Matthew wrote, viz. in Hebrew. Whether Papias was well informed in this statement or not, to the point for which this testimony is produced, namely, that these books bore these names at this time, his authority is complete.

Papias himself declares that he received his accounts of Christianity from those who were acquainted with the apostles, and that those accounts which he thus received from the older Christians, and had committed to memory, he inserted in his books. He farther adds, that he was very solicitous to obtain every possible information, especially to learn what the apostles said and preached, valuing such information more than what was written in books\*.

**102**  
**Of Polycarp.** A. D. 108, Polycarp was the bishop of Smyrna, and disciple of John the Apostle. This testimony concerning Polycarp is given by Irenæus, who in his youth had seen him. " I can tell the place," saith Irenæus, " in which the blessed Polycarp sat and taught, and his going out and coming in, and the manner of his life, and the form of his person, and the discourses he made to the people, and how he related his conversation with John and others who had seen the Lord, and how he related their sayings, and what he had heard concerning the Lord, both concerning his miracles and his doctrine, as he had received them from the eye-witnesses of the word of life ; all which Polycarp related agreeable to the scriptures."

Of Polycarp, whose proximity to the age and country and persons of the apostles is thus attested, we have one undoubted epistle remaining ; which, though a short performance, contains nearly 40 clear allusions to the books of the New Testament. This is strong evidence of the respect which was paid to them by Christians of that age. Amongst these, although the writings of St Paul are more frequently used by Polycarp than other parts of scripture, there are copious allusions to the gospel of St Matthew, some to passages found in the gospels both of Matthew and Luke, and some which more nearly resemble the words in Luke.

He thus fixes the authority of the Lord's Prayer, and the use of it among Christians. If, therefore, we pray the Lord to forgive us, we ought also to forgive. And again, With supplication beseeching the all-seeing God not to lead us into temptation.

In another place, he quotes the words of our Lord : " But remembering what the Lord said, teaching, Judge not, that ye be not judged. Forgive, and ye shall be forgiven ; be ye merciful, that ye may obtain mercy ; with what measure ye mete, it shall be measured

to you again\*." Supposing Polycarp to have had these words from the books in which we now find them, it is manifest that these books were considered by him, and by his readers, as he thought, as authentic accounts of Christ's discourses ; and that this point was incontestable.

He quotes also the following books, the first of which he ascribes to St Paul : 1 Corinthians, Ephesians, Philippians, 1 and 2 Thessalonians ; and makes evident references to others, particularly to Acts, Romans, 2 Corinthians, Galatians, 1 Timothy, 2 Timothy, 1 Peter, 1 John.

Ignatius, as it is testified by ancient Christian writers, became bishop of Antioch about 37 years after Christ's ascension ; and therefore, from his time, and place, and station, it is probable that he had known and conversed with many of the apostles. Epistles of Ignatius are referred to by Polycarp his contemporary. Passages, found in the epistles now extant under his name, are quoted by Irenæus, A. D. 178, by Origen, A. D. 230 ; and the occasion of writing them is fully explained by Eusebius and Jerome. What are called the smaller epistles of Ignatius are generally reckoned the same which were read by Irenæus, Origen, and Eusebius.

They are admitted as genuine by Vossius, and have been proved to be so by bishop Pearson with a force of argument which seems to admit of no reply. In these epistles are undoubted allusions to Matt. iii. 15. xi. 16. to John iii. 8. ; and their venerable author, who often speaks of St Paul in terms of the highest respect, once quotes his epistle to the Ephesians by name.

Near the conclusion of the epistle to the Romans, St Paul, amongst others, sends the following salutation : " Salute Asyncritus, Phlegon, Hermas, Patrobus, Hermes, and the brethren which are with them." Of Hermas, who appears in this catalogue of Roman Christians as contemporary with St Paul, there is a book still remaining, the authenticity of which cannot be disputed. It is called the *Shepherd*, or *Pastor of Hermas*. Its antiquity is incontestable, from the quotations of it in Irenæus, A. D. 178, Clement of Alexandria, A. D. 194, Tertullian, A. D. 200, Origen, A. D. 230. The notes of time extant in the epistle itself agree with its title, and with the testimonies concerning it, which intimate that it was written during the lifetime of Clement. In this piece are tacit allusions to St Matthew's, St Luke's, and St John's gospels ; that is to say, there are applications of thoughts and expressions found in these gospels, without citing the place or writer from which they were taken. In this form appear in Hermas the confessing and denying of Christ † ; the parable of the seed sown ‡ ; the comparison of Christ's disciples to little children, the saying, " he putteth away his wife, and marieth another, committeth adultery § ;" the singular expression, " having received all power from his Father," is probably an allusion to Matthew xxviii. 18. and Christ being the " gate," or only way of coming " to God," is a plain allusion to John xiv. 6. x. 7, 9. There is also a probable allusion to Acts v. 32.

The *Shepherd of Hermas* has been considered as a fanciful performance. This, however, is of no importance in the present case. We only adduce it as evidence that the books to which it frequently alludes existed in the first century ; and for this purpose it is satisfactory,

**Scripture.**  
\* Matt. viii. 1. 1. 2. v. 7.

**103**  
Of Ignatius.

**104**  
Of Hermas.

† Matt. x. 32, 33. or Luke xiii. 3. or Luke viii. 5. xvi. 18.

Scripture. factory, as its authenticity has never been questioned. However absurd opinions a man may entertain while he retains his understanding, his testimony to a matter of fact will still be received in any court of justice.

105  
Of Cle-  
mens Ro-  
manus.

A. D. 96, we are in possession of an epistle written by Clement bishop of Rome, whom ancient writers, without any doubt or scruple, assert to have been the Clement whom St Paul mentions Philippians iv. 3. "with Clement also, and other my fellow labourers, whose names are in the book of life." This epistle is spoken of by the ancients as an epistle acknowledged by all; and, as Irenæus well represents its value, "written by Clement, who had seen the blessed apostles and conversed with them, who had the preaching of the apostles still sounding in his ears, and their traditions before his eyes." It is addressed to the church of Corinth; and what alone may seem a decisive proof of its authenticity, Dionysius bishop of Corinth, about the year 170, *i. e.* about 80 or 90 years after the epistle was written, bears witness, "that it had been usually read in that church from ancient times." This epistle affords, amongst others, the following valuable passages: "Especially remembering the words of the Lord Jesus, which he spake, teaching gentleness and long suffering; for thus he said ( $\tau$ ), Be ye merciful, that ye may obtain mercy; forgive, that it may be forgiven unto you; as you do, so shall it be done unto you; as you give, so shall it be given unto you; as ye judge, so shall ye be judged; as ye shew kindness, so shall kindness be shewn unto you; with what measure ye mete, with the same it shall be measured to you. By this command, and by these rules, let us establish ourselves, that we may always walk obediently to his holy words."

Again, "Remember the words of the Lord Jesus, for he said, Wo to that man by whom offences come; it were better for him that he had not been born, than that he should offend one of my elect; it were better for him that a millstone should be tied about his neck, and that he should be drowned in the sea, than that he should offend one of my little ones ( $\upsilon$ )."

He ascribes the first epistle to the Corinthians to Paul, and makes such allusions to the following books as is sufficient to shew that he had seen and read them: Acts, Romans, 2 Corinthians, Galatians, Ephesians, Philippians, Colossians, 1 Thessalonians, 1 Timothy, 2 Timothy, Titus, 1 Peter, 2 Peter.

It may be said, as Clement has not mentioned the books by name from which we assert these allusions or references are made, it is uncertain whether he refers to any books, or whether he received these expressions from the discourses and conversation of the apostles. Mr Paley has given a very satisfactory answer to this objection: 1st, That Clement, in the very same manner, namely, without any mark of reference, uses a passage now found in the epistle to the Romans\*; which passage, from the peculiarity of the words that compose it, and from their order, it is manifest that he must have taken

from the epistle. The same remark may be applied to some very singular sentiments in the epistle to the Hebrews. Secondly, That there are many sentences of St Paul's first epistle to the Corinthians to be found in Clement's epistle, without any sign of quotation, which yet certainly are quotations; because it appears that Clement had St Paul's epistle before him; for in one place he mentions it in terms too express to leave us in any doubt. "Take into your hands the epistle of the blessed apostle Paul." Thirdly, That this method of adopting words of scripture, without reference or acknowledgment, was a method in general use amongst the most ancient Christian writers. These analogies not only repel the objection, but cast the presumption on the other side; and afford a considerable degree of positive proof, that the words in question have been borrowed from the places of scripture in which we now find them. But take it, if you will, the other way, that Clement had heard these words from the apostles or first teachers of Christianity; with respect to the precise point of our argument, *viz.* that the scriptures contain what the apostles taught, this supposition may serve almost as well.

We have now traced the evidence to the times of the apostles; but we have not been anxious to draw it out to a great length, by introducing every thing. On the contrary, we have been careful to render it as concise as possible, that its force might be discerned at a glance. The evidence which has been stated is of two kinds. Till the time of Justin Martyr and Irenæus it consists chiefly of allusions, references, and expressions, borrowed from the books of the New Testament, without mentioning them by name. After the time of Irenæus it became usual to cite the sacred books, and mention the authors from whom the citations were taken.

The first species of evidence will perhaps appear to some exceptionable; but it must be remembered that it was usual among the ancient Christians as well as Jews to adopt the expressions of Scripture without naming the authors. Why they did so it is not necessary to inquire. The only point of importance to be determined is, whether those references are a sufficient proof of the existence of the books to which they allude. This, we presume, will not be denied; especially in the present age, when it is so common to charge an author with plagiarism if he happen to fall upon the same train of ideas, or express himself in a similar manner with authors who have written before him. We may farther affirm, that these tacit references afford a complete proof that those ancient writers had no intention of imposing a forgery upon the world. They prove the existence of the Christian religion and of the apostolical writings, without showing any suspicious earnestness that men should believe them. Had these books been forged, those who wished to pass them upon the world would have been at more pains than the first Christians were to prove their authenticity. They acted the part of honest

( $\tau$ ) "Blessed are the merciful, for they shall obtain mercy," Matt. v. 7. "Forgive, and ye shall be forgiven; give, and it shall be given unto you," Luke vi. 37, 38. "Judge not, that ye be not judged; for with what judgment ye judge, ye shall be judged, and with what measure ye mete, it shall be measured to you again," Mat. vii. 2.

( $\upsilon$ ) Matt. xviii. 6. "But who so shall offend one of these little ones which believe in me, it were better for him that a millstone were hanged about his neck, and that he were cast into the sea." The latter part of the passage in Clement agrees more exactly with Luke xvii. 2. "It were better for him that a millstone were hanged about his neck, and he cast into the sea, than that he should offend one of these little ones."

figure. honest men; they believed them themselves, and they never imagined that others would suspect their truth.

It is a confideration of great importance, in reviewing the evidence which has been now stated, that the witnesses lived in different countries; Clemens flourished at Rome. Polycarp at Smyrna, Justin Martyr in Syria, Irenæus in France, Tertullian at Carthage, Origen at Alexandria, and Eusebius at Cæsarea. This proves that the books of the New Testament were equally well known in distant countries by men who had no intercourse with one another.

The same thing is proved by testimonies if possible less exceptionable. The ancient heretics, whose opinions were sometimes grosser and more impious than those which any modern sectary has ventured to broach, and whose zeal in the propagation of them equalled that of the most flaming enthusiast of the last century, never called in question the authenticity of the books of the New Testament. When they met with any passage in the gospels or epistles which they could not reconcile to their own heretical notions, they either erased it, or denied that the author was inspired; but they nowhere contend that the book in which it stood was not written by the apostle or evangelist whose name it bore. Eusebius relates, that the Ebionites rejected all the epistles of Paul, and called him an apostate, because he departed from the Levitical law; and they adopted as their rule of faith the gospel of St Matthew, though indeed they greatly corrupted it. This proves therefore that the gospel according to Matthew was then published, and that St Paul's epistles were then known.

Of the heretics who erased or altered passages to make the Scriptures agree with their doctrines, we may produce Marcion as an instance, who lived in the beginning of the 2d. century. He lived in an age when he could have easily discovered if the writings of the New Testament had been forged; and as he was much incensed against the orthodox party, if such a forgery had been committed, unquestionably he would not have failed to make the discovery, as it would have afforded the most ample means of revenge and triumph, and enabled him to establish his own opinions with less difficulty. But his whole conduct shows clearly, that he believed the writings of the New Testament to be authentic. He said that the gospel according to St Matthew, the epistle to the Hebrews, with those of St Peter and St James, as well as the Old Testament in general, were writings not for Christians but for Jews. He published a new edition of the gospel according to Luke, and the first ten epistles of Paul; in which it has been affirmed by Epiphanius, that he altered every passage that contradicted his own opinions: but as many of these alterations are what modern critics call *various readings*, though we receive the testimony of Epiphanius, we must not rely upon his opinion (x). Hence it is evident that the books of the New Testament above-mentioned did then exist, and were acknowledged to be the works of the authors whose names they bear.

Dr Lardner, in his General Review, sums up this head of evidence in the following words: "Noetus, Paul of Samosata, Sabellius, Marcellus, Photinus, the Novatians, Donatists, Manicheans (y), Priscillianists,

beside Artemon, the Audians, the Arians, and divers others, all received most or all the same books of the New Testament which the Catholics received; and agreed in a like respect for them as writ by apostles or their disciples and companions."

Celsus and Porphyry, both enemies of the Christian religion, are powerful witnesses for the antiquity of the New Testament. Celsus, who lived towards the end of the second century, not only mentions by name, but quotes passages from the books of the New Testament: and that the books to which he refers were no other than our present gospels, is evident from the allusions to various passages still found in them. Celsus takes notice of the genealogies, which fixes two of these gospels; of the precepts, Resist not him that injures you, and, If a man strike thee on the one cheek, offer to him the other also; of the woes denounced by Christ; of his predictions; of his saying that it is impossible to serve two masters; of the purple robe, the crown or thorns, and the reed which was put into the hand of Jesus; of the blood that flowed from his body upon the cross, a circumstance which is recorded only by John; and (what is *inftar omnium* for the purpose for which we produce it) of the difference in the accounts given of the resurrection by the evangelists, some mentioning two angels at the sepulchre, others only one.

It is extremely material to remark, that Celsus not only perpetually referred to the accounts of Christ contained in the four gospels, but that he referred to no other accounts; that he founded none of his objections to Christianity upon any thing delivered in spurious gospels.

The testimony of Porphyry is still more important than that of Celsus. He was born in the year 213, of Tyrian origin. Unfortunately for the present age, says Michaelis, the mistaken zeal of the Christian emperors has banished his writings from the world; and every real friend of our religion would gladly give the works of one of the pious fathers to rescue those of Porphyry from the flames. But Mr Marsh, the learned and judicious translator of Michaelis, relates, that, according to the accounts of Isaac Vossius, a manuscript of the works of Porphyry is preserved in the Medicean library at Florence, but kept so secret that no one is permitted to see it. It is universally allowed, that Porphyry is the most sensible, as well as the most severe, adversary of the Christian religion that antiquity can produce. He was versed not only in history, but also in philosophy and politics. His acquaintance with the Christians was not confined to a single country; for he had conversed with them in Tyre, in Sicily, and in Rome. Enabled by his birth to study the Syriac as well as the Greek authors, he was of all the adversaries to the Christian religion the best qualified to inquire into the authenticity of the sacred writings. He possessed therefore every advantage which natural abilities or a scientific education could afford to discover whether the New Testament was a genuine work of the apostles and evangelists, or whether it was imposed upon the world after the decease of its pretended authors. But no trace of this suspicion is anywhere to be found in his writings. In the fragments which still remain,

(x) Dr Loeffler has written a learned dissertation to prove that Marcion did not corrupt the sacred writings.  
(y) This must be with an exception, however, of Faustus, who lived so late as the year 384.

Scripture. mention is made of the gospels of St Matthew, St Mark, and St John, the Acts of the Apostles, and the epistle to the Galatians; and it clearly appears from the very objections of Porphyry, that the books to which he alludes were the same which we possess at present. Thus he objects to the repetition of a generation in St Matthew's genealogy; to Matthew's call; to the quotation of a text from Isaiah, which is found in a psalm ascribed to Asaph; to the calling of the lake of Tiberias a sea; to the expression in St Matthew, "the abomination of desolation;" to the variation in Matthew and Mark upon the text "the voice of one crying in the wilderness," Matthew citing it from Isaiah, Mark from the prophets; to John's application of the term *Word*; to Christ's change of intention about going up to the feast of tabernacles (John vii. 8.); to the judgement denounced by St Peter upon Ananias and Sapphira, which he calls an imprecation of death.

The instances here alleged serve in some measure to show the nature of Porphyry's objections, and prove that Porphyry had read the gospels with that sort of attention which a writer would employ who regarded them as the depositaries of the religion which he attacked. Beside these specifications, there exists in the writings of ancient Christians general evidence, that the places of Scripture, upon which Porphyry had made remarks, were very numerous.

The internal evidence to prove the authenticity of the New Testament consists of two parts: The nature of the style, and the coincidence of the New Testament with the history of the times.

The style of the New Testament is singular, and differs very widely from the style of classical authors. It is full of Hebraisms and Syriacisms; a circumstance which pious ignorance has considered as a fault, and which, even so late as the present century, it has attempted to remove; not knowing that these very deviations from Grecian purity afford the strongest presumption in its favour: for they prove, *that the New Testament was written by men of Hebrew origin, and is therefore a production of the first century.* After the death of the first Jewish converts, few of the Jews turned preachers of the gospel; the Christians were generally ignorant of Hebrew, and consequently could not write in the style of the New Testament. After the destruction of Jerusalem and the dispersion of the Jews, their language must have been bleuded with that of other nations, and their vernacular phraseology almost entirely lost. The language of the early fathers, though not always the purest classic Greek, has no resemblance to that of the New Testament, not even excepting the works of the few who had a knowledge of the Hebrew; as Origen, Epiphanius, and Justin Martyr, who being a native of Palestine, might have written in a style similar to that of the New Testament, had such a style then prevailed. He that suspects the New Testament to be the forgery of a more recent period, ought to produce some person who has employed a similar diction; but those who are conversant with eastern writings know well that a foreigner, who has not been enured to east-

ern manners and modes of thinking from his infancy, can never imitate with success the oriental style, much less forge a history or an epistle which contains a thousand incidental allusions, which nothing but truth could suggest. To imitate closely the style of the New Testament is even more difficult than to imitate that of any other oriental book; for there is not a single author, even among the Jews themselves, since the destruction of Jerusalem, that has composed in a style in the least degree like it (z).

But though the books of the New Testament bear so close a resemblance in idiom, there is a diversity of style which shows them to be the work of different persons. Whoever reads with attention the epistles of Paul, must be convinced that they were all written by the same author. An equal degree of similarity is to be found between the gospel and 1st epistle of John. The writings of St John and St Paul exhibit marks of an original genius which no imitation can ever attain. The character of Paul as a writer is drawn with great judgement by Michaelis: "His mind overflows with sentiment, yet he never loses sight of his principal object, but hurried on by the rapidity of thought, discloses frequently in the middle a conclusion to be made only at the end. To a profound knowledge of the Old Testament he joins the acuteness of philosophical wisdom, which he displays in applying and expounding the sacred writings; and his explanations are therefore sometimes so new and unexpected, that superficial observers might be tempted to suppose them erroneous. The fire of his genius, and his inattention to style, occasion frequently a twofold obscurity, he being often too concise to be understood except by those to whom he immediately wrote, and not seldom on the other hand so full of his subject, as to produce long and difficult parentheses, and a repetition of the same word even in different senses. With a talent for irony and satire, he unites the most refined sensibility, and tempers the severity of his censures by expressions of tenderness and affection; nor does he ever forget in the vehemence of his zeal the rules of modesty and decorum. He is a writer, in short, of so singular and wonderful a composition, that it would be difficult to find a rival. That truly sensible and sagacious philosopher Locke was of the same opinion, and contended that St Paul was without an equal."

Poems have been forged and ascribed to former ages with some success. Philosophical treatises might be invented which it would be difficult to detect; but there is not a single instance on record where an attempt has been made to forge a history or a long epistle, where the fraud has not been either fully proved, or rendered so suspicious that few are weak enough to believe it. Whoever attempts to forge a history or an epistle in the name of an ancient author, will be in great danger of contradicting the history or the manners of that age, especially if he relate events which are not mentioned in general history, but such as refer to a single city, sect, religion, or school.

The difficulty of forging such histories as the gospels, and

(z) The style of Clemens Romanus may perhaps be an exception. By many eminent critics it has been thought to like to that of the epistle to the Hebrews, as to give room for the opinion that Clement either was the author of that epistle, or was the person who translated it from the Syro-Chaldaic language, in which it was originally composed.

111  
Authenticity of the New Testament proved from internal evidence.

112  
From the style.

Scripture. and such epistles as those of Paul, cannot be overcome by all the genius, learning, and industry, of any individual or society of men that ever lived. They contain a purer system of ethics than all the ancient philosophers could invent: They discover a candour and modesty unexampled: They exhibit an originality in the character of Jesus, and yet such a consistency as the imagination of our best poets has never reached. Now it is a very remarkable circumstance, that histories written by four different men should preserve such dignity and consistency, though frequently relating different actions of Jesus, and descending to the most minute circumstances in his life. The scene of action is too extensive, and the agreement of facts with the state of the times as represented by other historians is too close, to admit the possibility of forgery.

The scene of action is not confined to one country, it is successively laid in the greatest cities of the Roman empire; in Rome, in Antioch, in Corinth, in Athens, as well as in Jerusalem and the land of Palestine. Innumerable allusions are made to the manners and opinions of the Greeks, the Romans, and the Jews; and respecting the Jews, they extend even to the trifles and follies of their schools. Yet after the strictest examination, the New Testament will be found to have a wonderful coincidence and harmony with Josephus, the principal historian of these times, and an enemy of Christianity.

It has been a question who the soldiers were who are said in the gospel of Luke to have addressed John the Baptist in these words, *What shall we do?* An answer to this question may be found in Josephus\*. Herod the tetrarch of Galilee was engaged in a war with his father-in-law Aretas, a petty king in Arabia Petraea, at the very time that John was preaching in the wilderness; and the road from Galilee to Arabia running through that wilderness, the soldiers on their march had this interview with the Baptist. A coincidence like this, which has been overlooked by all the commentators, would not probably be attended to in a forgery.

Another instance of an agreement no less remarkable we shall quote from the valuable work of Michaelis. It has been a question of some difficulty among the learned, who was the Ananias who commanded St Paul to be smitten on the mouth when he was making his defence before the council in Jerusalem\*. Kretz, in his remarks taken from Josephus, has shown him to have been the son of Nebedeni. But if so, how can it be reconciled with chronology, that Ananias was, at that time, called high priest, when it is certain from Josephus that the time of his holding that office was much earlier? And how comes it to pass that St Paul says, "I will not, brethren, that he was the high priest?" The sacerdotal garb must have discovered who he was: a jest would have ill-suited the gravity of a tribunal; and a falsehood is inconsistent with the character of St Paul.

All these difficulties vanish as soon as we examine the special history of that period: "Ananias the son of Nebedeni was high priest at the time that Helena queen of Adiabene supplied the Jews with corn from Egypt, during the famine which took place in the fourth year of Claudius, mentioned in the eleventh chapter of the Acts. St Paul therefore, who took a journey to Jerusalem at that period, could not have been ignorant of

the elevation of Ananias to that dignity. Soon after the holding of the first council, as it is called, at Jerusalem, Ananias was dispossessed of his office, in consequence of certain acts of violence between the Samaritans and the Jews, and sent prisoner to Rome; but being afterwards released, he returned to Jerusalem. Now from that period he could not be called *high-priest* in the proper sense of the word, though Josephus has sometimes given him the title of *αρχιεργς*, taken in the more extensive meaning of a priest, who had a seat and voice in the Sanhedrim; and Jonathan, though we are not acquainted with the circumstances of his elevation, had been raised in the mean time to the supreme dignity in the Jewish church. Between the death of Jonathan, who was murdered by order of Felix, and the high-priesthood of Ismael, who was invested with that dignity by Agrippa, elapsed an interval during which the sacerdotal office was vacant. Now it happened precisely in this interval that St Paul was apprehended in Jerusalem: and, the Sanhedrim being destitute of a president, he undertook of his own authority the discharge of that office, which he executed with the greatest tyranny. It is possible therefore that St Paul, who had been only a few days in Jerusalem, might be ignorant that Ananias, who had been dispossessed of the priest-hood, had taken upon himself a trust to which he was not intitled; he might therefore very naturally exclaim, "I will not, brethren, that he was the high-priest!" Admitting him on the other hand to have been acquainted with the fact, the expression must be considered as an indirect reproach, and a tacit refusal to recognize usurped authority."

Could such a correspondence as this subsist between truth and falsehood, between a forgery and an authentic history? or is it credible that these events could be related by any person but a contemporary?

Impressed with the love of truth, and feeling contempt as well as detestation at pious frauds, we hesitate not to acknowledge, that in some particular facts there is a difference either real or apparent between Josephus and the writers of the New Testament. The objections arising from these differences are of two kinds: 1. Such as would prove a book not to have been written by the author to whom it is ascribed. 2. Such as

would prove that the author was mistaken, and therefore not divinely inspired. To the first class belongs the following objection: St Paul says (2 Cor. xi. 32.) that the governor of Damascus was under Aretas the king: but if we are to judge from the 18th book of the Jewish Antiquities, which corresponds with the period of St Paul's journey to Damascus, this city must have belonged at that time to the Romans; and what authority could Aretas, a petty king in Arabia Petraea, have in such a city? In answer to this question, J. G. Hyne, in a dissertation published in 1755, has shown it to be highly probable that Aretas, against whom the Romans, not long before the death of Tiberius, made a declaration of war, which they neglected to put in execution, took the opportunity of seizing Damascus, which had once belonged to his ancestors; an event omitted by Josephus, as forming no part of the Jewish history, and by the Roman historians as being a matter not flattering in itself, and belonging only to a distant province. Secondly, That Aretas was by religion a Jew; a circumstance the more credible, when we reflect that

Judaism

Scripture.

114

There are also apparent inconsistencies, but these probably arise from oversight in Josephus;

Scripture. Judaism had been widely propagated in that country, and that even kings in Arabia Felix had recognized the Law of Moses. The difficulty then is so far removed, that it ceases to create suspicion against an epistle which has so many evident marks of authenticity; and it is only to be regretted that, in order to place the subject in the clearest point of view, we are not sufficiently acquainted with the particular history of Damascus.

115  
Or to his want of authentic information concerning the events that happened near his birth.

Examples of the second kind are such as, if allowed their full force, might indeed prove a writer not divinely inspired, but could afford no reason to conclude that he was not the author of the writings which bear his name, since mistakes may be committed by the most accurate historian. The chief difficulties of this nature are found in the gospel according to St Luke, and do not apply to the writings of Matthew, John, Paul, and Peter. Laying aside the idea of inspiration altogether, let us inquire whether Luke or Josephus be most intitled to credit in those passages where they differ; which of them is most accurate, and which of them had the best opportunities of exploring the truth of the facts which they relate. - Now Josephus relates the same story differently in different parts of his works, and is sometimes equally mistaken in them all. We do not recollect to have seen such inconsistencies in the writings of St Luke. Luke knew the characters, and witnessed many of the facts, of which he speaks; and he could receive the best information respecting those facts which were transacted in his absence. Josephus was born A. D. 37, some years after our Saviour's ascension. Now it is a very important observation of Michaelis, that the period of history with which mankind are least acquainted is that which includes the time of their childhood and youth, together with the twenty or thirty years immediately preceding their birth. Concerning the affairs transacted during that period, we are much more liable to fall into mistakes than concerning those of a remoter age. The reason is, that authentic history never comes down to the period of our birth; our knowledge of the period immediately preceding depends on hearsay; and the events, which pass within the first eighteen or twenty years of our lives, we are too young and heedless to observe with attention. This must have been more remarkably the case in the time of Josephus than at present, when there were neither daily papers nor periodical journals to supply the want of regular annals. There was no historian from whom Josephus could derive any knowledge of the times that immediately preceded his birth. There is a period then of forty or fifty years, in which, even with the most diligent inquiry, he was exposed to error.

When we find therefore the relations of Luke and Josephus so different as not to be reconciled, it would be very unfair to determine without any further inquiry in favour of Josephus. Let their character, and works, and situation, be strictly examined; let their testimony be duly weighed and compared; and then let the preference be given to that author who, according to the strictest rules of equity and justice, seems intitled to the highest degree of credit. The decision of a jury, we shall venture to say, would in every instance turn out in favour of Luke.

Having thus ascertained the authenticity of the books of the New Testament, the next thing to be considered

is their inspiration. It is certainly of some importance to know how far the apostles and evangelists were guided in their writings by the immediate influence of the Spirit of God; though this knowledge, if attainable, is not equally important with that of the authenticity of these writings. Michaelis indeed asserts, that the divinity of the New Testament may be proved whether we can evince it to be written by immediate inspiration or not. "The question (says he), whether the books of the New Testament are inspired? is not so important as the question, whether they are genuine? The truth of our religion depends upon the latter, not absolutely on the former. Had the Deity inspired not a single book of the New Testament, but left the apostles and evangelists without any other aid than that of natural abilities to commit what they knew to writing, admitting their works to be authentic, and possessed of a sufficient degree of credibility, the Christian religion would still be well founded. The miracles by which it is confirmed would equally demonstrate its truth, even if the persons who attested them were not inspired, but simply human witnesses; and their divine authority is never presupposed, when we discuss the question of miracles, but merely their credibility as human evidence. If the miracles are true which the evangelists relate, the doctrines of Christ recorded in the gospels are proved to be the infallible oracles of God; and, even if we admit the apostles to be mistaken in certain not essential circumstances, yet as the main points of the religion which Christ commissioned them to preach are so frequently repeated, their epistles would instruct us as well in the tenets of the Christian system, as the works of Maclaurin in the philosophy of Newton. It is possible therefore to doubt, and even deny, the inspiration of the New Testament, and yet be fully persuaded of the truth of the Christian religion: and many really entertain these sentiments either publicly or in private, to whom we should render great injustice, if we ranked them in the class of unbelievers.

"Yet the Christian religion would be attended with difficulty, if our *principium cognoscendi* rested not on firmer ground; and it might be objected, that sufficient care had not been taken for those whose consciences were tender, and who were anxiously fearful of mistaking the smallest of the divine commands. The chief articles indeed of Christianity are so frequently repeated, both by Christ and his apostles, that even were the New Testament not inspired, we could entertain no doubt of the following doctrines: 'Jesus was the Messiah of the Jews, and an infallible messenger of God: he died for our iniquity; and by the satisfaction made by his death we obtain remission of sins, if on our part be faith and amendment of life: the Levitical law is abolished, and moral precepts, with the ceremonies of Baptism and the Supper of the Lord, are appointed in its stead: after the present follows an everlasting life, in which the virtuous shall be rewarded and the wicked punished, and where Christ himself shall be the Judge.'

"To the epistles indeed (says Michaelis), inspiration is of real consequence; but with respect to the historical books, viz. the Gospels and the Acts of the Apostles, we should really be no losers if we abandoned the system of inspiration, and in some respects have a real advantage. We should be no losers, if we considered the apostles in historical facts as merely human witnesses,

Scripture  
116  
Inspiration  
of the New  
Testament

Chap. I  
§ 1.

117  
Not necessary to the truth of Christianity according to the opinion of Michaelis



Scripture. as Christ himself has done in saying, 'Ye also shall bear witness, because ye have been with me from the beginning \*.' And no one that attempts to convince an unbeliever of the truth of Christianity, would begin his demonstration by presupposing a doctrine which his adversary denies, but would ground his arguments on the credibility of the evangelists as human historians, for the truth of the miracles, the death, and the resurrection of Christ. Even those who examine the grounds of their faith for their own private conviction, must treat the evangelists as human evidence; since it would be arguing in a circle to conclude that the facts recorded in the gospels are true, because they are inspired, when we conclude the Scriptures to be inspired in consequence of their contents. In these cases, then, we are obliged to consider the evangelists as human evidence; and it would be no detriment to the Christian cause to consider them at all times as such in matters of historical fact. We find it nowhere expressly recorded that the public transactions which the apostles knew by their own experience, and of which St Luke informed himself by diligent inquiry, should be particular objects of divine inspiration. We should even be considerable gainers, in adjusting the harmony of the gospels, if we were permitted to suppose that some one of the evangelists had committed an immaterial error, and that St John has rectified some trifling mistakes in the preceding gospels. The most dangerous objections which can be made to the truth of our religion, and such as are most difficult to answer, are those drawn from the different relations of the four evangelists."

118  
Different meaning of the word inspiration.

Before any inquiry is made respecting the inspiration of the books of the New Testament, it is necessary to determine the meaning of the term; for theologians have given to it a variety of significations. Most of the German divines make it to consist in an infusion of words as well as ideas. Luther, Beza, and Salmasius, restrict it to ideas alone. Doddridge understands by it an intervention of the Deity, by which the natural faculties of the mind were directed to the discovery of truth. Warburton and Law think it was a negative intervention to preserve the sacred writers from essential errors. Some believe every circumstance was dictated by the Holy Ghost; others suppose that no supernatural assistance was granted except in the epistolary writings. See INSPIRATION.

As there is an evident distinction between inspiration and revelation, and as the origin of the Christian religion may be still proved divine, even though it were denied that those who record its facts and doctrines were inspired, in the act of writing, it will be most judicious and safe to employ the word *inspiration* in that sense which can be most easily defended and supported. By doing this much may be gained and nothing lost. It is difficult to prove to a deist that the words of Scripture are divine, because he sees that every writer has words and phrases peculiar to himself. It is difficult also to prove that the ideas were infused into the mind of the authors while they were engaged in the act of writing; because concerning facts they appeal not to divine inspiration, but declare *what they have seen and heard*. In reasoning they add their own sentiments to what they had received from the Lord, and subjoin, especially in their epistles, things not connected with religion. The definition which Doddridge gives, seems

VOL. XVII. Part I.

applicable to ordinary gifts or the usual endowments of rational creatures, rather than to the extraordinary gifts of the Holy Spirit, which were bestowed on the apostles. Those who maintain that every fact or circumstance was suggested by divine inspiration, will find it no easy matter to prove their position. The opinion of Warburton and Law, with proper explanations, seems most probable. The opinion of Grotius, that only the epistles were inspired, may be easily refuted.

The proof of the authenticity of the New Testament depends on human testimony: The proof of its inspiration is derived from the declaration of inspired persons.

In proving that the New Testament is inspired, we presuppose its authenticity that the sacred books were written by the apostles whose names they bear, and that they have been conveyed to us pure and uncorrupted. This we have already attempted to prove, and we hope with success. The evidence of inspiration is the testimony of Christ and his apostles, which we receive as credible, because they confirmed their doctrines by miracles. From the important mission of Christ and his apostles, we infer that every power was bestowed which divine wisdom thought expedient; and from their conduct we conclude, that it is morally impossible that they could lay claim to any powers which they did not possess. It is proper therefore to inquire into the declarations of Christ and his apostles concerning the nature, degree, and extent, of the inspiration bestowed upon the writers of the sacred books.

If we consider Christ's more immediate promises of inspiration to the apostles, we shall find that he has given them, in the most proper sense of the word, at three several periods, 1st, When he sent the apostles to preach the gospel †; 2dly, In holding a public discourse relating to the gospel, at which were present a considerable multitude; 3dly, In his prophecy of the destruction of Jerusalem †. When he sent the apostles to preach the gospel, he thus addressed them: "When they deliver you up, take no thought how or what ye shall speak, for it shall be given you in that same hour what ye shall speak; for it is not you that speak, but the spirit of your Father that speaketh in you." The same promise was made almost in the same words in the presence of an immense multitude (Luke xii. 11, 12.) From these passages it has been urged, that if the apostles were to be inspired in the presence of magistrates in delivering speeches, which were soon to be forgotten, it is surely reasonable to conclude that they would be inspired when they were to compose a standard of faith for the use of all future generations of Christians. If this conclusion be fairly deduced, it would follow that the writings of the New Testament are the dictates of inspiration, not only in the doctrines and precepts, but in the very words. But it is a conclusion to which sincere Christians have made objections; for, say they, though Christ promises to assist his apostles in cases of great emergency, where their own prudence and fortitude could not be sufficient, it does not follow that he would dictate to them those facts which they knew already, or those reasonings which their own calm reflection might supply. Besides, say they, if the New Testament was dictated by the Holy Spirit, and only penned by the apostles, what reason can be given for the care with which Christ instructed them both during his

119

The proof of it depends on the declaration of Christ and his apostles.

120

The declaration of Christ.

† Matt x. 19. 20.

† Mark xiii. 11.; Luke xxi. 14, 15.

T

ministry

*Scripture.* mainly and after his crucifixion in those things pertaining to the kingdom of God?

*121*  
*Proper idea of inspiration.*  
*122*  
*John iv 26, 26.*  
In answer to this, we may observe, that though it be difficult to prove that the identical words of the New Testament were dictated by the Holy Spirit, or the train of ideas infused into the minds of the sacred writers, there is one species of inspiration to which the New Testament has an undoubted claim. It is this, that the memories of the apostles were strengthened and their understandings preserved from falling into essential errors. This we prove from these words of our Saviour, "and I will pray the Father, and he will give you another comforter, that he may abide with you for ever. He shall teach you all things, and bring all things to your remembrance whatsoever I have said unto you." This promise was surely not restrained to the day of Pentecost: it must have been a permanent gift enabling the apostles at all times to remember with accuracy the discourses of our Saviour. When the apostles therefore (Matthew and John) relate those precepts of Christ which they themselves had heard, they write indeed from memory, but under the protection of the spirit who secures them from the danger of mistake: and we must of course conclude that their gospels are inspired.

Were we called upon more particularly to declare what parts of the New Testament we believe to be inspired, we would answer, The doctrines, the precepts, and the prophecies, every thing essential to the Christian religion. From these the idea of inspiration is inseparable. As to the events, the memory of the apostles was sufficient to retain them. If this opinion be just, it would enable us to account for the discrepancies between the sacred writers, which are chiefly confined to the relation of facts and events.

All the books of the New Testament were originally written in Greek, except the gospel according to Matthew and the epistle to the Hebrews, which there is reason to believe were composed in the Syro-Chaldaic language, which in the New Testament is called Hebrew.

Various reasons have been assigned why the greatest part of the New Testament was written in Greek; but the true reason is this, It was the language best understood both by writers and readers. Had St Paul written to a community in the Roman province of Africa, he might have written perhaps in Latin; but epistles to the inhabitants of Corinth, Galatia, Ephesus, Philippi, and Thessalonica, to Timothy, Titus, and Philemon, from a native of Tarsus, could hardly be expected in any other language than Greek. The same may be said of the epistles of St Peter, which are addressed to the Christians of different countries, who had no other language in common than the Greek; and likewise of the epistles of St James, who wrote to Jews, that lived at a distance from Palestine, and were ignorant of Hebrew. The native language of St Luke, as well as of Theophilus, to whom he addressed his gospel, and Acts of the apostles, appears to have been Greek; and that St John wrote his gospel in that language, and not in Hebrew, is by no means a matter of surprise, since he wrote at Ephesus.

With respect to the epistle to the Romans, it may be asked indeed why St Paul did not write in Latin? Now, whoever proposes this question, must presuppose that St Paul was master of the Latin language in such a degree as to find no difficulty in writing it; a matter

*Scripture.* which remains to be proved. It is very probable that St Paul was acquainted with the Latin; but between understanding a language, and being able to write it, there is a very material difference. As St Paul was a native of Tarsus, his native language was Greek; he had travelled during several years through countries in which no other language was spoken, and when he addressed the Roman centurion at Jerusalem, he spoke not Latin, but Greek. Is it extraordinary, then, that in writing to the inhabitants of Rome he should have used a language which was there so generally understood? It has been long remarked, that Greek was at that time as well known in Rome as French in any court of modern Europe: that according to Juvenal even the female sex made use of Greek as the language of familiarity and passion; and that in letters of friendship Greek words and phrases were introduced with greater freedom than French expressions in German letters, as appears from Cicero's epistles to Atticus, and from those of Augustus preserved in the works of Suetonius. To this must be added a material circumstance, that a great part of the Roman Christians consisted of native Jews, who were better acquainted with Greek than with Latin, as either they themselves or their ancestors had come from Greece, Asia Minor, or Egypt, in which Greek was the language of the country. At least they read the bible in that language, as no Latin translation of the Old Testament at that time existed; and the Christian church at that period consisting chiefly of Jews, the heathen converts in Rome were of course under the necessity of accustoming themselves to the Greek language. In short, St Paul in his epistle to the Romans made use of a language in which alone those who were ignorant of Hebrew could read the bible. What has been here advanced respecting the epistle to the Romans is equally applicable to the Greek of St Mark, on the supposition that it was written at Rome.

To the above arguments may be added the example of Josephus, who, as well as the Apostles, was by birth a Jew. He even lived in Rome, which is more than can be said of St Paul and St Mark, who resided there only a certain time: he was likewise younger than either; he came to Italy at an age which is highly suitable to the learning of a language, and previous to that period had spent several years in the Roman camp. The Jewish antiquities, the history of the Jewish war, and the account of his own life, he wrote undoubtedly with a view of their being read by the Romans; and yet he composed all these writings in Greek. He expresses his motive for writing his Greek account of the Jewish war in the following terms: "That having written in his native language (*i. e.* the Hebrew dialect at that time spoken) a history of the war, in order that Parthians, Babylonians, Arabians, Adiabenes, and the Jews beyond the Euphrates, might be informed of those events, he was now resolved to write for the Greeks and Romans, who had not been engaged in the campaigns, a more certain account than had hitherto been given." The motives which induced Josephus to write in Greek are fully as applicable to St Paul and St Mark.

Michaëlis has thus characterized the style of the New Testament. "The New Testament (says he) was written in a language at that time common among the Jews, p. 111.

*123*  
Language in which the New Testament was composed.

*123*  
Why the greater part of it written in Greek.

*Michaëlis*,  
vol. 1. chap.  
4. sect. 1.  
p. 101.

*Michaëlis*,  
vol. 1.  
chap. 4.  
sect. 3.  
p. 111.

Scripture. Jews, which may be named Hebraic Greek; the first traces of which we find in the translation of the LXX.

<sup>124</sup> Every man acquainted with the Greek language, who had never heard of the New Testament, must immediately perceive, on reading only a few lines, that the style is widely different from that of the classic authors. We find this character in all the books of the New Testament in a greater or less degree, but we must not therefore conclude that they possess an uniformity of style. The hardest Hebraisms, which extend even to grammatical errors in the government of cases, are the distinguishing marks of the book of Revelation; but they are accompanied with tokens of genius and poetical enthusiasm, of which every reader must be sensible who has taste and feeling. There is no translation of it which is not read with pleasure even in the days of childhood; and the very faults of grammar are so happily placed as to produce an agreeable effect. The gospels of St Matthew and St Mark have strong marks of this Hebraic style; the former has harsher Hebraisms than the latter, the fault of which may be ascribed to the Greek translator, who has made too literal a version, and yet the gospel of St Mark is written in worse language, and in a manner that is less agreeable. The epistles of St James and St Jude are somewhat better; but even these are full of Hebraisms, and betray in other respects a certain Hebrew tone. St Luke has in several passages written pure and classic Greek, of which the four first verses of his gospel may be given as an instance: in the sequel, where he describes the actions of Christ, he has very harsh Hebraisms, yet the style is more agreeable than that of St Matthew or St Mark. In the Acts of the apostles he is not free from Hebraisms, which he seems to have never studiously avoided; but his periods are more classically turned, and sometimes possess beauty devoid of art. St John has numerous, though not uncouth, Hebraisms both in his gospel and epistles; but he has written in a smooth and flowing language, and surpasses all the Jewish writers in the excellence of narrative. St Paul again is entirely different from them all; his style is indeed neglected and full of Hebraisms, but he has avoided the concise and verse-like construction of the Hebrew language, and has upon the whole a considerable share of the roundness of Grecian composition. It is evident that he was as perfectly acquainted with the Greek manner of expression as with the Hebrew, and he has introduced them alternately, as either the one or the other suggested itself the first, or was the best approved."

<sup>125</sup> Michaelis has shown that the New Testament not only contains Hebraisms but Rabbinisms, Syriacisms, Chaldaisms, Arabisms, Latinisms, and Persian words, of which he has exhibited many specimens. To theologians, whose duty it certainly is to study the language of the New Testament with attention, we would strenuously recommend the perusal of this work, which in the English translation is one of the most valuable accessions to scriptural criticism that has yet appeared. We speak of the English translation, which the large and judicious notes of Mr Marsh has rendered infinitely superior to the original.

<sup>126</sup> To the observations which have been made respecting the language of the New Testament, a few remarks may be added concerning the peculiarities of the style

and manner of the sacred writers, particularly the historians. These remarks extend to the Old Testament as well as to the New.— The principal quality for which the sacred history is remarkable is simplicity in the structure of the sentences. The first five verses of Genesis furnish an example, which consist of eleven sentences. The substantives are not attended by adjectives, nor the verbs by adverbs, no synonyms, no superlatives, no effort at expressing things in a bold, emphatical, or uncommon manner.

2. The second quality is simplicity of sentiment, particularly in the Pentateuch, arising from the very nature of the early and uncultivated state of society about which that book is conversant.

3. Simplicity of design. The subject of the narrative so engrosses the attention of the writer, that he himself is as nobody. He introduces nothing as from himself, no remarks, doubts, conjectures, or reasonings. Our Lord's biographers particularly excel in this quality. This quality of style we meet with in Xenophon and Cæsar.

The Evangelists may be ranked next to Genesis for simplicity of composition in the sentences. John and Matthew are distinguished for it more than Mark and Luke. But the sentiment is not so remarkable for simplicity in the Evangelist as the Pentateuch. The reasons of this difference are, the state of the Jews was totally changed; their manners, customs, &c. split into factions both in religion and politics. 2. The object of our Lord's ministry, which is the great subject of the gospels, was to *inculcate a doctrine and morality* with which none of their systems perfectly coincided: besides, being constantly opposed by all the great men, the greater part of his history consists of instructions and disputes. 3. As it is occupied with what our Saviour said and what he did, this makes two distinctions of style and manner; that of our Saviour, and the sacred penman's. In their own character, they neither explain nor command, promise nor threaten, praise nor blame. They generally omit the names of our Lord's enemies; thus directing our hatred at the vices they committed, not at the persons. They never mention such persons without necessity; which is the case with the high-priest, Pilate, Herod, and Judas: the three first for the chronology, the fourth to do justice to the eleven.

Herodias is indeed mentioned with dishonour, but her crime was a public one. On the other hand, all persons distinguished for any thing virtuous are carefully mentioned, Joseph of Arimathea, Nicodemus, Zaccheus, Bartimeus, Jairus, Lazarus, Mary, and Martha. They record their own faults (Peter's, Thomas's), nor do they make any merit of their confession. In one uniform strain they relate the most signal miracles and most ordinary facts.

From the narrative is excluded that quality of style which is called *animation*. Nothing that discovers passion in the writer or is calculated to excite the passions of the reader. Every thing is directed to mend the heart.

But in the discourses and dialogues of our Saviour the expression, without losing any thing of its simplicity, is often remarkable for spirit and energy. Respecting harmony and imitations, quantities which only add an external polish to language, they had not the least solicitude

Scripture.  
De Camp-  
on's Preli-  
minary  
Dissertations  
to his Trans-  
lation of  
the Gospel.

Scripture

As to elegance, there is an elegance which results from the use of such words as are most in use with those who are accounted fine writers, and from such arrangements in the words and clauses as have generally obtained their approbation. This is disclaimed by the sacred authors.

But there is an elegance of a superior order more nearly connected with the sentiment; and in this sort of elegance they are not deficient. In all the oriental languages great use is made of tropes, especially metaphors. When the metaphors employed bear a strong resemblance, they confer vivacity: if they be borrowed from objects which are naturally agreeable, beautiful, or attractive, they add also elegance. The Evangelists furnish us with many examples of this kind of vivacity and elegance. Our Lord borrows tropes from cornfields, vineyards, gardens, &c.

127  
Proper method of studying the New Testament by analysis and induction.

As a valuable appendage to this part of our subject, we shall subjoin Dr Campbell's method of studying the books of the New Testament. This we offer to our readers as a beautiful instance of the judicious application of philosophy to sacred studies. It is the same method of discovering truth by analysis and induction, which was pursued by Sir Isaac Newton with such astonishing success, which since his time has been uniformly practised in natural philosophy, and has been also applied to chemistry, to medicine, to natural history, and to the philosophy of mind, by the ingenious Dr Reid. This is the path of sound philosophy, which can alone lead to the discovery of truth. In following it, our progress may be slow, but it will be sure. If all theologians would steadily adhere to it, we might then entertain the pleasant hope of discarding for ever those absurd systems of religion which are founded on single passages and detached fragments of scripture, and of establishing opinions and doctrines on a solid foundation.

128  
Dr Campbell's method. Prel. Diss. to the Cor. Epist.

"1. To get acquainted with each writer's style; to observe his manner of composition, both in sentences and paragraphs; to remark the words and phrases peculiar to him, and the peculiar application that he may sometimes make of ordinary words; for there are few of those writers who have not their peculiarities in all the respects now mentioned. This acquaintance with each can be attained only by the frequent and attentive reading of his works in his own language.

"2. To inquire into the character, the situation, and the office of the writer, the time, the place, and the occasion of his writing, and the people for whose immediate use he originally intended his work. Every one of these particulars will sometimes serve to elucidate expressions otherwise obscure or doubtful. This knowledge may in part be learned from a diligent and reiterated perusal of the book itself, and in part be gathered from what authentic, or at least probable, accounts have been transmitted to us concerning the complement of the canon.

"3. The last general direction is, to consider the principal scope of the book, and the particulars chiefly observable in the method by which the writer has purposed to execute his design. This direction is particularly applicable to the epistolary writings, especially those of Paul.

"4. If a particular word or phrase occur, which appears obscure, perhaps unintelligible, the first thing we ought to do, if satisfied that the reading is genuine, is

Scriptures.

to consult the context, to attend to the manner wherein the term is introduced, whether in a chain of reasoning or in a historical narration, in a description, or included in an exhortation or command. As the conclusion is inferred from the premises, or as from two or more known truths a third unknown or unobserved before may fairly be deduced; so from such attention to the sentence in connection, the import of an expression, in itself obscure or ambiguous, will sometimes with moral certainty be discovered. This, however, will not always answer.

"5. If it do not, let the second consideration be, whether the term or phrase be one of the writer's peculiarities. If so, it comes naturally to be inquired, what is the acceptation in which he employs it in other places? If the sense cannot be precisely the same in the passage under review, perhaps, by an easy and natural metaphor or other trope, the common acceptation may give rise to one which perfectly suits the passage in question.—Recourse to the other places wherein the word or phrase occurs in the same author is of considerable use, though the term should not be peculiar to him.

"6. But thirdly, if there should be nothing in the same writer that can enlighten the place, let recourse be had to the parallel passages, if there be any such, in the other sacred writers. By parallel passages, I mean those places, if the difficulty occur in history, wherein the same or a similar story, miracle, or event, is related; if in teaching or reasoning, those parts wherein the same argument or doctrine is treated, or the same parable propounded; and in moral lessons, those wherein the same class of duties is recommended; or, if the difficulty be found in a quotation from the Old Testament, let the parallel passage in the book referred to, both in the original Hebrew, and in the Greek version, be consulted.

"7. But if in these there be found nothing that can throw light on the expression of which we are in doubt, the fourth recourse is to all the places wherein the word or phrase occurs in the New Testament, and in the Septuagint version of the Old, adding to these the consideration of the import of the Hebrew or Chaldaic word, whose place it occupies, and the extent of signification, of which in different occurrences such Hebrew or Chaldaic term is susceptible.

"8. Perhaps the term in question is one of those which very rarely occur in the New Testament, or those called *ἄσπερα λεγόμενα*, only once read in Scripture, and not found at all in the translation of the Seventy. Several such words there are. There is then a necessity, in the fifth place, for recurring to the ordinary acceptation of the term in classical authors. This is one of those cases wherein the interpretation given by the earliest Greek fathers deserves particular notice. In this, however, I limit myself to those comments wherein they give a literal exposition of the sacred text, and do not run into vision and allegory."

The manuscripts of the New Testament are the natural source from which the genuine readings of the Greek Testament are to be drawn. The printed editions are either copies of more ancient editions, or of manuscripts; and they have no further authority than as they correspond to the manuscripts from which they were originally taken. By manuscripts of the New Testament, we mean those only which were written before  
the

129  
Manuscript of the New Testament.

the invention of printing. The most ancient of these are lost, and there is no manuscript now extant older than the sixth century. Few contain the whole New Testament; some contain the four gospels; some the Acts of the Apostles and Epistles; and others the book of Revelation. The greatest number are those which contain the first part; those which have the second, or the first and second together, are likewise numerous; but those of the third are extremely few. It must be added also, that in many manuscripts those epistles are omitted whose divine authority was formerly doubted.

There are many manuscripts which have been examined only for a single text, such as 1 John v. 7. or at least for a very small number. Others have been examined from the beginning to the end, but not completely, and in respect of all the readings. A third class consists of such as either have been, or are said to have been, completely and accurately collated. But this requires such phlegmatic patience, that we can hardly expect to find in critical catalogues all the various readings which have been only once collated. Wetstein, in collating many manuscripts anew, made discoveries which had entirely escaped the notice of his predecessors. The fourth class consists of such as have been completely and accurately collated more than once; but here also we are in danger of being led into error.—When various readings are transferred from one critical edition to another, as from that of Gregory to Mill's edition, and from the latter to those of Bengel and Wetstein, the manuscripts must sometimes be falsely named, and various readings must frequently be omitted. And as Wetstein has marked by ciphers manuscripts that in former editions had been denoted by their initial letters, he could hardly avoid substituting, in some cases, one figure instead of another. The fifth class, which is by far the most valuable, consists of such as have been printed word for word, and therefore form an original edition of the Greek Testament. We can boast but of a very few manuscripts of this kind. Hearne printed at Oxford, in 1715, the Acts of the Apostles in Greek and Latin from the Codex Laudianus 3.; Knittel has annexed to his edition of Ulphilas, p. 53—118, a copy of two very ancient fragments preserved in the library of Wolfenbüttele; the one of the four Gospels in general, the other of St Luke and St John. Woide printed in 1786 the Codex Alexandrinus, a manuscript of great antiquity, which shall afterwards be more fully described; and the University of Cambridge has resolved to publish, in a similar manner, the Cod. Cant. I. or, as it is sometimes called, the Codex Bezae, the care of which is intrusted to Dr Kipling, a publication which will be thankfully received by every friend to sacred criticism. It was the intention of the Abbé Spoletti, a few years ago, to publish the whole of the celebrated Codex Vaticanus; which would likewise have been a most valuable accession, since a more important manuscript is hardly to be found in all Europe. He delivered for this purpose a memorial to the Pope; but the design was not put into execution, either because the Pope refused his assent, or the Abbé abandoned it himself. See the Oriental Bible, vol. xxii. n<sup>o</sup> 333. and vol. xxiii. n<sup>o</sup> 348.

“A very valuable library,” says Michaelis, “might be composed of the impressions of ancient manuscripts,

which, though too expensive for a private person, should be admitted into every university collection, especially the Alexandrine and Cambridge manuscripts, to which I would add, if it were now possible to procure it, Hearne's edition of the Codex Laudianus 3. A plan of this sort could be executed only in England, by a private subscription, where a zeal is frequently displayed in literary undertakings that is unknown in other countries; and it were to be wished that the project were begun before length of time has rendered the manuscripts illegible, and the attempt therefore fruitless. Ten thousand pounds would go a great way toward the fulfilling of this request, if the learned themselves did not augment the difficulty of the undertaking, by adding their own critical remarks, and endeavouring thereby to recommend their publications, rather than by presenting to the public a faithful copy of the original. Should posterity be put in possession of faithful impressions of important manuscripts, an acquisition which would render the highest service to sacred criticism, all these editions of the New Testament should be regulated on the same plan as Hearne's edition of the Acts of the Apostles.” It must be highly flattering to the patriotic spirit of an Englishman to hear the encomiums which learned foreigners have so profusely bestowed on our liberality in supporting works of genius and learning and public utility. The plan which Michaelis proposes to us, in preference to all the other nations in Europe, is noble and magnificent, and would certainly confer immortality on those men who would give it their patronage and assistance.

There are many ancient manuscripts, especially in Italy, which have never been collated, but lie still unexplored. Here is a field where much remains to be done. See Marsh's Notes to Michaelis, vol. ii. p. 643.

Michaelis has given a catalogue of ancient manuscripts, amounting in number to 292, to which he has added a short account of each. In this place we shall confine our observations to the most celebrated, the Alexandrian and Vatican manuscripts, which we have chiefly extracted from Michaelis.

The *Alexandrine manuscript* consists of four volumes; the three first of which contain the Old Testament, the fourth the New Testament, together with the first Epistle of Clement to the Corinthians, and a fragment of the second. In the New Testament, which alone is the object of our present inquiry, is wanting the beginning as far as Matthew xxv. 6. *ο τουτων ενδεχεται*, likewise from John vi. 50. to viii. 52. and from 2 Cor. iv. 13. to xii. 7. It must likewise be observed, that the Psalms are preceded by the epistle of Athanasius to Marcellinus, and followed by a catalogue, containing those which are to be used in prayer for each hour, both of the day and of the night; also by 14 hymns, partly apocryphal, partly biblical, the 11th of which is an hymn in praise of the Virgin Mary, entitled *αποστουχη μαριας της θεοτοκου*; further, the *Hypotheses Eusebii* are annexed to the Psalms, and his *Canones* to the Gospels. It is true, that this has no immediate reference to the New Testament, but may have influence in determining the antiquity of the manuscript itself.

It has neither accents nor marks of aspiration; it is written with capital, or, as they are called, *uncial letters*, and

Scripture.

130  
Michaelis's  
proposal  
of taking an  
impression  
of ancient  
manu-  
scripts,  
Vol. ii.  
p. 131.

131  
Account of  
the Alexan-  
drine ma-  
nuscript.

and has very few abbreviations. There are no intervals between the words; but the sense of a passage is sometimes terminated by a point, and sometimes by a vacant space. Here arises a suspicion that the copyist did not understand Greek, because these marks are sometimes found even in the middle of a word, for instance Levit. v. 4. *αριμος* η for *αριμωσ*, and Num. xiii. 29. *ωσ Τρις*.

This manuscript was presented to Charles I. in 1628, by Cyrillus Lucaris patriarch of Constantinople. Cyrillus himself has given the following account: "We know so much of this manuscript of the holy writings of the Old and New Testament, that Thecla an Egyptian lady of distinction (*nobilis femina Egyptia*) wrote it with her own hand 1300 years ago (A). She lived soon after the council of Nicæa. Her name was formerly at the end of the book; but when Christianity was subverted in Egypt by the errors of Mahomet, the books of the Christians suffered the same fate, and the name of Thecla was expunged. But oral tradition of no very ancient date (*memoria et traditio recens*) has preserved the remembrance of it."

But the reader will see that this account is merely traditional. Dr Semler very properly observes, that there is no more reason to rely on a tradition respecting the transcriber of an ancient manuscript, than on a tradition which relates to an ancient relic. The arguments which have been urged by Wetstein, Semler, Oudin, and Woide, to fix the date of this manuscript, are so many, that it would be tedious to repeat them. But, after all, its antiquity cannot be determined with certainty, though it appears from the formation of the letters, which resemble those of the fourth and fifth centuries, and the want of accents, that it was not written so late as the tenth century. In this century it was placed by Oudin, while Grabe and Schulze have referred it to the fourth, which is the very utmost period that can be allowed, because it contains the epistles of Athanasius. Wetstein, with more probability, has chosen a mean between these two extremes, and referred it to the fifth century: but we are not justified in drawing this inference from the formation of the letters alone, for it is well known that the same mode of forming the letters was retained longer in some countries and in some monasteries than in others.

We are now in possession of a perfect impression of this manuscript, which is accompanied with so complete and so critical a collection of various readings, as is hardly to be expected from the edition of any other manuscript. Dr Woide published it in 1786, with types cast for that purpose, line for line, without intervals between the words, as in the manuscript itself;

the copy is so perfect a resemblance of the original, that it may supply its place. Its title is *Novum Testamentum Græcum e codicis MS. Alexandrino qui Londini in Bibliotheca Musæi Britannici asservatur descriptum*. It is a very splendid folio; and the preface of the learned editor contains an accurate description of the manuscript, with an exact list of all its various readings, that takes up no less than 89 pages; and each reading is accompanied with a remark, in which is given an account of what his predecessors Juninus, Walton, Fell, Mill, Grabe, and Wetstein, had performed or neglected.

The *Vatican manuscript* contained originally the whole Greek Bible, including both the Old and New Testament; and in this respect, as well as in regard to its antiquity, it resembles none so much as the *Codex Alexandrinus*, but no two manuscripts are more dissimilar in their readings, in the New Testament as well as in the Old. After the Gospels, which are placed in the usual order, come the Acts of the Apostles, which are immediately followed by the seven catholic epistles. This must be particularly noted, because some have contended that the second Epistle of St Peter, with the second and third of St John, were wanting. Professor Huid, in a letter dated Rome, April 12. 1781, assured Michaelis that he had seen them with his own eyes, that the second Epistle of St Peter is placed folio 1434, the second of St John fol. 1442, the third folio 1443: then follow the Epistles of St Paul, but not in the usual order; for the Epistle to the Hebrews is placed immediately after those to the Thessalonians: and it is not improbable, that in the more ancient manuscript, from which the *Codex Vaticanus* was copied, this Epistle was even placed before that to the Ephesians, and immediately after the Epistle to the Galatians (B); for the Epistles of St Paul are divided into 93 sections by figures written in the margin with red ink; but the Epistle to the Galatians ends with 59, and that to the Ephesians begins with 70; the Epistle to the Hebrews, on the contrary, begins with 60, and ends with 69. With the words *αμεμων τρις δις*, Heb. ix. 14. the manuscript ceases, the remaining leaves being lost. There is wanting, therefore, not only the latter part of this Epistle, but the Epistles to Timothy, Titus, and Philemon, with the Revelation of St John: but this last book, as well as the latter part of the Epistle to the Hebrews, has been supplied by a modern hand in the 15th century. In many places the faded letters have been also retouched by a modern, but careful hand; and when the person who made these amendments, who appears to have been a man of learning, found a reading in his own manuscript which differed from that of the *Codex Vaticanus*, he has noted it in the margin, and

(A) He wrote this in the year 1628. According to this account, then, the manuscript must have been written in 328; a date to which so many weighty objections may be made, that its most strenuous advocates will hardly undertake to defend it. But this error has furnished Oudin with an opportunity of producing many arguments against the antiquity of the *Codex Alexandrinus*, which seem to imply, that Grabe and others, who have referred it to the fourth century, suppose it to have been written in the above-mentioned year. Now it is probable, that the inference which has been deduced from the account of Cyrillus is more than he himself intended to express, as he relates that Thecla lived after the council of Nicæa.

(B) Probably because the Epistle to the Hebrews, as well as the Epistle to the Galatians, relates to the abolition of the Mosaic law.

Scripture. and has generally left the text itself untouched, though in some few examples he has ventured to erase it.

It is certain, that this manuscript is of very high antiquity, though it has been disputed which of the two in this respect is entitled to the preference, the *Vaticanus* or *Alexandrinus*. The editors of the Roman edition of the Septuagint, in 1587, referred the date of the Vatican manuscript to the fourth century, the period to which the advocates for its great rival refer the *Codex Alexandrinus*. More moderate, and perhaps more accurate, are the sentiments of that great judge of antiquity Montfaucon, who, in his *Bibliotheca Bibliothecarum*, p. 3. refers it to the fifth or sixth century; and adds, that though he had seen other manuscripts of equal antiquity, he had found none at the same time so complete.

The *Codex Vaticanus* has a great resemblance to the manuscripts noted by Wettstein, C. D. L. 1. 12. 33. 69. 102. and to the Latin, Coptic, and Ethiopic versions; but it is preferable to most of them, in being almost entirely free from those undeniable interpolations and arbitrary corrections which are very frequently found in the above-mentioned manuscripts, especially in D. 1. and 69. It may be applied, therefore, as a mean not only of confirming their genuine readings, but of detecting and correcting those that are spurious. It is written with great accuracy, and is evidently a faithful copy of the more ancient manuscript from which it was transcribed. Peculiar readings, or such as are found neither in other manuscripts nor ancient versions, are seldom discovered in the *Codex Vaticanus*; and of the few which have been actually found, the greatest part are of little importance. But in proportion as the number of such readings is small, the number of those is great; in support of which few only, though ancient authorities, have been hitherto produced. But this manuscript has not throughout the whole New Testament the same uniform text.

As we have now a beautiful printed edition of the Alexandrine manuscript by Dr Woide, it is much to be wished that we had also an exact impression of the Vatican manuscript. From the superstitious fears and intolerant spirit of the inquisition at Rome, all access to this manuscript was refused to the Abbé Spoletti, who presented a memorial for that purpose. Unless the pope interpose his authority, we must therefore despair of having our wishes gratified; but from the liberality of sentiment which the present pontiff has shown on several occasions, we hope that the period is not far distant when the Vatican library will be open to the learned; and when the pope will think it his greatest honour to encourage their researches.

The most valuable editions of the Greek New Testament are those of Mill, Bengel, and Wettstein.

The edition of Mill, which was only finished 14 days before his death, occupied the attention of the author for 30 years.

The collections of various readings which had been made before the time of Mill, the Veleſian, the Barberini, those of Stephens, the London Polyglot, and Fell's edition, with those which the Bishop had left in manuscript, and whatever he was able to procure elsewhere, he brought together into one large collection. He made likewise very considerable additions to it. He

collated several original editions more accurately than had been done before: he procured extracts from Greek manuscripts, which had never been collated; and of such as had been before collated, but not with sufficient attention, he obtained more complete extracts. It is said that he has collected from manuscripts, fathers, and versions, not less than 3,000 various readings. This collection, notwithstanding its many imperfections, and the superiority of that of Wettstein, is still absolutely necessary to every critic: for Wettstein has omitted a great number of readings which are to be found in Mill, especially those which are either taken from the Vulgate, or confirm its readings. Mill was indeed too much attached to this version; yet he cannot be accused of partiality in producing its evidence, because it is the duty of a critic to examine the witnesses on both sides of the question: and Wettstein, by too frequently neglecting the evidence in favour of the Vulgate, has rendered his collection less perfect than it would otherwise have been. He likewise added, as far as he was able, readings from the ancient versions; and is much to be commended for the great attention which he paid to the quotations of the fathers; the importance of which he had sagacity enough to discern.

It cannot, however, be denied, that Mill's Greek Testament has many imperfections, and some of real importance. His extracts from manuscripts often are not only incomplete, but erroneous; and it is frequently necessary to correct his mistakes from the edition of Wettstein. His extracts from the oriental versions are also imperfect, because he was unacquainted with these languages; and in selecting readings from the Syriac, the Arabic, and Ethiopic, he was obliged to have recourse to the Latin translations, which are annexed to those versions in the London Polyglot.

The great diligence which Mill had shown in collecting so many various readings, alarmed the clergy as if the Christian religion had been in danger of subversion. It gave occasion for a time to the triumphs of the deist, and exposed the author to many attacks. But it is now universally known, that not a single article of the Christian religion would be altered though a deist were allowed to select out of Mill's 30,000 readings whatever he should think most inimical to the Christian cause.

In 1734, Bengel abbot of Alpirspach, in the duchy of Wurtemberg, published a new edition of the Greek Testament. The fears which Mill had excited began to subside upon this new publication; for Bengel was universally esteemed a man of piety. Bengel was not only diligent in the examination of various readings, but in the strictest sense of the word conscientious; for he considered it as an offence against the Deity, if, through his own fault, that is, through levity or carelessness, he introduced a false reading into the sacred text. His object was not merely to make a collection of readings, and leave the choice of them to the judgment of the reader, but to examine the evidence on both sides, and draw the inference: yet he has not given his own opinion so frequently as Mill, whom he resembled in his reverence for the Latin version, and in the preference which he gave to harsh and difficult readings, before those which were smooth and flowing. It may be observed in general, that he was a man of profound learning;

133  
e best  
tions of  
Greek  
w Testa-  
nt are  
ise of  
ill,

Scripture.

134  
of Bengel.

Scripture. learning, and had a cool and sound judgment, though it did not prevent him from thinking too highly of the Latin readings, and of the *Codex Alexandrinus*, with other Latinizing manuscripts.

The imperfections of Bengel's edition arise chiefly from his diffidence and caution. He did not venture to insert into the text any reading which had not already appeared in some printed edition, even though he believed it to be the genuine reading. In the book of Revelation indeed he took the liberty to insert readings which had never been printed; because few manuscripts had been used in the printing of that book.

132  
And of  
Wetstein.

The celebrated edition of John James Wetstein, which is the most important of all, and the most necessary to those engaged in sacred criticism, was published at Amsterdam in 1751 and 1752, in two volumes folio. No man will deny that Wetstein's *Prolegomena* discover profound erudition, critical penetration, and an intimate acquaintance with the Greek manuscripts. It is a work which in many respects has given a new turn to sacred criticism, and no man engaged in that study can dispense with it. Wherever Wetstein has delivered his sentiments respecting a Greek manuscript, which he has done less frequently than Mill, and indeed less frequently than we could have wished, he shows himself an experienced and sagacious critic. He is likewise more concise than Mill in delivering his opinion, and does not support it by producing so great a number of readings from the manuscript in question. This conciseness is the consequence of that warmth and haste which were peculiar to Wetstein's character, and which have sometimes given birth to mistakes. The fire of his disposition was likewise the cause of his advancing conjectures, in regard to the history of his manuscripts, which exceed the bounds of probability. But the critical rules which he has delivered are perfectly just; and in this respect there is a remarkable agreement between him and his eminent predecessors Mill and Bengel. In regard to the Latin version alone they appear to differ: in Mill and Bengel it has powerful, and perhaps partial, advocates; but in Wetstein a severe and sagacious judge, who sometimes condemns it without a cause. The Greek manuscripts which confirm the readings of the Vulgate, and which he supposed had been corrupted from it, he of course condemned with equal severity: and some collections of various readings which had been made by Catholics, he made no scruple to pronounce a forgery, saying, "*Timeo Danaos, et dona ferentes.*" But in consequence of his antipathy to the Vulgate, his collection of various readings is less perfect than it might have been.

It has been asked, 1. Whether he has quoted his manuscripts either falsely or imperfectly, in order to establish his own religious opinions? or, 2. Whether his diligence and accuracy has been such that we may at all times depend upon them? To the first of these questions there can be no other answer, than that Wetstein, in his character of a critic, is perfectly honest. With respect to the second, his diligence and accuracy, Michaelis thinks there is less reason to pronounce him faultless. But Mr Marsh has examined the examples on which Michaelis founds his assertion, and declares that Michaelis is mistaken in every one of them.

The diligence of Wetstein can scarcely be questioned

by any who are acquainted with his history. He travelled into different countries, and examined with his own eyes a much greater number of manuscripts than any of his predecessors. His collection of various readings amount to *above a million*; and he has not only produced a much greater quantity of matter than his predecessors, but has likewise corrected their mistakes. The extracts from manuscripts, versions, and printed editions of the Greek Testament, which had been quoted by Mill, are generally quoted by Wetstein. Whenever Wetstein had no new extracts from the manuscripts quoted by Mill, or had no opportunity of examining them himself, he copied literally from Mill; but wherever Mill has quoted from printed editions, as from the margin of Robert Stephens's for instance, or from the London Polyglot, Wetstein did not copy from Mill, but went to the original source, as appears from his having corrected many mistakes in Mill's quotations.

In the opinion of Michaelis, there are many defects in the edition of Wetstein, which require to be supplied, and many errors to be corrected. Yet still it must be allowed to be a work of immense labour, and most valuable to those engaged in sacred criticism; and it is surprising, when we consider the difficulties and labour which Wetstein had to encounter, that his errors and imperfections are so few.

The proposal of Michaelis, however, of a new collation of manuscripts, in order to form a complete collection of various readings, is worthy the attention of the learned. In mentioning this proposal, Michaelis turns a wishful eye towards Britain, the only country, he says, which possesses the will and the means to execute the task. Should a resolution, he adds, be formed in this island, so happily situated for promoting the purposes of general knowledge, to make the undertaking a public concern, to enter into a subscription, and to employ men of abilities in collating manuscripts both at home and abroad, they would be able to do more in ten years than could otherwise be done in a century. And could this nation direct its attention to any object more glorious or more useful than in ascertaining the text of the sacred Scriptures, and giving to posterity an accurate edition?

As the sense of Scripture, as well as all other books, is affected by the punctuation, it is of importance to determine whether the stops or points which we find in the sacred books were used by the sacred writers, or have been inserted by modern transcribers.

We are told by Montfaucou, in his *Palaographia Græca*, p. 31. that the person who first distinguished the several parts of a period in Greek writing, by the introduction of a point, was Aristophanes of Byzantium, who lived under Ptolemæus Epiphanes, in the 145th Olympiad. But though points were not used in books before this period, they were employed in inscriptions above 400 years before the birth of Christ. See *Mont. Pal. Græc.* p. 135.

Under the article PUNCTUATION we mentioned, on authority which we reckoned unquestionable, that the ancient manuscripts were written without any points. We have now, however, discovered, from Woide's edition of the *Codex Alexandrinus*, that points are used in that manuscript, though omitted in the *fac simile* given by

Scripture.

136  
Punctua-  
tion of the  
New Testa-  
ment.



Scripture. by Montfaucon. That they are found too in the *Codex Vaticanus*, though not frequently, is related by Birch in his *Prolegomena*, p. 14.

Scripture. they contained, according to Jerome, 68 breves; Mark contained 48; Luke 83; and John 18. All the evangelists together consisted of 217 breves and 1126 capitula. The inventor of our modern division into chapters was Hugo de S. Caro, a French Dominican friar who lived in the 13th century.

As the fact has not been generally known, that the ancients pointed their manuscripts, and as it is an important and interesting fact, we shall present our readers with the first six lines of St John's Gospel, as they are pointed in the Alexandrine manuscript:

ΕΝΑΡΧΗΗΝΘΑΟΓΟΣΚΑΙΟΑΙΟΑΟΓΟΣΗΝ  
ΠΡΟΣΤΟΝΘΝ ΚΑΙΘΥΗΝΟΑΟΓΟΣ·  
ΟΤΤΟΣΗΝΕΝΑΡΧΗΠΡΟΣΤΟΝΘΝ  
ΠΑΝΤΑΔΙΑΤΟΤΕΓΕΝΕΤΟ·ΚΑΙΧΩ  
ΡΕΙΣΑΤΤΟΤΕΓΕΝΕΤΟΟΤΑΕΕΝ·  
ΟΤΕΓΟΝΕΝΕΝΑΤΤΩΖΩΗΗΝ·

Whether any points for marking the sense were used by the apostles, cannot be determined; but the points now in use have been invented since.

The ancients had two kinds of verses, one of which they called *σχοι*, and the other *ρυσια*. The *remata* were lines which contained a certain number of letters, like our printed books, and therefore often broke off in the middle of a word. Josephus's 20 books of Antiquities contained 60,000 of them, though in Ittiquis's edition there are only 40,000 broken lines.

*Stichi* were lines measured by the sense: according to an ancient written list mentioned by Father Simin, there were in the New Testament 18,612 of these.

In the fourth century, Jerome began to add the comma and colon to the Latin version; and they were then inserted in many more ancient manuscripts. In the fifth century, Euthalius a deacon of Alexandria divided the New Testament into lines. This division was regulated by the sense, so that each line ended where some pause was to be made in speaking. And when a copyist was disposed to contract his space, and therefore crowded the lines into each other, he then placed a point where Euthalius had terminated the line. In the eighth century, the stroke was invented which we call a comma. In the Latin manuscripts, Jerome's points were introduced by Paul Warnfried and Alcuin, at the command of Charlemagne. In the ninth century, the Greek note of interrogation (;) was first used. At the invention of printing the editors placed the points arbitrarily, probably without bestowing the necessary attention; and Stephens, in particular, varied his points in every edition (D).

The verses into which the New Testament is now divided are more modern, and an imitation of the division of the Old Testament. Robert Stephens, the first inventor, introduced them in his edition in the year 1551. He made this division on a journey from Lyons to Paris; and, as his son Henry tells us in the preface to the Concordance of the New Testament, he made it *inter equitandum*. This phrase probably means, that when he was weary of riding, he amused himself with this work at his inn.

This invention of the learned printer was soon introduced into all the editions of the New Testament; and it must be confessed, that in consulting and quoting the Scriptures, and in framing concordances for them, a subdivision into minute parts is of the greatest utility. But all the purposes of utility could surely have been gained, without adopting the hasty and indigested division of Stephens, which often breaks the sense in pieces, renders plain passages obscure, and difficult passages unintelligible. To the injudicious division of Stephens we may ascribe a great part of the difficulties which attend the interpretation of the New Testament, and a great many of those absurd opinions which have disgraced the ages of the Reformation. For as separate verses appear to the eyes of the learned, and to the minds of the unlearned, as so many detached sentences, they have been supposed to contain complete sense, and they have accordingly been explained without any regard to the context, and often in direct opposition to it. Were any modern history or continued discourse divided into fragments with as little regard to the sense, we should soon find, that as many opposite meanings could be forced upon them as have been forced upon the books of the New Testament. The division into verses has been still more injurious to the Epistles than to the Gospels, for there is a close connection between the different parts of the Epistles, which the verses entirely dissolve. It is therefore to be wished that this division into verses were laid aside. The Scriptures ought to be divided into paragraphs, according to the sense; and the figures ought to be thrown into the margin. In this way, the figures will retain their utility without

The meaning of many passages in the Scripture has been altered by false pointing. We shall produce one instance of this: Mat. v. 34. is commonly pointed in this manner, *εγω δε λεγω υμιν, μη ομοσαι ολως· μητε εν τω υρακρ,* and consequently translated, "But I say unto you, swear not at all." But if, instead of the colon placed after *ολως*, we substitute a comma, the translation will be, "But I say to you that you ought by no means to swear, either by heaven, for it is his throne, or by earth, for it is his footstool." The command of Christ therefore applies particularly to the abuse of oaths among the Pharisees, who on every trivial occasion swore by the heaven, the earth, the temple, the head, &c. but it implies no prohibition to take an oath in the name of the Deity on solemn and important occasions.

The ancients divided the New Testament into two kinds of chapters, some longer and some shorter. This method appears to be more ancient than St Jerome, for he expunged a passage from the New Testament which makes an entire chapter. The longer kind of chapters were called *breves*, the shorter *capitula*. St Matthew. VOL. XVII. Part I.

137  
Division  
into chap-  
ters.

128  
Division  
into ver-  
ses.

139  
Its disad-  
vantages.

U without

(D) The reader will perceive that the account of the origin of points is different from that given under PUNCTUATION. But the best authors differ upon this subject. We shall perhaps reconcile the difference, by supposing that points were invented at the time here mentioned, but were not in general use till the time mentioned under the article PUNCTUATION.

**Scripture.** without their disadvantages. Dr Campbell, in his beautiful translation of the Gospels, has adopted this method with great judgment and success; and he who will read that translation, will perceive that this single alteration renders the Gospels much more intelligible, and, we may add, more entertaining (E).

140  
Meaning  
of the word  
Gospel.

The word ΕΓΑΓΓΕΛΙΟΝ signifies any joyful tidings, and exactly corresponds to our English word GOSPEL. In the New Testament this term is confined to "The glad tidings of the coming of the Messiah." Thus, in Mat. xi. 5. our Lord says, "The poor have the Gospel preached;" that is, The coming of the Messiah is preached to the poor. Hence the name of *Gospel* was given to the histories of Christ, in which the good news of the coming of the Messiah, with all its joyful circumstances, are recorded.

141  
Gospel ac-  
cording to  
St Mat-  
thew.

That the Gospel according to Matthew was composed, says Dr Campbell, by one born a Jew, familiarly acquainted with the opinions, ceremonies, and customs of his countrymen; that it was composed by one conversant in the sacred writings, and habituated to their idiom; a man of plain sense, but of little or no learning, except what he derived from the Scriptures of the Old Testament; and finally, that it was the production of a man who wrote from conviction, and had attended closely to the facts and speeches which he related, but who in writing entertained not the most distant view of setting off himself—we have as strong internal evidence as the nature of the thing will admit, and much stronger than that wherein the mind ninety-nine cases out of a hundred acquiesces.

That the author of this history of our blessed Saviour was Matthew, appears from the testimony of the early Christians. It is attested by Jerome, Augustin, Epiphanius, and Chrysostom, and in such a manner as shews that they knew the fact to be uncontroverted, and judged it to be incontrovertible. Origen, who flourished in the former part of the 3d century, is also respectable authority. He is quoted by Eusebius in a chapter \* wherein he specially treats of Origen's account \* *Hist.* of the sacred canon. "As I have learned (says Ori- *lib. 6. cap.* gen) by tradition concerning the four gospels, which alone are received without dispute by the whole church of God under heaven; the first was written by Matthew, once a publican, afterwards an apostle of Jesus Christ, who delivered it to the Jewish believers, composed in the Hebrew language." In another place he says, "Matthew writing for the Hebrews who expected him who was to descend from Abraham and David, says the lineage of Jesus Christ, son of David, son of Abraham." It must be observed, that the Greek word παραδοσις does not exactly correspond to the English word tradition, which signifies any thing delivered orally from age to age. Παραδοσις properly implies any thing transmitted from former ages, whether by oral or written testimony. In this acceptance we find it used in scripture †: "Hold the traditions (τας παραδοσεις) which † *Theff. ii.* ye have been taught, whether by word or our epistle." 15.

The next authority to which we shall have recourse is that of Irenæus bishop of Lyons, who had been a disciple of Polycarp. He says in the only book of his extant, that "Matthew, among the Hebrews, wrote a *Ev. Hist.* Gospel *Eccl. lib 5.* cap. 3.

(E) We shall here subjoin, as a curiosity, what the anonymous author terms *the Old and New Testament dissected*. It contains an enumeration of all the books, chapters, verses, words, and letters, which occur in the English Bible and Apocrypha. It is said to have occupied three years of the author's life, and is a singular instance of the trifling employments to which superstition has led mankind.

The OLD and NEW TESTAMENT dissected.

Books in the Old	-	-	39	in the New	-	27	Total	-	66	Apocrypha.
Chapters	-	-	929	-	-	260		-	1189	Chapters 183
Verses	-	-	23,214	-	-	7959		-	31,173	Verses 6081
Words	-	-	592,439	-	-	181,253		-	773,692	Words 252,185
Letter.	-	-	2,728,100	-	-	838,380		-	3,566,480	

- The middle Chapter and the least in the Bible is Psalm 117.
- The middle Verse is the 8th of the 118th Psalm.
- The middle time is the 2d of Chronicles, 4th Chap. 16th Verse.
- The word *And* occurs in the Old Testament 35,543 times.
- The same in the New Testament occurs 10,684 times.
- The word JEHOVAH occurs 6855 times.

OLD TESTAMENT.

- The middle Book is Proverbs.
- The middle Chapter is Job 29th.
- The middle Verse is 2d Chron. 20th Chap. between 17th and 18th Verses.
- The least Verse is 1 Chron. 1st Chap. and 1st Verse.

NEW TESTAMENT.

- The middle Book is Thessalonians 2d.
- The middle Chapter is between the 13th and 14th Romans.
- The middle Verse is 17th Chap. Acts, 17th Verse.
- The least Verse is 11th Chap. John, Verse 35.
- The 21st Verse of the 7th Chapter of Ezra has all the letters of the alphabet.
- The 19th Chapter of 2d of Kings and 37th of Isaiah are alike.

Scripture. gospel in their own language, whilst Peter and Paul were preaching the gospel at Rome and founding the church there."

To the testimony of these writers it may be objected, that, except Irenæus, they all lived in the third and fourth centuries, and consequently their evidence is of little importance. But there is such unanimity in the testimony, that it must have been derived from some authentic source. And is it fair to question the veracity of respectable men merely because we knew not from what writings they received their information? Many books which were then extant are now lost; and how do we know but these might have contained sufficient evidence? Irenæus at least had the best opportunities of information, having been well acquainted in his youth with Polycarp, the disciple of John; no objection can therefore be made to his evidence. But we can quote an authority still nearer the times of the apostles. Papias bishop of Hierapolis, in Cæsarea, who flourished about A. D. 116, affirms that Matthew wrote his gospel in the Hebrew tongue, which every one interpreted as he was able. Papias was the companion of Polycarp, and besides must have been acquainted with many persons who lived in the time of the apostles. The fact therefore is fully established, that Matthew, the apostle of our Saviour, was the author of that gospel which is placed first in our editions of the New Testament.

The next subject of inquiry respects the language in which it was written. This we are assured by Papias, by Irenæus, and Origen, was the Hebrew; but the truth of this fact has been disputed by Erasmus, Whitby, and others. Whitby urges the improbability that Providence would have suffered the original of this gospel to be lost, and nothing to remain but a translation. This is an argument of no force against written testimony; indeed we are always in danger of drawing false conclusions when we argue from our own opinions of the conduct of Providence. *For His ways are not as our ways, nor His thoughts as our thoughts.* But though we are forced to acknowledge that the gospel according to Matthew which we possess is a translation, it is evidently a close one; and the very circumstance that it has superseded the original, is a clear proof that it was thought equally valuable by the ancient Christians. It is necessary to remark, that the language in which the gospel according to Matthew was originally composed, and which is called Hebrew by Papias, Irenæus, and Origen, is not the same with the Hebrew of the Old Testament: it was what Jerome very properly terms Syro-Chaldaic, having an affinity to both languages, but much more to the Chaldean than to the Syrian.

The time when this gospel was composed has not been precisely ascertained by the learned. Irenæus says that "Matthew published his gospel when Peter and Paul were preaching at Rome." Now Paul arrived at Rome A. D. 60 or 61, and it is very probable suffered martyrdom in A. D. 65. This may be justly concluded from comparing the relation of Tacitus with that of Orosius, a writer of the fifth century. Orosius having given an account of Nero's persecution of the Christians, and of the death of the two apostles in it, adds, that it was followed by a pestilence in the city, and other disasters. And Tacitus relates that a pestilence prevailed

in the city, and violent storms took place in Italy, in the year of Christ 65. Matthew's gospel was therefore written between the year 60 and 65.

That this history was primarily intended for the use of the Jews, we have, besides historical evidence, very strong presumptions from the book itself. Every circumstance is carefully pointed out which might conciliate the faith of that nation; every unnecessary expression is avoided, which might in any way serve to obstruct it. To come to particulars, there was no sentiment relating to the Messiah with which the Jews were more strongly possessed, than that he must be of the race of Abraham, and of the family of David. Matthew, therefore, with great propriety, begins his narrative with the genealogy of Jesus. That he should be born at Bethlehem in Judea, is another circumstance in which the learned among the Jews were universally agreed. His birth in that city, with some very memorable circumstances that attended it, this historian has also taken the first opportunity to mention. Those passages in the prophets, or other sacred books, which either foretel any thing that should happen to him, or admit an allusive appellation, or were in that age generally understood to be applicable to events which respect the Messiah, are never passed over in silence by this Evangelist. The fulfilment of prophecy was always to the Jews, who were convinced of the inspiration of their sacred writings, strong evidence. Accordingly none of the Evangelists has been more careful than Matthew, that nothing of this kind should be overlooked.

That which chiefly distinguishes Matthew's writings from those of the other Evangelists, is the minute and distinct manner in which he has related many of our Lord's discourses and moral instructions. Of these his sermon on the mount, his charge to the apostles, his illustrations of the nature of his kingdom, and his prophecy on mount Olivet, are examples. He has also wonderfully united simplicity and energy in relating the replies of his master to the cavils of his adversaries. Being early called to the apostleship, he was an eye and ear witness of most of the things which he relates. And there are circumstances which incline Dr Campbell to think that Matthew has approached as near the precise order of time in which the events happened as any of the Evangelists.

Concerning the life of the apostle Matthew we have nothing to add, as the principal circumstances in his life have already been mentioned. See MATTHEW.

The Gospel according to Matthew is cited seven times in the epistle of Barnabas, twice in the first epistle of Clemens Romanus to the Corinthians, eight times in the Shepherd of Hermas, six times in Polycarp's small epistle to the Philippians, and seven times in the smaller epistles of Ignatius. These citations may be seen at full length in *Jos. New and Full Method of setting the Canon*, with the parallel passages in the gospel according to Matthew.

That Mark was the author of the gospel which bears his name, and that it was the second in the order of time, is proved by the unanimous testimony of the ancient Christians. Many authorities are therefore unnecessary; we shall only mention those of Papias and Irenæus. Eusebius has preserved the following passage of Papias: "This is what was related by the elder (that is, John, not the apostle, but a disciple of Jesus); Mark being

Euseb.  
H. Eccl.  
3. cap.

143  
language  
which  
was  
written.

144  
Date,

Cardner's  
H. of the  
Apostles.

Scripture.

145  
And design  
of it.

Dr Camp-  
bell's Pre-  
face to  
Matthew's  
Gospel.

146  
Distinguishing  
character.

147  
Gospel ac-  
cording to  
St Mark.

148  
at a then-  
city,

H. Eccl.  
lib. 3. cap.  
being 39

Scripture. being Peter's interpreter wrote exactly whatever he remembered, not indeed in the order wherein things were spoken and done by the Lord; for he was not himself a hearer or follower of our Lord; but he afterwards, as I said, followed Peter who gave instructions as suited the occasions, but not as a regular history of our Lord's teaching. Mark, however, committed no mistake in writing such things as occurred to his memory: for of this one thing he was careful, to omit nothing which he had heard, and to insert no falsehood into his narrative." Such is the testimony of Papias, which is the more to be regarded as he assigns his authority. He spoke not from hearsay, but from the information which he had received from a most credible witness, John the elder, or presbyter, a disciple of Jesus, and a companion of the apostles.

149  
And date.

Adv. Her.  
lib. 3 cap.  
2.

Irenæus, after telling us that Matthew published his gospel whilst Peter and Paul were preaching at Rome, adds: "After their departure (ἐξόδου), Mark also, the disciple and interpreter of Peter, delivered to us in writing the things which had been preached by Peter." The Greek ἐξόδου, like the English word *departure*, may either denote death, which is a departure out of the world, or mean a departure out of the city. It is probably in the former of these senses it is here used. Yet by the accounts given by some others, Mark's gospel was published in Peter's lifetime, and had his approbation. The gospel of Mark is supposed to be but two years posterior in date to that of Matthew. The precise year, however, cannot be determined with certainty; and it is a matter of no importance, since we have ascertained the author and the time in which he lived.

Mark has generally been supposed to be the same person who is mentioned in the acts and some of Paul's epistles, who is called John, and was the nephew of Barnabas. But as this person was the attendant of Paul and Barnabas, and is nowhere in scripture said to have accompanied Peter in his apostolical mission, which ancient writers inform us the author of the gospel did, Dr Campbell has justly concluded that these were different persons. The author of the gospel is certainly meant by Peter when he says *Marcus my son saluteth you* ||.

Preface to  
Mark.

|| 1 Pet. v.

13.  
1.0  
Language  
in which it  
was writ-  
ten.

That Mark wrote his gospel in Greek, is as evidently conformable to the testimony of antiquity, as that Matthew wrote his in Hebrew or Syro Chaldaic. The cardinals Baronius and Bellarmine, anxious to exalt the language in which the vulgate was written, have maintained that this Evangelist published his work in Latin. The only appearance of testimony which has been produced in support of this opinion is the inscription subjoined to this gospel in Syriac, and in some other oriental versions. But these postscripts are not the testimonies of the translators: they proceed from the conjecture of some transcriber; but when written, or by whom, is equally unknown. Against positive testimony therefore they are entitled to no credit.

151  
Design of

From the Hebraisms in the style, we should readily conclude that the author was by birth and education a Jew. There are also expressions which show that he had lived for some time among the Latins, as *κέντηρον*, "centurion," and *συνταγματάρχης*, "sentinel;" words which do not occur in the other gospels. There are other internal evidences that this gospel was written be-

yond the confines of Judea. The first time the Jordan is mentioned, ποταμός, "river," is added to the name for explanation; for though no person in Judea needed to be informed that Jordan was a river, the case was different in distant countries. The word *Gehenna*, which is translated *Hell* in the New Testament, originally signified the *Valley of Hinnom*, where infants had been sacrificed by fire to Moloch, and where a continual fire was afterwards kept up to consume the filth of Jerusalem. As this word could not have been understood by a foreigner, the Evangelist adds, by way of explanation, *ἡ ἐπὶ τοῦ αὐβισίν*, "the unquenchable fire." Instead of the word *Manimon*, he uses the common term *χρηματα* "riches." When he employs the oriental word *Corban*, he subjoins the interpretation *ἄρτι δαρον*, that is, "a gift." These peculiarities will corroborate the historical evidence that has been already mentioned, that Mark intended his gospel for the use of the Gentiles.

Dr Camp-  
bell's Pre-  
face to  
Mark's  
Gospel.

It has been affirmed that this evangelist is the abridger of Matthew. It is true that Mark sometimes copies the expressions used by Matthew; but he is not to be considered as a mere abridger, for he omits altogether several things related by Matthew, viz. our Lord's pedigree, his birth, the visit of the Magians, Joseph's flight into Egypt, and the cruelty of Herod. Dr Lardner has given a list of thirty-three passages, wherein circumstances are related which are omitted by the other evangelists. There is one parable, and an account of two miracles peculiar to Mark. The parable or similitude is mentioned in chap. iv. 26. One of these miracles was the curing of a deaf and dumb man, chap. vii. 31, 37. The other was the giving sight to a blind man at Bethsaida, chap. viii. 22, 26. The style of Mark, instead of being more concise than that of Matthew, is more diffuse. That he had read Matthew's gospel cannot be doubted, but that he abridged it, is a mistake.

152  
Mark not  
the abrid-  
ger of  
Matthew.

According to the testimony which has been already produced, Mark derived his information from the apostle Peter. It would be improper, therefore, not to remark, that this evangelist has omitted many things tending to Peter's honour, which are related in the other gospels, and has given the most particular account of Peter's fall. This gospel is seven times cited by Irenæus, and nine times by Tertullian.

153  
But deri-  
ved his in-  
formation  
from Pe-  
ter.

That the author of the gospel which is the third in order was Luke, the companion of the apostle Paul, is evident from the testimonies of Irenæus, Clemens of Alexandria, Origen, Tertullian, and many succeeding writers. But it has been disputed whether he was a Jew or a Gentile. That Luke was a Jew by birth, or at least by religion, may be argued from his being a constant companion of Paul. If he had been an un-circumcised Gentile, exceptions would have been made to him, especially at Jerusalem; but nothing of that kind appears. It is also rendered highly probable, from his mode of computing time by the Jewish festivals, and from his frequent use of the Hebrew idiom. It has been supposed that Luke was one of the 70 disciples; but he does not pretend to have been a witness of our Lord's miracles and teaching; on the contrary, he tells us in his introduction, that he received his information from others.

154  
Gospel ac-  
cording to  
St Luke.

The design of Luke in writing his gospel was to su-  
percede it.

155  
Design of

**Scripture.** **156** **From what sources of information it was derived.** **157** **Has supplied many omifions of the two former gospels.** **Dr Campbell's Preface to Luke's Gospel.** **158** **Style and compofition of it.** perfede fome imperfect and inaccurate hiftories of our Saviour, which had then been publifhed. What thefe were, it is impoffible now to determine, as they are not mentioned by any contemporary writer, and probably did not furvive the age in which they were compofed.

It has been fupposed that Luke chiefly derived his information from the apoftle Paul, whom he faithfully attended in his travels; but, from Luke's own words, we are led to conclude, that the principal fource of his intelligence, as to the facts related in the gofpel, was from thofe who had been eye and ear wiffneffes of what our Lord both did and taught. Now Paul evidently was not of this number. It was from converfing with fome of the twelve apoftles or difciples of our Lord, who heard his difcourfes and faw his miracles, that he obtained his information.

As to the time when this gofpel was written, we have hardly any thing but conjecture to guide us. But as Origen, Eufebius, and Jerome, have ranged it after thofe of Matthew and Mark, we have no reafon to doubt but they were written in the fame order.

The gofpel by Luke has fupplied us with many interefting particulars which had been omitted both by Matthew and Mark. It has given a diftinct narration of the circumftances attending the birth of John the Baptift and the nativity of our Saviour. It has given an account of feveral memorable incidents and cures which had been overlooked by the reft; the converfion of Zaccheus the publican; the cure of the woman who had been hewed down for 18 years; the cure of the dropsical man; the cleansing of the ten lepers; the inhofpitable treatment of our Saviour by the Samaritans, and the inftitutive rebuke which he gave on that occafion to two of his difciples for their intemperate zeal; alfo the affecting interview which he had after his refurrection with two of his difciples. Luke has alfo added many edifying parables to thofe which the other evangelifts had recorded. Moft of thefe are fpecified by Irenæus as particularly belonging to this gofpel, and has thereby fhown to us, without intending it, that the gofpel of Luke was the fame in his time that it is at prefent.

The ftyle of this evangelift abounds as much with Hebraifms as any of the facred writings, but it contains more of the Grecian idiom than any of them. It is alfo diftinguifhed by greater variety and copioufnefs; qualities which may be juftly afcribed to the fuperior learning of the author. His occupation as a phyfician would naturally induce him to employ fome time in reading, and give him eafier accefs to the company of the great than any of the other evangelifts. As an inftance of Luke's copioufnefs, Dr Campbell has remarked that each of the evangelifts has a number of words which are ufed by none of the reft; but in Luke's gofpel the number of fuch peculiarities or words, ufed in none of the other gospels, is greater than that of the peculiar words found in all the three other gospels put together; and that the terms peculiar to Luke are for the moft part long and compound words. The fame judicious writer has alfo obferved, that there is more of compofition in Luke's fentences than is found in the other three, and confequently lefs fimplicity. Of this the very firft fentence is an example, which occupies no lefs than four verfes. Luke, too, has a greater re-

semblance to other hiftorians, in giving what may be called his own verdict in the narrative part of this work; a freedom which the other evangelifts have feldom or never ventured to ufe. He calls the Pharifees *lovers of money*: in diftinguifhing Judas Ifcariot from the other Judas, he ufes the phrafe, *he who proved a traitor*, (*ὁς καὶ ἐγένετο προδοτὴς*). Matthew and Mark exprefs the fame fentiment in milder language, "he who delivered him up." In recording the moral inftitutions of our Lord, efpecially his parables, this evangelift has united an affecting fweetnefs of manner with genuine fimplicity.

This gofpel is frequently cited by Clemens Romanus, the contemporary of the Apoftles, by Ignatius, and Juftin Martyr. Irenæus has made above a hundred citations from it. In his *lib. 3. adv. Hæref. c. 14.* he vindicates the authority and perfection of Luke's gofpel, and has produced a collection of thofe facts which are only recorded by this evangelift.

That the gofpel which is placed laft in our editions of the New Teftament was written by John, one of our Saviour's apoftles, is confirmed by the unanimous testimony of the ancient Chriftians. He was the fon of Zebedee, a fifherman of Bethfaida in Galilee, by his wife Salome, and the brother of James, furnamed the elder or greater. He was the beloved difciple of our Saviour, and was honoured, along with Peter and James, with many marks of diftinction which were not conferred on the other difciples. He poffeffed a high degree of intrepidity and zeal, a warm and affectionate heart, and was itrongly attached to his mafter. His brother James and he were honoured with the title of *Boanerges*, or *Sons of Thunder*. He was anxious to refrain whatever he confidered as a mark of difrefpect againft his mafter, and to punifh his enemies with feverity. He was incenfed againft fome perfons for attempting to caft out demons in the name of Jesus; and required them to defift becaufe they were not his difciples. James and he propofed to our Saviour to call down fire from heaven to punifh the inhofpitable Samaritans. Nor was the courage of John lefs ardent than his zeal. When Peter had difowned his Lord, and all the other difciples had fled, John continued to attend his mafter. He was prefent at his trial, and followed him to the crofs, where he was a fpectator of his fufferings and death. The interview between Jesus and this difciple at Calvary, though concifely related, is an event which will ftrongly affect every man of feeling, while it convinces him of the unalterable affection of Jesus to his beloved difciple, as well as difcovers his refpectful tendernes for his mother. See JOHN.

The ancients inform us, that there were two motives which induced John to write his gofpel: the one, that he might refute the herefies of Cerinthus and the Nicolaitans, who had attempted to corrupt the Chriftian doctrine; the other motive was, that he might fupply thofe important events in the life of our Saviour which the other evangelifts had omitted. Of the former of thefe motives Irenæus gives us the following account: "John, defirous to extirpate the errors fown in the minds of men by Cerinthus, and fome time before by thofe called Nicolaitans, publifhed his gofpel; wherein he acquaints us that there is one God, who made all things by his word, and not, as they fay, one who is the Creator of the world, and another who is the father

Scripture

Scripture

of the Lord; one the son of the Creator, and another the Christ, from the supercelestial abodes who descended upon Jesus, the son of the Creator, but remained impassible, and afterwards fled back into his own pleroma or fulness." As Irenæus is the most ancient author who has written upon this subject, many appeals have been made to his authority. The authority of Irenæus is certainly respectable, and we have often referred to his testimony with confidence; but we think it necessary to make a distinction between receiving his testimony to a matter of fact, and implicitly adopting his opinion. He does not tell us, that he derived his information from any preceding writer, or indeed from any person at all. Nay, he seems to have believed that John wrote against these heresies by a prophetic spirit; for he says in another place, chap. xx. 30. "As John the disciple of our Lord assures us, saying, But these are written, that ye might believe that Jesus is the Christ, the Son of God, and that believing ye might have life through his name; FORBESKING these blasphemous notions that divide the Lord, so far as it is in their power."

162  
Not to confute heretics;

4. The Jewish Scriptures. Indeed the conclusion that Jesus was the Messiah the Son of God, naturally arises from almost every miracle which our Saviour is said to have performed and from every discourse that he delivered. This declaration is very often made by our Saviour himself; particularly to the woman of Samaria, to Nicodemus, and to the blind man whom he had cured.

It must be evident to every reader, that John studiously passes over those passages in our Lord's history and teaching which had been treated at large by the other evangelists, or if he mentions them at all he mentions them slightly. This confirms the testimony of ancient writers, that the first three gospels were written and published before John composed his gospel. Except the relation of our Saviour's trial, death, and resurrection, almost every thing which occurs in this book is new. The account of our Saviour's nativity, of his baptism, and of his temptation in the wilderness, is omitted; nor is any notice taken of the calling of the twelve apostles, or of their mission during our Saviour's life. It is remarkable, too, that not one parable is mentioned, nor any of the predictions relating to the destruction of Jerusalem. All the miracles recorded by the other evangelists are passed over, except the miraculous supply of provision, by which five thousand were fed: and it is probable that this miracle was related for the sake of the discourse to which it gave birth. The other miracles which are mentioned are few in number, but in general they are minutely detailed. They consist of these: the turning of water into wine at Cana; the cure of the diseased man at the pool of Bethesda; the cure of the man that had been blind from his birth; the restoring of Lazarus to life; and the healing of the servant's ear which Peter had cut off. But valuable would this gospel be, though it had only recorded the consolation of Jesus to his disciples previous to his departure; which exhibits a most admirable view of our Saviour's character, of his care and tender regard for his disciples. Having opened every source of comfort to their desponding minds; exhorted them to mutual love, and to the obedience of his Father's precepts; having warned them of the impending dangers and sorrows—our Saviour concludes with a prayer, in the true spirit of piety and benevolence; ardent without enthusiasm, sober and rational without lukewarmness.

164  
Is a supplement to the other three gospels.

Dr Campbell's Preface to John's Gospel.

Indeed it seems very improbable that an apostle should write a history of our Lord on purpose to confute the wild opinions of Cerinthus or any other heretic. Had John considered such a confutation necessary, it is more likely that he would introduce it into an epistle than blend it with the actions of his venerable Master. But were the opinion of Irenæus well-founded, we should surely discover some traces of it in the gospel of John; yet except in the introduction, there is nothing that can with the least shadow of probability be applied to the opinions of Cerinthus; and few, we presume, will affirm, that the gospel of John was composed merely for the sake of the first eighteen verses.

163  
But to prove that Jesus was the Messiah the Son of God.

The intention of John in writing his gospel was far more extensive and important than to refute the opinions of a few men who were to sink into oblivion in the course of a few centuries. It was evidently (according to the opinion of Clemens of Alexandria) to supply the omissions of the other evangelists: It was to exhibit the evidences of the Christian religion in a distinct and perspicuous manner: It was, as he himself in the conclusion of his gospel assures us, to convince his readers, that Jesus is the Messiah, the Son of God, and that believing they might have life through his name\*. Now it will appear to any person who reads this gospel with attention, that he has executed his plan with astonishing ability, and has given the most circumstantial and satisfactory evidence that Jesus was the Messiah the Son of God. After declaring the pre-existence of Jesus, he proceeds to deliver the testimony of John the Baptist, and selects some of the greatest miracles of Jesus to prove his divine mission. In the fifth chapter he presents us with a discourse which our Saviour delivered in the temple in the presence of the Jews, wherein he states in a very distinct manner the proofs of his mission from, 1. The testimony of John; 2. His own miracles; 3. The declaration of the Father at his baptism;

\* John xv. 22.

The time in which this gospel was written has not been fixed with any precision. Irenæus informs us, that it was written at Ephesus, but leaves us to conjecture whether it was written before or after John's return from Patmos. He was banished to Patmos by Domitian, who reigned 15 years, and according to the best computation died A. D. 96. The persecution which occasioned the exile of John commenced in the 14th year of Domitian's reign. If John wrote his gospel after his return to Ephesus, which is affirmed by Epiphanius to have been the case, we may fix the date of it about the year 97 (F).

165  
Time at which it was written.

This gospel is evidently the production of an illiterate

166  
Style of it. rate

(F) It has been argued from a passage in this gospel, that it must have been written before the destruction of Jerusalem. In speaking of the pool of Bethesda, John uses the present tense: His words are, "There is at Jerusalem."

Scripture. rate Jew, and its style is remarkable for simplicity. It abounds more with Hebraisms than any of the other gospels; and contains some strong oriental figures which are not readily understood by an European.

167  
often quoted  
by ancient  
Christians.  
168  
A. of the  
apostles.  
This gospel is cited once by Clemens Romanus, by Barnabas three times, by Ignatius five times, by Justin Martyr six times, by Irenæus, and above forty times by Clemens Alexandrinus.

The book which we intitle the Acts of the Apostles connects the gospels and the epistles. It is evidently a continuation of Luke's gospel, which appears both from the introduction and from the attestations of ancient Christians. Both are dedicated to Theophilus; and in the beginning of the Acts a reference is made to his gospel, which he calls a former treatise, recording the actions and discourses of Jesus till his ascension to heaven. Luke is mentioned as the author of the Acts of the Apostles by Irenæus, by Tertullian, by Origen, and Eusebius.

From the frequent use of the first person plural, it is manifest that Luke the author was present at many of the transactions which he relates. He appears to have accompanied Paul from Troas to Philippi. He attended him also to Jerusalem, and afterwards to Rome, where he remained for two years. He is mentioned by Paul in several of those epistles which were written from Rome, particularly in the 2d epistle to Timothy, and in the epistle to Philemon.

This book contains the history of the Christian church for the space of about 28 or 30 years, from the time of our Saviour's ascension to Paul's arrival at Rome in the year 60 or 61. As it informs us that Paul resided two years in Rome, it must have been written after the year 63; and as the death of Paul is not mentioned, it is probable it was composed before that event, which happened A. D. 65.

169  
Contents  
of that  
book.  
The Acts of the Apostles may be divided into seven parts. 1. The account of our Saviour's ascension, and of the occurrences which happened on the first Pentecost after that event, contained in chap. i. ii. 2. The transactions of the Christians of the circumcision at Jerusalem, in Judea, and Samaria, chap. iii.—ix. xi. 1—21. xii. 3. Transactions in Casarea, and the admission of the Gentiles, chap. x. 4. The first circuit of Barnabas and Paul among the Gentiles, chap. xi. 22. xiii. xiv. 5. Embassy to Jerusalem, and the first council held in that city, chap. xv. 6. Paul's second journey, chap. xvi.—xxi. 7. His arrestment, trial, appeal to Cæsar, and journey to Rome, chap. xxi. to the end of the book.

170  
often cited  
by the ear-  
ly Christi-  
ans.  
The Acts of the Apostles are cited by Clemens Romanus, by Polycarp, by Justin Martyr, thirty times by Irenæus, and seven times by Clemens Alexandrinus.

171  
the epif-  
es.  
All the essential doctrines and precepts of the Christian religion were certainly taught by our Saviour himself, and are contained in the gospels. The epistles may be considered as commentaries on the doctrines of the gospel, addressed to particular societies, accommodated to their respective situations; intended to refute the

errors and false notions which prevailed among them, and to inculcate those virtues in which they were most deficient.

172  
General  
plan of  
them.  
The plan on which these LETTERS are written is, first, to decide the controversy, or refute the erroneous notions which had arisen in the society to which the epistle was addressed: And, secondly, to recommend those duties which their false doctrines might induce them to neglect; at the same time inculcating in general exhortations the most important precepts of Christian morality.

173  
Arranged  
in chrono-  
logical or-  
der.  
Of the epistles fourteen were written by St Paul. These are not placed according to the order of time in which they were composed, but according to the supposed precedence of the societies or persons to whom they were addressed. It will be proper therefore to exhibit here their chronological order according to Dr Lardner.

A TABLE of St PAUL'S EPISTLES, with the Places where, and times when, written, according to Dr Lardner.

Epistles.	Places.	A. D.
1 Theſſalonians	Corinth	52
2 Theſſalonians	Corinth	52
Galatians	{ Corinth or Ephesus }	near the end of 52 or beginning of 53
1 Corinthians	Ephesus	the beginning of 53
1 Timothy	Macedonia	56
Titus	{ Macedonia or near it }	bef. the end of 56
2 Corinthians	Macedonia	about October 57
Romans	Corinth	about February 58
Ephesians	Rome	about April 61
2 Timothy	Rome	about May 61
Philippians	Rome	bef. the end of 62
Coloſſians	Rome	bef. the end of 62
Philemon	Rome	bef. the end of 62
Hebrews	{ Rome or Italy }	in Spring of 63

A TABLE of the CATHOLIC EPISTLES and the REVELATION, according to Dr Lardner.

Epistle.	Place.	A. D.
James	Judea	{ or beg. of 61
The two Epistles of Peter	Rome	64
1 John	Ephesus	about - 80
2d and 3d of John	Ephesus	{ between - and - 80
Jude	Unknown	64 or 65
Revelation	{ Patmos or Ephesus }	95 or 96

174  
Causes of  
their obitu-  
rity.  
It is more difficult to understand the epistolary writings than the gospels; the cause of which is evident. Many things are omitted in a letter, or slightly mentioned because supposed to be known by the person to whom it is addressed. To a stranger this will create much difficulty.

Jerusalem." Now if these words had been written after the destruction of Jerusalem, it is urged the past tense would have been used, and not the present. This argument is more specious than forcible. Though Jerusalem was demolished, does it follow that the pool of Bethesda was dried up?

Scripture. difficulty. The business about which St Paul wrote was certainly well known to his correspondents; but at this distance of time we can obtain no information concerning the occasion of his writing, of the character and circumstances of those persons for whom his letters were intended, except what can be gleaned from the writings themselves. It is no wonder, therefore, tho' many allusions should be obscure. Besides, it is evident from many passages that he answers letters and questions which his correspondents had sent him. If these had been preserved, they would have thrown more light upon many things than all the notes and conjectures of the commentators.

175  
Causes of  
obscurity  
peculiar to  
St Paul's  
epistles.

The causes of obscurity which have been now mentioned are common to all the writers of the epistles; but there are some peculiar to St Paul. 1. As he had an acute and fertile mind, he seems to have written with great rapidity, and without attending much to the common rules of method and arrangement. To this cause we may ascribe his numerous and long parentheses. In the heat of argument he sometimes breaks off abruptly to follow out some new thought; and when he has exhausted it, he returns from his digression without informing his readers; so that it requires great attention to retain the connection. 2. His frequent change of person, too, creates ambiguity: by the pronoun *I* he sometimes means himself; sometimes any Christian; sometimes a Jew, and sometimes any man. In using the pronoun *we* he sometimes intends himself, sometimes comprehends his companions, sometimes the apostles; at one time he alludes to the converted Jews, at another time to the converted Gentiles. 3. There is a third cause of obscurity; he frequently proposes objections, and answers them without giving any formal intimation. There are other difficulties which arise from our uncertainty who are the persons he is addressing, and what are the particular opinions and practices to which he refers. To these we may add two external causes, which have increased the difficulty of understanding the epistles. 1. The dividing them into chapters and verses, which dissolves the connection of the parts, and breaks them into fragments. If Cicero's epistles had been so disjointed, the reading of them would be attended with less pleasure and advantage, and with a great deal more labour. 2. We are accustomed to the phraseology of the epistles from our infancy; but we have either no idea at all when we use it, or our idea of it is derived from the articles or system which we have espoused. But as different sects have arbitrary definitions for St Paul's phrases, we shall never by following them discover the meaning of St Paul, who certainly did not adjust his phraseology to any man's system.

The best plan of studying the epistles is that which was proposed and executed by Mr Locke. This we shall present to our readers in the words of that acute and judicious author.

176  
Mr Locke's  
plan of study-  
ing the  
epistles.

"After I had found by long experience, that the reading of the text and comments in the ordinary way proved not so successful as I wished to the end proposed, I began to suspect that in reading a chapter as was usual, and thereupon sometimes consulting expositors upon some hard places of it, which at that time most affected me, as relating to points then under consideration in my own mind, or in debate amongst others, was

Scripture. not a right method to get into the true sense of these epistles. I saw plainly, after I began once to reflect on it, that if any one should write me a letter as long as St Paul's to the Romans, concerning such a matter as that is, in a style as foreign, and expressions as dubious as his seem to be, if I should divide it into fifteen or sixteen chapters, and read one of them to-day, and another to-morrow, &c. it is ten to one I should never come to a full and clear comprehension of it. The way to understand the mind of him that writ it, every one would agree, was to read the whole letter through from one end to the other all at once, to see what was the main subject and tendency of it: or if it had several views and purposes in it, not dependent one of another, nor in a subordination to one chief aim and end, to discover what those different matters were, and where the author concluded one, and began another; and if there were any necessity of dividing the epistle into parts, to make the boundaries of them.

"In the prosecution of this thought, I concluded it necessary, for the understanding of any one of St Paul's epistles, to read it all thro' at one sitting, and to observe as well as I could the drift and design of his writing it. If the first reading gave me some light, the second gave me more; and so I persisted on reading constantly the whole epistle over at once till I came to have a good general view of the apostle's main purpose in writing the epistle, the chief branches of his discourse wherein he prosecuted it, the arguments he used, and the disposition of the whole.

"This, I confess, is not to be obtained by one or two hasty readings; it must be repeated again and again with a close attention to the tenor of the discourse, and a perfect neglect of the divisions into chapters and verses. On the contrary, the safest way is to suppose that the epistle has but one business and one aim, till by a frequent perusal of it you are forced to see there are distinct independent matters in it, which will forward enough show themselves.

"It requires so much more pains, judgment, and application, to find the coherence of obscure and abstruse writings, and makes them so much the more unfit to serve prejudice and preoccupation when found; that it is not to be wondered that St Paul's epistles have with many passed rather for disjointed, loose, pious discourses, full of warmth and zeal, and overflows of light, rather than for calm, strong, coherent reasonings, that carried a thread of argument and consistency all through them."

Mr Locke tells us he continued to read the same epistle over and over again till he discovered the scope of the whole, and the different steps and arguments by which the writer accomplishes his purpose. For he was convinced before reading his epistles, that Paul was a man of learning, of sound sense, and knew all the doctrines of the gospel by revelation. The speeches recorded in the Acts of the Apostles convinced this judicious critic that Paul was a close and accurate reasoner: and therefore he concluded that his epistles would not be written in a loose, confused, incoherent style. Mr Locke accordingly followed the chain of the apostle's discourse, observed his inferences, and carefully examined from what premises they were drawn, till he obtained a general outline of any particular epistle. If every divine would follow this method, he would soon acquire such a know-  
ledge



Scripture. ledge of Paul's style and manner, that he would peruse his other Epistles with much greater ease.

177  
Epistle to  
the Romans. That the Epistle to the Romans was written at Corinth by St Paul, is ascertained by the testimony of the ancient Christians. It was composed in the year 58, in the 24th year after Paul's conversion, and is the seventh epistle which he wrote. From the Acts of the Apostles we learn that it must have been written within the space of three months; for that was the whole period of Paul's residence in Greece, (Acts x. 1, 2, 3.)

178  
date. The following analysis of this epistle we have taken from a valuable little treatise, intitled A Key to the New Testament, which was written by Dr Percy bishop of Dromore. It exhibits the intention of the apostle, and the arguments which he uses to prove his different propositions, in the most concise, distinct, and connected manner, and affords the best view of this Epistle that we have ever seen.

179  
General de-  
gn. "The Christian church at Rome appears not to have been plagued by any apostle; wherefore St Paul, lest it should be corrupted by the Jews, who then swarmed in Rome, and of whom many were converted to Christianity, sends them an abstract of the principal truths of the gospel, and endeavours to guard them against those erroneous notions which the Jews had of justification, and of the election of their own nation.

"Now the Jews assigned three grounds for justification. First, 'The extraordinary piety and merits of their ancestors, and the covenant made by God with these holy men.' They thought God could not hate the children of such meritorious parents: and as he had made a covenant with the patriarchs to bless their posterity, he was obliged thereby to pardon their sins. Secondly, 'A perfect knowledge and diligent study of the law of Moses.' They made this a plea for the remission of all their sins and vices. Thirdly, 'The works of the Levitical law,' which were to expiate sin, especially circumcision and sacrifices. Hence they inferred that the Gentiles must receive the whole law of Moses, in order to be justified and saved.

"The doctrine of the Jews concerning election was, 'That as God had promised to Abraham to bless his seed, to give him not only spiritual blessings, but also the land of Canaan, to suffer him to dwell there in prosperity, and to consider him as his church upon earth: 'That therefore this blessing extended to their whole nation, and that God was bound to fulfil these promises to them, whether they were righteous or wicked, faithful or unbelieving. They even believed that a prophet ought not to pronounce against their nation the prophecies with which he was inspired; but was rather to beg of God to expunge his name out of the book of the living.

"These previous remarks will serve as a key to unlock this difficult Epistle, of which we shall now give a short analysis. See *Michaelis's Lectures on the New Testament*.

180  
and a ly-  
s of it. "I. The Epistle begins with the usual salutation with which the Greeks began their letters, (chap. i. 1—7.)

"II. St Paul professes his joy at the flourishing state of the church at Rome, and his desire to come and preach the gospel (ver. 8—19.): then he insensibly introduces the capital point he intended to prove, *viz.*

"III. The subject of the gospel (ver. 16, 17.), that it reveals a righteousness unknown before, which is de-

rived solely from faith, and to which Jews and Gentiles have an equal claim. Scripture.

"IV. In order to prove this, he shows (chap. i. 18.—iii. 20.) that both Jews and Gentiles are 'under sin,' *i. e.* that God will impute their sins to Jews as well as to Gentiles.

"His arguments may be reduced to these syllogisms (ch. ii. 1. 17—24.) 1. 'The wrath of God is revealed against those who hold the truth in unrighteousness; *i. e.* who acknowledge the truth, and yet sin against it. 2. The Gentiles acknowledged truths; but, partly by their idolatry, and partly by their other detestable vices, they sinned against the truth they acknowledged. 3. Therefore the wrath of God is revealed against the Gentiles, and punisheth them. 4. The Jews have acknowledged more truths than the Gentiles, and yet they sin. 5. Consequently the Jewish sinners are yet more exposed to the wrath of God (ch. ii. 1—12.) Having thus proved his point, he answers certain objections to it. *Obj.* 1. 'The Jews were well grounded in their knowledge, and studied the law.' He answers, If the knowledge of the law, without observing it, could justify them, then God could not have condemned the Gentiles, who knew the law by nature, (ch. ii. 13—16.) *Obj.* 2. 'The Jews were circumcised.' *Ans.* That is, ye are admitted by an outward sign into the covenant with God. This sign will not avail you when ye violate that covenant (ch. ii. 25. to the end). *Obj.* 3. 'According to this doctrine of St Paul, the Jews have no advantage before others.' *Ans.* Yes, they still have advantages; for unto them are committed the oracles of God. But their privileges do not extend to this, that God should overlook their sins, which, on the contrary, Scripture condemns even in the Jews (ch. iii. 1—19.) *Obj.* 4. 'They had the Levitical law and sacrifices.' *Ans.* From hence is no remission, but only the knowledge of sin, (ch. iii. 20.)

"V. From all this St Paul concludes, that Jews and Gentiles may be justified by the same means, namely, without the Levitical law, through faith in Christ: And in opposition to the imaginary advantages of the Jews, he states the declaration of Zechariah, that God is the God of the Gentiles as well as of the Jews, (ch. iii. 21. to the end.)

"VI. As the whole blessing was promised to the faithful descendants of Abraham, whom both Scripture and the Jews call his children, he proves his former assertion from the example of Abraham; who was an idolater before his call, but was declared just by God, on account of his faith, long before his circumcision. Hence he takes occasion to explain the nature and fruits of faith, (ch. iv. 1. v. 11.)

"VII. He goes on to prove from God's justice, that the Jews had no advantages over the Gentiles with respect to justification. Both Jews and Gentiles had forfeited life and immortality, by the means of one common father of their race, whom they themselves had not chosen. Now as God was willing to restore immortality by a new spiritual head of a covenant, *viz.* Christ, it was just that both Jews and Gentiles should share in this new representative of the whole race (ch. v. 12. to the end).—Chap. v. ver. 15, 16. amounts to this negative question, 'Is it not fitting that the free gift should extend as far as the offence?'

**Scripture.** "VIII. He shows that the doctrine of justification, as stated by him, lays us under the strongest obligations of holiness, (ch. vi. 1. to the end.)

"IX. He shows that the law of Moses no longer concerns us at all; for our justification arises from our appearing in God's sight, as if actually dead with Christ on account of our sins; but the law of Moses was not given to the dead. On this occasion he proves at large, that the eternal power of God over us is not affected by this; and that whilst we are under the law of Moses we perpetually become subject to death, even by sins of inadvertency, (ch. vii. 1. to the end.)

"X. Hence he concludes, that all those, and those only, who are united with Christ, and for the sake of his union, do not live according to the flesh, are free from all condemnation of the law, and have an undoubted share in eternal life, (ch. viii. 1—17)

"XI. Having described their blessedness, he is aware that the Jews, who expected a temporal happiness, should object to him, that Christians notwithstanding endure much suffering in this world. He answers this objection at large, (ch. viii. 18 to the end)

"XII. He shows that God is not the less true and faithful, because he doth not justify, but rather rejects and punishes, those Jews who would not believe the Messiah, (ch. ix. x. xi.) In discussing this point, we may observe the cautious manner in which, on account of the Jewish prejudices, he introduces it (ch. ix. 1—5.), as well as in the discussion itself.

"He shows that the promises of God were never made to all the posterity of Abraham, and that God always reserved to himself the power of choosing those sons of Abraham whom, for Abraham's sake, he intended to bless, and of punishing the wicked sons of Abraham; and that with respect to temporal happiness or misery, he was not even determined in his choice by their works. Thus he rejected Ishmael, Esau, the Israelites in the desert in the time of Moses, and the greater part of that people in the time of Isaiah, making them a sacrifice to his justice, (ch. ix. 6—29)

"He then proceeds to show that God had reason to reject most of the Jews then living, because they would not believe in the Messiah, though the gospel had been preached to them plainly enough, (ch. ix. 30. x. to the end). However, that God had not rejected all his people, but was still fulfilling his promise upon many thousand natural descendants of Abraham, who believed in the Messiah, and would in a future period fulfil them upon more; for that all Israel would be converted, (ch. xi. 1—32.) And he concludes with admiring the wise counsels of God, (ver. 33. to the end.)

"XIII. From the doctrine hitherto laid down, and particularly from this, that God has in mercy accepted the Gentiles; he argues, that the Romans should consecrate and offer themselves up wholly to God. This leads him to mention in particular some Christian duties, (ch. xii. ), viz.

"XIV. He exhorts them to be subject to magistrates (ch. xiii. 1—7.); the Jews at that time being given to sedition.

"XV. To love one another heartily (ver. 2—10.)

And,  
"XVI. To abstain from those vices which were considered as things indifferent among the Gentiles, (ver. 11. to the end.)

"XVII. He exhorts the Jews and Gentiles in the Christian church to brotherly unity, (ch. xiv. 2. xv. 13.)

"XVIII. He concludes his Epistle with an excuse for having ventured to admonish the Romans, whom he had not converted; with an account of his journey to Jerusalem; and with some salutations to those persons whom he meant to recommend to the church at Rome." See *Michaelis's Lectures on the New Testament.*

Corinth was a wealthy and luxurious city, built upon the isthmus which joins the Morea to the northern parts of Greece. In this city Paul had spent two years founding a Christian church, which consisted of a mixture of Jews and Gentiles, but the greater part Gentiles.

About three years after the apostle had left Corinth, he wrote this Epistle from Ephesus in the year 56 or 57, and in the beginning of Nero's reign. That it was written from Ephesus, appears from the salutation with which the Epistle closes, (chap. xvi. 19.) "The churches of Asia salute you. Aquila and Priscilla salute you much in the Lord." From these words it is evident, in the 1st place, that the Epistle was written in Asia. 2dly, It appears from Acts xviii. 18, 19. that Aquila and Priscilla accompanied Paul from Corinth to Ephesus, where they seem to have continued till Paul's departure.

St Paul had certainly kept up a constant intercourse with the churches which he had founded; for he was evidently acquainted with all their revolutions. They seem to have applied to him for advice in those difficult cases which their own understanding could not solve; and he was ready on all occasions to correct their mistakes.

This Epistle consists of two parts. 1. A reproof for those vices to which they were most propense; 2. An answer to some queries which they had proposed to him.

The Corinthians, like the other Greeks, had been accustomed to see their philosophers divide themselves into different sects; and as they brought along with them into the Christian church their former opinions and customs, they wished, as before, to arrange themselves under different leaders. In this Epistle Paul condemns these divisions as inconsistent with the spirit of Christianity, which inculcates benevolence and unanimity, and as opposite to the conduct of Christian teachers, who did not, like the philosophers, aspire after the praise of eloquence and wisdom. They laid no claim to these nor to any honour that cometh from men. The apostle declares, that the Christian truths were revealed from heaven; that they were taught with great plainness and simplicity, and proved by the evidence of miracles, (chap. i. 1). He dissuades them from their divisions and animosities, by reminding them of the great trial which every man's work must undergo; or the guilt they incurred by polluting the temple or church of God; of the vanity of human wisdom; and of glorying in men. He admonishes them to esteem the teachers of the gospel only as the servants of Christ; and to remember that every superior advantage which they enjoyed was to be ascribed to the goodness of God, (chap. iii. 4).

2. In the fifth chapter the apostle considers the case of a notorious offender, who had married his stepmother;

Scripture.

Scripture.

ther; and tells them, that he ought to be excommunicated. He also exhorts the Christians not to associate with any person who led such an openly profane life.

3. He censures the Corinthians for their litigious disposition, which caused them to prosecute their Christian brethren before the Heathen courts. He expresses much warmth and surprise that they did not refer their differences to their brethren; and concludes his exhortations on this subject, by assuring them that they ought rather to allow themselves to be defrauded than to seek redress from Heathens (chap. v. 1—9).

4. He inveighs against those vices to which the Corinthians had been addicted before their conversion, and especially against fornication, the criminality of which they did not fully perceive, as this vice was generally overlooked in the systems of the philosophers, (ch. vi. 10. to the end).

Having thus pointed out the public irregularities with which they were chargeable, he next replies to certain questions which the Corinthians had proposed to him by letter. He, 1. Determines some questions relating to the marriage state; as, 1st, Whether it was good to marry under the existing circumstances of the church? And, 2d, Whether they should withdraw from their partners if they continued unbelievers? (ch. vii).

2 He instructs them how to act with respect to idol offerings. It could not be unlawful in itself to eat the food which had been offered to idols; for the consecration of flesh or wine to an idol did not make it the property of the idol, an idol being nothing, and therefore incapable of property. But some Corinthians thought it lawful to go to a feast in the idol temples, which at the same time were places of resort for lewdness, and to eat the sacrifices whilst praises were sung to the idol. This was publicly joining in the idolatry. He even advises to abstain from such participation as was lawful, rather than give offence to a weak brother; which he enforces by his own example, who had abstained from many lawful things, rather than prove a scandal to the gospel, (chap. viii. ix. x.)

3. He answers a third query concerning the manner in which women should deliver any thing in public, when called to it by a divine impulse. And here he censures the unusual dress of both sexes in prophesying, which exposed them to the contempt of the Greeks, among whom the men usually went uncovered and the women veiled.

Being thus led to the consideration of the abuses that prevailed in their public worship, he goes on to censure the irregularities which were committed at their love-feasts, or, as we term them, the *Lord's Supper*. It was a common practice with the Greeks at their social suppers for every man to bring his own provisions along with him, not, however, to share them with the company, but to feast upon them in a solitary manner. Thus the rich ate and drank to excess, while the poor were totally neglected. The Corinthians introduced the same practice in the celebration of the Lord's Supper, thus confounding it with their ordinary meals, and without ever examining into the end of the institution. It was this gross abuse that Paul reproves in the 11th chapter. He also censures their conduct in the exercise of the extraordinary gifts of the Holy Ghost; he shows them they all proceeded from the same spirit, and

were intended for the instruction of Christian societies; that all Christians ought to be united in mutual love; and that tenderness ought to be shown to the most inconsiderable member, as every one is subservient to the good of the whole (chap. xii). In the 13th chapter he gives a beautiful description of benevolence, which has been much and justly admired. He represents it as superior to the supernatural gifts of the spirit, to the most exalted genius, to universal knowledge, and even to faith. In the 14th chapter he cautions the Corinthians against ostentation in the exercise of the gift of languages, and gives them proper advices.

4. He asserts the resurrection of the dead, in opposition to some of the Corinthians who denied it, founding it upon the resurrection of Jesus Christ, which he considers as one of the most essential doctrines of Christianity. He then answers some objections to the resurrection, drawn from our not being capable of understanding how it will be accomplished, (chap. xv.) He then concludes with some directions to the Corinthian church concerning the manner of collecting alms; promises them a visit, and salutes some of the members.

The second Epistle to the Corinthians was written from Macedonia in the year 57, about a year after the former. See 2 Cor. ix. 1—5. viii. and xiii. 1.

St Paul's first Epistle had wrought different effects among the Corinthians: many of them examined their conduct; they excommunicated the incestuous man; requested St Paul's return with tears; and vindicated him and his office against the false teacher and his adherents. Others of them still adhered to that adversary of St Paul, expressly denied his apostolic office, and even furnished themselves with pretended arguments from that Epistle. He had formerly promised to take a journey from Ephesus to Corinth, thence to visit the Macedonians, and return from them to Corinth (2 Cor. i. 15, 16). But the unhappy state of the Corinthian church made him alter his intention (verse 23), since he found he must have treated them with severity. Hence his adversaries partly argued, 1. That St Paul was irresolute and unsteady, and therefore could not be a prophet; 2. The improbability of his ever coming to Corinth again, since he was afraid of them. Such was the state of the Corinthian church when St Paul, after his departure from Ephesus, having visited Macedonia, (Acts xx. 1.) received an account of the above particulars from Titus (2 Cor. vii. 5, 6.), and therefore wrote them his second Epistle about the end of the same year, or the beginning of 58.

But to give a more distinct view of the contents of this Epistle:

1. The apostle, after a general salutation, expresses his grateful sense of the divine goodness; professing his confidence in God, supported by a sense of his own integrity; makes an apology for not having visited the Corinthians as he had intended, and vindicates himself from the charge of fickleness, (chap. i).

2. He forgives the incestuous man, whose conduct had made so deep an impression on the apostle's mind, that one reason why he had deferred his journey to Corinth was, that he might not meet them in grief, nor till he had received advice of the effect of his apostolical admonitions. He mentions his anxiety to meet Titus at Troas, in order to hear of their welfare; expresses

186  
The second Epistle to the Corinthians.  
187  
State of the Corinthian church.

188  
View of the contents of this Epistle.

185  
and answers certain questions which they had proposed to us.

**Scripture.** his thankfulness to God for the success attending his ministry, and speaks of the Corinthians as his credentials, written by the finger of God, (chap. ii. iii. 1—6.)

3. He treats of the office committed to him of preaching the redemption; and highly prefers it to preaching the law: to which probably his adversaries had made great pretences. They had ridiculed his sufferings; which he shows to be no disgrace to the gospel or its ministers; and here he gives a short abstract of the doctrine he preaches, (chap. iii. 6. v. to the end)

He expatiates with great copiousness on the temper with which, in the midst of afflictions and persecutions, he and his brethren executed their important embassy; and with great affection and tenderness he exhorts them to avoid the pollution of idolatry, (chap. vi). He endeavours to win their confidence, by telling them how much he rejoiced in their amendment and welfare, and how sorry he had been for the distress which his necessary reproofs had occasioned, (chap. vii). He then exhorts them to make liberal contributions for the Christians in Judæa. He recommends to them the example of the Macedonians, and reminds them of the benevolence of the Lord Jesus. He expresses his joy for the readiness of Titus to assist in making the collection; and makes also honourable mention of other Christian brethren, whom he had joined with Titus in the same commission, (chap. viii). He then, with admirable address, urges a liberal contribution, and recommends them to the divine blessing, (chap. ix).

4. Next he obviates some reflections which had been thrown upon him for the mildness of his conduct, as if it had proceeded from fear. He asserts his apostolical power and authority, cautioning his opponents against urging him to give too sensible demonstrations of it, (chap. x). He vindicates himself against the insinuations of some of the Corinthians, particularly for having declined pecuniary support from the church; an action which had been ungenerously turned to his disadvantage. To show his superiority over those designing men who had opposed his preaching, he enumerates his sufferings; gives a detail of some extraordinary revelations which he had received; and vindicates himself from the charge of boasting, by declaring that he had been forced to it by the desire of supporting his apostolical character, (chap. xi. xii.) He closes the Epistle, by assuring them with great tenderness how much it would grieve him to demonstrate his divine commission by feverer methods

186  
Epistle to  
the Galatians.

The Galatians were descended from those Gauls who had formerly invaded Greece, and afterwards settled in Lower Asia. St Paul had preached the gospel among them in the year 51, soon after the council held at Jerusalem, (Acts xvi. 6). Asia swarmed at that time with zealots for the law of Moses, who wanted to impole it upon the Gentiles, (Acts xv. 1). Soon after St Paul had left the Galatians, these false teachers had got among them, and wanted them to be circumcised, &c. This occasioned the following Epistle, which Michaelis thinks was written in the same year, before St Paul left Thessalonica. Dr Lardner dates it about the end of the year 52, or in the very beginning of 53, before St Paul set out to go to Jerusalem by way of Ephesus.

190  
The date

The subject of this Epistle is much the same with

that of the Epistle to the Romans; only this question is more fully considered here, "Whether circumcision, and an observance of the Levitical law, be necessary to the salvation of a Christian convert?" It appears, these Judaizing Christians, whose indirect views St Paul exposes (Acts xv. 1. Gal. v. 3, 9.), at first only represented circumcision as necessary to salvation; but afterwards they insisted upon the Christians receiving the Jewish festivals, (Gal. iv. 10).

**Scripture.**  
191  
And contents of it.

As St Paul had founded the churches of Galatia, and instructed them in the Christian religion, he does not set before them its principal doctrines, as he had done in the Epistle to the Romans; but referring them to what he had already taught (chap. i. 8, 9.), he proceeds at once to the subject of the Epistle.

As it appears from several passages of this Epistle, particularly chap. i. 7, 8, 10. and chap. v. 11. that the Judaizing Christians had endeavoured to persuade the Galatians that Paul himself had changed his opinion, and now preached up the Levitical law; he denies that charge, and affirms that the doctrines which he had taught were true, for he had received them from God by immediate revelation. He relates his miraculous conversion; asserts his apostolical authority, which had been acknowledged by the disciples of Jesus; and, as a proof that he had never inculcated a compliance with the Mosaic law, he declares that he had opposed Peter at Antioch for yielding to the prejudices of the Jews.

Having now vindicated his character from the suspicion of fickleness, and shown that his commission was divine, he argues that the Galatians ought not to submit to the law of Moses: 1. Because they had received the Holy Ghost and the gifts of miracles, not by the law, but by the gospel, (chap. iii. 1—5). 2. Because the promises which God made to Abraham were not restricted to his circumcised descendants, but extended to all who are his children by faith, (chap. iii. 6—18).

192  
Arguments by which the apostle proves that the law of Moses was no obligatory on the Galatians.

In answer to the objection, *To what then serveth the law?* he replies, That it was given because of transgression; that is, to preserve them from idolatry till the Messiah himself should come. 3. Because all men, whether Jews or Gentiles, are made the children of God by faith, or by receiving the Christian religion, and therefore do not stand in need of circumcision, (ch. iii. 26—29.) From the 1st verse of chapter iv. to the 11th, he argues that the law was temporary, being only fitted for a state of infancy; but that the world, having attained a state of manhood under the Messiah, the law was of no farther use. In the remaining part of chap. iv. he reminds them of their former affection to him, and assures them that he was still their sincere friend. He exhorts them to stand fast in the liberty with which Christ had made them free; for the sons of Agar, that is, those under the law given at Mount Sinai, are in bondage, and to be cast out; the inheritance being designed for those only who are the free-born sons of God under the spiritual covenant of the gospel.

193  
Locke on the Epistles.

The apostle next confutes the false report which had been spread abroad among the Galatians, that Paul himself preached up circumcision. He had already indirectly refuted this calumny, by the particular account which he gave of his life; but he now directly and openly contradicts it in the following manner:

193  
How he vindicates his own character from false aspersions.

Scripture.

1. By assuring them, that all who thought circumcision necessary to salvation could receive no benefit from the Christian religion, (chap. v. 2-4).

2. By declaring, that he expected justification only by faith, (ver. 5, 6).

3. By testifying, that they had once received the truth, and had never been taught such false doctrines by him, (ver. 7, 8).

4. By insinuating that they should pass some censure on those who misled them (ver. 9, 10.), by declaring that he was persecuted for opposing the circumcision of the Christians, (ver. 11).

5. By expressing a wish that those persons should be cut off who troubled them with his doctrine.

This Epistle affords a fine instance of Paul's skill in managing an argument. The chief objection which the advocates for the Mosaic law had urged against him was, that he himself preached circumcision. In the beginning of the Epistle he overturns this slander by a statement of facts, without taking any express notice of it; but at the end fully refutes it, that it might leave a strong and lasting impression upon their minds.

He next cautions them against an idea which his arguments for Christian liberty might excite, that it consisted in licentiousness. He shows them it does not consist in gratifying vicious desires; for none are under stronger obligations to moral duties than the Christian. He recommends gentleness and meekness to the weak (chap. vi. 1-5), and exhorts them to be liberal to their teachers, and unto all men (ver. 6-10). He concludes with exposing the false pretences of the Judaizing teachers, and asserting the integrity of his own conduct.

194  
Epistle to  
the Ephesians.

Ephesus was the chief city of all Asia on this side Mount Taurus. St Paul had passed through it in the year 54, but without making any stay, (Acts xviii. 19-21). The following year he returned to Ephesus again, and staid there three years, (chap. xix.) During his abode there he completed a very flourishing church of Christians, the first foundations of which had been laid by some inferior teachers. As Ephesus was frequented by persons of distinction from all parts of Asia Minor, St Paul took the opportunity of preaching in the ancient countries (ver. 10.); and the other churches of Asia were considered as the daughters of the church of Ephesus; so that an Epistle to the Ephesians was, in effect, an epistle to the other churches of Asia at the same time.

195  
The date

Dr Lardner shows it to be highly probable that this Epistle was written in the year 61, soon after Paul's arrival at Rome.

196  
and design  
of it.

As Paul was in a peculiar manner the apostle of the Gentiles, and was now a prisoner at Rome in consequence of having provoked the Jews, by asserting that an observance of the Mosaic law was not necessary to obtain the favour of God, he was afraid lest an advantage should be taken of his confinement to unsettle the minds of those whom he had converted. Hearing that the Ephesians stood firm in the faith of Christ, without submitting to the law of Moses, he writes this Epistle to give them more exalted views of the love of God, and of the excellence and dignity of Christ. This Epistle is not composed in an argumentative or didactic style: The first three chapters consist almost entirely of thank-

givings and prayers, or glowing descriptions of the blessings of the Christian religion. This circumstance renders them a little obscure; but by the assistance of the two following epistles, which were written on the same occasion, and with the same design, the meaning of the apostle may be easily discovered. The last three chapters contain practical exhortations. He first inculcates unity, love, and concord, from the consideration that all Christians are members of the same body, of which Christ is the head. He then advises them to forsake the vices to which they had been addicted while they remained heathens. He recommends justice and charity; strenuously condemns lewdness, obscenity, and intemperance, vices which seem to have been too common among the Ephesians. In the 6th chapter he points out the duties which arise from the relations of husbands and wives, parents and children, masters and servants; and concludes with strong exhortations to fortitude, which he describes in an allegorical manner.

Scripture.

The church at Philippi had been founded by Paul, Silas, and Timothy (Acts xvi.), in the year 61, and had continued to show a strong and manly attachment to the Christian religion, and a tender affection for the apostle. Hearing of his imprisonment at Rome, they sent Epaphroditus, one of their pastors, to supply him with money. It appears from this Epistle that he was in great want of necessaries before this contribution arrived; for as he had not converted the Romans, he did not consider himself as intitled to receive supplies from them. Being a prisoner, he could not work as formerly; and it was a maxim of his never to accept any pecuniary assistance from those churches where a faction had been raised against him. From the Philippians he was not averse to receive a present in the time of want, because he considered it as a mark of their affection, and because he was assured that they had conducted themselves as sincere Christians.

197  
Epistle to  
the Philippians.

It appears from the apostle's own words, that this letter was written while he was a prisoner at Rome, (chap. i. 7, 13. iv. 22.); and from the expectation which he discovers (chap. ii. 24.) of being soon released and restored to them, compared with Philemon v. 22. and Heb. xiii. 13. where he expresses a like expectation in stronger terms, it is probable that this Epistle was written towards the end of his first imprisonment in the year 62.

198  
The date

The apostle's design in this Epistle, which is quite of the practical kind, seems to be, "to comfort the Philippians under the concern they had expressed at the news of his imprisonment; to check a party-spirit that appears to have broke out among them, and to promote, on the contrary, an entire union and harmony of affection; to guard them against being seduced from the purity of the Christian faith by Judaizing teachers; to support them under the trials with which they struggled; and, above all, to inspire them with a concern to adorn their profession by the most eminent attainments in the divine life." After some particular admonitions in the beginning of the 4th chapter, he proceeds in the 8th verse to recommend virtue in the most extensive sense, mentioning all the different foundations in which it had been placed by the Grecian philosophers. Towards the close of the Epistle, he makes his acknowledgments to the Philippians for the seasonable and liberal

199  
and design  
of it.

ral

*Scripture.* ral supply which they had sent him, as it was so convincing a proof of their affection for him, and their concern for the support of the gospel, which he preferred far above any private secular interest of his own; expressly disclaiming all selfish, mercenary views, and assuring them with a noble simplicity, that he was able upon all occasions to accommodate his temper to his circumstances; and had learned, under the teachings of Divine grace, in whatever station Providence might see fit to place him, therewith to be content. After which, the apostle, having encouraged them to expect a rich supply of all their wants from their God and Father, to whom he devoutly ascribes the honour of all, concludes with salutations from himself and his friends at Rome to the whole church, and a solemn benediction, (verse 10. to the end); and declares, that he rejoiced in their liberality chiefly on their own account.

200  
Epistle to  
the Colossians.—Date  
and design  
of it.

The Epistle to the Colossians was written while Paul was in prison (chap. iv. 3.), and was therefore probably composed in the year 62. The intention of the apostle, as far as can be gathered from the Epistle itself, was to secure the Colossians from the influence of some doctrines that were subversive of Christianity, and to excite them to a temper and behaviour worthy of their favored character. A new sect had arisen, which had blended the oriental philosophy with the superstitious opinions of the Jews.

201  
To guard  
the Colossians against  
the dangerous doctrines  
of the Jews.

They held, 1. That God was surrounded by demons or angels, who were mediators with God, and therefore to be worshipped. 2. That the soul is defiled by the body; that all bodily enjoyments hurt the soul, which they believed to be immortal, though they seem to have denied the resurrection of the body, as it would only render the soul sinful by being reunited to it. 3. That there was a great mystery in numbers, particularly in the number seven; they therefore attributed a natural holiness to the seventh or Sabbath day, which they observed more strictly than the other Jews. They spent their time mostly in contemplation; abstained from marriage, and every gratification of the senses; used washings, and thought it sinful to touch certain things; regarded wine as poison, &c.

Percy's Key  
to the New  
Testament.

202  
The arguments  
which the  
apostle employs.

The arguments against these doctrines are managed with great skill and address. He begins with expressing great joy for the favourable character which he had heard of them, and assures them that he daily prayed for their farther improvement. Then he makes a short digression, in order to describe the dignity of Jesus Christ; declares that he had created all things, whether thrones or dominions, principalities and powers; that he alone was the head of the church, and had reconciled men to the Father. The inference from this description is evident, that Jesus was superior to angels; that they were created beings, and ought not to be worshipped. Thus he indirectly confutes one doctrine before he formally opposes it. Paul now returns from his digression in the 21st verse to the sentiments with which he had introduced it in the 13th and 14th verses, and again expresses his joy that the Philippian remained attached to the gospel, which was to be preached to the Gentiles, without the restraints of the ceremonial law. Here again he states a general doctrine, which was inconsistent with the opinions of those who were zealous for the law of Moses; but he leaves the Colossians to draw the inference, (chap. i.)

Having again assured them of his tender concern for their welfare, for their advancement in virtue, and that they might acknowledge the mystery of God, that is, that the gospel was to supersede the law of Moses, he proceeds directly to caution them against the philosophy of the new teachers, and their superstitious adherence to the law; shows the superiority of Christ to the angels, and warns Christians against worshipping them. He censures the observance of Sabbaths, and rebukes those who required abstinence from certain kinds of food, and cautions them against persons who assume a great appearance of wisdom and virtue, (chap. ii.)

In the 3d chapter he exhorts them, that, instead of being occupied about external ceremonies, they ought to cultivate pure morality. He particularly guards them against impurity, to which they had before their conversion been much addicted. He admonishes them against indulging the irascible passions, and against committing falsehood. He exhorts them to cultivate the benevolent affections, and humility, and patience. He recommends also the relative duties between husbands and wives, parents and children, masters and servants. He enjoins the duties of prayer and thanksgiving (ch. iv. 2.), and requests them to remember him in their petitions. He enjoins affability and mild behaviour to the unconverted heathens (verse 6th); and concludes the Epistle with matters which are all of a private nature, except the directions for reading this Epistle in the church of Laodicea, as well as in the church of Colosse.

This Epistle is addressed to the inhabitants of Thessalonica, the capital of Macedonia, a large and populous city. It appears from the Acts, chapter xvii. 1. that the Christian religion was introduced into this city by Paul and Silas, soon after they had left Philippi. At first they made many converts; but at length the Jews, ever jealous of the admission of the Gentiles to the same privileges with themselves, stirred up the rabble, which assaulted the house where the apostle and his friends lodged; so that Paul and Silas were obliged to flee to Berea, where their success was soon interrupted by the same restless and implacable enemies. The apostle then withdrew to Athens; and Timothy, at his desire, returned to Thessalonica (1 Thess. iii. 2.) to see what were the sentiments and behaviour of the inhabitants after the persecution of the Jews. From Athens Paul went to Corinth, where he stayed a year and six months; during which, Timothy returned with the joyful tidings, that the Thessalonians remained stedfast to the faith, and firmly attached to the apostle, notwithstanding his flight. Upon this he sent them this Epistle, A. D. 52, in the 12th year of Claudius.

This is generally reckoned the first Epistle which Paul wrote; and we find he was anxious that it should be read to all the Christians. In chap. v. 27. he uses these words; "I adjure you by the Lord, that this Epistle be read unto all the holy brethren." This direction is very properly inserted in his first Epistle.

The intention of Paul in writing this Epistle was evidently to encourage the Thessalonians to adhere to the Christian religion. This church being still in its infancy, and oppressed by the powerful Jews, required to be established in the faith. St Paul, therefore, in the three first chapters, endeavours to convince the Thessalonians of the truth and divinity of his gospel, both by the

203  
Exhortation.

204  
First Epistle  
to the Thessalonians.

205  
The date

206  
And design  
of it.

*Scripture.* the miraculous gifts of the Holy Ghost which had been imparted, and by his own conduct when among them.

While he appeals, in the first chapter, to the miraculous gifts of the Holy Spirit, he is very liberal in his commendations. He vindicates himself from the charge of timidity, probably to prevent the Thessalonians from forming an unfavourable opinion of his fortitude, which his flight might have excited. He asserts, that he was not influenced by selfish or dishonourable motives, but that he was anxious to please God and not man. He expresses a strong affection for them, and how anxious he was to impart the blessings of the gospel. He congratulates himself upon his success; mentions it to their honour that they received the gospel as the word of God and not of man, and therefore did not renounce it when persecution was raised by the Jews. He expresses a strong desire to visit the Thessalonians; and assures them he had been hitherto retained against his will.

As a farther proof of his regard, the apostle informs them, that when he came to Athens, he was so much concerned, lest, being discouraged by his sufferings, they should be tempted to cast off their profession, that he could not forbear sending Timothy to comfort and strengthen them; and expresses, in very strong terms, the sensible pleasure he felt, in the midst of all his afflictions, from the favourable account he received of their faith and love; to which he adds, that he was continually praying for their farther establishment in religion, and for an opportunity of making them another visit, in order to promote their edification, which lay so near his heart, (chap. iii. throughout.)

Having now shown his paternal affection for them, with great address he improves all that influence which his zeal and fidelity in their service must naturally have given him to inculcate upon them the precepts of the gospel. He recommends chastity, in opposition to the prevailing practice of the heathens; justice, in opposition to fraud. He praises their benevolence, and encourages them to cultivate higher degrees of it. He recommends industry and prudent behaviour to their heathen neighbours. In order to comfort them under the loss of their friends, he assures them that those who were fallen asleep in Jesus should be raised again at the last day, and should, together with those who remained alive, be caught up to meet their Lord, and share his triumph, (chap. iv.) He admonishes them to prepare for this solemn event, that it might not come upon them unawares; and then concludes the Epistle with various exhortations.

<sup>207</sup>  
second E. The second Epistle to the Thessalonians appears to have been written soon after the first, and from the same place; for Silvanus or Silas, and Timothy, are joined together with the apostle in the inscriptions of this Epistle, as well as of the former.

<sup>208</sup>  
contents of The apostle begins with commending the faith and charity of the Thessalonians, of which he had heard a favourable report. He expresses great joy on account of the patience with which they supported persecution; and observes that their persecution was a proof of a

righteous judgment to come, where their persecutors would meet with their proper recompense, and the righteous be delivered out of all their afflictions. He assures them of his constant prayers for their farther improvement, in order to attain the felicity that was promised, (chap. i.)

From misunderstanding a passage in his former letter, it appears that the Thessalonians believed the day of judgment was at hand. To rectify this mistake, he informs them that the day of the Lord will not come till a great apostacy has overspread the Christian world, the nature of which he describes (c). Symptoms of this mystery of iniquity had then appeared; but the apostle expresses his thankfulness to God that the Thessalonians had escaped this corruption. He exhorts them to steadfastness, and prays that God would comfort and strengthen them, (chap. ii.)

He requests the prayers of the Thessalonians for him and his two assistants, at the same time expressing his confidence that they would pay due regard to the instructions which he had given them. He then proceeds to correct some irregularities. Many of the Thessalonians seem to have led an idle disorderly life; these he severely reproveth, and commands the faithful to shun their company if they still remained incorrigible.

When the first Epistle to Timothy was written, it is <sup>209</sup> difficult to ascertain. Lardner dates it in 56; Mill, Whitby, and Macknight, place it in 64; but the arguments on which each party founds their opinion are too long to insert here.

Timothy was the intimate friend and companion of <sup>210</sup> Paul, and is always mentioned by that apostle with much affection and esteem. Having appointed him to superintend the church of Ephesus during a journey which he made to Macedonia, he wrote this letter, in order to direct him how to discharge the important trust which was committed to him. This was the more necessary, as Timothy was young and unexperienced, (1 Tim. iv. 12.) In the beginning of the Epistle he reminds him of the charge with which he had intrusted him, to wit, to preserve the purity of the gospel against the pernicious doctrines of the Judaizing teachers, whose opinions led to frivolous controversies, and not to a good life. He shows the use of the law of Moses, of which these teachers were ignorant. This account of the law, he assures Timothy, was agreeable to the representation of it in the gospel, with the preaching of which he was intrusted. He then makes a digression, in the fulness of his heart, to express the sense which he felt of the goodness of God towards him.

In the second chapter the apostle prescribes the manner in which the worship of God was to be performed in the church of Ephesus; and in the third explains the qualifications of the persons whom he was to ordain as bishops and deacons. In the fourth chapter he foretels the great corruptions of the church which were to prevail in future times, and instructs him how to support the sacred character. In the fifth chapter

he

(c) For an explanation of this prophecy, Dr Hurd's Sermons may be consulted. He applies it to the papal power, to which it corresponds with astonishing exactness.

**Scripture.** he teaches Timothy how to admonish the old and young of both sexes; mentions the age and character of such widows as were to be employed by the society in some peculiar office; and subjoins some things concerning the respect due to elders. In the sixth chapter he describes the duties which Timothy was to inculcate on slaves; condemns trifling controversies and pernicious disputes; censures the excessive love of money, and charges the rich to be rich in good works.

211  
Second E-  
pistle to  
Timothy.

212  
Design and  
contents of  
it.

That the second Epistle to Timothy was written from Rome is universally agreed; but whether it was during his first or second imprisonment has been much disputed. That Timothy was at Ephesus or in Asia Minor when this Epistle was sent to him, appears from the frequent mention in it of persons residing at Ephesus. The apostle seems to have intended to prepare Timothy for those sufferings which he foresaw he would be exposed to. He exhorts him to constancy and perseverance, and to perform with a good conscience the duties of the sacred function.

The false teachers, who had before thrown this church into confusion, grew every day worse: insomuch that not only Hymenæus, but Philetus, another Ephesian heretic, now denied the resurrection of the dead. They were led into this error by a dispute about words. At first they only annexed various improper significations to the word *resurrection*, but at last they denied it altogether (H); pretending that the resurrection of the dead was only a resurrection from the death of sin, and so was already past. This error was probably derived from the eastern philosophy, which placed the origin of sin in the body, (chapter ii.) He then forewarns him of the fatal apostacy and declension that was beginning to appear in the church; and at the same time animates him, from his own example and the great motives of Christianity, to the most vigorous and resolute discharge of every part of the ministerial office.

213  
Epistle to  
Titus.

214  
Design and  
contents of  
it.

This Epistle is addressed to Titus, whom Paul had appointed to preside over the church of Crete. It is difficult to determine either its date or the place from which it was sent. The apostle begins with reminding Titus of the reasons for which he had left him at Crete; and directs him on what principles he was to act in ordaining Christian pastors: the qualifications of whom he particularly describes. To show him how cautious he ought to be in selecting men for the sacred office, he reminds him of the arts of the Judaizing teachers, and the bad character of the Cretans, (chapter i).

He advises him to accommodate his exhortations to the respective ages, sexes, and circumstances, of those whom it was his duty to instruct; and to give the greater weight to his instructions, he admonishes him to be an example of what he taught, (chap. ii). He exhorts him also to teach obedience to the civil magistrate, because the Judaizing Christians affirmed that no obedience was due from the worshippers of the true God to magistrates who were idolaters. He cautions

against censoriousness and contention, and recommends meekness; for even the best Christians had formerly been wicked, and all the blessings which they enjoyed they derived from the goodness of God. He then enjoins Titus strenuously to inculcate good works, and to avoid useless controversies; and concludes with directing him how to proceed with those heretics who attempted to sow dissension in the church.

The Epistle to Philemon was written from Rome at the same time with the Epistles to the Colossians and Philippians, about A. D. 62 or 63. The occasion of the letter was this: Onesimus, Philemon's slave, had robbed his master and fled to Rome; where, happily for him, he met with the apostle, who was at that time a prisoner at large, and by his instructions and admonitions was converted to Christianity, and reclaimed to a sense of his duty. St Paul seems to have kept him for some considerable time under his eye, that he might be satisfied of the reality of the change; and, when he had made a sufficient trial of him, and found that his behaviour was entirely agreeable to his profession, he would not detain him any longer for his own private convenience, though in a situation that rendered such an assistant peculiarly desirable (compare ver. 13, 14.), but sent him back to his master; and, as a mark of his esteem, entrusted him, together with Tychicus, with the charge of delivering his Epistle to the church at Colosse, and giving them a particular account of the state of things at Rome, recommending him to them, at the same time, as a faithful and beloved brother, (Col. iv. 9). And as Philemon might well be supposed to be strongly prejudiced against one who had left his service in so infamous a manner, he sends him this letter, in which he employs all his influence to remove his suspicions, and reconcile him to the thoughts of taking Onesimus into his family again. And whereas St Paul might have exerted that authority which his character as an apostle, and the relation in which he stood to Philemon as a spiritual father, would naturally give him, he chooses to intreat him as a friend; and with the softest and most insinuating address urges his suit, conjuring him by all the ties of Christian friendship that he would not deny him his request: and the more effectually to prevail upon him, he represents his own peace and happiness as deeply interested in the event; and speaks of Onesimus in such terms as were best adapted to soften his prejudices, and dispose him to receive one who was so dear to himself, not merely as a servant, but as a fellow Christian and a friend.

It is impossible to read over this admirable Epistle, without being touched with the delicacy of sentiment, and the matterly address that appear in every part of it. We see here, in a most striking light, how perfectly consistent true politeness is, not only with all the warmth and sincerity of the friend, but even with the dignity of the Christian and the apostle. And if this letter were to be considered in no other view than as a mere human composition, it must be allowed a master-piece in its kind. As an illustration of this remark, it may not be improper

(H) This is by no means uncommon amongst men; to begin to dispute about the signification of words, and to be led gradually to deny the thing signified. This appears to have been the cause of most disputes, and the general beginnings of scepticism and infidelity.

**Scripture.**

215  
Epistle to  
Philemon.  
—Date and  
design of it

Doddridge's  
Family Ex-  
positor.

216  
The skill  
and address  
which the  
apostle dis-  
covers in  
this Epistle



*Scripture.* improper to compare it with an epistle of Pliny, that seems to have been written upon a similar occasion, (*lib. ix. let. 21.*); which, though penned by one that was reckoned to excel in the epistolary style, and though it has undoubtedly many beauties, yet must be acknowledged, by every impartial reader, vastly inferior to this animated composition of the apostle.

*217*  
The Epistle to the Hebrews has been generally ascribed to Paul; but the truth of this opinion has been suspected by others, for three reasons: 1. The name of the writer is nowhere mentioned, neither in the beginning nor in any other part of the Epistle. 2. The style is said to be more elegant than Paul's. 3. There are expressions in the Epistle which have been thought unsuitable to an apostle's character. 1. In answer to the first objection, Clemens Alexandrinus has assigned a very good reason: "Writing to the Hebrews (says he), who had conceived a prejudice against him, and were suspicious of him, he wisely declined setting his name at the beginning, lest he should offend them." 2. Origen and Jerome admired the elegance of the style, and reckoned it superior to that which Paul has exhibited in his Epistles: but as ancient testimony had assigned it to Paul, they endeavoured to answer the objection, by supposing that the sentiments were the apostle's, but the language and composition the work of some other person. If the Epistle, however, be a translation, which we believe it to be, the elegance of the language may belong to the translator. As to the composition and arrangement, it cannot be denied that there are many specimens in the writings of this apostle not inferior in these qualities to the Epistle to the Hebrews. 3. It is objected, that in Heb. ii. 3. the writer of this Epistle joins himself with those who had received the gospel from Christ's apostles. Now Paul had it from Christ himself. But Paul often appeals to the testimony of the apostles in support of those truths which he had received from Revelation: We may instance 1 Cor. xv. 5, 6, 7, 8.; 2 Tim. ii. 2.

*218*  
This Epistle is not quoted till the end of the second century, and even then does not seem to have been universally received. This silence might be owing to the Hebrews themselves, who supposing this letter had no relation to the Gentiles, might be at no pains to diffuse copies of it. The authors, however, on whose testimony we receive it as authentic, are entitled to credit; for they lived so near the age of the apostles, that they were in no danger of being imposed on; and from the numerous list of books which they rejected as spurious, we are assured that they were very careful to guard against imposition. It is often quoted as Paul's by Clemens Alexandrinus, about the year 194. It is received and quoted as Paul's by Origen, about 230; by Dionysius bishop of Alexandria in 247; and by a numerous list of succeeding writers.

*219*  
The Epistle to the Hebrews was originally written in Hebrew, or rather Syro-Chaldaic; a fact which we believe on the testimony of Clemens Alexandrinus, Jerome, and Eusebius. To this it has been objected, that as these writers have not referred to any authority, we ought to consider what they say on this subject merely as an opinion. But as they state no reasons for adopting this opinion, but only mention as a fact that Paul wrote to the Hebrews in their native language, we must allow that it is their testimony which they

produce, and not their opinion. Eusebius informs us, *Scripture.* that some supposed Luke the Evangelist, and others Clemens Romanus, to have been the translator.

According to the opinion of ancient writers, particularly Clemens Alexandrinus, Jerome, and Euthalius, this Epistle was addressed to the Jews in Palestine.—The scope of the Epistle confirms this opinion.

*220*  
Having now given sufficient evidence that this Epistle was written by Paul, the time when it was written may be easily determined: For the salutation from the saints of Italy (chap. iv. 24.), together with the apostle's promise to see the Hebrews (ver. 23.), plainly intimate, that his confinement was then either ended or on the eve of being ended. It must therefore have been written soon after the Epistles to the Colossians, Ephesians, and Philemon, and not long before Paul left Italy, that is, in the year 61 or 62.

As the zealous defenders of the Mosaic law would naturally insist on the divine authority of Moses, on the majesty and glory attending its promulgation by the ministry of angels, and the great privileges it afforded those who adhered to it; the apostle shows,

I. That in all these several articles Christianity had an infinite superiority to the law.

*221*  
This topic he pursues from chap. i. to xi. wherein he reminds the believing Hebrews of the extraordinary favour shown them by God, in sending them a revelation by his own son, whose glory was far superior to that of angels (chap. i. throughout); very naturally inferring from hence the danger of despising Christ on account of his humiliation, which, in perfect consistency with his dominion over the world to come, was voluntarily submitted to by him for wise and important reasons; particularly to deliver us from the fear of death, and to encourage the freedom of our access to God (chap. ii. throughout). With the same view he magnifies Christ as superior to Moses, their great legislator; and from the punishment inflicted on those who rebelled against the authority of Moses, infers the danger of contemning the promises of the gospel (chap. iii. 2—13). And as it was an easy transition to call to mind on this occasion that rest in Canaan to which the authority invested in Moses was intended to lead them; the apostle hence cautions them against unbelief, as what would prevent their entering into a superior state of rest to what the Jews ever enjoyed (chap. iii. 14. iv. 11). This caution is still farther enforced by awful views of God's omniscience, and a lively representation of the high-priesthood of Christ (chap. iv. to the end; and Chap. v. throughout). In the next place, he intimates the very hopeless situation of those who apostatise from Christianity (chap. vi. 1—9.); and then, for the comfort and confirmation of sincere believers, displays to them the goodness of God, and his faithful adherence to his holy engagements; the performance of which is sealed by the entrance of Christ into heaven as our forerunner (chap. vi. 9. to the end). Still farther to illustrate the character of our Lord, he enters into a parallel between him and Melchizedec as to their title and descent; and, from instances wherein the priesthood of Melchizedec excelled the Levitical, infers, that the glory of the priesthood of Christ surpassed that under the law (chap. vii. 1—17). From these premises the apostle argues, that the Aaronical priesthood was not only excelled, but consummated by that of Christ,

**Scripture.** to which it was only introductory and subservient; and of course, that the obligation of the law was henceforth dissolved (chap. vii. 18. to the end). Then recapitulating what he had already demonstrated concerning the superior dignity of Christ's priesthood, he thence illustrates the distinguished excellence of the new covenant, as not only foretold by Jeremiah, but evidently enriched with much better promises than the old (ch. viii. throughout): Explaining farther the doctrine of the priesthood and intercession of Christ, by comparing it with what the Jewish high-priests did on the great day of atonement (chap. ix. 1—14). Afterwards he enlarges on the necessity of shedding Christ's blood, and the sufficiency of the atonement made by it (chap. ix. 15. to the end); and proves that the legal ceremonies could not by any means purify the conscience: whence he infers the insufficiency of the Mosaic law, and the necessity of looking beyond it (chap. x. 1—15.). He then urges the Hebrews to improve the privileges which such an high-priest and covenant conferred on them, to the purposes of approaching God with confidence, to a constant attendance on his worship, and most benevolent regards to each other (chap. x. 15—25).

The apostle having thus obviated the insinuations and objections of the Jews, for the satisfaction and establishment of the believing Hebrews, proceeds,

222  
And to animate them to bear persecution with fortitude.

II. To prepare and fortify their minds against the storm of persecution which in part had already befallen them, which was likely to continue and be often renewed, he reminds them of those extremities they had endured, and of the fatal effects which would attend their apostacy (chap. x. 26. to the end); calling to their remembrance the eminent examples of faith and fortitude exhibited by holy men, and recorded in the Old Testament (chap. xi. 1—29). He concludes his discourse with glancing at many other illustrious worthies; and, besides those recorded in Scripture, refers to the case of several who suffered under the persecution of Antiochus Epiphanes (2 Maccab. chap. viii. &c. chap. xi. 30. xii. 2).

Having thus finished the argumentative part of the Epistle, the apostle proceeds to a general application; in which he exhorts the Hebrew Christians to patience, peace, and holiness (Chap. xii. 3—14.); cautions them against secular views and sensual gratifications, by laying before them the incomparable excellence of the blessings introduced by the gospel, which even the Jewish economy, glorious and magnificent as it was, did by no means equal; exhorts them to brotherly affection, purity, compassion, dependence on the divine care, steadfastness in the profession of truth, a life of thankfulness to God, and benevolence to man: and concludes the whole with recommending their pious ministers to their particular regard, intreating their prayers, saluting and granting them his usual benediction.

223  
The seven Catholic epistles.

The seven following Epistles, one of James, two of Peter, three of John, and one of Jude, have been distinguished by the appellation of *catholic* or *general* epistles, because most of them are inscribed, not to particular churches or persons, but to the body of Jewish or Gentile converts over the world. The authenticity of some of these has been frequently questioned, viz. the Epistle of James, the second of Peter, the Epistle of Jude, and the second and third of John. The ancient

Christians were very cautious in admitting any books **Scripture.** into their canon whose authenticity they had any reason to suspect. They rejected all the writings forged by heretics in the name of the apostles, and certainly, therefore, would not receive any without first subjecting them to a severe scrutiny. Now, though these five epistles were not immediately acknowledged as the writings of the apostles, this only shows that the persons who doubted had not received complete and incontestable evidence of their authenticity. But as they were afterwards universally received, we have every reason to conclude, that upon a strict examination they were found to be the genuine productions of the apostles. The truth is, so good an opportunity had the ancient Christians of examining this matter, so careful were they to guard against imposition, and so well founded was their judgment concerning the books of the New Testament, that, as Dr Lardner observes, no writing which they pronounced genuine has yet been proved spurious, nor have we at this day the least reason to believe any book genuine which they rejected.

That the Epistle of James was written in the apostolical age is proved by the quotations of ancient authors. Clement Romanus and Ignatius seem to have made references to it. Origen quotes it once or twice.— There are several reasons why it was not more generally quoted by the first Christian writers. Being written to correct the errors and vices which prevailed among the Jews, the Gentiles might think it of less importance to them, and therefore take no pains to procure copies of it. As the author was sometimes denominated James the Just, and often called bishop of Jerusalem, it might be doubted whether he was one of the apostles. But its authenticity does not seem to have been suspected on account of the doctrines which it contains. In modern times, indeed, Luther called it a strawy epistle (*epistola straminea*), and excluded it from the sacred writings, on account of its apparent opposition to the apostle Paul concerning justification by faith.

This Epistle could not be written by James the Elder, the son of Zebedee, and brother of John, who was beheaded by Herod in the year 44, for it contains passages which refer to a later period. It must, therefore, have been the composition of James the Less, the son of Alpheus, who was called *the Lord's brother*, because he was the son of Mary, the sister of our Lord's mother. As to the date of this Epistle, Lardner fixes it in the year 61 or 62.

James the Less stately resided at Jerusalem, whence he hath been styled by some ancient fathers bishop of that city, though without sufficient foundation. Now James being one of the apostles of the circumcison, while he confined his personal labours to the inhabitants of Judea, it was very natural for him to endeavour by his writings to extend his services to the Jewish Christians who were dispersed abroad in more distant regions. For this purpose, there are two points which the apostle seems to have principally aimed at, though he hath not pursued them in an orderly and logical method, but in the free epistolary manner, handling them jointly or distinctly as occasions naturally offered. And these were, "to correct those errors both in doctrine and practice into which the Jewish Christians had fallen, which might otherwise have produced fatal consequences;

224  
Epistle of James the Less.

225  
The date

Dodridge's Family Expositor.

226  
and design of it.

Scripture. ces; and then to establish the faith and animate the hope of sincere believers, both under their present and their approaching sufferings."

The opinions which he is most anxious to refute are these, that God is the author of sin, (ch. i. 13.); that the belief of the doctrines of the gospel was sufficient to procure the favour of God for them, however deficient they were in good works, (ch. ii.) He dissuades the Jews from aspiring to the office of teachers in the third chapter, because their prejudices in favour of the law of Moses might induce them to pervert the doctrines of the gospel. He therefore guards them against the sins of the tongue, by representing their pernicious effects; and as they thought themselves wise and intelligent, and were ambitious of becoming teachers, he advises them to make good their pretensions, by showing themselves possessed of that wisdom which is from above, (ch. iii.)

The destruction of Jerusalem was now approaching; the Jews were split into factions, and often slaughtered one another; the apostle, therefore, in the fourth chapter, admonishes them to purify themselves from those vices which produced tumults and bloodshed. To rouse them to repentance, he foretells the miseries that were coming upon them. Lastly, he checks an irreligious spirit that seems to have prevailed, and concludes the Epistle with several exhortations.

The authenticity of the first Epistle of Peter has never been denied. It is referred to by Clemens Romanus, by Polycarp, and is quoted by Papias, Irenæus, Clemens Alexandrinus, and Tertullian. It is addressed to the strangers scattered through Pontus, &c. who are evidently Christians in general, as appears from chap. ii. 10. "In time past they were not a people, but are now the people of God." From Peter's sending the salutation of the church at Babylon to the Christians in Pontus, &c. it is generally believed that he wrote it in Babylon. There was a Babylon in Egypt and another in Assyria. It could not be the former, for it was an obscure place, which seems to have had no church for the four first centuries. We have no authority to affirm that Peter ever was in Assyria. The most probable opinion is that of Grotius, Whitby, Lardner, as well as of Eusebius, Jerome, and others, that by Babylon Peter figuratively means Rome. Lardner dates it in 63 or 64, or at the latest 65.

217  
First Epistle of Peter.

218  
The date

219  
And design of it.

St Peter's chief design is to confirm the doctrine of St Paul, which the false teachers pretended he was opposing; and to assure the profelytes that they stood in the true grace of God, (ch. v. 12.) With this view he calls them elect; and mentions, that they had been declared such by the effusion of the Holy Ghost upon them, (ch. i. 1, 2.) He assures them that they were regenerate without circumcision, merely through the gospel and resurrection of Christ, (ver. 3, 4. 21—25.); and that their sufferings were no argument of their being under the displeasure of God, as the Jews imagined, (ver. 6—12.) He recommends it to them to hope for grace to the end, (ver. 13.) He testifies, that they were not redeemed by the Paschal lamb, but through Christ, whom God had preordained for this purpose before the foundation of the world, (ver. 18—20.)

The second Epistle of Peter is not mentioned by any ancient writer extant till the fourth century, from which

time it has been received by all Christians except the Syrians. Jerome acquaints us, that its authenticity was disputed, on account of a remarkable difference between the style of it and the former Epistle. But this remarkable difference in style is confined to the 2d chapter of the 2d Epistle. No objection, however, can be drawn from this circumstance; for the subject of that chapter is different from the rest of Peter's writings, and nothing is so well known than that different subjects suggest different styles. Peter, in describing the character of some flagitious impostors, feels an indignation which he cannot suppress: it breaks out, therefore, in the bold and animated figures of an oriental writer. Such a diversity of style is not uncommon in the best writers, especially when warmed with their subject.

This objection being removed, we contend that this Epistle was written by Peter, from the inscription, *Simon Peter, a servant and an apostle of Jesus Christ*. It appears from chap. i. 16, 17, 18, that the writer was one of the disciples who saw the transfiguration of our Saviour. Since it has never been ascribed to James or John, it must therefore have been Peter. It is evident, from chap. iii. 1. that the author had written an Epistle before to the same persons, which is another circumstance that proves Peter to be the author.

It is acknowledged, however, that all this evidence is merely internal; for we have not been able to find any external evidence upon the subject. If, therefore, the credit which we give to any fact is to be in proportion to the degree of evidence with which it is accompanied, we shall allow more authority due to the gospels than to the epistles; more to those epistles which have been generally acknowledged than to those which have been controverted; and therefore no doctrine of Christianity ought to be founded solely upon them. It may also be added, that perhaps the best way of determining what are the essential doctrines of Christianity would be to examine what are the doctrines which occur ostent in the gospels; for the gospels are the plainest parts of the New Testament; and their authenticity is most completely proved. They are therefore best fitted for common readers. Nor will it be denied, we presume, that our Saviour taught all the doctrines of the Christian religion himself; that he repeated them on different occasions, and inculcated them with an earnestness proportionable to their importance. The Epistles are to be considered as a commentary on the essential doctrines of the gospel, adapted to the situation and circumstances of particular churches, and perhaps sometimes explaining doctrines of inferior importance. 1. The essential doctrines are therefore first to be sought for in the gospels, and to be determined by the number of times they occur. 2. They are to be sought for, in the next place, in the uncontroverted Epistles, in the same manner. 3. No essential doctrine ought to be founded on a single passage, nor on the authority of a controverted Epistle.

That Peter was old, and near his end, when he wrote this Epistle, may be inferred from chap. i. 14. "Knowing that shortly I must put off this tabernacle, even as our Lord Jesus has shewn me." Lardner thinks it was written soon after the former. Others, perhaps with more accuracy, date it in 67.

The general design of this Epistle is, to confirm the doctrines and instructions delivered in the former; "to excite the Christian converts to adorn, and stedfastly ad-

Scripture. here to their holy religion, as a religion proceeding from God, notwithstanding the artifices of false teachers, whose character is at large described; or the persecution of their bitter and inveterate enemies."

233  
First Epistle of John. Its authenticity and style.

The first Epistle of John is ascribed by the unanimous suffrage of the ancients to the beloved disciple of our Lord. It is referred to by Polycarp, is quoted by Papias, by Irenæus, and was received as genuine by Clemens Alexandrinus, by Dionysius of Alexandria, by Cyprian, by Origen, and Eusebius. There is such a resemblance between the style and sentiments of this Epistle and those of the gospel according to John, as to afford the highest degree of internal evidence that they are the composition of the same author. In the style of this apostle there is a remarkable peculiarity, and especially in this Epistle. His sentences, considered separately, are exceeding clear and intelligible; but when we search for their connection, we frequently meet with greater difficulties than we do even in the Epistles of St Paul. The principal signature and characteristic of his manner is an artless and amiable simplicity, and a singular modesty and candour, in conjunction with a wonderful sublimity of sentiment. His conceptions are apparently delivered to us in the order in which they arose to his own mind, and are not the product of artificial reasoning or laboured investigation.

It is impossible to fix with any precision the date of this Epistle, nor can we determine to what persons it was addressed.

234  
Design of it.

The leading design of the apostle is to show the insufficiency of faith, and the external profession of religion, separate from morality; to guard the Christians to whom he writes against the delusive arts of the corrupters of Christianity, whom he calls Antichrist; and to inculcate universal benevolence. His admonitions concerning the necessity of good morals, and the inefficacy of external professions, are scattered over the Epistle, but are most frequent in the 1st, 2d, and 3d chapters. The enemies or corrupters of Christianity, against whom he contends, seem to have denied that Jesus was the Messiah, the Son of God (chap. ii. 22. v. 1.), and had actually come into the world in a human form, (chap. iv. 2, 3.) The earnestness and frequency with which this apostle recommends the duty of benevolence is remarkable. He makes it the distinguishing characteristic of the disciples of Jesus, the only sure pledge of our love to God, and the only assurance of eternal life, (chap. iii. 14, 15.) Benevolence was his favourite theme, which he affectionately pressed upon others, and constantly practised himself. It was conspicuous in his conduct to his great Master, and in the reciprocal affection which it inspired in his sacred breast. He continued to recommend it in his last words. When his extreme age and infirmities had so wasted his strength that he was incapable to exercise the duties of his office, the venerable old man, anxious to exert in the service of his Master the little strength which still remained, caused himself to be carried to church, and, in the midst of the congregation, he repeated these words, "Little children, love one another."

235  
Second and third Epistles of John.

It has been observed by Dr Mill that the second and third Epistles of John are so short, and resemble the first so much in sentiment and style, that it is not worth while to contend about them. The second Epistle con-

Scripture. sists only of 13 verses; and of these eight may be found in the 1st Epistle, in which the sense or language is precisely the same.

The second Epistle is quoted by Irenæus, and was received by Clemens Alexandrinus. Both were admitted by Athanasius, by Cyril of Jerusalem, and by Jerome. The second is addressed to a woman of distinction whose name is by some supposed to be *Cyria* (taking *κυρια* for a proper name), by others *Ecclesia*. The third is inscribed to Gaius, or Caius according to the Latin orthography, who, in the opinion of Lardner, was an eminent Christian, that lived in some city of Asia not far from Ephesus, where St John chiefly resided after his leaving Judea. The time of writing these two Epistles cannot be determined with any certainty. They are so short that an analysis of them is not necessary.

The Epistle of Jude is cited by no ancient Christian writer extant before Clemens Alexandrinus about the year 194; but this author has transcribed eight or ten verses in his *Stromata* and *Pedagogue*. It is quoted once by Tertullian about the year 200; by Origen frequently about 230. It was not however received by many of the ancient Christians, on account of a supposed quotation from a book of Enoch. But it is not certain that Jude quotes any book. He only says that *Enoch prophesied, saying, The Lord cometh with ten thousand of his saints*. These might be words of a prophecy preserved by tradition, and inserted occasionally in different writings. Nor is there any evidence that there was such a book as Enoch's prophecies in the time of Jude, though a book of that name was extant in the second and third centuries. As to the date of this Epistle nothing beyond conjecture can be produced.

The design of it is, by describing the character of the false teachers, and the punishments to which they were liable, to caution Christians against listening to their suggestions, and being thereby perverted from the faith and purity of the gospel.

The Apocalypse or Revelation has not always been unanimously received as the genuine production of the apostle John. Its authenticity is proved, however, by the testimony of many respectable authors of the first centuries. It is referred to by the martyrs of Lyons: it was admitted by Justin Martyr as the work of the apostle John. It is often quoted by Irenæus, by Theophilus bishop of Antioch, by Clement of Alexandria, by Tertullian, by Origen, and by Cyprian of Carthage. It was also received by Heretics, by Novatus and his followers, by the Donatists, and by the Arians. For the first two centuries no part of the New Testament was more universally acknowledged, or mentioned with higher respect. But a dispute having arisen about the millennium, Caius with some others, about the year 212, to end the controversy as speedily and effectually as possible, ventured to deny the authority of the book which had given occasion to it.

The book of Revelation, as we learn from Rev. i. 9. was written in the isle of Patmos. According to the general testimony of ancient authors, John was banished into Patmos in the reign of Domitian, and restored by his successor Nerva. But the book could not be published till after John's release, when he returned to Ephesus. As Domitian died in 96, and his persecution

Scripture. did not commence till near the end of his reign, the Revelation might therefore be published in 96 or 97.

Here we should conclude; but as the curious reader may desire to be informed how the predictions revealed in this book of St John have usually been interpreted and applied, we shall consistently with our subject subjoin a key to the prophecies contained in the Revelation. This is extracted from the learned dissertations of Dr Newton, bishop of Bristol (1); to which the reader is referred for a more full illustration of the several parts, as the conciseness of our plan only admits a short analysis or abridgment of them.

Nothing of a prophetic nature occurs in the first three chapters, except, 1. What is said concerning the church of Ephesus, that her "candlestick shall be removed out of its place," which is now verified, not only in this, but in all the other Asiatic churches which existed at that time; the light of the gospel having been taken from them, not only by their heresies and divisions from within, but by the arms of the Saracens from without: And, 2. Concerning the church of Smyrna, that she shall "have tribulation ten days;" that is, in prophetic language, "ten years;" referring to the persecutions of Dioclesian, which alone of all the general persecutions lasted so long.

The next five chapters relate to the opening of the Seven Seals; and by these seals are intimated so many different periods of the prophecy. Six of these seals are opened in the sixth and seventh chapters.

The first seal or period is memorable for conquests. It commences with Vespasian, and terminates in Nerva; and during this time Judea was subjugated. The second seal is noted for war and slaughter. It commences with Trajan, and continues through his reign, and that of his successors. In this period, the Jews were entirely routed and dispersed; and great was the slaughter and desolation occasioned by the contending parties. The third seal is characterized by a rigorous execution of justice, and an abundant provision of corn, wine, and oil. It commences with Septimius Severus. He and Alexander Severus were just and severe emperors, and at the same time highly celebrated for the regard they paid to the felicity of their people, by procuring them plenty of every thing, and particularly corn, wine, and oil. This period lasted during the reigns of the Septimian family. The fourth seal is distinguished by a concurrence of evils, such as war, famine, pestilence, and wild beasts; by all which the Roman empire was remarkably infested from the reign of Maximin to that of Dioclesian. The fifth seal begins at Dioclesian, and is signalized by the great persecution, from whence arose that memorable era, the Era of Martyrs. With Constantine begins the sixth seal, a period of revolutions, pictured forth by great commotions in earth and in heaven, alluding to the subversion of Paganism and the establishment of Christianity. This period lasted from the reign of Constantine the Great to that of Theodosius the first. The seventh seal includes under it the remaining parts of the prophecy, and com-

prehends seven periods distinguished by the sounding of seven trumpets.

As the seals foretold the state of the Roman empire before and till it became Christian, so the trumpets foreshew the fate of it afterwards; each trumpet being an alarm to one nation or other, rousing them up to overthrow that empire.

Four of these trumpets are sounded in the eighth chapter.

At the founding of the first, Alaric and his Goths invade the Roman empire, besiege Rome twice, and set it on fire in several places. At the founding of the second, Attila and his Huns waste the Roman provinces, and compel the eastern emperor Theodosius the second, and the western emperor Valentinian the third, to submit to shameful terms. At the founding of the third, Genseric and his Vandals arrive from Africa; spoil and plunder Rome, and set sail again with immense wealth and innumerable captives. At the founding of the fourth, Odoacer and the Heruli put an end to the very name of the western empire; Theodoric founds the kingdom of the Ostrogoths in Italy; and at last Italy becomes a province of the eastern empire, Rome being governed by a duke under the exarch of Ravenna. As the foregoing trumpets relate chiefly to the downfall of the western empire, so do the two following to that of the eastern. They are sounded in the ninth, tenth, and part of the eleventh chapters. At the founding of the fifth trumpet, Mahomet, that blazing star, appears, opens the bottomless pit, and with his locusts the Arabians darkens the sun and air. And at the founding of the sixth, a period not yet finished, the four angels, that is, the four sultanes, or leaders of the Turks and Ottomans, are loosed from the river Euphrates. The Greek or Eastern empire was cruelly "hurt and tormented" under the fifth trumpet; but under the sixth, it was "slain," and utterly destroyed.

The Latin or Western Church not being reclaimed by the ruin of the Greek or Eastern, but still persisting in their idolatry and wickedness; at the beginning of the tenth chapter, and under the sound of this sixth trumpet, is introduced a vision preparative to the prophecies respecting the Western Church, wherein an angel is represented, having in his hand a little book, or codicil, describing the calamities that should overtake that church. The measuring of the temple shows, that during all this period there will be some true Christians, who will conform themselves to the rule of God's word, even whilst the outer court, that is, the external and more extensive part of this temple or church, is trodden under foot by Gentiles, i. e. such Christians as, in their idolatrous worship and persecuting practice, resemble and outdo the Gentiles themselves. Yet against these corrupters of religion there will always be some true witnesses to protest, who, however they may be overborne at times, and in appearance reduced to death, yet will arise again from time to time, till at last they triumph and gloriously ascend. The eleventh chapter concludes with the sounding of the seventh trumpet.

I 2

(1) Dissertations on the prophecies which have remarkably been fulfilled, and at this time are fulfilling, in the world, vol. iii. 8vo.

Scripture,  
Scrivener.

In the twelfth chapter, by the woman bearing a man-child is to be understood the Christian church; by the great red dragon, the heathen Roman empire; by the man-child whom the woman bore, Constantine the Great; and by the war in heaven, the contests between the Christian and Heathen religions.

In the thirteenth chapter, by the beast with seven heads and ten horns, unto whom the dragon gave his power, feat, and great authority, is to be understood, not Pagan but Christian, not imperial but papal Rome; in submitting to whose religion, the world did in effect submit again to the religion of the dragon. The ten-horned beast therefore represents the Romish church and state in general: but the beast with two horns like a lamb is the Roman clergy; and that image of the ten-horned beast, which the two-horned beast caused to be made, and inspired with life, is the pope; whose number is 666, according to the numerical powers of the letters constituting the Roman name *Λατίνος, Latinus*, or its equivalent in Hebrew, רמיתח *Ramith*.

A	30	200	7
A	1	6	7
T	300	40	0
E	5	10	0
I	10	10	0
N	50	400	0
O	70		
Σ	200		
<hr/>		<hr/>	
	666		666

Chapter xiv. By the lamb on mount Sion is meant Jesus; by the hundred forty and four thousand, his church and followers; by the angel preaching the everlasting gospel, the first principal effort made towards a reformation by that public opposition formed against the worship of saints and images by emperors and bishops in the eighth and ninth centuries; by the angel crying, "Babylon is fallen," the Waldenses and Albigeuses, who pronounced the church of Rome to be the Apocalyptic Babylon, and denounced her destruction; and by the third angel, Martin Luther and his fellow reformers, who protested against all the corruptions of the church of Rome, as destructive to salvation. For an account of the doctrines and precepts contained in the Scriptures, see THEOLOGY. For proofs of their divine origin, see RELIGION, PROPHECY, and MIRACLES.

SCRIVENER, one who draws contracts, or whose business it is to place money at interest. If a scrivener is entrusted with a bond, he may receive the interest; and if he fails, the obligee shall bear the loss: and so it is if he receive the principal and deliver up the bond; for being entrusted with the security itself, it must be presumed that he is trusted with power to receive interest or principal; and the giving up the bond on payment of the money shall be a discharge thereof. But if a scrivener shall be entrusted with a mortgage-deed, he hath only authority to receive the interest, not the principal; the giving up the deed in this case not being sufficient to restore the estate, but there must be a reconveyance, &c. It is held, where a scrivener puts out his client's money on a bad security, which upon inquiry might have been easily found so, yet he cannot in equity be charged to answer for the money; for it is

here said, no one would venture to put out money of another upon a security, if he were obliged to warrant and make it good in case a loss should happen, without any fraud in him.

SCROBICULUS CORDIS, the same as ANTICARDIUM.

SCROFANELLO, in ichthyology, a name by which some have called a small fish of the Mediterranean, more usually known by the name of the *scorpena*.

SCROLL, in HERALDRY. See that article, chap. iv. sect. 9. When the motto relates to the crest, the scroll is properly placed above the achievement; otherwise it should be annexed to the escutcheon. Those of the order of knighthood are generally placed round shields.

SCROPHULA, the KING'S EVIL. See MEDICINE, n<sup>o</sup> 349.

SCROPHULARIA, FIGWORT, in botany: A genus of the angiospermia order, belonging to the didynamia class of plants; and in the natural method ranking under the 40th order, *Personate*. The calyx is quinquefid; the corolla almost globose, and resupinated; the capsule bilocular. There are several species, of which the most remarkable are, 1. *Nodosa*, or the common figwort, which grows in woods and hedges. The root is tuberous; the stalks are four or five feet high, and branched towards the top; the leaves are heart-shaped, serrated, and acute. The flowers are of a dark red colour, shaped like a cap or helmet; the lower lip greenish: they grow in loose dichotomous spikes or *racemi* at the top of the branches. The leaves have a fetid smell and bitter taste. A decoction of them is said to cure hogs of the measles. An ointment made of the root was formerly used to cure the piles and scrophulous sores, but is at present out of practice. 2. *Aquatica*, water-figwort, or betony. The root is fibrous; stem erect, square, about four feet high. The leaves are opposite, elliptical, pointed, slightly scalloped, on decurrent footstalks. Flowers purple, in loose naked spikes. It grows on the sides of rivulets and other wet places, and has a fetid smell, though not so strong as the preceding. The leaves are used in medicine as a corrector of sena, and in powder to promote sneezing. 3. *Scorodonia*, or balm-leaved figwort. The stem is erect, square, about two feet high. The leaves are opposite, doubly serrated. The flowers are dusky purple, in composite bunches. It grows on the banks of rivulets, &c. in Cornwall. 4. *Vernalis*, or yellow figwort. The stalks are square, hairy, brown, about two feet high. The leaves are heart-shaped, roundish, hairy, indented, opposite. The flowers are yellow, on single forked footstalks from the axæ of the leaves. It grows in hedges in Surry.

SCROTUM. See ANATOMY, n<sup>o</sup> 107.

SCRUPI, in natural history, the name of a class of fossils, formed in detached masses, without any crusts; of no determinate figure or regular structure; and composed of a crystalline or sparry matter, debased by an admixture of earth in various proportions. Under this class are comprehended, 1. The *telaugia*. 2. The *petridia*. 3. The *lithozugia*. 4. The *jaspides* or jaspers.

SCRUPLE, SCRUPULUS, or *Scrupulum*, the least of the weights used by the ancients, which amongst the Romans was the 24th part of an ounce, or the 3d part of a dram. The scruple is still a weight among

Scrobiculus  
||  
Scruple.

**Scruple.** us, containing the 3d part of a dram, or 20 grains.  
**Scrutiny.** Among goldsmiths it is 24 grains.

**SCRUPLE**, in Chaldean chronology, is  $\frac{1}{60}$  part of an hour, called by the Hebrews *belakin*. These scruples are much used by the Jews, Arabs, and other eastern people, in computations of time.

**SCRUPLES of half Duration**, an arch of the moon's orbit, which the moon's centre describes from the beginning of an eclipse to its middle.

**SCRUPLES of Immersion or Incid-nee**, an arch of the moon's orbit, which her centre describes from the beginning of the eclipse to the time when its centre falls into the shadow.

**SCRUPLES of Emerfion**, an arch of the moon's orbit, which her centre describes in the time from the first emerfion of the moon's limb to the end of the eclipse.

**SCRUTINY**, (*Scrutinium*), in the primitive church, an examination or probation practised in the last week of Lent, on the catechumens, who were to receive baptism on the Easter-day. The scrutiny was performed with a great many ceremonies. Exorcisms and prayers were made over the heads of the catechumens; and on Palm Sunday, the Lord's Prayer and Creed were given them, which they were afterwards made to rehearse. This custom was more in use in the church of Rome than anywhere else; though it appears, by some missals, to have been likewise used, though much later, in the Gallican church. It is supposed to have ceased about the year 860. Some traces of this practice still remain at Vienne, in Dauphiné, and at Liege.

**SCRUTINY** is also used, in the canon law, for a ticket or little paper billet, wherein at elections the electors write their votes privately, so as it may not be known for whom they vote. Among us the term *scrutiny* is chiefly used for a strict perusal and examination of the several votes hastily taken at an election; in order to find out any irregularities committed therein, by unqualified voters, &c.

**SCRUTORE**, or **SCRUTOIR** (from the French *escrutoire*), a kind of cabinet, with a door or lid opening downwards, for conveniency of writing on, &c.

**SCRY**, in falconry, denotes a large flock of fowl.

**SCUDDING**, the movement by which a ship is carried precipitately before a tempest. As a ship flies with amazing rapidity through the water whenever this expedient is put in practice, it is never attempted in a contrary wind, unless when her condition renders her incapable of sustaining the mutual effort of the wind and waves any longer on her side, without being exposed to the most imminent danger of being overfet.

A ship either scuds with a sail extended on her fore-mast, or, if the storm is excessive, without any sail; which, in the sea-phrafe, is called *scudding under bare poles*. In sloops and schooners, and other small vessels, the sail employed for this purpose is called the *square-sail*. In large ships, it is either the fore-sail at large, reefed, or with its goose-wings extended, according to the degree of the tempest; or it is the fore-top sail, close reefed, and lowered on the cap; which last is particularly used when the sea runs so high as to becalm the fore-sail occasionally, a circumstance which exposes the ship to the danger of broaching-to. The principal hazards incident to scudding are generally, a pooping sea; the difficulty of steering, which exposes the vessel perpetually to the risk of broaching-to; and the want of sufficient sea-room. A sea striking the ship violently on the stern may dash it inwards, by which she must inevitably founder. In broaching-to (that is, inclining suddenly to windward), she is threatened with being immediately overturned; and, for want of sea-room, she is endangered by shipwreck on a lee-shore, a circumstance too dreadful to require explanation.

**SCULPONEÆ**, among the Romans, a kind of shoes worn by slaves of both sexes. These shoes were only blocks of wood made hollow, like the French *sa-bots*.

## S C U L P T U R E.

**I**S the art of carving wood or hewing stone into images. It is an art of the most remote antiquity, being practised, as there is reason to believe, before the general deluge. We are induced to assign to it this early origin, by considering the expedients by which, in the first stages of society, men have everywhere supplied the place of alphabetic characters. These, it is universally known, have been picture-writing, such as that of the Mexicans, which, in the progress of refinement and knowledge, was gradually improved into the hieroglyphics of the Egyptians and other ancient nations. See **HIEROGLYPHICS**.

That mankind should have lived near 1700 years, from the creation of the world to the flood of Noah, without falling upon any method to make their conceptions permanent, or to communicate them to a distance, is extremely improbable; especially when we call to mind that such methods of writing have been found, in modern times, among people much less enlightened than those must have been who were capable of building

such a vessel as the ark. But if the antediluvians were acquainted with any kind of writing, there can be little doubt of its being hieroglyphical writing. Mr Bryant has proved that the Chaldeans were possessed of that art before the Egyptians; and Berosus\* informs us, that \* *Apud Syncellum*, a delineation of all the monstrous forms which inhabited the chaos, when this earth was in that state, was to be seen in the temple of Belus in Babylon. This delineation, as he describes it, must have been a history in hieroglyphical characters; for it consisted of human figures with wings, with two heads, and some with the horns and legs of goats. This is exactly similar to the hieroglyphical writing of the Egyptians; and it was preserved, our author says, both in drawings and *engravings* in the temple of the god of Babylon. As Chal-dee was the first peopled region of the earth after the flood, and as it appears from Pliny†, as well as from Berosus, that the art of engraving upon bricks baked in the sun was there carried to a considerable degree of perfection at a very early period, the probability cer-  
 tainly

tainly is, that the Chaldeans derived the art of hieroglyphical writing, and consequently the rudiments of the art of sculpture, from their antediluvian ancestors.

2  
Not solely  
from ido-  
latory.

It is generally thought that sculpture had its origin from idolatry, as it was found necessary to place before the people the images of their gods to enliven the fervour of their devotion: but this is probably a mistake. The worship of the heavenly bodies, as the only gods of the heathen nations, prevailed so long before the deification of dead men was thought of (see POLYTHEISM), that we cannot suppose mankind to have been, during all that time, ignorant of the art of hieroglyphical writing. But the deification of departed heroes undoubtedly gave rise to the almost universal practice of representing the gods by images of a human form; and therefore we must conclude, that the elements of sculpture were known before that art was employed to enliven the devotion of idolatrous worshippers. The pyramids and obelisks of Egypt, which were probably temples, or rather altars, dedicated to the sun (see PYRAMID), were covered from top to bottom with hieroglyphical emblems of men, beasts, birds, fishes, and reptiles, at a period prior to that in which there is any unexceptionable evidence that mere statue-worship prevailed even in that nursery of idolatry.

3  
Though it  
probably  
contribu-  
ted to car-  
ry the art  
to perfec-  
tion.

But though it appears thus evident that picture-writing was the first employment of the sculptor, we are far from imagining that idolatrous worship did not contribute to carry his art to that perfection which it attained in some of the nations of antiquity. Even in the dark ages of Europe, when the other fine arts were almost extinguished, the mummery of the church of Rome, and the veneration which she taught for her saints and martyrs, preserved among the Italians some vestiges of the sister-arts of sculpture and painting; and therefore, as human nature is everywhere the same, it is reasonable to believe that a similar veneration for heroes and demigods would, among the ancient nations, have a similar effect. But if this be so, the presumption is, that the Chaldeans were the first who invented the art of hewing blocks of wood and stone into the figures of men and other animals; for the Chaldeans were unquestionably the first idolaters, and their early progress in sculpture is confirmed by the united testimonies of Berofus, Alexander Polyhistor, Apollodorus, and Pliny; not to mention the eastern tradition, that the father of Abraham was a statuary.

Mr Brom-  
ley's theo-  
ry, that  
sculpture  
was invent-  
ed by the  
Scythians.

Against this conclusion Mr Bromley, in his late History of the Fine Arts, has urged some plausible arguments. In stating these he professes not to be original, or to derive his information from the fountain-head of antiquity. He adopts, as he tells us, the theory of a French writer, who maintains, that in the year of the world 1949, about 300 years after the deluge, the Scythians under Brouma, a descendant of Magog the son of Japhet, extended their conquests over the greater part of Asia. According to this system, Brouma was not only the civilizer of India, and the author of the bramical doctrines, but also diffused the principles of the Scythian mythology over Egypt, Phœnicia, Greece, and the continent of Asia.

Of these principles Mr Bromley has given us no distinct enumeration: the account which he gives of them is not to be found in one place, but to be collected from a variety of distant passages. In attempting therefore

to present the substance of his scattered hints in one view, we will not be confident that we have omitted none of them. The ox, says he, was the Scythian emblem of the generator of animal life, and hence it became the principal divinity of the Arabians. The serpent was the symbol of the source of intelligent nature. These were the common points of union in all the first religions of the earth. From Egypt the Israelites carried with them a religious veneration for the ox and the serpent. Their veneration for the ox appeared soon after they marched into the wilderness, when in the absence of Moses they called upon Aaron to make them gods which should go before them. The idea of having an idol to go before them, says our author, was completely Scythian; for so the Scythians acted in all their progress through Asia, with this difference, that their idol was a living animal. The Israelites having gained their favourite god, which was an ox (not a calf as it is rendered in the book of Exodus), next proceeded to hold a festival, which was to be accompanied with dancing; a species of gaiety common in the festivals which were held in adoration of the emblematic *Urotal* or ox in that very part of Arabia near Mount Sinai where this event took place. It is mentioned too as a curious and important fact, that the ox which was revered in Arabia was called *Adonai*. Accordingly Aaron announcing the feast to the ox or golden calf, speaks thus, *to-morrow is a feast to Adonai*, which is in our translation rendered *to the Lord*. In the time of Jeroboam we read of the golden calves set up as objects of worship at Bethel and Dan. Nor was the reverence paid to the ox confined to Scythia, to Egypt, and to Asia; it extended much farther. The ancient Cimbri, as the Scythians did, carried an ox of bronze before them on all their expeditions. Mr Bromley also informs us, that as great respect was paid to the living ox among the Greeks as was offered to its symbol among other nations.

The emblem of the serpent, continues Mr Bromley, was marked yet more decidedly by the express direction of the Almighty. That animal had ever been considered as emblematic of the supreme generating power of intelligent life; and was that idea, says he, discouraged, so far as it went to be a sign or symbol of life, when God said to Moses, "Make thee a brazen serpent, and set it upon a pole, and it shall come to pass that every one who is bitten, when he looketh upon it, shall live." In Egypt the serpent surrounded their Isis and Osiris, the diadems of their princes, and the bonnets of their priests. The serpent made a distinguished figure in Grecian sculpture. The fable of Echidne, the mother of the Scythians, gave her figure terminating as a serpent to all the founders of states in Greece; from which their earliest sculptors represented in that form the Titan princes, Cecrops, Draco, and even Eriethonius. Besides the spear of the image of Minerva, which Phidias made for the citadel of Athens, he placed a serpent, which was supposed to guard that gods.

The serpent was combined with many other figures. It sometimes was coiled round an egg as an emblem of the creation; sometimes round a trident, to show its power over the sea; sometimes it encircled a flambeau, to represent life and death.

In Egypt, as well as in Scythia and India, the divinity



divinity was represented on the leaves of the tamara or lotus. Pan was worshipped as a god in that country, as well as over the east. Their sphinxes, and all their combined figures of animal creation, took their origin from the mother of the Scythians, who brought forth an offspring that was half a woman and half a serpent. Their pyramids and obelisks arose from the idea of flame; the first emblem of the supreme principle, introduced by the Scythians, and which even the influence of Zoroaster and the Magi could not remove.

We are told that the Bacchus of the Greeks is derived from the Brouma of the Indians; that both are represented as seated on a swan swimming over the waves, to indicate that each was the god of humid nature, not the god of wine, but the god of waters. The mitre of Bacchus was shaped like half an egg; an emblem taken from this circumstance, that at the creation the egg from which all things sprung was divided in the middle. Pan also was revered among the Scythians; and from that people were derived all the emblems by which the Greeks represented this divinity.

It would be tedious to follow our author through the whole of this subject; and were we to submit to the labour of collecting and arranging his scattered materials, we should still view his system with some degree of suspicion. It is drawn, as he informs us, from the work of M. D'Ancarville, intitled, *Recherches sur l'Origine, l'Esprit, et les Progres, des Arts de la Grece.*

To form conclusions concerning the origin of nations, the rise and progress of the arts and sciences, without the aid of historical evidence, by analogies which are sometimes accidental, and often fanciful, is a mode of reasoning which cannot readily be admitted. There may indeed, we acknowledge, be resemblances in the religion, language, manners, and customs, of different nations, so striking and so numerous, that to doubt of their being descended from the same stock would favour of scepticism. But historical theories must not be adopted rashly. We must be certain that the evidence is credible and satisfactory before we proceed to deduce any conclusions. We must first know whether the Scythian history itself be authentic, before we make any comparison with the history of other nations. But what is called the Scythian history, every man of learning knows to be a collection of fables. Herodotus and Justin are the two ancient writers from whom we have the fullest account of that warlike nation; but these two historians contradict each other, and both write what cannot be believed of the same people at the same period of their progress. Justin tells us, that there was a long and violent contest between the Scythians and Egyptians about the antiquity of their respective nations; and after stating the arguments on each side of the question, which, as he gives them\*, are nothing to the purpose, he decides in favour of the claim of the Scythians. Herodotus was too partial to the Egyptians, not to give them the palm of antiquity: and he was probably in the right; for Justin describes his most ancient of nations, even in the time of Darius Hystaspes, as ignorant of all the arts of civil life. "They occupied their land in common (says he), and cultivated none of it. They had no houses nor settled habitations, but wandered with their cattle from desert to desert. In these rambles they carried their wives and children in tumbrils covered with the skins of beasts,

which served as houses to protect them from the storms of winter. They were without laws, governed by the dictates of natural equity. They coveted not gold or silver like the rest of mankind, and lived upon milk and honey. Though they were exposed to extreme cold, and had abundance of flocks, they knew not how to make garments of wool, but clothed themselves in the skins of wild beasts †." This is the most favourable account which any ancient writer gives of the Scythians. By Strabo ‡ and Herodotus § they are represented as the most savage of mortals, delighting in war and bloodshed, cutting the throats of all strangers who came among them, eating their flesh, and making cups and pots of their skulls. Is it conceivable that such savages could be sculptors; or that, even supposing their manners to have been such as Justin represents them, a people so simple and ignorant could have imposed their mythology upon the Chaldeans, Phenicians, and Egyptians, whom we know by the most incontrovertible evidence to have been great and polished nations so early as in the days of Abraham? No! We could as soon admit other novelties of more importance, with which the French of the present age pretend to enlighten the world, as this origin assigned by Mr Bromley to the art of sculpture, unless supported by better authority than that of D'Ancarville.

The inference of our author from the name of the sacred ox in Arabia, and from the dancing and gaiety which were common in the religious festivals of the Arabians, appears to us to be very hastily drawn. At the early period of the departure of the Israelites from Egypt, the language of the Hebrews, Egyptians, and Arabians, differed not more from each other than do the different dialects of the Greek tongue which are found in the poems of Homer (see PHILOLOGY, Sect. III.); and it is certain, that for many years after the formation of the golden-calf, the Hebrews were strangers to every species of idolatry but that which they had brought with them from their house of bondage. See REMPHAN.

Taking for granted therefore that the Scythians did not impose their mythology upon the eastern nations, and that the art of sculpture, as well as hieroglyphic writing and idolatrous worship, prevailed first among the Chaldeans, we shall endeavour to trace the progress of this art through some other nations of antiquity, till we bring it to Greece, where it was carried to the highest perfection to which it has yet attained.

The first intimation that we have of the art of sculpture is in the book of Genesis, where we are informed, that when Jacob, by the divine command, was returning to Canaan, his wife Rachel carried along with her the teraphim or idols of her father. These we are assured were small, since Rachel found it so easy to conceal them from her father, notwithstanding his anxious search. We are ignorant, however, how these images were made, or of what materials they were composed. The first person mentioned as an artist of eminence is Bezaleel, who formed the cherubims which covered the mercy-seat.

The Egyptians also cultivated the art of sculpture; but there were two circumstances that obstructed its progress, 1. The persons of the Egyptians were not possessed of the graces of form, of elegance, or of symmetry; and of consequence they had no perfect standard

† Lib. 2.  
cap. 2.

‡ Lib. 7.  
§ Lib. 4.  
cap. 6.

5  
Ill founded.

• Lib. 2.  
cap. 1.

6  
Egyptian  
sculpture.

to model their taste. They resembled the Chinese in the cast of their face, in their great bellies, and in the clumsy rounding of their contours. 2. They were restrained by their laws to the principles and practices of their ancestors, and were not permitted to introduce any innovations. Their statues were always formed in the same stiff attitude, with the arms hanging perpendicularly down the sides. What perfection were they capable of who knew no other attitude than that of chairmen? So far were they from attempting any improvements, that in the time of Adrian the art continued in the same rude state as at first; and when their slavish adulation for that emperor induced them to place the statue of his favourite Antinous among the objects of their worship, the same inanimate stiffness in the attitude of the body and position of the arms was observed. We believe it will scarcely be necessary to inform our readers that the Egyptian statue just now mentioned is very different from the celebrated statue of Antinous, of which so many moulds have been taken that imitations of it are now to be met with almost in every cabinet in Europe.

Notwithstanding the attachment of the Egyptians to ancient usages, Winkelman thinks he has discovered two different styles of sculpture which prevailed at different periods. The first of these ends with the conquest of Egypt by Cambyfes. The second begins at that time, and extends beyond the reign of Alexander the Great.

7  
First style. In the first style, the lines which form the contour are straight and projecting a little; the position is stiff and unnatural: In sitting figures the legs are parallel, the feet squeezed together, and the arms fixed to the sides; but in the figures of women the left arm is folded across the breast; the bones and muscles are faintly discernible; the eyes are flat and looking obliquely, and the eyebrows sunk; features which destroy entirely the beauty of the head; the cheek-bones are high, the chin small and piked; the ears are generally placed higher than in nature, and the feet are too large and flat. In short, if we are to look for any model in the statues of Egypt, it is not for the model of beauty but of deformity. The statues of men are naked, only they have a short apron, and a few folds of drapery surrounding their waist: The vestments of women are only distinguishable by the border, which rises a little above the surface of the statue. In this age it is evident the Egyptians knew little of drapery.

8  
Second style. Of the second style of sculpture practised among the Egyptians, Winkelman thinks he has found specimens in the two figures of basaltes in the Capitol, and in another figure at Villa Albani, the head of which has been renewed. The two first of these, he remarks, bear visible traces of the former style, which appear especially in the form of the mouth and shortness of the chin. The hands possess more elegance; and the feet are placed at a greater distance from one another, than was customary in more ancient times. In the first and third figures the arms hang down close to the sides. In the second they hang more freely. Winkelman suspects that these three statues have been made after the conquest of Egypt by the Greeks. They are clothed with a tunic, a robe, and a mantle. The tunic, which is puckered into many folds, descends from the neck to the ground. The robe in the first and third statues seems close to the body, and is only perceptible by

some little folds. It is tied under the breast, and covered by the mantle, the two buttons of which are placed under the epaulet.

The Antinous of the Capitol is composed of two pieces, which are joined under the haunches. But as all the Egyptian statues which now remain have been hewn out of one block, we must believe that Diodorus, in saying the stone was divided, and each half finished by a separate artizan, spoke only of a colossus. The same author informs us, that the Egyptians divided the human body into  $24\frac{1}{2}$  parts; but it is to be regretted that he has not given a more minute detail of that division.

The Egyptian statues were not only formed by the chisel, they were also polished with great care. Even those on the summit of an obelisk, which could only be viewed at a distance, were finished with as much labour and care as if they had admitted a close inspection. As they are generally executed in granite or basaltes, stones of a very hard texture, it is impossible not to admire the indefatigable patience of the artills.

The eye was often of different materials from the rest of the statue; sometimes it was composed of a precious stone or metal. We are assured that the valuable diamond of the empress of Russia, the largest and most beautiful hitherto known, formed one of the eyes of the famous statue of Scheringham in the temple of Brama.

Those Egyptian statues which still remain are composed of wood or baked earth: and the statues of earth are covered with green enamel.

9  
The Phenicians possessed both a character and situation highly favourable to the cultivation of statuary. Phenician sculpture. They had beautiful models in their own persons, and their industrious character qualified them to attain perfection in every art for which they had a taste. Their situation raised a spirit of commerce, and commerce induced them to cultivate the arts. Their temples shone with statues and columns of gold, and a profusion of emeralds was everywhere scattered. All the great works of the Phenicians have been unfortunately destroyed; but many of the Carthaginian medals are still preserved, ten of which are deposited in the cabinet of the grand duke of Florence. But though the Carthaginians were a colony of Phenicians, we cannot from their works judge of the merit of their ancestors.

10  
The Persians made no distinguished figure in the arts of design. They were indeed sensible to the charms of beauty, but they did not study to imitate them. Their dress, which consisted of long flowing robes concealing the whole person, prevented them from attending to the beauties of form. Their religion, too, which taught them to worship the divinity in the emblem of fire, and that it was impious to represent him under a human form, seemed almost to prohibit the exercise of this art, by taking away those motives which alone could give it dignity and value; and as it was not customary among them to raise statues to great men, it was impossible that statuary could flourish in Persia. This art not cultivated among the Persians.

11  
The Etrurians or ancient Tuscans, in the opinion of Etrurian sculpture. Winkelman, carried this art to some degree of perfection at an earlier period than the Greeks. It is said to have been introduced before the siege of Troy by Dedalus, who, in order to escape the resentment of Minos, king of Crete, took refuge in Sicily, from whence he passed.

passed into Italy, where he left many monuments of his art. Pausanias and Diodorus Siculus inform us, that some works ascribed to him were to be seen when they wrote, and that these possessed that character of majesty which afterwards distinguished the labours of Etruria.

A character strongly marked forms the chief distinction in those productions of Etruria which have descended to us. Their style was indeed harsh and overcharged; a fault also committed by Michael Angelo the celebrated painter of modern Etruria; for it is not to be supposed that a people of such rude manners as the Etrurians could communicate to their works that vividness and beauty which the elegance of Grecian manners inspired. On the other hand, there are many of the Tuscan statues which bear so close a resemblance to those of Greece, that antiquarians have thought it probable that they were conveyed from that country or Magna Græcia into Etruria about the time of the Roman conquest, when Italy was adorned with the spoils of Greece.

<sup>12</sup> First style. Among the monuments of Etrurian art two different styles have been observed. In the first the lines are straight, the attitude stiff, and no idea of beauty appears in the formation of the head. The contour is not well rounded, and the figure is too slender. The head is oval, the chin piked, the eyes flat, and looking askant.

These are the defects of an art in a state of infancy, which an accomplished master could never fall into, and are equally conspicuous in Gothic statues as in the productions of the ancient natives of Florence. They resemble the style of the Egyptians so much, that one is almost induced to suppose that there had once been a communication between these two nations; but others think that this style was introduced by Dedalus.

<sup>13</sup> Second style. Winkelman supposes that the second epoch of this art commenced in Etruria, about the time at which it had reached its greatest perfection in Greece, in the age of Phidias; but this conjecture is not supported by any proofs. To describe the second style of sculpture among the Etrurians, is almost the same as to describe the style of Michael Angelo and his numerous imitators. The joints are strongly marked, the muscles raised, the bones distinguishable; but the whole mien harsh. In designing the bone of the leg, and the separation of the muscles of the calf, there is an elevation and strength above life. The statues of the gods are designed with more delicacy. In forming them, the artists were anxious to show that they could exercise their power without that violent distension of the muscles which is necessary in the exertions of beings merely human; but in general their attitudes are unnatural, and the actions strained. If a statue, for instance, hold any thing with its fore-fingers, the rest are stretched out in a stiff position.

According to ancient history, the Greeks did not emerge from the savage state till a long time after the Egyptians, Chaldeans, and Indians, had arrived at a considerable degree of civilization. The original rude inhabitants of Greece were civilized by colonies which arrived among them, at different times, from Egypt and Phenicia. These brought along with them the religion, the letters, and the arts of their parent coun-

tries: and if sculpture had its origin from the worship of idols, there is reason to believe that it was one of the arts which were thus imported; for that the gods of Greece were of Egyptian and Phenician extraction is a fact incontrovertible; (see MYSTERIES, MYTHOLOGY, PHILOLOGY, sect. 7. PHILOSOPHY, n<sup>o</sup> 19, and TITAN.) The original statues of the gods, however, were very rude. The earliest objects of idolatrous worship have everywhere been the heavenly bodies; and the symbols consecrated to them were generally pillars of a conical or pyramidal figure. It was not till hero-worship was engrafted on the planetary, that the sculptor thought of giving to the sacred statue any part of the human form (see POLYTHEISM, n<sup>o</sup> 19, 23); and it appears to have been about the era of their revolution in idolatry that the art of sculpture was introduced among the Greeks. The first representations of their gods were round stones placed upon cubes or pillars; and these stones they afterwards formed roughly, so as to give them something of the appearance of a head. Agreeable to this description was a Jupiter, which Pausanias saw in Tegeum, in Arcadia. These representations were called *Hermes*; not that they represented Mercury, but from the word *herma*, which signified a rough stone. It is the name which Homer gives to the stones which were used to fix vessels to the shore. Pausanias saw at Pheres 30 deities made of unformed blocks or cubical stones. The Lacedæmonians represented Castor and Pollux by two parallel posts; and a transverse beam was added, to express their mutual affection.

If the Greeks derived from foreign nations the rudiments of the arts, it must redound much to their honour, that in a few centuries they carried them to such wonderful perfection as entirely to eclipse the fame of their masters. It is by tracing the progress of sculpture among them that we are to study the history of this art; and we shall see its origin and successive improvements correspond with nature, which always operates slowly and gradually.

#### VIEW OF GRECIAN SCULPTURE.

THE great superiority of the Greeks in the art of sculpture may be ascribed to a variety of causes. <sup>14</sup> Causes which promoted the art of sculpture in Greece. The influence of climate over the human body is so striking, that it must have fixed the attention of every thinking man who has reflected on the subject. The violent heats of the torrid zone, and the excessive cold of the polar regions, are unfavourable to beauty. It is only in the mild climates of the temperate regions that it appears in its most attractive charms. Perhaps no country in the world enjoys a more serene air, less tainted with mists and vapours, or possesses in a higher degree that mild and genial warmth which can unfold and expand the human body into all the symmetry of muscular strength, and all the delicacies of female beauty in greater perfection, than the happy climate of Greece; and never was there any people that had a greater taste for beauty, or were more anxious to improve it. Of the four wishes of Simonides, the second was to have a handsome figure. The love of beauty was so great among the Lacedæmonian women, that they kept in their chambers the statues of Nereus, of Narcissus, of

Hyacinthus, and of Castor and Pollux; hoping that by often contemplating them they might have beautiful children.

There was a variety of circumstances in the noble and virtuous freedom of the Grecian manners that rendered these models of beauty peculiarly subservient to the cultivation of the fine arts. There were no tyrannical laws, as among the Egyptians, to check their progress. They had the best opportunities to study them in the public places, where the youth, who needed no other veil than chastity and purity of manners, performed their various exercises quite naked. They had the strongest motives to cultivate sculpture, for a statue was the highest honour which public merit could attain. It was an honour ambitiously sought, and granted only to those who had distinguished themselves in the eyes of their fellow citizens. As the Greeks preferred natural qualities to acquired accomplishments, they decreed the first rewards to those who excelled in agility and strength of body. Statues were often raised to wrestlers. Even the most eminent men of Greece, in their youth, sought renown in gymnastic exercises. Chrysis and Cleantes distinguished themselves in the public games before they were known as philosophers. Plato appeared as a wrestler both at the Isthmian and Pythian games; and Pythagoras carried off the prize at Elis, (see PYTHAGORAS.) The passion by which they were inspired was the ambition of having their statues erected in the most sacred place of Greece, to be seen and admired by the whole people. The number of statues erected on different occasions was immense; of course the number of artists must have been great, their emulation ardent, and their progress rapid.

As most of their statues were decreed for those who vanquished in the public games, the artists had the opportunity of seeing excellent models; for those who surpassed in running, boxing, and wrestling, must in general have been well formed, yet would exhibit different kinds of beauty.

The high estimation in which sculptors were held was very favourable to their art. Socrates declared the artists the only wise men. An artist could be a legislator, a commander of armies, and might hope to have his statue placed beside those of Miltiades and Themistocles, or those of the gods themselves. Besides, the honour and success of an artist did not depend on the caprice of pride or of ignorance. The productions of art were estimated and rewarded by the greatest sages in the general assembly of Greece, and the sculptor who had executed his work with ability and taste was confident of obtaining immortality.

It was the opinion of Winkelman, that liberty was highly favourable to this art; but, though liberty is absolutely necessary to the advancement of science, it may be doubted whether the fine arts owe their improvement to it. Sculpture flourished most in Greece, when Pericles exercised the power of a king; and in the reign of Alexander, when Greece was conquered. It attained no perfection in Rome till Augustus had enslaved the Romans. It revived in Italy under the patronage of the family of Medici, and in France under the despotic rule of Louis XIV. It is the love of beauty, luxury, wealth, or the patronage of a powerful individual, that promotes the progress of this art.

It will now be proper to give a particular account of

the ideas which the Greeks entertained concerning the standard of beauty in the different parts of the human body. And with respect to the head, the profile which they chiefly admired is peculiar to dignified beauty. It consists in a line almost straight, or marked by such slight and gentle inflections as are scarcely distinguishable from a straight line. In the figures of women and young persons, the forehead and nose form a line approaching to a perpendicular.

Ancient writers, as well as artists, assure us that the Greeks reckoned a small forehead a mark of beauty, and a high forehead a deformity. From the same idea, the Circassians wore their hair hanging down over their foreheads almost to their eyebrows. To give an oval form to the countenance, it is necessary that the hair should cover the forehead, and thus make a curve about the temples; otherwise the face, which terminates in an oval form in the inferior part, will be angular in the higher part, and the proportion will be destroyed. This rounding of the forehead may be seen in all handsome persons, in all the heads of ideal beauty in ancient statues, and especially in those of youth. It has been overlooked, however, by modern statuary. Bernini, who modelled a statue of Louis XIV. in his youth, turned back the hair from the forehead.

It is generally agreed that large eyes are beautiful; but their size is of less importance in sculpture than their form, and the manner in which they are enshaded. In ideal beauty, the eyes are always sunk deeper than they are in nature, and consequently the eyebrows have a greater projection. But in large statues, placed at a certain distance, the eyes, which are of the same colour with the rest of the head, would have little effect if they were not sunk. By deepening the cavity of the eye, the statuary increases the light and shade, and thus gives the head more life and expression. The same practice is used in small statues. The eye is a characteristic feature in the heads of the different deities. In the statues of Apollo, Jupiter, and Juno, the eye is large and round. In those of Pallas they are also large; but by lowering the eyelids, the virgin air and expression of modesty are delicately marked. Venus has small eyes, and the lower eyelid being raised a little, gives them a languishing look and an enchanting sweetness. It is only necessary to see the Venus de Medicis to be convinced that large eyes are not essential to beauty, especially if we compare her small eyes with those which resemble them in nature. The beauty of the eyebrows consists in the fineness of the hair, and in the sharpness of the bone which covers them; and masters of the art considered the joining of the eyebrows as a deformity, though it is sometimes to be met with in ancient statues.

The beauty of the mouth is peculiarly necessary to constitute a fine face. The lower lip must be fuller than the upper, in order to give an elegant rounding to the chin. The teeth seldom appear, except in laughing satyrs. In human figures the lips are generally close, and a little opened in the figures of the gods. The lips of Venus are half open.

In figures of ideal beauty, the Grecian artists never interrupted the rounding of the chin by introducing a dimple: for this they considered not as a mark of beauty, and only to be admitted to distinguish individuals. The dimple indeed appears in some ancient statues, but

15  
Grecian  
heads of  
beauty.  
16  
The profile.

17  
The face,  
head.

18  
The eyes.

19  
The mouth.

an

antiquaries suspect it to be the work of a modern hand. It is suspected also, that the dimple which is sometimes found on the cheeks of ancient statues is a modern innovation.

No part of the head was executed by the ancients with more care than the ears, though little attention has been given to them by modern artists. This character is so decisive, that if we observe in any statue that the ears are not highly finished, but only roughly marked, we may conclude with certainty that we are examining a modern production. The ancients were very attentive to copy the precise form of the ear in taking likenesses. Thus, where we meet with a head the ears of which have a very large interior opening, we know it to be the head of Marcus Aurelius.

The manner in which the ancient artists formed the hair also enables us to distinguish their works from those of the moderns. On hard and coarse stones the hair was short, and appeared as if it had been combed with a wide comb; for that kind of stone was difficult to work, and could not without immense labour be formed into curled and flowing hair. But the figures executed in marble in the most flourishing period of the art have the hair curled and flowing; at least where the head was not intended to be an exact resemblance, for then the artist conformed to his model. In the heads of women, the hair was thrown back, and tied behind in a waving manner, leaving considerable intervals; which gives the agreeable variety of light and shade, and produces the effects of the *claro-obscuro*. The hair of the Amazons is disposed in this manner. Apollo and Bacchus have their hair falling down their shoulders; and young persons, till they arrived at manhood, wore their hair long. The colour of the hair which was reckoned most beautiful, was fair; and this they gave without distinction to the most beautiful of their gods, Apollo and Bacchus, and likewise to their most illustrious heroes.

Although the ravages of time have preserved but few of the hands or feet of ancient statues, it is evident from what remains how anxious the Grecian artists were to give every perfection to these parts. The hands of young persons were moderately plump, with little cavities or dimples at the joints of the fingers. The fingers tapered very gently from the root to the point, like well proportioned columns, and the joints were scarcely perceptible. The terminating joint was not bent, as it commonly appears in modern statues.

In the figures of young men the joints of the knee are faintly marked. The knee unites the leg to the thigh without making any remarkable projections or cavities. The most beautiful legs and best-turned knees, according to Winkelman, are preserved in the Apollo Sauroctones, in the Villa Borghese; in the Apollo which has a swan at its feet; and in the Bacchus of Villa Medici. The same able connoisseur remarks, it is rare to meet with beautiful knees in young persons, or in the elegant representations of art. As the ancients did not cover the feet as we do, they gave to them the most beautiful turning, and studied the form of them with the most scrupulous attention.

The breasts of men were large and elevated. The breasts of women did not possess much amplitude. The figures of the deities have always the breasts of a virgin, the beauty of which the ancients made to consist in a gentle elevation. So anxious were the women to resemble this standard, that they used several arts to restrain the growth of their breasts. The breasts of the nymphs and goddesses were never represented swelling, because that is peculiar to those women who suckle. The paps of Venus contract and end in a point, this being considered as an essential characteristic of perfect beauty. Some of the moderns have transgressed these rules, and have fallen into great improprieties.

The lower part of the body in the statues of men was formed like that of the living body after a profound sleep and good digestion. The navel was considerably sunk, especially in female statues.

As beauty never appears in equal perfection in every part of the same individual, perfect or ideal beauty can only be produced by selecting the most beautiful parts from different models; but this must be done with such judgment and care, that these detached beauties when united may form the most exact symmetry. Yet the ancients sometimes confined themselves to one individual, even in the most flourishing age. Theodoros, whom Socrates and his disciples visited, served as a model to the artists of his time. Phryne also appears to have been a model to the painters and sculptors. But Socrates, in his conversation with Parrhasius, says, that when a perfect beauty was to be produced, the artists joined together the most striking beauties which could be collected from the finest figures. We know that Zeuxis, when he was going to paint Helen, united in one picture all the beauties of the most handsome women of Crotona.

The Grecian sculptors, who represented with such success the most perfect beauty of the human form, were not regardless of the drapery of their statues. They clothed their figures in the most proper stuff, which they wrought into that shape which was best calculated to give effect to their design.

The vestments of women in Greece generally consisted of linen cloth, or some other light stuff, and in latter times of silk and sometimes of woollen cloth. They had also garments embroidered with gold. In the works of sculpture, as well as in those of painting, one may distinguish the linen by its transparency and small united folds. The other light stuffs which were worn by the women (A) were generally of cotton produced in the isle of Cos; and these the art of statuary was able to distinguish from the linen vestments. The cotton cloth was sometimes striped, and sometimes embellished with a profusion of flowers. Silk was also employed; but whether it was known in Greece before the time of the Roman emperors cannot easily be determined. In paintings, it is distinguishable by changing its colour in different lights to red, violet, and sky-blue. There were two sorts of purple; that which the Greeks called the *colour of the sea*, and Tyrian purple, which resembled lac. Woollen garments are early known by the

(A) Men sometimes wore cotton, but all who did so were reckoned effeminate.

the amplitude of their folds. Besides these, cloth of gold sometimes composed their drapery: but it was not like the modern fabric, consisting of a thread of gold or of silver spun with a thread of silk; it was composed of gold or silver alone, without any mixture.

The vestments of the Greeks, which deserve particular attention, are the tunic, the robe, and the mantle.

<sup>27</sup>  
The tunic.

The tunic was that part of the dress which was next to the body. It may be seen in sleeping figures, or in those in dihabille; as in the Flora Farnese, and in the statues of the Amazons in the Capitol. The youngest of the daughters of Niobe, who throws herself at her mother's side, is clothed only with a tunic. It was of linen, or some other light stuff, without sleeves, fixed to the shoulders by a button, so as to cover the whole breast. None but the tunics of the goddesses Ceres and comedians have long straight sleeves.

<sup>28</sup>  
The robe.

The robes of women commonly consisted of two long pieces of woollen cloth, without any particular form, attached to the shoulders by a great many buttons, and sometimes by a clasp. They had straight sleeves which came down to the wrists. The young girls, as well as the women, fastened their robe to their side by a cincture, in the same way as the high-priest of the Jews fastened his, as it is still done in many parts of Greece. The cincture formed on the side a knot of ribbons sometimes resembling a rose in shape, which has been particularly remarked in the two beautiful daughters of Niobe. In the younger of these the cincture is seen passing over the shoulders and the back. Venus has two cinctures, the one passing over the shoulder, and the other surrounding the waist. The latter is called *ceflus* by the poets.

<sup>29</sup>  
The mantle.

The mantle was called *peplon* by the Greeks, which signifies properly the mantle of Pallas. The name was afterwards applied to the mantles of the other gods, as well as to those of men. This part of the dress was not square, as some have imagined, but of a roundish form. The ancients indeed speak in general of square mantles, but they received this shape from four tassels which were affixed to them; two of these were visible, and two were concealed under the mantle. The mantle was brought under the right arm, and over the left shoulder; sometimes it was attached to the shoulder by two buttons, as may be seen in the beautiful statue of Leucothea at Villa Albani.

<sup>30</sup>  
The colour of the vestments.

The colour of vestments peculiar to certain statues is too curious to be omitted. To begin with the figures of the gods.—The drapery of Jupiter was red, that of Neptune is supposed by Winkelman to have been sea-green. The same colour also belonged to the Nereids and Nymphs. The mantle of Apollo was blue or violet. Bacchus was dressed in white. Martianus Capella assigns green to Cybele. Juno's vestments were sky-blue, but she sometimes had a white veil. Pallas was robed in a flame-coloured mantle. In a painting of Herculaneum, Venus is in flowing drapery of a golden yellow. Kings were arrayed in purple; priests in white; and conquerors sometimes in sea-green.

With respect to the head, women generally wore no covering but their hair; when they wished to cover their head, they used the corner of their mantle.— Sometimes we meet with veils of a fine transparent texture. Old women wore a kind of bonnet upon their head, an example of which may be seen in a statue in the Capitol, called the *Proserpina*, but Winkelman thinks it is a statue of Hecuba.

The covering of the feet consisted of shoes or sandals. The sandals were generally an inch thick, and composed of more than one sole of cork. Those of Pallas in Villa Albani has two soles, and other statues had no less than five.

WINKELMAN has assigned four different styles to this art. <sup>31</sup> The *ancient* style, which continued until the time of Phidias; the *grand* style, formed by that celebrated <sup>Four styles of this art among the</sup> statuary; the *beautiful*, introduced by Praxiteles, A. Pelles, and Lyfippus; and the *imitative* style, practised by those artists who copied the works of the ancient masters.

The most authentic monuments of the ancient style <sup>The an-</sup> are medals, containing an inscription, which leads us <sup>cient style.</sup> back to very distant times. The writing is from right to left in the Hebrew manner; a usage which was abandoned before the time of Herodotus. The statue of Agamemnon at Elis, which was made by Ornatas, has an inscription from right to left. This artisan flourished 50 years before Phidias; it is in the intervening period therefore between these two artists, that we are to look for the cessation of this practice. The statues formed in the ancient style were neither distinguished by beauty of shape nor by proportion, but bore a close resemblance to those of the Egyptians and Etrurians (B); the eyes were long and flat; the section of the mouth not horizontal; the chin was pointed; the curls of the hair were ranged in little rings, and resembled grains inclosed in a heap of raisins. What was still worse, it was impossible by inspecting the head to distinguish the sex.

The characters of this ancient style were these: The designing was energetic, but harsh; it was animated, but without gracefulness; and the violence of the expression deprived the whole figure of beauty.

The grand style was brought to perfection by Phi- <sup>33</sup> The grand style, illustrious artists. It is probable, from some passages of ancient writers, that in this style were preserved some characters of the ancient manner, such as the straight lines, the squares and angles. The ancient masters, such as Polyclethus, being the legislators of proportions, says Winkelman, and of consequence thinking they had a right to distribute the measures and dimensions of the parts of the human body, have undoubtedly sacrificed some degree of the form of beauty to a grandeur which is harsh, in comparison of the flowing contours and graceful forms of their successors.— The most considerable monuments of the grand style are the statues of Niobe and her daughters, and a figure

(B) This is a proof additional to those that will be found in the articles to which we have referred, that the Greeks received the rudiments of the art of sculpture from the nations to which they were confessedly indebted for the elements of science.

gure of Pallas, to be seen in Villa Albani; which, however, must not be confounded with the statue which is modelled according to the first style, and is also found in the same place. The head possesses all the characters of dignified beauty, at the same time exhibiting the rigidness of the ancient style. The face is defective in gracefulness; yet it is evident how easy it would have been to give the features more roundness and grace. The figures of Niobe and her daughters have not, in the opinion of Winkelman, that austerity of appearance which marks the age of the statue of Pallas. They are characterized by grandeur and simplicity: so simple are the forms, that they do not appear to be the tedious productions of art, but to have been created by an instantaneous effort of nature.

The third style was the graceful or beautiful. Lysippus was perhaps the artist who introduced this style. Being more conversant than his predecessors with the sweet, the pure, the flowing, and the beautiful lines of nature, he avoided the square forms which the masters of the second style had too much employed. He was of opinion that the use of the art was rather to please than to astonish, and that the aim of the artist should be to raise admiration by giving delight. The artists who cultivated this style did not, however, neglect to study the sublime works of their predecessors. They knew that grace is consistent with the most dignified beauty, and that it possesses charms which must ever please: they knew also that these charms are enhanced by dignity. Grace is infused into all the movements and attitudes of their statues, and it appears in the delicate turns of the hair, and even in the adjusting of the drapery. Every sort of grace was well known to the ancients; and great as the ravages of time have been amongst the works of art, specimens are still preserved, in which can be distinguished *dignified beauty, attractive beauty, and a beauty peculiar to infants.* A specimen of dignified beauty may be seen in the statue of one of the muses in the palace of Barberini at Rome; and in the garden of the pope, on the Quirinal is a statue of another muse, which affords a fine instance of attractive beauty. Winkelman says that the most excellent model of infant beauty which antiquity has transmitted to us is a satyr of a year old, which is preserved, though a little mutilated, in Villa Albani.

The great reputation of Praxiteles and Apelles raised an ardent emulation in their successors, who despairing to surpass such illustrious masters, were satisfied with imitating their works. But it is well known that a mere imitator is always inferior to the master whom he attempts to copy. When no original genius appears, the art must therefore decline.

CLAY was the first material which was employed in statuary. An instance of this may be seen in a figure of Alcemenes in bas-relief in Villa Albani. The ancients used their fingers, and especially their nails, to render certain parts more delicate and lively: hence arose the phrase *ad unguem factus homo*, "an accomplished man." It was the opinion of count Caylus that the ancients did not use models in forming their statues. But to disprove this, it is only necessary to mention an engraving on a stone in the cabinet of Stofch, which represents Prometheus engraving the figure of a man, with a plummet in his hand to measure the proportions of his

model. The ancients as well as the moderns made works in plaster; but no specimens remain except some figures in bas-relief, of which the most beautiful were found at Baia.

The works made of ivory and silver were generally of a small size. Sometimes, however, statues of a prodigious size were formed of gold and ivory. The colossal Minerva of Phidias, which was composed of these materials, was 26 cubits high. It is indeed scarcely possible to believe that statues of such a size could entirely consist of gold and ivory. The quantity of ivory necessary to a colossal statue is beyond conception. M. de Pauw calculates that the statue of Jupiter Olympus, which was 54 feet high, would consume the teeth of 300 elephants.

The Greeks generally hewed their marble statues out of one block, though they after worked the heads separately, and sometimes the arms. The heads of the famous group of Niobe and her daughters have been adapted to their bodies after being separately finished. It is proved by a large figure representing a river, which is preserved in Villa Albani, that the ancients first hewed their statues roughly before they attempted to finish any part. When the statue had received its perfect figure, they next proceeded to polish it with pumice-stone, and again carefully retouched every part with the chisel.

The ancients, when they employed porphyry, usually made the head and extremities of marble. It is true, that at Venice there are four figures entirely composed of porphyry; but these are the productions of the Greeks of the middle age. They also made statues of basalt and alabaster.

WITHOUT expression, gesture, and attitude, no figure can be beautiful, because in these the graces always reside. It was for this reason that the graces are always represented as the companions of Venus.

The expression of tranquillity was frequent in Grecian statues, because, according to Plato, that was considered as the middle state of the soul between pleasure and pain. Experience too shows that in general the most beautiful persons are endowed with the sweetest and most engaging manner. Without a sedate tranquillity dignified beauty could not exist. It is in this tranquillity, therefore, that we must look for the complete display of genius.

The most elevated species of tranquillity and repose was studied in the figures of the gods. The father of the gods, and even inferior divinities, are represented without emotion or resentment. It is thus that Homer paints Jupiter shaking Olympus by the motion of his hair and his eyebrows.

Shakes his ambrosial curls, and gives the nod,  
The stamp of fate and sanction of the god.

Jupiter is not always exhibited in this tranquil state. In a bas-relief belonging to the Marquis Rondini he appears seated on an arm-chair with a melancholy aspect. The Apollo of the Vatican represents the god in a fit of rage against the serpent Python, which he kills at a blow. The artist, adopting the opinion of the poets, has made the nose the seat of anger, and the lips the seat of disdain.

To express the action of a hero, the Grecian sculptors delineated

<sup>38</sup>  
Ivory, silver, and gold.

<sup>39</sup>  
Marble.

<sup>40</sup>  
Porphyry.

<sup>41</sup>  
Expression, and attitude.

<sup>42</sup>  
In the statues of the gods.

<sup>43</sup>  
In the statues of heroes.

delineated the countenance of a noble virtuous character repressing his groans, and allowing no expression of pain to appear. In describing the actions of a hero the poet has much more liberty than the artist. The poet can paint them such as they were before men were taught to subdue their passions by the restraints of law, or the refined customs of social life. But the artist, obliged to select the most beautiful forms, is reduced to the necessity of giving such an expression of the passions as may not shock our feelings and disgust us with his production. The truth of these remarks will be acknowledged by those who have seen two of the most beautiful monuments of antiquity; one of which represents the fear of death, the other the most violent pains and sufferings. The daughters of Niobe, against whom Diana has discharged her fatal arrows, are exhibited in that state of stupefaction which we imagine must take place when the certain prospect of death deprives the soul of all sensibility. The fable presents us an image of that stupor which Æschylus describes as seizing the Niobe when they were transformed into a rock. The other monument referred to is the image of Laocoon, which exhibits the most agonizing pain that can affect the muscles, the nerves, and the veins. The sufferings of the body and the elevation of the soul are expressed in every member with equal energy, and form the most sublime contrast imaginable. Laocoon appears to suffer with such fortitude, that, whilst his lamentable situation pierces the heart, the whole figure fills us with an ambitious desire of imitating his constancy and magnanimity in the pains and sufferings that may fall to our lot.

Philoctetes is introduced by the poets shedding tears, uttering complaints, and rending the air with his groans and cries; but the artist exhibits him silent and bearing his pains with dignity. The Ajax of the celebrated painter Timomachus is not drawn in the act of destroying the sheep which he took for the Grecian chiefs, but in the moments of reflection which succeeded that frenzy. So far did the Greeks carry their love of calmness and slow movements, that they thought a quick step always announced rusticity of manners. Demosthenes reproaches Nicobulus for this very thing; and from the words he makes use of, it appears, that to speak with insolence and to walk hastily were reckoned synonymous.

In the figures of women, the artists have conformed to the principle observed in all the ancient tragedies, and recommended by Aristotle, never to make women show too much intrepidity or excessive cruelty. Conformable to this maxim, Clytemnestra is represented at a little distance from the fatal spot, watching the murderer, but without taking any part with him. In a painting of Timomachus representing Medea and her children, when Medea lifts up the dagger they smile in her face, and her fury is immediately melted into compassion for the innocent victims. In another representation of the same subject, Medea appears hesitating and indecisive. Guided by the same maxims, the artists of most refined taste were careful to avoid all deformity, choosing rather to recede from truth than from their accustomed respect for beauty, as may be seen in several figures of Hecuba. Sometimes, however, she appears in the decrepitude of age, her face furrowed with wrinkles, and her breasts hanging down.

Illustrious men, and those invested with offices of dignity, are represented with a noble assurance and firm aspect. The statues of the Roman emperors resemble those of heroes, and are far removed from every species of flattery, in the gesture, in the attitude, and action. They never appear with haughty looks, or with the splendor of royalty; no figure is ever seen presenting any thing to them with bended knee, except captives; and none addresses them with an inclination of the head. In modern works too little attention has been paid to the ancient *costume*. Winkelmann mentions a bas-relief, which was lately executed at Rome for the fountain of Trevi, representing an architect in the act of presenting the plan of an aqueduct to Marcus Agrippa. The modern sculptor, not content with giving a long beard to that illustrious Roman, contrary to all the ancient marble statues as well as medals which remain, exhibits the architect on his knees.

In general, it was an established principle to banish all violent passions from public monuments. This will serve as a decisive mark to distinguish the true antique from supposititious works. A medal has been found exhibiting two Assyrians, a man and woman tearing their hair, with this inscription, ASSYRIA. ET. PALÆSTINA. IN. POTEST. P. R. REDAC. S. C. The forgery of this medal is manifest from the word *Palæstina*, which is not to be found in any ancient Roman medal with a Latin inscription. Besides, the violent action of tearing the hair does not suit any symbolical figure. This extravagant style, which was called by the ancients *parenthyrsis*, has been imitated by most of the modern artists. Their figures resemble comedians on the ancient theatres, who, in order to suit the distant spectators, put on painted masks, employed exaggerated gestures, and far overleaped the bounds of nature. This style has been reduced into a theory in a treatise on the passions composed by Le Brun. The designs which accompany that work exhibit the passions in the very highest degree, approaching even to frenzy: but these are calculated to vitiate the taste, especially of the young; for the ardour of youth prompts them rather to seize the extremity than the middle; and it will be difficult for that artist who has formed his taste from such impassioned models ever to acquire that noble simplicity and sedate grandeur which distinguished the works of ancient taste.

PROPORTION is the basis of beauty, and there can be no beauty without it; on the contrary, proportion may exist where there is little beauty. Experience every day teaches us that knowledge is distinct from taste; and proportion, therefore, which is founded on knowledge, may be strictly observed in any figure, and yet the figure have no pretensions to beauty. The ancients considering ideal beauty as the most perfect, have frequently employed it in preference to the beauty of nature.

The body consists of three parts as well as the members. The three parts of the body are the trunk, the thighs, and the legs. The inferior part of the body are the thighs, the legs, and the feet. The arms also consist of three parts. These three parts must bear a certain proportion to the whole as well as to one another. In a well formed man the head and body must be proportioned to the thighs, the legs, and the feet, in the same manner as the thighs are proportioned to the legs and the feet, or the arms to the hands. The face



also consists of three parts, that is, three times the length of the nose; but the head is not four times the length of the nose, as some writers have asserted. From the place where the hair begins to the crown of the head are only three-fourths of the length of the nose, or that part is to the nose as 9 to 12.

It is probable that the Grecian, as well as Egyptian artists, have determined the great and small proportions by fixed rules; that they have established a positive measure for the dimensions of length, breadth, and circumference. This supposition alone can enable us to account for the great conformity which we meet with in ancient statues. Winkelman thinks that the foot was the measure which the ancients used in all their great dimensions, and that it was by the length of it that they regulated the measure of their figures, by giving to them six times that length. This in fact is the length which Vitruvius assigns, *Pes vero altitudinis corporis sexta*, l. 3. cap. 1. That celebrated antiquary thinks the foot is a more determinate measure than the head or the face, the parts from which modern painters and sculptors too often take their proportions. This proportion of the foot to the body, which has appeared strange and incomprehensible to the learned Huetius, and has been entirely rejected by Perrault, is however founded upon experience. After measuring with great care a vast number of figures, Winkelman found this proportion observed not only in Egyptian statues, but also in those of Greece. This fact may be determined by an inspection of those statues the feet of which are perfect. One may be fully convinced of it by examining some divine figures, in which the artists have made some parts beyond their natural dimensions. In the Apollo Belvidere, which is a little more than seven heads high, the foot is three Roman inches longer than the head. The head of the Venus de Medicis is very small, and the height of the statue is seven heads and a half: the foot is three inches and a half longer than the head, or precisely the sixth part of the length of the whole statue.

PRACTICE OF SCULPTURE.

WE have been thus minute in our account of the Grecian sculpture, because it is the opinion of the ablest critics that modern artists have been more or less eminent as they have studied with the greater or less attention the models left us by that ingenious people: Winkelman goes so far as to contend that the most finished works of the Grecian masters ought to be studied in preference even to the works of nature. This appears to be paradoxical; but the reason assigned by the Abbé for his opinion is, that the fairest lines of beauty are more easily discovered, and make a more striking and powerful impression, by their reunion in these sublime copies, than when they are scattered far and wide in the original. Allowing, therefore, the study of nature the high degree of merit it so justly claims, it must nevertheless be granted, that it leads to true beauty by a much more tedious, laborious, and difficult path, than the study of the *antique*, which presents immediately to the artist's view the object of his researches, and combines in a clear and strong point of light the various rays of beauty that are dispersed through the wide domain of nature.

As soon as the artist has laid this excellent founda-

tion, acquired an intimate degree of familiarity with the beauties of the Grecian statues, and formed his taste after the admirable models they exhibit, he may then proceed with advantage and assurance to the imitation of nature. The ideas he has already formed of the perfection of nature, by observing her dispersed beauties combined and collected in the compositions of the ancient artists, will enable him to acquire with facility, and to employ with advantage, the detached and partial ideas of beauty which will be exhibited to his view in a survey of nature in her actual state. When he discovers these partial beauties, he will be capable of combining them with those perfect forms of beauty with which he is already acquainted. In a word, by having always present to his mind the noble models already mentioned, he will be in some measure his own oracle, and will draw rules from his own mind.

There are, however, two ways of imitating nature. <sup>43</sup> In the one a single object occupies the artist, who endeavours to represent it with precision and truth; in the other, certain lines and features are taken from a variety of objects, and combined and blended into one regular whole. All kinds of copies belong to the first kind of imitation; and productions of this kind must be executed necessarily in the Dutch manner, that is to say, with high finishing, and little or no invention. But the second kind of imitation leads directly to the investigation and discovery of true beauty, of that beauty whose idea is connate with the human mind, and is only to be found there in its highest perfection. This is the kind of imitation in which the Greeks excelled, and in which men of genius excite the young artists to excel after their example, *viz.* by studying nature as they did.

After having studied in the productions of the Grecian masters their choice and expression of select nature, their sublime and graceful contours, their noble draperies, together with that sedate grandeur and admirable simplicity that constitute their chief merit, the curious artists will do well to study the manual and mechanical part of their operations, as this is absolutely necessary to the successful imitation of their excellent manner.

It is certain that the ancients almost always formed <sup>45</sup> their first models in wax: to this modern artists have substituted clay, or some such composition: they prefer clay before wax in the carnations, on account of the yielding nature of the latter, and its sticking in some measure to every thing it touches. We must not, however, imagine from hence that the method of forming models of wet clay was either unknown or neglected among the Greeks; on the contrary, it was in Greece that models of this kind were invented. Their author was Dibutades of Sicyon; and it is well known that Arcefilas, the friend of Lucullus, obtained a higher degree of reputation by his clay models than by all his other productions. Indeed, if clay could be made to preserve its original moisture, it would undoubtedly be the fittest substance for the models of the sculptor; but when it is placed either in the fire or left to dry imperceptibly in the air, its solid parts grow more compact, and the figure losing thus a part of its dimensions, is necessarily reduced to a smaller volume. This diminution would be of no consequence did it equally affect the whole figure, so as to preserve its proportions entire.

<sup>47</sup> Grecian sculpture to be studied by the modern artists.

<sup>43</sup> Two ways of imitating nature.

<sup>45</sup> Models of statues.

ture. But this is not the case: for the smaller parts of the figure dry sooner than the larger; and thus losing more of their dimensions in the same space of time than the latter do, the symmetry and proportions of the figure inevitably suffer. This inconveniency does not take place in those models that are made in wax. It is indeed extremely difficult, in the ordinary method of working the wax, to give it that degree of smoothness that is necessary to represent the softness of the carnations or fleshy parts of the body. This inconveniency may, however, be remedied, by forming the model first in clay, then moulding it in plaster, and lastly casting it in wax. And, indeed, clay is seldom used but as a mould in which to cast a figure of plaster, stucco, or wax, to serve henceforth for a model by which the measures and proportions of the statue are to be adjusted. In making waxen models, it is common to put half a pound of colophony to a pound of wax; and some add turpentine, meltin; the whole with oil of olives.

50  
Method of  
working  
the mar-  
ble, and

So much for the first or preparatory steps in this procedure. It remains to consider the manner of working the marble after the model so prepared; and the method here followed by the Greeks seems to have been extremely different from that which is generally observed by modern artists. In the ancient statues we find the most striking proofs of the freedom and boldness that accompanied each stroke of the chisel, and which resulted from the artist's being perfectly sure of the accuracy of his idea, and the precision and steadiness of his hand; the most minute parts of the figure carry these marks of assurance and freedom; no indication of timorousness or diffidence appear; nothing that can induce us to fancy that the artist had occasion to correct any of his strokes. It is difficult to find, even in the second-rate productions of the Grecian artists, any mark of a false stroke or a random touch. This firmness and precision of the Grecian chisel were certainly derived from a more determined and perfect set of rules than those which are observed in modern times.

The method generally observed by the modern sculptor is as follows: First, out of a great block of marble he saws another of the size required, which is performed with a smooth steel saw, without teeth, casting water and sand thereon from time to time; then he fashions it, by taking off what is superfluous with a steel point and a heavy hammer of soft iron; after this, bringing it near the measure required, he reduces it still nearer with another finer point; he then uses a flat cutting instrument, having notches in its edge; and then a chisel to take off the scratches which the former has left; till, at length, taking rasps of different degrees of fineness, by degrees he brings his work into a condition for polishing.

After this, having studied his model with all possible attention, he draws upon this model horizontal and perpendicular lines which intersect each other at right angles. He afterwards copies these lines upon his marble, as the painter makes use of such transversal lines to copy a picture, or to reduce it to a smaller size. These transversal lines or squares, drawn in an equal number upon the marble and upon the model, in a manner proportioned to their respective dimensions, exhibit accurate measures of the surfaces upon which the artist is to work; but cannot determine, with equal precision, the depths that are proportioned to these surfaces.—

The sculptor, indeed, may determine these depths by observing the relation they bear to his model; but as his eye is the only guide he has to follow in this estimate, he is always more or less exposed to error, or at least to doubt. He is never sure that the cavities made by his chisel are exact; a degree of uncertainty accompanies each stroke; nor can he be assured that it has carried away neither too much nor too little of his marble. It is equally difficult to determine, by such lines as have already been mentioned, the external and internal contours of the figure, or to transfer them from the model to the marble. By the internal contour is understood that which is described by the parts which approach towards the centre, and which are not marked in a striking manner.

It is farther to be noticed, that in a complicated and laborious work, which an artist cannot execute without assistance, he is often obliged to make use of foreign hands, that have not the talents or dexterity that are necessary to finish his plan. A single stroke of the chisel that goes too deep is a defect not to be repaired; and such a stroke may easily happen, where the depths are so imperfectly determined. Defects of this kind are inevitable, if the sculptor, in chipping his marble, begins by forming the depths that are requisite in the figure he designs to represent. Nothing is more liable to error than this manner of proceeding. The cautious artist ought, on the contrary, to form these depths gradually, by little and little, with the utmost circumspection and care; and the determining of them with precision ought to be considered as the last part of his work, and as the finishing touches of his chisel.

The various inconveniences attending this method determined several eminent artists to look out for one that would be liable to less uncertainty, and productive of fewer errors. The French academy of painting at Rome hit upon a method of copying the ancient statues, which some sculptors have employed with success, even in the figures which they finished after models in clay or wax. This method is as follows. The statue that is to be copied is inclosed in a frame that fits it exactly. The upper part of this frame is divided into a certain number of equal parts, and to each of these parts a thread is fixed with a piece of lead at the end of it. These threads, which hang freely, show what parts of the statue are most removed from the centre with much more perspicuity and precision than the lines which are drawn upon its surface, and which pass equally over the higher and hollow parts of the block: they also give the artist a tolerable rule to measure the more striking variations of height and depth, and thus render him more bold and determined in the execution of his plan.

But even this method is not without its defects: for as it is impossible, by the means of a straight line, to determine with precision the procedure of a curve, the artist has, in this method, no certain rule to guide him in his contours; and as often as the line which he is to describe deviates from the direction of the plumb line, which is his main guide, he must necessarily find himself at a loss, and be obliged to have recourse to conjecture.

It is also evident, that this method affords no certain rule to determine exactly the proportion which the various parts of the figure ought to bear to each other, considered in their mutual relation and connections. The artist, indeed, endeavours to supply this defect by

intersecting the plumb-lines by horizontal ones. This recourse has, nevertheless, its inconveniences, since the squares formed by transversal lines, that are at a distance from the figure (though they be exactly equal), yet represent the parts of the figure as greater or smaller, according as they are more or less removed from our position or point of view. But, notwithstanding these inconveniences, the method now under consideration is certainly the best that has hitherto been employed: it is

more practicable and sure than any other we know, though it appears, from the remarks we have now been making, that it does not exhibit a sure and universal criterion to a sculptor who executes after a model.

To polish the statue, or make the parts of it smooth and sleek, they use pumice-stone and smelt; then tripoli; and when a still greater lustre is required, they use burnt straw. For the  *Casting of Statues*, see  *FOUNDRY*, and  *PLASTER of Paris*.

52  
Of polishing the statue.

S C U

SCUM, properly denotes the impurities which a liquor, by boiling, casts up to the surface. The term *scum* is also used for what is more properly called the scoria of metals.

SCUPPERS, in a ship, are certain channels cut through the water-ways and sides of a ship, at proper distances, and lined with plated lead, in order to carry the water off from the deck into the sea. The scuppers of the lower deck of a ship of war are usually furnished with a leathern pipe, called the *scupper-hose*, which hangs downward from the mouth or opening of the scupper. The intent of this is to prevent the water from entering when the ship inclines under a weight of sail.

SCURVY, in medicine, see that article, n<sup>o</sup> 351, where we have given an account of the symptoms, causes, and modes of prevention and cure, according to some of the most eminent writers in medicine. We have here only to add, that, in the opinion of Dr Beddoes, the mineral acids, especially the nitric and vitriolic, may be employed in the prevention or cure of this dreadful disease with as much success as the vegetable acids.— But of all the substances that can at once be cheaply procured and long preserved, he thinks the concrete acid of tartar by far the most promising. It is very grateful, and comes near to the citric acid. In tropical countries the scurvy is seldom known.

*SCURVY-grass*, in botany. See *COCHLEARIA*.

The officinalis, or common officinal scurvy-grass, grows upon rocks on the sea coast, and on the Highland mountains, abundantly. It has an acrid, bitter, and acid taste, and is highly recommended for the scurvy. There are instances of a whole ship's crew having been cured of that distemper by it; and as it abounds with acid salts, there can be no doubt but that it is a great resister of putrefaction. The best way of taking it is raw in a salad. It is also diuretic, and useful in dropsies. The Highlanders esteem it as a good stomachic.

The coronopus, another species, was some years ago rendered famous, the ashes of it being an ingredient in Mrs Joanna Stephens's celebrated medicine for the stone and gravel; but, unfortunately for those afflicted with that excruciating complaint, it has not been able to support its credit. It is acrid, and tastes like garden cress.

SCUTAGE (*scutagium*, Sax. *scilpening*), was a tax or contribution raised by those that held lands by knights service, towards furnishing the king's army, at one, two, or three marks for every knight's fee. Henry III. for his voyage to the Holy Land, had a tenth granted by the clergy, and *scutage* three marks of every

S C Y

knight's fee by the *laidy*. This was also levied by Henry II. Richard I. and King John. See *KNIGHT-SERVICE*.

SCUTE (*scutum*), a French gold coin of 3s. 4d. in the reign of king Henry V. Catharine queen of England had an assurance made her of sundry castles, manors, lands, &c. valued at the sum of 40,000 *scutes*, every two whereof were worth a noble. *Rot. Parl.* 1. *Hen. VI.*

SCUTELLARIA, SKULL-CAP, in botany: A genus of the gymnospermia order, belonging to the didynamia class of plants; and in the natural method ranking under the 40th order, *Perispermata*. The calyx is short, tubulated, has the mouth entire, and close after flowering. There are two species in Britain, the *galericulata* and *minor*. 1. The *Galericulata*, *Blue Skull-cap*, or *Hooded Willow-herb*. The stems are weak, branched, and above a foot high; the leaves are heart-shaped, narrow-pointed, on short foot-stalks, and scalloped; the flowers are blue, in pairs, on pedicles from the axils of the leaves, and pendulous. It grows on the banks of rivers and lakes, is bitter, and has a garlic smell. 2. *Minor*, *little red Skull-cap*, or *Willow-herb*. The stalks are about eight inches high; the leaves are heart-shaped, oval; the flowers are purple. It grows in fens, and on the sides of lakes.

SCUTTLES, in a ship, square holes cut in the deck, big enough to let down the body of a man, and which serve upon some occasions to let the people down into any room below, or from one deck to another.

SCYLAX, a celebrated mathematician and geographer of Caria, flourished under the reign of Darius Hytaspes, about 558 B. C. Some have attributed to him the invention of geographical tables. We have under his name a geographical work published by Hofschelius; but it is written by a much later author, and is perhaps only an abridgment of Scylax's *Ancient Geography*.

SCYLLA (anc. geog.), a rock in the Fretum Siculum, near the coast of Italy, dangerous to shipping, opposite to Charybdis, a whirlpool on the coast of Sicily; both of them famous in mythology.

Scylla and Charybdis have been almost subdued by the repeated convulsions of this part of the earth, and by the violence of the current, which is continually increasing the breadth of the Straits. If proper allowance be made for these circumstances, we shall acquit the ancients of any exaggeration, notwithstanding the very dreadful colours in which they have painted this passage. It is formed by a low peninsula, called *Cape Pelorus*, stretching to the eastward on the Sicilian side,

Scute  
||  
Scylla.

See *Strabo's*  
*Tour up the*  
*Straits.*  
Letter x. l.

Scum  
||  
Scu age.

Scylla  
||  
Scythia.

immediately within which lies the famous whirlpool of Charybdis, and by the rocks of Scylla, which a few miles below on the Calabrian shore project towards the west. The current runs with surprising force from one to the other alternately in the direction of the tide, and the tides themselves are very irregular. Thus vessels, by shunning the one, were in the utmost danger of being swallowed up by the other.

At present, in moderate weather, when the tide is either at ebb or flood, boats pass all over the whirlpool: but, in general, it is like the meeting of two contending currents, with a number of eddies all around; and, even now, there is scarcely a winter in which there are not some wrecks.

“At the time when we passed the Straits (says Captain Sutherland, from whom we have obtained this accurate information) the weather was as favourable as we could wish; and yet, in spite of a strong breeze and the current, which hurried us on with surprising velocity, the ship's head was suddenly whirled round near three points; but the wind blowing fresh, in a few seconds she dashed through the eddy that had caught her; for, to avoid Scylla, and secure Messina, we had kept pretty close to Charybdis.”

SCYROS, an island in the Ægean sea, at the distance of about 28 miles north-east from Eubœa. It is 60 miles in circumference. It was originally in the possession of the Pelasgians and Carians. Achilles retired there to avoid going to the Trojan war, and became father of Neoptolemus by Deidamia the daughter of king Lycomedes. Scyros was conquered by the Athenians under Cimon. It was very rocky and barren. Now *Sciro*. E. Long. 25. O. N. Lat. 38. 15.

SCYT<sup>A</sup>LA LACONICA, in antiquity, a stratagem or device of the Lacedæmonians, for the secret writing of letters to their correspondents, so that if they should chance to be intercepted, nobody might be able to read them.—To this end they had two wooden rollers or cylinders, perfectly alike and equal; one whereof was kept in the city, the other by the person to whom the letter was directed. For the letter, a skin of very thin parchment was wrapped round the roller, and thereon was the matter written; which done, it was taken off, and sent away to the party, who, upon putting it in the same manner upon his roller, found the lines and words in the very same disposition as when they were first written. This expedient they set a very high value on; though, in truth, artless and gross enough: the moderns have improved vastly on this method of writing. See CIPHER.

SCYTALIA, in botany: A genus of the monogynia order, belonging to the octandria class of plants; and in the natural method ranking with those that are doubtful. The calyx is very short, monophyllous, and somewhat quinque-dentate; the corolla pentapetalous; the filaments hairy at the base; the berry unilocular, with one seed of a soft pulpy consistence. There is only one species, viz. the *Sinensis*, a native of the East Indies.

SCYTHIA, an ancient name for the northern parts of Asia, now known by the name of *Tartary*; also for some of the north-eastern parts of Europe.

This vast territory, which extends itself from the Ister or Danube, the boundary of the Celts, that is, from

about the 25th to almost the 110th degree of east longitude, was divided into Scythia in Europe and Scythia in Asia, including, however, the two Sarmatias; or, as they are called by the Greeks, *Sauromatias*, now the Circassian Tartary, which lay between and severed the two Scythias from each other. Sauromatia was also distinguished into European and Asiatic; and was divided from the European Scythia by the river Don or Tanais, which falls into the Palus Meotis; and from the Asiatic by the Rha, now Volga, which empties itself into the Caspian sea.

1. The Asiatic Scythia comprehended, in general, great Tartary, and Russia in Asia; and, in particular, the Scythia beyond or without Imaus, contained the regions of Bogdoi or Ostiacoi, and Tanguti. That within, or on this side Imaus, had Turkellan and Mongal, the Usbeck or Zagatai, Kalmuc and Nagaian Tartars; besides Siberia, the land of the Samoiedes, and Nova Zembla. These three last not being so soon inhabited as the former, as may be reasonably supposed, were wholly unknown to the ancients; and the former were peopled by the Bactrians, Sogdians, Gandari, Sacks, and Massagetes. As for Sarmatia, it contained Albania, Iberia, and Colchis; which makes now the Circassian Tartary, and the province of Georgia.

2. Scythia in Europe reached (towards the south-west) to the Po and the Alps, by which it was divided from Celto-Gallia. It was bounded on the south by the Ister or Danube and the Euxine sea. Its northern limits have been supposed to stretch to the spring-heads of the Boristhenes or Nieper, and the Rha or Volga, and so to that of the Tanais.—The ancients divided this country into Scythia Arimaspea, which lay eastward, joining to Scythia in Asia; and Sarmatia Europea on the west. In Scythia, properly so called, were the Arimaspeæ on the north; the Getæ or Dacians along the Danube, on the south; and the Neuri between these two. So that it contained the European Russia or Muscovy, and the Lesser Crimean Tartary eastward; and, on the west, Lithuania, Poland, part of Hungary, Transilvania, Walachia, Bulgaria, and Moldavia. Sarmatia is supposed to have reached northward to that part of Swedeland called *Feningia*, now *Finland*; in which they placed the Oenes, Panoti, and Hippopodes. This part they divided from northern Germany, now the west part of Sweden and Norway, by the *Mare Sarmaticum* or *Scythicum*, which they supposed ran up into the northern ocean, and, dividing Lapland into two parts, formed the western part of Sweden, with Norway, into one island, and Finland into another; supposing this also to be cut off from the continent by the gulph of that name.

Although the ancient Scythians were celebrated as a warlike people, yet their history is too uncertain and obscure to enable us to give any detail which would not prove equally tiresome and uninteresting to the reader. Mr Pinkerton, in a dissertation on their origin, endeavours to prove that they were the most ancient of nations; and he assigns for the place of their first habitation the country known by the name of Persia. From Persia, he thinks, they proceeded in numerous hordes westward; furrounded the Euxine, peopled Germany, Italy, Gaul, the countries bordering on the Baltic, with part of Britain and Ireland. That the Scythians were of Asiatic

Scythia.

Scythian  
||  
Sea.

atic origin cannot, we think, be questioned; and as Persia was peopled at a very early period, it may not improbably have been their parent country: but when our author contends that their empire had subsisted for more than 1500 years before Ninus the founder of the Assyrian monarchy, and that it extended from Egypt to the Ganges, and from the Persian gulf and Indian sea to the Caspian, we cannot help thinking that his prejudices against the Celts, and his desire to do honour to his favourite Goths, have made him advance a paradox inconsistent with the most authentic records of antiquity. His dissertation however is ingenious, and replete with a variety of curious learning.

SCYTHIAN Lamb, in natural history. See *Scythian LAMB*.

SCYTHROPS, a general name given by Mr Latham to a bird of which hitherto but one species has been observed. It is about the size of a crow, and two feet three inches in length. The bill is large, convex, furrowed on the sides, and bent at the tip; the nostrils are placed at the base of it, and the tongue is cloven at the end. The general colour of the plumage is a brownish ash, but the tip of each feather of the back, wings, and tail, is black. The tail has each feather banded with black at the end, and the tip itself white; but the inner webs of the feather are marked with black and white bands. The toes are placed two forwards and two backwards, as in the parrot genus. This curious bird is a native of New Holland, and we believe in that part of the world is not uncommon, but its manners are as yet quite unknown. We are happy in being able to present our readers with an engraving of it from an excellent drawing with which we were lately favoured. See plate CCCCXLIX.

SEA, in a strict sense, signifies a large portion of water almost surrounded by land, as the Baltic and Mediterranean seas; but it is frequently used for that vast body of water which encompasses the whole earth.

What proportion the superficies of the sea bears to that of the land cannot easily be ascertained. Buffon has supposed that the surface of our globe is equally divided between land and water, and has accordingly calculated the superficies of the sea to be 85,490,506 square miles. But it is now well known that the ocean covers much more than the half of the earth's surface. Buffon believed the existence of a vast southern continent, which Captain Cook has shown to be visionary. It was this circumstance which misled him. According to the most accurate observations hitherto made, the surface of the sea is to the land as three to one; the ocean therefore extends over 128,735,759 square miles, supposing the superficies of the whole globe to be 170,941,012 square miles. To ascertain the depth of the sea is still more difficult than its superficies, both on account of the numerous experiments which it would be necessary to make, and the want of proper instruments for that purpose. Beyond a certain depth the sea has hitherto been found unfathomable; and though several methods have been contrived to obviate this difficulty, none of them has completely answered the purpose. We know in general that the depth of the sea increases gradually as we leave the shore; but if this continued beyond a certain distance, the depth in the middle of the ocean would be prodigious. Indeed the numerous islands everywhere scattered in the sea demonstrate the con-

trary, by showing us that the bottom of the water is unequal like the land, and that so far from uniformly sinking, it sometimes rises into lofty mountains. If the depth of the sea be in proportion to the elevation of the land, as has generally been supposed, its greatest depth will not exceed five or six miles, for there is no mountain six miles perpendicular above the level of the sea. The sea has never been actually sounded to a greater depth than a mile and 66 feet; every thing beyond that therefore rests entirely upon conjecture and analogical reasoning, which ought never to be admitted to determine a single point that can be ascertained by experiment, because, when admitted, they have too often led to false conclusions. Along the coasts, where the depth of the sea is in general well known, it has always been found proportioned to the height of the shore: when the coast is high and mountainous, the sea that washes it is deep; when, on the contrary, the coast is low, the water is shallow. Whether this analogy holds at a distance from the shore, experiments alone can determine.

To calculate the quantity of water contained in the sea, while its depth is unknown, is impossible. But if we suppose with Buffon that its medium depth is the fourth part of a mile, the ocean, if its superficies be 128,735,759 square miles, will contain 32,058,939.75 cubic miles of water.

Let us now endeavour to compute the quantity of water which is constantly discharged into the sea. For this purpose let us take a river whose velocity and quantity of water is known, the Po, for instance, which according to Riccioli is 1000 feet (or 100 perches of Boulogne) broad, 10 feet deep, and runs at the rate of four miles in an hour; consequently that river discharges into the sea 200,000 cubic perches of water in an hour, or 4,800,000 in a day. A cubic mile contains 125,000,000 cubic perches; the Po therefore will take 26 days to discharge a cubic mile of water into the sea. Let us now suppose, what is perhaps not very far from the truth, that the quantity of water which the sea receives from the rivers in any country is proportioned to the extent of that country. The Po from its origin to its mouth traverses a country 380 miles long, and the rivers which fall into it on every side rise from sources about sixty miles distant from it. The Po, therefore, and the rivers which it receives, water a country of 43,600 square miles. Now since the whole superficies of the dry land is about 42,745,253 square miles, it follows, from our supposition, that the quantity of water discharged by all the rivers in the world, in one day, is 36 cubic miles, and in a year 13,140. If therefore the sea contains 32,058,939 cubic miles of water, it would take all the rivers in the world 2459 years to discharge an equal quantity.

It may seem surprising that the sea, since it is continually receiving such an immense supply of water, does not visibly increase, and at last cover the whole earth. But our surprise will cease, if we consider that the rivers themselves are supplied from the sea, and that they do nothing more than carry back those waters which the ocean is continually lavishing upon the earth. Dr Halley has demonstrated that the vapours raised from the sea and transported upon land are sufficient to maintain all the rivers in the world. The simplicity of this great process is astonishing: the sea not only connects distant

Sea

Quantity  
of water  
which it  
contains.

Buffon's  
Theory of  
the Earth,  
art. 10.

Why it  
does not  
increase.

Sea.

distant countries, and renders it easy to transport the commodities of one nation to another, but its waters rising in the air descend in showers to fertilise the earth and nourish the vegetable kingdom, and collecting into rivers flow onwards, bringing fertility and wealth and commerce along with them, and again return to the sea to repeat the same round.

5  
Theories of philo-  
sophers on  
this sub-  
j-ct.

The knowledge of this process of nature might, one would think, have convinced philosophers that the proportion between sea and land continued always nearly the same. Philosophers however have formed different theories about this as well as most other subjects, maintaining on the one hand that the sea is continually encroaching on the land, and on the other that the land is constantly gaining on the sea. Both sides have supported their theories by arguments, demonstrations, and uncontrovertible facts!

6  
Arguments  
of those  
who affirm  
that the sea  
is encroach-  
ing on the  
land.

The height of the mountains, say the philosophers who support the encroachments of the sea, is continually diminishing; exposed to the violence of every storm, the hardest rocks must at last give way and tumble down. The rivers are continually sweeping along with them particles of earth which they deposit in the bottom of the sea. Both the depth of the ocean then and the height of the dry land must be always decreasing; the waters therefore must, unless a part of them were annihilated, spread over a greater extent of surface in proportion as these causes operate. This reasoning, convincing as it is, might be confirmed by a great number of facts: it will be sufficient however to mention one or two. In the reign of Augustus the isle of Wight made a part of Britain, so that the English crossed over to it at low water with cart loads of tin; yet that island is at present separated from Britain by a channel half a mile wide. The Godwin sands on the eastern shore of England were formerly the fertile estate of earl Godwin. Nor are the encroachments of the sea confined to Britain. In the bay of Baize near Naples there are remains of houses and streets still visible below the present level of the sea. The sea therefore is making continued encroachments upon the land; and the time will come, say they, when the waters will again cover the surface of the earth.

7  
Arguments  
of those  
who affirm  
that the  
land is  
gain- ing on  
the sea.

Such are the arguments of those philosophers who maintain the continual encroachments of the sea. Those who maintain the opposite theory, that the land is gradually gaining on the sea, though they pretend not to deny the facts advanced by their opponents, affirm that they are altogether insufficient to establish the hypothesis which they were brought forward to support. Though the rivers carry down particles of earth into the sea, these, say they, are either accumulated on other shores, or, collecting in the bottom of the ocean, harden into stone, which being possessed of a vegetative power rises by degrees above the surface of the sea and forms rocks, and mountains, and islands. The vegetative nature of stone indeed is sufficient, of itself, to convince us that the quantity of earth must be daily accumulating, and consequently that the surface of the sea is diminishing in extent. Cellius, a Swedish philosopher (for this dispute has been carried on in Sweden with the greatest keenness), has endeavoured to build this

theory with more solid materials than vegetable stone. In a curious memoir, published in 1743, he asserts that the Baltic and the Atlantic, at least that part of it which washes Norway, is constantly diminishing; and he proves this by the testimony of a great many aged pilots and fishermen, who affirmed that the sea was become much shallower in many places than it had been during their youth: that many rocks formerly covered with water were now several feet above the surface of the sea: that loaded vessels used formerly to ride in many places where pinnaces and barks could now with difficulty swim. He produces instances of ancient sea port towns now several leagues from the shore, and of anchors and wrecks of vessels found far within the country. He mentions a particular rock which 168 years before was at the bottom of the sea, but was then raised eight feet above its surface. In another place where the water 50 years before had reached to the knee there was then none. Several rocks, too, which during the infancy of some old pilots had been two feet under water, were then three feet above it. From all these observations M. Cellius concludes, that the water of the Baltic decreases in height  $4\frac{1}{2}$  lines in a year, 4 inches 5 lines in 18 years, 4 feet 5 inches in a hundred years, and in a thousand years 45 feet. Conscious, however, that these facts, how conclusive soever as far as relates to the Baltic, can never determine the general question, M. Cellius advances another argument in support of his theory. All that quantity of moisture, says he, which is imbibed by plants is lost to the general mass of water, being converted into earth by the putrefaction of vegetables. This notion had been mentioned by Newton, and was adopted by Van Helmont: if granted, it follows as a consequence that the earth is continually increasing and the water diminishing in a very rapid degree.

Such are the arguments advanced in support of both theories; for it is needless to mention a notion of Linnæus that the whole earth was formerly covered with water except a single mountain. When fairly weighed, they amount to nothing more than this, that the sea has encroached upon the land in some places, and retired in others; a conclusion which we are very willing to allow. What was advanced by those philosophers, who maintain that the sea is continually encroaching on the land, about the depth of the sea constantly diminishing, must remain a mere assertion till they prove by experiments, either that this is really the case, or that nature has no way of restoring those particles of earth which are washed down by the rivers. Nor have they any good reason to affirm that the height of the mountains is decreasing. Can a single uncontrovertible instance be produced of this? Are the Alps or the Apennines, or Taurus, or Caucasus, less lofty now than they were a thousand years ago? We mean not to deny that the rain actually washes down particles of earth from the mountains, nor to affirm that the hardest rocks are able to resist continual storms, nor that many mountains have suffered, and continue to suffer daily, from a thousand accidents. But the effects produced by all these causes are so trifling as to be altogether imperceptible (A). Nature has assiduously guarded against such accidents; she has formed the mountains of the most durable

Sea.

(A) M. Genfanne pretends that the Pyrenean mountains become an inch lower every ten years. But even according

Sea.

ble materials; and where they are covered with earth, she has bound it together by a thick and firm matting of grafs, and thus fecured it from the rains; and should accident deprive it of this covering, she takes care immediately to fupply the defect. Even should the earth be fwept away together with its covering, nature has ftill fuch resources left as frequently reftore things to their former ftate. Many kinds of mofs, one would be tempted to think, have been created for this very purpofe: they take root and flourifh almoft upon the bare rock, and furnifh as they decay a fufficient bed for feveral of the hardy Alpine plants. Thefe perifh in their turn, and others fucceed them. The roots of the plants bind faft the earth as it accumulates, more plants fpring up and fpread wider, till by degrees the whole furface is covered with a firm coat of grafs. Even the rain, which always contains in it a good deal of earth, contributes fomewhat to haften the procefs.

As the vegetation of ftone, an argument advanced by the philofophers who fupport the oppofite theory, is now, we believe, given up by all parties, it is needless to take any farther notice of it here, (fee STONE). The hypothefis of M. Celfius, that water is converted into earth, has alfo fhared the fame fate, becaufe it was unfupported by experiment, and contrary to every thing that we know either about earth or water. It is a little extraordinary that philofophers have been fo lavifh of water as to convert it in this manner into ftone and earth, when they had given it, one would think, fufficient employment before in making new worlds and in confuting Mofes.

9  
tom of  
sea.

As the fea covers fo great a portion of the globe, we fhould, no doubt, by exploring its bottom, difcover a valt number of interefting particulars. Unfortunately in the greater part of the ocean this has hitherto been impoffible. Part, however, has been examined; and the difcoveries which this examination has produced may enable us to form fome idea at leaft of the whole. The bottom of the fea, as might have been conjectured indeed beforehand, bears a great refemblance to the furface of the dry land, being, like it, full of plains, rocks, caverns, and mountains; fome of which are abrupt and almoft perpendicular, while others rife with a gentle declivity, and fometimes tower above the water and form iflands. Neither do the materials differ which compofe the bottom of the fea and the bafis of the dry land. If we dig to a confiderable depth in any part of the earth, we uniformly meet with rock; the fame thing holds in the fea. The ftрата, too, are of the fame kind, difpofed in the fame manner, and form indeed but one whole. The fame kind of mineral and bituminous fubftances are alfo found interperfed with thefe ftрата; and it is to them probably that the fea is indebted for its bitter tafte. Over thefe natural and original ftрата an artificial bed has pretty generally been formed, compofed of different materials in different places. It confifts frequently of muddy tartareous fubftances firmly cemented

together, fometimes of fhells or coral reduced to powder, and near the mouths of rivers it is generally compofed of fine fand or gravel. The bottom of the fea refembles the land likewife in another particular: many frefh fountains and even rivers rife out of it, which, difplacing the falt water, render the lower part of the fea wherever they abound quite frefh. An inftance of this kind occurs near Goa on the weftern coaft of India \*; and another † in the Mediterranean fea not far from Marfeilles. Thefe facts occafioned a notion, which later experiments have exploded, that the fea beyond a certain depth was always frefh.

Subftances of a very beautiful appearance are frequently brought up by the founding line from the bottom of the fea. The plummet is hollowed below, and this cavity filled with tallow, to which fome of the fubftances adhere which form the bed of the ocean. Thefe are generally fand, gravel, or mud; but they are fometimes of the brighteft fcarlet, vermilion, purple, and yellow; and fometimes, though lefs frequently, they are blue, green, or white. Thefe colours are owing to a kind of jelly which envelopes the fubftances, and vanifh entirely as foon as this jelly dries. At times, however, they affume the appearance of tartareous crufts, and are then fo permanent, that they can be received into white wax melted and poured round them, and perhaps by proper care might be converted into valuable paints.

Sea-water is really, as any one may convince himfelf by pouring it into a glafs, as clear and tranfparent as river water. The various appearances therefore which it affumes are owing to accidental caufes, and not to any change in the water itfelf. The depth, or the materials which compofe the bottom of the fea, occafions it to affume different colours in different places. The Arabian gulph, for inftance, is faid to be red from the colour of the fands which form its bed. The appearance of the fea is affected too by the winds and the fun, while the clouds that pafs over it communicate all their various and fleeting colours. When the fun fhines it is green; when the fun gleams through a fog it is yellow; near the north pole it appears black; while in the torrid zone its colour is often brown. Sometimes the fea affumes a luminous appearance. See LIGHT, u<sup>o</sup> 17.

The fea contains the greateft quantity of falt in the torrid zone, where otherwife from the exceffive heat it would be in danger of putrefaction: as we advance northward this quantity diminifhes, till at the pole it nearly vanifhes altogether. Under the line Lucas found that the fea contained a feventh part of folid contents, confifting chiefly of fea-falt. At Harwich he found it yielded  $\frac{1}{12}$ th of fea-falt. At Carlferoon in Sweden it contains  $\frac{1}{10}$ th part (a), and on the coaft of Greenland a great deal lefs. This deficiency of falt near the poles probably contributes a good deal towards the prodigious quantities of ice which are met with in thefe fea;

for

according to his own calculation, it would require a million of years to level thefe mountains with the plain, though they continued to decrease at the fame rate; and philofophers tell us that this rate is constantly diminifhing!

(a) This gradual diminution of faltnefs from the equator to the pole is not, however, without particular exceptions. The Mediterranean fea contains  $\frac{1}{12}$ th of fea-falt, which is lefs than the German fea contains.

Sea.

\* *Boyle de Fonds Maris.*  
† *Marfigli Hiftoire*  
*Hyfique de la Mer, partie 1.*

<sup>10</sup>  
Colour of  
the fea.

<sup>11</sup>  
Surtnefs of  
the fea.

Sea.

for salt water requires a much greater degree of cold to freeze it than fresh water. It was this circumstance, probably, together with its constant motion, which induced the ancients to believe that the sea never froze. Even among the moderns it has been a generally received opinion, that sea-ice is originally formed in rivers. Buffon has made the great quantities of ice with which the South sea abounds an argument for the existence of a continent near the Antarctic pole. But it is now well known that great quantities of ice are formed at a distance from land. Sea-ice is of two kinds; field ice, which extends along the shore, and is only two or three feet thick; and mountain ice, which abounds in the middle of the ocean. The size of these mountains is sometimes prodigious. The sea-ice is always fresh, and has been often of great use to navigators. The weight of sea-water is to that of river-water as 73 to 70; that is, a cubic foot of sea-water weighs 73 lb. while the same quantity of river-water weighs only 70 lb.; but this proportion varies in different places. It is worthy of our attention, too, that the water at the surface of the sea contains less salt than near the bottom; the difference indeed is inconsiderable, but still it is something. The Comte de Marigli found the same quantity of water, when taken from the bottom of the Mediterranean, to weigh one ounce three pennyweights 51 grains; whereas from the surface it weighed only one ounce three pennyweights 49 grains. He repeated the experiment frequently with nearly the same result.

12  
Temperature of the sea.

Boyle de  
Temperie  
Regionum  
Submarina-  
rum.

Phil. Transf.  
for 1751,  
P. 213.

13  
The sea has three motions. Motion occasioned by the wind

The sea, with respect to temperature, may be divided into two regions: The first begins at the surface of the water, and descends as far as the influence of the sun's rays; the second reaches from thence to the bottom of the sea. In summer the lower region is considerably colder than the upper: but it is probable that during winter the very reverse takes place; at least the Comte de Marigli found it so repeatedly in the Mediterranean. This naturally results from the situation of the water near the bottom of the sea. Uninfluenced by the changes in the atmosphere, it retains always nearly the same degree of temperature: and this is considerably above congelation; for the lower region of the sea, at least in the temperate parts of the world, was never known to freeze. Captain Ellis let down a sea-gage (see GAGE) in latitude 25° 13' north, and longitude 25° 12' west, to take the degrees of temperature and saltness of the sea at different depths. It descended 5346 feet, which is a mile and eleven fathoms. He found the sea saltier and colder in proportion to its depth till the gage had descended 3900 feet, when the mercury in the thermometer came up at 53; but the water never grew colder, though he let down the gage 2446 feet lower. At the surface the thermometer stood at 84.

The sea has three kinds of motion: 1. The first is that undulation which is occasioned by the wind. This motion is entirely confined to the surface; the bottom even during the most violent storms remains perfectly calm. Mr Boyle has remarked, from the testimony of several divers, that the sea is affected by the winds only to the depth of six feet. It would follow from this, that the height of the waves above the surface does not exceed six feet; and that this holds in the Mediterranean at least, we are informed by the Comte de Marigli, though he also sometimes observed them, during a very violent tempest, rise two feet higher. It is as-

firming by Pliny, and several other ancient writers, that oil calms the waves of the sea; and that divers were accustomed to carry some of it for that purpose in their mouths. This account was always considered by the moderns as a fable, and treated with such contempt, that they did not even deign to put it to the test of experiment, till Dr Franklin accidentally discovered its truth. Happening in 1757 to be in the middle of a large fleet, he observed that the water round one or two vessels was quite calm and smooth, while everywhere else it was very much agitated by the winds. He applied to the captain for an explanation of this phenomenon, who replied, that the cooks, he supposed, had thrown their greasy water out at the scupper-holes, and by that means oiled the sides of the vessels in question. This answer did not satisfy the Doctor at first; but recollecting what Pliny had said on the subject, he resolved at least to try the experiment. He did so accordingly in 1762, and found that oil actually calmed the waves of the sea. He repeated the experiment upon lake Clapham: the oil spread itself with great rapidity upon the surface, but did not produce the desired effect, because, having been thrown in upon the side opposite to the wind, it was immediately driven to the edge of the water. But upon throwing in a like quantity upon the other side of the lake, it calmed in an instant several yards of the surface; and gradually spreading, rendered all that part of the lake, to the extent of at least half an acre, as smooth as glass. The curious effect produced by this liquid may be accounted for by the repulsion which exists between oil and water, and between oil and air, which prevents all immediate contact, all rubbing of the one upon the other.

2. The second kind of motion is that continual tendency which the whole water in the sea has towards the west. It is greater near the equator than about the poles; and indeed cannot be said to take place at all in the northern hemisphere beyond the tropic. It begins on the west side of America, where it is moderate: hence that part of the ocean has been called *Pacific*. As the waters advance westward their motion is accelerated; so that, after having traversed the globe, they strike with great violence on the eastern shore of America. Being stopped by that continent, they turn northward, and run with considerable impetuosity into the gulph of Mexico; from thence they proceed along the coast of North America, till they come to the south side of the great bank at Newfoundland, when they turn off, and run down through the Western Isles. This current is called the *Gulph Stream*. It was first accurately described by Dr Franklin, who remarked also, that the water in it having been originally heated in the torrid zone, cools so gradually in its passage northward, that even the latitude might be found in any part of the stream by means of a thermometer.— This motion of the sea westward has never been explained: it seems to have some connection with the trade-winds and the diurnal revolution of the earth on its axis.

3. The third and most remarkable motion of the sea is the tide, which is a regular swell of the ocean once every 12 hours, owing, as Newton has demonstrated, to the attraction of the moon. In the middle of the sea the tide seldom rises higher than one or two feet, but on the coast it frequently reaches the height of 45 feet,

Sea.  
14  
Stilled by oil.

15  
Motion towards the west—Currents.

16  
Motion occasioned by the tide.



feet, and in some places even more. The tide generally rises higher in the evening than in the morning: on the coast of Britain this holds in winter, but in summer the morning tides are highest. In some seas it is said that there are no tides. This cannot be owing to their being surrounded by land, because there is a tide in the lakes of North America. For an explanation of these and other phenomena we refer to the article TIDE.

*SEA-Air*, that part of the atmosphere which is above the sea.

Sea-air has been found salubrious and remarkably beneficial in some distempers. This may be owing to its containing a greater portion of oxygenous gas or vital air, and being less impregnated with noxious vapours than the land. Dr Ingenhousz made several experiments to ascertain the salubrity of sea-air. By mixing equal measures of common air and nitrous air, he found, that at Gravesend, they occupied about 104, or one measure, and  $\frac{1}{25}$  of a measure: whereas on sea, about three miles from the mouth of the Thames, two measures of air (one of common and one of nitrous air) occupied from 0.91 to 0.94. He attempted a similar experiment on the middle of the channel between the English coast and Ostend; but the motion of the ship rendered it impracticable. He found that in rainy and windy weather the sea-air contained a smaller quantity of vital air than when the weather was calm. On the sea-shore at Ostend it occupied from 94 $\frac{1}{2}$  to 97; at Bruges he found it at 105; and at Antwerp 109 $\frac{1}{2}$ . Dr Ingenhousz thus concludes his paper:

*It. Transf.*  
89, p. 354. It appears, from these experiments, that the air at sea and close to it is in general purer and fitter for animal life than the air on the land, though it seems to be subject to the same inconstancy in its degree of purity with that of the land; so that we may now with more confidence send our patients, labouring under consumptive disorders, to the sea, or at least to places situated close to the sea, which have no marshes in their neighbourhood. It seems also probable, that the air will be found in general much purer far from the land than near the shore, the former being never subject to be mixed with land air.

Dr Damman, an eminent physician and professor royal of midwifery at Ghent, told Dr Ingenhousz, that when he was formerly a practitioner at Ostend, during seven years, he found the people there remarkably healthy; that nothing was rarer there than to see a patient labouring under a consumption or asthma, a malignant, putrid, or spotted fever; that the disease to which they are the most subject, is a regular intermittent fever in autumn, when sudden transitions from hot to cold weather happen.

People are in general very healthy at Gibraltar, though there are very few trees near that place; which Dr Ingenhousz thinks is owing to the purity of the air, arising from the neighbourhood of the sea.

Most small islands are very healthy.

At Malta people are little subject to diseases, and live to a very advanced age.

*SEA-Anemony.* See ANIMAL-Flower.

*SEA-Bear.* }  
*SEA-Calf.* } See PHOCA.

*SEA-Cow.* See TRICHECUS.

*SEA-Crow, MIRE-Crow, or Pewit.* See LARUS.

Vol. XVII. Part I.

*SEA-Dead.* See ASPHALTICES,

*SEA-Devil.* See LOPHIUS.

*SEA-Dragon*, a monster of a very singular nature. In the Gentleman's Magazine for the year 1749, we have the account of a sea-dragon which was said to be taken between Orford and Southwold, on the coast of Suffolk, and afterwards carried round the country as a curiosity by the fisherman who caught it.

"Its head and tail (says the writer) resemble those of an alligator; it has two large fins, which serve it both to swim and to fly; and though they were so dried that I could not extend them, yet they appear, by the folds, to be shaped like those which painters have given to dragons and other winged monsters that serve as supporters to coats of arms. Its body is covered with impenetrable scales; its legs have two joints, and its feet are hooped like those of an ass: it has five rows of very white and sharp teeth in each jaw, and is in length about four feet, though it was longer when alive, it having shrunk as it became dry.

"It was caught in a net with mackerel; and being dragged on shore, was knocked down with a stretcher or boat-hook. The net being opened, it suddenly sprung up, and flew above 50 yards: the man who first seized it had several of his fingers bitten off; and the wound mortifying, he died. It afterwards fastened on the man's arm who shows it, and lacerated it so much, that the muscles are shrunk, and the hand and fingers distorted; the wound is not yet healed, and is thought to be incurable. It is said by some to have been described by naturalists under the name of the *Sea-dragon*." See Plate CCCCLXIX.

*SEA-Gage.* See *SEA-GAGE*.

*SEA-Hare.* See LAPLYSIA.

*SEA-Horse*, in ichthyology, the English name of the *Hippocampus*. See SYNGNATHUS.

*SEA-Lemon.* See DORIS.

*SEA-Lion.* See PHOCA.

*SEA-Mall, or SEA-Mew.* See LARUS.

*SEA-Man.* See MERMAID.

*SEA-Marks.* The erection of beacons, light-houses, and sea-marks, is a branch of the royal prerogative. By 8 Eliz. 13. the corporation of the Trinity-house are empowered to set up any beacons or sea-marks wherever they shall think them necessary; and if the owner of the land or any other person shall destroy them, or take down any steeple, tree, or other known sea-mark, he shall forfeit 100l. Sterling; or, in case of inability to pay it, he shall be *ipso facto* outlawed.

*SEA-Needle, Garfish.* See ESOX.

*SEA-Nettle.* See ANIMAL-Flower.

*SEA-Pie, or Oyster-Catcher.* See HÆMATOPUS.

*SEA-Plants*, are those vegetables that grow in salt-water within the shores of the sea. The old botanists divided these into three classes. 1. The first class, according to their arrangement, contained the *Alga*, the *fuci*, the *sea-mosses* or *confervæ*, and the different species of sponges. 2. The second contained substances of a hard texture, like stone or horn, which seem to have been of the same nature with what we call *zoophyta*, with this difference, that we refer sponges to this class and not to the first. The third class was the same with our *lithophyta*, comprehending *corals*, *mandrepora*, &c. It is now well known that the genera belonging to the

Sea

second and third of these classes, and even some referred to the first, are not vegetables, but animals, or the productions of animals. See CORALLINA, MADREPORA, SPONGIA. Sea-plants, then, properly speaking, belong to the class of cryptogamia, and the order of algæ; and, according to Bomare, are all comprehended under the genus of fucus. We may also add several species of the ulva and conferva and the fargazo. The fuci and marine ulvæ are immersed in the sea, are sessile, and without root. The marine confervæ are either sessile or floating. The fargazo grows beyond soundings.

As some species of the fucus, when dried and preserved, are externally beautiful, the curious, and especially those who prosecute the study of botany, must be anxious to know the best method of preserving them, without destroying their colour and beauty. The following method is recommended by M. Mauduyt. Take a sheet of paper, or rather of pasteboard, and cover it with varnish on both sides; and having rowed in a boat to the rock where the fucus abounds, plunge your varnished paper into the water, and, detaching the fucus, receive it upon the paper. Agitate the paper gently in the water, that the plant may be properly spread over it; and lift them up together softly out of the water: then fix down with pins the strong stalks, that they may not be displaced, and leave the plant lying upon the varnished paper to dry in the open air. When it is fully dry, the different parts will retain their position, and the plant may be preserved within the leaves of a book. If you wish to free it from the slime and salt which adheres to it, it may be washed gently in fresh water, after being removed from the rock on which it grew.

*SEA-Serpent*, a monstrous creature, said to inhabit the northern seas about Greenland and the coasts of Norway. The following marvellous account of this monster is given by Guthrie. "In 1756, one of them was shot by a master of a ship: its head resembled that of a horse; the mouth was large and black, as were the eyes, a white mane hanging from its neck: it floated on the surface of the water, and held its head at least two feet out of the sea: between the head and neck were seven or eight folds, which were very thick; and the length of this snake was more than 100 yards, some say fathoms. They have a remarkable aversion to the smell of castor; for which reason, ship, boat, and bark masters provide themselves with quantities of that drug, to prevent being overfet, the serpent's olfactory nerves being remarkably exquisite. The particularities related of this animal would be incredible, were they not attested upon oath. Egede, a very reputable author, says, that on the 6th day of July 1734, a large and frightful sea-monster raised itself so high out of the water, that its head reached above the main-top-mast of the ship; that it

had a long sharp snout, broad paws, and spouted water like a whale; that the body seemed to be covered with scales; the skin was uneven and wrinkled, and the lower part was formed like a snake. The body of this monster is said to be as thick as a hog's head; his skin is variegated like a tortoise shell: and his excrement, which floats upon the surface of the water, is corrosive." Notwithstanding the belief of Guthrie, and the testimony which he produces, we cannot help doubting of the existence of the sea-serpent. Its bulk is said to be so disproportionate to all the known animals of our globe, that it requires more than ordinary evidence to render it credible; but the evidence which is offered is so very feeble and unsatisfactory, that no man of sound judgment would think it sufficient to establish the truth of an extraordinary fact.

*SEA-Sickness*, a disorder incident to most persons on their first going to sea, occasioned by the agitation of the vessel. In voyages, sea-sickness, though it continues in general only for the first day or two, is extremely harassing to some people at intervals, especially on any increased motion of the vessel. Sometimes, by long continuance, it causes fever, headach, quick pulse, thirst, white tongue, and a total deprivation of the retention of the stomach; evils which are always difficult to remove, and frequently terminate only with the voyage.

This indisposition is considerably alleviated by a small tea spoonful of ether, taken now and then in a glass of water, and applying some of it to the temples and nostrils. The ancient writers recommend acid fruits, bread and vegetables soaked in vinegar, after the stomach has been cleansed by vomiting; but not to attempt to suppress the vomiting until that end was obtained. An old remedy for sea-sickness, and a very common one among sailors, is a draught or two of sea water; which, though a disgusting medicine at such a time, yet where the first passages are foul and loaded, generally produces the desired effect when the perturbation it occasions ceases.

*SEA-Star*. See ASTERIAS.

*SEA-Urchine*. See ECHINUS.

*SEA-Water*, the salt water of the sea. The principal salts contained in sea water are, 1st, Common marine or culinary salt, compounded of fossil alkali or soda and marine acid; 2dly, A salt formed by the union of the same acid with magnesian earth; and, lastly, A small quantity of selenite. The quantity of saline matter contained in a pint of sea-water, in the British seas, is, according to Neumann, about one ounce in each pint (A).

The saltness of this water is judged to arise from great multitudes both of mines and mountains of salt dispersed here and there in the depths of the sea. Dr Halley supposes that it is probable the greatest part of the sea-salt, and of all salt lakes, as the Caspian Sea, the Dead Sea, the Lake of Mexico, and the Titicaca in

(A) In Sir Torbern Bergman's analysis of sea-water taken up in the beginning of June 1776, about the latitude of the Canaries, from the depth of 60 fathoms, the solid contents of a pint of the water were,

	Grs.			
Of common salt	-	253 <sup>6</sup> / <sub>17</sub>	} or 5	3. 9. 10 <sup>2</sup> / <sub>17</sub> Grs.
Salited magnesia	-	69 <sup>1</sup> / <sub>17</sub>		
Gypsum	-	8 <sup>1</sup> / <sub>17</sub>		
Total	-	330 <sup>7</sup> / <sub>17</sub>		

Sea.

in Peru, is derived from the water of the rivers which they receive: and since this sort of lakes has no exit or discharge but by the exhalation of vapours, and also since these vapours are entirely fresh or devoid of such particles, it is certain that the saltness of the sea and of such lakes must from time to time increase; and therefore the saltness at this time must be greater than at any time heretofore. He further adds, that if, by experiments made in different ages, we could find the different quantity of salt which the same quantity of water (taken up in the same place, and in all other the same circumstances) would afford, it would be easy from thence, by rules of proportion, to find the age of the world very nearly, or the time wherein it has been acquiring its present saltness.

This opinion of Dr Halley is so improbable, that it is surprising so acute a philosopher could have adopted it. That fresh water rivers should in the course of many thousand years produce saltness in the sea, is quite incredible. If this were the case, every sea or great body of water which receives rivers must be salt, and must possess a degree of saltness in proportion to the quantity of water which the rivers discharge. But so far is this from being true, that the Palus Meotis and the great lakes in America do not contain salt but fresh water. It may indeed be objected, that the quantity of salt which the rivers carry along with them and deposit in the sea, must depend on the nature of the soil through which they flow, which may in some places contain no salt at all: and this may be the reason why the great lakes in America and the Palus Meotis are fresh. But to this opinion, which is merely hypothetical, there are insurmountable objections. It is a curious fact that the saltness of the sea is greatest under the line, and diminishes gradually as we advance to the poles: We must therefore suppose, if Dr Halley's theory be true, that the earth contains more salt in the tropical regions than in the temperate zones, and more in the temperate zones than in the frigid; and consequently that the rivers in these different regions contain a quantity of salt proportionable to their distance from the equator. This, however, must first be proved by experiment, and cannot be assumed as an established fact. But there is another circumstance that entirely destroys this theory. If we allow that the sea receives its saltness from the rivers, it must be equally salt or nearly so in every part of the earth. For, according to a simple and well known principle in chemistry, *when any substance is dissolved in water with the assistance of agitation, at whatever part of the water it is introduced, it will be equally diffused through the whole liquid.* Now though it were true that a greater quantity of salt were introduced into the sea under the line than towards the poles, from the constant agitation occasioned by the wind and tide, the salt must soon pervade the whole mass of water. To say that the superior degree of heat in the tropical regions may dissolve a greater quantity of salt, will not destroy our argument; for it is an established principle in chemistry, that cold water will dissolve nearly as great a quantity of salt as hot water can dissolve.

The saltness of the sea has also been ascribed to the solution of subterraneous mines of salt which is supposed to abound in the bottom of the sea and along its shores. But this hypothesis cannot be supported.

Sea.

If the sea were constantly dissolving salt, it would soon become saturated; for it cannot be said that it is deprived of any part of its salt by evaporation, since rain-water is fresh. If the sea were to become saturated, neither fishes nor vegetables could live in it. We must therefore despair of being able to account for the saltness of the sea by second causes; and must suppose that it has been salt from the creation. It is impossible indeed to suppose that the waters of the sea were at any period fresh since the formation of fishes and sea-plants: for as these will not live in water saturated with salt, neither will they live in water that is fresh; we therefore conclude that the saltness of the sea has been nearly the same in all ages. This is the simplest hypothesis of the three that has been mentioned. It explains best the various phenomena, and is involved in fewest difficulties. We shall, however, allow that there may be some exceptions; that the saltness of some seas, or of particular parts of the same sea, may be increased by mines of rock-salt dispersed near its shores.

With regard to the use of this salt property of sea-water, it is observed, that the saltness of the sea preserves its waters pure and sweet, which otherwise would corrupt and stink like a filthy lake, and consequently that none of the myriads of creatures which now live therein could then have a being. From thence also the sea-water becomes much heavier, and therefore ships of greater size and quantity may be used thereon. Salt-water also doth not freeze so soon as fresh-water, whence the seas are more free for navigation. We have a dissertation, by Dr Russel, concerning the medical uses of sea-water in diseases of the glands, &c. wherein the author premises some observations upon the nature of sea-water, considered as impregnated with particles of all the bodies it passes over, such as submarine plants, fish, salts, minerals, &c. and saturated with their several effluvia, to enrich it and keep it from putrefaction: whence this fluid is supposed to contract a soapiness; and the whole collection, being pervaded by the sulphureous steams passing through it, to constitute what we call *sea-water*; the confessed distinguishing characteristics of which are saltness, bitterness, nitrosity, and unctuousity: whence the author concludes, that it may be justly expected to contribute signally to the improvement of physic. The cases in which our author informs us we are to expect advantage from sea-water are, 1. In all recent obstructions of the glands of the intestines and mesentery. 2. All recent obstructions of the pulmonary glands, and those of the viscera, which frequently produce consumptions. 3. All recent glandular swellings of the neck, or other parts. 4. Recent tumors of the joints, if they are not suppurated, or become scirrhous or cancerous, and have not carious bones for their cause. 5. Recent defluxions upon the glands of the eyelids. 6. All desquandations of the skin, from an erysipelas to a lepra. 7. Diseases of the glands of the nose, with their usual companion a thickness of the lip. 8. Obstructions of the kidneys, where there is no inflammation, and the stone not large. 9. In recent obstructions of the liver, this method will be proper, where it prevents constipations of the belly, and assists other medicines directed in icterical cases. The same remedy is said to be of signal service in the bronchocele; and is likewise recommended for the prevention, of

Sea.

those bilious colics that so frequently affect our mariners.

*Preservation of Sea-Water from Putrefaction.* As it is sometimes necessary to preserve sea-water in casks for bathing and other purposes, it is of importance to know how to keep it from putrefaction. Many experiments were made to determine this point by Mr Henry, and are recorded in the first volume of the *Memoirs of the Literary and Philosophical Society of Manchester*. His first experiment we shall here present to our readers. "To one quart of sea-water were added two scruples of fresh quicklime; to another, half an ounce of common culinary salt; and a third was kept as a standard without any addition. The mouths of the bottles being loosely covered with paper, they were exposed to the action of the sun in some of the hottest weather in summer. In about a week the standard became very offensive; and the water, with the additional quantity of salt, did not continue sweet many hours longer; whereas that with lime continued many months without ever exhibiting the least marks of putridity." When he added a dram more of quicklime, the whole of the magnesia contained in the water was separated; and when a further addition was made, a lime-water was immediately formed. He therefore concluded, that two scruples of quicklime are sufficient to preserve a quart of sea-water. The proportions, however, may vary a little, according to the strength of the quicklime employed.

I  
Different  
methods of  
freshening  
sea-water.

*Freshening of Sea-Water.* The method of making sea-water fresh was long a desideratum in navigation. Many methods have been proposed for this purpose. Mr Appleby published an account of a process which he had instituted in the year 1734. He distilled sea-water with a quantity of *lapis infernalis* and calcined bones; but this process was soon laid aside, as it was not only difficult in itself, but rendered the water unpalatable. Dr Butler proposed soap-leys in place of Mr Appleby's ingredients; but the water was still liable to the same objection. Dr Stephen Hales recommended powdered chalk; but his method was expensive, and did not improve the taste of the water. Dr Lind of Portsmouth distilled sea-water without any ingredients; but as the experiment he made was performed in a vessel containing only two quarts, with a glass receiver in his study, nothing conclusive can be drawn from it for the use of sailors. At length Dr Irving brought the process to a very high degree of simplicity and perfection, by which the water is obtained pure, without much expence of fuel or a complicated apparatus. For this valuable discovery he received a reward of L. 5000. The advantages of his method remain to be stated, which may be reduced to the following: 1. The abolishing all stills, still-heads, worm-pipes, and their tubes, which occupy so much space as to render them totally incompatible with the necessary business of the ship; and using in the room of these the ship's kettle or boiler, to the top whereof may occasionally be applied a simple tube, which can be easily made on board a vessel at sea, of iron plate, stove funnel, or tin sheet; so that no situation can prevent a ship from being completely supplied with the means of distilling sea-water. 2. In consequence of the principles of distillation being fully ascertained, the contrivance of the simplest means

2  
Dr Irving's

of obtaining the greatest quantity of distilled water, by making the tube sufficiently large to receive the whole column of vapour, and placing it nearly in a horizontal direction, to prevent any compression of the fluid, which takes place so much with the common worm. 3. The adopting of the simplest and most efficacious means of condensing vapour; for nothing more is required in the distillation but keeping the surface of the tube always wet, which is done by having some sea-water at hand, and a person to dip a mop or swab into this water, and pass it along the upper surface of the tube. By this operation the vapour contained in the tube will be entirely condensed with the greatest rapidity imaginable; for by the application of the wet mop thin sheets of water are uniformly spread, and mechanically pressed upon the surface of the hot tube; which being converted into vapour make way for a succession of fresh sheets; and thus, both by the evaporation and close contact of the cold water constantly repeated, the heat is carried off more effectually than by any other method yet known. 4. The carrying on the distillation without any addition, a correct chemical analysis of sea-water having evinced the futility of mixing ingredients with it, either to prevent an acid from rising with the vapour, or to destroy any bituminous oil supposed to exist in sea-water, and to contaminate the distilled water, giving it that fiery unpalatable taste inseparable from the former processes. 5. The ascertaining the proper quantity of sea-water that ought to be distilled, whereby the fresh water is prevented from contracting a noxious impregnation of metallic salts, and the vessel from being corroded and otherwise damaged by the salts caking on the bottom of it. 6. The producing a quantity of sweet and wholesome water, perfectly agreeable to the taste, and sufficient for all the purposes of shipping. 7. The taking advantage of the dressing the ship's provisions, so as to distil a very considerable quantity of water from the vapour, which would otherwise be lost, without any addition of fuel. To sum up the merits of this method in a few words: The use of a simple tube, of the most easy construction, applicable to any ship's kettle. The rejecting all ingredients; ascertaining the proportion of water to be distilled, with every advantage of quality, saving of fuel, and preservation of boilers. The obtaining fresh water, wholesome, palatable, and in sufficient quantities. Taking advantage of the vapour which ascends in the kettle while the ship's provisions are boiling. All these advantages are obtained by the above mentioned simple addition to the common ship's kettles. But Dr Irving proposes to introduce two further improvements. The first is a hearth, or stove, so constructed that the fire which is kept up the whole day for the common business of the ship serves likewise for distillation; whereby a sufficient quantity of water for all the economical purposes of the ship may be obtained, with a very inconsiderable addition to the expence of fuel. The other improvement is that of substituting, even in the largest ships, cast-iron boilers, of a new construction, in the place of coppers.

As soon as sea-water is put into the boiler, the tube is to be fitted either into the top or lid, round which, if necessary, a bit of wet linen may be applied, to make it fit close to the mouth of the vessel; there will be no occasion for luting, as the tube acts like a funnel in carrying

Sea.

3  
Directions  
for distilling  
sea-water.

ving off the vapour. When the water begins to boil, the vapour should be allowed to pass freely for a minute, which will effectually clean the tube and upper part of the boiler. The tube is afterwards to be kept constantly wet, by passing a mop or swab, dipped in sea water, along its upper surface. The waste water running from the mop may be carried off by means of a board made like a spout, and placed beneath the tube. The distillation may be continued till three-fourths of the water be drawn off, and no further. This may be ascertained either by a gauge-rod put into the boiler, or by measuring the water distilled. The brine is then to be let out. Water may be distilled in the same manner while the provisions are boiling. When the tube is made on shore, the best substance for the purpose is thin copper well tinned, this being more durable in long voyages than tin-plates. Instead of mopping, the tube, if required, may have a case made also of copper, so much larger in diameter as to admit a thin sheet of water to circulate between them by means of a spiral copper thread, with a pipe of an inch diameter at each end of the case; the lower for receiving cold water, and the upper for carrying it off when heated.

When only a very small portion of room can be conveniently allowed for distillation, the machine (n<sup>o</sup> 2.), which is only 27 inches long, may be substituted, as was done in this voyage. The principal intention of this machine, however, is to distil rum and other liquors; for which purpose it has been employed with extraordinary success, in preventing an *empyreuma*, or fiery taste.

Figure 1. represents in perspective a section of the two boilers taken out of the frame. In the back part at D, E, are seen openings for the cocks. On the top is a distilling tube A, B, C, five inches diameter at A, and decreasing in size to three inches at C; the length from B to C is five feet. Near C is a ring to prevent the water which is applied to the surface from mixing with the distilled water. In the inside of the tube, below B, is a small lip or ledging, to hinder the distilled water from returning into the boiler by the rolling of the ship.

In figure 2. A, B, C, D, represent a vertical section of a copper box, 27 inches long, seven inches wide, and 11 in height, tinned on the inside. In the bottom F is an aperture about six inches in diameter, having a ring to fit on the still or boiler. The dotted lines which run nearly horizontal, are vessels of thin copper, tinned on the outside, two feet long, seven inches wide, and three quarters of an inch deep. At G is a tunnel to receive cold water, which is conveyed into the vessels by communicating pipes, contrived in such a manner as to form a complete and quick circulation of the water through their whole extent. When the water is become hot by the action of the steam, it is discharged by the horizontal pipe at A. E is a pipe from which the distilled water or spirits run, and is bent in such a form that the liquor running from it acts as a valve, and hinders any steam from escaping that way. On the top of the box, at H, is a safety-valve, which prevents any danger from a great accumulation of vapour not condensed for want of a proper supply of cold water.

We shall now mention a different method, discovered by the Chevalier Lergna, by congelation of sea-water: Sea-water requires a very great degree of cold in order to become ice. Our author found that a freezing mix-

ture, made by mixing three parts of pounded ice with two parts of common salt, was quite sufficient to freeze it. The cold produced by this mixture is equal to about 4<sup>o</sup> below nought of Fahrenheit's thermometer.

A quantity of sea-water is never entirely congelated, a portion of it always remaining fluid; and, what is very remarkable, this fluid part is incomparably more full of salt and more nauseous than the rest: hence, if this be separated from the congelated part, the latter on being melted will be found to contain much less salt than it did before congelation. This we shall call *the water of the first purification*.

If the water of the first purification be again congelated, a part of it will remain fluid as in the first operation. This fluid portion will contain a greater proportion of salt than the rest, which is of course more pure, and, being melted, forms the water of the second purification. Thus, by repeatedly freezing the same sea-water, and separating the fluid from the congelated part in every operation, it is at last perfectly purified, so as to be entirely divested of salt, and as fit for drink and other purposes as the purest water that is used.

At first the sea-water, in order to be congelated, requires a very great degree of cold, as mentioned above, the ice formed in it consists rather of scales or filaments than of a compact body, and the quantity of the fluid parts bears a considerable proportion to the quantity of ice. But as the water, by undergoing the successive congelations, becomes more and more pure, so it becomes capable of being congelated by a smaller and smaller degree of cold; the ice is at the same time more compact, and in greater quantity; the fluid part at last becoming very inconsiderable.

*SEA-Weed*, or *Alga Marina*, is commonly used as a manure on the sea-coast, where it can be procured in abundance. The best sort grows on rocks, and is that from which kelp is made. The next to this is called the *peasy sea-weed*; and the worst is that with a long stalk. In the neighbourhood of Berwick, the farmers mix it with stable-dung and earth, and thus obtain a great quantity of excellent manure. Sea-weed is found also to be a very fit manure for gardens, as it not only enriches them, but destroys the vermin by which they are usually infested.

*SEA-Wolf*. See ANARRHICAS.

*Saltness of the SEA*. See *SEA-Water*.

*South SEA*. See *PACIFIC Ocean*, and *SOUTH Sea*.

*SEAL*, a puncheon, piece of metal, or other matter, usually either round or oval; whereon are engraven the arms, device, &c. of some prince, state, community, magistrate, or private person, often with a legend or inscription; the impression whereof in wax serves to make acts, instruments, &c. authentic.

The use of seals, as a mark of authenticity to letters and other instruments in writing, is extremely ancient. We read of it among the Jews and Persians in the earliest and most sacred records of history. And in the book of Jeremiah there is a very remarkable instance, not only of an attestation by seal, but also of the other usual formalities attending a Jewish purchase. In the civil law also, seals were the evidence of truth, and were required, on the part of the witnesses at least, at the attestation of every testament. But in the times of our Saxon ancestors, they were not much in use in England. For though Sir Edward Coke relies on an instance

Seal.

instance of king Edwyn's making use of a seal about 100 years before the conquest, yet it does not follow that this was the usage among the whole nation: and perhaps the charter he mentions may be of doubtful authority, from this very circumstance of its being sealed; since we are assured by all our ancient historians that sealing was not then in common use. The method of the Saxons was, for such as could write to subscribe their names, and, whether they could write or not, to affix the sign of the cross; which custom our illiterate vulgar do for the most part to this day keep up, by signing a cross for their mark when unable to write their names. And indeed this inability to write, and therefore making a cross in its stead, is honestly avowed by Cædwalla, a Saxon king, at the end of one of his charters. In like manner, and for the same unfurmountable reason, the Normans, a brave but illiterate nation, at their first settlement in France used the practice of sealing only, without writing their names; which custom continued when learning made its way among them, though the reason for doing it had ceased; and hence the charter of Edward the Confessor to Westminster-abbey, himself being brought up in Normandy, was witnessed only by his seal, and is generally thought to be the oldest sealed charter of any authenticity in England. At the Conquest, the Norman lords brought over into this kingdom their own fashions; and introduced waxen seals only, instead of the English method of writing their names, and signing with the sign of the cross. The impressions of these seals were sometimes a knight on horseback, sometimes other devices; but coats of arms were not introduced into seals, nor indeed used at all till about the reign of Richard I. who brought them from the croisade in the Holy Land, where they were first invented and painted on the shields of the knights, to distinguish the variety of persons of every Christian nation who resorted thither, and who could not, when clad in complete steel, be otherwise known or ascertained.

This neglect of signing, and resting only upon the authenticity of seals, remained very long among us; for it was held in all our books, that sealing alone was sufficient to authenticate a deed: and so the common form of attesting deeds, "sealed and delivered," continues to

this day; notwithstanding the statute 29 Car. II. c. 3. revives the Saxon custom, and expressly directs the signing in all grants of lands and many other species of deeds: in which, therefore, signing seems to be now as necessary as sealing, though it hath been sometimes held that the one includes the other.

The king's *great seal* is that whereby all patents, commissions, warrants, &c. coming down from the king are sealed; the keeping whereof is in the hands of the lord chancellor. The king's *privy-seal* is a seal that is usually first set to grants that are to pass the great seal.

SEAL. See *KEEPER of the Privy-Seal*.

SEAL is also used for the wax or lead, and the impression thereon affixed to the thing sealed.

An amalgam of mercury with gold, reduced to the consistence of butter, by straining off part of the mercury through leather, has been recommended as a proper material for taking off the impression of seals in wax. In this state, the compound scarcely contains one part of mercury to two of gold; yet is of a silver whiteness, as if there was none of the precious metal in it. In this state it grows soft on being warmed or worked between the fingers; and is therefore proper for the purpose above-mentioned, but is not superior to some amalgams made with the inferior metals, as is well known to some impostors, who have sold for this use amalgams of the base metals as curious preparations of gold.

SEAL, in zoology. See *PHOCCA*.

SEALER, an officer in chancery appointed by the lord chancellor or keeper of the great seal to seal the writs and instruments there made in his presence.

SEALING, in architecture, the fixing a piece of wood or iron in a wall with plaster, mortar, cement, lead, or other solid binding. For staples, hinges, and joints, plaster is very proper.

SEALING-Wax. See *WAX*.

SEAM, or *SEME* of coin, is a measure of eight bushels.

*SEAM of Glass*, the quantity of 120 pounds, or 24 stones, each five pounds weight. The seam of wood is an horse-load.

SEAM, in mines, the same with a vein or stratum of metal.

## S E A M A N S H I P.

Definition.

**B**Y this word we express that noble art, or, more purely, the qualifications which enable a man to exercise the noble art of working a ship. A *SEAMAN*, in the language of the profession, is not merely a mariner or labourer on board a ship, but a man who understands the structure of this wonderful machine, and every subordinate part of its mechanism, so as to enable him to employ it to the best advantage for pushing her forward in a particular direction, and for avoiding the numberless dangers to which she is exposed by the violence of the winds and waves. He also knows what courses can be held by the ship, according to the wind that blows, and what cannot, and which of these is most conducive to her progress in her intended voyage: and he must be able to perform every part of the

necessary operation with his own hands. As the seaman expresses it, he must be able "to hand, reef, and steer."

We are justified in calling it a *noble art*, not only by its importance, which it is quite needless to amplify or embellish, but by its immense extent and difficulty, and the prodigious number and variety of principles on which it is founded—all of which must be possessed in such a manner that they shall offer themselves without reflection in an instant, otherwise the pretended seaman is but a lubber, and cannot be trusted on his watch.

The art is practised by persons without what we call *education*, and in the humbler walks of life, and therefore it suffers in the estimation of the careless spectator. It is thought little of, because little attention is

paid

paid to it. But if multiplicity, variety, and intricacy of principles, and a systematic knowledge of these principles, intitle any art to the appellation of *scientific* and *liberal*, seamanship claims these epithets in an eminent degree. We are amused with the pedantry of the seaman, which appears in his whole language. Indeed it is the only pedantry that amuses. A scholar, a soldier, a lawyer, nay, even the elegant courtier, would disgust us, were he to make the thousandth part of the allusions to his profession that is well received from the jolly seaman; and we do the seaman no more than justice. His profession *must* engross his whole mind, otherwise he can never learn it. He possesses a prodigious deal of knowledge; but the honest tar cannot tell what he knows, or rather what he feels, for his science is really at his fingers ends. We can say with confidence, that if a person of education, versed in mechanics, and acquainted with the structure of a ship, were to observe with attention the movements which are made on board a first or second rate ship of war during a shifting storm, under the direction of an intelligent officer, he would be rapt in admiration.

What a pity it is that an art so important, so difficult, and so intimately connected with the invariable laws of mechanical nature, should be so held by its possessors, that it cannot improve, but must die with each individual. Having no advantages of previous education, they cannot arrange their thoughts; they can hardly be said to think. They can far less express or communicate to others the intuitive knowledge which they possess; and their art, acquire<sup>d</sup> by habit alone, is little different from an instinct. We are as little intitled to expect improvement here as in the architecture of the bee or the beaver. The species (pardon the allusion ye generous hearts of oak) cannot improve. Yet a ship is a machine. We know the forces which act on it, and we know the results of its construction—all these are as fixed as the laws of motion. What hinders this to be reduced to a set of practical maxims, as well founded and as logically deduced as the working of a steam engine or a cotton mill. The toker or the spinner acts only with his hands, and may "whistle as he works for want of thought;" but the mechanist, the engineer, thinks for him, improves his machine, and directs him to a better practice. May not the rough seaman look for the same assistance; and may not the ingenious speculatist in his closet unravel the intricate thread of mechanism which connects all the manual operations with the unchangeable laws of nature, and both furnish the seaman with a better machine and direct him to a more dexterous use of it?

We cannot help thinking that much may be done; nay, we may say that much has been done. We think highly of the progressive labours of Renaud, Pitot, Bouguer, Du Hanel, Groignard, Bernoulli, Euler, Romme, and others; and are both surpris'd and sorry that Britain has contributed so little in these attempts. Gordon is the only one of our countrymen who has given a professedly scientific treatise on a small branch of the subject. The government of France has always been strongly impressed with the notion of great improvements being attainable by systematic study of this art; and we are indebted to the endeavours of that ingenious nation for any thing of practical importance that has

been obtained. M. Bouguer was professor of hydrology at one of the marine academies of France, and was enjoined, as part of his duty, to compose dissertations both on the construction and the working of ships. His *Traité du Navire*, and his *Manœvre des Vaisseaux*, are undoubtedly very valuable performances: So are those of Euler and Bernoulli, considered as mathematical dissertations, and they are wonderful works of genius, considered as the productions of persons who hardly ever saw a ship, and were totally unacquainted with the profession of a seaman. In this respect Bouguer had great superiority, having always lived at a sea-port, and having made many very long voyages. His treatises therefore are infinitely better accommodated to the demands of the seaman, and more directly instructive; but still the author is more a mathematician than an artist, and his performance is intelligible only to mathematicians. It is true, the academical education of the young gentlemen of the French navy is such, that a great number of them may acquire the preparatory knowledge that is necessary; and we are well informed that, in this respect, the officers of the British navy are greatly inferior to them.

But this very circumstance has furnished to many persons an argument against the utility of those performances. It is said that, "notwithstanding this superior mathematical education, and the possession of those boasted performances of M. Bouguer, the French are greatly inferior, in point of seamanship, to our countrymen, who have not a page in their language to instruct them, and who could not peruse it if they had it." Nay, so little do the French themselves seem sensible of the advantage of these publications, that no person among them has attempted to make a familiar abridgement of them, written in a way fitted to attract attention; and they still remain neglected in their original abstruse and uninteresting form.

We wish that we could give a satisfactory answer to this observation. It is just, and it is important. These very ingenious and learned dissertations are by no means so useful as we should expect. They are large books, and appear to contain much; and as their plan is logical, it seems to occupy the whole subject, and therefore to have done almost all that can be done. But, alas! they have only opened the subject, and the study is yet in its infancy. The whole science of the art must proceed on the knowledge of the impulsions of the wind and water. These are the forces which act on the machine; and its motions, which are the ultimatum of our research, whether as an end to be obtained or as a thing to be prevented, must depend on these forces. Now it is with respect to this fundamental point that we are as yet almost totally in the dark. And; in the performances of M. Bouguer, as also in those of the other authors we have named, the theory of these forces, by which their quantity and the direction of their action are ascertained, is altogether erroneous; and its results deviate so enormously from what is observed in the motions of a ship, that the person who should direct the operations on shipboard, in conformity to the maxims deducible from M. Bouguer's propositions, would be baffled in most of his attempts, and be in danger of losing the ship. The whole proceeds on the supposed truth of that theory which states the impulse of a fluid

5  
Argument  
against the  
utility of  
their perform-  
ances.

6  
Which are  
confeſſedly  
erroneous  
in their  
fundamen-  
tal princi-  
ples;

to be in the proportion of the square of the sine of the angle of incidence; and that its action on any small portion, such as a square foot of the sails or hull, is the same as if that portion were detached from the rest, and were exposed, single and alone, to the wind or water in the same angle. But we have shown, in the article *RESISTANCE of Fluids*, both from the theory and experience, that both of these principles are erroneous, and this to a very great degree, in cases which occur most frequently in practice, that is, in the small angles of inclination. When the wind falls nearly perpendicular on the sails, theory is not very erroneous; but in these cases, the circumstances of the ship's situation are generally such that the practice is easy, occurring almost without thought; and in this case, too, even considerable deviations from the very best practice are of no great moment. The interesting cases, where the intended movement requires or depends upon very oblique actions of the wind on the sails, and its practicability or impracticability depends on a very small variation of this obliquity; a mistake of the force, either as to intensity or direction, produces a mighty effect on the resulting motion. This is the case in sailing to windward; the most important of all the general problems of seamanship. The trim of the sails, and the course of the ship, so as to gain most on the wind, are very nice things; that is, they are confined within very narrow limits, and a small mistake produces a very considerable effect. The same thing obtains in many of the nice problems of tacking, box-hauling, wearing after lying-to in a storm, &c.

The error in the second assertion of the theory is still greater, and the action on one part of the sail or hull is so greatly modified by its action on another adjoining part, that a stay-sail is often seen hanging like a loose rag, altho' there is nothing between it and the wind; and this merely because a great sail in its neighbourhood sends off a lateral stream of wind, which completely hinders the wind from getting at it. Till the theory of the action of fluids be established, therefore, we cannot tell what are the forces which are acting on every point of the sail and hull: Therefore we cannot tell either the mean intensity or direction of the whole force which acts on any particular sail, nor the intensity and mean direction of the resistance to the hull; circumstances absolutely necessary for enabling us to say what will be their energy in producing a rotation round any particular axis. In like manner, we cannot, by such a computation, find the spontaneous axis of conversion (see *ROTATION*), or the velocity of such conversion. In short, we cannot pronounce with tolerable confidence *a priori* what will be the motions in any case, or what dispositions of the sails will produce the movement we wish to perform. The experienced seaman learns by habit the general effects of every disposition of the sails; and though his knowledge is far from being accurate, it seldom leads him into any very blundering operation. Perhaps he seldom makes the best adjustment possible, but seldom still does he deviate very far from it; and in the most general and important problems, such as working to windward, the result of much experience and many corrections has settled a trim of the sails, which is certainly not far from the truth, but (it must be acknowledged) deviates widely and uniformly from

the theories of the mathematician's closet. The honest tar, therefore, must be indulged in his joke on the useless labours of the mathematician, who can neither haul, reef, nor steer.

After this account of the theoretical performances in the art of seamanship, and what we have said in another place on the small hopes we entertain of seeing a perfect theory of the impulse of fluids, it will not be expected that we enter very minutely on the subject in this place; nor is it our intention. But let it be observed, that the theory is defective in one point only; and although this is a most important point, and the errors in it destroy the conclusions of the chief propositions, the reasonings remain in full force, and the *modus operandi* is precisely such as is stated in the theory. The principles of the art are therefore to be found in these treatises; but false inferences have been drawn, by computing from erroneous quantities. The rules and the practice of the computation, however, are still beyond controversy: Nay, since the process of investigation is legitimate, we may make use of it in order to discover the very circumstance in which we are at present mistaken; for by converting the proposition, instead of finding the motions by means of the supposed forces, combined with the known mechanism, we may discover the forces by means of this mechanism and the observed motions.

We shall therefore in this place give a very general view of the movements of a ship under sail, showing how they are produced and modified by the action of the wind on her sails, the water on her rudder and on her bows. We shall not attempt a precise determination of any of these movements; but we shall say enough to enable the curious landman to understand how this mighty machine is managed amidst the fury of the winds and waves: and, what is more to our wish, we hope to enable the uninstructed but thinking seaman to generalise that knowledge which he possesses; to class his ideas, and give them a sort of rational system; and even to improve his practice, by making him sensible of the immediate operation of every thing he does, and in what manner it contributes to produce the movement which he has in view.

A ship may be considered at present as a mass of inert matter in free space, at liberty to move in every direction, according to the forces which impel or resist her: and when she is in actual motion, in the direction of her course, we may still consider her as at rest in absolute space, but exposed to the impulse of a current of water moving equally fast in the opposite direction; for in both cases the pressure of the water on her bows is the same; and we know that it is possible, and frequently happens in currents, that the impulse of the wind on her sails, and that of the water on her bows, balance each other so precisely, that she not only does not stir from the place, but also remains steadily in the same position, with her head directed to the same point of the compass. This state of things is easily conceived by any person accustomed to consider mechanical subjects, and every seaman of experience has observed it. It is of importance to consider it in this point of view, because it gives us the most familiar notion of the manner in which these forces of the wind and water are set in opposition, and made to balance or not to balance each



each other by the intervention of the ship, in the same manner as the goods and the weights balance each other in the scales by the intervention of a beam or steelyard.

When a ship proceeds steadily in her course, without changing her rate of sailing, or varying the direction of her head, we must in the first place conceive the accumulated impulses of the wind on all her sails as precisely equal and directly opposite to the impulse of the water on her bows. In the next place, because the ship does not change the direction of her keel, she resembles the balanced steelyard, in which the energies of the two weights, which tend to produce rotations in opposite directions, and thus to change the position of the beam, mutually balance each other round the fulcrum; so the energies of the actions of the wind on the different sails balance the energies of the water on the different parts of the hull.

The seaman has two principal tasks to perform. The first is to keep the ship steadily in that course which will bring her farthest on in the line of her intended voyage. This is frequently very different from that line, and the choice of the best course is sometimes a matter of considerable difficulty. It is sometimes possible to shape the course precisely along the line of the voyage; and yet the intelligent seaman knows that he will arrive sooner, or with greater safety, at his port, by taking a different course; because he will gain more by increasing his speed than he loses by increasing the distance. Some principle must direct him in the selection of this course. This we must attempt to lay before the reader.

Having chosen such a course as he thinks most advantageous, he must set such a quantity of sail as the strength of the wind will allow him to carry with safety and effect, and must trim the sails properly, or so adjust their positions to the direction of the wind, that they may have the greatest possible tendency to impel the ship in the line of her course, and to keep her steadily in that direction.

His other task is to produce any deviations which he sees proper from the present course of the ship; and to produce these in the most certain, the safest, and the most expeditious manner. It is chiefly in this movement that the mechanical nature of a ship comes into view, and it is here that the superior address and resource of an expert seaman is to be perceived.

Under the article SAILING some notice has been taken of the first task of the seaman, and it was there shown how a ship, after having taken up her anchor and fitted her sails, accelerates her motion, by degrees which continually diminish, till the increasing resistance of the water becomes precisely equal to the diminished impulse of the wind, and then the motion continues uniformly the same so long as the wind continues to blow with the same force and in the same direction.

It is perfectly consonant to experience that the impulse of fluids is in the duplicate ratio of the relative velocity. Let it be supposed that when water moves one foot per second its perpendicular pressure or impulse on a square foot is  $m$  pounds. Then, if it be moving with the velocity  $V$  estimated in feet per second, its perpendicular impulse on a surface  $S$ , containing any number of square feet, must be  $mSV^2$ .

In like manner, the impulse of air on the same sur-

face may be represented by  $nSV^2$ ; and the proportion of the impulse of these two fluids will be that of  $m$  to  $n$ . We may express this by the ratio of  $q$  to  $r$ , making

$$\frac{m}{n} = q.$$

M. Bouguer's computations and tables are on the supposition that the impulse of sea-water moving one foot per second is 23 ounces on a square foot, and that the impulse of the wind is the same when it blows at the rate of 24 feet per second. These measures are all French. They by no means agree with the experiments of others; and what we have already said, when treating of the *RESISTANCE of Fluids*, is enough to show us that nothing like precise measures can be expected. It was shown as the result of a rational investigation, and confirmed by the experiments of Buat and others, that the impulsions and resistances at the same surface, with the same obliquity of incidence and the same velocity of motion, are different according to the form and situation of the adjoining parts. Thus the total resistance of a thin board is greater than that of a long prism, having this board for its front or bow, &c.

We are greatly at a loss what to give as absolute measures of these impulsions.

1. With respect to water. The experiments of the French academy on a prism two feet broad and deep and four feet long, indicate a resistance of 0,973 pounds avoirdupois to a square foot, moving with the velocity of one foot per second at the surface of still water.

Mr Buat's experiments on a square foot wholly immersed in a stream were as follow:

A square foot as a thin plate	-	1,81 pounds.
Ditto as the front of a box one foot long	-	1,42
Ditto as the front of a box three feet long	-	1,29
The resistance of sea-water is about	$\frac{1}{17}$	greater.

2. With respect to air, the varieties are as great.—The resistance of a square foot to air moving with the velocity of one foot per second appears from Mr. Robins's experiments on 16 square inches to be on a square foot

Chevalier Borda's on 16 inches	0,001596 pounds,
----- on 81 inches	0,002542
Mr Rouse's on large surfaces	0,002291

Precise measures are not to be expected, nor are they necessary in this inquiry. Here we are chiefly interested in their proportions, as they may be varied by their mode of action in the different circumstances of obliquity and velocity.

We begin by recurring to the fundamental proposition concerning the impulse of fluids, viz. that the absolute pressure is always in a direction perpendicular to the impelled surface, whatever may be the direction of the stream of fluid. We must therefore illustrate the doctrine, by always supposing a flat surface of sail stretched on a yard, which can be braced about in any direction, and giving this sail such a position and such an extent of surface that the impulse on it may be the same both as to direction and intensity with that on the real sails. Thus the consideration is greatly simplified. The direction of the impulse is therefore perpendicular to the yard. Its intensity depends on the velocity

To Impulse of the wind on the sails opposite to that of the water on the bows.

11 Skill of the seaman displayed in shaping his course.

12 Impulse of the water computed in ounces on the square foot.

13 Direct impulse on the sail perpendicular to the yard.

locity with which the wind meets the sail, and the obliquity of its stroke. We shall adopt the constructions founded on the common doctrine, that the impulse is as the square of the sine of the inclination, because they are simple; whereas, if we were to introduce the values of the oblique impulses, such as they have been observed in the excellent experiments of the Academy of Paris, the constructions would be complicated in the extreme, and we could hardly draw any consequences which would be intelligible to any but expert mathematicians. The conclusions will be erroneous, not in kind but in quantity only; and we shall point out the necessary corrections, so that the final results will be found not very different from real observation.

14  
A ship compared to an oblong box,

If a ship were a round cylindrical body like a flat tub, floating on its bottom, and fitted with a mast and sail in the centre, she would always sail in a direction perpendicular to the yard. This is evident. But she is an oblong body, and may be compared to a chest, whose length greatly exceeds its breadth. She is so shaped, that a moderate force will push her through the water with the head or stern foremost; but it requires a very great force to push her sidewise with the same velocity. A fine sailing ship of war will require about 12 times as much force to push her sidewise as to push her head foremost. In this respect therefore she will very much resemble a chest whose length is 12 times its breadth; and whatever be the proportion of these resistances in different ships, we may always substitute a box which shall have the same resistances headwise and sidewise.

Let EFGH (fig. 1.) be the horizontal section of such a box, and AB its middle line, and C its centre. In whatever direction this box may chance to move, the direction of the whole resistance on its two sides will pass through C. For as the whole stream has one inclination to the side, EF, the equivalent of the equal impulses on every part will be in a line perpendicular to the middle of EF. For the same reason, it will be in a line perpendicular to the middle of FG. These perpendiculars must cross in C. Suppose a mast erected at C, and YC<sub>y</sub> to be a yard hoisted on it carrying a sail. Let the yard be first conceived as braced right athwart at right angles to the keel, as represented by Y'y. Then, whatever be the direction of the wind abast this sail, it will impel the vessel in the direction CB. But if the sail has the oblique position Yy, the impulse will be in the direction CD perpendicular to CY, and will both push the vessel ahead and sidewise: For the impulse CD is equivalent to the two impulses CK and CI (the sides of a rectangle of which CD is the diagonal). The force CI pushes the vessel ahead, and CK pushes her sidewise. She must therefore take some intermediate direction *ab*, such that the resistance of the water to the plane FG is to its resistance to the plane EF as CI to CK.

15  
Makes leeway when not sailing directly before the wind.

The angle *b* CB between the real course and the direction of the head is called the **LEEWAY**; and in the course of this dissertation we shall express it by the symbol *x*. It evidently depends on the shape of the vessel and on the position of the yard. An accurate knowledge of the quantity of leeway, corresponding to different circumstances: obliquity of impulse, extent of surface, &c. is of the utmost importance in the practice

of navigation; and even an approximation is valuable. The subject is so very difficult that this must content us for the present.

Let V be the velocity of the ship in the direction <sup>How to find the quantity of leeway,</sup> CB, and let the surfaces FG and FE be called A' and B'. Then the resistance to the lateral motion is  $mV^2 \times B' \times \text{fine}^2$ , *b* CB, and that to the direct motion is  $mV^2 \times A' \times \text{fine}^2$ , *b* CK, or  $mV^2 \times A' \times \text{cof.}^2$  *b* CB. Therefore these resistances are in the proportion of  $B' \times \text{fine}^2$ , *v* to  $A' \times \text{cof.}^2$ , *x* (representing the angle of leeway *b* CB by the symbol *x*).

Therefore we have  $CI : CK$ , or  $CI : ID = A' \times \text{cof.}^2$  *x* :  $B' \times \text{fine}^2$  *x*, =  $A' : B' \times \frac{\text{fine}^2 \times x}{\text{cof.}^2 \times x} = A : B \cdot \text{tan-}$   
gent <sup>2</sup> *x*.

Let the angle YCB, to which the yard is braced np, be called the **TRIM** of the sails, and expressed by the symbol *b*. This is the complement of the angle DCI. Now  $CI : ID = \text{rad.} : \text{tan. DCI}$ , =  $1 : \text{tan. DCI}$ , =  $1 : \text{cotan. } b$ . Therefore we have finally  $1 : \text{cotan. } b = A' : B' \cdot \text{tan.}^2$  *x*, and  $A' \cdot \text{cotan. } b = B' \cdot \text{tan-}$   
gent <sup>2</sup> *x*, and  $\text{tan.}^2$  *x* =  $\frac{A}{B} \cdot \text{cot. } b$ . This equation evidently ascertains the mutual relation between the trim of the sails and the leeway in every case where we can tell the proportion between the resistances to the direct and broadside motions of the ship, and where this proportion does not change by the obliquity of the course. Thus, suppose the yard braced up to an angle of 30° with the keel. Then  $\text{cotan. } 30^\circ = 1,732$  very nearly. Suppose also that the resistance sidewise is 12 times greater than the resistance headwise. This gives  $A' = 1$  and  $B' = 12$ . Therefore  $1,732 = 12 \times \text{tan-}$   
gent <sup>2</sup> *x*, and  $\text{tangent}^2$  *x* =  $\frac{1,732}{12}$ , = 0,14434, and  $\text{tan. } x = 0,3799$ , and  $x = 20^\circ 48'$ , very nearly two points of leeway.

This computation, or rather the equation which gives room for it, supposes the resistances proportional to the squares of the sines of incidence. The experiments of the Academy of Paris, of which an abstract is given in the article *RESISTANCE of Fluids*, show that this supposition is not far from the truth when the angle of incidence is great. In this present case the angle of incidence on the front FG is about 70°, and the experiments just now mentioned show that the real resistances exceed the theoretical ones only  $\frac{1}{186}$ . But the angle of incidence on EF is only 20° 48'. Experiment shows that in this inclination the resistance is almost quadruple of the theoretical resistances. Therefore the lateral resistance is assumed much too small in the present instance. Therefore a much smaller leeway will suffice for producing a lateral resistance which will balance the lateral impulse CK, arising from the obliquity of the sail, viz. 30°. The matter of fact is, that a pretty good sailing ship, with her sails braced to this angle at a medium, will not make above five or six degrees leeway in smooth water and easy weather; and yet in this situation the hull and rigging present a very great surface to the wind, in the most improper positions, so as to have a very great effect in increasing her leeway. And if we compute the resistances for this leeway of six degrees by the actual experiments of the French Academy on that angle, we shall find the result not far

from the truth; that is, the direct and lateral resistances will be nearly in the proportion of CI to ID.

It results from this view of the matter, that the leeway is in general much smaller than what the usual theory assigns.

17  
Which depends on the trim of the sails.

We also see, that according to whatever law the resistances change by a change of inclination, the leeway remains the same while the trim of the sails is the same. The leeway depends only on the direction of the impulse of the wind; and this depends solely on the position of the sails with respect to the keel, whatever may be the direction of the wind. This is a very important observation, and will be frequently referred to in the progress of the present investigation. Note, however, that we are here considering only the action on the sails, and on the same sails. We are not considering the action of the wind on the hull and rigging. This may be very considerable; and it is always in a lee direction, and augments the leeway; and its influence must be so much the more sensible as it bears a greater proportion to the impulse on the sails. A ship under courses, or close-reefed topsails and courses, must make more leeway than when under all her canvas trimmed to the same angle. But to introduce this additional cause of deviation here would render the investigation too complicated to be of any use.

18  
Illustration of this doctrine by experiments

This doctrine will be considerably illustrated by attending to the manner in which a lighter is tracked along a canal, or swings to its anchor in a stream. The track rope is made fast to some staple or bolt E on the deck (fig. 2.), and is passed between two of the timberheads of the bow at D, and laid hold of at F on shore. The men or cattle walk along the path FG, the rope keeps extended in the direction DF, and the lighter arranges itself in an oblique position AB, and is thus dragged along in the direction *ab*, parallel to the side of the canal. Or, if the canal has a current in the opposite direction *ba*, the lighter may be kept steady in its place by the rope DF made fast to a post at F. In this case, it is always observed that the lighter swings in a position AB, which is oblique to the stream *ab*. Now the force which retains it in this position, and which precisely balances the action of the stream, is certainly exerted in the direction DF; and the lighter would be held in the same manner if the rope were made fast at C amidship, without any dependence on the timberheads at D; and it would still be held in the same position, if, instead of the single rope CF, it were riding by two ropes CG and CH, of which CH is in a direction right ahead, but oblique to the stream, and the other CG is perpendicular to CH or AB. And, drawing DI and DK perpendicular to AB and CG, the strain on the rope CH is to that on the rope CG as CI to CK. The action of the rope in these cases is precisely analogous to that of the sail *yY*; and the obliquity of the keel to the direction of the motion, or to the direction of the stream, is analogous to the leeway. All this must be evident to any person accustomed to mechanical disquisitions.

19  
On models and

A most important use may be made of this illustration. If an accurate model be made of a ship, and if it be placed in a stream of water, and ridden in this manner by a rope made fast at any point D of the bow, it will arrange itself in some determined position AB. There will be a certain obliquity to the stream, mea-

sured by the angle *Bob*; and there will be a corresponding obliquity of the rope, measured by the angle FCB. Let *yCY* be perpendicular to CF. Then *CY* will be the position of the yard, or trim of the sails corresponding to the leeway *bCB*. Then, if we shift the rope to a point of the bow distant from D by a small quantity, we shall obtain a new position of the ship, both with respect to the stream and the rope; and in this way may be obtained the relation between the position of the sails and the leeway, independent of all theory, and susceptible of great accuracy; and this may be done with a variety of models suited to the most usual forms of ships.

20  
On ships

In farther thinking on this subject, we are persuaded that these experiments, instead of being made on models, may with equal ease be made on a ship of any size. Let the ship ride in a stream at a mooring D (fig. 3.) by means of a short hawser BCD from her bow, having a spring AC on it carried out from her quarter. She will swing to her moorings, till she ranges herself in a certain position AB with respect to the direction *ab* of the stream; and the direction of the hawser DC will point to some point E of the line of the keel. Now, it is plain to any person acquainted with mechanical disquisitions, that the deviation *BE* is precisely the leeway that the ship will make when the average position of the sails is that of the line GEH perpendicular to ED; at least this will give the leeway which is produced by the sails alone. By heaving on the spring, the knot C may be brought into any other position we please; and for every new position of the knot the ship will take a new position with respect to the stream and to the hawser. And we persist in saying, that more information will be got by this train of experiments than from any mathematical theory: for all theories of the impulses of fluids must proceed on physical postulates with respect to the motions of the filaments, which are exceedingly conjectural.

21  
The comparison of a ship to an oblong body is only useful to give clear notions on the subject.

And it must now be farther observed, that the substitution which we have made of an oblong parallelopiped for a ship, although well suited to give us clear notions of the subject, is of small use in practice: for it is next to impossible (even granting the theory of oblique impussions) to make this substitution. A ship is of a form which is not reducible to equations; and therefore the action of the water on her bow or broadside can only be had by a most laborious and intricate calculation for almost every square foot of its surface. (See *Bezout's Cours de Mathem.* vol. 5. p. 72, &c.) And this must be different for every ship. But, which is more unlucky, when we have got a parallelopiped which will have the same proportion of direct and lateral resistance for a particular angle of leeway, it will not answer for another leeway of the same ship; for when the leeway changes, the figure actually exposed to the action of the water changes also. When the leeway is increased, more of the lee-quarter is acted on by the water, and a part of the weather-bow is now removed from its action. Another parallelopiped must therefore be discovered, whose resistances shall suit this new position of the keel with respect to the real course of the ship.

We therefore beg leave to recommend this train of experiments to the notice of the ASSOCIATION FOR THE IMPROVEMENT OF NAVAL ARCHITECTURE as a very promising method for ascertaining this important point. And

we proceed, in the next place, to ascertain the relation between the velocity of the ship and that of the wind, modified as they may be by the trim of the sails and the obliquity of the impulse.

21  
The relation between the velocity of the ship and wind ascertained.

Let AB (fig. 4, 5, and 6.) represent the horizontal section of a ship. In place of all the drawing sails, that is, the sails which are really filled, we can always substitute one sail of equal extent, trimmed to the same angle with the keel. This being supposed attached to the yard DCD, let this yard be first of all at right angles to the keel, as represented in fig. 4. Let the wind blow in the direction WC, and let CE (in the direction WC continued) represent the velocity V of the wind. Let CF be the velocity  $v$  of the ship. It must also be in the direction of the ship's motion, because when the sail is at right angles to the keel, the absolute impulse on the sail is in the direction of the keel, and there is no lateral impulse, and consequently no leeway. Draw EF, and complete the parallelogram CFE $\epsilon$ , producing  $\epsilon$ C through the centre of the yard to  $w$ . Then  $w$ C will be the relative or apparent direction of the wind, and C $\epsilon$  or FE will be its apparent or relative velocity: For if the line C $\epsilon$  be carried along CF, keeping always parallel to its first position, and if a particle of air move uniformly along CE (a fixed line in absolute space) in the same time, this particle will always be found in that point of CE where it is intersected at that instant by the moving line C $\epsilon$ ; so that if C $\epsilon$  were a tube, the particle of air, which really moves in the line CE, would always be found in the tube C $\epsilon$ . While CE is the real direction of the wind, C $\epsilon$  will be the position of the vane at the mast head, which will therefore mark the apparent direction of the wind, or its motion relative to the moving ship.

We may conceive this in another way. Suppose a cannon-shot fired in the direction CE at the passing ship, and that it passes through the mast at C with the velocity of the wind. It will not pass through the off-side of the ship at P, in the line CE: for while the shot moves from C to P, the point P has gone forward, and the point  $p$  is now in the place where P was when the shot passed through the mast. The shot will therefore pass through the ship's side in the point  $p$ , and a person on board seeing it pass through C and  $p$  will say that its motion was in the line C $p$ .

23  
When a ship is in motion the apparent direction of the wind is always different from the real direction.

Thus it happens, that when a ship is in motion the apparent direction of the wind is always ahead of its real direction. The line  $w$ C is always found within the angle WCB. It is easy to see from the construction, that the difference between the real and apparent directions of the wind is so much the more remarkable as the velocity of the ship is greater: For the angle WC $w$  or EC $\epsilon$  depends on the magnitude of E $\epsilon$  or CF, in proportion to CE. Persons not much accustomed to attend to these matters are apt to think all attention to this difference to be nothing but affectation of nicety. They have no notion that the velocity of a ship can have any sensible proportion to that of the wind. "Swift as the wind" is a proverbial expression; yet the velocity of a ship always bears a very sensible proportion to that of the wind, and even very frequently exceeds it. We may form a pretty exact notion of the velocity of the wind by observing the shadows of the summer clouds flying along the face of a country, and it may be very well measured by this me-

thod. The motion of such clouds cannot be very different from that of the air below; and when the pressure of the wind on a flat surface, while blowing with a velocity measured in this way, is compared with its pressure when its velocity is measured by more unexceptionable methods, they are found to agree with all desirable accuracy. Now observations of this kind frequently repeated, show that what we call a pleasant brisk gale blows at the rate of about 10 miles an hour, or about 15 feet in a second, and exerts a pressure of half a pound on a square foot. Mr Smeaton has frequently observed the sails of a windmill, driven by such a wind, moving faster, nay much faster, towards their extremities, so that the sail, instead of being pressed to the frames on the arms, was taken aback, and fluttering on them. Nay, we know that a good ship, with all her sails set and the wind on the beam, will in such a situation sail above 10 knots an hour in smooth water. There is an observation made by every experienced seaman, which shows this difference between the real and apparent directions of the wind very distinctly. When a ship that is sailing briskly with the wind on the beam tacks about, and then sails equally well on the other tack, the wind always appears to have shifted and come more ahead. This is familiar to all seamen. The seaman judges of the direction of the wind by the position of the ship's vanes. Suppose the ship sailing due west on the starboard tack, with the wind apparently N. N. W. the vane pointing S. S. E. If the ship puts about, and stands due east on the larboard tack, the vane will be found no longer to point S. S. E. but perhaps S. S. W. the wind appearing N. N. E. and the ship must be nearly clove-hauled in order to make an east course. The wind appears to have shifted four points. If the ship tacks again, the wind returns to its old quarter. We have often observed a greater difference than this. The celebrated astronomer Dr Bradley, taking the amusement of sailing in a pinnace on the river Thames, observed this, and was surprised at it, imagining that the change of wind was owing to the approaching to or retiring from the shore. The boatmen told him that it always happened at sea, and explained it to him in the best manner they were able. The explanation struck him, and set him a musing on an astronomical phenomenon which he had been puzzled by for some years, and which he called THE ABBERRATION OF THE FIXED STARS. Every star changes its place a small matter for half a year, and returns to it at the completion of the year. He compared the stream of light from the star to the wind, and the telescope of the astronomer to the ship's vane, while the earth was like the ship, moving in opposite directions when in the opposite points of its orbit. The telescope must always be pointed ahead of the real direction of the star, in the same manner as the vane is always in a direction ahead of the wind; and thus he ascertained the progressive motion of light, and discovered the proportion of its velocity to the velocity of the earth in its orbit, by observing the deviation which was necessarily given to the telescope. Observing that the light shifted its direction about 40", he concluded its velocity to be about 11,000 times greater than that of the earth; just as the intelligent seaman would conclude from this apparent shifting of the wind, that the velocity of the wind is about triple that of the ship. This is indeed the best method

24  
Observation of Dr Bradley on this subject.

for

for discovering the velocity of the wind. Let the direction of the vane at the mast-head be very accurately noticed on both tacks, and let the velocity of the ship be also accurately measured. The angle between the directions of the ship's head on these different tacks being halved, will give the real direction of the wind, which must be compared with the position of the vane in order to determine the angle contained between the real and apparent directions of the wind or the angle EC  $\epsilon$ ; or half of the observed shifting of the wind will show the inclination of its true and apparent directions. This being found, the proportion of EC to FC (fig. 6.) is easily measured.

We have been very particular on this point, because since the mutual actions of bodies depend on their relative motions only, we should make prodigious mistakes if we estimated the action of the wind by its real direction and velocity, when they differ so much from the relative or apparent.

We now resume the investigation of the velocity of the ship (fig. 4.), having its sail at right angles to the keel, and the wind blowing in the direction and with the velocity CE, while the ship proceeds in the direction of the keel with the velocity CF. Produce E  $\epsilon$ , which is parallel to BC, till it meet the yard in g, and draw FG perpendicular to E g. Let  $a$  represent the angle WCD, contained between the sail and the real direction of the wind, and let  $b$  be the angle of trim DCB. CE the velocity of the wind was expressed by V, and CF the velocity of the ship by  $v$ .

The absolute impulse on the sail is (by the usual theory) proportional to the square of the relative velocity, and to the square of the sine of the angle of incidence; that is, to  $FE^2 \times \sin.^2 w CD$ . Now the angle GFE =  $w CD$ , and EG is equal to FE  $\times \sin. GFE$ ; and EG is equal to E g - g G. But E g = EC  $\times \sin. ECg$ , = V  $\times \sin. a$ ; and g G = CF, =  $v$ . Therefore EG = V  $\times \sin. a - v$ , and the impulse is proportional to  $V^2 \times \sin.^2 a - v^2$ . If S represent the surface of the sail, the impulse, in pounds, will be  $nS (V \times \sin. a - v)^2$ .

Let A be the surface which, when it meets the water perpendicularly with the velocity  $v$ , will sustain the same pressure or resistance which the bows of the ship actually meets with. This impulse, in pounds, will be  $mAv^2$ . Therefore, because we are considering the ship's motion as in a state of uniformity, the two pressures balance each other; and therefore  $mAv^2 = nS (V \times \sin. a - v)^2$ , and  $\frac{m}{n} Av^2 = S (V \times \sin. a - v)^2$ ;

$$\text{therefore } \sqrt{\frac{m}{n}} \sqrt{A} \times v = \sqrt{S} \times V \times \sin. a - v \sqrt{S},$$

$$\text{and } v = \frac{\sqrt{\frac{m}{n}} \sqrt{A} \times v \times \sin. a}{\sqrt{\frac{m}{n}} \sqrt{A} + \sqrt{S}} = \frac{V \times \sin. a}{\sqrt{\frac{m}{n}} \sqrt{A} + \sqrt{S}} = \frac{V \times \sin. a}{\sqrt{\frac{A}{S} + 1}}.$$

We see, in the first place, that the velocity of the ship is (*ceteris paribus*) proportional to the velocity of the wind, and to the sine of its incidence on the sail jointly; for while the surface of the sail S and the equivalent surface for the bows remains the same,  $v$  increases or diminishes at the same rate with  $V \times \sin. a$ . When the wind is right astern, the sine of  $a$  is unity,

and then the ship's velocity is 
$$\frac{V}{\sqrt{\frac{m}{n} \frac{A}{S} + 1}}.$$

Note, that the denominator of this fraction is a common number; for  $m$  and  $n$  are numbers, and A and S being quantities of one kind,  $\frac{A}{S}$  is also a number.

It must also be carefully attended to, that S expresses a quantity of sail actually receiving wind with the inclination  $a$ . It will not always be true, therefore, that the velocity will increase as the wind is more abaft, because some sails will then becalm others. This observation is not, however, of great importance; for it is very unusual to put a ship in the situation considered hitherto; that is, with the yards square, unless she be right before the wind.

If we would discover the relation between the velocity and the quantity of sail in this simple case of the wind right aft, observe that the equation  $v = \frac{V}{\sqrt{\frac{m}{n} \frac{A}{S} + 1}}$

gives us  $\sqrt{\frac{m}{n} \frac{A}{S}} v + v = V$ , and  $\sqrt{\frac{m}{n} \frac{A}{S}} v = V - v$ ;

and  $\frac{m}{n} \frac{A}{S} v^2 = V^2 - v^2$ , and  $\frac{n}{m} \frac{S}{A} = \frac{v^2}{(V - v)^2}$ ; and because  $n$  and  $m$  and A are constant quantities, S is proportional to  $\frac{v^2}{(V - v)^2}$ , or the surface of sail is proportional

to the square of the ship's velocity directly, and to the square of the relative velocity inversely. Thus, if a ship be sailing with  $\frac{1}{2}$  of the velocity of the wind, and we would have her sail with  $\frac{1}{4}$  of it, we must quadruple the sails. This is more easily seen in another way. The velocity of the ship is proportional to the velocity of the wind; and therefore the relative velocity is also proportional to that of the wind, and the impulse of the wind is as the square of the relative velocity. Therefore, in order to increase the relative velocity by an increase of sail only, we must make this increase of sail in the duplicate proportion of the increase of velocity.

Let us, in the next place, consider the motion of a ship whose sails stand oblique to the keel.

The construction for this purpose differs a little from the former, because, when the sails are trimmed to any oblique position DCB (fig. 5. and 6.), there must be a deviation from the direction of the keel, or a leeway BC  $b$ . Call this  $x$ . Let CF be the velocity of the ship. Draw, as before, E g perpendicular to the yard, and FG perpendicular to E g; also draw FH perpendicular to the yard: then, as before, EG, which is in the subduplicate ratio of the impulse on the sail, is equal to E g - Gg. Now E g is, as before, = V  $\times \sin. a$ , and Gg is equal to FH, which is = CF  $\times \sin. FCH$ , or =  $v \times \sin. (b + x)$ . Therefore we have the impulse =  $nS (V \times \sin. a - v \times \sin. (b + x))^2$ .

This expression of the impulse is perfectly similar to that in the former case, its only difference consisting in the subductive part, which is here  $v \times \sin. b + x$  instead of  $v$ . But it expresses the same thing as before, viz. the diminution of the impulse. The impulse being reckoned solely in the direction perpendicular to the sail,

25  
Its velocity when the sails stand oblique to the keel.

it is diminished solely by the sail withdrawing itself in that direction from the wind; and as  $gE$  may be considered as the real impulsive motion of the wind,  $GE$  must be considered as the relative and effective impulsive motion. The impulse would have been the same had the ship been at rest, and had the wind met it perpendicularly with the velocity  $GE$ .

27  
Connection between the impulse and motion of the ship.

We must now show the connection between this impulse and the motion of the ship. The sail, and consequently the ship, is pressed by the wind in the direction  $CI$  perpendicular to the sail or yard with the force which we have just now determined. This (in the state of uniform motion) must be equal and opposite to the action of the water. Draw  $IL$  at right angles to the keel. The impulse in the direction  $CI$  (which we may measure by  $CI$ ) is equivalent to the impulses  $CL$  and  $LI$ . By the first the ship is impelled right forward, and by the second she is driven sidewise. Therefore we must have a leeway, and a lateral as well as a direct resistance. We suppose the form of the ship to be known, and therefore the proportion is known, or discoverable, between the direct and lateral resistances corresponding to every angle  $x$  of leeway. Let  $A$  be the surface whose perpendicular resistance is equal to the direct resistance of the ship corresponding to the leeway  $x$ , that is, whose resistance is equal to the resistance really felt by the ship's bows in the direction of the keel when she is sailing with this leeway; and let  $B$  in like manner be the surface whose perpendicular resistance is equal to the actual resistance to the ship's motion in the direction  $LI$ , perpendicular to the keel. (*N. B.* This is not equivalent to  $A'$  and  $B'$  adapted to the rectangular box, but to  $A' \cos.^2 x$  and  $B' \sin.^2 x$ .) We have therefore  $A : B = CL : LI$ , and  $LI = \frac{CL \cdot B}{A}$ . Also,

because  $CI = \sqrt{CL^2 + LI^2}$ , we have  $A : \sqrt{A^2 + B^2} = CL : CI$ , and  $CI = \frac{CL \cdot \sqrt{A^2 + B^2}}{A}$ . The resist-

ance in the direction  $LC$  is properly measured by  $mAv^2$ , as has been already observed. Therefore the resistance in the direction  $IC$  must be expressed by  $m\sqrt{A^2 + B^2}v^2$ ; or (making  $C$  the surface which is equal to  $\sqrt{A^2 + B^2}$ , and which will therefore have the same perpendicular resistance to the water having the velocity  $v$ ) it may be expressed by  $mCv^2$ .

Therefore, because there is an equilibrium between the impulse and resistance, we have  $mCv^2 = nS(V \cdot \sin. a - v \cdot \sin. b+x)^2$  and  $\frac{m}{n}Cv^2$ , or  $qCv^2 = S(V \cdot \sin. a - v \cdot \sin. b+x)^2$ , and  $\sqrt{q} \sqrt{C} v = \sqrt{S}(V \cdot \sin. a - v \cdot \sin. b+x)$ .

$$\text{Therefore } v = \frac{\sqrt{S} \cdot V \cdot \sin. a}{\sqrt{q} \sqrt{C} + \sqrt{S} \cdot \sin. b+x}, = \frac{V \cdot \sin. a}{\sqrt{q} \frac{\sqrt{C}}{\sqrt{S}} + \sin. b+x}, = V \frac{\sin. a}{\sqrt{q} \frac{\sqrt{C}}{\sqrt{S}} + \sin. b+x}.$$

Observe that the quantity which is the coefficient of  $V$  in this equation is a common number; for  $\sin. a$  is a number, being a decimal fraction of the radius 1.  $\sin. b+x$  is also a number, for the same reason. And since  $m$  and  $n$  were numbers of pounds,  $\frac{m}{n}$  or  $q$  is a

common number. And because  $C$  and  $S$  are surfaces, or quantities of one kind,  $\frac{C}{S}$  is also a common number.

This is the simplest expression that we can think of for the velocity acquired by the ship, though it must be acknowledged to be too complex to be of very prompt use. Its complication arises from the necessity of introducing the leeway  $x$ . This affects the whole of the denominator; for the surface  $C$  depends on it, because  $C$  is  $= \sqrt{A^2 + B^2}$ , and  $A$  and  $B$  are analogous to  $A' \cos.^2 x$  and  $B' \sin.^2 x$ .

But we can deduce some important consequences from this theorem.

While the surface  $S$  of the sail actually filled by the wind remains the same, and the angle  $\angle DCB$ , which in future we shall call the *TRIM* of the sails, also remains the same, both the leeway  $x$  and the substituted surface  $C$  remains the same. The denominator is therefore constant; and the velocity of the ship is proportional to  $\sqrt{S} \cdot V \cdot \sin. a$ ; that is, directly as the velocity of the wind, directly as the absolute inclination of the wind to the yard, and directly as the square root of the surface of the sails.

We also learn from the construction of the figure that  $FG$  parallel to the yard cuts  $CE$  in a given ratio. For  $CF$  is in a constant ratio to  $EG$ , as has been just now demonstrated. And the angle  $\angle DCF$  is constant. Therefore  $CF \cdot \sin. b$ , or  $FH$  or  $Gg$ , is proportional to  $EG$ , and  $OC$  to  $EC$ , or  $EC$  is cut in one proportion, whatever may be the angle  $\angle ECD$ , so long as the angle  $\angle DCF$  is constant.

We also see that it is very possible for the velocity of the ship on an oblique course to exceed that of the wind. This will be the case when the number

$$\frac{\sin. a}{\sqrt{q \frac{C}{S} + \sin. b+x}}$$

exceeds unity, or when  $\sin. a$  is greater than  $\sqrt{q \frac{C}{S} + \sin. b+x}$ . Now this may easily

be by sufficiently enlarging  $S$  and diminishing  $b+x$ . It is indeed frequently seen in fine sailers with all their sails set and not hauled too near the wind.

We remarked above that the angle of leeway  $x$  affects the whole denominator of the fraction which expresses the velocity. Let it be observed that the angle  $\angle ICL$  is the complement of  $\angle LCD$ , or of  $b$ . Therefore  $CL : LI$ , or  $A : B = 1 : \tan. \angle ICL = 1 : \cot. b$ , and  $B = A \cdot \cotan. b$ . Now  $A$  is equivalent to  $A' \cos.^2 x$ , and thus  $b$  becomes a function of  $x$ .  $C$  is evidently so, being  $= \sqrt{A^2 + B^2}$ . Therefore before the value of this fraction can be obtained, we must be able to compute, by our knowledge of the form of the ship, the value of  $A$  for every angle  $x$  of leeway. This can be done only by resolving her bows into a great number of elementary planes, and computing the impulses on each and adding them into one sum. The computation is of immense labour, as may be seen by one example given by Bouguer. When the leeway is but small, not exceeding ten degrees, the substitution of the rectangular prism of one determined form is abundantly exact for all leeways contained within this limit; and we shall soon see reason

28  
Imports consequences deduced from the foregoing theorem.

son for being contented with this approximation. We may now make use of the formula expressing the velocity for solving the chief problems in this part of the seaman's talk.

And first let it be required to determine the best position of the sail for standing on a given course  $ab$ , when  $CE$  the direction and velocity of the wind, and its angle with the course  $WCF$ , are given. This problem has exercised the talents of the mathematicians ever since the days of Newton. In the article **FRUMATICS** we gave the solution of one very nearly related to it, namely, to determine the position of the sail which would produce the greatest impulse in the direction of the course. The solution was to place the yard  $CD$  in such a position that the tangent of the angle  $FCD$  may be one half of the tangent of the angle  $DCW$ . This will indeed be the best position of the sail for beginning the motion; but as soon as the ship begins to move in the direction  $CF$ , the effective impulse of the wind is diminished, and also its inclination to the sail. The angle  $DCW$  diminishes continually as the ship accelerates; for  $CF$  is now accompanied by its equal  $CE$ , and by an angle  $ECe$  or  $WCw$ .  $CF$  increases, and the impulse on the sail diminishes, till an equilibrium obtains between the resistance of the water and the impulse of the wind. The impulse is now measured by  $CE^2 \times \sin.^2 e CD$  instead of  $CE^2 \times \sin.^2 ECD$ , that is, by  $EG^2$  instead of  $Eg^2$ .

This introduction of the relative motion of the wind renders the actual solution of the problem extremely difficult. It is very easily expressed geometrically: Divide the angle  $wCF$  in such a manner that the tangent of  $DCF$  may be half of the tangent of  $DCw$ , and the problem may be constructed geometrically as follows.

Let  $WCF$  (fig. 7.) be the angle between the sail and course. Round the centre  $C$  describe the circle  $WDFY$ ; produce  $WC$  to  $Q$ , so that  $CQ = \frac{1}{2} WC$ , and draw  $QY$  parallel to  $CF$  cutting the circle in  $Y$ ; bisect the arch  $WY$  in  $D$ , and draw  $DC$ .  $DC$  is the proper position of the yard.

Draw the chord  $WY$ , cutting  $CD$  in  $V$  and  $CF$  in  $T$ ; draw the tangent  $PD$  cutting  $CF$  in  $S$  and  $CY$  in  $R$ .

It is evident that  $WY$ ,  $PR$ , are both perpendicular to  $CD$ , and are bisected in  $V$  and  $D$ ; therefore (by reason of the parallels  $QY$ ,  $CF$ )  $4 : 3 = QW : CW$ ,  $= YW : TW$ ,  $= RP : SP$ . Therefore  $PD : PS = 2 : 3$ , and  $PD : DS = 2 : 1$ . *Q. E. D.* But this division cannot be made to the best advantage till the ship has attained its greatest velocity, and the angle  $wCF$  has been produced.

We must consider all the three angles,  $a$ ,  $b$ , and  $x$  as variable in the equation which expresses the value of  $v$ , and we must make the fluxion of this equation  $= 0$ ; then, by means of the equation  $B = A \cdot \cotan. b$ , we must obtain the value of  $b$  and of  $\dot{b}$  in terms of  $x$  and  $\dot{x}$ . With respect to  $a$ , observe, that if we make the angle  $WCF = p$ , we have  $p = a + b + x$ ; and  $p$  being a constant quantity, we have  $a + b + x = c$ . Substituting for  $a$ ,  $b$ ,  $a$ , and  $\dot{b}$ , their values in terms of  $x$  and  $\dot{x}$ , in the fluxionary equation  $= 0$ , we readily obtain  $x$ , and then  $a$  and  $b$ , which solves the problem.

Let it be required, in the next place, to determine

the course and the trim of the sails most proper for plying to windward.

In fig. 6. draw  $FP$  perpendicular to  $WC$ .  $CF$  is the motion of the ship; but it is only by the motion  $CP$  that she gains to windward. Now  $CP$  is  $= CF \times \cosin. WCF$ , or  $v \cdot \cosin. (a + b + x)$ . This must be rendered a maximum, as follows.

By means of the equation which expresses the value of  $v$  and the equation  $B = A \cdot \cotan. b$ , we exterminate the quantities  $v$  and  $b$ ; we then take the fluxion of the quantity into which the expression  $v \cdot \cosin. (a + b + x)$  is changed by this operation. Making this fluxion  $= 0$ , we get the equation which must solve the problem. This equation will contain the two variable quantities  $a$  and  $x$  with their fluxions; then make the coefficient of  $\dot{x}$  equal to 0, also the coefficient of  $\dot{a}$  equal to 0. This will give two equations which will determine  $a$  and  $x$ , and from this we get  $b = p - a - x$ .

Should it be required, in the third place, to find the best course and trim of the sails for getting away from a given line of coast  $CM$  (fig. 6.), the process perfectly resembles this last, which is in fact getting away from a line of coast which makes a right angle with the wind. Therefore, in place of the angle  $WCF$ , we must substitute the angle  $WCM = WCF$ . Call this angle  $e$ . We must make  $v \cdot \cosin. (e - a - b - x)$  a maximum. The analytical process is the same as the former, only  $e$  is here a constant quantity.

These are the three principal problems which can be solved by means of the knowledge that we have obtained of the motion of the ship when impelled by an oblique sail, and therefore making leeway; and they may be considered as an abstract of this part of M. Bouguer's work. We have only pointed out the process for this solution, and have even omitted some things taken notice of by M. Bezout in his very elegant compendium. Our reasons will appear as we go on. The learned reader will readily see the extreme difficulty of the subject, and the immense calculations which are necessary even in the simplest cases, and will grant that it is out of the power of any but an expert analyst to derive any use from them; but the mathematician can calculate tables for the use of the practical seaman. Thus he can calculate the best position of the sails for advancing in a course  $90^\circ$  from the wind, and the velocity in that course; then for  $85^\circ$ ,  $80^\circ$ ,  $75^\circ$ , &c. M. Bouguer has given a table of this kind; but to avoid the immense difficulty of the process, he has adapted it to the apparent direction of the wind. We have inserted a few of his numbers, suited to such cases as can be of service, namely, when all the sails draw, or none stand in the way of others. Column 1st is the apparent angle of the wind and course; column 2d is the corresponding angle of the sails and keel; and column 3d is the apparent angle of the sails and wind.

<sup>1</sup> $wCF$	<sup>2</sup> $DCB$	<sup>3</sup> $wCD$
$103^\circ 53'$	$42^\circ 30'$	$61^\circ 25'$
$99 \ 13$	$40 \ \text{—}$	$59 \ 13$
$94 \ 25$	$37 \ 30$	$56 \ 55$
$89 \ 28$	$35 \ \text{—}$	$54 \ 28$
$84 \ 23$	$32 \ 30$	$51 \ 53$
$79 \ 06$	$30 \ \text{—}$	$49 \ 06$
$73 \ 37$	$27 \ 30$	$46 \ 09$
$65 \ \text{—}$	$25 \ \text{—}$	$43 \ \text{—}$

In all these numbers we have the tangent of  $wCD$  double of the tangent of  $DCF$ .

34  
Inutility of  
these calcu-  
lations.

But this is really doing but little for the seaman. The apparent direction of the wind is unknown to him till the ship is sailing with uniform velocity; and he is still uninformed as to the leeway. It is, however, of service to him to know, for instance, that when the angle of the vanes and yards is  $56$  degrees, the yard should be braced up to  $37\ 30'$ , &c.

But here occurs a new difficulty. By the construction of a square-rigged ship it is impossible to give the yards that inclination to the keel which the calculation requires. Few ships can have their yards braced up to  $37\ 30'$ ; and yet this is required in order to have an incidence of  $56^\circ$ , and to hold a course  $94^\circ\ 25'$  from the apparent direction of the wind, that is, with the wind apparently  $4^\circ\ 25'$  abaft the beam. A good sailing ship in this position may acquire a velocity even exceeding that of the wind. Let us suppose it only one half of this velocity. We shall find that the angle  $WCw$  is in this case about  $29^\circ$ , and the ship is nearly going  $123^\circ$  from the wind, with the wind almost perpendicular to the sail; therefore this utmost bracing up of the sails is only giving them the position suited to a wind broad on the quarter. It is impossible therefore to comply with the demand of the mathematician, and the seaman must be contented to employ a less favourable disposition of his sails in all cases where his course does not lie at least eleven points from the wind.

Let us see whether this restriction, arising from necessity, leaves any thing in our choice, and makes one course preferable to another. We see that there are a prodigious number of courses, and these the most usual and the most important, which we must hold with one trim of the sails; in particular, sailing with the wind on the beam, and all cases of plying to windward, must be performed with this unfavourable trim of the sails. We are certain that the smaller we make the angle of incidence, real or apparent, the smaller will be the velocity of the ship; but it may happen that we shall gain more to windward, or get sooner away from a lee-coast, or any object of danger, by sailing slowly on one course than by sailing quickly on another.

We have seen that while the trim of the sails remains the same, the leeway and the angle of the yard and course remains the same, and that the velocity of the ship is as the sine of the angle of real incidence, that is, as the sine of the angle of the sail and the real direction of the wind.

Let the ship  $AB$  (fig. 8.) hold the course  $CF$ , with the wind blowing in the direction  $WC$ , and having her yards  $DCD$  braced up to the smallest angle  $BCD$  which the rigging can admit. Let  $CF$  be to  $CE$  as the velocity of the ship to the velocity of the wind; join  $FE$  and draw  $Cw$  parallel to  $EF$ ; it is evident that  $FE$  is the relative motion of the wind, and  $wCD$  is the relative incidence on the sail. Draw  $FO$  parallel to the yard  $DC$ , and describe a circle through the points  $COF$ ; then we say that if the ship, with the same wind and the same trim of the same drawing sails, be made to sail on any other course  $Cf$ , her velocity along  $CF$  is to the velocity along  $Cf$  as  $CF$  is to  $Cf$ ; or, in other words, the ship will employ the same time in going from  $C$  to any point of the circumference  $CFO$ .

Join  $fO$ . Then, because the angles  $CFO$ ,  $cfO$  are on

the same chord  $CO$ , they are equal, and  $fO$  is parallel to  $dCd$ , the new position of the yard corresponding to the new position of the keel  $ab$ , making the angle  $dCb = DCB$ . Also, by the nature of the circle, the line  $CF$  is to  $Cf$  as the sine of the angle  $COF$  to the sine of the angle  $COf$ , that is (on account of the parallels  $CD$ ,  $OF$  and  $Cd$ ,  $Of$ ), as the sine of  $WCD$  to the sine of  $WCd$ . But when the trim of the sails remains the same, the velocity of the ship is as the sine of the angle of the sail with the direction of the wind; therefore  $CF$  is to  $Cf$  as the velocity on  $CF$  to that on  $Cf$ , and the proposition is demonstrated.

Let it now be required to determine the best course for avoiding a rock  $R$  lying in the direction  $CR$ , or for withdrawing as fast as possible from a line of coast  $PQ$ . Draw  $CM$  through  $R$ , or parallel to  $PQ$ , and let  $m$  be the middle of the arch  $CmM$ . It is plain that  $m$  is the most remote from  $CM$  of any point of the arch  $CmM$ , and therefore the ship will recede farther from the coast  $PQ$  in any given time by holding the course  $Cm$  than by any other course.

This course is easily determined; for the arch  $CmM = 360^\circ - (\text{arch } CO + \text{arch } OM)$ , and the arch  $CO$  is the measure of twice the angle  $CFO$ , or twice the angle  $DCB$ , or twice  $b+x$ , and the arch  $OM$  measures twice the angle  $ECM$ .

Thus, suppose the sharpest possible trim of the sails to be  $35^\circ$ , and the observed angle  $ECM$  to be  $70^\circ$ ; then  $CO + OM$  is  $70^\circ + 140^\circ$  or  $210^\circ$ . This being taken from  $360^\circ$ , leaves  $150^\circ$ , of which the half  $Mm$  is  $75^\circ$ , and the angle  $MCm$  is  $37^\circ\ 30'$ . This added to  $ECM$  makes  $ECm$   $107^\circ\ 30'$ , leaving  $WCm = 72^\circ\ 30'$ , and the ship must hold a course making an angle of  $72^\circ\ 30'$  with the real direction of the wind, and  $WCD$  will be  $37^\circ\ 30'$ .

This supposes no leeway. But if we know that under all the sail which the ship can carry with safety and advantage she makes  $5$  degrees of leeway, the angle  $DCm$  of the sail and course, or  $b+x$ , is  $40^\circ$ . Then  $CO + OM = 220^\circ$ , which being taken from  $360^\circ$  leaves  $140^\circ$ , of which the half is  $70^\circ = Mm$ , and the angle  $MCm = 35^\circ$ , and  $ECm = 105^\circ$ , and  $WCm = 75^\circ$ , and the ship must lie with her head  $70^\circ$  from the wind, making  $5$  degrees of leeway, and the angle  $WCD$  is  $35^\circ$ .

The general rule for the position of the ship is, that the line on shipboard which bisects the angle  $b+x$  may also bisect the angle  $WCM$ , or make the angle between the course and the line from which we wish to withdraw equal to the angle between the sail and the real direction of the wind.

It is plain that this problem includes that of plying to windward. We have only to suppose  $ECM$  to be  $90^\circ$ ; then, taking our example in the same ship, with the same trim and the same leeway, we have  $b+x = 40^\circ$ . This taken from  $90^\circ$  leaves  $50^\circ$  and  $WCn = 90^\circ - 25^\circ = 65^\circ$ , and the ship's head must lie  $60^\circ$  from the wind, and the yard must be  $25^\circ$  from it.

It must be observed here, that it is not always eligible to select the course which will remove the ship fastest from the given line  $CM$ ; it may be more prudent to remove from it more securely though more slowly. In such cases the procedure is very simple, viz. to shape the course as near the wind as is possible.

The reader will also easily see that the propriety of these practices is confined to those courses only where the practicable trim of the sails is not sufficiently sharp.



Whenever the course lies so far from the wind that it is possible to make the tangent of the apparent angle of the wind and sail double the tangent of the sail and course, it should be done.

ratio of the sines; and col. 4th the impulses, if they were in the simple ratio of the sines.

37 The adjustment of the sails supposed in the theory impracticable.

These are the chief practical consequences which can be deduced from the theory. But we should consider how far this adjustment of the sails and course can be performed. And here occur difficulties so great as to make it almost impracticable. We have always supposed the position of the surface of the sail to be distinctly observable and measurable; but this can hardly be affirmed even with respect to a sail stretched on a yard. Here we supposed the surface of the sail to have the same inclination to the keel that the yard has. This is by no means the case; the sail assumes a concave form, of which it is almost impossible to assign the direction of the mean impulse. We believe that this is always considerably to leeward of a perpendicular to the yard, lying between CI and CE (fig. 6.). This is of some advantage, being equivalent to a sharper trim. We cannot affirm this, however, with any confidence, because it renders the impulse on the weather-leech of the sail so exceedingly feeble as hardly to have any effect. In sailing close to the wind the ship is kept so near that the weather-leech of the sail is almost ready to receive the wind edgewise, and to flutter or shiver. The most effective or drawing sails with a side-wind, especially when plying to windward, are the stay-sails. We believe that it is impossible to say, with any thing approaching to precision, what is the position of the general surface of a stay-sail, or to calculate the intensity and direction of the general impulse; and we affirm with confidence that no man can pronounce on these points with any exactness. If we can guess within a third or a fourth part of the truth, it is all we can pretend to; and after all, it is but a guess. Add to this, the sails coming in the way of each other, and either becalming them or sending the wind upon them in a direction widely different from that of its free motion. All these points we think beyond our power of calculation, and therefore that it is in vain to give the seaman mathematical rules, or even tables of adjustment ready calculated; since he can neither produce that medium position of his sails that is required, nor tell what is the position which he employs.

Angle of Incid.	Impulsion observed.	Impulse as Sine <sup>2</sup> .	Impulse as Sine.
90	1000	1000	1000
84	989	989	995
78	958	957	978
72	908	905	951
66	845	835	914
60	771	750	866
54	693	655	809
48	615	552	743
42	543	448	669
36	480	346	587
30	440	250	500
24	424	165	407
18	414	96	309
12	406	43	208
6	400	11	105

Here we see an enormous difference in the great obliquities. When the angle of incidence is only six degrees, the observed impulse is forty times greater than the theoretical impulse; at 12° it is ten times greater; at 18° it is more than four times greater; and at 24° it is almost three times greater.

No wonder then that the deductions from this theory are so useless and so unlike what we familiarly observe. We took notice of this when we were considering the leeway of a rectangular box, and thus saw a reason for admitting an incomparably smaller leeway than what would result from the laborious computations necessary by the theory. This error in theory has as great an influence on the impulsions of air when acting obliquely on a sail; and the experiments of Mr Robins and of the Chevalier Borda on the oblique impulsions of air are perfectly conformable (as far as they go) to those of the academicians on water. The oblique impulsions of the wind are therefore much more efficacious for pressing the ship in the direction of her course than the theory allows us to suppose; and the progress of a ship plying to windward is much greater, both because the oblique impulses of the wind are more effective, and because the leeway is much smaller, than we suppose. Were not this the case, it would be impossible for a square-rigged ship to get to windward. The impulse on her sails when close-hauled would be so trifling that she would not have a third part of the velocity which we see her acquire: and this trifling velocity would be wasted in leeway; for we have seen that the diminution of the oblique impulses of the water is accompanied by an increase of leeway. But we see that in the great obliquities the impulsions continue to be very considerable, and that even an incidence of six degrees gives an impulse as great as the theory allows to an incidence of 40. We may therefore, on all occasions, keep the yards more square; and the loss which we sustain by the diminution of the very oblique impulse will be more than compensated by its more favourable direction with respect to the ship's keel. Let us take an example of this. Suppose the wind about two points before the beam, making an angle of 68° with the keel. The theory assigns 43° for the inclination of the wind to

38 The theory itself erroneous.

But there is another principal reason for the small progress which has been made in the theory of seamanship: This is the errors of the theory itself, which supposes the impulsions of a fluid to be in the duplicate ratio of the sine of incidence. The most careful comparison which has been made between the results of this theory and matter of fact is to be seen in the experiments made by the members of the Royal Academy of Sciences at Paris, mentioned in the article *RESISTANCE of Fluids*. We subjoin another abstract of them in the following table; where col. 1st gives the angle of incidence; col. 2d gives the impulsions really observed; col. 3d the impulses, had they followed the duplicate

the sail, and  $25^\circ$  for the trim of the sail. The perpendicular impulse being supposed 1000, the theoretical impulse for  $43^\circ$  is 465. This reduced in the proportion of radius to the sine of  $25^\circ$ , gives the impulse in the direction of the course only 197.

But if we ease off the lee-braces till the yard makes an angle of  $30^\circ$  with the keel, and allows the wind an incidence of no more than  $18^\circ$ , we have the experimented impulse 414, which, when reduced in the proportion of radius to the sine of  $50^\circ$ , gives an effective impulse 317. In like manner, the trim  $56^\circ$ , with the incidence  $12^\circ$ , gives an effective impulse 337; and the trim  $62^\circ$ , with the incidence only  $6^\circ$ , gives 353.

Hence it would at first sight appear that the angle DCB of  $62^\circ$  and WCD of  $6^\circ$  would be better for holding a course within six points of the wind than any more oblique position of the sails; but it will only give a greater initial impulse. As the ship accelerates, the wind apparently comes ahead, and we must continue to brace up as the ship freshens her way. It is not unusual for her to acquire half or two thirds of the velocity of the wind; in which case the wind comes apparently ahead more than two points, when the yards must be braced up to  $35^\circ$ , and this allows an impulse no greater than about  $7^\circ$ . Now this is very frequently observed in good ships, which in a brisk gale and smooth water will go five or six knots close-hauled, the ship's head six points from the wind, and the sails no more than just full, but ready to shiver by the smallest luff. All this would be impossible by the usual theory; and in this respect these experiments of the French academy give a fine illustration of the seaman's practice. They account for what we should otherwise be much puzzled to explain; and the great progress which is made by a ship close-hauled being perfectly agreeable to what we should expect from the law of oblique impulsion deducible from these so often mentioned experiments, while it is totally incompatible with the common theory, should make us abandon the theory without hesitation, and strenuously set about the establishment of another, founded entirely on experiments. For this purpose the experiments should be made on the oblique impulsions of air on as great a scale as possible, and in as great a variety of circumstances, so as to furnish a series of impulsions for all angles of obliquity. We have but four or five experiments on this subject, viz. two by Mr Robins and two or three by the Chevalier Borda. Having thus gotten a series of impulsions, it is very practicable to raise on this foundation a practical institute, and to give a table of the velocities of a ship suited to every angle of inclination and of trim; for nothing is more certain than the resolution of the impulse perpendicular to the sail into a force in the direction of the keel, and a lateral force.

We are also disposed to think that experiments might be made on a model very nicely rigged with sails, and trimmed in every different degree, which would point out the mean direction of the impulse on the sails, and the comparative force of these impulses in different directions of the wind. The method would be very similar to that for examining the impulse of the water on the hull. If this can also be ascertained experimentally, the intelligent reader will easily see that the whole motion of a ship under sail may be determined for every case. Tables may then be constructed by calculation,

or by graphical operations, which will give the velocities of a ship in every different course, and corresponding to every trim of sail. And let it be here observed, that the trim of the sail is not to be estimated in degrees of inclination of the yards; because, as we have already remarked, we cannot observe nor adjust the latten sails in this way. But, in making the experiments for ascertaining the impulse, the exact position of the tacks and sheets of the sails are to be noted; and this combination of adjustments is to pass by the name of a certain trim. Thus that trim of all the sails may be called 40, whose direction is experimentally found equivalent to a flat surface trimmed to the obliquity  $40^\circ$ .

Having done this, we may construct a figure for each trim similar to fig. 8. where, instead of a circle, we shall have a curve COMF', whose chords CF', cf', &c. are proportional to the velocities in these courses; and by means of this curve we can find the point m', which is most remote from any line CM from which we wish to withdraw: and thus we may solve all the principal problems of the art.

We hope that it will not be accounted presumption in us to expect more improvement from a theory founded on judicious experiments only, than from a theory of the impulse of fluids, which is found so inconsistent with observation, and of whose fallacy all its authors, from Newton to D'Alembert, entertained strong suspicions. Again, we beg leave to recommend this view of the subject to the attention of the SOCIETY FOR THE IMPROVEMENT OF NAVAL ARCHITECTURE. Should these patriotic gentlemen entertain a favourable opinion of the plan, and honour us with their correspondence, we will cheerfully impart to them our notions of the way in which both these trains of experiments may be prosecuted with success, and results obtained in which we may confide; and we content ourselves at present with offering to the public these hints, which are not the speculations of a man of mere science, but of one who, with a competent knowledge of the laws of mechanical nature, has the experience of several years service in the royal navy, where the art of working of ships was a favourite object of his scientific attention.

With these observations we conclude our discussion of the first part of the seaman's task, and now proceed to consider the means that are employed to prevent or to produce any deviations from the uniform rectilinear course which has been selected.

Here the ship is to be considered as a body in free space, convertible round her centre of inertia. For whatever may be the point round which she turns, this motion may always be considered as compounded of a rotation round an axis passing through her centre of gravity or inertia. She is impelled by the wind and by the water acting on many surfaces differently inclined to each other, and the impulse on each is perpendicular to the surface. In order therefore that she may continue steadily in one course, it is not only necessary that the impelling forces, estimated in their mean direction, be equal and opposite to the resisting forces estimated in their mean direction; but also that these two directions may pass through one point, otherwise she will be affected as a log of wood is when pushed in opposite directions by two forces, which are equal indeed, but are applied to different parts of the log. A ship must

40  
Experiments proper for establishing another

41  
Recommended to the Society for the Improvement of Naval Architecture.

42  
Means employed to prevent or produce deviations from a course.

be considered as a lever, acted on in different parts by forces in different directions, and the whole balancing each other round that point or axis where the equivalent of all the resisting forces passes. This may be considered as a point supported by this resisting force, and as a sort of fulcrum: therefore, in order that the ship may maintain her position, the energies or *momenta* of all the impelling forces round this point must balance each other.

43  
Impulses on a ship sailing right before the wind differ from those on her when sailing obliquely.

When a ship sails right afore the wind, with her yards square, it is evident that the impulses on each side of the keel are equal, as also their mechanical *momenta* round any axis passing perpendicularly through the keel. So are the actions of the water on her bows. But when the sails on an oblique course, with her yards braced up on either side, she sustains a pressure in the direction *CI* (fig. 5.) perpendicular to the sail. This, by giving her a lateral pressure *LI*, as well as a pressure *CL* ahead, causes her to make leeway, and to move in a line *Cb* inclined to *CB*. By this means the balance of action on the two bows is destroyed; the general impulse on the lee-bow is increased; and that on the weather-bow is diminished. The combined impulse is therefore no longer in the direction *BC*, but (in the state of uniform motion) in the direction *IC*.

Suppose that in an instant the whole sails are annihilated and the impelling pressure *CI*, which precisely balanced the resisting pressure on the bows, removed. The ship tends, by her inertia, to proceed in the direction *Cb*. This tendency produces a continuation of the resistance in the opposite direction *IC*, which is not directly opposed to the tendency of the ship in the direction *Cb*; therefore the ship's head would immediately come up to the wind. The experienced seaman will recollect something like this when the sails are suddenly lowered when coming to anchor. It does not happen solely from the obliquity of the action on the bows: It would happen to the paralleloiped of fig. 2. which was sustaining a lateral impulsion  $B \sin^2 x$ , and a direct impulsion  $A \cos^2 x$ . These are continued for a moment after the annihilation of the sail; but being no longer opposed by a force in the direction *CD*, but by a force in the direction *Cb*, the force  $B \sin^2 x$  must prevail, and the body is not only retarded in its motion, but its head turns towards the wind. But this effect of the leeway is greatly increased by the curved form of the ship's bows. This occasions the centre of effort of all the impulsions of the water on the lee side of the ship to be very far forward, and this so much the more remarkably as the is sharper afore. It is in general not much abaft the foremast. Now the centre of the ship's tendency to continue her motion is the same with her centre of gravity, and this is generally but a little before the mainmast. She is therefore in the same condition nearly as if she were pushed at the mainmast in a direction parallel to *Cb*, and at the foremast by a force parallel to *IC*. The evident consequence of this is a tendency to come up to the wind. This is independent of all situation of the sails, provided only that they have been trimmed obliquely.

44  
Steeping.

This tendency of the ship's head to windward is called *GRIPPING* in the seaman's language, and is greatest in ships which are sharp forward, as we have said already. This circumstance is easily understood. Whatever is the direction of the ship's motion, the absolute

impulse on that part of the bow immediately contiguous to *D* is perpendicular to that very part of the surface. The more acute, therefore, that the angle of the bow is, the more will the impulse on that part be perpendicular to the keel, and the greater will be its energy to turn the head to windward.

Thus we are enabled to understand or to see the propriety of the disposition of the sails of a ship. We see the disposition of the sails of a ship crowded with sails forward, and even many sails extended far before her bow, such as the spritsail, the bowsprit top-sail, the fore-topmast stay-sail, the jib, and flying jib. The sails abaft are comparatively smaller. The sails on the mizenmast are much smaller than those on the foremast. All the stay-sails hoisted on the mainmast may be considered as head-sails, because their centres of effort are considerably before the centre of gravity of the ship; and notwithstanding this disposition, it generally requires a small action of the rudder to counteract the windward tendency of the lee-bow. This is considered as a good quality when moderate; because it enables the seaman to throw the sails aback, and stop the ship's way in a moment, if she be in danger from any thing ahead; and the ship which does not carry a little of a weather helm, is always a dull sailer.

In order to judge somewhat more accurately of the action of the water and sails, suppose the ship *AB* (fig. 9.) to have its sails on the mizenmast *D*, the mainmast *E*, and foremast *F*, braced up or trimmed alike, and that the three lines *Di*, *Ee*, *Ff*, perpendicular to the sails, are in the proportion of the impulses on the sails. The ship is driven ahead and to leeward, and moves in the path *aCb*. This path is so inclined to the line of the keel that the medium direction of the resistance of the water is parallel to the direction of the impulse. A line *CI* may be drawn parallel to the lines *Di*, *Ee*, *Ff*, and equal to their sum: and it may be drawn from such a point *C*, that the actions on all the parts of the hull between *C* and *B* may balance the *momenta* of all the actions on the hull between *C* and *A*. This point may justly be called the *centre of effort*, or the *centre of resistance*. We cannot determine this point for want of a proper theory of the resistance of fluids. Nay, although experiments like those of the Parisian academy should give us the most perfect knowledge of the intensity of the oblique impulses on a square foot, we should hardly be benefited by them: for the action of the water on a square foot of the hull at *p*, for instance, is so modified by the intervention of the stream of water which has struck the hull about *B*, and glided along the bow *Bo p*, that the pressure on *p* is totally different from what it would have been were it a square foot of surface detached from the rest, and presented in the same position to the water moving in the direction *bC*. For it is found, that the resistances given to planes joined so as to form a wedge, or to curved surfaces, are widely different from the accumulated resistances, calculated for their separate parts, agreeably to the experiments of the academy on single surfaces. We therefore do not attempt to ascertain the point *C* by theory; but it may be accurately determined by the experiments which we have so strongly recommended; and we offer this as an additional inducement for prosecuting them. To be determined.

Draw through *C* a line perpendicular to *CI*, that is, parallel to the sails; and let the lines of impulse of the *momenta* terminate.

49  
Equilibrium preserved by the position of the sails

three sails cut it in the points  $i$ ,  $k$ , and  $m$ . This line  $im$  may be considered as a lever, moveable round  $C$ , and acted on at the points  $i$ ,  $k$ , and  $m$ , by three forces. The rotatory momentum of the sails on the mizenmast is  $Di \times iC$ ; that of the sails on the mainmast is  $Ee \times kC$ ; and the momentum of the sails on the foremast is  $Ff \times mC$ . The two first tend to prefs forward the arm  $Ci$ , and then to turn the ship's head towards the wind. The action of the sails on the foremast tends to pull the arm  $Cm$  forward, and produce a contrary rotation. If the ship under these three sails keeps steadily in her course, without the aid of the rudder, we must have  $Di \times iC + Ee \times kC = Ff \times mC$ . This is very possible, and is often seen in a ship under her mizen-topfail, main topfail, and fore-topfail, all parallel to one another, and their surfaces duly proportioned by reefing. If more sails are set, we must always have a similar equilibrium. A certain number of them will have their efforts directed from the larboard arm of the lever  $im$  lying to leeward of  $CI$ , and a certain number will have their efforts directed from the starboard arm lying to windward of  $CI$ . The sum of the products of each of the first set, by their distances from  $C$ , must be equal to the sum of the similar products of the other set. As this equilibrium is all that is necessary for preserving the ship's position, and the cessation of it is immediately followed by a conversion; and as these states of the ship may be had by means of the three square sails only, when their surfaces are properly proportioned—it is plain that every movement may be executed and explained by their means. This will greatly simplify our future discussions. We shall therefore suppose in future that there are only the three topfails set, and that their surfaces are so adjusted by reefing, that their actions exactly balance each other round that point  $C$  of the middle line  $AB$ , where the actions of the water on the different parts of her bottom in like manner balance each other. This point  $C$  may be differently situated in the ship according to the leeway she makes, depending on the trim of the sails; and therefore although a certain proportion of the three surfaces may balance each other in one state of leeway, they may happen not to do so in another state. But the equilibrium is evidently attainable in every case, and we therefore shall always suppose it.

50  
Consequence of shifting it.

It must now be observed, that when this equilibrium is destroyed, as, for example, by turning the edge of the mizen-topfail to the wind, which the seamen call *shivering* the mizen-topfail, and which may be considered as equivalent to the removing the mizen-topfail entirely, it does not follow that the ship will round the point  $C$ , this point remaining fixed. The ship must be considered as a free body, still acted on by a number of forces, which no longer balance each other; and she must therefore *begin* to turn round a spontaneous axis of conversion, which must be determined in the way set forth in the article ROTATION. It is of importance to point out in general where this axis is situated. Therefore let  $G$  (fig. 1c.) be the centre of gravity of the ship. Draw the line  $qGv$  parallel to the yards, cutting  $Dd$  in  $q$ ,  $Ee$  in  $r$ ,  $CI$  in  $t$ , and  $Ff$  in  $v$ . While the three sails are set, the line  $qv$  may be considered as a lever acted on by four forces, *viz.*  $Dd$ , impelling the lever forward perpendicularly in the point  $q$ ;  $Ee$ , impelling it forward in the point  $r$ ;  $Ff$ , impelling it for-

ward in the point  $v$ ; and  $CI$ , impelling it backward in the point  $t$ . These forces balance each other both in respect of progressive motion and of rotatory energy: for  $CI$  was taken equal to the sum of  $Dd$ ,  $Ee$ , and  $Ff$ ; so that no acceleration or retardation of the ship's progress in her course is supposed.

But by taking away the mizen-topfail, both the equilibriums are destroyed. A part  $Dd$  of the accelerating force is taken away; and yet the ship, by her inertia or inherent force, tends, for a moment, to proceed in the direction  $Cp$  with her former velocity; and by this tendency exerts for a moment the same pressure  $CI$  on the water, and sustains the same resistance  $IC$ . She must therefore be retarded in her motion by the excess of the resistance  $IC$  over the remaining impelling forces  $Ee$  and  $Ff$ , that is, by a force equal and opposite to  $Dd$ . She will therefore be retarded in the same manner as if the mizen-topfail were still set, and a force equal and opposite to its action were applied to  $G$  the centre of gravity, and she would soon acquire a smaller velocity, which would again bring all things into equilibrium; and she would stand on in the same course, without changing either her leeway or the position of her head.

But the equilibrium of the lever is also destroyed. It is now acted on by three forces only, *viz.*  $Ee$  and  $Ff$ , impelling it forward in the points  $r$  and  $v$ , and  $IC$  impelling it backward in the point  $t$ . Make  $rv : ro :: Ee + Ff : Ff$ , and make  $op$  parallel to  $CI$  and equal to  $Ee + Ff$ . Then we know, from the common principles of mechanics, that the force  $op$  acting at  $o$  will have the same momentum or energy to turn the lever round any point whatever as the two forces  $Ee$  and  $Ff$  applied at  $r$  and  $v$ ; and now the lever is acted on by two forces, *viz.*  $IC$ , urging it backwards in the point  $t$ , and  $op$  urging it forwards in the point  $o$ . It must therefore turn round like a floating log, which gets two blows in opposite directions. If we now make  $IC - op : op :: to : tx$ , or  $IC - op : IC :: to : ox$ , and apply to the point  $x$  a force equal to  $IC - op$  in the direction  $IC$ ; we know, by the common principles of mechanics, that this force  $IC - op$  will produce the same rotation round any point as the two forces  $IC$  and  $op$  applied in their proper directions at  $t$  and  $o$ . Let us examine the situation of the point  $x$ .

The force  $IC - op$  is evidently  $= Dd$ , and  $op$  is  $= Ee + Ff$ . Therefore  $ot : tx :: Dd : op$ . But because, when all the sails were filled, there was an equilibrium round  $C$ , and therefore round  $t$ , and because the force  $op$  acting at  $o$  is equivalent to  $Ee$  and  $Ff$  acting at  $r$  and  $v$ , we must still have the equilibrium; and therefore we have the momentum  $Dd \times qt = op \times ot$ . Therefore  $ot : tq = Dd : op$ , and  $tq = tx$ . Therefore the point  $x$  is the same with the point  $q$ .

Therefore, when we shiver the mizen-topfail, the rotation of the ship is the same as if the ship were at rest, and a force equal and opposite to the action of the mizen-topfail were applied at  $q$  or at  $D$ , or at any point in the line  $Dq$ .

This might have been shown in another and shorter way. Suppose all sails filled, the ship is in equilibrio. This will be disturbed by applying to  $D$  a force opposite to  $Dd$ ; and if the force be also equal to  $Dd$ , it is evident that these two forces destroy each other, and that this application of the force  $dD$  is equivalent to the

the

51  
By shivering the mizen-topfail.

the taking away of the mizen-topfail. But we chose to give the whole mechanical investigation; because it gave us an opportunity of pointing out to the reader, in a case of very easy comprehension, the precise manner in which the ship is acted on by the different fails and by the water, and what share each of them has in the motion ultimately produced. We shall not repeat this manner of procedure in other cases, because a little reflection on the part of the reader will now enable him to trace the *modus operandi* through all its steps.

We now see that, in respect both of progressive motion and of conversion, the ship is affected by shivering the fail  $D$ , in the same manner as if a force equal and opposite to  $Dd$  were applied at  $D$ , or at any point in the line  $Dd$ . We must now have recourse to the principles established under the article ROTATION.

Let  $p$  represent a particle of matter,  $r$  its radius vector, or its distance  $pG$  from an axis passing through the centre of gravity  $G$ , and let  $M$  represent the whole quantity of matter of the ship. Then its momentum of inertia is  $= \int p.r^2$  (see ROTATION, n<sup>o</sup> 18.) The ship, impelled in the point  $D$  by a force in the direction  $dD$ , will begin to turn round a spontaneous vertical axis, passing through a point  $S$  of the line  $qG$ , which is drawn through the centre of gravity  $G$ , perpendicular to the direction  $dD$  of the external force, and the distance  $GS'$  of this axis from the centre of gra-

avity is  $= \frac{\int p.r^2}{M.Gq}$  (see ROTATION, n<sup>o</sup> 96.), and it is taken on the opposite side of  $G$  from  $q$ , that is,  $S$  and  $q$  are on opposite sides of  $G$ .

Let us express the external force by the symbol  $F$ . It is equivalent to a certain number of pounds, being the pressure of the wind moving with the velocity  $V$  and inclination  $a$  on the surface of the fail  $D$ ; and may therefore be computed either by the theoretical or experimental law of oblique impulses. Having obtained this, we can ascertain the angular velocity of the rotation and the absolute velocity of any given point of the ship by means of the theorems established in the article ROTATION.

But before we proceed to this investigation, we shall consider the action of the rudder, which operates precisely in the same manner. Let the ship  $AB$  (fig. 11.) have her rudder in the position  $AD$ , the helm being hard a-starboard, while the ship sailing on the starboard tack, and making leeway, keeps on the course  $ab$ . The lee surface of the rudder meets the water obliquely. The very foot of the rudder meets it in the direction  $DE$  parallel to  $ab$ . The parts farther up meet it with various obliquities, and with various velocities, as it glides round the bottom of the ship and falls into the wake. It is absolutely impossible to calculate the accumulated impulse. We shall not be far mistaken in the deflection of each contiguous filament, as it quits the bottom and glides along the rudder; but we neither know the velocity of these filaments, nor the deflection and velocity of the filaments gliding without them. We therefore imagine that all computations on this subject are in vain. But it is enough for our purpose that we know the direction of the absolute pressure which they exert on its surface. It is in the direction  $Dd$ , perpendicular to that surface. We also may be confident that this pressure is very consider-

able, in proportion to the action of the water on the ship's bows, or of the wind on the sails; and we may suppose it to be nearly in the proportion of the square of the velocity of the ship in her course; but we cannot affirm it to be accurately in that proportion, for reasons that will readily occur to one who considers the way in which the water falls in behind the ship.

It is observed, however, that a fine failer always <sup>53</sup>Great fit in steers well, and that all movements by means of the <sup>4</sup> fine failer.

rudder are performed with great rapidity when the velocity of the ship is great. We shall see by and by, that the speed with which the ship performs the angular movements is in the proportion of her progressive velocity: For we shall see that the squares of the times of performing the evolution are as the impulses inversely, which are as the squares of the velocities. There is perhaps no force which acts on a ship that can be more accurately determined by experiment than this.

Let the ship ride in a stream or tideway whose velocity is accurately measured; and let her ride from two moorings, so that her bow may be a fixed point. Let a small tow-line be laid out from her stern or quarter at right angles to the keel, and connected with some apparatus fitted up on shore or on board another ship, by which the strain on it may be accurately measured; a person conversant with mechanics will see many ways in which this can be done. Perhaps the following may <sup>54</sup>How to de-

be as good as any: Let the end of the tow-line be fixed <sup>54</sup>termine it.

to some point as high out of the water as the point of the ship from which it is given out, and let this be very high. Let a block with a hook be on the rope, and a considerable weight hung on this hook. Things being thus prepared, put down the helm to a certain angle, so as to cause the ship to sheer off from the point to which the far end of the tow-line is attached. This will stretch the rope, and raise the weight out of the water.

Now heave upon the rope, to bring the ship back again to her former position, with her keel in the direction of the stream. When this position is attained, note carefully the form of the rope, that is, the angle which its two parts make with the horizon. Call this angle  $a$ . Every person acquainted with these subjects knows that the horizontal strain is equal to half the weight multiplied by the cotangent of  $a$ , or that 2 is to the cotangent of  $a$  as the weight to the horizontal strain.

Now it is this strain which balances and therefore measures the action of the rudder, or  $Dd$  in fig. 11. Therefore, to have the absolute impulse  $Dd$ , we must increase  $Dd$  in the proportion of radius to the secant of the angle  $b$  which the rudder makes with the keel. In a great ship sailing six miles in an hour, the impulse on the rudder inclined  $30^\circ$  to the keel is not less than 3000 pounds. The surface of the rudder of such a ship contains near 80 square feet. It is not, however, very necessary to know this absolute impulse  $Dd$ , because it is its part  $De$  alone which measures the energy of the rudder in producing a conversion. Such experiments, made with various positions of the rudder, will give its energies corresponding to these positions, and will settle that long disputed point which is the best position for turning a ship. On the hypothesis that the impulses of fluids are in the duplicate ratio of the sines of incidence, there can be no doubt that it should make an angle of  $54^\circ 44'$  with the keel. But the form of a large ship will not admit of this, because a tiller of a length sufficient for managing the rudder in sailing <sup>with</sup>

with great velocity has not room to deviate above 30° from the direction of the keel; and in this position of the rudder the mean obliquity of the filaments of water to its surface cannot exceed 40° or 45°. A greater angle would not be of much service, for it is never for want of a proper obliquity that the rudder fails of producing a conversion.

55  
Why a ship  
misses stays,  
&c.

A ship misses stays in rough weather for want of a sufficient progressive velocity, and because her bows are beat off by the waves: and there is seldom any difficulty in wearing the ship, if she has any progressive motion. It is, however, always desirable to give the rudder as much influence as possible. Its surface should be enlarged (especially below) as much as can be done consistently with its strength and with the power of the steersmen to manage it; and it should be put in the most favourable situation for the water to get at it with great velocity; and it should be placed as far from the axis of the ship's motion as possible. These points are obtained by making the stern-post very upright, as has always been done in the French dockyards. The British ships have a much greater rake; but our builders are gradually adopting the French forms, experience having taught us that their ships, when in our possession, are much more obedient to the helm than our own.— In order to ascertain the motion produced by the action of the rudder, draw from the centre of gravity a line  $Gg$  perpendicular to  $Dd$  ( $Dd$  being drawn thro' the centre of effort of the rudder). Then, as in the consideration of the action of the sails, we may conceive the line  $gG$  as a lever connected with the ship, and impelled by a force  $Dd$  acting perpendicularly at  $g$ . The consequence of this will be, an incipient conversion of the ship about a vertical axis passing through some point  $S$  in the line  $gG$ , lying on the other side of  $G$  from  $g$ ; and we have, as in the former case,  $GS =$

$$\frac{\int \rho \cdot r^2}{M \cdot Gg}$$

56  
The action  
of the rudder  
similar  
to that of  
the sails,  
and very  
great.

Thus the action and effects of the sails and of the rudder are perfectly similar, and are to be considered in the same manner. We see that the action of the rudder, though of a small surface in comparison of the sails, must be very great: For the impulse of water is many hundred times greater than that of the wind; and the arm  $gG$  of the lever, by which it acts, is incomparably greater than that by which any of the impulsions on the sails produces its effect; accordingly the ship yields much more rapidly to its action than she does to the lateral impulse of a sail.

Observe here, that if  $G$  were a fixed or supported axis, it would be the same thing whether the absolute force  $Dd$  of the rudder acts in the direction  $Dd$ , or its transverse part  $De$  acts in the direction  $De$ , both would produce the same rotation; but it is not so in a free body. The force  $Dd$  both tends to retard the ship's motion and to produce a rotation: It retards it as much as if the same force  $Dd$  had been immediately applied to the centre. And thus the real motion of the ship is compounded of a motion of the centre in a direction parallel to  $Dd$ , and of a motion round the centre. These two constitute the motion round  $S$ .

57  
Employed  
as an exam-  
ple of the  
motions of  
conversion.

As the effects of the action of the rudder are both more remarkable and somewhat more simple than those of the sails, we shall employ them as an example of the mechanism of the motions of conversion in general; and as we must content ourselves in a work like this with

what is very general, we shall simplify the investigation by attending only to the motion of conversion. We can get an accurate notion of the whole motion, if wanted for any purpose, by combining the progressive or retrograde motion parallel to  $Dd$  with the motion of rotation which we are about to determine.

In this case, then, we observe, in the first place, that the angular velocity (see ROTATION, n° 22.) is  $\frac{Dh \cdot qG}{\int \rho r^2}$

and, as was shown in that article, this velocity of rotation increases in the proportion of the time of the forces uniform action, and the rotation would be uniformly accelerated if the forces did really act uniformly. This, however, cannot be the case, because, by the ship's change of position and change of progressive velocity, the direction and intensity of the impelling force is continually changing. But if two ships are performing similar evolutions, it is obvious that the changes of force are similar in similar parts of the evolution. Therefore the consideration of the momentary evolution is sufficient for enabling us to compare the motions of ships actuated by similar forces, which is all we have in view at present.

The velocity  $v$ , generated in any time  $t$  by the continuance of an invariable momentary acceleration (which is all that we mean by saying that it is produced by the action of a constant accelerating force), is as the acceleration and the time jointly. Now what we call the angular velocity is nothing but this momentary acceleration. Therefore the velocity  $v$  generated in the time

$$t \text{ is } = \frac{F \cdot qG}{\int \rho r^2} t.$$

The expression of the angular velocity is also the expression of the velocity  $v$  of a point situated at the distance  $t$  from the axis  $G$ .

Let  $z$  be the space or arch of revolution described in the time  $t$  by this point, whose distance from  $G$  is  $t$ . Then  $z = v t = \frac{F \cdot qG}{\int \rho r^2} t^2$ , and taking the

fluent  $z = \frac{F \cdot qG}{\int \rho r^2} t^2$ . This arch measures the whole angle of rotation accomplished in the time  $t$ . These are therefore as the squares of the times from the beginning of the rotation.

Those evolutions are equal which are measured by equal arches. Thus two motions of 45 degrees each are equal. Therefore because  $z$  is the same in both,

the quantity  $\frac{F \cdot qG}{\int \rho r^2} t^2$  is a constant quantity, and  $t^2$  is

reciprocally proportional to  $\frac{F \cdot qG}{\int \rho r^2}$ , or is proportional to  $\frac{\int \rho r^2}{F \cdot qG}$ , and  $t$  is proportional to  $\frac{\sqrt{\int \rho r^2}}{\sqrt{F \cdot qG}}$ . That

is to say, the times of the similar evolutions of two ships are as the square root of the momentum of inertia directly, and as the square root of the momentum of the rudder or sail inversely. This will enable us to make the comparison easily. Let us suppose the ships perfectly similar in form and rigging, and to differ only in length  $L$  and  $l$ ;  $\int P \cdot R^2$  is to  $\int \rho r^2$  as  $L^5$  to  $l^5$ .

For

For the similar particles P and p contain quantities of matter which are as the cubes of their lineal dimensions, that is, as  $L^3$  to  $l^3$ . And because the particles are similarly situated,  $R^2$  is to  $r^2$  as  $L^2$  to  $l^2$ . Therefore  $P \cdot R^2 : p \cdot r^2 = L^5 : l^5$ . Now F is to f as  $L^2$  to  $l^2$ . For the surfaces of the similar rudders or sails are as the squares of their lineal dimensions, that is, as  $L^2$  to  $l^2$ . And, lastly, G q is to g q as L to l, and therefore  $F \cdot G q : f \cdot g q = L^3 : l^3$ . Therefore we have  $T^2 :$

$$t^2 = \frac{F \cdot R^2}{F \cdot G q} : \frac{f \cdot r^2}{f \cdot g q} = \frac{L^5}{L^3} : \frac{l^5}{l^3} = L^2 : l^2, \text{ and } T : t = L : l.$$

Therefore the times of performing similar evolutions with similar ships are proportional to the lengths of the ships when both are sailing equally fast; and since the evolutions are similar, and the forces vary similarly in their different parts, what is here demonstrated of the smallest incipient evolutions is true of the whole. They therefore not only describe equal angles of revolution, but also similar curves.

A small ship, therefore, works in less time and in less room than a great ship, and this in the proportion of its length. This is a great advantage in all cases, particularly in wearing, in order to sail on the other tack close-hauled. In this case she will always be to windward and ahead of the large ship, when both are got on the other tack. It would appear at first sight that the large ship will have the advantage in tacking. Indeed the large ship is farther to windward when again trimmed on the other tack than the small ship when she is just trimmed on the other tack. But this happened before the large ship had completed her evolution, and the small ship, in the mean time, has been going forward on the other tack, and going to windward. She will therefore be before the large ship's beam, and perhaps as far to windward.

We have seen that the velocity of rotation is proportional, *cæteris paribus*, to  $F \times G q$ . F means the absolute impulse on the rudder or sail, and is always perpendicular to its surface. This absolute impulse on a sail depends on the obliquity of the wind to its surface. The usual theory says, that it is as the square of the sine of incidence: but we find this not true. We must content ourselves with expressing it by some as yet unknown function  $\tau$  of the angle of incidence  $a$ , and call it  $\tau a$ ; and if S be the surface of the sail, and V the velocity of the wind, the absolute impulse is  $n V^2 S \times \tau a$ . This acts (in the case of the mizen-top-sail, fig. 1c.) by the lever  $q G$ , which is equal to  $D G \times \text{cof. } D G q$ , and  $D G q$  is equal to the angle of the yard and keel; which angle we formerly called  $b$ . Therefore its energy in producing a rotation is  $n V^2 S \times \tau a \times D G \times \text{cof. } b$ . Leaving out the constant quantities  $n, V^2, S,$  and  $D G$ , its energy is proportional to  $\tau a \times \text{cof. } b$ . In order, therefore, that any sail may have the greatest power to produce a rotation round G, it must be so trimmed that  $\tau a \times \text{cof. } b$  may be a maximum. Thus, if we would trim the sails on the foremast, so as to pay the ship off from the wind right ahead with the greatest effect, and if we take the experiments of the French academicians as proper measures of the oblique impulses of the wind on the sail, we will brace up the yard to an angle of 48 degrees with the keel. The impulse corresponding to 48 is 615, and the cosine of 48° is 669. These give a product of 411435. If we brace the sail

to 54.44, the angle assigned by the theory, the effective impulse is 405274. If we make the angle 45°, the impulse is 408774. It appears then that 48° is preferable to either of the others. But the difference is inconsiderable, as in all cases of maximum a small deviation from the best position is not very detrimental. But the difference between the theory and this experimental measure will be very great when the impulses of the wind are of necessity very oblique. Thus, in tacking ship, as soon as the headsails are taken aback, they serve to aid the evolution, as is evident: But if we were now to adopt the maxim inculcated by the theory, we should immediately round in the weather-braces, so as to increase the impulse on the sail, because it is then very small; and although we by this means make yard more square, and therefore diminish the rotatory momentum of this impulse, yet the impulse is more increased (by the theory) than its vertical lever is diminished. — Let us examine this a little more particularly, because it is reckoned one of the nicest points of seamanship to aid the ship's coming round by means of the headsails; and experienced seamen differ in their practice in this manœuvre. Suppose the yard braced up to 45°, which is as much as can be usually done, and that the sail shivers (the bowlines are usually let go when the helm is put down), the sail immediately takes aback, and in a moment we may suppose an incidence of 6 degrees. The impulse corresponding to this is 400 (by experiment), and the cosine of 45° is 766. This gives 306400 for the effective impulse. To proceed according to the theory, we should brace the yard to 70°, which would give the wind (now 34° on the weather-bow) an incidence of nearly 36°, and the sail an inclination of 20° to the intended motion, which is perpendicular to the keel. For the tangent of 20° is about  $\frac{1}{2}$  of the tangent of 36°. Let us now see what effective impulse the experimental law of oblique impulses will give for this adjustment of the sails. The experimental impulse for 36° is 480; the cosine of 70° is 342; the product is 164160, not much exceeding the half of the former. Nay, the impulse for 36°, calculated by the theory, would have been only 346, and the effective impulse only 118332. And it must be farther observed, that this theoretical adjustment would tend greatly to check the evolution, and in most cases would entirely mar it, by checking the ship's motion ahead, and consequently the action of the rudder, which is the most powerful agent in the evolution; for here would be a great impulse directed almost astern.

We were justifiable, therefore, in saying, in the beginning of this article, that a seaman would frequently find himself baffled if he were to work a ship according to the rules deduced from M. Bouguer's work; and we see by this instance of what importance it is to have the oblique impulses of fluids ascertained experimentally. The practice of the most experienced seaman is directly the opposite to this theoretical maxim, and its success greatly confirms the usefulness of these experiments of the academicians so often praised by us.

We return again to the general consideration of the rotatory motion. We found the velocity  $v = \frac{F \cdot q G}{\int \rho r^2}$ . It is therefore proportional, *cæteris paribus*, to  $q G$ . We have seen in what manner  $q G$  depends on the position

60  
A nice point  
of seamanship.

59  
nes of fi-  
ar evo-  
ons with  
ilar

tion and situation of the sail or rudder when the point G is fixed. But it also depends on the position of G. With respect to the action of the rudder, it is evident that it is so much the more powerful as it is more remote from G. The distance from G may be increased either by moving the rudder farther aft or G farther forward. And as it is of the utmost importance that a ship answer her helm with the greatest promptitude, those circumstances have been attended to which distinguished fine steering ships from such as had not this quality; and it is in a great measure to be ascribed to this, that, in the gradual improvement of naval architecture, the centre of gravity has been placed far forward. Perhaps the notion of a centre of gravity did not come into the thoughts of the rude builders in early times; but they observed that those boats and ships steered best which had their extreme breadth before the middle point, and consequently the bows not so acute as the stern. This is so contrary to what one would expect, that it attracted attention more forcibly; and, being somewhat mysterious, it might prompt to attempts of improvement, by exceeding in this singular maxim. We believe that it has been carried as far as is compatible with other essential requisites in a ship.

61  
Of importance to determine the best place for a ship's centre of gravity.

We believe that this is the chief circumstance in what is called the trim of a ship; and it were greatly to be wished that the best place for the centre of gravity could be accurately ascertained. A practice prevails, which is the opposite of what we are now advancing. It is usual to load a ship so that her keel is not horizontal, but lower abaft. This is found to improve her steerage. The reason of this is obvious. It increases the acting surface of the rudder, and allows the water to come at it with much greater freedom and regularity; and it generally diminishes the gripping of the ship forward, by removing a part of the bows out of the water. It has not always this effect; for the form of the harping aloft is frequently such, that the tendency to gripe is diminished by immersing more of the bow in the water.

But waving these circumstances, and attending only to the rotatory energy of the rudder, we see that it is of advantage to carry the centre of gravity forward. The same advantage is gained to the action of the after sails. But, on the other hand, the action of the head sails is diminished by it; and we may call every sail a head sail whose centre of gravity is before the centre of gravity of the ship; that is, all the sails hoisted on the bowsprit and foremast, and the stay sails hoisted on the mainmast; for the centre of gravity is seldom far before the mainmast.

Suppose that when the rudder is put into the position AD (fig. 11.), the centre of gravity could be shifted to g, so as to increase qG, and that this is done without increasing the sum of the products pr<sup>2</sup>. It is obvious that the velocity of conversion will be increased in the proportion of qG to qg. This is very possible, by bringing to that side of the ship parts or her loading which were situated at a distance from G on the other side. Nay, we can make this change in such a manner that ∫pr<sup>2</sup> shall even be less than it was before, by taking care that every thing which we shift shall be nearer to g than it was formerly to G. Suppose it all placed in one spot m, and that m is the quantity of matter so shifted, while M is the quantity of matter in the whole ship.

It is only necessary that m · g G<sup>2</sup> shall be less than the sum of the products pr<sup>2</sup> corresponding to the matter which has been shifted. Now, although the matter which is easily moveable is generally very small in comparison to the whole matter of the ship, and therefore can make but a small change in the place of the centre of gravity, it may frequently be brought from places so remote, that it may occasion a very sensible diminution of the quantity ∫pr<sup>2</sup>, which expresses the whole momentum of inertia.

This explains a practice of the seamen in small wherries or skiffs, who in putting about are accustomed to place themselves to leeward of the mast. They even find that they can aid the quick motions of these light boats by the way in which they rest on their two feet, sometimes leaning all on one foot, and sometimes on the other. And we have often seen this evolution very sensibly accelerated in a ship of war, by the crew running suddenly, as the helm is put down, to the lee-bow. And we have heard it asserted by very expert seamen, that after all attempts to wear ship (after lying-to in a storm) have failed, they have succeeded by the crew collecting themselves near the weather fore-threads the moment the helm was put down. It must be agreeable to the reflecting seaman to see this practice supported by undoubted mechanical principles.

62  
A practice of seamen in putting about explained.

It will appear paradoxical to say that the evolution may be accelerated even by an addition of matter to the ship; and though it is only a piece of curiosity, our readers may wish to be made sensible of it. Let m be the addition, placed in some point m lying beyond G from g. Let S be the spontaneous centre of conversion before the addition. Let v be the velocity of rotation round g, that is, the velocity of a point whose distance from g is 1, and let r be the radius vector, or distance of a particle from g. We have (ROTATION, n<sup>o</sup> 22.) v =  $\frac{F \cdot qg}{\int pr^2 + m \cdot g^2}$ . But we know (ROTATION, n<sup>o</sup> 23.)

63  
The evolution accelerated by additional matter.

that  $\int pr^2 = \int p r^2 + M \cdot G g^2$ . Therefore v =  $\frac{F \cdot qg}{\int pr^2 + M \cdot G g^2 + m \cdot m g^2}$ . Let us determine Gg and mg and qg.

Let mG be called z. Then, by the nature of the centre of gravity, M + m : M = Gm : gm = z : gm, and gm =  $\frac{M}{M+m} z$ , and m · gm<sup>2</sup> =  $\frac{m M^2}{M+m} z^2$ . In like manner, M · Gg<sup>2</sup> =  $\frac{M m^2}{M+m} z^2$ . Now mM<sup>2</sup> + Mm<sup>2</sup> = Mm × M + m. Therefore M · Gg<sup>2</sup> + m · gm<sup>2</sup> =  $\frac{Mm \times (M+m)}{M+m} z^2$ , =  $\frac{Mm}{M+m} z^2$ . Let n be =  $\frac{m}{M+m}$ , then M · Gg<sup>2</sup> + m · gm<sup>2</sup> = Mnz<sup>2</sup>. Also Gg = nz, being =  $\frac{m}{M+n} z$ . Let qG be called c: then qg = c + nz. Also let SG be called e.

We have now for the expression of the velocity v =  $\frac{F(c+nz)}{\int pr^2 + M n z^2}$ , or v =  $\frac{F}{M} \times \frac{c+nz}{\int pr^2 + n z^2}$ . But



(ROTATION,  $\pi 30$ )  $\frac{\int \rho r^2}{M} = ce$ . Therefore, finally,  $v =$

$$\frac{F}{M} \times \frac{c+nz}{ce+nz^2}$$

Had there been no addition of matter made, we should have had  $v = \frac{F}{M} \times \frac{c}{ce}$ . It remains to

show, that  $z$  may be so taken that  $\frac{c}{ce}$  may be less than

$$\frac{c+nz}{ce+nz^2}$$

Now, if  $c$  be to  $z$  as  $ce$  to  $z^2$ , that is, if  $z$  be taken equal to  $e$ , the two fractions will be equal. But if  $z$  be less than  $e$ , that is, if the additional matter is placed anywhere between  $S$  and  $G$ , the complex frac-

tion will be greater than the fraction  $\frac{c}{ce}$ , and the velocity of rotation will be increased. There is a particular distance which will make it the greatest possible, namely, when  $z$  is made  $= \frac{1}{n} (\sqrt{c^2 + nce} - c)$ , as will

easily be found by treating the fraction  $\frac{c+nz}{ce+nz^2}$ , with

$z$ , considered as the variable quantity, for a maximum.

In what we have been saying on this subject, we have considered the rotation only in as much as it is performed round the centre of gravity, although in every moment it is really performed round a spontaneous axis lying beyond that centre. This was done because it afforded an easy investigation, and any angular motion round the centre of gravity is equal to the angular motion round any other point. Therefore the extent and the time of the evolution are accurately defined.—

From observing that the energy of the force  $F$  is proportional to  $qG$ , an inattentive reader will be apt to conceive the centre of gravity as the centre of motion, and the rotation as taking place because the momenta of the sails and rudder, on the opposite sides of the centre of gravity, do not balance each other. But we must always keep in mind that this is not the cause of the rotation. The cause is the want of equilibrium round the point  $C$  (fig. 10.), where the actions of the water balance each other. During the evolution, which consists of a rotation combined with a progressive motion, this point  $C$  is continually shifting, and the unbalanced momenta which continue the rotation always respect the momentary situation of the point  $C$ . It is nevertheless always true that the energy of a force  $F$  is proportional (*ceteris paribus*) to  $qG$ , and the rotation is always made in the same direction as if the point  $G$  were really the centre of conversion. Therefore the main-sail acts always (when oblique) by pushing the stern away from the wind, although it should sometimes act on a point of the vertical lever through  $C$ , which is a-head of  $C$ .

These observations on the effects of the sails and rudder in producing a conversion, are sufficient for enabling us to explain any case of their action which may occur. We have not considered the effects which they tend to produce by inclining the ship round a horizontal axis, viz. the motions of rolling and pitching. See ROLLING and PITCHING. To treat this subject properly would lead us into the whole doctrine of the equilibrium of floating bodies, and it would rather lead to maxims of construction than to maxims of manœuvre. M. Bouguer's *Traité du Navire* and Euler's *Scientia Navalis* are excellent performances on this subject,

and we are not here obliged to have recourse to any erroneous theory.

It is easy to see that the lateral pressure both of the wind on the sails and of the water on the rudder tends to incline the ship to one side. The sails also tend to press the ship's bows into the water, and, if she were kept from advancing, would press them down considerably. But by the ship's motion, and the prominent form of her bows, the resistance of the water to the fore part of the ship produces a force which is directed upwards. The sails also have a small tendency to raise the ship, for they constitute a surface which in general separates from the plumb-line below. This is remarkably the case in the stay-sails, particularly the jib and fore-topmast stay-sail. And this helps greatly to soften the plunges of the ship's bows into the head seas. The upward pressure also of the water on her bows, which we just now mentioned, has a great effect in opposing the immersion of the bows which the sails produce by acting on the long levers furnished by the masts. M. Bouguer gives the name of *point velique* to the point  $V$  (fig. 12.) of the mast, where it is cut by the line  $CV$ , which marks the mean place and direction of the whole impulse of the water on the bows. And he observes, that if the mean direction of all the actions of the wind on the sails be made to pass also through this point, there will be a perfect equilibrium, and the ship will have no tendency to plunge into the water or to rise out of it; for the whole action of the water on the bows, in the direction  $CV$ , is equivalent to, and may be resolved into the action  $CE$ , by which the progressive motion is resisted, and the vertical action  $CD$ , by which the ship is raised above the water. The force  $CE$  must be opposed by an equal force  $VD$ , exerted by the wind on the sails, and the force  $CD$  is opposed by the weight of the ship. If the mean effort of the sails passes above the point  $V$ , the ship's bows will be pressed into the water; and if it pass below  $V$ , her stern will be pressed down. But, by the union of these forces, she will rise and fall with the sea, keeping always in a parallel position. We apprehend that it is of very little moment to attend to the situation of this point. Except when the ship is right afore the wind, it is a thousand chances to one that the line  $CV$  of mean resistance does not pass through any mast; and the fact is, that the ship cannot be in a state of uniform motion on any other condition but the perfect union of the line of mean action of the sails, and the line of mean action of the resistance. But its place shifts by every change of leeway or of trim; and it is impossible to keep these lines in one constant point of intersection for a moment, on account of the incessant changes of the surface of the water on which the floats. M. Bouguer's observations on this point are, however, very ingenious and original.

We conclude this dissertation, by describing some of the chief movements or evolutions. What we have said hitherto is intended for the instruction of the artist, by making him sensible of the mechanical procedure. The description is rather meant for the amusement of the landman, enabling him to understand operations that are familiar to the seaman. The latter will perhaps smile at the awkward account given of his business by one who cannot head, reef, nor steer.

To tack Ship.

THE ship must first of all be kept full, that is, with

65  
Different operations of the water on the ship and wind on the sails balance each other.

64  
The rotation performed round a constant axis.

66  
Chief evolutions described.

a very sensible angle of incidence on the sails, and by no means lugging the wind. For as this evolution is chiefly performed by the rudder, it is necessary to give the ship a good velocity. When the ship is observed to luff up of herself, that moment is to be caught for beginning the evolution, because she will by her inherent force continue this motion. The helm is then put down. When the officer calls out Helm's a lee, the fore-sheet, fore-top bowline, jib, and flag sail sheets forward are let go. The jib is frequently hauled down. Thus the obstacles to the ship's head coming up to the wind by the action of the rudder are removed. If the mainfail is set, it is not unusual to clue up the weather side, which may be considered as a headfail, because it is before the centre of gravity. The mizen must be hauled out, and even the fail braced to windward. Its power in paying off the stern from the wind conspires with the action of the rudder. It is really an aerial rudder. The fails are immediately taken aback. In this state the effect of the mizen-topfail would be to obstruct the movement, by pressing the stern the contrary way to what it did before. It is therefore either immediately braced about sharp on the other tack, or lowered. Braicing it about evidently tends to pay round the stern from the wind, and thus assist in bringing the head up to the wind. But in this position it checks the progressive motion of the ship, on which the evolution chiefly depends. For a rapid evolution, therefore, it is as well to lower the mizen-topfail. Meantime, the headfails are all aback, and the action of the wind on them tends greatly to pay the ship round. To increase this effect, it is not unusual to haul the fore-top bowline again. The fails on the mainmast are now almost becalmed; and therefore when the wind is right ahead, or a little before, the mainfail is hauled round and braced up sharp on the other tack with all expedition. The stayfail sheets are now shifted over to their places for the other tack. The ship is now entirely under the power of the headfails and of the rudder, and their actions conspire to promote the conversion. The ship has acquired an angular motion, and will preserve it, so that now the evolution is secured, and she falls off apace from the wind on the other tack. The farther action of the rudder is therefore unnecessary, and would even be prejudicial, by causing the ship to fall off too much from the wind before the fails can be shifted and trimmed for falling on the other tack. It is therefore proper to right the helm when the wind is right ahead, that is, to bring the rudder into the direction of the keel. The ship continues her conversion by her inherent force and the action of the headfails.

When the ship has fallen off about four points from the wind, the headfails are hauled round, and trimmed sharp on the other tack with all expedition; and although this operation was begun with the wind four points on the bow, it will be six before the fails are braaced up, and therefore the headfails will immediately fill. The after-fails have filled already, while the headfails were inactive, and therefore immediately check the farther falling off from the wind. All fails now draw, for the stayfail sheets have been shifted over while they were becalmed or shaking in the wind. The ship now gathers way, and will obey the smallest motion of the helm to bring her close to the wind.

We have here supposed, that during all this operation the ship preserves her progressive motion. She

must therefore have described a curve line, advancing all the while to windward. Fig. 13. is a representation of this evolution when it is performed in the completest manner. The ship standing on the course  $Ea$ , with the wind blowing in the direction  $WF$ , has her helm put hard a-lee when she is in the position  $A$ . She immediately deviates from her course, and describing a curve, comes to the position  $B$ , with the wind blowing in the direction  $WF$  of the yards, and the square-fails now shiver. The mizen-topfail is here represented braced sharp on the other tack, by which its tendency to aid the angular motion (while it checks the progressive motion) is distinctly seen. The main and fore-fails are now shivering, and immediately after are taken aback. The effect of this on the headfails is distinctly seen to be favourable to the conversion, by pushing the point  $F$  in the direction  $Fi$ ; but for the same reason it continues to retard the progressive motion. When the ship has attained to the position  $C$ , the mainfail is hauled round and trimmed for the other tack. The impulse in the direction  $Fi$  still aids the conversion and retards the progressive motion. When the ship has attained a position between  $C$  and  $D$ , such that the main and mizen topfail yards are in the direction of the wind, there is nothing to counteract the force of the headfails to pay the ship's head off from the wind. Nay, during the progress of the ship to this intermediate position, if any wind gets at the main or mizen topfails, it acts on their anterior surfaces, and impels the after parts of the ship away from the curve  $abcd$ , and thus aids the revolution. We have therefore said, that when once the fails are taken fully aback, and particularly when the wind is brought right ahead, it is scarce possible for the evolution to fail; as soon therefore as the main-topfail (trimmed for the other tack) shivers, we are certain that the headfails will be filled by the time they are hauled round and trimmed. The stayfails are filled before this, because their sheets have been shifted, and they stand much sharper than the square-fails; and thus every thing tends to check the falling off from the wind on the other tack, and this no sooner than it should be done. The ship immediately gathers way, and holds on in her new course  $dC$ .

But it frequently happens, that in this conversion the ship loses her whole progressive motion. This sometimes happens while the fails are shivering before they are taken fully aback. It is evident, that in this case there is little hopes of success, for the ship now lies like a log, and neither sails nor rudder have any action. The ship drives to leeward like a log, and the water acting on the lee-side of the rudder checks a little the driving of the stern. The head therefore falls off again, and by and by the fails fill, and the ship continues on her former tack. This is called MISSING STAYS, and it is generally owing to the ship's having too little velocity at the beginning of the evolution. Hence the propriety of keeping the fails well filled for some little time before. Rough weather, too, by raising a wave which beats violently on the weather-bow, frequently checks the first luffing of the ship, and beats her off again.

If the ship loses all her motion after the headfails have been fully taken aback, and before we have brought the wind right ahead, the evolution becomes uncertain, but by no means desperate; for the action

of the wind on the headfairs will presently give her stern-way. Suppose this to happen when the ship is in the position C. Bring the helm over hard to windward, so that the rudder shall have the position represented by the small dotted line *of*. It is evident, that the resistance of the water to the stern-way of the rudder acts in a favourable direction, pushing the stern outwards. In the mean time, the action of the wind on the headfairs pushes the head in the opposite direction. These actions conspire therefore in promoting the evolution; and if the wind is right ahead, it cannot fail, but may even be completed speedily, because the ship gathers stern-way, and the action of the rudder becomes very powerful; and as soon as the wind comes on the formerly lee-bow, the action of the water on the now lee-quarter will greatly accelerate the conversion. When the wind therefore has once been brought nearly right ahead, there is no risk of being baffled.

But should the ship have lost all her head-way considerably before this, the evolution is very uncertain: for the action of the water on the rudder may not be nearly equal to its contrary action on the lee-quarter; in which case, the action of the wind on the headfairs may not be sufficient to make up the difference. When this is observed, when the ship goes astern without changing her position, we must immediately throw the headfairs completely aback, and put the helm down again, which will pay off the ship's head from the wind enough to enable us to fill the sails again on the same tack, to try our fortune again; or we must *BOUHAUL* the ship, in the manner to be described by and by.

Such is the ordinary process of tacking ship: a process in which all the different modes of action of the rudder and sails are employed. To execute this evolution in the most expeditious manner, and so as to gain as much on the wind as possible, is considered as the test of an expert seaman. We have described the process which is best calculated for *ensuring* the movement. But if the ship be failing very briskly in smooth water, so that there is no danger of missing stays, we may gain more to windward considerably by keeping fast the fore-top bowline and the jib and stay-fail sheets till the square-fails are all shivering: For these fails, continuing to draw with considerable force, and balancing each other tolerably fore and aft, keep up the ship's velocity very much, and thus maintain the power of the rudder. If we now let all fly when the square-fails are shivering, the ship may be considered as without fails, but exposed to the action of the water on the lee-bow; from which arises a strong pressure of the bow to windward, which conspires with the action of the rudder to aid the conversion. It evidently leaves all that tendency of the bow to windward which arises from leeway, and even what was counteracted by the formerly unbalanced action of these head-stayfairs. This method lengthens the whole time of the evolution, but it advances the ship to windward. Observe, too, that keeping fast the fore-top bowline till the fail shivers, and then letting it go, insures the taking aback of that fail, and thus instantly produces an action that is favourable to the evolution.

The most expert seamen, however, differ among themselves with respect to these two methods, and the first is the most generally practised in the British navy, because the least liable to fail. The forces which op-

pose the conversion are sooner removed, and the production of a favourable action by the backing of the fore-topfail is also sooner obtained, by letting go the fore-top bowline at the first.

Having entered so minutely into the description and rationale of this evolution, we have sufficiently turned the reader's attention to the different actions which cooperate in producing the motions of conversion. We shall therefore be very brief in our description of the other evolutions.

#### To wear Ship.

WHEN the seaman sees that his ship will not go a bout head to wind, but will miss stays, he must change his tack the other way; that is, by turning her head away from the wind, going a little way before the wind, and then hauling the wind on the other tack. This is called *WEARING* or *VEERING* ship. It is most necessary in stormy weather with little sail, or in very faint breezes, or in a disabled ship.

The process is exceedingly simple; and the mere narration of the procedure is sufficient for showing the propriety of every part of it.

Watch for the moment of the ship's falling off, and then haul up the mainfail and mizen, and shiver the mizen-topfail, and put the helm a-weather. When the ship falls off sensibly (and not before), let go the bowlines. Ease away the fore-sheet, raise the fore-tack, and gather aft the weather fore-sheet, as the lee-sheet is eased away. Round in the weather-braces of the fore and main masts, and keep the yards nearly bisecting the angle of the wind and keel, so that when the ship is before the wind the yards may be square. It may even be of advantage to round in the weather-braces of the main-topfail more than those of the headails; for the mainmast is abaft the centre of gravity. All this while the mizen-topfail must be kept shivering, by rounding in the weather-braces as the ship pays off from the wind. Then the main-topfail will be braced up for the other tack by the time that we have brought the wind on the weather-quarter. After this it will be full, and will aid the evolution. When the wind is right aft, shift the jib and stay-fail sheets. The evolution now goes on with great rapidity; therefore briskly haul on board the fore and main tacks, and haul out the mizen, and set the mizen-stayfail as soon as they will take the wind the right way. We must now check the great rapidity with which the ship comes to the wind on the other tack, by righting the helm before we bring the wind on the beam; and all must be trimmed sharp fore and aft by this time, that the headails may take and check the coming-to. All being trimmed, stand on close by the wind.

We cannot help losing a great deal of ground in this movement. Therefore, though it be very simple, it requires much attention and rapid execution to do it with as little loss of ground as possible. One is apt to imagine at first that it would be better to keep the headfairs braced up on the former tack, or at least not to round in the weather-braces so much as is here directed. When the ship is right afore the wind, we should expect assistance from the obliquity of the headfairs; but the rudder being the principal agent in the evolution, it is found that more is gained by increasing the ship's velocity, than by a smaller impulse on the head.

headfails more favourably directed. Experienced seamen differ, however, in their practice in respect of this particular.

*To boxhaul a Ship.*

THIS is a process performed only in critical situations, as when a rock, a ship, or some danger, is suddenly seen right ahead, or when a ship misses stays. It requires the most rapid execution.

The ship being close-hauled on a wind, haul up the mainfail and mizen, and shiver the topfails, and put the helm hard a-lee altogether. Raise the fore-tack, let go the head bowlines, and brace about the headfails sharp on the other tack. The ship will quickly lose her way, set stern-way, and then fall off, by the joint action of the headfails and of the inverted rudder. When she has fallen off eight points, brace the afterfails square, which have hitherto been kept shivering. This will at first increase the power of the rudder, by increasing the stern-way, and at the same time it makes no opposition to the conversion which is going on. The continuation of her circular motion will presently cause them to take the wind on their after surfaces. This will check the stern-way, stop it, and give the ship a little head-way. Now shift the helm, so that the rudder may again act in conjunction with the headfails in paying her off from the wind. This is the critical part of the evolution, because the ship has little or no way through the water, and will frequently remain long in this position. But as there are no counteracting forces, the ship continues to fall off. Then the weather-braces of the after-fails may be gently rounded in, so that the wind acting on their hinder surfaces may both push the ship a little ahead and her stern laterally in conjunction with the rudder. Thus the wind is brought upon the quarter, and the headfails shiver. By this time the ship has acquired some headway. A continuation of the rotation would now fill the headfails, and their action would be contrary to the intended evolution. They are therefore immediately braced the other way, nearly square, and the evolution is now completed in the same manner with wearing ship.

Some seamen brace all the fails aback the moment that the helm is put hard a-lee, but the after-fails no more aback than just to square the yards. This quickly gives the ship stern-way, and brings the rudder into action in its inverted direction; and they think that the evolution is accelerated by this method.

There is another problem of seamanship deserving of our attention, which cannot properly be called an evolution. This is lying-to. This is done in general by laying some fails aback, so as to stop the head-way produced by others. But there is a considerable address necessary for doing this in such a way that the ship shall lie easily, and under command, ready to proceed in her course, and easily brought under weigh.

To bring-to with the fore or main-topfail to the mast, brace that fail sharp aback, haul out the mizen, and clap the helm hard a-lee.

Suppose the fore topfail to be aback; the other fails shoot the ship ahead, and the lee helm makes the ship come up to the wind, which makes it come more perpendicularly on the fail which is aback. Then its impulse soon exceeds those on the other fails, which are now shivering, or almost shivering. The ship stands still

awhile, and then falls off, so as to fill the after-fails, which again shoot her ahead, and the process is thus repeated. A ship lying-to in this way goes a good deal ahead and also to leeward. If the main-topfail be aback, the ship shoots ahead, and comes up till the diminished impulse of the drawing fails in the direction of the keel is balanced by the increased impulse on the main-topfail. She lies a long while in this position, driving slowly to leeward; and she at last falls off by the beating of the water on her weather-bow. She falls off but little, and soon comes up again.

Thus a ship lying-to is not like a mere log, but has a certain motion which keeps her under command. To get under weigh again, we must watch the time of falling off; and when this is just about to finish, brace about briskly, and fill the fail which was aback. To aid this operation, the jib and fore-topmast stayfail may be hoisted, and the mizen brailed up: or, when the intended course is before the wind or large, back the fore-topfail sharp, shiver the main and mizen topfail, brail up the mizen, and hoist the jib and fore-topmast stay-fails altogether.

In a storm with a contrary wind, or on a lee shore, a ship is obliged to lie-to under a very low fail. Some fail is absolutely necessary, in order to keep the ship steadily down, otherwise she would kick about like a cork, and roll so deep as to strain and work herself to pieces. Different ships behave best under different fails. In a very violent gale, the three lower stayfails are in general well adapted for keeping her steady, and distributing the strain. This mode seems also well adapted for wearing, which may be done by hauling down the mizen-stayfail. Under whatever fail the ship is brought to in a storm, it is always with a fitted fail, and never with one laid aback. The helm is lashed down hard a-lee; therefore the ship shoots ahead, and comes up till the sea on her weather-bow beats her off again. Getting under weigh is generally difficult; because the ship and rigging are lofty abaft, and hinder her from falling off readily when the helm is put hard a-weather. We must watch the falling off, and assist the ship by some small headfail. Sometimes the crew get up on the weather fore-shrouds in a crowd, and thus present a surface to the wind.

THESE examples of the three chief evolutions will enable those who are not seamen to understand the propriety of the different steps, and also to understand the other evolutions as they are described by practical authors. We are not acquainted with any performance in our language where the whole are considered in a connected and systematic manner. There is a book on this subject in French, called *Le Manœuvrier*, by M. Bourdè de Ville-Huet, which is in great reputation in France. A translation into English was published some years ago, said to be the performance of the Chevalier de Saufenil a French officer. But this appears to be a bookfeller's puff; for it is undoubtedly the work of some person who did not understand either the French language, or the subject, or the mathematical principles which are employed in the scientific part. The blunders are not such as could possibly be made by a Frenchman not versant in the English language, but natural for an Englishman ignorant of French. No French gentleman or officer would have translated a work of

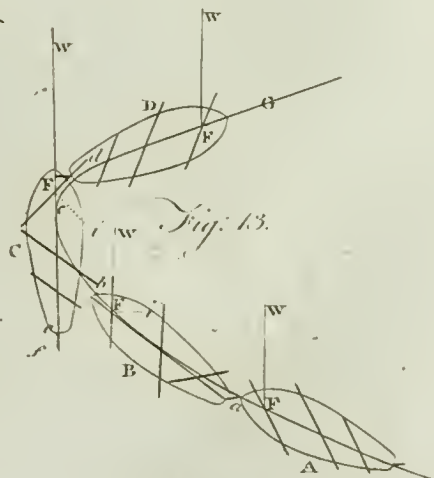
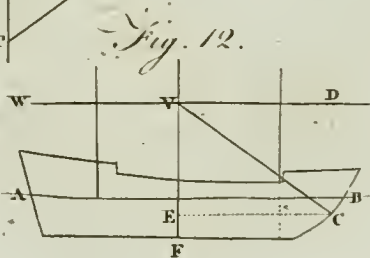
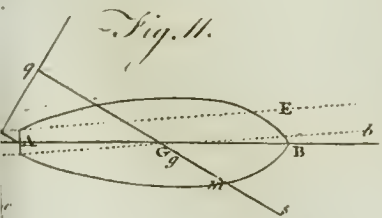
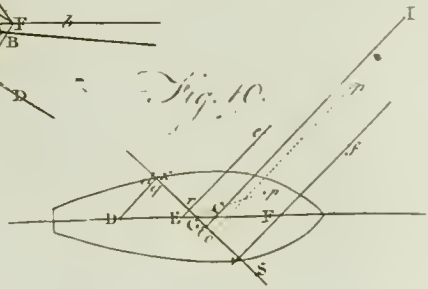
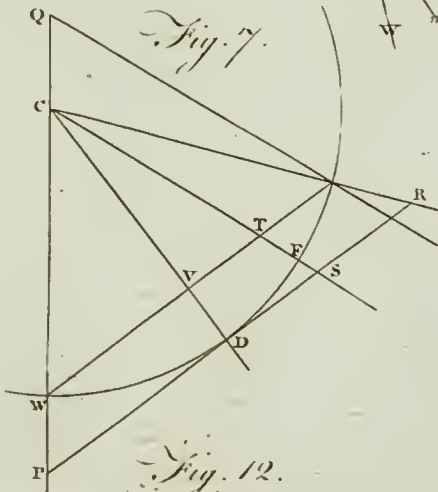
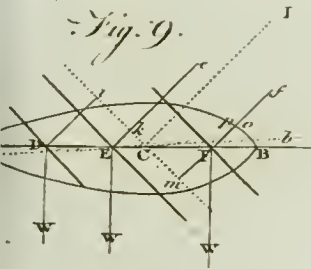
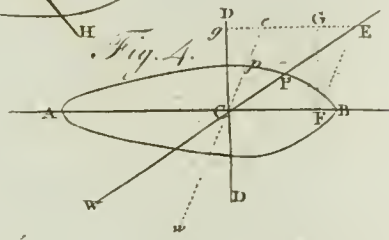
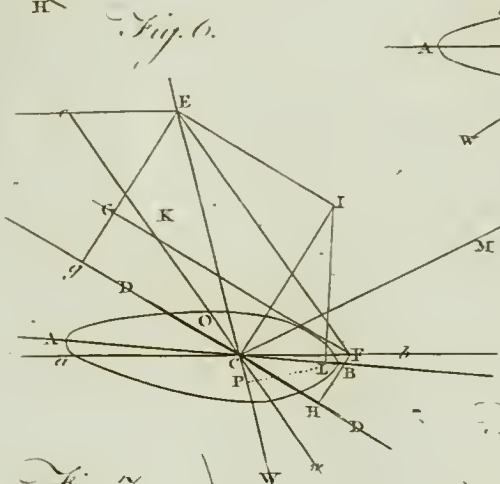
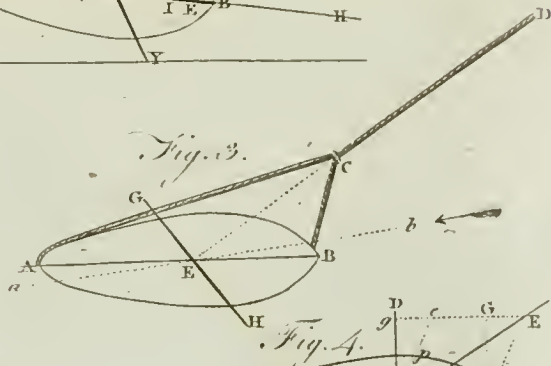
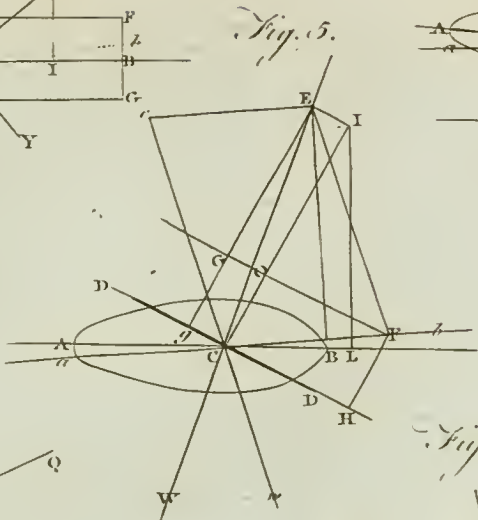
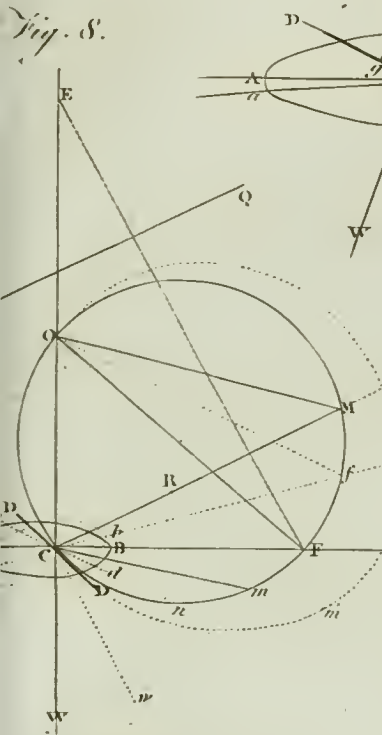
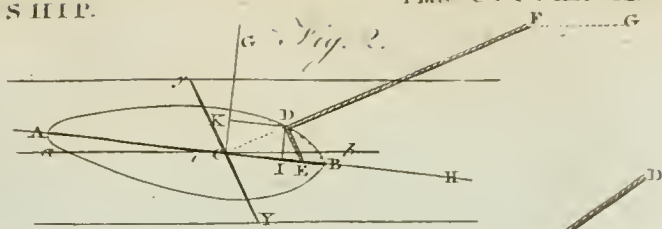
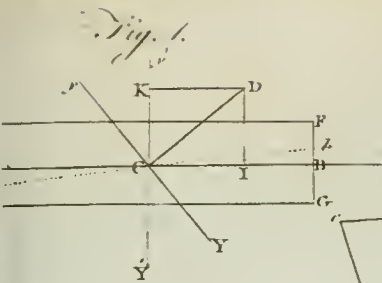

J. Bell, Pin. Wal. Sculptor fecit



this kind (which he professes to think so highly of) to serve the rivals and foes of his country. But indeed it can do no great harm in this way; for the scientific part of it is absolutely unintelligible for want of science in the translator; and the practical part is full of blunders for want of knowledge of the French language.

We offer this account of the subject with all proper respect and diffidence. We do not profess to teach: but by pointing out the defects of the celebrated works

of M. Bouguer, and the course which may be taken to remove them, while we preserve much valuable knowledge which they contain, we may perhaps excite some persons to apply to this subject, who, by a combination of what is just in M. Bouguer's theory, with an experimental doctrine of the impulses of fluids, may produce a treatise of seamanship which will not be confined to the libraries of mathematicians, but become a manual for seamen by profession.

## S E A

SEAMEN, such persons as serve the king or others at sea by navigation and fighting ships, &c. See *NAVY*.

Seamen fighting, quarrelling, or making any disturbances may be punished by the commissioners of the navy with fine and imprisonment. Registered seamen are exempted from serving in any parish, office, &c. and are allowed bounty-money beside their pay. By the law of merchants, the seamen of a vessel are accountable to the master or commander, the master to the owners, and the owners to the merchants, for damage sustained either by negligence or otherwise. Where a seaman is hired for a voyage, and he deserts before it is ended, he shall lose his wages; and in case a ship be lost in a storm, the seamen lose their wages, as well as the owners their freight.

*Means of Preserving the Health of SEAMEN.* See *MEDICINE*, n<sup>o</sup> 351.

In addition to what has been said on this subject in the place referred to, we shall subjoin some valuable observations which we have met with in the sixth volume of the *Memoirs of the Royal Society of Medicine at Paris* for the years 1784 and 1785.

In 1783, the marshal de Castries, intending to make some changes in the regulations of the navy, particularly with regard to diet, proposed to the society the two following questions: 1. "What are the most wholesome aliments for seamen, considering the impossibility of procuring them fresh meat? And what kinds of salt meat, or fish, of pulse, and of drink, are most proper for them, and in what quantity, not omitting to inquire into the regimens in use amongst other maritime nations for what may be adopted by us, and into what experience has evinced the utility of, from the accounts of the most celebrated navigators?" 2. "A number of patients labouring under different diseases being assembled in naval hospitals, and different constitutions affected by the same disease requiring difference of diet, what general dietetic rules for an hospital would be best adapted to every exigence, dividing the patients into three classes; the first in which liquids alone are proper, the second in which we begin to give solids in small quantities, and the state of convalescence in which a fuller diet is necessary?" A committee was appointed to draw up an answer to these, who investigated the subject very minutely. The result of their labours is there given at large. The observations most worthy of notice are, that the scurvy of the English seamen, who live chiefly on salt-meat, is a putrid disease; whilst that of the Dutch, who use farinaceous vegetables and dried pulse in large quantities, has more of an hydropical tendency. A mixture of both, even at the same meal,

## S E A

is recommended. This is supported by philosophical reasoning, and the example of Captain Cook, who was partly indebted to this mixed regimen for the preservation of his crew. Salt fish should never be used: salt beef grows hard, and after boiling its fibrous parts only remain, which are more calculated to load the stomach than recruit the strength. Salt bacon may be kept at sea 18 months; it does not lose its moist and nutrimental parts, and unites better with pulse, but should not be used when rancid. Live animals kept on board ships tend to produce diseases amongst the crew. Rice should be used largely. Our puddings are bad food: the flour would be much better made into bread, which might be done at sea with no great trouble. Sour krait should be used freely. Mustard, vinegar, sugar, melasses, and honey, are good antiscorbutics. Of drinks, wine is the best: wort, spruce-beer, or the Russian *quas*, are good substitutes. Spirits are only to be used in cold climates, and in small quantity. The greater part of the excellent memoir in answer to the second question, perfectly coincides with M. Duhamel du Monceau's "Means of Preserving the Health of Seamen," and M. Poissonnier des Perrieres's treatise "On the Diseases of Seamen," and "On the advantages of changing the Diet of Seamen," and his "Examination of Pringle's Dissertation."

SEAPOYS, or SEROYS, natives of Indostan serving in a military capacity under the European powers, and disciplined after the European manner.

The Seapoys of the English East India company compose perhaps the most numerous, regular, and best disciplined body of black troops in the world. They are raised from among the natives of the country, and consist of Moors or Mahometans, Raja-poots, Hindoos, Pariars, besides many intermediate casts peculiar to themselves; the whole modelled in all corresponding particulars, and disciplined in every respect as the army of Great Britain.

The military establishments of Bengal, Madras, and Bombay, have each their respective numbers, that of Bengal exceeding the rest. The Seapoys are formed into complete, uniform, and regular battalions, as our marching regiments at home, being intended to represent and answer fully to every purpose in India to the like troops in Europe. A battalion consists of 700 men, of complete effective strength. In each there are eight companies, including two flank ones or grenadiers. They are respectively commanded by their own black and European officers; to each company there is attached a subaltern, who takes the command, under whom are two native commissioned officers, bearing the rank of subidar and jimindar; of eight subalterns, six

Seamen,  
Seapoys.

Seapoys.

are lieutenants, the other ensigns; exclusive is a staff, of adjutant and surgeon. The black non-commissioned officers answer to our serjeants and corporals, and are called *havildars* and *naigues*. There is also to each corps an English serjeant-major, drill and store serjeant; to each battalion is a band of drums and fifes, and to each a pair of colours. A captain commands the whole.

Their jackets, which are made entirely after the European fashion, are of a red colour with yellow facings (as worn by all the infantry of the company on the Coromandel coast). The remaining part of their attire resembles more the country or Indian habit, and consists of a dark blue turban, broad and round at top, descending deep to the bottom, the sides of which, of a concave form, are crossed by a white band, running in front, fastened under a rose above. As an under garment, they have a jacket of linen. A dark blue sash girding, to answer the turban, goes round their middle. On the thighs they have short drawers, fastened by a scoloped band. Their legs are bare, which renders them more ready for action or service. Their arms are a firelock and bayonet; their accoutrements or cross belts black leather, with pouches the same.

A battalion drawn out cannot but strike the spectators with a lively and fanciful military impression, as they unite in their exterior traits respectively Indian and European.

They are brought to the utmost exactness of discipline; go through their evolutions and manœuvres with a regularity and precision equal to, and not surpassed by, European troops. In action they are brave and steady, and have been known to stand where Europeans have given way.

Their discipline puts them on a footing with European troops, with whom they are always ready to act in concert.

Their utility and services are evident: they secure to the company the internal good order and preservation of their territorial districts, which, though possible to be enforced with a strong hand by Europeans, requires numbers, and can only be conducted with that ease and address peculiar to the native forces of the country.

They are considered with respect in the eyes of the other natives, though they sufficiently, and with a good grace, feel and assert their own consequence. In large garrisons, where the duty is great, as Madras, Pondicherry, Trichinopoly, Vellore, &c. two or three battalions might be present together, exclusive of Europeans. If sent singly up the country, they are liable to be detached, sometimes by one or more companies being sent to a station dependent on the chief garrison or headquarters, otherwise they are dispersed through the districts, four or five together, with a non-commissioned officer (this is a part of the service which is called *going on command*), on hills, or in villages, to preserve order, convey intelligence, and assist the *tasildar*, renter, or cutwall of the place, in cases of emergency. They also enforce the police, and prevent in such cases the country from being infested with thieves, which otherwise have combined, forming a banditti, to rob passengers and plunder cattle, of which there are so many instances upon record. As for such British officers in the company's service as are attached to battalions, they are obliged to follow the fortunes and destinations of their

men, with their respective corps, leading a life often replete with adventures of a peculiar nature. An individual in such cases is frequently secluded from those of his own colour when up the country, or detached upon command, where in a frontier garrison or hill fort in the interior parts of India none but natives are to be found. Here he might live as he pleases, being perfectly absolute within his jurisdiction. Such stations being lucrative, with management may produce great fortunes. Neither is the condition hard to a person conversant in the language of the country, or that of the Seapoys called *Moors* (which most officers in the company's service acquire); otherwise the loss of society is not recompensed by other advantages, as you forget your own language, grow melancholy, and pass your days without comfort.

The peace establishment at Madras consists of 30 Seapoy battalions, but in time of war is augmented as occasion requires; or frequently each corps is strengthened by the addition of two companies, which are reduced again in time of peace, the officers remaining supernumeraries in the service. In garrison they are quartered in barracks: they live agreeably to the usage of the country, sleep on the ground on a mat or thin carpet. In their persons they are cleanly, but appear to best advantage in their uniform. Off duty they go as the other natives in poor circumstances; and have only a cloth round their middle and over their shoulders. As to the different casts, the Moormen or Mussulmen assert pre-eminence, as coming into the country by conquest. In their persons they are rather robust, and in their tempers vindictive. Their religion and dress is distinct from the Hindoos, who are mild and passive in their temper, faithful, steady, and good soldiers. The Parriars are inferior to the others, live under different circumstances, dwell in huts, and associate not on equal terms with the rest; they do all menial offices, are servants to Europeans, and think themselves happy when by them employed, though they are equally good Seapoys.

Having thus treated of the company's Seapoys, we shall observe that they are kindly attentive to their officers when often in circumstances requiring their assistance; are guilty of few vices; and have a strong attachment to those who have commanded them. That acute historian Dr Robertson has remarked, as a proof that the ingenuity of man has recourse in similar situations to the same expedients that the European powers have, in forming the establishment of these native troops, adopted the same maxims, and, probably without knowing it, have modelled their battalions of Seapoys upon the same principles as Alexander the Great did his phalax of Persians.

SEARCH-WARRANT, in law, a kind of general warrant issued by justices of peace or magistrates of towns for searching all suspected places for stolen goods. In Scotland this was often done formerly; and in some English law-books there are precedents requiring the constable to search all such suspected places as he and the party complaining shall think convenient; but such practice is condemned by Lord Hale, Mr Hawkins, and the best authorities both among the English and Scotch lawyers. However, in case of a complaint, and oath made of goods stolen, and that the party suspects that those goods are in a particular house, and shows the cause

Seapoys.  
Search-  
warrant.



earcher  
ll  
soning.

cause of such suspicion, the justice may grant a warrant to search not only that house but other suspected places; and to attach the goods, and the party in whose custody they are found, and bring them before him or some other justice, to give an account how he came by them, and to abide such order as to law shall appertain; which warrant should be directed to the constable or other public officer, who may enter a suspected house and make search.

SEARCHER, an officer in the customs, whose business it is to search and examine ships outward bound, if they have any prohibited goods on board, &c. (12 Car. II.) There are also searchers of leather, &c. See ALNAGER.

SEARCHER, in ordnance, is an iron socket with branches, from four to eight in number, a little bent outwards, with small points at their ends; to this socket is fixed a wooden handle, from eight to twelve feet long, of about an inch and a quarter diameter. After the gun has been fired, this searcher is introduced into it, and turned round, in order to discover the cavities within. The distances of these cavities, if any be found, are then marked on the outside with chalk, when another searcher that has only one point, about which a mixture of wax and tallow is put, is introduced to take the impression of the holes; and if there be any hole, a quarter of an inch deep, or of any considerable length, the gun is rejected as unserviceable.

SEARCLOTH, or CERECLOTH, in surgery, a form of external remedy somewhat harder than an unguent, yet softer than an emplaster, though it is frequently used both for the one and the other. The cerecloth is always supposed to have wax in its composition, which distinguishes and even denominates it. In effect, when a liniment or unguent has wax enough in it, it does not differ from a cerecloth.

SEASIN, in a ship, the name of a rope by which the boat rides by the ship's side when in harbour, &c.

SEASONING, the first illness to which persons habituated to colder climates are subject on their arrival in the West Indies. This seasoning, unless they live very temperately, or are in a proper habit of body (tho' some people are unmolested for many months), seldom suffers them to remain long before it makes its appearance in some mode or other; particularly if at first they expose themselves in a shower of rain, or too long in the sun, or in the night-air; or when the body is much heated, if they drink large draughts of cold liquors, or bathe in cold water; or use much exercise; or commit excess in drinking wine or spirits; or by heating the body and inflaming the blood; or by subjecting themselves to any cause that may suddenly check perspiration, which at first is generally excessive.

Some people, from a favourable state of body, have no seasoning. Thin people, and very young people, are most likely to escape it. Women generally do from their temperance, and perhaps their menstruation contributes to their security; indeed hot climates are favourable to the delicacy of their habits, and suitable to their modes of life. Some escape by great regularity of living; some, by the breaking out of the rash, called the *prickly heat*; some by a great degree of perspiration; and some by observing a cooling regimen. The disorders are various that constitute this seasoning of

new-comers as they are called; depending on age, constitution, and habit of body. But all seasoning diseases are of the inflammatory kind; and yield to antiphlogistic treatment proportioned to their violence. When all precaution to guard against sickness has failed, and prudence proved abortive to new-comers, they will have this comfort at least for their pains, that their disorders will seldom be severe or expensive, and will generally have a speedy termination; and that their seasoning, as it is emphatically called, will be removed by bleeding, a dose of salts, rest, and a cooling regimen.

SEASONING of Timber. See TIMBER.

SEASONS, in cosmography, certain portions or quarters of the year, distinguished by the signs which the sun then enters, or by the meridian altitudes of the sun; consequent on which are different temperatures of the air, different works in tillage, &c. See WEATHER.

The year is divided into four seasons, spring, summer, autumn, and winter. The beginnings and endings of each whereof, see under its proper article. It is to be observed, the seasons anciently began differently from what they now do: witness the old verses,

*Dat Clemens hyemem; dat Petrus ver cathedratus;  
Æfluat Urbanus; autumnat Bartholomæus.*

SEAT, in the manege, is the posture or situation of a horseman upon the saddle.

SEATON, a small fishing town on the south coast of Devon, between Lyme and Sidmouth. Risdon says "our learned antiquarians would have it to be that *Maridunum* whereof Antonine spake, placed between *Dunnovaria* and *Isca*; for *Maridunum* in British is the same with *Seaton* in English, 'a town upon a hill by the sea side.'" This place is memorable for the Danish princes landing there in the year 937.

SEBACIC ACID, the acid procured from fat. To obtain it, let some suet be melted in a skillet over the fire, along with some quicklime in fine powder, and constantly stirred, raising the fire towards the end of the operation, and taking care to avoid the vapours, which are very offensive. By this process the sebacic acid unites with the lime into a sebat of lime, which is difficultly soluble in water; it is, however, separated from the fatty matters with which it is mixed by solution in a large quantity of boiling water. From this the neutral salt is separated by evaporation; and, to render it pure, is calcined, redissolved, and again crystallized. After this we pour on a proper quantity of sulphuric acid, and the sebacic acid passes over by distillation. See FAT, and CHEMISTRY-Index.

STSEBASTIAN, a handsome, populous, and strong town of Spain, in the province of Guipuscoa, with a good and well frequented harbour. It is seated at the foot of a mountain; and the harbour secured by two moles, and a narrow entrance for the ships. The town is surrounded with a double wall, and to the sea side is fortified with bastions and half moons. The streets are long, broad, and straight, and paved with white flagstones. At the top of the mountain is a citadel, with a garrison well furnished with cannon. The town carries on a considerable trade, the greatest part of which consists of iron and steel, which some reckon to be the best in Europe. They also deal in wool, which comes

Seasoning  
ll  
St. Sebast-  
tian.

Sebastiano from Old Castile. W. Long. 1. 59. N. Lat. 43. 23.—  
 The capital of Brasil in South America is likewise called *Sebastian*.

SEBASTIANO, called *Del Piccolo*, from an office in the lead mines given him by Pope Clement VII. was an eminent Venetian painter, born in 1485. He was first a disciple of old Giovanni Bellino; continued his studies under Giorgione; and having attained an excellent manner of colouring, went to Rome, where he insinuated himself into the favour of Michael Angelo. He has the name of being the first who invented the art of preparing plaster-walls for oil-painting; but was so slow and lazy in his work, that other hands were often employed to finish what he began. He died in 1547.

SEBESTEN, in botany. See *Cordia*.

SEBUÆI, a sect among the ancient Samaritans, whom St Epiphanius accuses of changing the time expressed in the law, for the celebration of the great annual feasts of the Jews,

SEBURAI, SEBURÆI, a name which the Jews give to such of their rabbins or doctors as lived and taught some time after the finishing of the Talmud.

SECACUL, in the materia medica of the ancients, a name given by Avicenna, Serapion, and others, to a root which was like ginger, and was brought from the East Indies, and used as a provocative to venery. The interpreters of their works have rendered this word *iringo*; and hence some have supposed that our *eryngium* or *eryngo* was the root meant by it: but this does not appear to be the case on a strict inquiry, and there is some reason to believe that the famous root, at this time called *ginfeng*, was what they meant.

SECALE, RYE, in botany: A genus of the digynia order, belonging to the triandria class of plants; and in the natural method ranking under the 4th order, *Gramina*. The calyx is a glume of two leaves, which are opposite to one another, erect, linear, pointed, and less than the corolla. The corolla consists of two valves, the exterior of which ends in a beard. There are four species, the *villosum*, *orientale*, *creticum*, and *c. reale*. The *villosum*, or wood rye-grass, is distinguished by a calyx with wedge-shaped leaves, and by the fringe of the glume being woolly. The glumes of the *orientale* are shaggy, and the scales of the calyx shaped like an awl. The glumes of the *creticum* are fringed on the outside. The *c. reale*, or common rye, has glumes with rough fringes. It is a native of the island of Candia, was introduced into England many ages ago, and is the only species of rye cultivated in this kingdom. There are, however, two varieties, the winter and spring rye.

The winter rye, which is larger in the grain than the spring rye, is sown in autumn at the same time with wheat, and sometimes mixed with it; but as the rye ripens sooner than the wheat, this method must be very exceptionable. The spring rye is sown along with the oats, and usually ripens as soon as the winter rye; but the grain produced is lighter, and it is therefore seldom sown except where the autumnal crop has failed.

Rye is commonly sown on poor, dry, limestone, or

sandy soils, where wheat will not thrive. By continuing to sow it on such a soil for two or three years, it will at length ripen a month earlier than that which has been raised for years on strong cold ground.

Rye is commonly used for bread either alone or mixed with wheat. This mixture is called *meslin*, and was formerly a very common crop in some parts of Britain. Mr Musshall tells us, that the farmers in Yorkshire believe that this mixed crop is never affected by mildew, and that a small quantity of rye sown among wheat will prevent this destructive disease. Rye is much used for bread in some parts of Sweden and Norway by the poor people. About a century ago rye-bread was also much used in England; but being made of a black kind of rye, it was of the same colour, clammy, very detergent, and consequently not so nourishing as wheat.

Rye is subject to a disease which the French call *ergot*, and the English *horned rye*; which sometimes happens when a very hot summer succeeds a rainy spring. According to Tissot, horned rye is such as suffers an irregular vegetation in the middle substance between the grain and the leaf, producing an excrescence of a brownish colour, about an inch and a half long, and two-tenths of an inch broad. Bread made of this kind of rye has a nauseous acrid taste, and produces spasmodic and gangrenous disorders. In 1596, an epidemic disease prevailed in Hesse, which the physicians ascribed to bread made of horned rye. Some, we are told, were seized with an epilepsy, and these seldom ever recovered; others became lunatic, and continued stupid the rest of their lives: those who apparently recovered had annual returns of their disorder in January and February; and the disease was said to be contagious at least in a certain degree. The facts which we have now mentioned are taken from a work of Tissot, which was never printed. The same disease was occasioned by the use of this bread in several parts of the continent in the years 1648, 1675, 1702, 1716, 1722, and 1736; and has been very minutely described by Hoffman, A. O. Goeliecke, Vater Burghart, and J. A. Slink.

In the year 1709, one fourth part of all the rye raised in the province of Salonia in France was horned, and the surgeon to the hospital of Orleans had no less than 500 patients under his care that were distressed by eating it: They were called *ergots*, from *ergot* (A), the French name for horned rye; they consisted chiefly of men and boys, the number of women and girls being very small. The first symptom was a kind of drunkenness, then the local disorder began in the toes, and thence extended sometimes to the thigh, and the trunk itself, even after amputation, which is a good argument against that operation before the gangrene is stopped.

In the year 1710, the celebrated Fontenelle describes a case in the History of the Academy of Sciences of France, which exactly resembles that of the poor family at Wattisham. A peasant at Blois, who had eaten horned rye in bread, was seized with a mortification, which first caused all the toes of one foot to fall off, then

(A) *Ergot* is French for a cock's spur, and horned rye was called *ergot* from the resemblance of its excrescence to that part.

*Secant.*  
*Seceders.*  
then the toes of the other, afterwards the remainder of the feet, and, lastly, it eat off the flesh of both his legs and thighs, leaving the bones bare.

Horned rye is not only hurtful to man, but to other animals; it has been known to destroy even the flies that settled upon it; sheep, dogs, deer, geese, ducks, swine, and poultry, that were fed with it for experiment, died miserably, some convulsed, others mortified and ulcerated.

SECANT, in geometry, a line that cuts another or divides it into parts. The secant of a circle is a line drawn from the circumference on one side to a point without the circumference on the other; and it is demonstrated by geometers, that of several secants drawn to the same point, that is the longest which passes thro' the centre of the circle. The portions, however, of these several secants that are without the circle are so much the greater as they recede from the centre, and the least external portion is of that secant which passes through it.

SECANT, in trigonometry, denotes a right line drawn from the centre of a circle, which, cutting the circumference, proceeds till it meets with a tangent to the same circle. See GEOMETRY, n<sup>o</sup> 24—28.

Line of SECANTS, one of those lines or scales which are usually put upon sectors. How such a scale is formed will be seen by a bare inspection of fig. 53. Plate CCXV.; for C 10, C 20, C 30, &c. drawn from the centre C to the line of tangents BE, being the real secants of the arches B 10, B 20, B 30, it is obvious that by marking off the distances B 10, B 20, B 30, upon any other line, we make that line a scale of secants.

*Seceders.*  
SECEDERS, a numerous body of Presbyterians in Scotland, who have withdrawn from the communion of the established church. As they take up their ground upon the establishment of religion from 1638 to 1650, which they hold to be the purest period of the Scottish church, we shall introduce our account of them by a short review of ecclesiastical history from that period to the era of their secession. With our usual candour and impartiality we mean to give a fair statement of those events with which, as they say, their secession is connected.

James I. having for some time previous to his death entertained a wish to form the church of Scotland as much as possible upon the model of that in England, his son Charles, with the assistance of archbishop Laud, endeavoured to carry the design into execution, by establishing canons for ecclesiastical discipline, and introducing a liturgy into the public service of the church.—Numbers of the clergy and laity of all ranks took the alarm at what they considered to be a bold and dangerous innovation; and after frequent applications to the throne, they at last obtained the royal proclamation for a free parliament and general assembly. The assembly met in 1638, and began their labours with a repeal of all the acts of the six preceding parliaments, which had favoured the designs of James. They condemned the liturgy, together with every branch of the hierarchy. They cited all the Scottish bishops to their bar; and after having excommunicated nine of them, and deposed five from their episcopal office, they restored kirk-sessions, presbyteries, and synods provincial as well as national. See PRESBYTERIANS.

VOL. XVII. Part I.

These proceedings were ratified by the parliament which met in 1640. The law of patronage was in full force for several years after this period; yet great care was taken that no minister should be obtruded on the Christian people contrary to their inclinations; and in 1649 it was abolished as an oppressive grievance.

*Seceders.*

The Restoration of Charles II. in 1660 changed the face of affairs in the church of Scotland. All that the general assembly had done from 1638 to 1650 was rendered null and void, their covenants were pronounced to be unlawful, episcopacy was restored, and the king was declared to be the supreme head of the church in all causes civil and ecclesiastical. During this period the Presbyterians were subjected to fines and imprisonment, while numbers of them were publicly executed for their adherence to their political and religious tenets.

The Revolution in 1688 gave a different turn to the affairs of the church. The first parliament which met after that event, abolished prelacy and the king's supremacy in ecclesiastical affairs. They ratified the Westminster Confession of Faith, together with the Presbyterian form of church-government and discipline, "as agreeable to the word of God, and most conducive to the advancement of true piety and godliness, and the establishment of peace and tranquillity within these realms." That same parliament abolished patronage, and lodged the election of ministers in the hands of heritors and elders, with the consent of the congregation.

In the reign of Q. Anne the true Protestant religion was ratified and established, together with the Presbyterian form of church-government and discipline; and the unalterable continuance of both was declared to be an essential condition of the union of the two kingdoms in all time coming. In 1712 the law respecting patronage was revived, in resentment, it has been said, of that warm attachment which the church of Scotland discovered to the family of Hanover; but the severity of that law was greatly mitigated by the first parliament of George I. stat. 50. by which it is enacted, that if the presentee do not signify his acceptance, the presentation shall become void and null in law. The church, however, did not avail herself of this statute; and an event which happened not many years afterwards gave rise to the *secession*.

In 1732 more than 40 ministers presented an address to the general assembly, specifying in a variety of instances what they considered to be great defections from the established constitution of the church, and craving a redress of these grievances. A petition to the same effect, subscribed by several hundreds of elders and private Christians, was offered at the same time; but the assembly refused a hearing to both, and enacted, that the election of ministers to vacant charges, where an accepted presentation did not take place, should be competent only to a conjunct meeting of elders and heritors, being Protestants. To this act many objections were made by numbers of ministers and private Christians. They asserted that more than 30 to one in every parish were not possessed of landed property, and were on that account deprived of what they deemed their natural right to choose their own pastors. It was also said, that this act was extremely prejudicial to the honour and interest of the church, as well as to the edification of the people; and in fine, that it was directly

<sup>2</sup>  
Origin of

F f

contrary

**Seceders.** contrary to the appointment of Jesus Christ, and the practice of the apostles, when they filled up the first vacancy in the apostolic college, and appointed the election of deacons and elders in the primitive church.— Many of those also who were thought to be the best friends of the church, expressed their fears that this act would have a tendency to overturn the ecclesiastical constitution which was established at the Revolution.

<sup>3</sup> They oppose the measures of the general assembly; Mr Ebenezer Erskine minister at Stirling distinguished himself by a bold and determined opposition to the measures of the assembly in 1732. Being at that time moderator of the synod of Perth and Stirling, he opened the meeting at Perth with a sermon from Psalm cxviii. 22. "The stone which the builders rejected is become the head stone of the corner." In the course of his sermon he remonstrated with no small degree of freedom against the act of the preceding assembly with regard to the settlement of ministers, and alleged that it was contrary to the word of God and the established constitution of the church. A formal complaint was lodged against him for uttering several offensive expressions in his sermon before the synod. Many of the members declared that they heard him utter nothing but sound and reasonable doctrine; but his accusers insisting on their complaint, obtained an appointment of a committee of synod to collect what were called the offensive expressions, and to lay them before the next diet in writing. This was done accordingly; and Mr Erskine gave in his answers to every article of the complaint. After three days warm reasoning on this affair, the synod by a majority of six found him censurable; against which sentence he protested, and appealed to the next general assembly. When the assembly met in May 1733, it affirmed the sentence of the synod, and appointed Mr Erskine to be rebuked and admonished from the chair. Upon which he protested, that, as the assembly had found him censurable, and had rebuked him for doing what he conceived to be agreeable to the word of God and the standards of the church, he should be at liberty to preach the same truths, and to testify against the same or similar evils, on every proper occasion. To this protest Messrs William Wilson minister at Perth, Alexander Moncrief minister at Abernethy, and James Fisher minister at Kinclaven, gave in a written adherence, under the form of instrument; and these four withdrew, intending to return to their respective charges, and act agreeably to their protest whenever they should have an opportunity. Had the affair rested here, there never would have been a secession; but the assembly resolving to carry on the process, cited them by their officer to compare next day. They obeyed the citation; and a committee was appointed to retire with them, in order to persuade them to withdraw their protest. The committee having reported that they still adhered to their protest, the assembly ordered them to appear before the commission in August following and retract their protest; and if they should not comply and testify their sorrow for their conduct, the commission was empowered to suspend them from the exercise of their ministry, with certification that if they should act contrary to said sentence, the commission should proceed to an higher censure.

The commission met in August accordingly; and the

four ministers still adhering to their protest, were suspended from the exercise of their office, and cited to the next meeting of the commission in November following. From this sentence several ministers and elders, members of the commission, dissented. The commission met in November, and the suspended ministers appeared. Addresses, representations, and letters from several synods and presbyteries, relative to the business now before the commission, were received and read. The synods of Dumfries, Murray, Ross, Angus and Mearns, Perth and Stirling, craved that the commission would delay proceeding to an higher censure. The synods of Galloway and Fife, as also the presbytery of Dornoch, addressed the commission for lenity, tenderness, and forbearance, towards the suspended ministers; and the presbytery of Aberdeen represented, that, in their judgment, the sentence of suspension inflicted on the forefaid ministers was too high, and that it was a stretch of ecclesiastical authority. Many members of the commission reasoned in the same manner, and alleged that the act and sentence of last assembly did not oblige them to proceed to an higher censure at this meeting of the commission. The question, however, was put, Proceed to an higher censure, or not? and the votes being numbered, were found equal on both sides: upon which Mr John Goldie the moderator gave his casting vote to proceed to an higher censure; which stands in their minutes in these words: "The commission did and hereby do loose the relation of Mr Ebenezer Erskine minister at Stirling, Mr William Wilson minister at Perth, Mr Alexander Moncrief minister at Abernethy, and Mr James Fisher minister at Kinclaven, to their respective charges, and declare them no longer ministers of this church; and do hereby prohibit all ministers of this church to employ them, or any of them, in any ministerial function. And the commission do declare the churches of the said ministers vacant from and after the date of this sentence."

This sentence being intimated to them, they protested, that their ministerial office and relation to their respective charges should be held as valid as if no such sentence had passed; and that they were now obliged to make a secession from the prevailing party in the ecclesiastical courts; and that it shall be lawful and warrantable for them to preach the gospel, and discharge every branch of the pastoral office, according to the word of God and the established principles of the church of Scotland. Mr Ralph Erskine minister at Dunfermline, Mr Thomas Mair minister at Orwel, Mr John McLaren minister at Edinburgh, Mr John Currie minister at Kinglassie, Mr James Wardlaw minister at Dunfermline, and Mr Thomas Nairn minister at Abbotshal, protested against the sentence of the commission, and that it should be lawful for them to complain of it to any subsequent general assembly of the church.

The secession properly commenced at this date. And accordingly the ejected ministers declared in their protest that they were laid under the disagreeable necessity of seceding, not from the principles and constitution of the church of Scotland, to which, they said, they steadfastly adhered, but from the present church-courts, which had thrown them out from ministerial communion. The assembly, however, which met in May 1734 did so far modify the above sentence, that they empowered the synod of Perth and Stirling to receive the ejected ministers

Seceders  
5  
Suspended  
from the  
exercise of  
their office

6  
Deprived  
of their  
living.

ministers into the communion of the church, and restore them to their respective charges; but with this express direction, "that the said synod should not take upon them to judge of the legality or formality of the former procedure of the church judicatories in relation to this affair, or either approve or censure the same." As this appointment neither condemned the act of the preceding assembly nor the conduct of the commission, the seceding ministers considered it to be rather an act of grace than of justice, and therefore they said they could not return to the church-courts upon this ground; and they published to the world the reasons of their refusal, and the terms upon which they were willing to return to the communion of the established church. They now erected themselves into an ecclesiastical court, which they called the *Associated Presbytery*, and preached occasionally to numbers of the people who joined them in different parts of the country. They also published what they called an *Act, Declaration, and Testimony*, to the doctrine, worship, government, and discipline of the church of Scotland, and against several instances, as they said, of defection from these, both in former and in the present times. Some time after this several ministers of the established church joined them, and the *Associated Presbytery* now consisted of eight ministers. But the general assembly which met in 1738 finding that the number of Seceders was much increased, ordered the eight ministers to be served with a libel, and to be cited to the next meeting of the assembly in 1739. They now appeared at the bar as a constituted presbytery, and having formally declined the assembly's authority, they immediately withdrew. The assembly which met next year deposed them from the office of the ministry; which, however, they continued to exercise in their respective congregations, who still adhered to them, and erected meeting-houses, where they preached till their death. Mr James Fisher, the last survivor of them, was, by an unanimous call in 1741, translated from Kinclaven to Glasgow, where he continued in the exercise of his ministry among a numerous congregation, respected by all ranks in that large city, and died in 1775 much regretted by his people and friends. In 1745 the seceding ministers were become so numerous, that they were erected into three different presbyteries, under one synod, when a very unprofitable dispute divided them into two parties.

The burghs oath in some of the royal boroughs of Scotland contains the following clause: "I profess and allow with my heart the true religion presently professed within this realm, and authorized by the laws thereof. I will abide at and defend the same to my life's end, renouncing the Romish religion called *Papistry*." Messrs Ebenezer and Ralph Erskine, James Fisher, and others, affirmed that this clause was no way contrary to the principles upon which the secession was formed, and that therefore every Seceder might lawfully swear it. Messrs Alexander Moncrief, Thomas Mair, Adam Gib, and others, contended on the other hand

that the swearing of the above clause was a virtual renunciation of their testimony. And this controversy was so keenly agitated, that they split into two different parties, and now meet in different synods. Those of them who assert the lawfulness of swearing the burghs oath are called *Burghers*, and the other party who condemn it are called *Antiburgher Seceders*. Each party claiming to itself the lawful constitution of the *Associate Synod*, the Antiburghers, after several previous steps, excommunicated the Burghers on the ground of their sin and of their contumacy in it. This rupture took place in 1747, since which period no attempts to effect a reunion have been successful. They remain under the jurisdiction of different synods, and hold separate communion, although much of their former hostility has been laid aside. The Antiburghers consider the Burghers as too lax and not sufficiently steadfast to their testimony. The Burghers on the other hand contend that the Antiburghers are too rigid, in that they have introduced new terms of communion into the society. The Antiburghers having adopted ideas with regard to what they call *covenanting*, which the Burghers never approved (A), have been in use of renewing in their several congregations the Scottish Covenant, by causing their people formally swear to maintain it. In other respects the differences between the two parties are not material. The Antiburghers are most numerous on the north of the Tay, and the Burghers on the south of it.

What follows in this article is a further account of those who are commonly called the *Burgher Seceders*. They have a greater number of people in their communion than the Antiburghers, and for some years past they have greatly increased in the southern and western districts of Scotland. As there were among them from the commencement of their secession several students who had been educated at one or other of the universities, they appointed one of their ministers to give lectures in theology, and train up candidates for the ministry. Messrs William Wilson minister at Perth and Alexander Moncrief minister at Abernethy were their professors of theology before their separation from the Antiburghers.

Since that period Mr Ebenezer Erskine minister at Stirling, Mr James Fisher minister at Glasgow, Mr John Swanson minister at Kinross, and Mr John Brown minister at Haddington, have succeeded each other in this office. At present (1794) Mr George Lawson minister at Selkirk is their professor of theology, and there are between thirty and forty students who attend his lectures annually. The number of their ministers is about an hundred, and each of their congregations contain from two hundred and fifty to three thousand persons; and there are among them at present more than twenty vacant charges. Where a congregation is very numerous, as in Stirling, Dunfermline, and Perth, it is formed into a collegiate charge, and provided with two ministers. They are erected into six dif-

F f 2 ferent

(A) This is the account which the Burghers give of their own notions respecting the covenant. One of the most enlightened of their opponents, however, assure us that they acknowledge covenanting to be a *moral duty*, and that the solemn vows of our ancestors are obligatory. But since the breach in the synod they have never engaged in this work; giving, as their reason, that this is not the proper season.

**Seceders.** ferent presbyteries, united in one general synod, which commonly meets at Edinburgh in May and September (B). They have also a synod in Ireland composed of three or four different presbyteries. They are legally tolerated in Ireland; and government some years ago granted L. 500 *per annum*, and of late an additional L. 100, which, when divided among them, affords to each minister about L. 20 over and above the stipend which he receives from his hearers. These have besides a presbytery in Nova Scotia; and some years ago, it is said, that the Burgher and the Antiburgher ministers residing in the United States formed a coalition and joined in a general synod, which they call the *Synod of New York and Pennsylvania*. They all preach the doctrines contained in the Westminster Confession of Faith and Catechisms, as they believe these to be founded on the sacred scriptures. They catechise their hearers publicly, and visit them from house to house once every year. They will not give the Lord's supper to those who are ignorant of the principles of the gospel, nor to such as are scandalous and immoral in their lives. They condemn private baptism, nor will they admit those who are grossly ignorant and profane to be sponsors for their children. Believing that the people have a natural right to choose their own pastors, the settlement of their ministers always proceeds upon a popular election; and the candidate who is elected by the majority is ordained among them. Convinced that the charge of souls is a trust of the greatest importance, they carefully watch over the morals of their students, and direct them to such a course of reading and study as they judge most proper to qualify them for the profitable discharge of the pastoral duties. At the ordination of their ministers they use a *formula* of the same kind with that of the established church, which their ministers are bound to subscribe when called to it; and if any of them teach doctrines contrary to the scriptures or the Westminster Confession of Faith, they are sure of being thrown out of their communion. By this means uniformity of sentiment is preserved among them; nor has any of their ministers, excepting one, been prosecuted for error in doctrine since the commencement of their secession.

II  
Their rules  
of faith,

They believe that the holy scriptures are the sole criterion of truth, and the only rule to direct mankind to glorify and enjoy God, the chief and eternal good; and that "the Supreme Judge, by which all controversies of religion are to be determined, and all the decrees of councils, opinions of ancient writers, doctrines of men and private spirits, are to be examined, and in whose sentence we are to rest, can be no other but the Holy Spirit speaking in the scriptures." They are fully persuaded, however, that the standards of public authority in the church of Scotland exhibit a just and

consistent view of the meaning and design of the holy scriptures with regard to doctrine, worship, government, and discipline; and they in so far differ from the dissenters in England, in that they hold these standards to be not only articles of peace and a test of orthodoxy, but as a bond of union and fellowship. They consider a simple declaration of adherence to the scriptures as too equivocal a proof of unity in sentiment, because Arians, Socinians, and Arminians, make such a confession of their faith, while they retain sentiments which they (the Seceders) apprehend are subversive of the great doctrines of the gospel. They believe that Jesus Christ is the only King and Head of the Church, which is his body; that it is his sole prerogative to enact laws for the government, of his kingdom, which is not of this world; and that the church is not possessed of a legislative, but only of an executive power, to be exercised in explaining and applying to their proper objects and ends those laws which Christ hath published in the scriptures. Those doctrines which they teach relative to faith and practice are exhibited at great length in an explanation of the Westminster Assembly's Shorter Catechism, by way of question and answer, in two volumes, composed chiefly by Mr James Fisher late of Glasgow, and published by desire of their synod.

For these fifty years past, the grounds of their secession, they allege, have been greatly enlarged by the public administrations of the established church, and particularly by the uniform execution of the law respecting patronage, which, they say, has obliged many thousands of private Christians to withdraw from the parish-churches and join their society.

It is certain, however, that their number has rapidly increased of late, especially in the large cities of the kingdom. They have three different congregations in Edinburgh, two in Glasgow, and two in London, besides several others in the north of England. In most of their congregations they celebrate the Lord's supper twice in the year, and they catechise their young people concerning their knowledge of the principles of religion previously to their admission to that sacrament. When any of them fall into the sin of fornication or adultery, the scandal is regularly purged according to the form of process in the established church; and those of the delinquents who do not submit to adequate censure are publicly declared to be fugitives from discipline, and are expelled the society. They never accept a sum of money as a commutation for the offence. They condemn all clandestine and irregular marriages, nor will they marry any persons unless they have been proclaimed in the parish church on two different Lord's days at least.

When they separated from the established church, and remained firm in their attachment to the state; and they

(B) The constitution of the Antiburgher church differs very little from that of the Burghers. The supreme court among them is designed *The General Associate Synod*, having under its jurisdiction three provincial synods in Scotland and one in Ireland. In the former country there are eleven presbyteries; in the latter, four. They have a few congregations in England, and a presbytery in connection with them in North America. The number of ministers belonging to the general synod is a hundred and thirty-seven; and in Scotland there are nineteen vacancies. They, as well as the Burgher Seceders, have a professor of theology, whose lectures every candidate for the office of a preacher is obliged to attend, we have been told, for no less than five or six sessions! Surely the session must be of short duration.

Seceders,  
Seckium.

they were not many years formed into a distinct society, when they expelled from their communion a Mr Thomas Nairn miller at Kirkcaldy, who had taught doctrines inimical to the civil government of the nation. In 1745 there was not one of their number who joined the then pretender to the British crown. They are still of the same sentiments; and in their public assemblies they always pray for our sovereign King George, with the royal family, and for all who are in authority under them. They are so far from wishing the overthrow of the present civil government, that when the nation was lately in danger of being thrown into a fermentation by the circulation of inflammatory and seditious writings, they warmly recommended peace and order in society (e). No legal disqualifications, as in the case of the dissenters in England, exclude them from any place of public trust in the municipal government of the country; and some of them are frequently in the magistracy of the royal boroughs. They are not, however, legally tolerated, but are supported by the mildness of administration and the liberal spirit of the times. Avowing their adherence to the doctrines contained in the public standards of the church of Scotland, together with the presbyterian form of government, from which they never intended to secede, they deny that they are either schismatics or sectaries, as they have been frequently called; and when they withdrew from the ecclesiastical courts, they did not, they say, constitute a church of their own, different from the national church, but profess to be a part of that church, endeavouring to hold by her reformed principles, in opposition to those deviations from them which they have specified in their *Act and Testimony*. Most of them live in habits of friendship and intimacy with their brethren of the establishment, and they profess an affectionate regard for all those of every denomination who love Jesus Christ in sincerity and truth. In the late re-exhibition of their testimony, they have declared to the world, that, were the grounds of their secession happily removed, they would account it one of the most singular felicities of their time to return with pleasure to the communion of the established church.

SECKIUM, in botany: A genus of the syngenesia order, belonging to the monœcia class of plants; and in the natural method ranking under the 34th order, *Cucurbitaceæ*. The male calyx is quinque-dentate and monophyllous; the corolla monopetalous; the five filaments are united in an erect tube. In the female flower the pistillum is cylindrical and erect; the stigma large, peltate, and reflected; the pericarpium large, oval, unequal, fleshy, and unilocular, containing one seed, which is smooth, compressed, and fleshy. Of this there is only one species, viz. the *Edulis*, or Chocho vine.— This is cultivated and grows very luxuriantly in many places in Jamaica. The vines run and spread very much. The fruit is boiled, and served up at table by

way of greens; and the root of the old vine is somewhat like a yam (*Dioscorea*), and on being boiled or roasted tastes farinaceous and wholesome.

Seckendorf,  
Secker.

SECKENDORF (Guy Lewis de), a very learned German, descended from an ancient and noble family, was born at Aurach in Franconia in 1626. He was a good linguist, learned in law, history, and divinity; and is said to have been a tolerable painter and engraver. He was honourably employed by several of the German princes; and died counsellor of state to Frederic III. elector of Brandenburg, and chancellor of the university of Halle, in 1692. He wrote many books, particularly "A history and defence of the Lutheran religion," 2 vols folio, Frankfurt, 1602, in Latin.

SECKER (Thomas), a learned and respectable prelate of the church of England, was born, in 1693, at a village called *Sibthorp*, in the vale of Belvoir, Nottinghamshire. His father was a Protestant dissenting, a pious, virtuous, and sensible man; who having a small paternal fortune, followed no profession. His mother was the daughter of Mr George Brough, a substantial gentleman farmer of Shelton in the same county. He received his education at several private schools and academies in the country, being obliged, by various accidents, to change his masters frequently.

Notwithstanding this disadvantage, he had at the age of 19 not only made a considerable progress in Greek and Latin, and read the best writers in both languages, but had acquired a knowledge of French, Hebrew, Chaldee, and Syriac; had learned geography, logic, algebra, geometry, conic sections, and gone through a course of lectures on Jewish antiquities and other points, preparatory to the critical study of the Bible. He had been destined by his father for orders among the Dissenters. With this view, during the latter years of his education, his studies were chiefly turned towards divinity, in which he had made such quick advances, that by the time he was 23 he had carefully read over a great part of the Scriptures, particularly the New Testament, in the original, and the best comments upon it; Eusebius's Ecclesiastical History, The Apostolical Fathers, Whiston's Primitive Christianity, and the principal writers for and against Ministerial and Lay Conformity.— But though the result of these inquiries was a well-grounded belief of the Christian revelation, yet not being at that time able to decide on some abstruse speculative doctrines, nor to determine absolutely what communion he should embrace; he resolved, like a wise and honest man, to pursue some profession, which should leave him at liberty to weigh those things more maturely in his thoughts, and not oblige him to declare or teach publicly opinions which were not yet thoroughly settled in his own mind.

In 1716, therefore, he applied himself to the study of physic, and after gaining all the medical knowledge he could,

(c) All this is said of the Burgher Seceders; but we hope it is equally true of those who are styled Anti-burghers. There are indeed some clauses in the Covenant which they swear to maintain, that seem not, at first view, very friendly to civil subordination; but let not those who entertain any apprehension on this account, forget that one of the most useful defences of the British constitution, occasioned by the late factious spirit of democratic innovation, came from the pen of Dr Young the Anti-burgher minister at Hawick. See *Young's Essays*.

Secker.

could, by reading the usual preparatory books, and attending the best lectures during that and the following winter in London, in order to improve himself farther, in January 1718-19 he went to Paris. There he lodged in the same house with the famous anatomist Mr Winslow, whose lectures he attended, as he did those of the materia medica, chemistry, and botany, at the king's gardens. The operations of surgery he saw at the *Hotel Dieu*, and attended also for some time M. Gregoire, the accoucheur, but without any design of ever practising that or any other branch of surgery. Here he became acquainted with Mr Martin Benson, afterwards bishop of Gloucester, one of the most agreeable and virtuous men of his time; with whom he quickly became much conversed, and not many years after was united to him by the strictest bonds of affinity as well as affection.

During the whole of Mr Secker's continuance at Paris, he kept up a constant correspondence with Mr Joseph Butler, afterwards bishop of Durham, with whom he became acquainted at the academy of one Mr Jones, kept first at Gloucester, and afterward at Tewksbury. Mr Butler having been appointed preacher at the Rolls on the recommendation of Dr Clarke and Mr Edward Talbot, son to bishop Talbot, he now took occasion to mention his friend Mr Secker, without Secker's knowledge, to Mr Talbot, who promised, in case he chose to take orders in the church of England, to engage the bishop his father to provide for him. This was communicated to Mr Secker in a letter from Mr Butler about the beginning of May 1720. He had not at that time come to any resolution of quitting the study of physic; but he began to foresee many obstacles to his pursuing that profession; and having never discontinued his application to theology, his former difficulties both with regard to conformity and some other doubtful points had gradually lessened, as his judgment became stronger, and his reading and knowledge more extensive. It appears also from two of his letters still in being, written from Paris to a friend in England, (both of them prior to the date of Mr Butler's abovementioned), that he was greatly dissatisfied with the divisions and disturbances which at that particular period prevailed among the Dissenters.

In this state of mind Mr Butler's unexpected proposal found him; which he was therefore very well disposed to take into consideration; and after deliberating on the subject of such a change for upwards of two months, he resolved at length to embrace the offer, and for that purpose quitted France about the beginning of August 1720.

On his arrival in England, he was introduced to Mr Talbot, with whom he cultivated a close acquaintance; but it was unfortunately of very short duration; for in the month of December that gentleman died of the small-pox. This was a great shock to all his friends, who had justly conceived the highest expectations of him; but especially to an amiable lady whom he had lately married, and who was very near sinking under so sudden and grievous a stroke. Mr Secker, beside sharing largely in the common grief, had peculiar reason to lament an accident that seemed to put an end to all his hopes; but he had taken his resolution, and he determined to persevere. It was some encouragement to him to find that Mr Talbot had, on his death-bed,

recommended him, together with Mr Benson and Mr Butler, to his father's notice. Thus did that excellent young man (for he was but 29 when he died), by his nice discernment of characters, and his considerate good nature, provide most effectually, in a few solemn moments, for the welfare of that church from which he himself was so prematurely snatched away; and at the same time raised up, when he least thought of it, the truest friend and protector to his wife and unborn daughter; who afterwards found in Mr Secker all that tender care and assistance which they could have hoped for from the nearest relation.

It being judged necessary by Mr Secker's friends that he should have a degree at Oxford; and having been informed, that if he should previously take the degree of Doctor in Physic at Leyden, it would probably help him in obtaining the other, he went over and took his degree there in March 1721: and, as part of his exercise for it, he composed and printed a dissertation *de Medicina Statica*, which is still extant, and is thought by the gentlemen of that profession to be a sensible and learned performance.

In April the same year, he entered himself a gentleman commoner of Exeter college, Oxford; after which he obtained the degree of Bachelor of Arts, in consequence of the chancellor's recommendatory letter to the convocation.

He now spent a considerable part of his time in London, where he quickly gained the esteem of some of the most learned and ingenious men of those days, particularly of Dr Clarke, rector of St James's, and the celebrated dean Berkeley, afterwards bishop of Cloyne, with whom he every day became more delighted, and more closely connected. He paid frequent visits of gratitude and friendship to Mrs Talbot, widow of Mr Edward Talbot, by whom she had a daughter five months after his decease. With her lived Mrs Catharine Benson, sister to bishop Benson, whom in many respects she greatly resembled. She had been for several years Mrs Talbot's inseparable companion, and was of unspeakable service to her at the time of her husband's death, by exerting all her courage, activity, and good sense (of which she possessed a large share), to support her friend under so great an affliction, and by afterwards attending her sickly infant with the utmost care and tenderness, to which, under Providence, was owing the preservation of a very valuable life.

Bishop Talbot being in 1721 appointed to the see of Durham, Mr Secker was in 1722 ordained deacon by him in St James's church, and priest not long after in the same place, where he preached his first sermon March 28. 1723. The bishop's domestic chaplain at that time was Dr Rundle, a man of warm fancy and very brilliant conversation, but apt sometimes to be carried by the vivacity of his wit into indiscreet and ludicrous expressions, which created him enemies, and, on one occasion, produced disagreeable consequences.— With him Mr Secker was soon after associated in the bishop's family, and both taken down by his lordship to Durham in July 1723.

In the following year the bishop gave Mr Secker the rectory of Houghton-le-Spring. This preferment putting it in his power to fix himself in the world, in a manner agreeable to his inclinations, he soon after made a proposal of marriage to Mrs Benson; which being accepted,

Secker.



Secker. cepted, they were married by bishop Talbot in 1725. At the earnest request of both, Mrs Talbot and her daughter consented to live with them, and the two families from that time became one.

About this time bishop Talbot also gave preferments to Mr Butler and Mr Benson, whose rise and progress in the church is here interwoven with the history of Mr Secker. In the winter of 1725-6, Mr Butler first published his incomparable sermons; on which, as Dr Beilby Porteous and Dr Stinton inform us, Mr Secker took pains to render the style more familiar, and the author's meaning more obvious: yet they were at last by many called obscure. Mr Secker gave his friend the same assistance in that noble work the *Analogy of Religion*, &c.

He now gave up all the time he possibly could to his residence at Houghton, applying himself with alacrity to all the duties of a country clergyman, and supporting that useful and respectable character throughout with the strictest propriety. He omitted nothing which he thought would be of use to the souls and bodies of the people entrusted to his care. He brought down his conversation and his sermons to the level of their understandings; he visited them in private, he catechised the young and ignorant, he received his country neighbours and tenants very kindly and hospitably, and was of great service to the poorer sort of them by his skill in physic, which was the only use he ever made of it. Though this place was in a very remote part of the world, yet the solitude of it perfectly suited his studious disposition, and the income arising from it bounded his ambition. Here he would have been content to live and die; here, as he has often been heard to declare, he spent some of the happiest hours of his life; and it was no thought or choice of his own that removed him to an higher and more public sphere; but Mrs Secker's health, which now began to be very bad, and was thought to be injured by the dampness of the situation, obliged him to think of exchanging it for a more healthy one. Accordingly, an exchange was made through the friendly interposition of Mr Benson (who generously sacrificed his own interest on this occasion, by relinquishing a prebend of his own to serve his friend) with Dr Finney, prebendary of Durham, and rector of Ryton; and Mr Secker was instituted to Ryton and the prebend June 3. 1727. For the two following years he lived chiefly at Durham, going every week to officiate at Ryton, and spending there two or three months together in the summer.

In July 1732 he was appointed chaplain to the king; for which favour he was indebted to Dr Sherlock, who having heard him preach at Bath, had conceived the highest opinion of his abilities, and thought them well worthy of being brought forward into public notice. From that time an intimacy commenced between them, and he received from that great prelate many solid proofs of esteem and friendship,

His month of waiting at St James's happened to be August, and on Sunday the 27th of that month he preached before the queen, the king being then abroad. A few days after, her majesty sent for him into her closet, and held a long and gracious conversation with him; in the course of which he took an opportunity of mentioning to her his friend Mr Butler. He also, not long after this, on Mr Talbot's being made lord chancellor,

found means to have Mr Butler effectually recommended to him for his chaplain. The queen also appointed him clerk of her closet; from whence he rose, as his talents became more known, to those high dignities which he afterwards attained.

Secker.

Mr Secker now began to have a public character, and stood high in the estimation of those who were allowed to be the best judges of merit: he had already given proofs of abilities that plainly indicated the eminence to which he must one day rise, as a preacher and a divine; and it was not long before an opportunity offered of placing him in an advantageous point of view. Dr Tyrwhit, who succeeded Dr Clarke as rector of St James's in 1729, found that preaching in so large a church endangered his health. Bishop Gibson, therefore, his father-in-law, proposed to the crown that he should be made residentiary of St Paul's, and that Mr Secker should succeed him in the rectory. This arrangement was so acceptable to those in power, that it took place without any difficulty. Mr Secker was instituted rector the 18th of May 1733; and in the beginning of July went to Oxford to take his degree of Doctor of Laws, not being of sufficient standing for that of divinity. On this occasion it was that he preached his celebrated A&T Sermon, on the advantages and duties of academical education, which was universally allowed to be a masterpiece of sound reasoning and just composition: it was printed at the desire of the heads of houses, and quickly passed through several editions. It is now to be found in the second collection of *Occasional Sermons*, published by himself in 1766.

It was thought that the reputation he acquired by this sermon, contributed not a little toward that promotion which very soon followed its publication. For in December 1734, he received a very unexpected notice from bishop Gibson, that the king had fixed on him to be bishop of Bristol. Dr Benson was about the same time appointed to the see of Gloucester, as was Dr Fleming to that of Carlisle; and the three new bishops were all consecrated together in Lambeth Chapel, Jan. 19. 1734-5, the consecration-sermon being preached by Dr Thomas, afterwards bishop of Winchester.

The honours to which Dr Secker was thus raised in the prime of life did not in the least abate his diligence and attention to business; for which, indeed, there was now more occasion than ever. His learned biographers, Messrs Porteous and Stinton, now relate the manner in which he set about the visitation of his diocese, and the ceremony of confirmation, which he performed in a great number of places; he also preached in several churches, sometimes twice a-day. The affairs of his parish of St James's being likewise in great disorder, he took extraordinary pains to regulate and adjust every thing, particularly the management of the poor; and thus became of signal service to his parishioners, even in a temporal view. But, say our authors, "it was their spiritual welfare which engaged, as it ought to do, his chief attention. As far as the circumstances of the times, and the populousness of that part of the metropolis allowed, he omitted not even those private admonitions and personal applications which are often attended with the happiest effects. He allowed out of his own income a salary for reading early and late prayers, which had formerly been paid out of the offertory money. He held a confirmation once every year, and examined

Secker.

amined the candidates several weeks, before in the vestry, and gave them religious tracts, which he also distributed at other times very liberally to those that needed them. He drew up, for the use of his parishioners, that admirable course of *Lectures on the Church Catechism* which hath been lately published, and not only read them once every week on the usual days, but also every Sunday evening, either at the church or one of the chapels belonging to it."

The sermons which at the same time, we are told, he set himself to compose, "were truly excellent and original. His faculties were now in their full vigour, and he had an audience to speak before that rendered the utmost exertion of them necessary. He did not, however, seek to gratify the higher part, by amusing them with refined speculations, or ingenious essays, unintelligible to the lower part, and unprofitable to both; but he laid before them all, with equal freedom and plainness, the great Christian duties belonging to their respective stations, and reproved the follies and vices of every rank among them, without distinction or palliation. He studied human nature thoroughly in all its various forms, and knew what sort of arguments would have most weight with each class of men. He brought the subject home to their bosoms, and did not seem to be merely saying useful things in their presence, but addressing himself personally to every one of them. Few ever possessed, in a higher degree, the rare talent of touching on the most delicate subjects with the nicest propriety and decorum, of saying the most familiar things without being low, the plainest without being feeble, the boldest without giving offence. He could descend with such singular ease and felicity into the minutest concerns of common life, could lay open with so much address the various workings, artifices, and evasions of the human mind, that his audience often thought their own particular cases alluded to, and heard with surprise their private sentiments and feelings, their ways of reasoning and principles of acting, exactly stated and described. His preaching was, at the same time, highly rational, and truly evangelical. He explained with perspicuity, he asserted with dignity, the peculiar characteristic doctrines of the gospel. He inculcated the utility, the necessity of them, not merely as speculative truths, but as actual instruments of moral goodness, tending to purify the hearts and regulate the lives of men; and thus, by God's gracious appointment, as well as by the inseparable connection between true faith and right practice, leading them to salvation.

"These important truths he taught with the authority, the tenderness, the familiarity, of a parent instructing his children. Though he neither possessed nor affected the artificial eloquence of an orator who wants to amuse or to mislead, yet he had that of an honest man who wants to convince, of a Christian preacher who wants to reform and to save those that hear him. Solid argument, manly sense, useful directions, short, nervous, striking sentences, awakening questions, frequent and pertinent applications of scripture; all these following each other in quick succession, and coming evidently from the speaker's heart, enforced by his elocution, his figure, his action, and above all by the corresponding sanctity of his example, stamped conviction on the minds of his hearers, and sent them home with impressions not easy to be effaced. It will readily be

imagined that with these powers he quickly became one of the most admired and popular preachers of his time."

In 1737 he succeeded to the see of Oxford, on the promotion of Dr Potter to that of Canterbury, then vacant by the death of Archbishop Wake.

In the spring of 1748, Mrs Secker died of the gout in her stomach. She was a woman of great sense and merit, but of a weak and sickly constitution. The bishop's affection and tenderness for her was suited to his character. In 1750, he was installed dean of St Paul's, for which he gave in exchange the rectory of St James's and his prebend of Durham. "It was no wonder (say our authors) that, after presiding over so extensive and populous a parish for upwards of 17 years, he should willingly consent to be released from a burden which began now to grow too great for his strength. When he preached his farewell sermon, the whole audience melted into tears: he was followed with the prayers and good wishes of those whom every honest man would be most ambitious to please; and there are numbers still living who retain a strong and grateful remembrance of his incessant and tender solicitude for their welfare. Having now more leisure both to prosecute his own studies and to encourage those of others, he gave Dr Church considerable assistance in his *First and Second Vindication of the Miraculous Powers*, &c. against Dr Middleton, and he was of equal use to him in his *Analysis of Lord Bolingbroke's Works*. About the same time began the late Archdeacon Sharp's controversy with the followers of Mr Hutchinson, which was carried on to the end of the year 1755." Bishop Secker, we are told, read over all Dr Sharp's papers, amounting to three volumes 8vo, and corrected and improved them throughout. But the ease which this late change of situation gave him was soon disturbed by a heavy and unexpected stroke, the loss of his three friends, Bishops Butler, Benson, and Berkeley, who were all cut off within the space of one year.

Our authors next give an account of the part which Dr Secker bore, in the House of Lords, in respect to the famous repeal of the Jew bill; for which the duke of Newcastle moved, and was seconded by the Bishop, in a speech which, we are told, was remarkably well received. At length his distinguished merit prevailed over all the political obstacles to his advancement, and placed him, without any efforts or application of his own, in that important station which he had shown himself so well qualified to adorn. On the death of archbishop Hutton, he was promoted to the see of Canterbury, and was confirmed at Bow-church, April 21. 1758; on which occasion our authors observe, that in accepting this high and burdensome station, Dr Secker acted on that principle which influenced him through life; that he sacrificed his own ease and comfort to considerations of public utility; that the mere secular advantages of grandeur were objects below his ambition; and were, as he knew and felt, but poor compensations for the anxiety and difficulties attending them. He had never once through his whole life asked preferment for himself, nor shown any unbecoming eagerness for it; and the use he made of his newly acquired dignity very clearly showed, that rank, and wealth, and power, had in no other light any charms for him, than as they enlarged the sphere of his active and industrious benevolence.

Secker.

He sought out and encouraged men of real genius or extensive knowledge; he expended 300 l. in arranging and improving the manuscript library at Lambeth; and observing with concern, that the library of printed books in that palace had received no additions since the time of Archbishop Tennison, he made it his business to collect books in all languages from most parts of Europe at a very great expence, with a view of supplying that chasm; which he accordingly did, by leaving them to the library at his death, and thereby rendered that collection one of the noblest and most useful in the kingdom.

All designs and institutions which tended to advance good morals and true religion, he patronized with zeal and generosity: he contributed largely to the maintenance of schools for the poor; to rebuilding or repairing parsonage houses and places of worship; and gave no less than 600 l. towards erecting a chapel in the parish of Lambeth. To the society for promoting Christian knowledge he was a liberal benefactor; and to that for propagating the gospel in foreign parts, of which he was the president, he paid much attention; was constant at all the meetings of its members, even sometimes when his health would but ill permit, and superintended their deliberations with consummate prudence and temper.

Whenever any publications came to his knowledge that were manifestly calculated to corrupt good morals, or subvert the foundations of Christianity, he did his utmost to stop the circulation of them; yet the wretched authors themselves he was so far from wishing to treat with any undue rigour, that he has more than once extended his bounty to them in distress. And when their writings could not properly be suppressed (as was too often the case) by lawful authority, he engaged men of abilities to answer them, and rewarded them for their trouble. His attention was everywhere. Even the falsehoods and misrepresentation of writers in the newspapers, on religious or ecclesiastical subjects, he generally took care to have contradicted; and when they seemed likely to injure, in any material degree, the cause of virtue and religion, or the reputation of eminent and worthy men, he would sometimes take the trouble of answering them himself. One instance of this kind, which does him honour, and deserves mention, was his defence of Bishop Butler, who, in a pamphlet published in 1767, was accused of having died a Papist. The conduct which he observed towards the several divisions and denominations of Christians in this kingdom was such as showed his way of thinking to be truly liberal and catholic. The dangerous spirit of popery, indeed, he thought should always be kept under proper legal restraints, on account of its natural opposition not only to the religious but the civil rights of mankind. He therefore observed its movements with care, and exhorted his clergy to do the same, especially those who were situated in the midst of Roman Catholic families; against whose influence they were charged to be upon their guard, and were furnished with proper books or

Vol. XVII. Part I.

instructions for that purpose. He took all fit opportunities of combating the errors of the church of Rome in his own writings (A); and the best answers that were published to some of the late bold apologies for popery were written at his instance, and under his direction.

With the Dissenters his Grace was sincerely desirous of cultivating a good understanding. He considered them, in general, as a conscientious and valuable class of men. With some of the most eminent of them, Watts, Doddridge, Leland, Chandler, Lardner, he maintained an intercourse of friendship or civility. By the most candid and considerate part of them he was highly revered and esteemed; and to such among them as needed help he showed no less kindness and liberality than to those of his own communion.

Nor was his concern for the Protestant cause confined to his own country. He was well known as the great patron and protector of it in various parts of Europe; from whence he had frequent applications for assistance, which never failed of being favourably received. To several foreign Protestants he allowed pensions, to others he gave occasional relief, and to some of their universities was an annual benefactor.

In public affairs, his Grace acted the part of an honest citizen, and a worthy member of the British legislature. From his first entrance into the House of Peers, his parliamentary conduct was uniformly upright and noble. He kept equally clear from the extremes of factious petulance and servile dependence; never wantonly thwarting administration from motives of party zeal or private pique, or personal attachment, or a passion for popularity; nor yet going every length with every minister from views of interest or ambition. He admired and loved the constitution of his country, and wished to preserve it unaltered and unimpaired. So long as a due regard to this was maintained, he thought it his duty to support the measures of government; but whenever they were evidently inconsistent with the public welfare, he opposed them with freedom and firmness. Yet his opposition was always tempered with the utmost fidelity, respect, and decency, to the excellent prince upon the throne; and the most candid allowances for the unavoidable errors and infirmities even of the very best ministers, and the peculiarly difficult situation of those who govern a free and high-spirited people. He seldom spoke in parliament, except where the interests of religion and virtue seemed to require it; but whenever he did, he spoke with propriety and strength, and was heard with attention and deference. Though he never attached himself blindly to any set of men, yet his chief political connections were with the late Duke of Newcastle and Lord Chancellor Hardwicke. To these he principally owed his advancement; and he had the good fortune to live long enough to show his gratitude to them or their descendants.

During more than ten years that Dr Secker enjoyed the see of Canterbury, he resided constantly at his archiepiscopal house at Lambeth. A few months before his death, the dreadful pains he felt had compelled

G g him

(A) See particularly his sermons on the rebellion in 1745; on the Protestant working schools in Ireland; on the 5th of November; and a great number of occasional passages to the same purpose, in various parts of his lectures, sermons, and other works.

Secker.

him to think of trying the Bath waters; but that design was stopped by the fatal accident which put an end to his life.

His Grace had been for many years subject to the gout, which, in the latter part of his life, returned with more frequency and violence, and did not go off in a regular manner, but left the parts affected for a long time very weak, and was succeeded by pains in different parts of the body. About a year and a half before he died, after a fit of the gout, he was attacked with a pain in the arm, near the shoulder, which having continued about 12 months, a similar pain seized the upper and outer part of the opposite thigh, and the aim soon became easier. This was much more grievous than the former, as it quickly disabled him from walking, and kept him in almost continual torment, except when he was in a reclining position. During this time he had two or three fits of the gout; but neither the gout nor the medicines alleviated these pains, which, with the want of exercise, brought him into a general bad habit of body.

On Saturday July 30. 1768, he was seized, as he sat at dinner, with a sickness at his stomach. He recovered before night; but the next evening, while his physicians were attending, and his servants raising him on his couch, he suddenly cried out that his thigh-bone was broken. The shock was so violent, that the servants perceived the couch to shake under him, and the pain so acute and unexpected, that it overcame the firmness he so remarkably possessed. He lay for some time in great agonies; but when the surgeons arrived, and discovered with certainty that the bone was broken, he was perfectly resigned, and never afterwards asked a question about the event. A fever soon ensued. On Tuesday he became lethargic, and continued so till about five o'clock on Wednesday afternoon, when he expired with great calmness, in the 75th year of his age.

On examination, the thigh-bone was found to be carious about four inches in length, and at nearly the same distance from its head. The disease took its rise from the internal part of the bone, and had so entirely destroyed its substance, that nothing remained at the part where it was broken but a portion of its outward integument; and even this had many perforations, one of which was large enough to admit two fingers, and was filled with a fungous substance arising from within the bone. There was no appearance of matter about the caries, and the surrounding parts were in a sound state. It was apparent that the torture which he underwent during the gradual corrosion of this bone must have been inexpressibly great. Out of tenderness to his family he seldom made any complaints to them, but to his physicians he frequently declared his pains were so excruciating, that unless some relief could be procured he thought it would be impossible for human nature to support them long. Yet he bore them for upwards of six months with astonishing patience and fortitude; sat up generally the greater part of the day, admitted his particular friends to see him, mixed with his family at the usual hours, sometimes with his usual cheerfulness; and, except some very slight defects of memory, retained all his faculties and senses in their full vigour till within a few days of his death. He was buried, pursuant to his own directions, in a covered passage, lead-

ing from a private door of the palace to the north door of Lambeth church; and he forbade any monument or epitaph to be placed over him.

By his will he appointed the Rev. Dr Daniel Burton, canon of Christ-church, and Mrs Catherine Talbot, already mentioned in the course of these memoirs, his executors; and left 12,000 l in trust to the Drs Porteous and Stinton, his chaplains; to pay the interest thereof to Mrs Talbot and her daughter during their joint lives, or the life of the survivor; and after the decease of both those ladies, 11,000 l. of the said 12,000 l. are to be transferred to charitable purposes; amongst which are 10,000 l. to the Society for the Propagation of the Gospel, and 1000 l. to the same society for a bishop or bishops in the king's dominions in America.

The following description is given of his person: He was tall and comely; in the early part of his life slender, and rather consumptive; but as he advanced in years his constitution gained strength, and his size increased, yet never to a degree of corpulency that was disproportionate or troublesome.

The dignity of his form corresponded with the greatness of his mind, and inspired at all times respect and awe; but peculiarly so when he was engaged in any of the more solemn functions of religion, into which he entered with such devout earnestness and warmth, with so just a consciousness of the place he was in, and the business he was about, as seemed to raise him above himself, and added new life and spirit to the natural gracefulness of his appearance.

His countenance was open, ingenuous, and expressive of every thing right. It varied easily with his spirits and his feelings, so as to be a faithful interpreter of his mind, which was incapable of the least dissimulation. It could speak dejection, and, on occasion, anger, very strongly; but when it meant to show pleasure or approbation, it softened into a most gracious smile, and diffused over all his features the most benevolent and revealing complacency that can be imagined.

SECOMIÆ, in natural history, the name of a genus of fossils of the class of septariæ; the characters of which are, That they are bodies of a dusky hue; divided, by septa or partitions of a sparry matter, into several more or less regular portions; of a moderately firm texture; not giving fire with steel; but fermenting with acid menstrua, and easily calcining. The septariæ of this genus are of all others the most common, and are what have been known by the little expressive or mistaken names of the waxen vein, or ludus Helmontii. We have many species of these bodies common among us. Of the whitish or brownish, we have thirteen; of the yellowish five; and of the ferruginous ones four.

SECOND, in geometry, chronology, &c. the 60th part of a prime or minute, whether of a degree or of an hour.

SECOND, in music, one of the musical intervals; being only the difference between any sound and the next nearest sound, whether above or below it.

SECOND Major, in music. See INTERVAL.

SECOND Minor, in music. See INTERVAL.

SECOND Sight, in Erse called *Taisch*, is a mode of seeing superadded to that which nature generally bestows. This gift or faculty, which is neither voluntary

Secker  
second.

*Second.* nor constant, is in general rather troublesome than agreeable to the possessors of it, who are chiefly found among the inhabitants of the Highlands of Scotland, those of the Western Isles, of the Isle of Man, and of Ireland. It is an impression made either by the mind upon the eye, or by the eye upon the mind, by which things distant or future are perceived, and seen as if they were present. A man on a journey far from home falls from his horse; another, who is perhaps at work about the house, sees him bleeding on the ground, commonly with a landscape of the place where the accident befalls him. Another seer, driving home his cattle, or wandering in idleness, or musing in the sunshine, is suddenly surpris'd by the appearance of a bridal ceremony, or funeral procession, and counts the mourners or attendants, of whom, if he knows them, he relates the names; if he knows them not, he can describe the dresses. Things distant are seen at the instant when they happen.

Of things future, Johnson says that he knows no rule pretended to for determining the time between the sight and the event; but we are inform'd by Mr Grose, that in general the time of accomplishment bears some relation to the time of the day in which the impressions are received. Thus visions seen early in the morning (which seldom happens) will be much sooner accomplished than those appearing at noon; and those seen at noon will take place in a much shorter time than those happening at night; sometimes the accomplishment of the last does not fall out within a year or more.

These visions are not confined to solemn or important events; nor is it true, as is commonly reported, that to the second sight nothing is presented but phantoms of evil. The future visit of a mountebank, or piper; a plentiful draught of fish; the arrival of common travellers; or, if possible, still more trifling matters than these,—are foreseen by the seers. A gentleman told Dr Johnson, that when he had once gone far from his own island one of his labouring servants predicted his return, and described the livery of his attendant, which he had never worn at home; and which had been, without any previous design, occasionally given him.

As many men eminent for science and literature have admitted the reality of this apparently useless gift, we shall, without interposing our own opinion, give the reflections of two of the first characters of the age upon it, and leave our readers to form their own judgment. By Dr Beattie of Aberdeen it is thus accounted for.

The Highlands of Scotland are a picturesque but a melancholy country. Long tracts of mountainous desert, covered with dark heath, and often obscured by misty weather; narrow valleys, thinly inhabited, and bounded by precipices resounding with the fall of torrents; a soil so rugged, and a climate so dreary, as in many parts to admit neither the amusements of pasturage nor the labours of agriculture; the mournful dashing of waves along the friths and lakes that intersect the country; the portentous noises which every change of the wind and every increased diminution of

the waters is apt to raise in a lonely region full of echoes and rocks and caverns; the grotesque and ghastly appearance of such a landscape by the light of the moon: objects like these diffuse a gloom over the fancy, which may be compatible enough with occasional and social merriment, but cannot fail to tincture the thoughts of a native in the hour of silence and solitude. If these people, notwithstanding their reformation in religion, and more frequent intercourse with strangers, do still retain many of their old superstitions, we need not doubt but in former times they must have been much more enslaved to the horrors of imagination, when beset with the bugbears of Popery and Paganism. Most of their superstitions are of a melancholy cast. That of *second sight*, by which some are still supposed to be haunted, is considered by themselves as a misfortune, on account of the many dreadful images it is said to obtrude upon the fancy. It is said that some of the Alpine regions do likewise lay claim to a sort of second sight. Nor is it wonderful, that persons of a lively imagination, immured in deep solitude, and surrounded with the stupendous scenery of clouds, precipices, and torrents, should dream (even when they think themselves awake) of those few striking ideas with which their lonely lives are diversified: of corpses, funeral processions, and other subjects of terror; or of marriages, and the arrival of strangers, and such like matters of more agreeable curiosity.

Let it be observed also, that the ancient Highlanders of Scotland had hardly any other way of supporting themselves than by hunting, fishing, or war; professions that are continually exposed to fatal accidents. And hence, no doubt, additional horrors would often haunt their solitude, and a deeper gloom overshadow the imagination even of the hardiest native.

A sufficient evidence can hardly be found for the reality of the *second sight*, or at least of what is commonly understood by that term. A treatise on the subject was published in the year 1762, in which many tales were told of persons whom the author believed to have been favoured, or haunted, with these illuminations; but most of the tales were trifling and ridiculous: and the whole work betrayed, on the part of the compiler, such extreme credulity, as could not fail to prejudice many readers against his system.

That any of these visionaries are apt to be swayed in their declarations by sinister views, we will not say; but this may be said with confidence, that none but ignorant people pretend to be gifted in this way. And in them it may be nothing more, perhaps, than short fits of sudden sleep or drowsiness, attended with lively dreams, and arising from some bodily disorder, the effect of idleness, low spirits, or a gloomy imagination. For it is admitted, even by the most credulous Highlanders, that as knowledge and industry are propagated in their country, the second sight disappears in proportion; and nobody ever laid claim to the faculty who was much employed in the intercourse of social life (A).

G g 2

Nor

(A) This, however, is denied by Johnson, who affirms that the Islanders of all degrees, whether of rank or understanding, universally admit it except the ministers, who, according to him, reject it, in consequence of a system, against conviction. He affirms, too, that in 1773 there was in the Hebrides a second-sighted gentleman, who complained of the terrors to which he was exposed.

Second.

Nor is it at all extraordinary, that one should have the appearance of being awake, and should even think one's self so, during those fits of dozing; that they should come on suddenly, and while one is engaged in some business. The same thing happens to persons much fatigued, or long kept awake, who frequently fall asleep for a moment, or for a long space, while they are standing, or walking, or riding on horseback. Add but a lively dream to this slumber, and (which is the frequent effect of disease) take away the consciousness of having been asleep, and a superstitious man may easily mistake his dream for a waking vision; which, however, is soon forgotten when no subsequent occurrence recalls it to his memory; but which, if it shall be thought to resemble any future event, exalts the poor dreamer into a Highland prophet. This conceit makes him more reclusive and more melancholy than ever; and so feeds his disease, and multiplies his visions: which, if they are not dissipated by business or society, may continue to haunt him as long as he lives; and which, in their progress through the neighbourhood, receive some new tinctures of the marvellous from every mouth that promotes their circulation. As to the prophetic nature of this second sight, it cannot be admitted at all. That the Deity should work a miracle in order to give intimation of the frivolous things that these tales are made up of, the arrival of a stranger, the nailing of a coffin, or the colour of a suit of clothes; and that these intimations should be given for no end, and to those persons only who are idle and solitary, who speak Gaelic, or who live among mountains and deserts—is like nothing in nature or providence that we are acquainted with; and must therefore, unless it were confirmed by satisfactory proof (which is not the case), be rejected as absurd and incredible.

These visions, such as they are, may reasonably enough be ascribed to a disordered fancy. And that in them, as well as in our ordinary dreams, certain appearances should, on some rare occasions, resemble certain events, is to be expected from the laws of chance; and seems to have in it nothing more marvellous or supernatural, than that the parrot, who deals out his scurrilities at random, should sometimes happen to salute the passenger by his right appellation.

To the confidence of these objections Dr Johnson replies, that by presuming to determine what is fit, and what is beneficial, they presuppose more knowledge of the universal system than man has attained; and therefore depend upon principles too complicated and extensive for our comprehension; and that there can be no security in the consequence when the premises are not understood; that the second sight is only wonderful because it is rare, for, considered in itself, it involves no more difficulty than dreams, or perhaps than the regular exercise of the cogitative faculty; that a general opinion of communicative impulses, or visionary representations, has prevailed in all ages and all nations; that particular instances have been given with such evidence, as neither Bacon nor Bayle has been able to resist; that sudden impressions, which the event has verified, have been felt by more than own or publish them; that the second sight of the Hebrides implies only the local frequency of a power, which is nowhere totally unknown; and that where we are unable to decide by antecedent reason, we must be content to yield to the force of tes-

timony. By pretension to second sight, no profit was ever fought or gained. It is an involuntary affection, in which neither hope nor fear are known to have any part. Those who profess to feel it do not boast of it as a privilege, nor are considered by others as advantageously distinguished. They have no temptation to feign, and their hearers have no motive to encourage the imposture.

*SECOND Terms*, in algebra, those where the unknown quantity has a degree of power less than it has in the term where it is raised to the highest. The art of throwing these second terms out of an equation, that is, of forming a new equation where they have no place, is one of the most ingenious and useful inventions in all algebra.

**SECONDARY**, in general, something that acts as second or in subordination to another.

*SECONDARY*, or *Secondary*, an officer who acts as second or next to the chief officer. Such are the secondaries of the courts of king's bench and common pleas; the secondaries of the compters, who are next the sheriffs of London in each of the two compters; two secondaries of the pipe; secondaries to the remembrancers, &c.

*SECONDARY Circles of the Ecliptic* are circles of longitude of the stars; or circles which, passing through the poles of the ecliptic, are at right angles to the ecliptic. See *CIRCLES of Latitude*.

*SECONDARY Qualities of Bodies*. See *METAPHYSICS*, n<sup>o</sup> 153.

**SECONDAT**. See *MONTESQUIEU*.

**SECRETARIES BIRD**, the falco serpentarius and fagittarius of Linnæus, but classed by Latham under the genus *VULTUR*; which see.

**SECRETARY**, an officer who, by his master's orders, writes letters, dispatches, and other instruments, which he renders authentic by his signet. Of these there are several kinds; as, 1. Secretaries of state, who are officers that have under their management and direction the most important affairs of the kingdom, and are obliged constantly to attend on the king: they receive and dispatch whatever comes to their hands, either from the crown, the church, the army, private grants, pardons, dispensations, &c. as likewise petitions to the sovereign, which, when read, are returned to them; all which they dispatch according to the king's direction. They have authority to commit persons for treason, and other offences against the state, as conservators of the peace at common law, or as justices of the peace throughout the kingdom. They are members of the privy-council, which is seldom or never held without one of them being present. As to the business and correspondence in all parts of this kingdom, it is managed by either of the secretaries without any distinction; but with respect to foreign affairs, the business is divided into two provinces or departments, the southern and the northern, comprehending all the kingdoms and states that have any intercourse with Great Britain; each secretary receiving all letters and addresses from, and making all dispatches to, the several princes and states comprehended in his province. Ireland and the Plantations are under the direction of the elder secretary, who has the southern province, which also comprehends France, Italy, Switzerland, Spain, Portugal, and Turkey; the northern province includes the Low Countries,

Second  
||  
Secretary.

**Secretion** tries, Germany, Denmark, Sweden, Poland, and Muscovy. Each of the secretaries has an apartment in all the royal houses, both for their own accommodation and their officers; they have also a table at the king's charge, or else board-wages. The two secretaries for Britain have each two under secretaries, and one chief clerk; with an uncertain number of other clerks and translators, all wholly depending on them. To the secretaries of state belong the custody of that seal properly called the *signet*, and the direction of two other offices, one called the *paber-office*, and the other the *signet office*. In addition to these, there is at present (179;) a secretary for the war department, whose office must be temporary. 2. Secretary of an embassy, a person attending an ambassador, for writing dispatches relating to the negotiation. There is a great difference between the secretary of an embassy and the ambassador's secretary; the last being a domestic or menial of the ambassador, and the first a servant or minister of the prince. 3. The secretary of war, an officer of the war-office, who has two chief clerks under him, the last of which is the secretary's messenger. There are also secretaries in most of the other offices.

**SECRETION**, in the animal œconomy. See **PHYSIOLOGY**, sect. VI.

**SECT**, a collective term, comprehending all such as follow the doctrines and opinions of some famous divine, philosopher, &c.

**SECTION**, in general, denotes a part of a divided thing, or the division itself. Such, particularly, are the subdivisions of a chapter; called also *paragraphs* and *articles*: the mark of a section is §.

**SECTION**, in geometry, denotes a side or surface of a body or figure cut off by another; or the place where lines, planes, &c. cut each other.

**SECTOR**, in geometry, is a part of a circle comprehended between two radii and the arch; or it is a mixed triangle, formed by two radii and the arch of a circle.

**SECTOR**, is also a mathematical instrument, of great use in finding the proportion between quantities of the same kind: as between lines and lines, surfaces and surfaces, &c. whence the French call it the *compass of proportion*. The great advantage of the sector above the common scales, &c. is, that it is made so as to fit all radii and all scales. By the lines of chords, sines, &c. on the sector, we have lines of chords, sines, &c. to any radius betwixt the length and breadth of the sector when open.

The real inventor of this valuable instrument is unknown; yet of so much merit has the invention appeared, that it was claimed by Galileo, and disputed by nations.

The sector is founded on the fourth proposition of the sixth book of Euclid; where it is demonstrated, that similar triangles have their homologous sides proportional. An idea of the theory of its construction may be conceived thus. Let the lines AB, AC (Plate CCCCXLVIII. fig. 5.) represent the legs of the sector; and AD, AE, two equal sections from the centre: if, now the points CB and DE be connected, the lines CB and DE will be parallel; therefore the triangles ADE,

ACB will be similar; and consequently the sides AD, DE, AB, and BC, proportional; that is, as AD : DE :: AB : BC : whence, if AD be the half, third, or fourth part of AB; DE will be a half, third, or fourth part of CB: and the same holds of all the rest. If, therefore, AD be the chord, sine, or tangent, of any number of degrees to the radius AB; DE will be the same to the radius BC.

Sector.

*Description of the Sector.* The instrument consists of two rulers or legs, of brass or ivory, or any other matter, representing the radii, moveable round an axis or joint, the middle of which expresses the centre; whence are drawn on the faces of the rulers several scales, which may be distinguished into single and double.

The double scales, or lines graduated upon the faces of the instrument, and which are to be used as sectoral lines, proceed from the centre; and are, 1. Two scales of equal parts, one on each leg, marked LIN. or L. each of these scales, from the great extensiveness of its use, is called the *line of lines*. 2. Two lines of chords marked CHO. or C. 3. Two lines of secants marked SEC. or S. A line of polygons marked POL. Upon the other face the sectoral lines are, 1. Two lines of sines marked SIN. or S. 2. Two lines of tangents marked TAN. or T. 3. Between the line of tangents and sines there is another line of tangents to a lesser radius, to supply the defect of the former, and extending from 45° to 75°, marked t.

Each pair of these lines (except the line of polygons) is so adjusted as to make equal angles at the centre; and consequently at whatever distance the sector be opened, the angles will be always respectively equal. That is, the distance between 10 and 10 on the line of lines, will be equal to 60 and 60 on the line of chords, 90 and 90 on the line of sines, and 45 and 45 on the line of tangents.

Besides the sectoral scales, there are others on each face, placed parallel to the outward edges, and used as those of the common plane scale. 1. These are a line of inches. 2. A line of latitudes. 3. A line of hours. 4. A line of inclination of meridians. 5. A line of chords. Three logarithmic scales, namely, one of numbers, one of lines, and one of tangents; these are used when the sector is fully opened, the legs forming one line (A).

The value of the divisions on most of the lines are determined by the figures adjacent to them; these proceed by tens, which constitute the divisions of the first order, and are numbered accordingly; but the value of the divisions on the line of lines, that are distinguished by figures, is entirely arbitrary, and may represent any value that is given to them; hence the figures 1, 2, 3, 4, &c. may denote either 10, 20, 30, 40, or 100, 200, 300, 400, and so on.

The *line of lines* is divided into ten equal parts, numbered 1, 2, 3, to 10; these may be called *divisions of the first order*; each of these are again subdivided into 10 other equal parts, which may be called *divisions of the second order*; each of these is divided into two equal parts, forming *divisions of the third order*. The divisions on all the scales are contained between four parallel lines; those

To read and estimate the divisions on the sector and lines.

(A) The lines are placed in different orders on different sectors, but they may easily be found by these general directions.

Sector. those of the third order extend to the most distant; those of the third to the least; those of the second to the intermediate parallel.

When the whole line of lines represents 100, the divisions of the first order, or those to which the figures are annexed, represent tens; those of the second order units; those of the third order the halves of these units. If the whole line represent ten, then the divisions of the first order are units; those of the second tenths; the thirds twentieths.

In the line of tangents, the divisions to which the numbers are affixed, are the degrees expressed by those numbers. Every fifth degree is denoted by a line somewhat longer than the rest; between every number and each fifth degree, there are four divisions, longer than the intermediate adjacent ones, these are whole degrees; the shorter ones, or those of the third order, are 30 minutes.

From the centre, to 60 degrees, the line of sines is divided like the line of tangents, from 60 to 70; it is divided only to every degree, from 70 to 80, to every two degrees, from 80 to 90; the division must be estimated by the eye.

The divisions on the line of chords are to be estimated in the same manner as the tangents.

The lesser line of tangents is graduated every two degrees, from 45 to 50; but from 50 to 60 to every degree; from 60 to the end, to half degrees.

The line of secants from 0 to 10 is to be estimated by the eye; from 20 to 50, it is divided to every two degrees; from 50 to 60, to every degree; from 60 to the end, to every half degree.

4  
Division of a given line by the line of equal parts.

*Use of the Line of Equal Parts on the Sector.* 1. To divide a given line into any number of equal parts, suppose seven. Take the given line in your compasses, and setting one foot in a division of equal parts, that may be divided by seven, for example 70, whose seventh part is 10, open the sector till the other point fall exactly on 70, in the same line on the other leg. In this disposition, applying one point of the compasses to 10 in the same line; shut them till the other fall in 10 in the same line on the other leg, and this opening will be the seventh part of the given line. Note, if the line to be divided be too long to be applied to the legs of the sector, divide only one half or one fourth by seven, and the double or quadruple thereof will be the seventh part of the whole.

5  
To measure the perimeter of a polygon

2. To measure the lines of the perimeter of a polygon, one of which contains a given number of equal parts. Take the given line in your compasses, and set it parallel, upon the line of equal parts, to the number on each leg expressing its length. The sector remaining thus, set off the length of each of the other lines parallel to the former, and the number each of them shall on will express its length.

6  
Subtraction.

3. A right line being given, and the number of parts it contains, suppose 120, to take from it a shorter line, containing any number of the same parts, suppose 25. Take the given line in your compasses, open the sector till the two feet fall on 120 on each leg; then will the distance between 25 on one leg, and the same number on the other, give the line required.

7  
Multiplication.

4. To multiply by the line of equal parts on the sector. Take the lateral distance from the centre of the

line to the given multiplicator; open the sector till you fit that lateral distance to the parallel of 1 and 1, or 10 and 10, and keep the sector in that disposition; then take in the compasses the parallel distance of the multiplicand, which distance, measured laterally on the same line, will give the product required. Thus, suppose it were required to find the product of 8 multiplied by 4: take the lateral distance from the centre of the line to 4 in your compasses, i. e. place one foot of the compasses in the beginning of the divisions, and extend the other along the line to 4. Open the sector till you fit this lateral distance to the parallel of 1 and 1, or 10 and 10. Then take the parallel distance of 8, the multiplicand; i. e. extend the compasses from 8, in this line, on one leg, to 8 in the same line on the other; and that extent, measured laterally, will give the product required.

Sector.

5. To divide by the line of equal parts on the sector. Extend the compasses laterally from the beginning of the line to 1, and open the sector till you fit that extent to the parallel of the divisor; then take the parallel distance of the dividend, which extent, measured in a lateral direction, will give the quotient required. Thus, suppose it was required to divide 36 by 4; extend the compasses laterally, the beginning of the line to 1, and fit to that extent the parallel of 4, the divisor; then extend the compasses parallel, from 36 on one leg to 36 on the other, and that extent, measured laterally, will give 9, the quotient required.

8  
Division in general.

6. Proportion by the line of equal parts. Make the lateral distance of the second term the parallel distance of the first term, the parallel distance of the third term is the fourth proportional. *Example.* To find a fourth proportional to 8, 4, and 6, take the lateral distance of 4, and make it the parallel distance of 8; then the parallel distance of 6, extended from the centre, shall reach to the fourth proportional 3.

9  
Proportion

In the same manner, a third proportional is found to two numbers. Thus, to find a third proportional to 8 and 4, the sector remaining as in the former example, the parallel distance of 4, extended from the centre, shall reach to the third proportional 2. In all these cases, if the number to be made a parallel distance be too great for the sector, some aliquot part of it is to be taken, and the answer is to be multiplied by the number by which the first number was divided.

10  
Line of chords.

*Use of the Line of Chords on the Sector.* 1. To open the sector so as the two lines of chords may make an angle or number of degrees, suppose 40. Take the distance from the joint to 40, the number of the degrees proposed, on the line of chords; open the sector till the distance from 60 to 60, on each leg, be equal to the given distance of 40; then will the two lines on the sector form an angle of 40 degrees, as was required.

2. The sector being opened, to find the degrees of its aperture. Take the extent from 60 to 60, and lay it off on the line of chords from the centre; the number whereon it terminates will show the degrees, &c. required.

3. To lay off any number of degrees upon the circumference of a circle. Open the sector till the distance between 60 and 60 be equal to the radius of the given circle; then take the parallel extent of the chord of the number of degrees on each leg of the sector, and

lay



lay it off on the circumference of the given circle.— Hence any regular polygon may be easily inscribed in a given circle.

*Use of the Line of Polygons on the SECTOR.* 1. To inscribe a regular polygon in a given circle. Take the semidiameter of the given circle in the compasses, and adjust it to the number 6, on the line of polygons, on each leg of the sector: then, the sector remaining thus opened, take the distance of the two equal numbers, expressing the number of sides the polygon is to have; *e. gr.* the distance from 5 to 5 for a pentagon, from 7 to 7 for a heptagon, &c. These distances carried about the circumference of the circle, will divide it into so many equal parts.

2. To describe a regular polygon, *e. gr.* a pentagon, on a given right line. Take the length of the line in the compasses, and apply it to the extent of the number 5, 5, on the lines of polygons. The sector thus opened, upon the same lines take the extent from 6 to 6; this will be the semidiameter of the circle the polygon is to be inscribed in. It then, with this distance, from the ends of the given line, you describe two arches of a circle, their intersection will be the centre of the circle.

3. On a right line, to describe an isocles triangle, having the angles at the base double that at the vertex. Open the sector, till the ends of the given line fall on 10 and 10 on each leg; then take the distance from 6 to 6. This will be the length of the two equal sides of the triangle.

*Use of the Lines of Sines, Tangents, and Secants, on the SECTOR.* By the several lines disposed on the sector, we have scales to several radii; so that having a length or radius given, not exceeding the length of the sector when opened, we find the chord, sine, &c. thereto: *e. gr.* Suppose the chord, sine, or tangent, of 10 degrees, to a radius of 3 inches required; make 3 inches the aperture, between 60 and 60, on the lines of chords of the two legs; then will the same extent reach from 45 to 45 on the line of tangents, and from 90 to 90 on the line of the sines on the other side; so that to whatever radius the line of chords is set, to the same are all the others set. In this disposition, therefore, if the aperture between 10 and 10, on the lines of chords, be taken with the compasses, it will give the chord of 10 degrees. If the aperture of 10 and 10 be in like manner taken on the lines of sines, it will be the sine of 10 degrees. Lastly, if the aperture of 10 and 10 be in like manner taken on the lines of tangents, it gives the tangent of 10 degrees.

If the chord, or tangent, of 70 degrees were required; for the chord, the aperture of half the arch, *viz.* 35, must be taken, as before; which distance, repeated twice, gives the chord of 70 degrees. To find the tangent of 70 degrees to the same radius, the small line of tangents must be used, the other only reaching to 45: making, therefore, 3 inches the aperture between 45 and 45 on the small line; the extent between 70 and 70 degrees on the same, will be the tangent of 70 degrees to 3 inches radius.

To find the secant of an arch, make the given radius the aperture between 0 and 0 on the lines of secants: then will the aperture of 10 and 10, or 70 and 70, on said lines, give the tangent of 10° or 70°.

If the converse of any of these things were required,

that is, if the radius be required, to which a given line is the sine, tangent, or secant, it is but making the given line, if a chord, the aperture on the line of chords, between 10 and 10, and then the sector will stand at the radius required; that is, the aperture between 60 and 60 on the said line is the radius. If the given line were a sine, tangent, or secant, it is but making it the aperture of the given number of degrees; then will the distance of 90 and 90 on the sines, of 45 and 45 on the tangents, of 0 and 0 on the secants, be the radius.

*Astronomical SECTOR.* See *ASTRONOMICAL SECTOR.*

*Dialing SECTOR.* See *DIALING.*

SECULAR, that which relates to affairs of the present world, in which sense the word stands opposed to *spiritual, ecclesiastical*: thus we say secular power, &c.

SECULAR, is more peculiarly used for a person who lives at liberty in the world, not shut up in a monastery, nor bound by vows, or subjected to the particular rules of any religious community; in which sense it stands opposed to *regular*. The Romish clergy are divided into secular and regular, of which the latter are bound by monastic rules, the former not.

*SECULAR Games*, in antiquity, solemn games held among the Romans once in an age. These games lasted three days and as many nights; during which time sacrifices were performed, theatrical shews exhibited, with combats, sports, &c. in the circus. The occasion of these games, according to Valerius Maximus, was to stop the progress of a plague. Valerius Publicola was the first who celebrated them at Rome in the year of the city 245. The solemnity was as follows: The whole world was invited by a herald to a feast which they had never seen already, nor ever should see again. Some days before the games began, the quindecimviri in the Capitol and the Palatine temple, distributed to the people purifying compositions, of various kinds, as flambeaus, sulphur, &c. From hence the populace passed to Diana's temple on the Aventine mount, with wheat, barley, and oats, as an offering. After this, whole nights were spent in devotion to the Deities. When the time of the games was fully come, the people assembled in the Campus Martius, and sacrificed to Jupiter, Juno, Apollo, Latona, Diana, the Paræ, Ceres, Pluto, and Proserpine. On the first night of the feast the emperor, with the quindecimviri, caused three altars to be erected on the banks of the Tiber, which they sprinkled with the blood of three lambs, and then proceeded to regular sacrifice. A space was next marked out for a theatre, which was illuminated with innumerable flambeaus and fires. Here they sung hymns, and celebrated all kinds of sports. On the day after, having offered victims at the Capitol, they went to the Campus Martius, and celebrated sports to the honour of Apollo and Diana. These lasted till next day, when the noble matrons, at the hour appointed by the oracle, went to the Capitol to sing hymns to Jupiter. On the third day, which concluded the solemnity, twenty-seven boys, and as many girls, sung in the temple of Palatine Apollo hymns and verses in Greek and Latin, to recommend the city to the protection of those deities whom they designed particularly to honour by their sacrifices.

The inimitable Carmen Seulare of Horace was composed for this last day, in the Secular Games, held by Augustus.

Sector,  
Secular.

Secular  
||  
Secundus.

It has been much disputed whether these games were held every hundred, or every hundred and ten years. Valerius Antius, Varro, and Livy, are quoted in support of the former opinion: In favour of the latter may be produced the quinquagesimal registers, the edicts of Augustus, and the words of Horace in the Secular poem,

*Catus undenos decies per annos.*

It was a general belief, that the girls who bore a part in the song should be soonest married; and that the children who did not dance and sing at the coming of Apollo, should die unmarried, and at an early period of life.

*SECULAR Poem*, a poem sung or rehearsed at the secular games; of which kind we have a very fine piece among the works of Horace, being a sapphic ode at the end of his epodes.

**SECULARIZATION**, the act of converting a regular person, place, or benefice, into a secular one. Almost all the cathedral churches were anciently regular, that is, the canons were to be religious; but they have been since secularized. For the secularization of a regular church, there is required the authority of the pope, that of the prince, the bishop of the place, the patron, and even the consent of the people. Religious that want to be released from their vow, obtain briefs of secularization from the pope.

**SECUNDINES**, in anatomy, the several coats or membranes wherein the fetus is wrapped up in the mother's womb; as the chorion and amnios, with the placenta, &c.

**SECUNDUS** (Joannes Nicolaius), an elegant writer of Latin poetry, was born at the Hague in the year 1511. His descent was from an ancient and honourable family in the Netherlands; and his father Nicolaus Everardus, who was born in the neighbourhood of Middleburg, seems to have been high in the favour of the emperor Charles V. as he was employed by that monarch in several stations of considerable importance. We find him first a member of the grand parliament or council of Mechelen, afterwards president of the states of Holland and Zealand at the Hague, and lastly holding a similar office at Mechelen, where he died, August 5. 1532, aged 70.

These various employments did not occupy the whole of Everardus's time. Notwithstanding the multiplicity of his business, he found leisure to cultivate letters with great success, and even to act as preceptor to his own children, who were five sons and three daughters. They all took the name of Nicolaii from their father; but on what account our author was called *Secundus* is not known. It could not be from the order of his birth, for he was the youngest son. Perhaps the name was not given him till he became eminent; and then, according to the fashion of the age, it might have its rise from some pun, such as his being *Poetarum nemini Secundus*. Poetry, however, was by no means the profession which his father wished him to follow. He intended him for the law, and when he could no longer direct his studies himself, placed him under the care of *Jacobus Valeardus*. This man is said to have been every way well qualified to discharge the important trust which was committed to him; and he certainly gained the affection of his pupil, who, in one of his poems,

mentions the death of Valeardus with every appearance of unfeigned sorrow. Another tutor was soon provided; but it does not appear that Secundus devoted much of his time to legal pursuits. Poetry and the sister arts of painting and sculpture had engaged his mind at a very early period; and the imagination, on which these have laid hold, can with difficulty submit to the dry study of musty civilians. Secundus is said to have written verses when but ten years old; and from the vast quantity which he left behind him, we have reason to conclude that such writing was his principal employment. He found time, however, to carve figures of all his own family, of his mistresses, of the emperor Charles V. of several eminent personages of those times, and of many of his intimate friends; and in the last edition of his works published by Scriverius at Leyden, 1631, there is a print of one of his mistresses with this inscription round it; *VATIS AMATORIS JULIA SCULPTA MANU*.

Secundus having nearly attained the age of twenty one, and being determined, as it would seem, to comply as far as possible with the wishes of his father, quitted Mechelen, and went to France, where at *Bourges*, a city in the *Orleanois*, he studied the civil law under the celebrated *Andreas Alciatus*. Alciatus was one of the most learned civilians of that age; but what undoubtedly endeared him much more to our author was his general acquaintance with polite literature, and more particularly his taste in poetry. Having studied a year under this eminent professor, and taken his degrees, Secundus returned to Mechelen, where he remained only a very few months. In 1533 he went into Spain with warm recommendations to the count of Nassau and other persons of high rank; and soon afterwards became secretary to the cardinal archbishop of Toledo in a department of business which required no other qualifications than what he possessed in a very eminent degree, a facility in writing with elegance the Latin language. It was during his residence with this cardinal that he wrote his *Bassa*, a series of wanton poems, of which the fifth, seventh, and ninth *carmina* of *Catullus* seem to have given the hint. Secundus was not, however, a servile imitator of *Catullus*. His expressions seem to be borrowed rather from *Tibullus* and *Propertius*; and in the warmth of his descriptions he surpasses every thing that has been written on similar subjects by *Catullus*, *Tibullus*, *Propertius*, *C. Gallus*, *Ovid*, or *Horace*.

In 1535 he accompanied the emperor Charles V. to the siege of Tunis, but gained no laurels as a soldier. The hardships which were endured at that memorable siege were but little suited to the soft disposition of a votary of Venus and the muses; and upon an enterprise which might have furnished ample matter for an epic poem, it is remarkable that Secundus wrote nothing which has been deemed worthy of preservation. Having returned from his martial expedition, he was sent by the cardinal to Rome to congratulate the pope upon the success of the emperor's arms; but was taken so ill on the road, that he was not able to complete his journey. He was advised to seek, without a moment's delay, the benefit of his native air; and that happily recovered him.

Having now quitted the service of the archbishop of Toledo, Secundus was employed in the same office of secretary by the bishop of Utrecht; and so much had

N° 1.



N° 2.



N° 3.



N° 4.

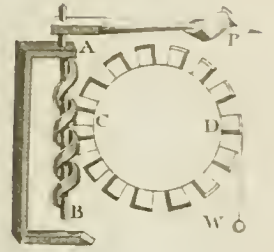

Machine for Freshening  
SEA WATER.

Fig. 1.

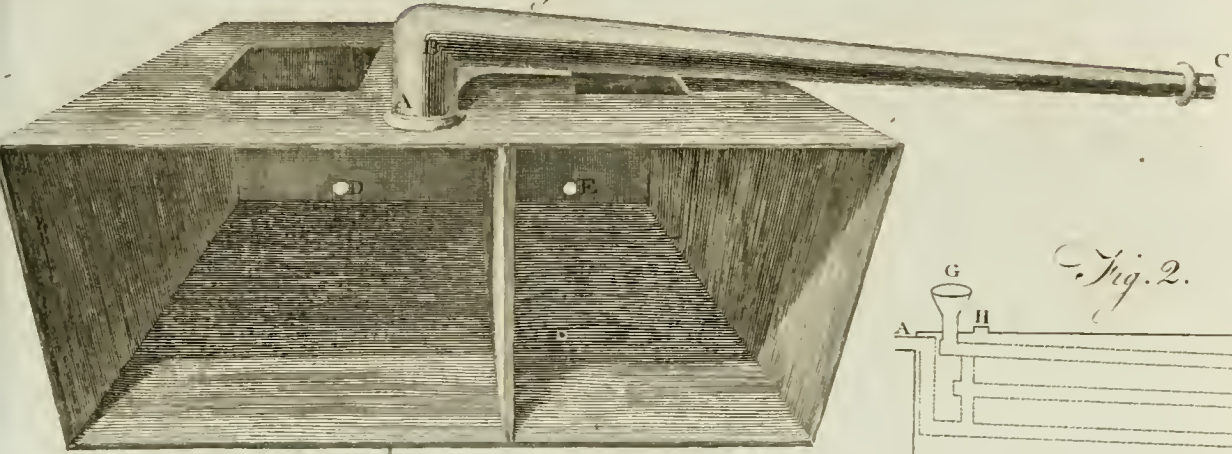
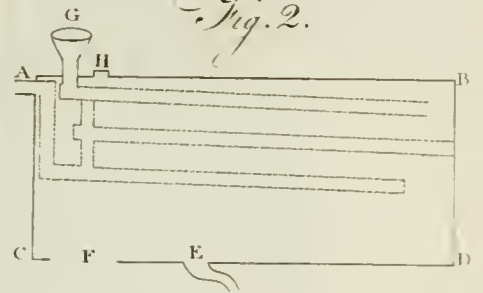

Fig. 2.



SECTOR.

Fig. 3.

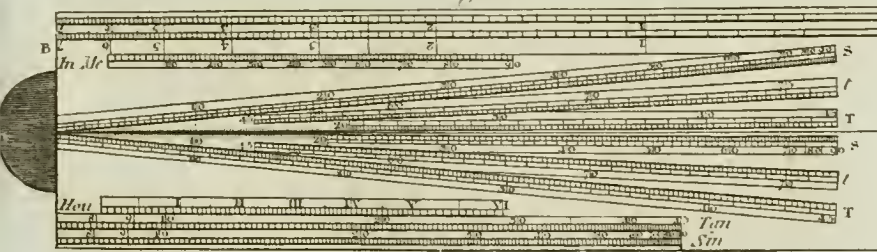

Fig. 4.

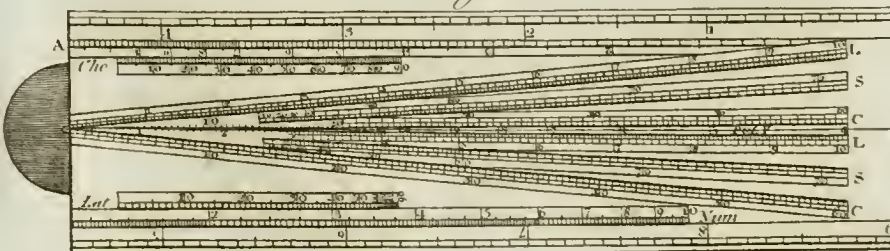
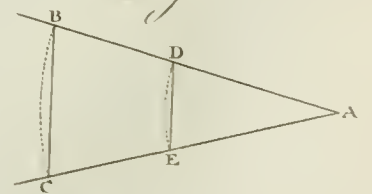

Fig. 5.



J. Bell, Pin. Mal. sculp.



he hitherto distinguished himself by the classical elegance of his compositions, that he was soon called upon to fill the important post of private Latin secretary to the emperor, who was then in Italy. This was the most honourable office to which our author was ever appointed; but before he could enter upon it death put a stop to his career of glory. Having arrived at *Saint Amand* in the district of *Tournay*, in order to meet, upon business, with the bishop of *Utrecht*, he was on the 8th of October 1536 cut off by a violent fever, in the very flower of his age, not having quite completed his twenty-fifth year. He was interred in the church of the *Benedictines*, of which his patron, the bishop, was *abbot* or *pro-abbot*; and his near relations erected to his memory a marble monument, with a plain Latin inscription.

The works of *Secundus* have gone through several editions, of which the best and most copious is that of *Scriverius* already mentioned. It consists of *JULIA, Eleg. Lib. 1.*; *AMORES, Eleg. Lib. 2.*; *AD DIVERSOS Eleg. Lib. 3.*; *BASIA*, styled by the editor *incomparabilis et divinus prorus liber*; *EPIGRAMMATA*; *ODARUM liber unus*; *EPISTOLARUM liber unus Elegiaca*; *EPISTOLARUM liber alter, heroico carmine scriptus*; *FUNERUM liber unus*; *SYLVÆ et CARMINUM fragmenta*; *POEMATA nonnulla fratrum*; *ITINERARIA Secundi tria, &c.*; *EPISTOLÆ toidem, soluta oratione*. Of these works it would be superfluous in us to give any character after the ample testimonies prefixed to them of *Lelius Greg. Gyraldus*, the elder *Scaliger*, *Theodore Beza*, and others equally celebrated in the republic of letters, who all speak of them with rapture. A French critic, indeed, after having affirmed that the genius of *Secundus* never produced any thing which was not excellent in its kind, adds, with too much truth, *Mais sa muse est un peu trop lascive*. For this fault our author makes the following apology in an epigram addressed to the grammarians;

Carmina cur spargam cunctis lasciva libellis,  
Queritis? Infulfos arceo grammaticos.  
Fortia magnanimi canerem si Cæsaris arma,  
Factave DIVORUM religioſa VIRUM:  
Quot miser exciperemque notas, pateretque lituras?  
Quot fierem teneris supplicium pueris?  
At nunc uda mihi distant cum BASIA carmen,  
Pruri et versu mentula multa meo;  
Me leget innuptæ juvenis placiturus amicæ,  
Et placitura nova blanda puella viro:  
Et quemcunque juvat lepidorum de grege vatum  
Otia festivis ludere deliciis.  
Lusibus et lætis procul hinc abſistite, SÆVI  
GRAMMATICI, injustas et cohibite manus.  
Ne puer, ab malleis cæsus lacrymansque leporis;  
DURAM FORTE MEIS OSSIBUS OPTET HUMUM.

*SECURIDACA*, a plant belonging to the class of *diadelphia*, and to the order of *octandria*. The calyx has three leaves, which are small, deciduous, and coloured. The corolla is papilionaceous. The vexillum, consisting of two petals, is oblong, straight, and conjoined to the carina at the base. The carina is of the same length with the alæ. The legumen is ovated, unilocular, monospermous, and ending in a ligulated ala. There are two species, the *erebia* and *volubilis*. The erecta has an upright stem: the *volubilis* or *scandens* is a climbing plant, and is a native of the West Indies.

*SECUTORES*, a species of gladiators among the

Romans, whose arms were a helmet, a shield, and a sword or a leaden bullet. They were armed in this manner, because they had to contend with the *retiaris*, who were dressed in a short tunic, bore a three-pointed lance in their left hand, and a net in their right. The *retiaris* attempted to cast his net over the head of the *secutor*; and if he succeeded, he drew it together and slew him with his trident: but if he missed his aim, he immediately betook himself to flight till he could find a second opportunity of intangling his adversary with his net. He was pursued by the *secutor*, who endeavoured to dispatch him in his flight.

*Secutores* was also a name given to such gladiators who took the place of those killed in the combat, or who engaged the conqueror. This post was usually taken by lot.

*SEDAN* is a town of Champagne in France, in E. Long. 4. 45. N. Lat. 49. 46. This is the capital of a principality of the same name, situated on the *Maese*, six miles from *Bouillon*, and fifteen from *Charleville*. Its situation on the frontiers of the territory of *Liege*, *Namur*, and *Limburg*, formerly rendered it one of the keys of the kingdom. It is extremely well fortified, and defended by a strong citadel. The castle is situated on a rock, surrounded with large towers and strong walls; here you see a most beautiful magazine of ancient arms. The governor's palace is opposite the castle. From the ramparts you have a most agreeable prospect of the *Maese* and the neighbouring country. Though the town is but small, yet it is full of tradesmen, as tanners, weavers, dyers, &c. the manufacture of fine cloth in this city employing a great number of hands. The principality of *Sedan* formerly belonged to the duke of *Bouillon*, who was obliged in the beginning of the last century to resign it to the crown.

*SEDAN-CHAIR* is a covered vehicle for carrying a single person, suspended by two poles, and borne by two men, hence denominated *chairmen*. They were first introduced in *London* in 1634, when *Sir Sanders Duncomb* obtained the sole privilege to use, let, and hire a number of the said covered chairs for fourteen years.

*SEDITION*, among civilians, is used for a factious commotion of the people, or an assembly of a number of citizens without lawful authority, tending to disturb the peace and order of the society. This offence is of different kinds: some seditions more immediately threatening the supreme power, and the subversion of the present constitution of the state; others tending only towards the redress of private grievances. Among the Romans, therefore, it was variously punished, according as its end and tendency threatened greater mischief. See *lib. i. Cod. de Seditiosis*, and *Mat. de Crimin. lib. ii. n. 5. de Læsa Majestate*. In the punishment, the authors and ringleaders were justly distinguished from those who, with less wicked intention, joined and made part of the multitude.

The same distinction holds in the law of *England* and in that of *Scotland*. Some kinds of sedition in *England* amount to high treason, and come within the stat. 25 *Edw. III.* as levying war against the king. And several seditions are mentioned in the *Scotch acts* of parliament as treasonable. *Bayne's Crim. Law of Scotland*, p. 33, 34. The law of *Scotland* makes riotous and tumultuous assemblies a species of sedition. But the law there, as well as in *England*, is now chiefly

Sedatives  
||  
Sedley.

regulated by the riot act, made t Geo. I. only it is to be observed, that the proper officers in Scotland, to make the proclamation thereby enacted, are sheriffs, stewards, and bailies of regalities, or their deputies; magistrates of royal boroughs, and all other inferior judges and magistrates: high and petty constables, or other officers of the peace, in any county, stewardry, city, or town. And in that part of the island, the punishment of the offence is any thing short of death which the judges, in their discretion, may appoint.

SEDATIVES, in medicine, a general name for such medicines as weaken the powers of nature, such as blood-letting, cooling salts, purgatives, &c.

SE DEFENDENDO, in law, a plea used for him that is charged with the death of another, by alleging that he was under a necessity of doing what he did in his own defence: as that the other assaulted him in such a manner, that if he had not done what he did, he must have been in hazard of his own life. See HOMICIDE and MURDER.

SEDIMENT, the settlement or dregs of any thing, or that gross heavy part of a fluid body which sinks to the bottom of the vessel when at rest.

SEDLEY (Sir Charles), an English poet and wit, the son of Sir John Sedley of Aylesford in Kent, was born about the year 1639. At the restoration he came to London to join the general jubilee; and commenced wit, courtier, poet, and gallant. He was so much admired, that he became a kind of oracle among the poets; which made king Charles tell him, that Nature had given him a patent to be Apollo's viceroy. The productions of his pen were some plays, and several delicately tender amorous poems, in which the softness of the verses was so exquisite, as to be called by the duke of Buckingham *Sedley's witchcraft*. "There were no marks of genius or true poetry to be descried, (say the authors of the *Biographia Britannica*); the art wholly consisted in raising loose thoughts and lewd desires, without giving any alarm; and so the poison worked gently and irresistibly. Our author, we may be sure, did not escape the infection of his own art, or rather was first tainted himself before he spread the infection to others."—A very ingenious writer of the present day, however, speaks much more favourably of Sir Charles Sedley's writings. "He studied human nature; and was distinguished for the art of making himself agreeable, particularly to the ladies; for the verses of Lord Rochester, beginning with, *Sedley has that pre-wailing gentle art*, &c. so often quoted, allude not to his writings, but to his *personal address*." [*Langborn's Effusions*, &c.]—But while he thus grew in reputation for wit and in favour with the king, he grew poor and debauched: his estate was impaired, and his morals were corrupted. One of his frolics, however, being followed by an indictment and a heavy fine, Sir Charles took a more serious turn, applied himself to business, and became a member of parliament, in which he was a frequent speaker. We find him in the House of Commons in the reign of James II. whose attempts upon the constitution he vigorously withstood; and he was very active in bringing on the revolution. This was thought more extraordinary, as he had received favours from James. But that prince had taken a fancy to Sir Charles's daughter (though it seems she was not very handsome), and, in consequence of his intrigues with

her, he created Miss Sedley countess of Dorchester. This honour, so far from pleasing, greatly shocked Sir Charles. However libertine he himself had been, yet he could not bear the thoughts of his daughter's dishonour; and with regard to her exaltation, he only considered it as rendering her more conspicuously infamous. He therefore conceived a hatred for the king; and from this, as well as other motives, readily joined to dispossess him of the throne. A witty saying of Sedley's, on this occasion, is recorded. "I hate ingratitude, (said Sir Charles); and therefore, as the king has made my daughter a countess, I will endeavour to make his daughter a queen;" meaning the princess Mary, married to the prince of Orange, who dispossessed James of the throne at the revolution. He lived to the beginning of queen Anne's reign; and his works were printed in 2 vols 8vo, 1719.

SEDR, or SEDRE, the high-priest of the sect of Ali among the Persians. The sedre is appointed by the emperor of Persia, who usually confers the dignity on his nearest relation. The jurisdiction of the sedre extends over all effects destined for pious purposes, over all mosques, hospitals, colleges, sepulchres, and monasteries. He disposes of all ecclesiastical employments, and nominates all the superiors of religious houses. His decisions in matters of religion are received as so many infallible oracles; he judges of all criminal matters in his own house without appeal. His authority is balanced by that of the muditehid, or first theologue of the empire.

SEDUCTION, is the act of tempting and drawing aside from the right path, and comprehends every endeavour to corrupt any individual of the human race. This is the import of the word in its largest and most general sense; but it is commonly employed to express the act of tempting a virtuous woman to part with her chastity.

The seducer of female innocence practises the same stratagems of fraud to get possession of a woman's person, that the swindler employs to get possession of his neighbour's goods or money; yet the law of honour, which pretends to abhor *deceit*, and which impels its votaries to *murder* every man who presumes, however justly, to suspect them of fraud, or to question their veracity, applauds the address of a successful intriguer, tho' it be well known that the seducer could not have obtained his end without swearing to the truth of a thousand falsehoods, and calling upon God to witness promises which he never meant to fulfil.

The law of honour is indeed a very capricious rule, which accommodates itself to the pleasures and conveniences of higher life; but the law of the land, which is enacted for the equal protection of high and low, may be supposed to view the guilt of seduction with a more impartial eye. Yet for this offence, even the laws of this kingdom have provided no other punishment than a pecuniary satisfaction to the injured family; which, in England, can be obtained only by one of the quaintest fictions in the world, by the father's bringing his action against the seducer for the loss of his daughter's service during her pregnancy and nurturing. See *Palay's Moral Philosophy*, Book III. Part iii. Chap. 3.

The moralist, however, who estimates the merit or demerit of actions, not by laws of human appointment, but by their general consequences as established by the laws of nature, must consider the seducer as a criminal

Sede  
||  
Seduction

of the deepest guilt. In every civilized country, and in many countries where civilization has made but small progress, the virtue of women is collected as it were into a single point, which they are to guard above all things, as that on which their happiness and reputation wholly depend. At first sight this may appear a capricious regulation; but a moment's reflection will convince us of the contrary. In the married state so much confidence is necessarily reposed in the fidelity of women to the beds of their husbands, and evils so great result from the violation of that fidelity, that whatever contributes in any degree to its preservation, must be agreeable to him who, in establishing the laws of nature, intended them to be subservient to the real happiness of all his creatures. But nothing contributes so much to preserve the fidelity of wives to their husbands, as the impressing upon the minds of women the highest veneration for the virtue of chastity. She who, when unmarried, has been accustomed to grant favours to different men, will not find it easy, if indeed possible, to resist afterwards the allurements of variety. It is therefore a wise institution, and agreeable to the will of Him who made us, to train up women so as that they may look upon the loss of their chastity as the most disgraceful of all crimes; as that which sinks them in the order of society, and robs them of all their value. In this light virtuous women actually look upon the loss of chastity. The importance of that virtue has been so deeply impressed upon their minds, and is so closely associated with the principle of honour, that they cannot think but with abhorrence upon the very deed by which it is lost. He therefore who by fraud and falsehood persuades the unsuspecting girl to deviate in one instance from the honour of the sex, weakens in a great degree her moral principle; and if he reconcile her to a repetition of her crime, he destroys that principle entirely, as she has been taught to consider all other virtues as inferior to that of chastity. Hence it is that the hearts of prostitutes are generally steeled against the miseries of their fellow-creatures; that they lend their aid to the seducer in his practices upon other girls; that they lie and swear and steal without compunction; and that too many of them hesitate not to commit murder if it can serve any selfish purpose of their own.

The loss of virtue, though the greatest that man or woman can sustain, is not the only injury which the seducer brings upon the girl whom he deceives. She cannot at once reconcile herself to prostitution, or even to the loss of character; and while a sense of shame remains in her mind, the misery which she suffers must be exquisite. She knows that she has forfeited what in the female character is most valued by both sexes; and she must be under the perpetual dread of a discovery. She cannot even confide in the honour of her seducer, who may reveal her secret in a fit of drunkenness, and thus rob her of her fame as well as of her virtue; and while she is in this state of anxious uncertainty, the agony of her mind must be insupportable. That it is so in fact, the many instances of child murder by unmarried women of every rank leave us no room to doubt. The affection of a mother to her new-born child is one of the most unequivocal and strongest instincts in human nature (see *INSTINCT*); and nothing short of the extremity of distress could prompt any one so far to op-

pose her nature as to embroc her hands in the blood of her imploring infant.

Even this deed of horror seldom prevents a detection of the mother's frailty, which is indeed commonly discovered, though no child has been the consequence of her intrigue. He who can seduce is base enough to betray; and no woman can part with her honour, and retain any well-grounded hope that her amour shall be kept secret. The villain to whom she surrendered will glory in his victory, if it was with difficulty obtained, and if she surrendered at discretion, her own behaviour will reveal her secret. Her reputation is then irretrievably lost, and no future circumstance will be of the smallest avail to recover it. She will be stunned by the virtuous part of her own sex, and treated as a mere instrument of pleasure by the other. In such circumstances she cannot expect to be married with advantage. She may perhaps be able to captivate the heart of a heedless youth, and prevail upon him to unite his fate to her's before the delirium of his passion shall give him time for reflection; she may be addressed by a man who is a stranger to her story, and married while he has no suspicion of her secret; or she may be solicited by one of a station inferior to her own, who, though acquainted with every thing that has befallen her, can barter the delicacy of wedded love for some pecuniary advantage; but from none of these marriages can she look for happiness. The delirium which prompted the first will soon vanish, and leave the husband to the bitterness of his own reflections, which can hardly fail to produce cruelty to the wife. Of the secret, to which, in the second case, the lover was a stranger, the husband will soon make a discovery, or at least find room for harbouring strong suspicions; and suspicions of having been deceived in a point so delicate have hitherto been uniformly the parents of misery. In the third case, the man married her merely for money, of which having got the possession, he has no farther inducement to treat her with respect. Such are some of the consequences of seduction, even when the person seduced has the good fortune to get afterwards a husband; but this is a fortune which few in her circumstances can reasonably expect. By far the greater part of those who have been defrauded of their virtue by the arts of the seducer sink deeper and deeper into guilt, till they become at last common prostitutes. The public is then deprived of their service as wives and parents; and instead of contributing to the population of the state, and to the sum of domestic felicity, these outcasts of society become seducers in their turn, corrupting the morals of every young man whose appetites they can inflame, and of every young woman whom they can entice to their own practices.

All this complication of evil is produced at first by arts, which, if employed to deprive a man of his property, would subject the offender to the execration of his fellow-subjects, and to an ignominious death: but while the forger of a bill is pursued with relentless rigour by the ministers of justice, and the swindler loaded with universal reproach, the man who by fraud and forgery has enticed an innocent girl to gratify his desires at the expence of her virtue, and thus introduced her into a path which must infallibly lead to her own ruin, as well as to repeated injuries to the public at

Seduction.  
Sedum

large, is not despoiled by his own sex, and is too often carested even by the virtuous part of the other. Yet the loss of property may be easily repaired; the loss of honour is irreparable! It is vain to plead in alleviation of this guilt, that women should be on their guard against the arts of the seducer. Most unquestionably they should; but arts have been used which hardly any degree of caution would have been sufficient to counteract. It may as well be said that the trader should be on his guard against the arts of the forger, and accept of no bill without previously consulting him in whose name it is written. Cases, indeed, occur in trade, in which this caution would be impossible; but he must be little acquainted with the workings of the human heart, who does not know that situations likewise occur in life, in which it is equally impossible for a girl of virtue and tenderness to resist the arts of the man who has completely gained her affections.

The mentioning of this circumstance leads us to consider another species of seduction, which, though not so highly criminal as the former, is yet far removed from innocence; we mean the practice which is too prevalent among young men of fortune of employing every art in their power to gain the hearts of heedless girls whom they resolve neither to marry nor to rob of their honour. Should a man adhere to the latter part of this resolution, which is more than common fortitude can always promise for itself, the injury which he does to the object of his amusement is yet very great, as he raises hopes of the most sanguine kind merely to disappoint them, and diverts her affections perhaps for ever from such men as, had they been fixed on one of them, might have rendered her completely happy. Disappointments of this kind have sometimes been fatal to the unhappy girl; and even when they have neither deprived her of life, nor disordered her reason, they have often kept her wholly from marriage, which, whatever it be to a man, is that from which every woman expects her chief happiness. We cannot therefore conclude this article more properly than with warning our female readers not to give up their hearts hastily to men whose station in life is much higher than their own; and we beg leave to assure every one of them, that the man who solicits the last favour under the most solemn promise of a subsequent marriage, is a base seducer, who prefers a momentary gratification of his own to her honour and happiness through life, and has no intention to fulfil his promise. Or, if he should by any means be compelled to fulfil it, she may depend upon much ill treatment in return for her premature compliance with his base desires.

SEDUM, ORPINE, in botany: A genus of the pentagynia order, belonging to the decandria class of plants; and in the natural method ranking under the 13th order, *Succulentæ*. The calyx is quinquesid; the corolla is pentapetalous, pointed, and spreading; there are five nectariferous squamæ or scales at the base of the germens. The capsules are five.

The species are 20 in number. 1. The Verticillatum; 2. Telephium; 3. Anacamperos; 4. Aizoon; 5. Hybridum; 6. Populifolium; 7. Stellatum; 8. Cæpæa; 9. Libanoticum; 10. Dafyphyllum; 11. Reflexum; 12. Rupestre; 13. Lineare; 14. Hispanicum; 15. Album; 16. Acre; 17. Sexangulare; 18. Annum;

19. Villosum; 20. Atratum. The following species are the most remarkable.

1. The telephium, common orpine, or live-long, hath a perennial root, composed of many knobbed tubercles, sending up erect, round, succulent stalks, branching half a yard or two feet high, garnished with oblong, plane, serrated, succulent leaves, and the stalks terminated by a leafy corymbus of flowers, of different colours in the varieties. This species is an inhabitant of woods and dry places in England, &c. but has been long a resident of gardens for variety and medical use. 2. The anacamperos, or decumbent evergreen Italian orpine, hath a fibrous perennial root, decumbent or trailing stalks, wedge-shaped entire leaves, and the stalks terminated by a corymbus of purple flowers. 3. The rupestre, rock sedum, or stone-crop of St Vincent's rock, hath slender, trailing, purple stalks; short, thick, awl-shaped, succulent, glaucous leaves in clusters, quinquelobedly imbricated round the stalks, and the stalks terminated by roundish cymose bunches of bright yellow flowers. It grows naturally on St Vincent's rock near Bristol, and other rocky places in Europe. 4. The aizoon, or Siberian yellow orpine, hath a tuberculate, fibrous, perennial root; many upright, round, succulent, stalks, a foot high; lanceolated, plane, serrated, thickish leaves; and the stalks terminated by a close-fitting cymose cluster of bright yellow flowers. 5. The reflexum, reflexed small yellow sedum, or prick-madam, hath a slender fibrous perennial root; small trailing succulent stalks, garnished with thick, awl-shaped, succulent leaves sparsely, the lower ones recurved, and the stalks terminated by reflexed spikes of bright yellow flowers. It grows naturally on old walls and buildings in England, &c. 6. The acre, acrid sedum, common stone-crop of the wall, or wall-pepper, hath small fibrous roots, very slender succulent stalks four or five inches high, very small, suboval, gibbous, erect, alternate leaves, close together, and the stalks terminated by trifid cymose bunches of small yellow flowers. This sort grows abundantly on rocks, old walls, and tops of buildings, almost everywhere, which often appear covered with the flowers in summer. 7. The sexangulare, or sexangular stone-crop, hath a fibrous perennial root; thick, short, succulent stalks; small, suboval, gibbous, erect leaves close together, arranged six ways imbricated, and the stalks terminated by bunches of yellow flowers. It grows on rocky and other dry places in England, &c. 8. The album, or white stone-crop, hath fibrous perennial roots; trailing slender stalks, six or eight inches long; oblong, obtuse, sessile, spreading leaves; and the stalks terminated by branchy cymose bunches of white flowers. This grows on old walls, rocks, and buildings, in England, &c. 9. The hispanicum, or Spanish sedum, hath fibrous perennial roots, crowned with clusters of taper, acute, succulent leaves; slender succulent stalks, four or five inches high, garnished also with taper leaves, and terminated by downy cymose clusters of white flowers.

All these species of sedum are hardy herbaceous succulent perennials, durable in root, but mostly annual in stalk, &c. which, rising in spring, flower in June, July, and August, in different sorts; the flowers consisting universally of five spreading petals, generally crowning the stalks numerously in corymbose and cymose bunches, and spikes, appearing tolerably conspicuous, and are

Sedum

suc-



Seed  
||  
Seeks.

succeeded by plenty of seeds in autumn, by which they may be propagated, also abundantly by parting the roots, and by slips or cuttings of the stalks in summer; in all of which methods they readily grow and spread very fast into tufted bunches: being all of succulent growth, they consequently delight molt in dry soils, or in any dry rubbishy earth.

*Uses.* As flowering plants, they are mostly employed to embellish rock-work, ruins, and the like places, planting either the roots or cuttings of the shoots in a little mud or any moist soil at first, placing it in the crevices, where they will soon root and fix themselves, and spread about very agreeably. For economical purposes, the reflexum and rupestre are cultivated in Holland and Germany, to mix with lettuce in fallads. The wall-pepper is so acrid, that it blisters the skin when applied externally. Taken inwardly, it excites vomiting. In scorbutic cafes and quartan agues, it is said to be an excellent medicine under proper management. Goats eat it; cows, horses, sheep, and swine, refuse it.

SEED, in physiology, a substance prepared by nature for the reproduction and conservation of the species both in animals and plants. See BOTANY, sect. iv. p. 435.; and PHYSIOLOGY, sect. xiii.

SEEDLINGS, among gardeners, denote such roots of gilliflowers, &c. as come from seed sown. Also the young tender shoots of any plants that are newly sown.

SEEDY, in the brandy trade, a term used by the dealers to denote a fault that is found in several parcels of French brandy, which renders them unsaleable. The French suppose that these brandies obtain the flavour which they express by this name, from weeds that grow among the vines from whence the wine of which this brandy is pressed was made.

SEEING, the perceiving of external objects by means of the eye. For an account of the organs of sight, and the nature of vision, see ANATOMY, sect. vi. and OPTICS, page 292, *et seq.*

SEEKS, a religious sect settled at Patna, and so called from a word contained in one of the commandments of their founder, which signifies *learn thou*. In books giving an account of oriental sects and oriental customs, we find mention made both of *Seeks* and *Seiks*; and we are strongly inclined to think that the same tribe is meant to be denominated by both words. If so, different authors write very differently of their principles and manners. We have already related what we then knew of the *Seiks* under the article HINDOOS, p. 530; but in the Asiatic Researches, Mr Wilkins gives a much more amiable account of the *Seeks*, which we lay before our readers with pleasure.

The Seeks are a sect distinguished both from the Mussulmans and the worshippers of Brahma; and, from our author's account of them, must be an amiable people. He asked leave to enter into their chapel: they said it was a place of worship, open to all men, but intimated that he must take off his shoes. On complying with this ceremony, he was politely conducted into the hall, and seated upon a carpet in the midst of the assembly. The whole building forms a square of about 40 feet. The hall is in the centre, divided from four other apartments by wooden arches, upon pillars of the same materials. The walls above the arches were hung with European looking-glasses in gilt frames, and with

pictures. On the left hand, as one enters, is the chancel, which is furnished with an altar covered with cloth of gold, raised a little above the ground in a declining position. About it were several flower-pots and rose-water bottles, and three urns to receive the donations of the charitable. On a low desk, near the altar, stood a great book, of folio size, from which some portions are daily read in the divine service. When notice was given that it was noon, the congregation arranged themselves upon the carpet on each side of the hall. The great book and desk were brought from the altar, and placed at the opposite extremity. An old silver-haired man kneeled down before the desk, with his face towards the altar, and by him sat a man with a drum, and two or three with cymbals. The book was now opened, and the old man began to chant to the time of the instruments, and at the conclusion of every verse most of the congregation joined chorus in a response, with countenances exhibiting great marks of joy. Their tones were not harsh; the time was quick; and Mr Wilkins learned that the subject was a hymn in praise of the unity, omnipresence, and omnipotence of the Deity. The hymn concluded, the whole company got up and presented their faces, with joined hands, towards the altar in the attitude of prayer. The prayer was a sort of litany pronounced by a young man in a loud and distinct voice; the people joining, at certain periods, in a general response. This prayer was followed by a short blessing from the old man, and an invitation to the assembly to partake of a friendly feast. A share was offered to Mr Wilkins, who was too polite to refuse it. It was a kind of sweetmeat composed of sugar and flower mixed up with clarified butter. They were next served with a few sugar plums; and thus ended the feast and ceremony.

In the course of conversation Mr Wilkins learned that the founder of this sect was *Naneeek Sub*, who lived about 400 years ago; who left behind him a book, composed by himself in verse, containing the doctrines he had established; that this book teaches, that there is but one God, filling all space, and pervading all matter; and that there will be a day of retribution, when virtue will be rewarded, and vice punished. (Our author forgot to ask in what manner.) It forbids murder, theft, and such other deeds as are by the majority of mankind esteemed crimes, and inculcates the practice of all the virtues; but, particularly, a universal philanthropy and hospitality to strangers and travellers. It not only commands universal toleration, but forbids disputes with those of another persuasion. If any one show a sincere inclination to be admitted among them, any five or more Seeks being assembled in any place, even on the highway, they lend to the first shop where sweetmeats are sold, and procure a very small quantity of a particular kind called *batast* (Mr Wilkins does not tell us of what it is composed), which having diluted in pure water, they sprinkle some of it on the body and eyes of the proselyte, whilst one of the best instructed repeats to him the chief canons of their faith, and exacts from him a solemn promise to abide by them the rest of his life. They offered to admit Mr Wilkins into their society; but he declined the honour, contenting himself with their alphabet, which they told him to guard as the apple of his eye, as it was a sacred character. Mr Wilkins finds it but little different from the Dewanagari.

The

Segoberg  
||  
Segovia.

The language itself is a mixture of Persian, Arabic, and Shanherit, grafted upon the provincial dialect of Punjab, which is a kind of Hindowee, or, as we commonly call it, *Moors*.

SEGE<sup>B</sup>ERG, a town of Germany, in the duchy of Holslein, and in Wagria; with a castle standing on a high mountain, consisting of limestone, large quantities of which are carried to Hamburg and Lubeck. It belongs to Denmark, and is seated on the river Treve, in E. Long. 10. 9. N. Lat. 54. 0.

SEGEDIN, a strong town of Lower Hungary, in the county of Czongrad, with a castle. The Imperialists took it from the Turks in 1686. It is seated at the confluence of the rivers Tesse and Masroch, in E. Long. 20. 35. N. Lat. 46. 28.

SEGMENT *of a CIRCLE*, in geometry, is that part of the circle contained between a chord and an arch of the same circle.

SEGNA, a city of Croatia, belonging to the house of Austria, and seated on the coast of the Gulph of Venice. It was formerly a place of strength and great importance; but it has suffered many calamities, and its inhabitants at present do not amount to 7000. In the beginning of this century it sent 50 merchant ships to sea; but the inconveniency of its situation and badness of its harbour, in which the sea is never calm, discouraged navigation, and Segna has now very few ships belonging to it. Among the customs of the Segnans, Mr Fortis mentions one relative to the dead, which for its singularity may be worthy of notice.

Fortis's  
Travels into  
Dalmatia.

"All the relations and friends of the family go to kiss the corpse, by way of taking leave, before burial. Each of them uncovers the face, over which a handkerchief is spread, more or less rich according to the family; having kissed the dead person, every one throws another handkerchief over the face; all which remain to the heirs, and sometimes there are 20, 30, and more at this ceremony. Some throw all these handkerchiefs into the grave with the corpse; and this, in former times, was the general custom; but then they were rich. This seems to have been brought into use as a substitute for the ancient *voss lacrimatorii*." E. Long. 15. 21. N. Lat. 45. 22.

SE<sup>G</sup>NI, an ancient town of Italy, in the Campagna of Rome, with a bishop's see, and the title of duchy. It is said that organs were first invented here. It is seated on a mountain. E. Long. 13. 15. N. Lat. 41. 50.

SE<sup>G</sup>ORBE, a town of Spain, in the kingdom of Valencia, with the title of a duchy, and a bishop's see. It is seated on the side of a hill, between the mountains, in a soil very fertile in corn and wine, and where there are quarries of fine marble. It was taken from the Moors in 1245; and the Romans thought it worth their while to carry some of the marble to Rome. W. Long. 0. 3. N. Lat. 39. 48.

SE<sup>G</sup>O<sup>V</sup>IA, an ancient city of Spain, of great power in the time of the Cæsars, is built upon two hills near the banks of the Arayda in Old Castile. W. Long. 3. 48. N. Lat. 41. 0. It is still a bishop's see, and is distinguished for some venerable remains of antiquity. In the year 1525 the city contained 5000 families, but now they do not surpass 2000, a scanty population for 25 parishes; yet, besides 21 churches and a cathedral, there are 21 convents.

The first object in Segovia that attracts the eye is

the aqueduct, which the singular situation of the city renders necessary. As it is built upon two hills, and the valley by which they are separated, and extends considerably in every direction, it was difficult for a part of the citizens to be supplied with water. The difficulty was removed, according to the opinion of the learned, in the reign of Trajan, by this aqueduct, which is one of the most astonishing and the best preserved of the Roman works. In the opinion of Mr Swinburne, who surveyed it in 1776, and who seems to have given a very accurate account of the curiosities of Segovia, it is superior in elegance of proportion to the Pont du Gard at Nismes. It is so perfectly well preserved, that it does not seem leaky in any part. From the first low arches to the reservoir in the town, its length is 2400 Spanish feet; its greatest height (in the Plaza del Azubejo at the foot of the walls) is 104; it is there composed of a double row of arches, built of large square stones without mortar, and over them a hollow wall of coarser materials for the channel of the water, covered with large oblong flags. Of the lower range of arcades, which are 15 feet wide by 65 high, there are 42. The upper arches are 119 in number, their height 27 Spanish feet, their breadth seventeen, the transversal thickness, or depth of the piers, eight feet.

The cathedral is a mixture of the Gothic and Moorish architecture. The inside is very spacious and of majestic simplicity. The windows are well disposed, and the great altar has been lately decorated with the finest Grenadian marble. But it is to be regretted, that in this cathedral, as well as in most others of Spain, the choir is placed in the middle of the nave. The church is nearly upon the model of the great church of Salamanca, but it is not so highly finished.

The alcazar, or ancient palace of the Moors, stands in one of the finest positions possible, on a rock rising above the open country. A very pretty river washes the foot of the precipice, and the city lies admirably well on each side on the brow of the hill; the declivity is woody, and the banks charmingly rural; the snowy mountains and dark forests of Saint Ildefonso compose an awful back-ground to the picture. Towards the town there is a large court before the great outward tower, which, as the prison of Gil Blas, is so well described by Le Sage, that the subject requires no farther explanation. The rest of the buildings form an antique palace, which has seldom been inhabited by any but prisoners since the reign of Ferdinand and Isabella, who were much attached to this situation. There are some magnificent halls in it, with much gilding in the ceilings, in a semi-barbarous taste. All the kings of Spain are seated in state along the cornice of the great saloon; but it is doubtful whether they are like the princes whose names they bear; if that resemblance, however, be wanting, they have no other merit to claim. The royal apartments are now occupied by a college of young gentlemen cadets, educated at the king's expense in all the sciences requisite for forming an engineer. The grand-master of the ordnance resides at Segovia, which is the head establishment of the Spanish artillery.

The mint is below the alcazar, a large building, the most ancient place of coinage in the kingdom. The machines for melting, stamping, and milling the coin, are worked by water: but there is reason to believe that

Segovia

Swinburne  
Travels  
through  
Spain.Travels in  
Spain by  
Gibson de  
Bourgoane

Segovia that Seville has at present more business, as being nearer the source of riches, the port of Cadiz, where the ingots of America are landed.

The unevenness of the crown of the hill gives a wild look to this city. Most of the streets are crooked and dirty, the houses wooden and very wretched; nor do the inhabitants appear much the richer for their cloth manufactory. Indeed, it is not in a very flourishing condition, but what cloth they make is very fine.

The country about Segovia has the reputation of being the best for rearing the kind of sheep that produces the beautiful Spanish wool; but as those flocks wander over many other parts of the kingdom, Segovia seems to have no exclusive title to this reputation. Segovia (says Mr Townsend, whose valuable travels will be read with much pleasure) was once famous for its cloth made on the king's account; but other nations have since become rivals in this branch, and the manufacture in this city has been gradually declining. When the king gave it up to a private company, he left about 3000 l. in trade; but now he is no longer a partner in the business. In the year 1612 were made here 25,500 pieces of cloth, which consumed 44,625 quintals of wool, employed 34,189 persons; but at present they make only about 4000 pieces. The principal imperfections of this cloth are, that the thread is not even, and that much grease remains in it when it is delivered to the dyer; in consequence of which the colour is apt to fail. Yet, independently of imperfections, so many are the disadvantages under which the manufacture labours, that foreigners can afford to pay 3 l. for the arroba of fine wool, for which the Spaniard gives no more than 20 shillings, and after all his charges can command the market even in the ports of Spain.

SEGOVIA (New), a town of North America, in New Spain, and in the audience of Guatimala; seated on the river Yare, on the confines of the province of Honduras. W. Long. 84. 30. N. Lat. 13. 25.

SEGOVIA, a town of America, in Terra Firma, and in the province of Venezuela, seated on a river, near a very high mountain, where there are mines of gold. W. Long. 65. 30. N. Lat. 8. 20.

SEGOVIA, a town of Asia, in the island of Manila, and one of the largest of the Philippines, seated at the north end of the island, 240 miles north of Manila, and subject to Spain. E. Long. 120. 59. N. Lat. 18. 36.

SEGREANT, is the herald's word for a griffin when drawn in a leaping posture and displaying his wings as if ready to fly.

SEGUE, in the Italian music, is often found before *aria, alleluja, amen*, &c. to show that those portions or parts are to be sung immediately after the last note of that part over which it is writ; but if these words *fi plaet*, or *ad libitum*, are joined therewith, it signifies, that these portions may be sung or not at pleasure.

SEQUIERIA, in botany; a plant belonging to the class of polyandria, and the order of monogynia. The calyx is pentaphyllous; the phylla are oblong, concave, coloured, and permanent; there is no corolla. The capsule is oblong and monospermous, the large ala terminating in small lateral alæ. There is only one species, the *americana*.

SEJANT, a term used in heraldry, when a lion, or

other beast, is drawn in an escutcheon sitting like a cat with his fore-feet straight.

SEJANUS (*Alius*), a native of Vulturnum in Tuscany, who distinguished himself in the court of Tiberius. His father's name was Seius Strabo; a Roman knight, commander of the pretorian guards. His mother was descended from the Junian family. Sejanus first gained the favours of Caius Cæsar, the grandson of Augustus, but afterwards he attached himself to the interest and the views of Tiberius, who then sat on the imperial throne. The emperor, who was naturally of a suspicious temper, was free and open with Sejanus, and while he distrusted others, he communicated his greatest secrets to this fawning favourite. Sejanus improved this confidence; and when he had found that he possessed the esteem of Tiberius, he next endeavoured to become the favourite of the soldiers, and the darling of the senate. As commander of the pretorian guards he was the second man in Rome, and in that important office he made use of insinuations and every mean artifice to make himself beloved and revered. His affability and condescension gained him the hearts of the common soldiers, and, by appointing his own favourites and adherents to places of trust and honour, all the officers and centurions of the army became devoted to his interest. The views of Sejanus in this were well known; yet, to advance with more success, he attempted to gain the affection of the senators. In this he met with no opposition. A man who has the disposal of places of honour and dignity, and who has the command of the public money, cannot but be the favourite of those who are in need of his assistance. It is even said, that Sejanus gained to his views all the wives of the senators, by a private and most secret promise of marriage to each of them, whenever he had made himself independent and sovereign of Rome. Yet, however successful with the best and noblest families in the empire, Sejanus had to combat numbers in the house of the emperor; but these seeming obstacles were soon removed. All the children and grandchildren of Tiberius were sacrificed to the ambition of the favourite under various pretences; and Drusus the son of the emperor, by striking Sejanus, made his destruction sure and inevitable. Livia, the wife of Drusus, was gained by Sejanus; and, though the mother of many children, she was prevailed upon to assist her adulterer in the murder of her husband, and she consented to marry him when Drusus was dead. No sooner was Drusus poisoned, than Sejanus openly declared his wish to marry Livia. This was strongly opposed by Tiberius; and the emperor, by recommending Germanicus to the senators for his successor, rendered Sejanus bold and determined. He was more urgent in his demands; and when he could not gain the consent of the emperor, he persuaded him to retire to solitude from the noise of Rome and the troubles of the government. Tiberius, naturally fond of ease and luxury, yielded to his representations and retired to Campania, leaving Sejanus at the head of the empire. This was highly gratifying to the favourite, but he was not without a matter. Prudence and moderation might have made him what he wished to be; but having offended the emperor beyond forgiveness, he resolved to retrieve his loss, and by one vigorous effort to decide the fate of the empire. He called together his friends and followers; he said

Sejanus.

Lempriere's Dictionary.

sourc

Sejanus

court to such as seemed disaffected; he held forth rewards and promises; and, having increased the number of his partisans, formed a bold conspiracy, resolved by any means to seize the sovereign power.

Murphy's  
Tacitus,  
Book v.

A powerful league was formed with astonishing rapidity, and great numbers of all descriptions, senators as well as military men, entered into the plot. Among these, Satrius Secundus was the confidential friend and prime agent of the minister. Whatever was this man's motive, whether fear, or views of interest, or ingratitude (for no principle of honour can be imputed to him), he resolved to betray the secret to Tiberius. For this purpose he addressed himself to Antonia, the daughter of Anthony the triumvir, the widow of Drusus, and the mother of Germanicus. When this illustrious woman, who was honoured by the court and revered by the people, heard the particulars, she sent dispatches to the emperor by one of her slaves. Tiberius was astonished, but not dismayed. The danger pressed; his habitual slowness was out of season; the time called for vigour and decisive measures. He sent Macro to Rome, with a special commission to take upon him the command of the prætorian guards. He added full instructions for his conduct in all emergencies. Early in the morning on the 15th, before the kalends of November, a report was spread, that letters had arrived at Rome, in which the emperor signified his intention to associate Sejanus with himself in the tribunitian power. The senate was summoned to meet in the temple of Apollo, near the imperial palace. Sejanus attended without delay. A party of the prætorians followed him. Macro met him in the vestibule of the temple. He approached the minister with all demonstrations of profound respect, and taking him aside, "Be not surprised (he said) that you have no letter from the prince: it is his pleasure to declare you his colleague in the tribunitian power; but he thinks that a matter of so much importance should be communicated to the fathers by the voice of the consuls. I am going to deliver the emperor's orders." Sejanus, elated with joy, and flushed with his new dignity, entered the senate-house; Macro followed him. As soon as the consuls arrived, he delivered the letter from Tiberius, and immediately went forth to the prætorian guards. He informed them, that by order of the prince, a large donative was to be distributed among the soldiers. He added, that, by a new commission, he himself was appointed their commanding officer; and, if they followed him to the camp, they would there receive the promised bounty. The lure was not thrown out in vain: the prætorian guards quitted their station. Laco, who stood near at hand, immediately surrounded the senate-house with a body of the city-cohorts.

The letter to the consuls was confused, obscure, and tedious, only glancing at Sejanus, till at last the language of invective left no room for doubt. Sejanus kept his seat like a man benumbed, senseless and stupid with astonishment. His friends, who a little before congratulated him on his new dignity, deserted him on every side. He was commanded by the consul to rise and follow him, and being loaded with irons, was conducted to prison. His downfall filled the city with exultation. The populace, who worshipped him in the hour of prosperity, rejoiced to see the sad catastrophe to which he was now reduced. They followed in crowds,

rending the air with shouts, and pouring forth a torrent of abuse and scurrilous language. The prisoner endeavoured to hide his face; but the mob delighted to see remorse and shame and guilt and horror in every feature of his distracted countenance. They reviled him for his acts of cruelty; they laughed at his wild ambition; they tore down his images, and dashed his statues to pieces. He was doomed by Tiberius to suffer death on that very day; but, as he had a powerful faction in the senate, it was not thought advisable, for the mere formality of a regular condemnation, to hazard a debate. Private orders were given to Macro to dispatch him without delay; but the consul, seeing the dispositions of the people, and the calm neutrality of the prætorian guards, judged it best to re-assemble the fathers. They met in the temple of Concord. With one voice Sejanus was condemned to die, and the sentence was executed without delay. He was strangled in the prison. His body was dragged to the Gemoniæ, and, after every species of insult from the populace, at the end of three days was thrown into the Tiber. Such was the tragic end of that ambitious favourite. He fell a terrible example to all, who, in any age or country, may hereafter endeavour by their vices to rise above their fellow-citizens.

SEIGNIOR, is, in its general signification, the same with *lord*; but is particularly used for the lord of the fee as of a manor, as *seigneur* among the feudists is he who grants a fee or benefit out of the land to another; and the reason is, because having granted away the use and profit of the land, the property or dominion he still retains in himself:

SEIGNIORAGE, is a royalty or prerogative of the king, whereby he claims an allowance of gold and silver bought in the mass to be exchanged for coin. As *seigniorage*, out of every pound weight of gold, the king had for his coin 5 s. of which he paid to the master of the mint sometimes 1 s. and sometimes 1 s. 6 d. Upon every pound weight of silver, the *seigniorage* answered to the king in the time of Edward III. was 18 penny-weights, which then amounted to about 1 s. out of which he sometimes paid 8 d. at others 9 d. to the master. In the reign of king Henry V. the king's *seigniorage* of every pound of silver was 15 d. &c.

SEIGNIORY, is borrowed from the French *seigneurie*, i. e. *dominatus*, *imperium*, *principatus*; and signifies with us a manor or lordship, *seigniorie de sokemans*. *Seigniorie in gross*, seems to be the title of him who is not lord by means of any manor, but immediately in his own person; as *tenure in capite*, whereby one holds of the king as of his crown, is *seigniorie in gross*.

SEIKS. See HINDOSTAN, p. 530.

SEISIN, in law, signifies possession. In this sense we say, *premier seisin*, for the first possession, &c.

Seisin is divided into that *in deed* or *in fact*, and that *in law*. A seisin *in deed* is where a possession is actually taken: but a seisin *in law* is, where lands descend, and the party has not entered thereon; or in other words, it is where a person has a right to lands, &c. and is by wrong disseised of them. A seisin *in law* is held to be sufficient to avow on; though to the bringing of an assize, actual seisin is required; and where seisin is alleged, the person pleading it must show of what estate he is seised, &c.

Seisin of a superior service is deemed to be a seisin

of all superior and casual services that are incident thereto; and seisin of a lessee for years, is sufficient for him in reversion.

*Livery of Seisin*, in law, an essential ceremony in the conveyance of landed property; being no other than the pure feudal investiture, or delivery of corporal possession of the land or tenement. This was held absolutely necessary to complete the donation; *Nam feudum sine investitura nullo modo constitui potuit*: and an estate was then only perfect when, as Fleta expresses it in our law, *sit juris et seisinæ conjunctio*. See FEODMENT.

Investitures, in their original rise, were probably intended to demonstrate in conquered countries the actual possession of the lord; and that he did not grant a bare litigious right, which the soldier was ill qualified to prosecute, but a peaceable and firm possession. And, at a time when writing was seldom practised, a mere oral gift, at a distance from the spot that was given, was not likely to be either long or accurately retained in the memory of bystanders, who were very little interested in the grant. Afterwards they were retained as a public and notorious act, that the country might take notice of and testify the transfer of the estate; and that such as claimed title by other means might know against whom to bring their actions.

In all well-governed nations, some notoriety of this kind has been ever held requisite, in order to acquire and ascertain the property of lands. In the Roman law, *plenum dominium* was not said to subsist unless where a man had both the *rights* and the *corporal possession*; which possession could not be acquired without both an actual intention to possess, and an actual seisin, or entry into the premises, or part of them in the name of the whole. And even in ecclesiastical promotions, where the freehold passes to the person promoted, corporal possession is required at this day to vest the property completely in the new proprietor; who, according to the distinction of the canonists, acquires the *jus ad rem*, or inchoate and imperfect right, by nomination and institution; but not the *jus in re*, or complete and full right, unless by corporal possession. Therefore in dignities possession is given by instalment; in rectories and vicarages by induction; without which no temporal rights accrue to the minister, though every ecclesiastical power is vested in him by institution. So also even in descents of lands, by our law, which are cast on the heir by act of the law itself, the heir has not *plenum dominium*, or full and complete ownership, till he has made an actual corporal entry into the lands: for if he dies before entry made, his heir shall not be entitled to take the possession, but the heir of the person who was last actually seised. It is not therefore only a mere right to enter, but the actual entry, that makes a man complete owner; so as to transmit the inheritance to his own heirs: *non jus, sed seisina, facit stipitem*.

Yet the corporal tradition of lands being sometimes inconvenient, a symbolical delivery of possession was in many cases anciently allowed; by transferring something near at hand, in the presence of credible witnesses, which by agreement should serve to represent the very thing designed to be conveyed; and an occupancy of this sign or symbol was permitted as equivalent to occupancy of the land itself. Among the Jews we find the evidence of a purchase thus defined in the

book of Ruth: "Now this was the manner in former time in Israel, concerning redeeming and concerning changing, for to confirm all things: a man plucked off his shoe, and gave it to his neighbour; and this was a testimony in Israel." Among the ancient Goths and Swedes, contracts for the sale of lands were made in the presence of witnesses, who extended the cloak of the buyer, while the seller cast a clod of the land into it, in order to give possession; and a staff or wand was also delivered from the vender to the vendee, which passed through the hands of the witnesses. With our Saxon ancestors the delivery of a turf was a necessary solemnity to establish the conveyance of lands. And, to this day, the conveyance of our copyhold estates is usually made from the seller to the lord or his steward by delivery of a rod or verge, and then from the lord to the purchaser by re-delivery of the same in the presence of a jury of tenants.

Conveyances in writing were the last and most refined improvement. The mere delivery of possession, either actual or symbolical, depending on the ocular testimony and remembrance of the witnesses, was liable to be forgotten or misrepresented, and became frequently incapable of proof. Besides, the new occasions and necessities introduced by the advancement of commerce, required means to be devised of charging and incumbering estates, and of making them liable to a multitude of conditions and minute designations, for the purposes of raising money, without an absolute sale of the land; and sometimes the like proceedings were found useful in order to make a decent and competent provision for the numerous branches of a family, and for other domestic views. None of which could be effected by a mere, simple, corporal transfer of the soil from one man to another, which was principally calculated for conveying an absolute unlimited dominion. Written deeds were therefore introduced, in order to specify and perpetuate the peculiar purposes of the party who conveyed: yet still, for a very long series of years, they were never made use of, but in company with the more ancient and notorious method of transfer by delivery of corporal possession.

*Livery of seisin*, by the common law, is necessary to be made upon every grant of an estate of freehold in hereditaments corporeal, whether of inheritance or for life only. In hereditaments incorporeal it is impossible to be made; for they are not the object of the senses: and in leases for years, or other chattel interests, it is not necessary. In leases for years indeed an actual entry is necessary, to vest the estate in the lessee: for a bare lease gives him only a right to enter, which is called his interest in the term, or *interesse termini*: and when he enters in pursuance of that right, he is then, and not before, in possession of his term, and complete tenant for years. This entry by the tenant himself serves the purpose of notoriety, as well as livery of seisin from the grantor could have done; which it would have been improper to have given in this case, because that solemnity is appropriated to the conveyance of a freehold. And this is one reason why freeholds cannot be made to commence *in futuro*, because they cannot (at the common law) be made but by livery of seisin; which livery, being an actual manual tradition of the land, must take effect *in presenti*, or not at all.

*Livery of seisin* is either in deed or in law.

Seisin,  
Seize.

Livery in *deed* is thus performed. The feoffor, lessor, or his attorney, together with the feoffee, lessee, or his attorney, (for this may as effectually be done by deputy or attorney as by the principals themselves in person), come to the land or to the house; and there, in the presence of witnesses, declare the contents of the feoffment or lease on which livery is to be made. And then the feoffor, if it be of land, doth deliver to the feoffee, all other persons being out of the ground, a clod or turf, or a twig or bough there growing, with words to this effect: "I deliver these to you in the name of seisin of all the lands and tenements contained in this deed." But, if it be of a house, the feoffor must take the ring or latch of the door, the house being quite empty, and deliver it to the feoffee in the same form; and then the feoffee must enter alone, and shut the door, and then open it, and let in the others. If the conveyance or feoffment be of divers lands, lying scattered in one and the same county, then in the feoffor's possession, livery of seisin of any parcel, in the name of the rest, sufficeth for all; but if they be in several counties, there must be as many liveries as there are counties. For, if the title to these lands comes to be disputed, there must be as many trials as there are counties, and the jury of one county are no judges of the notoriety of a fact in another. Besides, anciently, this seisin was obliged to be delivered *coram paribus de vicinato*, before the peers or freeholders of the neighbourhood, who attested such delivery in the body or on the back of the deed; according to the rule of the feudal law, *Pares debent interesse investituræ feudi, et non alii*: for which this reason is expressly given; because the peers or vassals of the lord, being bound by their oath of fealty, will take care that no fraud be committed to his prejudice, which strangers might be apt to connive at. And though afterwards the ocular attestation of the *pares* was held unnecessary, and livery might be made before any credible witnesses, yet the trial, in case it was disputed, (like that of all other attestations), was still reserved to the *pares* or jury of the county. Also, if the lands be out on lease, though all lie in the same county, there must be as many liveries as there are tenants: because no livery can be made in this case, but by the consent of the particular tenant; and the consent of one will not bind the rest. And in all these cases it is prudent, and usual, to endorse the livery of seisin on the back of the deed, specifying the manner, place, and time of making it; together with the names of the witnesses. And thus much for livery in deed.

Livery in *law* is where the same is not made on the land, but in *sight* of it only; the feoffor saying to the feoffee, "I give you yonder land, enter and take possession." Here, if the feoffee enters during the life of the feoffor, it is a good livery, but not otherwise; unless he dares not enter through fear of his life or bodily harm; and then his continual claim, made yearly in due form of law, as near as possible to the lands, will suffice without an entry. This livery in law cannot, however, be given or received by attorney, but only by the parties themselves.

SEIZE, in the sea-language, is to make fast or bind, particularly to fasten two ropes together with rope-yarr. The seizing of a boat is a rope tied to a ring or little chain in the fore-ship of the boat, by which means it is fastened to the side of the ship.

SEIZURE, in commerce, an arrest of some merchandise, moveable, or other matter, either in consequence of some law or of some express order of the sovereign. Contraband goods, those fraudulently entered, or landed without entering at all, or at wrong places, are subject to seizure. In seizures among us, one half goes to the informer, and the other half to the king.

SELAGO, in botany: A genus of the angiospermia order, belonging to the didynamia class of plants; and in the natural method ranking under the 48th order, *Aggregateæ*. The calyx is quinquefid: the tube of the corolla capillary, with the limb nearly equal, and a single seed. There are 27 species.

SELDEN (John), called by Grotius *the glory of England*, was born at Salvington in Sussex in 1584. He was educated at the free-school at Chichester; whence he was sent to Hart-Hall in the university of Oxford, where he staid four years. In 1617, he entered himself in Clifford's Inn, in order to study the law; and about two years after removed to the Inner Temple, where he soon acquired great reputation by his learning. He had already published several of his works; and this year wrote verses in Latin, Greek, and English, upon Mr William Browne's *Britannia's Pastorals*. In 1614, he published his *Titles of Honour*; and in 1616, his *Notes on Sir John Fortescue's book De Laudibus Legum Angliæ*. In 1618, he published his *History of Tythes*; which gave great offence to the clergy, and was animadverted upon by several writers; and for that book he was called before the high commission court, and obliged to make a public acknowledgment of his sorrow for having published it. In 1621, being sent for by the parliament, though he was not then a member of that house, and giving his opinion very strongly in favour of their privileges in opposition to the court, he was committed to the custody of the sheriff of London, but was set at liberty after five weeks confinement. In 1623, he was chosen burges for Lancaster; but, amidst all the divisions of the nation, kept himself neuter, prosecuting his studies with such application, that though he was the next year chosen reader of Lyon's Inn, he refused to perform that office. In 1625, he was chosen burges for Great Bedwin in Wiltshire, to serve in the first parliament of king Charles I. in which he declared himself warmly against the duke of Buckingham; and on his Grace's being impeached by the House of Commons, was appointed one of the managers of the articles against him. In 1627 and 1628, he opposed the court party with great vigour. The parliament being prorogued to January 20. 1629, Mr Selden retired to the earl of Kent's house at Wrest, in Bedfordshire, where he finished his *Marmora Arundeliana*. The parliament being met, he, among others, again distinguished himself by his zeal against the court; when the king dissolving the parliament, ordered several of the members to be brought before the King's Bench bar, and committed to the Tower. Among these was Mr Selden, who insisting on the benefit of the laws, and refusing to make his submission, was removed to the King's Bench prison. Being here in danger of his life on account of the plague then raging in Southwark, he petitioned the lord high treasurer, at the end of Trinity-term, to intercede with his Majesty that he might be removed to the Gate-House, Westminster, which was granted: but in Michaelmas term following, the judges objecting to the lord treasurer's warrant, by which he had

Seizure  
Selden

Selden, had been removed to the Gate-house, an order was made for conveying him back to the King's Bench, whence he was released in the latter end of the same year; but fifteen years after, the parliament ordered him 5000*l.* for the losses he had sustained on this occasion. He was afterwards committed, with several other gentlemen, for dispersing a libel; but the author, who was abroad, being discovered, they were at length set at liberty. In 1634, a dispute arising between the English and Dutch concerning the herring-fishery on the British coast, he was prevailed upon by archbishop Laud to draw up his *Mare Clausum*, in answer to Grotius's *Mare Liberum*: which greatly recommended him to the favour of the court. In 1640, he was chosen member for the university of Oxford; when he again opposed the court, though he might, by complying, have raised himself to very considerable posts. In 1643, he was appointed one of the lay-members to sit in the assembly of divines at Westminster, and was the same year appointed keeper of the records in the Tower. Whilst he attended his duty in the assembly, a warm debate arose respecting the distance of Jericho from Jerusalem. The party which contended for the shortest distance, urged, as a proof of their opinion being well founded, that fishes were carried from the one city to the other, and sold in the market. Their adversaries were ready to yield to the force of this conclusive argument, when Selden, who despised both parties, as well as the frivolousness of their dispute, exclaimed, "Perhaps the fishes were salted!" This unexpected remark left the victory doubtful, and renewed the debate; and our author, who was sick of such trifling, soon found employment more suited to his genius; for, in 1645, he was made one of the commissioners of the admiralty. The same year he was unanimously elected master of Trinity-college, Cambridge; but declined accepting. He died in 1654; and was interred in the Temple-church, where a monument is erected to his memory. Dr Wilkes observes, that he was a man of uncommon gravity and greatness of soul, averse to flattery, liberal to scholars, charitable to the poor; and though he had great latitude in his principles with regard to ecclesiastical power, yet he had a sincere regard for the church of England. He wrote many learned works besides those already mentioned; the principal of which are, 1. *De Jure Naturali & Gentium juxta Disciplinam Hebraeorum*. 2. *De Nuptiis & Divorciis*. 3. *De Anno Civili veterum Hebraeorum*. 4. *De Nummis*. 5. *De Diis Syris*. 6. *Uxor Hebraica*. 7. *Fani Anglorum Facies altera*, &c. All his works were printed together in 1726, in 3 vols folio.

SELENITES, in natural history, the name of a large class of fossils, the characters of which are these: they are bodies composed of slender and scarce visible filaments, arranged into fine, even, and thin flakes; and those disposed into regular figures, in the several different genera, approaching to a rhomboide, or hexangular column, or a rectangled parallelogram; fissile, like the talcs, but they not only lie in a horizontal, but also in a perpendicular direction: they are flexile in a small degree, but not at all elastic; they do not ferment with acid menstrua, but readily calcine in the fire. Of this class there are seven orders of bodies, and under those ten genera. The selenitæ of the first order are those composed of horizontal plates, and approaching to a rhomboidal form: of the second are those composed of horizontal plates, arranged into a columnar and angular

form: of the third are those whose filaments are scarce visibly arranged into plates, but which, in the whole masses, appear rather of a striated than of a tubulated structure: of the fourth are those which are flat, but of no determinately angular figure: of the fifth are those formed of plates, perpendicularly arranged: of the sixth are those formed of congeries of plates, arranged into the figure of a star; and of the seventh are those of a complex and indeterminate figure.

Of the first of these orders there are three genera. 1. The *leptodecarhombes*. 2. The *pacodecarhombes*. 3. The *tetradeccarhombes*. Of the second order there are also three genera. 1. The *ischnambulces*. 2. The *isambulces*. 3. The *oxucia*. Of the third order there is only one known genus, the *inambulcu*. Of the fourth order there is also only one known genus, the *sanidia*. Of the fifth order there is also only one known genus, the *cathelopes*. Of the sixth order, there are two genera. 1. The *lepaltra*.— 2. The *trichysira*. Of the seventh order there is only one genus, the *symplexia*.

The structure of the selenitæ of all the genera of the first order is exactly alike; they are all composed of a great number of broad flakes or plates, in a great measure externally resembling the flakes of the foliaceous talcs: these are of the length and breadth of the whole mass; the top and bottom being each only one such plate, and those between them, in like manner, each complete and single; and the body may always be easily and evenly split, according to the direction of these flakes. These differ, however, extremely from the talcs, for they are each composed of a number of parallel threads or filaments, which are usually disposed parallelly to the sides of the body, though sometimes parallelly to its ends. In many of the species they are also divided by parallel lines, placed at a considerable distance from each other, and the plates in splitting often break at these lines; add to this, that they are not elastic, and that they readily calcine. The structure of those of the second order is the same with that of the first; but that in many of the specimens of them the filaments of which the plates are composed run in two directions, and meet in an obtuse angle; and in the middle there is generally seen in this case a straight line running the whole length of the column and small parcels of clay insinuating themselves into this crack, represent in it the figure of an ear of grass so naturally, as to have deceived many into a belief that there was really an ear of grass there. The other orders consisting only of single genera, the structure of each is explained under the genetical name.

SELENITES, in chemistry, called also *gypsum spatiosum*, a species of gypsum or plaster of Paris. See GYPSUM.

SELENOGRAPHY, a branch of cosmography, which describes the moon and all the parts and appearances thereof, as geography does those of the earth. See MOON.

SELEUCIA, (anc. geogr.), furnished *Babylonia*, because situated on its confines, at the confluence of the Euphrates and Tigris. Ptolemy places it in Mesopotamia. It is called also *Seleucia ad Tigrim*, (Polybius, Strabo, Isidorus, Characenus); washed on the south by the Euphrates, on the east by the Tigris, (Theophylactus); generally agreed to have been built or enlarged by Seleucus Nicanor, master of the east after Alexander; by means of which Babylon came to be deserted.

Seleucidæ  
||  
Self.

It is said to have been originally called *Cocbe*, (Ammian, Eutropius); though others, as Arrian, distinguish it, as a village, from *Selucia*: and, according to Zofimus, the ancient name of Selucia was *Zochafia*. Now called *Bagdad*. E. Long. 44. 21. N. Lat. 33. 10. There were many other cities of the same name, all built by Seleucus Nicanor.

SELEUCIDÆ, in chronology. Era of the Seleucidæ, or the Syro-Macedonian era, is a computation of time, commencing from the establishment of the Seleucidæ, a race of Greek kings, who reigned as successors of Alexander the Great in Syria, as the Ptolemies did in Egypt. This era we find expressed in the books of the Maccabees, and on a great number of Greek medals struck by the cities of Syria, &c. The Rabbins call it the *era of contracts*, and the Arabs *therik dikarnain*, that is, the "era of the two horns." According to the best accounts, the first year of this era falls in the year 311 B. C. being 12 years after Alexander's death.

SELEUCUS (Nicanor), one of the chief generals under Alexander the Great, and, after his death, founder of the race of princes called *Seleucidæ*. He is equally celebrated as a renowned warrior, and as the father of his people; yet his virtues could not protect him from the fatal ambition of Ceraunus, one of his courtiers, by whom he was assassinated 280 B. C.

SELF-HEAL, the PRUNELLA VULGARIS of Linnaeus. The stem is erect, and about eight or ten inches high. The leaves grow on foot stalks, are ovato-oblong, slightly indented, and somewhat hairy. The bractæ are heart-shaped, opposite, and fringed. The flowers are white or purplish, grow in dense spikes, and are terminal. This plant is perennial, grows wild in meadows and pasture grounds, and flowers in June and July.

This herb is recommended as a mild restraining and vulnerary in spittings of blood, and other hemorrhagies and fluxes; and in gargarisms against aphthæ and inflammations of the fauces. Its virtues do not appear to be very great; to the taste it discovers a very slight austerity or bitterness, which is more sensible in the flowery tops than in the leaves, though the latter are generally directed for medicinal use.

SELF-Command, is that steady equanimity which enables a man in every situation to exert his reasoning faculty with coolness, and to do what the present circumstances require. It depends much upon the natural temperament of the body, and much upon the moral cultivation of the mind. He who enjoys good health, and has braced his frame by exercise, has always a greater command of himself than a man of equal mental powers, who has suffered his constitution to become relaxed by indolence; and he who has from his early youth been accustomed to make his passions submit to his reason, must, in any sudden emergency, be more capable of acting properly than he who has tamely yielded to his passion. Hence it is that reclude and literary men, when forced into the bustle of public life, are incapable of acting where promptness is requisite; and that men who have once or twice yielded to a sense of impending danger seldom acquire afterwards that command of themselves which may be necessary to extricate them from subsequent dangers. In one of the earliest battles fought by the late king of Prussia, the sovereign was among the first men who quitted the field:

had he behaved in the same manner a second and a third time, he would never have become that hero whose actions astonished Europe. A celebrated engineer among ourselves, who was well known to the writer of this short article, had little science, and was a stranger to the principles of his own art; but being possessed of a firm and vigorous frame, and having been accustomed to struggle with dangers and difficulties, he had such a constant command of himself, as enabled him to employ with great coolness every necessary resource in the day of battle.

But it is not only in battle, and in the face of immediate danger, that self-command is necessary to enable a man to act with propriety. There is no situation in life where difficulties, greater or less, are not to be encountered; and he who would pass through life with comfort to himself, and with utility to the public, must endeavour to keep his passions in constant subjection to his reason. No man can enjoy without iniquitude what he cannot lose without pain; and no man who is overwhelmed with despondency under any sudden misfortune can exert the talents necessary to retrieve his circumstances. We ought, therefore, by every means to endeavour to obtain a constant command of ourselves; and nowhere shall we find better lessons for this purpose than in ancient Laedemon. There certain occupations were appointed for each sex, for every hour, and for every season of life. In a life always active, the passions have no opportunity to deceive, seduce, or corrupt; and the nervous system acquires a firmness which makes it a fit instrument to a vigorous mind.

SELF-Defence implies not only the preservation of one's life, but also the protection of his property, because without property life cannot be preserved in a civilized nation. The extent of property essential to life is indeed small, and this consideration may enable us to decide a question which some moralists have made intricate. By what means, it has been asked, may a man protect his property? May he kill the person who attacks it, if he cannot otherwise repel the attack?

That a man, in the state of nature, may kill the person who makes an attack on his life, if he cannot otherwise repel the attack, is a truth which has never been controverted; and he may do the same in civil society, if his danger be so imminent that it cannot be exerted by the interposition of the protection provided for individuals by the state. In all possible situations, except the three following, whatever is absolutely necessary to the preservation of life may be lawfully performed, for the law of self-preservation is the first and most sacred of those laws which are impressed upon every mind by the author of nature.

The three excepted situations are those of a soldier in the day of battle, of a criminal about to suffer by the laws of his country, and of a man called upon to renounce his religion. The soldier hazards his life in the most honourable of all causes, and cannot betray his trust, or play the coward, without incurring a high degree of moral turpitude. He knows that the very profession in which he is engaged necessarily subjects him to danger; and he voluntarily incurred that danger for the good of his country, which, with great propriety, annexes to his profession peculiar privileges and much glory. The criminal under sentence of death cannot, without adding to his guilt, resist the execution of that

sentence;

Herb's  
Materia  
Medica.

Self.



Self. sentence; for the power of inflicting punishment is essential to society, and society is the ordinance of God, (see SOCIETY). The man who is called upon to renounce his religion ought to submit to the cruellest death rather than comply with that request, since religion is his only security for future and permanent happiness. But in every other situation, that which is absolutely necessary to the preservation of life is undoubtedly lawful. Hence it is, that a person sinking in water is never thought to be guilty of any crime, though he drag his neighbour after him by his endeavours to save himself; and hence, too, a man in danger of perishing by shipwreck may drive another from a plank which cannot carry them both, for since one of two lives must be lost, no law, human or divine, calls upon either of them to prefer his neighbour's life to his own.

But though the rights of self-defence authorise us to repel every attack made upon our life, and in cases of extremity to save ourselves at the expence of the life of our innocent neighbour, it is not so evident that, rather than give to an unjust demand a few shillings or pounds, we may lawfully deprive a fellow creature of life, and the public of a citizen. A few pounds lost may be easily regained; but life when lost can never be recovered. If these pounds, indeed, be the whole of a man's property; if they include his clothes, his food, and the house where he shelters his head—there cannot be a doubt but that, rather than part with them, he may lawfully kill the aggressor, for no man can exist without shelter, food, and raiment. But it is seldom that an attempt is made, or is indeed practicable, to rob a man at once of all that he possesses. The question then of any importance is, May a man put a robber to death rather than part with a small part of his property? Mr Paley doubts whether he could innocently do so in a state of nature, "because it cannot be contended to be for the augmentation of human happiness, that one man should lose his life or limb, rather than another a pennyworth of his property." He allows, that in civil society the life of the aggressor may be always taken away by the person aggrieved, or meant to be aggrieved, when the crime attempted is such as would subject its perpetrator to death by the laws of his country.

It is not often that we feel ourselves disposed to differ in opinion from this most valuable and intelligent writer; but on the present occasion we cannot help thinking that he does not reason with his usual precision. To us he even seems to lose sight of his own principles. No legislature can have a right to take away life in civil society, but in such cases as individuals have the same right in a state of nature. If therefore a man, in the state of nature, have not a right to protect his property by killing the aggressor, when it cannot be otherwise protected, it appears to us self-evident that no legislature can have a right to inflict the punishment of death upon such offences; but if the laws inflicting death upon the crime of robbery be morally evil, it is certain that an individual cannot be innocent when he prevents robbery by the death of the robber, merely because he knows that the laws of his country have decreed that punishment against those convicted of that crime. But we think that the protection of property by the death of the aggressor may be completely vindicated upon more general principles. It is necessary, in every state, that property be protected, or mankind

Self. could not subsist; but in a state of nature every man must be the defender of his own property, which in that state must necessarily be small; and if he be not allowed to defend it by every mean in his power, he will not long be able to protect it at all. By giving him such liberty, a few individuals may, indeed, occasionally lose their lives and limbs for the preservation of a very small portion of private property; but we believe that the sum of human happiness will be more augmented by cutting off such worthless wretches than by exposing property to perpetual depredation; and therefore, if general utility be the criterion of moral good, we must be of opinion that a man may in every case lawfully kill a robber rather than comply with his unjust demand.

But if a man may without guilt preserve his property by the death of the aggressor, when it cannot be preserved by any other means, much more may a woman have recourse to the last extremity to protect her chastity from forcible violation. This, indeed, is admitted by Mr Paley himself, and will be controverted by no man who reflects on the importance of the female character, and the probable consequences of the smallest deviation from the established laws of female honour. See SEDUCTION.

*Self-Knowledge*, the knowledge of one's own character, abilities, opinions, virtues, and vices. This has always been considered as a difficult though important acquisition. It is difficult, because it is disagreeable to investigate our errors, our faults, and vices; because we are apt to be partial to ourselves, even when we have done wrong; and because time and habitual attention are requisite to enable us to discover our real character. But these difficulties are more than counterbalanced by the advantages of self-knowledge.

By knowing the extent of our abilities, we shall never rashly engage in enterprises where our ineffectual exertions may be productive of harm: by investigating our opinions, we may discover those which have no foundation, and those also which lead us insensibly into vice. By examining our virtues and vices, we shall learn what principles ought to be strengthened, and what habits ought to be removed.

Man is a rational and intelligent being, capable of great improvement, and liable to great vices. If he acts without examining his principles, he may be hurried by blind passion into crimes. If he aspires at noble and valuable acquisitions, he must act upon a plan, with deliberation and fore-thought; for he is not like a vegetable, which attains perfection by the influence of external causes: he has powers within himself which must be exerted, and exerted with judgment, in order to attain the perfection of his nature. To enable him to employ these powers aright, he must know, first, what is his duty; and, secondly, he must often review his principles and conduct, that he may discover whether he is performing his duty, or in what circumstances he has failed. When he finds that he has fallen into error and vice, he will naturally inquire what causes have produced this effect, that he may avoid the same for the time to come. This is the method by which every reformation in religion and science has been produced, and the method by which the arts have been improved. Before Lord Bacon introduced the new way of philosophizing, he must first have considered wherein true philosophy consisted; secondly, he must have inquired

Self.

in what respects the ancient method of philosophizing was false or useless: and after determining these two points, he was qualified to describe the way by which the study of philosophy could be successfully pursued without deviating into hypothesis and error. Luther found out the errors of the church of Rome by comparing their doctrines with the Scriptures. But had this comparison never been made, the reformation could never have taken place. Without self-knowledge, or without that knowledge of our character which is derived from a comparison of our principles and conduct with a perfect standard of morality, we can never form plans and resolutions, or make any exertion to abandon the vicious habits which we have contracted, and strengthen those virtuous principles in which we are deficient.

As much may be learned from the errors of those who have been in similar situations with ourselves; so many useful cautions may be obtained from our own errors; and he that will remember these, will seldom be twice guilty of the same vice.

It was evidently the intention of Providence that man should be guided chiefly by experience. It is by the observations which we make on what we see passing around us, or from what we suffer in our own person, that we form maxims for the conduct of life. The more minutely therefore we attend to our principles, and the more maxims we form, we shall be the better fitted to attain moral perfection.

With respect to our understanding, to mark the errors which we have fallen into, either by its natural defects or by negligence, is also of great importance; for the greatest genius and most profound scholar are liable to these errors, and often commit them as well as the weak and illiterate. But by observing them, and tracing them to their causes, they at length acquire an habitual accuracy. It is true, that men of feeble minds can never by knowing their own defects exalt themselves to the rank of genius; but such knowledge will enable them to improve their understandings, and so to appreciate their own powers, as seldom to attempt what is beyond their strength. They may thus become useful members of society; and though they will not probably be admired for their abilities, they will yet escape the ridicule which is poured upon vanity.

It is difficult to lay down precise rules for the acquisition of this self-knowledge, because almost every man is blinded by a fallacy peculiar to himself. But when one has got rid of that partiality which arises from self-love, he may easily form a just estimate of his moral improvements, by comparing the general course of his conduct with the standard of his duty; and if he has any doubt of the extent of his intellectual attainments, he will most readily discover the truth by comparing them with the attainments of others who have been most successful in the same pursuits. Should vanity arise in his mind from such a comparison, let him then compare the extent of his knowledge with what is yet to be known, and he will then be in little danger of thinking of himself more highly than he ought to think. See *PREJUDICE* and *SELF-PARTIALITY*.

*SELF-LOVE*, is that instinctive principle which impels every animal, rational and irrational, to preserve its life and promote its own happiness. It is very generally confounded with selfishness; but we think that the one propriety is distinct from the other. Every man loves him-

Self.

self; but every man is not selfish. The selfish man grasps at all *immediate* advantages, regardless of the consequences which his conduct may have upon his neighbour. Self-love only prompts him who is actuated by it to procure to himself the greatest possible sum of happiness during the whole of his existence. In this pursuit the rational self-lover will often forego a present enjoyment to obtain a greater and more permanent one in reversion; and he will as often submit to a present pain to avoid a greater hereafter. Self-love, as distinguished from selfishness, always comprehends the whole of a man's existence, and in that extended sense of the phrase, we hesitate not to say that every man is a self-lover; for, with eternity in his view, it is surely not possible for the most disinterested of the human race not to prefer himself to all other men, if their future and everlasting interests could come into competition. This indeed they never can do; for though the introduction of evil into the world, and the different ranks which it makes necessary in society, put it in the power of a man to raise himself, in the present state, by the depression of his neighbour, or by the practice of injustice, yet in the pursuit of a prize which is to be gained only by sobriety, righteousness, and piety, there can be no rivalry among the different competitors. The success of one is no injury to another; and therefore, in this sense of the phrase, self-love is not only lawful, but absolutely unavoidable. It has been a question in morals, whether it be not likewise the incentive to every action, however virtuous or apparently disinterested?

Those who maintain the affirmative side of this question say, that the prospect of immediate pleasure, or the dread of immediate pain, is the only apparent motive to action in the minds of infants, and indeed of all who look not before them, and infer the future from the past. They own, that when a boy has had some experience, and is capable of making comparisons, he will often decline an immediate enjoyment which he has formerly found productive of future evil more than equivalent to all its good; but in doing so they think, and they think justly, that he is still actuated by the principle of self-love, pursuing the greatest good of which he knows himself to be capable. After experiencing that truth, equity, and benevolence in all his dealings is the readiest, and indeed the only certain, method of securing to himself the kindness and good offices of his fellow-creatures, and much more when he has learned that they will recommend him to the Supreme Being, upon whom depends his existence and all his enjoyments, they admit that he will practice truth, equity, and benevolence; but still, from the same principle, pursuing his own ultimate happiness as the object which he has always in view. The prospect of this great object will make him feel an exquisite pleasure in the performance of the actions which he conceives as necessary to its attainment, till at last, without attending in each instance to their consequences, he will, by the great associating principle which has been explained elsewhere (see *METAPHYSICS*, part 1st, chap. 1.) feel a refined enjoyment in the actions themselves, and perform them, as occasions offer, without deliberation or reflection. Such, they think, is the origin of benevolence itself, and indeed of every virtue.

Those who take the other side of the question, can hardly deny that self-love thus modified may prompt to vir-

vir.

virtuous and apparently disinterested conduct; but they think it degrading the dignity of man to suppose him actuated solely by motives which can be traced back to a desire of his own happiness. They observe, that the Author of our nature has not left the preservation of the individual, or the continuance of the species, to the deductions of our reason, computing the sum of happiness which the actions necessary to these ends produce to ourselves: on the contrary, He has taken care of both, by the surer impulse of instinct planted in us for these very purposes. And is it conceivable, say they, that He would leave the care of our fellow-creatures a matter of indifference, till each man should be able to discover or be taught that by loving his neighbour, and doing him all the good in his power, he would be most effectually promoting his own happiness? It is dishonouring virtue, they continue, to make it proceed in any instance from a prospect of happiness, or a dread of misery; and they appeal from theory to fact, as exhibited in the conduct of savage tribes, who deliberate little on the consequences of their actions.

Their antagonists reply, that the conduct of savage tribes is to be considered as that of children in civilized nations, regulated entirely by the examples which they have before them; that their actions cannot be the offspring of innate instincts, otherwise savage virtues would, under similar circumstances, everywhere be the same, which is contrary to fact; that virtue proceeds from an interested motive on either supposition; and that the motive which the instinctive scheme holds up is the most selfish of the two. The other theory supposes, that the governing motive is the hope of future happiness and the dread of future misery; the instinctive scheme supply a present motive in the self-complacency arising in the heart from a consciousness of right conduct. The former is a rational motive, the latter has nothing more to do with reason than the enjoyment arising from eating or drinking, or from the intercourse between the sexes. But we mean not to pursue the subject farther, as we have said enough on it in the articles BENEVOLENCE, INSTINCT, PASSION, and PHILANTHROPY. We shall therefore conclude with observing, that there is certainly a virtuous as well as a vicious self-love, and that "true self-love and social are the same."

*SELF-MURDER.* See SUICIDE.

*SELF-PARTIALITY*, is a phrase employed by some philosophers\* to express that weakness of human nature through which men overvalue themselves when compared with others. It is distinguished from general partiality, by those who make use of the expression, because it is thought that a man is led to over-rate his own accomplishments, either by a particular instinct, or by a process of intellect different from that by which he over-rates the accomplishments of his friends or children. The former kind of partiality is wholly selfish; the latter partakes much of benevolence.

This distinction may perhaps be deemed plausible by those who consider the human mind as little more than a bundle of instincts; but it must appear perfectly ridiculous to such as resolve the greater part of apparent instincts into early and deep-rooted associations of ideas. In the partialities which most men have to their friends, their families, and themselves, be instinctive, they are

certainly instincts of different kinds; but an instinctive partiality is a contradiction in terms. Partiality is founded on a comparison between two or more objects; but genuine instincts form no comparisons. See INSTINCT. No man can be said to be partial to the late Dr Johnson, merely for thinking highly of his intellectual powers; nor was the Doctor partial to himself, tho' he thought in this respect with the generality of his countrymen; but if, upon a comparison with Milton, he was deemed the greater poet of the two, such a judgment will be allowed to be partial, whether formed by himself or by any of his admirers. We apprehend, however, that the process of its formation was the same in every mind by which it was held.

The origin of self-partiality is not difficult to be found; and our partialities to our friends may be traced to a similar source. By the constitution of our nature we are impelled to shun pain and to pursue pleasure; but remorse, the severest of all pains, is the never-failing consequence of vicious conduct. Remorse arises from the dread of that punishment which we believe will in a future state be inflicted on vice unrepented of in this; and therefore every vicious person endeavours by all possible means to banish that dread from his own mind. One way of effecting this is to compare his own life with the lives of others; for he fancies that if numbers be as wicked as himself, the benevolent Lord of all things will not involve them in one common ruin. Hence, by magnifying to himself the temptations which led him astray, and diminishing the injuries which his conduct has done in the world, and by adopting a course diametrically the reverse, when estimating the morality or immorality of the conduct of his neighbours, he soon comes to believe that he is at least not more wicked than they. Thus is self-partiality formed in the mind, and quickly blinds him who is under its influence so completely, as to hide from him the very faults which he sees and blames in others. Hence the coward thinks himself only cautious, the miser frugal. Partiality is formed in the very same manner to natural or acquired accomplishments, whether mental or corporeal. These always procure respect to him who is possessed of them; and as respect is accompanied with many advantages, every man wishes to obtain it for himself. If he fail in his attempts, he consoles himself with the persuasion that it is at least due to his merits, and that it is only withheld by the envy of the public. He compares the particular branch of science or bodily accomplishment in which he himself most excels, with those which have conferred splendor on his rival; and easily finds that his own excellencies are of the highest order, and entitled to the greatest share of public esteem. Hence the polite scholar despises the mathematician; the reader of Aristotle and Plato all the modern discoveries in physical and moral science; and the mere experimentalist holds in the most sovereign contempt a critical knowledge of the ancient languages. The pupil of the ancients denies the merits of the moderns, whilst the mere modern allows nothing to the ancients; and thus each becomes partial to his own acquisitions, and of course to himself, for having been at the trouble to make them.

Partiality to our friends and families is generated in the very same way. Whenever we acquire such an affection

Self.

Selim  
||  
Selkirk.

fection for them as to consider their happiness as adding to our own (see PASSION), we magnify their excellencies, and diminish their defects, for the same reason, and by the same process, that we magnify and diminish our own. All partialities, however, are prejudices, and prejudices of the worst kind. They ought therefore to be guarded against with the utmost care, by the same means which we have elsewhere recommended (see PREJUDICE and METAPHYSICS, n<sup>o</sup> 98.); and he who is partial to his own virtue or his own knowledge, will do well to compare the former, not with the conduct of his neighbour, but with the express rule of his duty; and to consider the latter as no farther valuable than as it contributes to the sum of human happiness.

SELIM I. emperor of the Turks, was the second son of Bajazet II. He made war upon his father, and though defeated in 1511, he at last dethroned him and took him prisoner, and immediately dispatched him by poison, together with his elder brother Achmet, and his younger Korkud, an amiable and enlightened prince. Having established his throne by these crimes, he marched against Campson-Gaury sovereign of Egypt, gained a great victory at Aleppo, and slew his general. But though the sultan perished in that battle, the Mameluks determined to oppose the emperor. Selim entering their country at the head of his army, defeated the Egyptians in two battles, and ordered J'oumoumbai, the new elected sultan, who had fallen into his hands, to be hung on a gibbet. He then took Cairo and Alexandria, and in a short time reduced all Egypt to subjection. Thus ended the dominion of the Mameluks in Egypt, which had continued for more than 260 years. He confirmed the ancient privileges of the Venetians in Egypt and Syria, by which they carried on their commerce with India, and formed a league with them to destroy the power of the Portuguese in that country. (See INDIA, n<sup>o</sup> 37). Selim had before this gained a great victory over the Persians, and stripped them of Tauris and Keman. He was preparing to attack Christendom when he was seized with an ulcerous sore in the back. Thinking that the air of Adrianople would restore his health, he ordered himself to be conducted thither; but he died at Clari in Thraee on his road to that city, in the year 1520, in the very spot where he had poisoned his father. He reigned 8 years, and lived 54. He was a prince of great courage, sobriety, and liberality: he was fond of history, and wrote some verses. But these good qualities were obscured by the most abominable crimes that ever disgraced human nature: he made his way to the throne by shedding the blood of his father, and secured it by murdering his brothers and eight nephews, and every bashaw who had been faithful to his duty.

SELINUM, in botany: A genus of the digynia order, belonging to the pentandria class of plants; and in the natural method ranking under the 45th order, *Umbellatæ*. The fruit is oval, oblong, compressed, plane, and striated in the middle: the involucreum is reflexed; the petals cordate and equal. There are seven species, the sylvestre, palustre, cultriacum, carvisolia, chabraeci, seguieri, monnieri.

SELKIRK (Alexander), whose adventures gave rise to a well-known historical romance, was born at Largo, in the county of Fife, about the year 1676, and was bred a seaman. He went from England, in

1703, in the capacity of sailing-master of a small vessel called the *Cinque-Ports Galley*, Charles Pickering captain, burthen about 90 tons, with 16 guns and 63 men; and in September the same year sailed from Corke, in company with another ship of 26 guns and 120 men, called the *St George*, commanded by that famous navigator William Dampier, intending to cruize on the Spaniards in the South Sea. On the coast of Brazil, Pickering died, and was succeeded in his command by his lieutenant Thomas Stradling. They proceeded on their voyage round Cape Horn to the island of Juan Fernandes, whence they were driven by the appearance of two French ships of 36 guns each, and left five of Stradling's men there on shore, who were taken off by the French. Hence they sailed to the coast of America, where Dampier and Stradling quarrelled, and separated by agreement, on the 19th of May 1704. In September following, Stradling came again to the island of Juan Fernandes, where Selkirk and his captain had a difference, which, with the circumstance of the ship's being very leaky, and in bad condition, induced him to determine on staying there alone; but when his companions were about to depart, his resolution was shaken, and he desired to be taken on board again. The captain, however, refused to admit him, and he was obliged to remain, having nothing but his clothes, bedding, a gun, and a small quantity of powder and ball; a hatchet, knife, and kettle; his books, and mathematical and nautical instruments. He kept up his spirits tolerably till he saw the vessel put off, when (as he afterwards related) his heart yearned within him, and melted at parting with his comrades and all human society at once.

“ ——— Yet believe me, Arcas,  
Such is the rooted love we bear mankind,  
All russians as they were, I never heard  
A sound so dismal as their parting oars.”

*Thomson's Agamemnon.*

Thus left sole monarch of the island, with plenty of the necessaries of life, he found himself in a situation hardly supportable. He had fish, goat's flesh, turnips and other vegetables; yet he grew dejected, languid, and melancholy, to such a degree as to be scarce able to refrain from doing violence to himself. Eighteen months passed before he could, by reasoning, reading his bible, and study, be thoroughly reconciled to his condition. At length he grew happy, employing himself in decorating his huts, chasing the goats, whom he equalled in speed, and scarcely ever failed of catching. He also tamed young kids, laming them to prevent their becoming wild; and he kept a guard of tame cats about him, to defend him when asleep from the rats, who were very troublesome. When his clothes were worn out, he made others of goats skins, but could not succeed in making shoes, with the use of which, however, habit, in time, enabled him to dispense. His only liquor was water. He computed that he had caught 1000 goats during his abode in the island; of which he had let go 500, after marking them by slitting their ears. Commodore Anson's people, who were there about 30 years after, found the first goat which they shot upon landing was thus marked, and as it appeared to be very old, concluded that it had been under the power of Selkirk. But it appears by captain Carteret's account of his voyage in the Swallow sloop, that other persons practised this mode of marking, as he found a

Selkirk.

Selkirk, goat with his ears thus slit on the neighbouring island of Mas-a-fuera, where Selkirk never was. He made companions of his tame goats and cats, often dancing and singing with them. Though he constantly performed his devotions at stated hours, and read aloud; yet, when he was taken off the island, his language, from disuse of conversation, was become scarcely intelligible. In this solitude he continued four years and four months; during which time only two incidents happened which he thought worth relating, the occurrences of every day being in his circumstances nearly similar. The one was, that, pursuing a goat eagerly, he caught it just on the edge of a precipice, which was covered with bushes, so that he did not perceive it, and he fell over to the bottom, where he lay (according to captain Roger's account) 24 hours senseless; but, as he related to Sir R. Steele, he computed, by the alteration of the moon, that he had lain three days. When he came to himself, he found the goat lying under him dead. It was with great difficulty that he could crawl to his habitation, whence he was unable to stir for ten days, and did not recover of his bruises for a long time. The other event was the arrival of a ship, which he at first supposed to be French: and such is the natural love of society in the human mind, that he was eager to abandon his solitary felicity, and surrender himself to them, although enemies; but upon their landing, approaching them, he found them to be Spaniards, of whom he had too great a dread to trust himself in their hands. They were by this time so near that it required all his agility to escape, which he effected by climbing into a thick tree, being shot at several times as he ran off. Fortunately the Spaniards did not discover him, though they stayed some time under the tree where he was hid, and killed some goats just by. In this solitude Selkirk remained until the 2d of February 1709, when he saw two ships come into the bay, and knew them to be English. He immediately lighted a fire as a signal; and on their coming on shore, found they were the Duke captain Rogers, and the Duchefs captain Courtney, two privateers from Bristol. He gave them the best entertainment he could afford; and, as they had been a long time at sea without fresh provisions, the goats which he caught were highly acceptable. His habitation consisting of two huts, one to sleep in, the other to dress his food in, was so obscurely situated, and so difficult of access, that only one of the ship's officers would accompany him to it. Dampier, who was pilot on board the Duke, and knew Selkirk very well, told captain Rogers, that, when on board the Cinque-Ports, he was the best seaman on board that vessel; upon which captain Rogers appointed him master's mate of the Duke. After a fortnight's stay at Juan Fernandes, the ships proceeded on their cruise against the Spaniards; plundered a town on the coast of Peru; took a Manilla ship off California; and returned by way of the East Indies to England, where they arrived the 1st of October 1711; Selkirk having been absent eight years, more than half of which time he had spent alone in the island. The public curiosity being excited respecting him, he was induced to put his papers into the hands of Defoe, to arrange and form them into a regular narrative. These papers must have been drawn up after he left Juan Fernandes, as he had no means of recording his transactions there. Captain Cooke remarks, as an extraordinary circumstance, that he had

contrived to keep an account of the days of the week and month: but this might be done, as Defoe makes Robinson Crusoe do, by cutting notches in a post, or many other methods. From this account of Selkirk, Defoe took the idea of writing a more extensive work, the romance of Robinson Crusoe, and very dishonestly defrauded the original proprietor of his share of the profits. Of the time or place or manner of this extraordinary man's death we have received no account; but in 1792 the chest and musket which Selkirk had with him on the island were in the possession of his grand-nephew, John Selkirk weaver in Largo, where doubts less they are at present.

SELKIRK, the capital of the county of the same name, is a small town pleasantly situated on a rising ground, and enjoys an extensive prospect in all directions, especially up and down the river Etterick. It is remarkable for nothing but those plaintive airs produced in its neighbourhood, the natural simplicity of which are the pride of Scotland and the admiration of strangers. W. Long. 2. 46. N. Lat. 55. 26.

SELKIRKSHIRE, called also the *Sheriffdom of Etterick Forest*, a county of Scotland, extending about 20 miles in length from east to west, and about 12 in breadth from south to north. It borders on the north with part of Tweeddale and Mid-Lothian; on the south and east with Teviotdale; and on the west with Annandale. This county was formerly reserved by the Scottish princes for the pleasure of the chase, and where they had houses for the reception of their train. At that time the face of the country was covered with woods, in which there were great numbers of red and fallow deer, whence it had the name of *Etterick Forest*. The woods, however, are now almost entirely cut down, and the county is chiefly supported by the breed of sheep. They are generally sold into the south, but sometimes into the Highlands, about the month of March, where they are kept during summer; and after being improved by the mountain-grass, are returned into the Lowlands in the beginning of winter.

This county, though not very populous at present, was once the nurse of heroes, who were justly accounted the bulwark of their native soil, being ever ready to brave danger and death in its defence. Of this we have a memorable proof in the pathetic lamentations of their wives and daughters for the disaster of the field of Flowden. "where their brave foresters were a' wed away." The rivers Etterick and Yarrow unite a little above the town of Selkirk, and terminate in the Tweed. For five miles above its junction with the Etterick, the Tweed is still adorned with woods, and leads the pleased imagination to contemplate what this country must have been in former times. The Yarrow, for about five miles above its junction with Etterick, exhibits nature in a bold and striking aspect. Its native woods still remain, through which the stream has cut its turbid course, deeply engulfed amidst rugged rocks. Here, certainly in a flood, stood the descriptive Thomson when he saw it

"Work and boil, and foam and thunder through."

Upon a peninsula, cut out by the surrounding stream, in the middle of this fantastically wild scene of grandeur and beauty, stands the castle of Newark, which has been supposed by many to be the birth-place of Mary Scot the flower of Yarrow; but this we believe to be a mistake.

Sella,  
Seltzer.

SELLA TURCICA, is a deep depression between the clinoid apophyses of the sphenoid bone. See ANATOMY, p. 682.

SELTZER WATER, is a mineral water which springs up at Lower Seltzer, a village in the electorate of Triers, about 10 miles from Frankfort on the Mayne. It is a very useful medicinal water. It contains, according to some, a very small portion of calcareous earth, of a native mineral alkali, and an acid; but of these the quantity is too small to attribute any medicinal virtues to; but it contains also near 1.7th of its bulk of fixed air, which is more than is found in any other mineral water, and to this it owes its principal virtues. Others have said that it is of the very same nature with Pyrmont water, and contains a subtile aqueous fluid, a volatile iron, and a predominant alkali, all joined together into one brisk spirituous water. The consequence of these different opinions respecting its constituent parts is, that different methods have been recommended for imitating it.

According to the former analysis, artificial Seltzer water may be prepared by adding one scruple of magnesia alba, six scruples of fossil alkali, and four scruples of common salt, to each gallon of water, and saturating the water with fixed air or carbonic acid. According to the latter it may be imitated by adding to a quart of the purest and lightest water thirty drops of a strong solution of iron made in spirit of salt, a drachm of oil of tartar per deliquium, and thirty drops of spirit of vitriol, or a little more or less as is found necessary, not to let the alkali of the oil of tartar prevail too strongly, tho' it must prevail a little. If the proportions be carefully observed, and the whole of these ingredients shaken briskly together, the artificial Seltzer or Pyrmont water thus made will strongly resemble the natural, and have the same good effect in medicine.

But as fixed air is the only efficacious medicinal part of the composition of Seltzer water, the best method of imitating it is by impregnating common water with that acid by a process for which we are indebted to Dr Priestley. The first idea of this kind occurred to him in 1767, when, having placed shallow vessels of water within the region of fixed air, on the surface of the fermenting vessels of a brewery, and left them all night in that situation, he found that the water had acquired a very sensible and pleasant impregnation. He proceeded to accelerate the impregnation by pouring the water from one vessel into another, while they were both held within the sphere of the fixed air. The method of effecting this by air dislodged from chalk and other calcareous substances did not occur to him till the year 1772, when he published his directions for this purpose, together with a drawing of the necessary apparatus, which he had before communicated to the Board of Admiralty. That apparatus has now given way to another invented by Dr Nooth, which is made of glass, and stands on a wooden vessel *dd* (fig 1.) resembling a tea-board: the middle vessel *B* has a neck which is inserted into the mouth of the vessel *A*, to which it is ground air-tight. The lower neck of the vessel *B* has a glass stopper *S*, composed of two parts, both having holes sufficient to let a good quantity of air pass through them. Between these two parts is left a small space, containing a plano-convex lens, which acts like a valve, in letting the air pass from below upwards, and

hindering its return into the vessel *A*. The upper vessel *C* terminates below in a tube *rt*, which being crooked, hinders the immediate ascent of the bubbles of fixed air into that vessel, before they reach the surface of the water in the vessel *B*. The vessel *C* is also ground air-tight to the upper neck or the middle vessel *B*, and has a stopper *p* fitted to its upper mouth, which has a hole through its middle. The upper vessel *C* holds just half as much as the middle one *B*; and the end *t* of the crooked tube goes no lower than the middle of the vessel *B*.

For the use of this apparatus: Fill the middle vessel *B* with spring or any other wholesome water, and join to it the vessel *C*. Pour water into the vessel *A* (by the opening *m*, or otherwise) so as to cover the rising part of its bottom: for this about three-fourths of a pint will be sufficient. Fill an ounce phial with oil of vitriol, and add it to the water, shaking the vessel so as to mix them well together. As heat is generated, it will be best to add the oil by a little at a time, otherwise the vessel may be broken. Put to this, through a wide glass or paper funnel, about an ounce of powdered raw chalk or marble. White marble being first granulated, or pounded like coarse sand, is better for the purpose than powdered chalk, because it is harder; and therefore the action of the diluted acid upon it is slower, and lasts to a considerable time. On this account the supply of fixed air from it is more regular than with the chalk: and besides, when no more air is produced, the water may be decanted from the vessel *A*, and the white sediment washed off, and the remaining granulated marble may be employed again, by adding to it fresh water and a new quantity of oil of vitriol. The funnel in this process is made use of, in order to prevent the powder from touching the inside of the vessel's mouth; for if that happens, it will stick so strongly to the neck of the vessel *B* as not to admit of their being separated without breaking. Place immediately the two vessels *B* and *C* (fastened to each other) into the mouth of the vessel *A*, as in the figure, and all the fixed air which is disengaged from the chalk or marble by the oil of vitriol will pass up through the valve in *S* into the vessel *B*. When this fixed air comes to the top of the vessel *B*, it will dislodge from thence as much water as is equal to its bulk; which water will be forced up through the crooked tube into the upper vessel *C*.

Care must be taken not to shake the vessel *A* when the powdered chalk is put in; otherwise a great and sudden effervescence will ensue, which will perhaps expel part of the contents. In this case it may be necessary to open a little the stopper *p*, in order to give vent, otherwise the vessel *A* may burst. It will be proper also to throw away the contents and wash the vessel; for the matter will stick between the necks of the vessels, and cement them together. The operation must then be begun afresh. But if the chalk be put into the vessel loosely wrapt up in paper, this accident will be still better guarded against. When the effervescence goes on well, the vessel *C* will soon be filled with water, and the vessel *B* half filled with air; which will easily be known to be the case by the air going up in large bubbles through the crooked tube *rt*.

When this is observed, take off the two vessels *B* and *C* together as they are, and shake them so that the water and air within them may be much agitated. A great

Seltzer.

Plate  
CCCLXIV.

part

Seltzer. part of the fixed air will be absorbed into the water, as will appear by the end of the crooked tube being considerably under the surface of the water in the vessel. The shaking them for two or three minutes will be sufficient for this purpose. These vessels must not be shaken while joined to the under one A, otherwise too great an effervescence will be occasioned in the latter, together with the ill consequence above mentioned. After the water and air have been sufficiently agitated, loosen the upper vessel C, so that the remaining water may fall down into B, and the unabsorbed air pass out. Put these vessels together, and replace them into the mouth of A, in order that B may be again half filled with fixed air. Shake the vessels B and C, and let out the unabsorbed air as before. By repeating the operation three or four times, the water will be sufficiently impregnated.

Whenever the effervescence nearly ceases in the vessel A, it may be renewed by giving it a gentle shake, so that the powdered chalk or marble at the bottom may be mixed with the oil of vitriol and water above it; for then a greater quantity of fixed air will be disengaged. When the effervescence can be no longer renewed by shaking the vessel A, either more chalk must be put in, or more oil of vitriol; or more water, if neither of these produce the desired effect.

Mr Magellan has still further improved this contrivance. He has two sets of the vessels B and C. While he is shaking the air and water contained in one of these sets, the other may be receiving fixed air from the vessel A. By this means twice the quantity of water may be impregnated in the same time. He has a wooden stand on which to fix the vessels B, C, when taken off from A, which is very convenient. He has a small tin trough for measuring the quantity of chalk or marble requisite for one operation, and a wide glass funnel for putting it through into the vessel A, to prevent its sticking to the sides, as mentioned before.

He has also contrived a stopper without a hole, to be used occasionally instead of the perforated one *p*. It must be of a conical figure, and very loose; but so exactly and smoothly ground as to be air-tight merely by its pressure. Its use is to compress the fixed air on the water, and thereby increase the impregnation. For by keeping the air on the water in this compressed state, the latter may be made to sparkle like champagne. And if the vessels are strong, there will be no danger of their bursting in the operation.

The water thus impregnated may be drawn out at the opening *k*. But if it is not wanted immediately, it will be better to let it remain in the machine, where it has no communication with the external air; otherwise the fixed air flies off by degrees, and the water becomes vapid and flat. But it may be kept a long time in bottles well stopped, especially if they are placed with their mouths downwards.

Dr Withering of Birmingham has lately contrived a new apparatus for impregnating water with fixed air, which, he says, is preferable to that in common use, because it can be made at less expence, and is more easily prepared; because the whole quantity of fixable air produced is converted to use, without any waste of the vitriolic acid; because it impregnates three times the quantity of water at one time more completely and with less trouble; and the impregnated water will al-

ways retain its virtue, if the joints and cocks of the machine are made perfectly air-tight; for which purpose they should once a-year be supplied with a small quantity of unsalted lard. This apparatus is exhibited by fig. 2. and consists of a glass vessel A, about ten inches high in the cylindrical part, and six inches and a half in diameter; another glass vessel B, about twelve inches high in the conical part, one inch and a half in the neck, and five inches in diameter at the bottom; a copper pipe C passing through the stopper of the vessel B, and tied fast in the flexible tube D, made of strong leather, air-tight, and kept hollow by means of a spiral wire passing through its whole length; a conical brass pipe E, with a stop-cock fastened to the tube D; another conical pipe F, with a stop-cock G, into which the end of the tube E is accurately ground so as to be air-tight, and cutting off all communication with the atmosphere when the pipe E is removed; two large hog's bladders H, H, each of which ought to hold two quarts; a stop-cock I to prevent the water rising into the bladders when the vessel A is agitated; a bladder K tied to the crooked tube with the stop-cock L, which occasionally opens or shuts the communication with the vessel B; a glass funnel M, accurately fitted with the glass stopper N; an aperture O, fitted with a glass stopper or a silver cock, from which the impregnated water is to be drawn for use; and, lastly, the tube P opening into the vessel A. When this apparatus is used, let the vessel A be filled with pure water, and any other ingredients that are required, in a proper proportion; into the vessel B put as much marble or whiting, in small lumps, as will cover its bottom to the height of about two inches; and pour in water to the height represented by the dotted line; let the mouth of the vessel A be well fitted with a cork, and through a hole in the cork pass the tube P, putting upon the cork melted sealing-wax of the softest kind, or modelling-wax, so as to make the whole air-tight. Let the mouth of the vessel B be stopped with a piece of mahogany, turned into a conical figure in a lathe, and of a size somewhat larger than the mouth of the glass will admit; put this piece of wood into melted bees-wax, and heat the wax till the wood begins to grow black; when cool, turn it again till it fits the mouth of the vessel: the tubes C, L, and M are fitted into holes and bored through the wooden stopper previous to its being immersed in the wax; push these tubes through the holes, and press the stopper into the orifice of the vessel B, and cement the whole with sealing or modelling-wax; shut the stop-cocks I and L, having previously pressed the air out of the bladder K: open the stop-cocks G and E; then squeeze the air out of the bladders H, H, and afterwards press the conical pipe E into the pipe F; pour about a large spoonful of oil of vitriol through the funnel M, and stop it with its stopper N. The fixable air let loose by the effervescence in the vessel B, rising through the tube C, passes into the bladders H, H, and dilends them. In this case open the stop-cock I, and from the aperture O draw out about a quart of water; and the space before occupied by the water will be filled with fixable air, which soon begins to be absorbed by the remaining water, and is still supplied from the bladders H, H, and from the effervescing mixture in the vessel B. When the bladders are considerably collapsed, more vitriolic acid must be added through the

Seltzer

funnel M, so that they may be always kept pretty fully distended. When an impregnation is speedily required, turn the stop-cocks at G and E, and open that at L; then separate the pipe E from the tube F, and agitate the vessel A; the fixable air will pass into the bladder K, and may be pressed into the two other bladders, when the parts of the apparatus are united. During the agitation, the stop-cock at I should be closed, and opened only occasionally to supply out of the bladders H, H, the fixable air absorbed by the water. If a strong impregnation be required, this process should be carried on in a room, the heat of which does not exceed forty-eight degrees of Fahrenheit's thermometer. Dr Withering observes, that the impregnated water receives no taste from the bladders; and that if the vessel A with its impregnated water be separated from the vessel B at the conical parting E, F, it may be inclosed in a pyramidal mahogany case, out of the lower part of which the silver cock at O projects; and thus serve for an ornamental as well as luxurious and salubrious addition to the side-board, particularly in the summer and autumnal seasons.

The artificial mineral waters thus made, are more pleasant to the taste than the natural Pyrmont or Seltzer waters; which, besides their fixed air, contain saline particles of a disagreeable taste, which are known to contribute little or nothing to their medicinal virtues, and may, in some cases, be hurtful. They are likewise considerably stronger. According to Sir John Pringle, these waters may be made more nearly to resemble genuine Pyrmont water, by adding to each pint of them from eight to ten drops of *tinctura martis cum spiritu salis*. Or this may be done, by adding to the water in the middle vessel B (fig. 1.), in the proportion of about thirty grains of Epsom salt, ten grains of common salt, a scruple of magnesia alba, and a dram of iron filings or iron wire, clean and free from rust, to one gallon of spring water, and impregnating the whole with fixed air in the manner already described. Let them remain, till the other ingredients and as much of the iron as is necessary are dissolved; which will be in two or three days; or the magnesia may be omitted, and then the operation will be finished in less than half that time. These waters may be rendered ferruginous or chalybeate very easily, by putting in the middle vessel two or more slender phials, filled with cuttings of fine iron-binding wire, or with small iron nails; because the impregnated water will dissolve the iron so fast, as to become well saturated with it in a few hours, according to the experiments of Mr Lane. But the method of rendering these artificial waters chalybeate, used by Dr Hulme, is to add one grain of salt of steel to each pint (sixteen ounces) of water already impregnated with fixed air.

But the ingenious Mr Bewley has invented a still better method of exhibiting fixed air as a medicine. He directs a scruple of alkaline salt to be dissolved in a sufficient quantity (a quarter of a pint, or less) of water, which is to be impregnated with as much fixed air as it can imbibe: this is to be taken at one dose. Mr Bewley directs it to be prepared in larger quantities at a time, and calls it his mephitic julep. If immediately after it a spoonful of lemon juice, mixed with two or three spoonfuls of water, and sweetened with sugar, be drunk, the fixed air will be extricated in the stomach;

and thus a much greater quantity of it may be given than the same quantity of water alone can be made to imbibe. Fixed air acts as a corroborant; and therefore may be given with success in weakness of the stomach, and in vomitings arising from that cause. It has also been given with success in the stone and in nephritic complaints. When the lungs are purulent, fixed air mixed with the air drawn into the lungs has repeatedly been found to perform a cure. The bark also may be given with advantage in water impregnated with fixed air, as they both coincide in their effect. Fixed air may be applied by means of a syringe, funnel, or otherwise, to inflamed breasts, putrid ulcers, mortified parts, ulcerated fore throats, and has been found in such and similar cases to have very remarkable efficacy. It may also be given internally at the same time. In putrid dysenteries, and in putrid stools, fixed air may be given by way of clyster. Fermenting cataplasms are of service, chiefly as they supply fixed air to the part. In cases of putridity fixed air has been successfully applied to the surface of the body exposed to streams of it. It is also found an excellent cooling as well as strengthening beverage in hot relaxing weather, and has the advantage of being pleasant to the taste.

SEM, or SHEM, the son of Noah, memorable for his filial piety in concealing the folly and disgrace of his father; for which he received a remarkable benediction, about 2476 B. C. He lived to the age of 600 years.

RAS SEM. See *RAS SEM* and *PETREFIED City*.

SEMECARPUS, in botany; a genus of the trigynia order, belonging to the pentandria class of plants. The corolla is quinquepetalous; the drupe is heart-shaped, cellulous, and monospermous. There is but one species.

SEMEN, SEED. See *BOTANY*, sect. iv. p. 435.

With respect to number, plants are either furnished with one seed, as sea-pink and bistort; two, as wood-roof and the umbelliferous plants; three, as spurge; four, as the lip-flowers of Tournefort and rough-leaved plants of Ray; or many, as ranunculus, anemone, and poppy.

The form of seeds is likewise extremely various, being either large or small, round, oval, heart-shaped, kidney-shaped, angular, prickly, rough, hairy, wrinkled, sleek or shining, black, white, or brown. Most seeds have only one cell or internal cavity; those of lesser burdock, valerian, lamb's lettuce, cornelian cherry, and fe-besten, have two.

With respect to substance, seeds are either soft, membranaceous, or of a hard bony substance; as in grom-well, tamarind, and all the nuciferous plants.

In point of magnitude, seeds are either very large, as in the cocoa-nut; or very small, as in campanula, *ammannia*, rampions, and throat-wort.

With respect to situation, they are either dispersed promiscuously through the pulp (*femina nidulanti*), as in water-lily; affixed to a suture or joining of the valves of the seed-vessel, as in the cross-shaped and pea-bloom flowers; or placed upon a *placenta* or receptacle within the seed vessel, as in tobacco and thorn-apple.

Seeds are said to be naked (*femina nuda*) which are not contained in a cover or vessel: such are those of the lip and compound flowers, the umbelliferous and rough-leaved plants; covered seeds (*femina lecta*) are

Sema  
||  
Semen.



**Semen.** contained in some vessel, whether of the capsule, pod, berry, apple, or cherry kind.

A simple seed is such as bears neither crown, wing, nor downy *pappus*; the varieties in seeds, arising from these circumstances, are particularly enumerated under their respective heads.

In assimilating the animal and vegetable kingdoms, Linnæus denominates seeds the eggs of plants. The fecundity of plants is frequently marvellous; from a single plant or stalk of Indian Turkey wheat, are produced, in one summer, 2000 seeds; of elecampane, 3000; of sun-flower, 4000; of poppy, 32,000; of a spike of cat's tail, 10,000 and upwards: a single fruit, or seed-vessel, of tobacco, contains 1000 seeds; that of white poppy, 8000. Mr Ray relates, from experiments made by himself, that 1012 tobacco-seeds are equal in weight to one grain; and that the weight of the whole quantum of seeds in a single tobacco-plant, is such as must, according to the above proportion, determine their number to be 362,000. The same author estimates the annual produce of a single stalk of spleen-wort to be upwards of one million of seeds.

The dissemination of plants respects the different methods or vehicles by which nature has contrived to disperse their seeds for the purpose of increase. These by naturalists are generally reckoned four.

1. Rivers and running waters. 2. The wind. 3. Animals. 4. An elastic spring, peculiar to the seeds themselves.

1. The seeds which are carried along by rivers and torrents are frequently conveyed many hundreds of leagues from their native soil, and cast upon a very different climate, to which, however, by degrees they render themselves familiar.

2. Those which are carried by the wind, are either *winged*, as in fir-tree, trumpet-flower, tulip-tree, birch, arbor-vitæ, meadow rue, and Jessamine, and some umbelliferous plants; furnished with a *pappus*, or downy crown, as in valerian, poplar, reed, succulent swallow-wort, cotton-tree, and many of the compound flowers; placed within a winged *calyx* or seed-vessel, as in scabious, sea-pink, dock, dioscorea, ash, maple, and elm-trees, logwood and woad; or lastly, contained within a swelled *calyx* or seed-vessel, as in winter-cherry, cucubalus, melilot, bladder-nut, fumatory, bladder-sena, heart-feed, and chick-pease.

3. Many birds swallow the seeds of vanelloe, juniper, mistletoe, oats, millet, and other grasses, and void them entire. Squirrels, rats, parrots, and other animals, suffer many of the seeds which they devour to escape, and thus in effect disseminate them. Moles, ants, earthworms, and other insects, by ploughing up the earth, admit a free passage to those seeds which have been scattered upon its surface. Again, some seeds attach themselves to animals, by means of hooks, crotchets, or hairs, which are either affixed to the seeds themselves, as in hound's tongue, mouse-ear, vervain, carrot, bastard-parsley, fanicle, water hemp-agrimony, *arctopus* and *verbesina*; to their calyx, as in burdock, agrimony, *rhexia*, small wild bugloss, dock, nettle, pellitory, and lead wort; or to their fruit or seed-vessel, as in liquorice, enchanter's night shade, cross-wort, clivers, French honey-suckle, and arrow-headed grass.

4. The seeds which disperse themselves by an elastic force, have that force resident either in their *calyx*, as

in oats and the greater number of ferns; in their *pappus*, as in centaurea erupina; or in their *capsule*, as in geraanium, herb-bennet, African spiræa, fraxinella, horie-tail, balsam, Malabar nut, cucumber, clatium, and male balsam apple.

SEMEN, in the animal economy. See PHYSIOLOGY, sect. xii. and ANATOMY, n<sup>o</sup> 109.

SEMEN Santalum, or Santonicum. See ARTEMISIA.

SEMENDRIAH, a town of Turkey in Europe, in the province of Servia, with a good citadel. It is the capital of a sangiacate, was taken by the Turks in 1690, and is seated on the Danube, in E. Long. 21. 45. N. Lat. 45. 0.

SEMENTINÆ FERIÆ, in antiquity, feasts held annually among the Romans, to obtain of the gods a plentiful harvest. They were celebrated in the temple of Tellus, where solemn sacrifices were offered to Tellus and Ceres. These feasts were held about seed-time, usually in the month of January; for, as Macrobius observes, they were moveable feasts.

SEMI, a word borrowed from the Latin, signifying *half*; but only used in composition with other words, as in the following articles.

SEMI-Arians, in ecclesiastical history, a branch of the ancient Arians, consisting, according to Epiphanius, of such as, in appearance, condemned the errors of that heresiarch, but yet acquiesced in some of the principles thereof, only palliating and hiding them under softer and more moderate terms. Though they separated from the Arian faction (see ARIANS), they could never be brought to acknowledge that the Son was homouousios, that is, consubstantial, or of the same substance with the Father; they would only allow him to be homioousios, that is, of a like substance with the Father, or similar to the Father in his essence, not by nature, but by a peculiar privilege.

The semi-arianism of the moderns consists in their maintaining that the Son was from all eternity begotten by the *will* of the Father, contrary to the doctrine of the orthodox, who seem to teach that the eternal generation is *necessary*. Such at least are the respective opinions of Dr Clarke and Bishop Bull. See THEOLOGY.

SEMICIRCLE, in geometry, half a circle, or that figure comprehended between the diameter of the circle and half its circumference.

SEMICOLON, in grammar, one of the points or stops used to distinguish the several members of a sentence from each other.

The mark or character of the semicolon is (;), and has its name as being of somewhat less effect than a colon; or as demanding a shorter pause.

The proper use of the semicolon is to distinguish the conjunct members of a sentence. Now, by a conjunct member of a sentence is meant such a one as contains at least two simple members.—Whenever, then, a sentence can be divided into several members of the same degree, which are again divisible into other simple members, the former are to be separated by a semicolon. For instance: "If fortune bear a great sway over him, who has nicely stated and concerted every circumstance of an affair; we must not commit every thing, without reserve, to fortune, lest she have too great a hold of us." Again: *Si quantum in agro locisque desertis audacia potest, tantum in foro atque judiciis impudentia valeret; non minus in causa cederet Aulus Cicerina Sexta Ebutii impudentia.*

Semen  
||  
Semi.

Semicul-  
buni  
||  
Semi-ela-  
gians.

*dentie, quam tum in vi facienda cessit audacia.* An instance in a more complex sentence we have in Cicero: *Res familiaris primum bene parata sit, nulloque turpi questu: tum quam plurimis, modo dignis, se uilem præbeat; deinde augetur ratione, diligentia, parsimonia; nec libidini potius luxuriaeque, quam liberalitati et beneficentia pareat.*

But though the proper use of the semicolon be to distinguish conjunct members, it is not necessary that all the members divided hereby be conjunct. For upon dividing a sentence into great and equal parts, if one of them be conjunct, all those other parts of the same degree are to be distinguished by a semicolon.—Sometimes also it happens, that members that are opposite to each other, but relate to the same verb, are separated by a semicolon. Thus Cicero: *Ex hac parte pudor, illinc petulantia; hinc fides, illinc fraudatio; hinc pietas, illinc scelus, &c.* To this likewise may be referred such sentences, where the whole going before, the parts follow: as “The parts of oratory are four; invention, disposition, elocution, and pronunciation.”

**SEMICUBIUM**, in medicine, a half-bath, wherein the patient is only placed up to the navel.

**SEMI-DIAMETER**, half the diameter, or a right line drawn from the centre of a circle or sphere to its circumference: being the same with what is otherwise called the *radius*.

**SEMI-FLOSCULUS**, in botany, a term used to express the flowers of the syngenesia class. These semiflosculi are petals, hollow in their lower part, but in their upper flat, and continued in the shape of a tongue.

**SEMITONE**, in music. See **INTERVAL**.

**SEMINAL**, something belonging to the semen or seed.

**SEMINARY**, in its primary sense, the ground where any thing is sown, to be afterwards transplanted.

**SEMINARY**, in a figurative sense, is frequently applied to places of education, whence scholars are transplanted into life.—In Catholic countries it is particularly used for a kind of college or school, where youth are instructed in the ceremonies, &c. of the sacred ministry. Of these there are great numbers; it being ordained by the council of Trent, that there be a seminary belonging to each cathedral, under the direction of the bishop.

**SEMINATION**, denotes the manner or act of shedding and dispersing the seeds of plants. See **SEMEN**.

**SEMIPELAGIANS**, in ecclesiastical history, a name anciently, and even at this day, given to such as retain some tincture of Pelagianism. See **PELAGIANS**.

Cassian, who had been a deacon of Constantinople, and was afterwards a priest at Marseilles, was the chief of these Semipelagians; whose leading principles were, 1. That God did not dispense his grace to one more than another in consequence of predestination, *i. e.* an eternal and absolute decree, but was willing to save all men, if they complied with the terms of his gospel. 2. That Christ died for all men. 3. That the grace purchased by Christ, and necessary to salvation, was offered to all men. 4. That man, before he received grace, was capable of faith and holy desires. 5. That man was born free, and was consequently capable of resisting the influences of grace, or of complying with its suggestion. The Semipelagians were very numerous; and the doctrine of Cassian, though variously explained, was received in the greatest part of the monastic schools in Gaul, from whence it spread itself far and wide thro'

the European provinces. As to the Greeks and other Semiramis, eastern Christians, they had embraced the Semipelagian Semipervi- doctrines before Cassian, and still adhere to them. In vum. the 6th century, the controversy between the Semipelagians and the disciples of Augustin prevailed much, and continued to divide the western churches.

**SEMIRAMIS** (fab. hist.), a celebrated queen of Assyria, daughter of the goddess Derceto, by a young Assyrian. She was exposed in a desert; but her life was preserved by doves for one whole year, till Simmas, one of the shepherds of Ninus, found her and brought her up as his own child. Semiramis, when grown up, married Menones, the governor of Nineveh, and accompanied him to the siege of Bactria; where, by her advice and prudent directions, she hastened the king's operations, and took the city. These eminent services, together with her uncommon beauty, endeared her to Ninus. The monarch asked her of her husband, and offered him his daughter Sofana in her stead; but Menones, who tenderly loved Semiramis, refused; and when Ninus had added threats to entreaties, he hanged himself. No sooner was Menones dead, than Semiramis, who was of an aspiring soul, married Ninus, by whom she had a son called *Ninyas*. Ninus was so fond of Semiramis, that at her request he resigned the crown, and commanded her to be proclaimed queen and sole empress of Assyria. Of this, however, he had cause to repent: Semiramis put him to death, the better to establish herself on the throne; and when she had no enemies to fear at home, she began to repair the capital of her empire, and by her means Babylon became the most superb and magnificent city in the world. She visited every part of her dominions, and left everywhere immortal monuments of her greatness and benevolence. To render the roads passable and communication easy, she hollowed mountains and filled up valleys, and water was conveyed at a great expence by large and convenient aqueducts to barren deserts and unfruitful plains. She was not less distinguished as a warrior: Many of the neighbouring nations were conquered; and when Semiramis was once told as she was dressing her hair, that Babylon had revolted, she left her toilette with precipitation, and though only half dressed, she refused to have the rest of her head adorned before the sedition was quelled and tranquillity re-established. Semiramis has been accused of licentiousness; and some authors have observed that she regularly called the strongest and stoutest men in her army to her arms, and afterwards put them to death, that they might not be living witnesses of her incontinence. Her passion for her son was also unnatural; and it was this criminal propensity which induced Ninyas to destroy his mother with his own hands. Some say that Semiramis was changed into a dove after death, and received immortal honours in Assyria. It is supposed that she lived about 11 centuries before the Christian era, and that she died in the 62d year of her age and the 25th of her reign. Many fabulous reports have been propagated about Semiramis, and some have declared that for some time she disguised herself and passed for her son Ninyas. *Lempriere's Bibliotheca Classica.*

**SEMPERVIVUM**, **HOUSE-LEEK**, in botany: A genus of plants belonging to the order of dodecagymnia, and to the class of dodecandria; and in the natural method ranking under the 13th order, *Succulentæ*. The calyx is divided into 12 parts; the petals are 12, and the capsules

12, containing many seeds. There are 12 species; the arboreum, canariense, glutinosum, glandulosum, tectorum, globiferum, villosum, tortuosum, arachnoideum, montanum, fedeforme, and menanthes. Linnæus has only eight of these. The tectorum alone is a native of Britain. The stalk is about a foot high; the radical leaves are thick, oval, pointed, fringed, and spreading in a rose; those on the stem are imbricated and membranous: the flowers are pale red and sessile, and grow on curved terminal bunches. It is frequent on the tops of houses, and flowers in July.

The following chemical description of this species is given by Lewis: "The leaves of house-leek, of no remarkable smell, discover to the taste a mild subacid austerity: their expressed juice, of a pale yellowish hue when filtered, yields on inspissation a deep yellow, tenacious, mucilaginous mass, considerably acidulous and acerb: from whence it may be presumed, that this herb has some claim to the refrigerant and restraining virtues that have been ascribed to it. It is observable that the filtered juice, on the addition of an equal quantity of rectified spirit of wine, forms a light white coagulum, like cream of fine pomatum, of a weak but penetrating taste: this, freed from the fluid part, and exposed to the air, almost totally exhales. From this experiment it is concluded by some, that house-leek contains a volatile alkaline salt: but the juice coagulates in the same manner with volatile alkalis themselves, as also with fixed alkalis: Acids produce no coagulation."

SENAAR, or SENNAAR. See SENNAAR.

SENATE, in general, is an assembly or council of senators; that is, of the principal inhabitants of a state, who have a share in the government.

The senate of ancient Rome is of all others the most celebrated. It exercised no contentious jurisdiction; but appointed judges, either from among the senators or knights, to determine processes: it also appointed governors of provinces, and disposed of the revenues of the commonwealth, &c. Yet did not the whole sovereign power reside in the senate, since it could not elect magistrates, make laws, or decide of war and peace; in all which cases the senate was obliged to consult the people.

The senate, when first instituted by Romulus, consisted of 100 members; to whom he afterwards added the same number when the Sabines had migrated to Rome. Tarquin the ancient made the senate consist of 300, and this number remained fixed for a long time; but afterwards it fluctuated greatly, and was increased first to 700, and afterwards to 900 by J. Cæsar, who filled the senate with men of every rank and order. Under Augustus the senators amounted to 1000, but this number was reduced, and fixed to 600. The place of a senator was always bestowed upon merit: the monarchs had the privilege of choosing the members; and after the expulsion of the Tarquins, it was one of the rights of the consuls, till the election of the censors, who from their office seemed most capable of making choice of men whose character was irreproachable, whose morals were pure, and relations honourable. Only particular families were admitted into the senate; and when the plebeians were permitted to share the honours of the state, it was then required that they should be born of free citizens. It was also required that the candidates should be knights

before their admission into the senate. They were to be above the age of 25, and to have previously passed through the inferior offices of quæstor, tribune of the people, edile, pretor, and consul.

The senate always met of course on the 1st of January, for the inauguration of the new consuls; and in all months, universally, there were three days, viz. the kalends, nones, and ides, on which it regularly met: but it always met on extraordinary occasions, when called together by consul, tribune, or dictator.

To render their decrees valid and authentic, a certain number of members was requisite, and such as were absent without some proper cause were always fined. In the reign of Augustus, 400 senators were requisite to make a senate. Nothing was transacted before sun-rise or after sun-set. In their office the senators were the guardians of religion, they disposed of the provinces as they pleased, they prorogued the assemblies of the people, they appointed thanksgivings, nominated their ambassadors, distributed the public money, and in short had the management of every thing political or civil in the republic, except the creating of magistrates, the enacting of laws, and the declarations of war or peace, which were confined to the assemblies of the people.

SENATOR, in general, denotes a member of some senate.

The dignity of a Roman senator could not be supported without the possession of 80,000 sesterces, or about 7000 l. English money; and therefore such as squandered away their money, and whose fortune was reduced below this sum, were generally struck out of the list of senators. This regulation was not made in the first ages of the republic, when the Romans boasted of their poverty. The senators were not permitted to be of any trade or profession. They were distinguished from the rest of the people by their dress; they wore the laticlave, half-boots of a black colour, with a crescent or silver buckle in the form of a C; but this last honour was confined only to the descendants of those hundred senators who had been elected by Romulus, as the letter C seems to imply. See the preceding article.

Among us, senator is a member of parliament. In the laws of king Edward the Confessor, we are told that the Britons called those *senators* whom the Saxons called afterwards *aldermen* and *borough-masters*; though not for their age, but their wisdom; for some of them were young men, but very well skilled in the laws. Kenulph king of the Mercians granted a charter, which ran thus, viz. *Consilio et consensu episcoporum et senatorum gentis sue largitus fuit dicto monasterio, &c.*

In Scotland, the lords of session are called *senators* of the college of justice.

SENATUS AUCTORITAS. See the next article.

*SENATUS-Consultum*, which made part of the Roman law. When any public matter was introduced into the senate, which was always called *referre ad senatum*, any senator whose opinion was asked, was permitted to speak upon it as long as he pleased, and on that account it was often usual for the senators to protract their speeches till it was too late to determine. When the question was put, they passed to the side of that speaker whose opinion they approved, and a majority of votes was easily collected, without the trouble

Seneca.

of counting the numbers. When the majority was known, the matter was determined, and a *senatus consultum* was immediately written by the clerks of the house, at the feet of the chief magistrates, and it was signed by all the principal members of the house. When there was not a sufficient number of members to make a senate, the decision was called *senatus auctoritas*, but it was of no force if it did not afterwards pass into a *senatus consultum*.

The *senatus consulta* were at first left in the custody of the kings, and afterward of the consuls, who could suppress or preserve them; but about the year of Rome 304, they were always deposited in the temple of Ceres, and afterwards in the treasury, by the ediles of the people.

SENECA (Lucius Annæus), a Stoic philosopher, was born at Corduba in Spain, about the beginning of the Christian era, of an Equestrian family, which had probably been transplanted thither in a colony from Rome. He was the second son of Marcus Annæus Seneca, commonly called the *rhetorician*, whose remains are printed under the title of *Suaſoria & Controversiæ, cum Declamationum Excerptis*; and his youngest brother Annæus Mela (for there were three of them) had the honour of being father to the poet Lucan. He was removed to Rome, together with his father and the rest of his family, while he was yet in his infancy. There he was educated in the most liberal manner, and under the best masters. He learned eloquence from his father; but his genius rather leading him to philosophy, he put himself under the stoics Attalus, Sotion, and Papirius Fabianus; men famous in their way, and of whom he has made honourable mention in his writings. It is probable, too, that he travelled when he was young, since we find him, in several parts of his works, particularly in his *Quæstiones Naturales*, making very exact and curious observations upon Egypt and the Nile.— But this, though entirely agreeable to his own humour, did not at all correspond with that scheme or plan of life which his father had drawn out for him; who therefore forced him to the bar, and put him upon soliciting for public employments; so that he afterwards became quæstor, prætor, and, as Lipsius will have it, even consul.

In the first year of the reign of Claudius, when Julia the daughter of Germanicus was accused of adultery by Messalina, and banished, Seneca was banished too, being charged as one of the adulterers. Cortica was the seat of his exile, where he lived eight years; “happy in the midst of those things which usually make other people miserable; *inter eas res beatus, quæ solent miseris facere*.” and where he wrote his books of consolation, addressed to his mother Helvia, and to his friend Polybius, and perhaps some of those tragedies which go under his name; for he says, *modo se levioribus studiis ibi oblectasse*. Agrippina being married to Claudius, upon the death of Messalina, she prevailed with the emperor to recall Seneca from banishment; and afterwards procured him to be tutor to her son Nero, whom she designed for the empire. Africanus Burrhus, a prætorian præfect, was joined with him in this important charge: and these two preceptors, who were entrusted with equal authority, had each his respective department. By the bounty and generosity of his royal pupil, Seneca ac-

quired that prodigious wealth which rendered him in a manner equal to kings. His houses and walks were the most magnificent in Rome. His villas were innumerable: and he had immense sums of money placed out at interest in almost every part of the world. The historian Dio reports him to have had 250,000 l. Sterling at interest in Britain alone; and reckons his calling it in all at a sum, as one of the causes of a war with that nation.

All this wealth, however, together with the luxury and effeminacy of a court, does not appear to have had any ill effect upon the temper and disposition of Seneca. He continued abstemious, exact in his manners, and, above all, free from the vices so commonly prevalent in such places, flattery and ambition. “I had rather (said he to Nero) offend you by speaking the truth, than please you by lying and flattery *maluerim veris offendere, quam placere adulando*.” How well he acquitted himself in quality of preceptor to his prince, may be known from the five first years of Nero’s reign, which have always been considered as a perfect pattern of good government; and if that emperor had but been as observant of his master through the whole course of it, as he was at the beginning, he would have been the delight, and not, as he afterwards proved, the curse and detestation of mankind. But when Poppæa and Tigellinus had got the command of his humour, and hurried him into the most extravagant and abominable vices, he soon grew weary of his master, whose life must indeed have been a constant rebuke to him. Seneca, perceiving that his favour declined at court, and that he had many accusers about the prince, who were perpetually whispering in his ear the great riches of Seneca, his magnificent houses and fine gardens, and what a favourite through means of these he was grown with the people, made an offer of them all to Nero. Nero refused to accept them: which, however, did not hinder Seneca from changing his way of life; for, as Tacitus relates, he “kept no more levees, declined the usual civilities which had been paid to him, and, under a pretence of indisposition, or some engagement or other, avoided as much as possible appearing in public.”

Nero, in the mean time, who, as it is supposed, had dispatched Burrhus by poison, could not be easy till he had rid himself of Seneca also: For Burrhus was the manager of his military concerns, and Seneca conducted his civil affairs. Accordingly, he attempted, by means of Cleonicus, a freedman of Seneca, to take him off by poison; but this not succeeding, he ordered him to be put to death, upon an information that he was privy to Piso’s conspiracy against his person. Not that he had any real proof of Seneca’s being at all concerned in this plot, but only that he was glad to lay hold of any pretence for destroying him.— He left Seneca, however, at liberty to choose his manner of dying; who caused his veins to be opened immediately. His wife Paulina, who was very young in comparison of himself, had yet the resolution and affection to bear him company, and thereupon ordered her veins to be opened at the same time; but as Nero was not willing to make his cruelty more odious and insupportable than there seemed occasion for, he gave orders to have her death prevented: upon which her wounds were bound up, and the blood stopped, in just time enough to save her; tho’, as Tacitus says, she looked so miser-

Seneca,  
Senecio,

ably pale and wan all her life after, that it was easy to read the loss of her blood and spirits in her countenance. In the mean time, Seneca, finding his death slow and lingering, desired Statius Annæus his physician to give him a dose of poison, which had been prepared some time before in case it should be wanted; but this not having its usual effect, he was carried to a hot bath, where he was at length stifled with the steams. He died, as Lipsius conjectures, in the 63d or 64th year of his age, and in about the 10th or 11th of Nero's reign. Tacitus, on mentioning his death, observes, that, as he entered the bath, he took of the water, and with it sprinkled some of his nearest domestics, saying, "That he offered those libations to Jupiter the Deliverer." These words are an evident proof that Seneca was not a Christian, as some have imagined him to have been; and that the 13 epistles from Seneca to St Paul, and from St Paul to Seneca, are supposititious pieces. His philosophical works are well known.—They consist of 124 epistles and distinct treatises; and, except his books of physical questions, are chiefly of the moral kind, treating of anger, consolation, providence, tranquillity of mind, constancy, clemency, the shortness of life, a happy life, retirement, benefits. He has been justly censured by Quintilian and other critics, as one of the first corrupters of the Roman style; but his works are highly valuable, on account of the vast erudition which they discover, and the beautiful moral sentiments which they contain.

SENECIO, GROUNDSEL, in botany: A genus belonging to the class of syngenesia, and to the order of polygamia superflua; and in the natural classification ranked under the 49th order, *Compositæ*. The receptacle is naked; the pappus simple; the calyx cylindrical and calyculated. The scales are equal and contiguous, so as to seem entire; those at the base are few, and have their apices or points decayed. There are 57 species. Of these, seven are British, the *vulgaris*, *viscosus*, *sylvaticus*, *erucifolius*, *jacobæa*, *paludosus*, and *saracenicus*.

1. The *vulgaris*, or common groundsel, has its corollæ naked, its leaves sessile, smooth, and sinuated, their segments short, broad, and minutely serrated; the flowers are yellow, and without radii. This weed grows in cultivated ground everywhere, and flowers in May. Its leaves have been used in medicine externally as a vulnerary and refrigerant, and internally as a mild emetic; but they have little or no efficacy. 2. The *viscosus*, or cotton groundsel, has its corollæ revolute, its leaves pinnatifid, viscid, and downy. The scales of the calyx are lax and hairy, and are of the same length with the perianthium. 3. The *sylvaticus*, or mountain groundsel, has its corollæ revolute, its leaves pinnatifid and dentated, the stem comyrbous and erect. It flowers in July, and is frequent in woods and heaths. 4. The *erucifolius*, hoary perennial ragwort; the corollæ are radiant; the leaves are pinnatifid, dentated, and downy beneath; the stem is erect, and two feet high; the flowers are yellow, and grow in clusters. This plant is frequent in woods and hedges. 5. The *jacobæa*, common ragwort; the corollæ are radiant; the leaves pinnated and lyre-shaped, and of a dark-green colour; the stalk is erect, round, and generally purplish; the flowers grow in clusters on the tops of the stalks. The leaves have a bitterish subærid taste, and extremely nauseous. Si-

VOL. XVII. Part I.

mon Paulli says, that a decoction of them cured many soldiers of an epidemic dysentery. 6. The *paludosus*, marsh ragwort; the corollæ are radiant; the leaves sword-shaped, acutely serrated, and somewhat downy underneath; the stem is erect, branched towards the top, and four or five feet high; the flowers are large and yellow. This plant is frequent in fens and ditches in England. 7. The *saracenicus*, broad-leaved ragwort; the corollæ are radiant; the leaves are lanceolated, serrated, and somewhat smooth; the stem is erect, simple, and four or five feet high; there are several flowers on each footstalk, which are yellow, and grow in clusters on the top. The plant grows in moist pastures in England; and flowers in July or August.

SENEGAL, a part of Negroland in Africa, the boundaries of which are not known. See GUINEA.

*Isle of SENEGAL*, sometimes called *Saint Louis*, is a small island in the mouth of the river Senegal, and according to Maskelyne's tables is situated in N. Lat. 15. 53. W. Long. 16. 31. The Dutch were the first Europeans who settled at Senegal; but their colony was expelled by the French in 1687. It was taken by the English in 1692; and retaken by the French the year following. It was a second time taken possession of by the English in 1758; but in 1779 the French recovered it, and it was ceded by the British crown by the treaty of 1783.

The best account of this island which we have seen, is given in the interesting voyage of M. Saignier to the coast of Africa. This adventurer visited Senegal in June 1785.

"The island (says he), properly speaking, is only a bank of sand in the middle of the river. It is 1000 geometrical paces long, and about 60 in its greatest width; is almost on a level with the river and with the sea, being defended from the latter by Barbary point, which is of greater elevation than the colony. The eastern branch of the river is the more considerable of the two, being about 400 toises across; the western branch is only from 50 to 200 toises wide. The isle consists entirely of burning sands, on the barren surface of which you sometimes meet with scattered flints, thrown out among their ballast by vessels coming from Goree, or with the ruins of buildings formerly erected by Europeans. There is scarcely such a thing as a garden upon the island; European seeds in general not thriving here. It is not surprising that the soil is so unproductive; for the air is strongly impregnated with sea salt, which pervades every thing, and consumes even iron in a very short space of time. The heats are excessive, and rendered still more insupportable by the reflection of the sand; so that from ten in the morning until four in the afternoon it is almost impossible to do any work. During the months of January, February, March, and April, the heats are moderated; but in August and the following months they become so oppressive as even to affect the natives themselves. What effect then must they have upon the Europeans, suddenly transported into this burning climate? The nights are a little less sultry: not always, however, but only when the sea-breeze sets in. It is then that the inhabitants of the colony breathe a fresher air, for which they have been longing the whole of the day; but this air in our climate would seem a burning vapour. The nights are nevertheless troublesome, notwithstanding the comforts of the

L I

Senegal.

Senegal. sea breeze. The instant the fan is set, we are assailed by an infinity of gnats, which are called *musquitos*; their stings are very painful, and their multitudes incredible. The inhabitants find but a poor defence in their gauze-curtains. For my own part, accustomed as I had been to live among the Moors, I was but little annoyed by these insects. Being half a savage, I felt no desire to recommend myself to the favourable regard of the fair sex, and I was therefore under no necessity of taking care of my person. In imitation of my former masters, I smeared myself with butter, and this expedient preserved me at all times from these impertinent stingers, these spiteful enemies to the repose of the human kind.

“ If the prospect of Senegal is not agreeable to the eye, much less are its environs, which are covered over only with sand, and over-run with mangles. It may be said, without exaggeration, that there is not a more forsaken situation to be found on the face of the inhabited globe, or a place in which the common necessities of life are procured with greater difficulties. Water, that indispensable aliment of man, is here not potable. Wells are dug in the sand to the depth of five or six feet, and water is obtained by these means; but whatever pains are taken to freshen it, it ever retains a brackish taste. I have distilled this water myself, and observed that it always had a disagreeable flavour, which cannot fail to be hurtful to the health: it is true, that when the river is high, its streams are fresh, but the water is only the more dangerous. It proves the cause of most of those maladies which carry off the Europeans so rapidly, that at the end of every three years the colony has a fresh set of inhabitants. The blacks themselves, although accustomed to the climate, are not in this season free from disease.”

The fort of St Louis is a quadrangle, and has two bastions of considerable strength; but the greatest security of the fort is its natural situation. The cannon of the fort are numerous, and the arsenal well supplied with small arms and stores. Besides this fort the French had no other upon the river, except Fort St Joseph, which stands about four leagues below the cataract at Govina, though they had a few factories in different parts.

The principal commodity of this country is that of gum Senegal (see *Gum-Senegal*), which is a valuable branch of commerce, as it is used in many arts and manufactures, particularly by the painters in water-colours, the silk weavers, and dyers.

The French import from the river Senegal not only gum-arabic, but elephants teeth, hides, bees-wax, gold-dust, cotton, ostrich feathers, ambergris, indigo, and civet.

Notwithstanding the barrenness of the spot, Senegal contains more than 6000 negroes, including the captives of the Tapades, or negroes born of the black inhabitants of the country. They are never put up to sale, unless convicted of some crime. Their huts, constructed in the form of bee-hives, and supported upon four stakes, surround the habitations of the negro inhabitants. The entire height of those huts may rise to about 12 feet, the width in every direction is commonly from 10 to 12. The beds are composed of hurdles laid upon cross-bars, supported by forked stakes at the height of about a foot from the ground. Here the slaves

Senegal. sleep promiscuously, men, women, girls, and boys. A fire is made in the middle of the hut, which is filled with smoke, sufficient to stifle any man but a negro.

The men are tall, and the women are accounted the handsomest negroes of all Africa. The Senegalians may be considered as the most courageous people of that part of the world, without even excepting the Moors. Their courage, however, is more nearly allied to temerity than to bravery. In the course of the voyage to Galam, they meet the greatest dangers with gaiety and song; they dread neither musket nor cannon, and are equally fearless of the cayman or crocodile. Should one of their companions be killed, and devoured by these animals before their face, they are not deterred from plunging into the water, if the working of the ship require it. These excellent qualifications which distinguish them, and on which they value themselves so much, do not, however, preserve them from the common contagion of the country, which inclines them all to rapine. They are emulous to surpass one another in all the arts of over-reaching and fraud. The conduct of the Europeans has, no doubt, encouraged these vices as much as the lessons of the marabouts, who inculcate the duty of plundering the Christians to the utmost of their power.

The Yof negroes of Senegal are either Christians or Mahometans, or rather one and the other, or with more truth neither; religion being a matter of indifference to them. Those on the continent are of the same way of thinking, and their religious practices are kept up only for the sake of form. A bar of iron, a few beads, will make them change their opinion at will. By such means are they acted upon; a sufficient proof of their want of all religious principle. The marabouts, or priests, and the men of their law, are no better than the rest. “ I have examined the character of several of this order of men (says M. Saugnier), and even among the nation of the Poules, who are considered as great fanatics, I discovered that they were only publicly attached to their opinions. ‘ This white man (say they) does so; he is better informed than I, and why should not I imitate his example?’ This way of reasoning is common to all that tract of country.”

The colony of Senegal is surrounded with islands, which, on account of the proximity of the sea, are all more unhealthy than that on which the town is built. They are full of standing pools, that, when dried up by the sun, exhale a putrid vapour that carries mortality with it, and desolates these islands. It is doubtless the same cause that takes off so many of the French at Senegal during the dangerous season of the year. This also may be in part occasioned by the bad quality of the water, which flows from the ponds in the neighbourhood of the colony, and though incorporated with that of the river, comes down little agitated by the current, and is easily distinguished by a vapidness of taste. This particular is, in my opinion, essentially worthy of notice, and if properly attended to by our medical men, might become the means of preserving many lives.

SENEGAL-RIVER, see NIGER. As so little is known respecting this river, which is one of the greatest in Africa, any additional information must be interesting. We shall therefore present our readers with the account contained in the communications presented to the Association

Senegal, Seneka. tion for promoting the discovery of the Interior Parts of Africa, which, as far as we know, is the latest and most authentic.

The river known to Europeans by the name of *Niger* or *Senegal* runs on the south of the kingdom of *Cahna*, in its course towards *Tombuctou*; and if the report which *Ben Alli* heard in that town may be credited, it is afterwards lost in the sands on the south of the country of *Tombuctou*. In the map (A), only the known part of its course is marked by a line; and the supposititious part by dots. It may be proper to observe, that the Africans have two names for this river; that is, *Neel il Aheed*, or river of the Negroes; and *Neel il Kibeer*, or the great river. They also term the Nile (that is the Egyptian river) *Neel Shem*; so that the term *Neel*, from whence our Nile, is nothing more than the appellation of river; like *Ganges*, or *Sinde*.

Of this river the rise and termination are unknown, but the course is from east to west. So great is its rapidity, that no vessel can ascend its stream; and such is the want of skill, or such the absence of commercial inducements among the nations who inhabit its borders, that even with the current, neither vessels nor boats are seen to navigate. In one place, indeed, the traveller finds accommodations for the passage of himself and of his goods; but even there, tho' the ferrymen, by the indulgence of the sultan of *Cahna*, are exempted from all taxes, the boat which conveys the merchandise is nothing more than an ill-constructed raft; for the planks are fastened to the timbers with ropes, and the seams are closed both within and without by a plaster of tough clay, of which a large provision is always carried on the raft, for the purpose of excluding the stream wherever its entrance is observed.

The depth of the river at the place of passage, which is more than a hundred miles to the south of the city of *Cahna*, the capital of the empire of that name, is estimated at 23 or 24 feet English. Its depth is from 10 to 12 pecks, each of which is 27 inches.

Its width is such, that even at the island of *Gongoo*, where the ferrymen reside, the sound of the loudest voice from the northern shore is scarcely heard; and at *Tombuctou*, where the name of *Gnewa*, or black, is given to the stream, the width is described as being that of the *Thames* at *Westminster*. In the rainy season it swells above its banks, and not only floods the adjacent lands, but often sweeps before it the cattle and cottages of the short-sighted or too confident inhabitants.

That the people who live in the neighbourhood of the *Niger* should refuse to profit by its navigation, may justly surprize the traveller: but much greater is his astonishment, when he finds that even the food which the bounty of the stream would give, is uselessly offered to their acceptance; for such is the want of skill, or such the settled dislike of the people to this sort of provision, that the fish with which the river abounds are left in undisturbed possession of its waters.

SENEKA, or SENEGA, *Rattlesnake-root*, *Milk-wort*, a medicinal plant. See POLYGALA.

SENESCHAL, (*Seneschallus*), derived from the German *sein* "a house or place," and *scale* "an officer," is a steward, and signifies one who has the dispensing of justice in some particular cases: As the high seneschal or steward of England; *seneschal de la hotel de roi*, "steward of the king's household, seneschal, or steward of courts, &c." *Co. Lit. 61. Croke's Jurisil. 102. Kitch 83.* See STEWARD.

SENNA, the leaf of the *castia fenna* of *Linnaeus*. See CASSIA.

*Senna* appears to have been cultivated in England in the time of *Parkinson* (1640); and *Miller* tells us, that by keeping these plants in a hot-bed all the summer, he frequently had them in flower; but adds, it is very rarely that they perfect their seeds in England. There can be little doubt, however, but that some of the British possessions may be found well enough adapted to the growth of this vegetable, and that the patriotic views of the Society for encouraging Arts, &c. which has offered a reward to those who succeed in the attempt, will be ultimately accomplished.

*Senna*, which is in common use as a purgative, was first known to the Arabian physicians *Serapion* and *Mesue*: the first among the Greeks who takes any notice of it is *Aetnarius*, but he only speaks of the fruit, and not of the leaves. To remove the disagreeable taste of this medicine, *Dr Cullen* recommends *coriander seeds*; and, for preventing the gripings with which it is sometimes attended, he thinks the warmer aromatics, as *cardamoms* or *ginger*, would be more effectual.

The *Senna Indica*, or blunt-leaved *senna*, is a variety of the *Alexandrian* species; which, by its cultivation in the south of France (*Provence*), has been found to assume this change. It is less purgative than the pointed-leaved *senna*, and is therefore to be given in larger doses. It was employed as a cathartic by *Dr Wright* at *Jamaica*, where it grows on the sand-banks near the sea.

SENNAAR, a country of Africa, bordering upon *Abyssinia*, with the title of a kingdom; the present government of which was established in the 16th century by a race of negroes named, in their own language, *Shillook*. This country, together with all the northern parts of Africa, had been over-run by the *Saracens* during the rapid conquests of the *khalifs*; but instead of erecting any distinct principalities here, as in other parts, they had incorporated themselves with the old inhabitants called *Shepherds*, whom they found at their arrival; had converted them to their religion, and become one people with them. In 1504 the *Shillook*, a people before unknown, came from the western banks of the river *Bahiar el Abiad*, which empties itself into the Nile, and conquered the country; allowing the Arabs, however, to retain their possessions on condition of paying them a certain tribute. These founded the city of *Sennaar*, and have ever since continued to carry on an intercourse with *Egypt* in the way of merchandize. At the establishment of their monarchy the whole nation were Pagans, but soon after became converts to *Mohammedanism*, and took the name of *Funge*, an appellation signifying "lords or conquerors," and like

(A) The map alluded to is that which accompanies the volume which contains the proceedings of the Associations. This work was printed in 1791.

*Sennaar.* wife free citizens. Mr Bruce, who passed through this country in his return from Abyssinia, gives a list of 20 kings who have reigned in it since the conquest of the Shillook.

*Bruce's  
Travels,  
vol. 4.*

This country is inhabited by a people so barbarous and brutish, that no history of them can be expected. One of the most remarkable of their customs is, that the king ascends the throne with the expectation of being murdered whenever the general council of the nation thinks proper. The dreadful office of executioner belongs to one single officer, styled, in the language of the country, *Sid el Coom*; and who is always a relation of the monarch himself. It was from his registers that Mr Bruce took the list of the kings already mentioned, with the number of years they reigned, and which may therefore be received as authentic. The *Sid el Coom* in office at the time that Mr Bruce visited this country was named Achmet, and was one of his best friends. He had murdered the late king, with three of his sons, one of whom was an infant at its mother's breast; he was also in daily expectation of performing the same office to the reigning sovereign. He was by no means reserved concerning the nature of his office, but answered freely every question that was put to him. When asked by Mr Bruce why he murdered the king's young son in his father's presence? he answered, that he did it from a principle of duty to the king himself, who had a right to see his son killed in a lawful and regular manner, which was by cutting his throat with a sword, and not in a more painful or ignominious way, which the malice of his enemies might possibly have inflicted.

The king, he said, was very little concerned at the sight of his son's death, but he was to very unwilling to die himself, that he often pressed the executioner to let him escape; but finding his intreaties ineffectual, he submitted at last without resistance. On being asked, whether he was not afraid of coming into the presence of the king, considering the office he might possibly have to perform? he replied, that he was not in the least afraid on this account; that it was his duty to be with the king every morning, and very late in the evening; that the king knew he would have no hand in promoting his death; but that, when the matter was absolutely determined, the rest was only an affair of decency; and it would undoubtedly be his own choice, rather to fall by the hand of his own relation in private than by a hired assassin, an Arab, or a Christian slave, in the sight of the populace. Eaady the king's father, having the misfortune to be taken prisoner, was sent to Atbara to Welled Hassan the governor of that province to be put to death there. But the king, who was a strong man, and always armed, kept so much upon his guard, that Welled could find no opportunity of killing him but by running him through the back with a lance as he was washing his hands. For this Welled himself was afterwards put to death; not on account of the murder itself, but because, in the first place, he, who was not the proper executioner, had presumed to put the king to death; and, in the next, because he had done it with a lance, whereas the only lawful instrument was a sword.

On the death of any of the sovereigns of this country, his eldest son succeeds to the throne of course; on which as many of his brothers as can be found are ap-

prehended, and put to death by the *Sid el Coom* in the manner already related. Women are excluded from the sovereignty here as well as in Abyssinia. The princesses of Sennaar, however, are worse off than those of Abyssinia, having no settled income, nor being treated in any degree better than the daughters of private persons. The king is obliged, once in his lifetime, to plough and sow a piece of ground; whence he is named *Baady*, the "countryman or peasant;" a title as common among the monarchs of Sennaar as *Cesar* was among the Romans. The royal family were originally negroes; but as the kings frequently marry Arab women, the white colour of the mother is communicated to the child. This, we are told by Mr Bruce, is invariably the case when a negro man of Sennaar marries an Arab woman; and it holds equally good when an Arab man marries a negro woman; and he likewise informs us, that he never saw one black Arab all the time he was at Sennaar.

The soil and climate of this country is extremely unfavourable both to man and beast. The men are strong and remarkable for their size, but short lived; and there is such a mortality among the children, that were it not for a constant importation of slaves, the metropolis would be depopulated. The shortness of their lives, however, may perhaps be accounted for, from their indulging themselves from their infancy in every kind of excess. No horse, mule, nor ass, will live at Sennaar or for many miles round it. The case is the same with bullocks, sheep, dogs, cats, and poultry; all of them must go to the sands every half-year. It is difficult to account for this mortality; though Mr Bruce assures us it is the case everywhere about the metropolis of this country, where the soil is a fat earth during the first season of the rains. Two greyhounds which he brought along with him from Atbara, and the mules he brought from Abyssinia, lived only a few weeks after their arrival at Sennaar. Several of the kings of Sennaar have tried to keep lions, but it was always found impossible to preserve them alive after the rains. They will live, however, as well as other quadrupeds, in the sands, at no great distance from the capital. — No species of tree except the lemon flowers near this city; the cultivation of the rose has often been attempted, but always without success. In other respects, however, the soil of Sennaar is exceedingly fertile, being said to yield 300 fold; but this is thought by Mr Bruce to be a great exaggeration. It is all sown with dora or millet, which is the principal food of the people; wheat and rice are also produced here, which are sold by the pound, even in years of plenty. The soil all round is strongly impregnated with salt, so that a sufficient quantity to serve the inhabitants is extracted from it.

SENNAAR, a city of Africa, the capital of the kingdom of that name. It stands, according to Mr Bruce's observations, in N. Lat. 13° 34' 36" E. Long. 33° 30' 30" on the western side of the Nile, and close upon the banks of it; the ground on which it stands being just high enough to prevent the inundation. The town is very populous, and contains a great many houses. In Poncet's time they were all of one story; but now most of the officers have houses of two stories high. They are built of clay mixed with a very little straw, and have all flat roofs; which shows that the rains here  
must



Sennaar. must be much less in quantity than to the southward. During the time of Mr Bruce's residence here, however, there was one week of continual rain, and the Nile, after loud thunder and great darknels to the south, increased violently; the whole stream being covered with the wrecks of houses and their furniture; so that he supposed it had destroyed many villages to the southward. About 12 miles to the north-west of Sennaar is a collection of villages named *Shaddly*, from a great faint of that name, who constructed several granaries here. These are no other than large pits dug in the ground, and well plastered in the inside with clay, then filled with grain when it is at its lowest price, and afterwards covered up and plastered again at top: these pits they call *matamores*. On any prospect of death they are opened, and the corn sold to the people. About 24 miles north of Shaddly there is another set of granaries named *Wed-Aboud*, still greater than Shaddly; and upon these two the subsistence of the Arabs principally depends: for as these people are at continual war with each other, and direct their fury rather against the crops than the persons of their enemies, the whole of them would be unavoidably starved, were it not for this extraordinary resource. Small villages of soldiers are scattered up and down this country to guard the grain after it is sown, which is only that species of millet named *Dora*; the soil, it is said, being incapable of producing any other. There are great hollows made in the earth at proper distances throughout the country, which fill with water in the rainy season, and are afterwards of great use to the Arabs as they pass from the cultivated parts to the sands. The fly, which is such a dreadful enemy to the cattle, is never seen to the northward of Shaddly.

To the westward of these granaries the country is quite full of trees as far as the river Abiad, or El-aice. In this extensive plain there arise two ridges of mountains, one called *Jibbel Moira*, or the *Mountain of water*; the other *Jibbel Segud*, or the *Cold Mountain*. Both of them enjoy a fine climate, and serve for a protection to the farms about Shaddly and Aboud already mentioned. Here also are fortresses placed in the way of the Arabs, which serve to oblige them to pay tribute in their flight from the cultivated country, during the rains, to the dry lands of Atbara. Each of these districts is governed by the descendant of their ancient and native princes, who long resisted all the power of the Arabs. Sacrifices of a horrid nature are said to have been offered up on these mountains till about the year 1554, when one of the kings of Sennaar besieged first one and then the other of the princes in their mountains; and having forced them to surrender, he fastened a chain of gold to each of their ears, exposed them in the market-place at Sennaar, and sold them for slaves at less than a farthing each. Soon after this they were circumcised, converted to the Mahometan religion, and restored to their kingdoms.

Nothing (says Mr Bruce) is more pleasant than the country around Sennaar in the end of August and beginning of September. The grain, being now sprung up, makes the whole of this immense plain appear a level green land, interspersed with great lakes of water, and ornamented at certain intervals with groups of villages; the conical tops of the houses presenting at a distance the appearance of small encampments. Through

this very extensive plain winds the Nile, a delightful river there, above a mile broad, full to the very brim, but never overflowing. Everywhere on these banks are seen herds of the most beautiful cattle of various kinds. The banks of the Nile about Sennaar resemble the pleasanter part of Holland in the summer season; but soon after, when the rains cease, and the sun exerts its utmost influence, the dora begins to ripen, the leaves to turn yellow and to rot, the lakes to putrefy, smell, become full of vermin, and all its beauty suddenly disappears: bare scorched Nubia returns, and all its terrors of poisonous winds and moving sands, glowing and ventilated with sultry blasts, which are followed by a troop of terrible attendants; epilepsies, apoplexies, violent fevers, obstinate agues, and lingering painful dysenteries, still more obstinate and mortal.

War and treason seem to be the only employment of this horrid people, whom Heaven has separated by almost impassable deserts from the rest of mankind; confining them to an accursed spot, seemingly to give them an earnest in time of the only other course which he has reserved to them for an eternal hereafter."

With regard to the climate of the country round Sennaar, Mr Bruce has several very curious observations. The thermometer rises in the shade to 119 degrees; but the degree indicated by this instrument does not at all correspond with the sensations occasioned by it; nor with the colour of the people who live under it. "Nations of blacks (says he) live within latitude 13 and 14 degrees; about 10 degrees south of them, nearly under the line, all the people are white, as we had an opportunity of observing daily in the Galla Sennaar, which is in latitude 13 degrees, is hotter by the thermometer 50 degrees, when the sun is most distant from it, than Gondar, which is a degree farther south, when the sun is vertical.—Cold and hot (says our author) are terms merely relative, not determined by the latitude, but elevation of the place. When, therefore, we say *hot*, some other explanation is necessary concerning the place where we are, in order to give an adequate idea of the sensations of that heat upon the body, and the effects of it upon the lungs. The degree of the thermometer conveys this but very imperfectly; 90 degrees is excessively hot at Loheia in Arabia Felix; and yet the latitude of Loheia is but 15 degrees; whereas 90 degrees at Sennaar is only warm as to sense; though Sennaar, as we have already said, is in latitude 13 degrees.

"At Sennaar, then, I call it *cold*, when one fully clothed and at rest feels himself in want of fire. I call it *cool*, when one fully clothed and at rest feels he could bear more covering all over, or in part, than he has at that time. I call it *temperate*, when a man so clothed, and at rest, feels no such want, and can take moderate exercise, such as walking about a room without sweating. I call it *warm*, when a man, so clothed, does not sweat when at rest; but, upon taking moderate exercise, sweats, and again cools. I call it *hot*, when a man at rest, or with moderate exercise, sweats excessively. I call it *very hot*, when a man with thin, or little clothing, sweats much, though at rest. I call it *excessive hot*, when a man, in his shirt and at rest, sweats excessively, when all motion is painful, and the knees feel feeble, as if after a fever. I call it *extreme hot*, when the strength fails, a disposition to faint comes on, a straitness is found

Sennaar

**Sennaar.** in the temples, as if a small cord was drawn tight about the head, the voice impaired, the skin dry, and the head seems more than ordinarily large and light. This, I apprehend, denotes death at hand; but this is rarely or never effected by the sun alone, without the addition of that poisonous wind which pursued us through Atbara, where it has, no doubt, contributed to the total extinction of every thing that hath the breath of life. A thermometer, graduated upon this scale, would exhibit a figure very different from the common one; for I am convinced by experiment, that a web of the finest muslin, wrapt round the body at Sennaar, will occasion at mid-day a greater sensation of heat in the body, than a rise of 5 degrees in the thermometer of Fahrenheit.

“At Sennaar, from 70 to 78 degrees of Fahrenheit’s thermometer is cool; from 79 to 92 temperate; at 92 degrees begins warmth. Although the degree of the thermometer marks a greater heat than is felt by the body of us strangers, it seems to me that the sensations of the natives bear still a less proportion to that degree than ours. On the 2d of August, while I was lying perfectly enervated on a carpet in a room deluged with water at 12 o’clock, the thermometer at 116, I saw several black labourers pulling down a house, working with great vigour, without any symptoms of being incommoded.”

The dress of the people of Sennaar consists only of a long shirt of blue cloth, which wraps them up from the under part of the neck to the feet. It does not, however, conceal the neck in the men, though it does in the women. The men sometimes have a sash tied about their middle; and both men and women go bare-footed in the houses, whatever their rank may be. The floors of their apartments, especially those of the women, are covered with Persian carpets. Both men and women anoint themselves, at least once a-day, with camel’s grease mixed with civet, which, they imagine, softens their skins, and preserves them from cutaneous eruptions; of which they are so fearful, that they confine themselves to the house if they observe the smallest pimple on their skins. With the same view of preserving their skins, though they have a clean shirt every day, they sleep with a greased one at night, having no other covering but this. Their bed is a tanned bull’s hide, which this constant greasing softens very much; it is also very cool, though it gives a smell to their bodies from which they cannot be freed by any washing.

Our author gives a very curious description of the queens and ladies of the court at Sennaar. He had access to them as a physician, and was permitted to pay his visit alone. He was first shown into a large square apartment, where there were about 50 black women, all quite naked excepting a very narrow piece of cotton rag about their waists. As he was musing whether these were all queens, one of them took him by the hand, and led him into another apartment much better lighted than the former. Here he saw three women sitting upon a bench or sofa covered with blue Surat cloth; they themselves being clothed from the neck to the feet with cotton shirts of the same colour. These were three of the king’s wives; his favourite, who was one of the number, appeared to be about six feet high, and so corpulent that our traveller imagined her to be the largest creature he had seen next to the elephant

and rhinoceros. Her features perfectly resembled those of a negro: a ring of gold passed through her under lip, and weighed it down, till, like a flap, it covered her chin, leaving her teeth bare, which were small and very fine. The inside of her lip was made black with antimony. Her ears reached down to her shoulders, and had the appearance of wings: there was a gold ring in each of them about five inches in diameter, and somewhat smaller than a man’s little finger; the weight of which had drawn down the hole where her ear was pierced so much that three fingers might easily pass above the ring. She had a gold necklace like that called *Esclavage*, of several rows, one below another; to which were hung rows of sequins pierced. She had two manacles of gold upon her ancles larger than those used for chaining felons. Our author could not imagine how it was possible for her to walk with them, till he was informed that they were hollow. The others were dressed much in the same manner; only there was one who had chains coming from her ears to the outside of each nostril, where they were fastened. A ring was also put through the grille of her nose, and which hung down to the opening of her mouth; having all together something of the appearance of a horse’s bridle; and Mr Bruce thinks that she must have breathed with difficulty.

The poorer sort of the people of Sennar live upon the flour or bread of millet; the rich make puddings of this, toasting the flour before the fire, and putting milk and butter into it; besides which they use beef partly roasted and partly raw. They have very fine and fat horned cattle, but the meat commonly sold in the market is camel’s flesh. The liver and spare ribs of this animal are always eaten raw; nor did our author see one instance to the contrary all the time he was in the country. Hog’s flesh is not sold in the market; but all the common people of Sennaar eat it openly; those in office, who pretend to be Mahometans, doing the same in secret.

There are no manufactures in this country, and the principal article of trade is blue Surat cloth. In former times, when caravans could pass with safety, Indian goods were brought in quantities from Jidda to Sennaar, and then dispersed over the country of the blacks. The returns were made in gold, a powder called *Tilbar*, civet, rhinoceroses horns, ivory, ostrich feathers, and above all slaves or glass, more of these being exported from Sennaar than from all the East of Africa. This trade, however, as well as that of the gold and ivory, is almost destroyed; though the gold is still reputed to be the best and purest in Africa, and is therefore bought at Mocha to be carried to India, where it all centres at last.

SENNERTUS (Daniel), an eminent physician, was born in 1572 at Breslaw; and in 1593 he was sent to Wittemberg, where he made great progress in philosophy and physic. He visited the universities of Leipzig, Jena, Francfort upon the Oder, and Berlin; but soon returned to Wittemberg, where he was promoted to the degree of doctor of physic, and soon after to a professorship in the same faculty. He was the first who introduced the study of chemistry into that university; he gained a great reputation by his works and practice, and was very generous to the poor. He died of the plague at Wittemberg, in 1637. He raised himself  
enemies

enemies by contradicting the ancients. He thought the seed of all living creatures animated, and that the soul of this seed produces organization. He was accused of impiety for asserting that the souls of beasts are not material; for this was affirmed to be the same thing with asserting that they are immortal; but he rejected this consequence, as he well might do. See METAPHYSICS, Part III. chap. vi.

SENONES, (anc. geog.), a people of Gallia Celtica, situated on the Sequana to the south of the Parisii, near the confluence of the Jeanna or Yonne with the above-mentioned river. Their most considerable exploit was their invasion of Italy, and taking and burning Rome, as related under that article. This was done by a colony of them long before transported into Italy, and settled on the Adriatic. Their capital, Agendicum in Gaul, was in the lower age called *Senones*, now *Sens*. In Italy the Senones extended themselves as far as the river Aesis; but were afterwards driven beyond the Rubicon, which became the boundary of Gallia Cisalpina, (Polybius, Strabo.)

SENSATION, in philosophy, the perception of external objects by means of the senses. See METAPHYSICS, Part I. chap. i.

SENSE, a faculty of the soul whereby it perceives external objects by means of the impressions they make on certain organs of the body. See METAPHYSICS, Part I. and ANATOMY, n<sup>o</sup> 137, &c.

*Common SENSE*, is a term that has been variously used both by ancient and modern writers. With some it has been synonymous with public sense; with others it has denoted prudence; in certain instances, it has been confounded with some of the powers of taste; and, accordingly, those who commit egregious blunders with regard to decorum, saying and doing what is offensive to their company, and inconsistent with their own character, have been charged with a defect in common sense. Some men are distinguished by an uncommon acuteness in discovering the characters of others; and this talent has been sometimes called *common sense*; similar to which is that use of the term, which makes it to signify that experience and knowledge of life which is acquired by living in society. To this meaning Quintilian refers, speaking of the advantages of a public education: *Sensum ipsum qui communis dicitur, ubi discit, cum se a congressu, qui non hominibus solum, sed mutis quoque animalibus naturalis est, segregari?* Lib. i. cap. 2.

But the term *common sense* hath in modern times been used to signify that power or the mind which perceives truth, or commands belief, not by progressive argumentation, but by an instantaneous, instinctive, and irresistible impulse; derived neither from education nor from habit, but from nature; acting independently of our will, whenever its object is presented, according to an established law, and therefore called *sense*; and acting in a similar manner upon all, or at least upon a great majority of mankind, and therefore called *common sense*. See METAPHYSICS, n<sup>o</sup> 127.

*Moral SENSE*, is a determination of the mind to be pleased with the contemplation of those affections, actions, or characters, of rational agents, which we call *good* or *virtuous*.

This moral sense of beauty in actions and affections

may appear strange at first view: some of our moralists themselves are offended at it in Lord Shaftesbury, as being accustomed to deduce every approbation or aversion from rational views of interest. It is certain that his Lordship has carried the influence of the moral sense very far, and some of his followers have carried it farther. The advocates for the selfish system seem to drive their opinions to the opposite extreme, and we have elsewhere endeavoured to show that the truth lies between the contending parties. See MORAL PHILOSOPHY, n<sup>o</sup> 27,—32.

*Public SENSE* is defined by the noble author of the Characteristics to be an innate propensity to be pleased with the happiness of others, and to be uneasy at their misery. It is found, he says, in a greater or less degree in all men, and was sometimes called *κοινωνία*, or *sensus communis*, by ancient writers.

Of the reality of this public sense we have great doubts. The conduct of savages, who are more under the influence of original instinct than civilized men, gives no countenance to it. Their affections seem all to be selfish, or at least to spring from self-love variously modified. For the happiness of their wives they have very little regard, considering them merely as instruments of their own pleasure, and valuing them for nothing else. Hence they make them toil, while they themselves indulge in listless idleness. To their children we believe they exhibit strong symptoms of attachment, as soon as they derive assistance from them in war, or in the business of the chase; but during the helpless years of infancy, the child is left by the selfish father wholly to the care and protection of its wretched mother; who, impelled by the *storgé* of all females to their young, cherishes her offspring with great fondness.—The savage is, indeed, susceptible of strong attachments, similar to that which we call friendship; but such attachments are no proofs of disinterested benevolence, or what his Lordship calls the *public sense*. Two barbarous heroes are probably first linked together by the observation of each other's prowess in war, or their skill in pursuing their game; for such observation cannot fail to show them that they may be useful to one another; and we have elsewhere shown how real friendship may spring from attachments originally selfish. The savage is very much attached to his horde or tribe, and this attachment resembles patriotism: but patriotism itself is not a sentiment of pure benevolence delighting in the happiness of others, and grieving at their misery; for the patriot prefers his own country to all others, and is not very scrupulous with respect to the rectitude of the means by which he promotes its interest, or depresses its rivals. The savage pursues with relentless rigour the enemies of himself or of the tribe to which he belongs; shows no mercy to them when in his power, but puts them to the cruellest death, and carries their scalps to the leader of his party. These facts, which cannot be controverted, are perfectly irreconcilable with innate benevolence, or a public sense comprehending the whole race of men; and show the truth of that theory by which we have in another place endeavoured to account for all the passions, social as well as selfish. See PASSION.

SENSIBLE NOTE, in music, is that which constitutes a third major above the dominant, and a semi-

Sense,  
Sensible.

*Sensibility* tone beneath the tonic. *Si*, or *B*, is the sensible note in the tone of *ut* or *C sol* ♯; or *G* sharp, in the tone of *h* or *A*.

They call it the *sensible note* on this account, that it causes to be perceived the tone or natural series of the key and the tonic itself; upon which, after the chord of the dominant, the sensible note taking the shortest road, is under a necessity of rising; which has made some authors treat this sensible note as a major dissonance, for want of observing, that dissonance, being a relation, cannot be constituted unless by two notes between which it fulfills.

It is not meant that the sensible note is the seventh of the tone, because, in the minor mode, this seventh cannot be a sensible note but in ascending; for, in descending, it is at the distance of a full note from the tonic, and of a third minor from the dominant.

**SENSIBILITY**, is a nice and delicate perception of pleasure or pain, beauty or deformity. It is very nearly allied to taste; and, as far as it is natural, seems to depend upon the organization of the nervous system. It is capable, however, of cultivation, and is experienced in a much higher degree in civilized than in savage nations, and among persons liberally educated than among boors and illiterate mechanics. The man who has cultivated any of the fine arts has a much quicker and more exquisite perception of beauty and deformity in the execution of that art, than another of equal or even greater natural powers, who has but casually inspected its productions. He who has been long accustomed to that decorum of manners which characterizes the polite part of the world, perceives almost instantaneously the smallest deviation from it, and feels himself almost as much hurt by behaviour harmless in itself, as by the grossest rudeness; and the man who has long proceeded steadily in the paths of virtue, and often painted to himself the deformity of vice, and the miseries of which it is productive, is more quickly alarmed at any deviation from rectitude, than another who, though his life has been stained by no crime, has yet thought less upon the principles of virtue and consequences of vice.

Every thing which can be called sensibility, and is not born with man, may be resolved into association, and is to be regulated accordingly; for sensibilities may be acquired which are inimical to happiness and to the practice of virtue. The man is not to be envied who has so accustomed himself to the forms of polite address as to be hurt by the unaffected language and manners of the honest peasant, with whom he may have occasion to transact business; nor is he likely to acquire much useful knowledge who has so sedulously studied the beauties of composition as to be unable to read without disgust a book of science or of history, of which the style comes not up to his standard of perfection. That sensibility which we either have from nature, or necessarily acquire, of the miseries of others, is of the greatest use when properly regulated, as it powerfully impels us to relieve their distress; but if it by any means become so exquisite as to make us shun the sight of misery, it counteracts the end for which it was implanted in our nature, and only deprives us of happiness, while it contributes nothing to the good of others. Indeed there is reason to believe that all such extreme sensibilities are selfish affectations, employed as apologies for withholding from the miserable that relief which it is in our power

to give; for there is not a fact better established in the science of human nature, than that passive perceptions grow gradually weaker by repetition, while active habits daily acquire strength.

It is of great importance to a literary man to cultivate his taste, because it is the source of much elegant and refined pleasure, (see **TASTE**); but there is a degree of fastidiousness which renders that pleasure impossible to be obtained, and is the certain indication of expiring letters. It is necessary to submit to the artificial rules of politeness, for they tend to promote the peace and harmony of society, and are sometimes a useful substitute for moral virtue; but he who with respect to them has so much sensibility as to be disgusted with all whose manners are not equally polished with his own, is a very troublesome member of society. It is every man's duty to cultivate his moral sensibilities, so as to make them subservient to the purposes for which they were given to him; but if he either feel, or pretend to feel, the miseries of others to so exquisite a degree as to be unable to afford them the relief which they have a right to expect, his sensibilities are of no good tendency.

That the man of true sensibility has more pains and more pleasures than the callous wretch, is universally admitted, as well as that his enjoyments and sufferings are more exquisite in their kinds; and as no man lives for himself alone, no man will acknowledge his want of sensibility, or express a wish that his heart were callous. It is, however, a matter of some moment to distinguish real sensibilities from ridiculous affectations; those which tend to increase the sum of human happiness from such as have a contrary tendency, and to cultivate them all in such a manner as to make them answer the ends for which they were implanted in us by the beneficent Author of nature. This can be done only by watching over them as over other associations, (see **METAPHYSICS**, n<sup>o</sup> 98.); for excessive sensibility, as it is not the gift of nature, is the bane of human happiness. "Too much tenderness (as Rousseau well observes) proves the bitterest curse instead of the most fruitful blessing; vexation and disappointment are its certain consequences. The temperature of the air, the change of the seasons, the brilliancy of the sun, or thickness of the fogs, are so many moving springs to the unhappy possessor, and he becomes the wanton sport of their arbitration."

**SENSITIVE-PLANT.** See **MIMOSA**, **DIONÆA**, and **HEDYSARUM**.

The sensitive plants are well known to possess a kind of motion, by which the leaves and stalks are contracted and fall down upon being slightly touched, or shaken with some degree of violence.

The contraction of the leaves and branches of the sensitive plant when touched, is a very singular phenomenon. Different hypotheses have been formed by botanists in order to explain it; but we are disposed to believe that these have generally been deduced rather from analogical reasoning than from a collection of facts and observations. We shall therefore give an account of all the important facts which we have been able to collect upon this curious subject; and then draw such conclusions as obviously result from them, without, however, attempting to support any old, or to establish a new, hypothesis.

1. It is difficult to touch the leaf of a healthy sensitive plant so delicately that it will not immediately collapse

*Sensitive.* lapse (A), the foliola or little leaves moving at their base till they come into contact, and then applying themselves close together. If the leaf be touched with a little more force, the opposite leaf will exhibit the same appearance. If a little more force be applied, the partial footstalks bend down towards the common footstalk from which they issue, making with it a more acute angle than before. If the touch be more violent still, all the leaves situated on the same side with the one that has been touched will instantly collapse, and the partial footstalk will approach the common footstalk to which it is attached, in the same manner as the partial footstalk of the leaf approaches the stem or branch from which it issues; so that the whole plant, from having its branches extended, will immediately appear like a weeping birch.

2. These motions of the plant are performed by means of three distinct and sensible articulations. The first, that of the foliola or lobes to the partial footstalk; the second, that of the partial footstalk to the common one; the third, that of the common footstalk to the trunk. The primary motion of all which is the closing of the leaf upon the partial footstalk, which is performed in a similar manner, and by a similar articulation. This, however, is much less visible than the others. These motions are wholly independent on one another, as may be proved by experiment. It appears that if the partial footstalks are moved, and collapse toward the petioli, or these toward the trunk, the little leaves, whose motion is usually primary to these, should be affected also; yet experiment proves that it is possible to touch the footstalks in such a manner as to affect them only, and make them apply themselves to the trunk, while the leaves feel nothing of the touch; but this cannot be, unless the footstalks are so disposed as that they can fall to the trunk, without suffering their leaves to touch any part of the plant in their passage, because, if they do, they are immediately affected.

3. Winds and heavy rains make the leaves of the sensitive plant contract and close; but no such effect is produced from slight showers.

4. At night, or when exposed to much cold in the day, the leaves meet and close in the same manner as when touched, folding their upper surfaces together, and in part over each other, like scales or tiles, so as to expose as little as possible of the upper surface to the air. The opposite sides of the leaves (foliola) do not come close together in the night, for when touched they apply themselves closer together. Dr Darwin kept a sensitive plant in a dark place for some hours after day-break; the leaves and footstalks were collapsed as in its most profound sleep; and, on exposing it to the light, above 20 minutes passed before it was expanded.

5. In the month of August, a sensitive plant was carried in a pot out of its usual place into a dark cave, the motion that it received in the carriage shut up its leaves, and they did not open till 24 hours afterwards; at this time they became moderately open, but were af-

terwards subject to no changes at night or morning, but remained three days and nights with their leaves in the same moderately open state. At the end of this time they were brought out again into the air, and there recovered their natural periodical motions, shutting every night, and opening every morning, as naturally and as strongly as if the plant had not been in this forced state; and while in the cave, it was observed to be very little less affected with the touch than when abroad in the open air.

6. The great heats of summer, when there is open sunshine at noon, affect the plant in some degree like cold, causing it to shut up its leaves a little, but never in any very great degree. The plant, however, is least of all affected about nine o'clock in the morning, and that is consequently the properest time to make experiments on it. A branch of the sensitive plant cut off, and laid by, retains yet its property of shutting up and opening in the morning for some days; and it holds it longer if kept with one end in water, than if left to dry more suddenly.

7. The leaves only of the sensitive plant shut up in the night, not the branches; and if it be touched at this time, the branches are affected in the same manner as in the day, shutting up, or approaching to the stalk or trunk, in the same manner, and often with more force. It is of no consequence what the substance is with which the plant is touched, it answers alike to all; but there may be observed a little spot, distinguishable by its paler colour in the articulations of its leaves, where the greatest and nicest sensibility is evidently placed.

8. Duhamel having observed, about the 15th of September, in moderate weather, the natural motion of a branch of a sensitive plant, remarked, that at nine in the morning it formed with the stem an angle of 100 degrees; at noon, 112 degrees; at three afternoon, it returned to 100; and after touching the branch, the angle was reduced to 90. Three quarters of an hour after it had mounted to 112; and, at eight at night, it descended again, without being touched, to 90. The day after, in finer weather, the same branch, at eight in the morning, made an angle of 135 degrees with the stem; after being touched, the angle was diminished to 80; an hour after, it rose again to 135; being touched a second time, it descended again to 80; an hour and a half after, it had risen to 145; and upon being touched a third time, descended to 135; and remained in that position till five o'clock in the afternoon, when being touched a fourth time it fell to 110.

9. The parts of the plants which have collapsed afterwards unfold themselves, and return to their former expanded state. The time required for that purpose varies, according to the vigour of the plant, the season of the year, the hour of the day, the state of the atmosphere. Sometimes half an hour is requisite, sometimes only ten minutes. The order in which the parts recover themselves varies in like manner: sometimes it is the common footstalk; sometimes the rib to which

(A) As the nature of the sensitive plant is curious, we wish to make the description of it intelligible to those who are not acquainted with the technical language of botany. We have therefore used the word *leaf* instead of *foliolum*, or *lobe*.

Sensitive

the leaves are attached; and sometimes the leaves themselves are expanded, before the other parts have made any attempt to be reinflated in their former position.

10. If, without shaking the other smaller leaves, we cut off the half of a leaf or lobe belonging to the last pair, at the extremity or summit of a wing, the leaf cut, and its antagonist, that is to say, the first pair, begin to approach each other; then the second, and so on successively, till all the lesser leaves, or lobes of that wing, have collapsed in like manner. Frequently, after 12 or 15 seconds, the lobes of the other wings, which were not immediately affected by the stroke, shut; whilst the stalk and its wing, beginning at the bottom, and proceeding in order to the top, gradually recover themselves. If, instead of one of the lesser extreme leaves, we cut off one belonging to the pair that is next the footstalk, its antagonist shuts, as do the other pairs successively, from the bottom to the top. If all the leaves of one side of a wing be cut off, the opposite leaves are not affected, but remain expanded. With some address, it is possible even to cut off a branch without hurting the leaves, or making them fall. The common footstalk of the winged leaves being cut as far as three-fourths of its diameter, all the parts which hang down collapse, but quickly recover without appearing to have suffered any considerable violence by the shock. An incision being made into one of the principal branches to the depth of one-half the diameter, the branches situated betwixt the section and the root will fall down; those above the incision remain as before, and the lesser leaves continue open; but this direction is soon destroyed, by cutting off one of the lobes at the extremity, as was observed above. Lastly, a whole wing being cut off with precaution near its insertion into the common footstalk, the other wings are not affected by it, and its own lobes do not shut. No motion ensues from piercing the branch with a needle or other sharp instrument.

11. If the end of one of the leaves be burned with the flame of a candle, or by a burning glass, or by touching it with hot iron, it closes up in a moment, and the opposite leaf does the same, and after that the whole series of leaves on each side of the partial or little footstalk; then the footstalk itself; then the branch or common footstalk; all do the same, if the burning has been in a sufficient degree. This proves that there is a very nice communication between all the parts of the plant, by means of which the burning, which only is applied to the extremity of one leaf, diffuses its influence through every part of the shrub. If a drop of aquafortis be carefully laid upon a leaf of the sensitive plant, so as not to shake it in the least, the leaf does not begin to move till the acrid liquor corrodes the substance of it; but at that time, not only that particular leaf, but all the leaves placed on the same footstalk, close themselves up. The vapour of burning sulphur has also this effect on many leaves at once, according as they are more or less exposed to it; but a bottle of very acrid and sulphureous spirit of vitriol, placed under the branches unstopped, produces no such effect. Wetting the leaves with spirit of wine has been observed also to have no effect, nor the rubbing oil of almonds over them; though this last application destroys many plants.

From the preceding experiments the following con-

clusions may be fairly drawn: 1. The contraction or the parts of the sensitive plant is occasioned by an external force, and the contraction is in proportion to the force. 2. All bodies which can exert any force affect the sensitive plant; some by the touch or by agitation, as the wind, rain, &c.; some by chemical influence, as heat and cold. 3. Touching or agitating the plant produces a greater effect than an incision or cutting off a part, or by applying heat or cold.

Attempts have been made to explain these curious phenomena. Dr Darwin, in the notes to his admired poem, intitled, *The Botanic Garden*, lays it down as a principle, that "the sleep of animals consists in a suspension of voluntary motion; and as vegetables are subject to sleep as well as animals, there is reason to conclude (says he) that the various action of closing their petals and foliage may be justly ascribed to a voluntary power; for without the faculty of volition sleep would not have been necessary to them." Whether this definition of sleep when applied to animals be just, we shall not inquire; but it is evident the supposed analogy between the sleep of animals and the sleep of plants has led Dr Darwin to admit this astonishing conclusion, that plants have volition. As volition presupposes a mind or soul, it were to be wished that he had given us some information concerning the nature of a vegetable soul, which can think and will. We suspect, however, that this vegetable soul will turn out to be a mere mechanical or chemical one; for it is affected by external forces uniformly in the same way, its volition is merely passive, and never makes any successful resistance against those causes by which it is influenced. All this is a mere abuse of words. The sleep of plants is a metaphorical expression, and has not the least resemblance to the sleep of animals. Plants are said to sleep when the flowers or leaves are contracted or folded together; but we never heard that there is any similar contraction in the body of an animal during sleep.

The fibres of vegetables have been compared with the muscles of animals, and the motions of the sensitive plant have been supposed the same with muscular motion. Between the fibres of vegetables and the muscles of animals, however, there is not the least similarity. If muscles be cut through, so as to be separated from the joints to which they are attached, their powers are completely destroyed; but this is not the case with vegetable fibres. The following very ingenious experiment, which was communicated to us by a respectable member of the University of Edinburgh, is decisive on this subject. He selected a growing poppy at that period of its growth, before unfolding, when the head and neck are bent down almost double. He cut the stalk where it was curved half through on the under side, and half through at a small distance on the upper side, and half through in the middle point between the two sections, so that the ends of the fibres were separated from the stalk. Notwithstanding these several cuttings on the neck, the poppy raised its head, and assumed a more erect position. There is, therefore, a complete distinction between muscular motion and the motions of a plant, for no motion can take place in the limb of an animal when the muscles of that limb are cut.

In fine, we look upon all attempts to explain the motions of plants as absurd, and all reasoning from supposed analogy between animals and vegetables as the source

Sensitive

Sentence || sentiment  
 source of wild conjecture, and not of sound philosophy. We view the contraction and expansion of the sensitive plant in the same light as we do gravitation, chemical attraction, electricity, and magnetism, as a singular fact, the circumstances of which we may be fully acquainted with, but must despair of understanding its cause.

What has been said under this article chiefly refers to the *mimosa sensitiva* and *putica*. For a full account of the motions of vegetables in general, see *Vegetable Motion*, under the article MOTION.

SENTENCE, in law, a judgment passed in court by the judge in some process, either civil or criminal. See JUDGMENT.

SENTENCE, in grammar, denotes a period; or a set of words comprehending some perfect sense or sentiment of the mind. The business of pointing is to distinguish the several parts and members of sentences, so as to render the sense thereof as clear, distinct, and full as possible. See PUNCTUATION.

In every sentence there are two parts necessarily required; a noun for the subject, and a definite verb: whatever is found more than these two, affects one of them, either immediately, or by the intervention of some other, whereby the first is affected.

Again, every sentence is either simple or compound: a simple sentence is that consisting of one single subject, and one finite verb.—A compound sentence contains several subjects and finite verbs, either expressly or implicitly.

A simple sentence needs no point or distinction; only a period to close it: as, "A good man loves virtue for itself."—In such a sentence, the several adjuncts affect either the subject or the verb in a different manner. Thus the word *good* expresses the quality of the subject, *virtue* the object of the action, and *for itself* the end thereof.—Now none of these adjuncts can be separated from the rest of the sentence: for if one be, why should not all the rest? and if all be, the sentence will be minced into almost as many parts as there are words.

But if several adjuncts be attributed in the same manner either to the subject or the verb, the sentence becomes compound, and is to be divided into parts.

In every compound sentence, as many subjects, or as many finite verbs as there are, either expressly or implied, so many distinctions may there be. Thus, "My hopes, fears, joys, pains, all centre in you." And thus *Catiline abiit, excessit, evasit, erupit.*—The reason of which pointing is obvious; for as many subjects or finite verbs as there are in a sentence, so many members does it really contain. Whenever, therefore, there occur more nouns than verbs, or contrariwise, they are to be conceived as equal. Since, as every subject requires its verbs, so every verb requires its subject, where-with it may agree: excepting, perhaps, in some figurative expressions.

SENTICOSÆ (from *sentis*, a "briar or bramble"); the name of the 35th order in Linnæus's fragments of a natural method, consisting of rose, bramble, and other plants, which resemble them in port and external structure. See BOTANY, page 465.

SENTIMENT, according to Lord Kames, is a term appropriated to such thoughts as are prompted by passion. It differs from a perception; for a perception signifies the act by which we become conscious

of external objects. It differs from consciousness of an internal action, such as thinking, suspending thought, inclining, resolving, willing, &c. And it differs from the conception of a relation among objects; a conception of that kind being termed *opinion*.

SENTIMENTS, in poetry. To talk in the language of music, each passion hath a certain tone, to which every sentiment proceeding from it ought to be tuned with the greatest accuracy: which is no easy work, especially where such harmony ought to be supported during the course of a long theatrical representation. In order to reach such delicacy of execution, it is necessary that a writer assume the precise character and passion of the personage represented; which requires an uncommon genius. But it is the only difficulty; for the writer, who, annihilating himself, can thus become another person, need be in no pain about the sentiments that belong to the assumed character: these will flow without the least study, or even preconception; and will frequently be as delightfully new to himself as to his reader. But if a lively picture even of a single emotion require an effort of genius, how much greater the effort to compose a passionate dialogue with as many different tones of passion as there are speakers? With what ductility of feeling must that writer be endued, who approaches perfection in such a work; when it is necessary to assume different and even opposite characters and passions in the quickest succession? Yet this work, difficult as it is, yields to that of composing a dialogue in genteel comedy, exhibiting characters without passion. The reason is, that the different tones of character are more delicate, and less in sight, than those of passion; and, accordingly, many writers, who have no genius for drawing characters, make a shift to represent, tolerably well, an ordinary passion in its simple movements. But of all works of this kind, what is truly the most difficult, is a characteristical dialogue upon any philosophical subject; to interweave characters with reasoning, by suiting to the character of each speaker a peculiarity not only of thought but of expression, requires the perfection of genius, taste, and judgment.

How difficult dialogue-writing is, will be evident, even without reasoning, from the miserable compositions of that kind found without number in all languages. The art of mimicking any singularity in gesture or in voice, is a rare talent, though directed by sight and hearing, the acutest and most lively of our external senses: how much more rare must that talent be, of imitating characters and internal emotions, tracing all their different tints, and representing them in a lively manner by natural sentiments properly expressed? The truth is, such execution is too delicate for an ordinary genius; and for that reason the bulk of writers, instead of expressing a passion as one does who feels it, content themselves with describing it in the language of a spectator. To awake passion by an internal effort merely, without any external cause, requires great sensibility; and yet that operation is necessary, not less to the writer than to the actor; because none but those who actually feel a passion can represent it to the life. The writer's part is the more complicated: he must add composition to passion: and must, in the quickest succession, adopt every different character. But a very humble flight of imagination may serve to convert a

*Sentiments.* writer into a spectator, so as to figure, in some obscure manner, an action as passing in his sight and hearing. In that figured situation, being led naturally to write like a spectator, he entertains his readers with his own reflections, with cool description, and florid declamation; instead of making them eye-witnesses, as it were, to a real event, and to every movement of genuine passion. Thus most of our plays appear to be cast in the same mould; personages without character, the mere outlines of passion, a tiresome monotony, and a pompous declamatory style.

This descriptive manner of representing passion is a very cold entertainment; our sympathy is not raised by description; we must first be lulled into a dream of reality, and every thing must appear as passing in our sight. Unhappy is the player of genius who acts a part in what may be termed a *descriptive tragedy*; after assuming the very passion that is to be represented, how is he cramped in action, when he must utter, not the sentiments of the passion he feels, but a cold description in the language of a bystander? It is that imperfection, undoubtedly, in the bulk of our plays, which confines our stage almost entirely to Shakespeare, notwithstanding his many irregularities. In our late English tragedies, we sometimes find sentiments tolerably well adapted to a plain passion: but we must not in any of them expect a sentiment expressive of character; and, upon that very account, our late performances of the dramatic kind are for the most part intolerably insipid.

But it may be proper to illustrate this subject by examples. The first examples shall be of sentiments that appear the legitimate offspring of passion; to which shall be opposed what are descriptive only, and illegitimate: and in making this comparison, the instances shall be borrowed from Shakespeare and Corneille, who for genius in dramatic composition stand uppermost in the rolls of fame.

I. Shakespeare shall furnish the first example, being of sentiments dictated by a violent and perturbed passion:

*Lear.* ———— Filial ingratitude!  
Is it not as if this mouth should tear this hand  
For lifting food to't?—But I'll punish home;  
No, I will weep no more.—In such a night,  
To shut me out!—Pour on, I will endure.  
In such a night as this! O Regan, Gonerill,  
Your old kind father, whose frank heart gave all—  
O! that way madness lies; let me shun that;  
No more of that. ————

*Kent.* Good, my lord, enter here.

*Lear.* Prithee, go in thyself, seek thine own ease,  
This tempest will not give me leave to ponder  
On things would hurt me more:—but I'll go in;  
In, boy, go first. You houseless poverty—  
Nay, get thee in; I'll pray, and then I'll sleep—  
Poor naked wretches, wheresoe'er you are,  
That bide the pelting of this pitiless storm!  
How shall your houseless heads, and unfed sides,  
Your loop'd and window'd raggedness defend you  
From seasons such as these!—O I have ta'en  
Too little care of this! take physic, Pomp;  
Expose thyself to feel what wretches feel,

*Sentiments.* That thou may'st shake the superflux to them,  
And show the heav'ns more just.

*King Lear, act 3. sc. 5.*

With regard to the French author, truth obliges us to acknowledge, that he describes in the style of a spectator, instead of expressing passion like one who feels it; which naturally betrays him into a tiresome monotony, and a pompous declamatory style. It is scarce necessary to give examples, for he never varies from that tone. We shall, however, take two passages at a venture, in order to be confronted with those transcribed above. In the tragedy of Cinna, after the conspiracy was discovered, Æmilia, having nothing in view but racks and death to herself and her lover, receives a pardon from Augustus, attended with the brightest circumstances of magnanimity and tenderness. This is a lucky situation for representing the passions of surprise and gratitude in their different stages, which seem naturally to be what follow. These passions, raised at once to the utmost pitch, and being at first too big for utterance, must, for some moments, be expressed by violent gestures only: so soon as there is vent for words, the first expressions are broken and interrupted: at last, we ought to expect a tide of intermingled sentiments, occasioned by the fluctuation of the mind between the two passions. Æmilia is made to behave in a very different manner: with extreme coolness she describes her own situation, as if she were merely a spectator; or rather the poet takes the task off her hands:

Et je me rends, Seigneur, à ces hautes bontés:  
Je recouvre la vue auprès de leurs clartés.  
Je connois mon forfait qui me sembloit justice;  
Et ce que n'avoit pu la terreur du supplice,  
Je sens naître en mon ame un repentir puissant,  
Et mon cœur en secret me dit, qu'il y consent.  
Le ciel a résolu votre grandeur suprême;  
Et pour preuve, Seigneur, je n'en veux que moi-même.  
J'ose avec vanité me donner cet éclat,  
Puisqu'il change mon cœur, qu'il veut changer l'état.  
Ma haine va mourir, que j'ai crue immortelle;  
Elle est morte, et ce cœur devient sujet fidele;  
Et prenant désormais cette haine en horreur,  
L'ardeur de vous servir succede à sa fureur.

*Act 5. sc. 3.*

So much in general upon the genuine sentiments of passion. We proceed to particular observations. And, first, passions seldom continue uniform any considerable time: they generally fluctuate, swelling and subsiding by turns, often in a quick succession; and the sentiments cannot be just unless they correspond to such fluctuation. Accordingly, a climax never shows better than in expressing a swelling passion: the following passages may suffice for an illustration.

*Almeria.* ———— How hast thou charm'd  
The wildness of the waves and rocks to this;  
That thus relenting they have giv'n thee back  
To earth, to light and life, to love and me?

*Mourning Bride, act 1. sc. 7.*

I would not be the villain that thou think'st  
For the whole space that's in the tyrant's grasp,  
And the rich earth to boot.

*Macbeth, act 4. sc. 4.*  
The



iments. The following passage expresses finely the progress of conviction.

Let me not stir, nor breathe, lest I dissolve  
That tender, lovely form, of painted air,  
So like Almeria. Ha! it sinks, it falls;  
I'll catch it e'er it goes, and grasp her shade.  
'Tis life! 'tis warm! 'tis she! 'tis she herself!  
It is Almeria! 'tis, it is my wife!

*Mourning Bride, act 2. sc. 6.*

In the progress of thought our resolutions become more vigorous as well as our passions.

If ever I do yield or give consent,  
By any action, word, or thought, to wed  
Another lord; may then just heav'n show'r down, &c.  
*Mourning Bride, act 1. sc. 1.*

And this leads to a second observation, That the different stages of a passion, and its different directions, from birth to extinction, must be carefully represented in their order; because otherwise the sentiments, by being misplaced, will appear forced and unnatural. — Repentment, for example, when provoked by an atrocious injury, discharges itself first upon the author: sentiments therefore of revenge come always first, and must in some measure be exhausted before the person injured think of grieving for himself. In the *Cid* of Corneille, Don Diegue having been affronted in a cruel manner, expresses scarce any sentiment of revenge, but is totally occupied in contemplating the low situation to which he is reduced by the affront:

O rage! ô desespoir! ô vieilleste ennemie!  
N'ai-je donc tant vécu que pour cette intamie?  
Et ne suis-je blanchi dans les travaux guerriers,  
Que pour voir en un jour flétrir tant de lauriers?  
Mon bras, qu'avec respect tout l'Espagne admire,  
Mon bras qui tant de fois a sauvé cet empire,  
Tant de fois affermi le trône de son roi,  
Trahit donc ma querelle, et ne fait rien pour moi!  
O cruel souvenir de ma gloire passé!  
Oeuvre de tant de jours en un jour effacé!  
Nouvelle dignité fatale à mon bonheur!  
Precipice élevé d'où tombe mon honneur!  
Faut-il de votre éclat voir triompher le comte,  
Et mourir sans vengeance, ou vivre dans la honte?  
Comte, fois de mon prince à présent gouverneur,  
Ce haut rang n'admet point un homme sans honneur;  
Et ton jaloux orgueil par cet affront infligé,  
Malgré le choix du roi, m'en a fû rendre indigne.  
Et toi, de mes exploits glorieux instrument,  
Mais d'un corps tout de glace inutile ornement,  
Fer jadis tant à craindre, et qui dans cette offense,  
M'as servi de parade, et non pas de défense,  
Va, quitte désormais le dernier des humains,  
Passe pour me venger en de meilleures mains.

*Le Cid, act 1. sc. 7.*

These sentiments are certainly not the first that are suggested by the passion of resentment. As the first movements of resentment are always directed to its object, the very same is the case of grief. Yet with relation to the sudden and severe distemper that seized Alexander bathing in the river Cydnus, Quintus Curtius describes the first emotions of the army as directed to themselves, lamenting that they were left without a leader, far from home, and had scarce any hopes of re-

turning in safety: their king's distress, which must naturally have been their first concern, occupies them but in the second place according to that author. In the *Aminta* of Tasso, Sylvia, upon a report of her lover's death, which she believed certain, instead of bemoaning the loss of her beloved, turns her thoughts upon herself, and wonders her heart does not break:

Ohime, ben son di fasso,  
Poi che questa novella non m'uccide. *Act. 4. sc. 2.*

In the tragedy of *Jane Shore*, Alicia, in the full purpose of destroying her rival, has the following reflection:

Oh Jealousy! thou bane of pleasing friendship,  
Thou worst invader of our tender bosoms;  
How does thy rancour poison all our softnesses,  
And turn our gentle nature into bitterness!  
See where she comes! Once my heart's dearest blessing,  
Now my chang'd eyes are blasted with her beauty,  
Loathe that known face, and sicken to behold her.

*Act 3. sc. 1.*

These are the reflections of a cool spectator. A passion, while it has the ascendant, and is freely indulged, suggests not to the person who feels it any sentiment to its own prejudice: reflections like the foregoing occur not readily till the passion has spent its vigour.

A person sometimes is agitated at once by different passions; and the mind in that case, vibrating like a pendulum, vents itself in sentiments that partake of the same vibration. This we give as a third observation:

*Queen.* Would I had never trod this English earth,  
Or felt the flatteries that grow upon it!  
Ye've angels faces, but heav'n knows your hearts.  
What shall become of me now? wretched lady!  
I am the most unhappy woman living.  
Alas! poor wench, where are now your fortunes?

[*To her women.*]

Shipwreck'd upon a kingdom, where no pity,  
No friends, no hope, no kindred, weep for me!  
Almost no grave allow'd me.

*Henry VIII. act 3. sc. 1.*

*Othello.* Oh devil, devil!  
If that the earth could teem with woman's tears,  
Each drop she falls would prove a crocodile.  
Out of my sight!

*Desdemona.* I will not stay t'offend you. [*Going.*]

*Lodovico.* Truly, an obedient lady:

I do beseech your lordship, call her back.

*Oth.* Mistress —

*Des.* My lord.

*Oth.* What would you with her, Sir?

*Lod.* Who, I, my lord?

*Oth.* Ay; you did wish that I would make her turn.

Sir, she can turn and turn, and yet go on;  
And turn again. And she can weep, Sir, weep;  
And she's obedient: as you say, obedient:  
Very obedient — proceed you in your tears —  
Concerning this, Sir, — oh well painted passion! —  
I am commanded home — get you away,  
I'll send for you anon — Sir, I obey the mandate,  
And will return to Venice. — Hence, avant!

[*Exit Desdemona.*]

*Othello, act 4. sc. 6.*

*Emilia.*

Sentiments. *Æmilia*. Oh ! my good lord, I would speak a word with you.

*Othello*. Yes, 'tis *Æmilia*—By and by.—She's dead.  
'Tis like she comes to speak of *Cassio's* death ;  
The noise was high.—Ha ! no more moving ?  
Still as the grave. Shall she come in ? wer't good ?  
I think she stirs again—No—what's the best ?  
If she come in, she'll, sure, speak to my wife :  
My wife ! my wife ! what wife ? I have no wife ;  
Oh insupportable ? oh heavy hour !

*Othello*, *act* 5. *sc.* 7.

A fourth observation is, That nature, which gave us passions, and made them extremely beneficial when moderate, intended undoubtedly that they should be subjected to the government of reason and conscience. It is therefore against the order of nature, that passion in any case should take the lead in contradiction to reason and conscience : such a state of mind is a sort of anarchy which every one is ashamed of and endeavours to hide or dissemble. Even love, however laudable, is attended with a conscious shame when it becomes immoderate : it is covered from the world, and disclosed only to the beloved object :

Et que l'amour souvent de remors combattu  
Paroisse une foiblesse, et non une vertu.

*Boileau*, *l'Art Poët. chant.* 3. l. 101.

O, they love least that let men know they love.

*Two Gentlemen of Verona*, *act* 1. *sc.* 3.

Hence a capital rule in the representation of immoderate passions, that they ought to be hid or dissembled as much as possible. And this holds in an especial manner with respect to criminal passions : one never counfels the commission of a crime in plain terms ; guilt must not appear in its native colours, even in thought ; the proposal must be made by hints, and by representing the action in some favourable light. Of the propriety of sentiment upon such an occasion, *Shakespeare*, in the *Tempest*, has given us a beautiful example, in a speech by the usurping duke of Milan, advising *Sebastian* to murder his brother the king of Naples :

*Antonio*. ————— What might,  
Worthy *Sebastian*,—O, what might—no more.  
And yet, methinks, I see it in thy face  
What thou shouldst be : the occasion speaks thee, and  
My strong imagination sees a crown  
Dropping upon thy head. *Act* 2. *sc.* 2.

A picture of this kind, perhaps still finer, is exhibited in *King John*, where that tyrant solicits (*act* 3. *sc.* 5.) *Hubert* to murder the young prince *Arthur* ; but it is too long to be inserted here.

II. As things are best illustrated by their contraries, we proceed for faulty sentiments, disdaining to be indebted for examples to any but the most approved authors. The first class shall consist of sentiments that accord not with the passion ; or, in other words, sentiments that the passion does not naturally suggest. In the second class shall be ranged sentiments that may belong to an ordinary passion, but unsuitable to it as tinged by a singular character. Thoughts that properly are not sentiments, but rather descriptions, make a third. Sentiments that belong to the passion represented, but are faulty as being introduced too early or

too late, make a fourth. Vicious sentiments exposed in their native dress, instead of being concealed or disguised, make a fifth. And in the last class shall be collected sentiments suited to no character nor passion, and therefore unnatural.

The first class contains faulty sentiments of various kinds, which we shall endeavour to distinguish from each other.

1. Of sentiments that are faulty by being above the tone of the passion, the following may serve as an example :

*Othello*. ————— O my soul's joy !

If after every tempest come such calms,  
May the winds blow till they have waken'd death :  
And let the labouring bark climb hills of seas  
Olympus high, and duck again as low  
As hell's from heaven ? *Othello*, *act* 2. *sc.* 6.

This sentiment may be suggested by violent and inflamed passion ; but is not suited to the satisfaction, however great, that one feels upon escaping danger.

2. Instance of sentiments below the tone of the passion. *Ptolemy*, by putting *Pompey* to death, having incurred the displeasure of *Cæsar*, was in the utmost dread of being dethroned : in that agitating situation, *Corneille* makes him utter a speech full of cool reflection, that is in no degree expressive of the passion.

Ah ! si je t'avois crû, je n'aurois pas de maitre,  
Je serois dans le trône où le ciel m'a fait naître ;  
Mais c'est une imprudence assez commune aux rois,  
D'écouter trop d'avis, et se tromper au choix.  
Le Destin les aveugle au bord du précipice,  
Ou si quelque lumière en leur ame se glisse,  
Cette fausse clarté dont il les éblouit,  
Le plonge dans une gouffre, et puis s'évanouit.  
*La Mort de Pompée*, *act* 4. *sc.* 1.

3. Sentiments that agree not with the tone of the passion ; as where a pleasant sentiment is grafted upon a painful passion, or the contrary. In the following instances, the sentiments are too gay for a serious passion :

No happier task these faded eyes pursue ;  
To read and weep is all they now can do.

*Eloisa to Abelard*. l. 47.

Again ;

Heav'n first taught letters for some wretch's aid,  
Some banish'd lover, or some captive maid :  
They live, they speak, they breathe what love inspires,  
Warm from the soul, and faithful to its fires ;  
The virgin's wish without her tears impart,  
Excuse the blush, and pour out all the heart ;  
Speed the soft intercourse from soul to soul,  
And waft a sigh from Indus to the pole.

*Eloisa to Abelard*, l. 51.

These thoughts are pretty : they suit *Pope*, but not *Eloisa*.

*Satan*, enraged by a threatening of the angel *Gabriel*, answers thus :

Then when I am thy captive, talk of chains,  
Proud liminary cherub ; but ere then  
Far heavier load thyself expect to feel  
From my prevailing arm, though heaven's King

Ride on thy wings, and thou with thy compeers,  
Us'd to the yoke, draw'st his triumphant wheels  
In progress thro' the road of heav'n *par'v'd.*

*Paradise Lost, b. 4.*

The concluding epithet forms a grand and delightful image, which cannot be the genuine offspring of rage.

4. Sentiments too artificial for a serious passion. The first example is a speech of Percy expiring.

O, Harry, thou hast robb'd me of my growth:  
I better brook the loss of brittle life,  
Than those proud titles thou hast won of me; [flesh.  
They wound my thoughts worse than thy sword my  
But thought's the slave of life, and life time's tool;  
And time, that takes survey of all the world,  
Must have a stop.

*First Part, Henry IV. act 5. sc. 9.*

The sentiments of the *Mourning Bride* are for the most part no less delicate than just copies of nature: in the following exception the picture is beautiful, but too artful to be suggested by severe grief.

*Almeria.* O no! Time gives increase to my afflictions.

The circling hours, that gather all the woes  
Which are diffus'd through the revolving year,  
Come heavy laden with th' oppressive weight  
To me; with me, successively, they leave  
The sighs, the tears, the groans, the restless cares,  
And all the damps of grief, that did retard thy flight;  
They shake their downy wings, and scatter all  
The dire collected dews on my poor head;  
'Then fly with joy and swiftness from me. *Act 1. sc. 1.*

In the same play, *Almeria* seeing a dead body, which she took to be *Alphonso's*, expresses sentiments strained and artificial, which nature suggests not to any person upon such an occasion:

Had they or hearts or eyes, that did this deed?  
Could eyes endure to guide such cruel hands?  
Are not my eyes guilty alike with theirs,  
'That thus can gaze, and yet not turn to stone?  
—I do not weep! The springs of tears are dry'd,  
And of a sudden I am calm, as if [der'd!  
All things were well; and yet my husband's murder,  
Yes, yes, I know to mourn: I'll sluice this heart,  
'The source of wo, and let the torrent in.

*Act 5. sc. 11.*

Pope's elegy to the memory of an unfortunate lady, expresses delicately the most tender concern and sorrow that one can feel for the deplorable fate of a person of worth. Such a poem, deeply serious and pathetic, rejects with disdain all fiction. Upon that account, the following passage deserves no quarter; for it is not the language of the heart, but of the imagination indulging its flights at ease, and by that means is eminently discordant with the subject. It would be a still more severe censure, if it should be ascribed to imitation, copying indiscreetly what has been said by others:

What tho' no weeping loves thy ashes grace,  
Nor polish'd marble emulate thy face?  
What though no sacred earth allow thee room,  
Nor hallow'd dirge be mutter'd o'er thy tomb?

Yet shall thy grave with rising flow'rs be dress'd,  
And the green turf lie lightly on thy breast:  
There shall the morn her earliest tears bestow,  
'There the first roses of the year shall blow;  
While angels with their silver wings o'er shade  
The ground, now sacred by thy relics made.

5. Fanciful or finical sentiments. Sentiments that degenerate into point or conceit, however they may amuse in an idle hour, can never be the offspring of any serious or important passion. In the *Jerusalem* of Tasso, Tancred, after a single combat, spent with fatigue and loss of blood, falls into a swoon; in which situation, understood to be dead, he is discovered by Erminia, who was in love with him to distraction. A more happy situation cannot be imagined, to raise grief in an instant to its highest pitch; and yet, in venting her sorrow, she descends most abominably into antitheses and conceit even of the lowest kind:

E in lui versò d'inefficabil vena  
Lacrime, e voce di sospiri mista.  
In che misero punto hor qui me mena  
Fortuna? a che veduta amara e trista?  
Dopo gran tempo i' ti ritrovo à pena  
Tancredi, e ti riveggio, e non son vista  
Villa non fou da te, benche presente  
T' trovando ti perdo eternamente.

*Canto 19. st. 105.*

*Armida's* lamentation respecting her lover *Rinaldo* is in the same vicious taste. *Vid. canto 20. Stan. 124, 125, 126.*

*Queen.* Give me no help in lamentation,  
I am not barren to bring forth complaints:  
All springs reduce their currents to mine eyes,  
'That I, being govern'd by the wat'ry moon,  
May send forth plenteous tears to drown the world,  
Ah, for my husband, for my dear lord Edward.

*King Richard III. act 2. sc. 2.*

*Jane Shore* utters her last breath in a witty conceit:

'Then all is well, and I shall sleep in peace —  
'Tis very dark, and I have lost you now —  
Was there not something I would have bequeath'd you?  
But I have nothing left me to bestow,  
Nothing but one sad sigh. Oh mercy, Heav'n! [*Dies.*  
*Act 5.*

*Gilford* to *Lady Jane Gray*, when both were condemned to die:

Thou stand'st unmov'd;  
Calm temper sits upon thy beauteous brow;  
'Thy eyes that flow'd so fast for Edward's loss,  
Gaze unconcern'd upon the ruin round thee,  
As if thou had'st resolv'd to brave thy fate,  
And triumph in the midst of desolation.  
Ha! see, it swells, the liquid crystal rises,  
It starts in spite of thee — but I will catch it,  
Nor let the earth be wet with dew so rich.

*Lady Jane Gray, act 4. near the end.*

The concluding sentiment is altogether finical, unsuitable to the importance of the occasion, and even to the dignity of the passion of love.

*Cornelle,*

*Sentiments.* Corneille, in his *Examen of the Gid*, answering an objection, That his sentiments are sometimes too much refined for persons in deep distress, observes, that if poets did not indulge sentiments more ingenious or refined than are prompted by passion, their performances would often be low, and extreme grief would never suggest but exclamations merely. This is in plain language to assert, that forced thoughts are more agreeable than those that are natural, and ought to be preferred.

The *second* class is of sentiments that may belong to an ordinary passion, but are not perfectly concordant with it, as tinctured by a singular character.

In the last act of that excellent comedy *The Careless Husband*, Lady Easy, upon Sir Charles's reformation, is made to express more violent and turbulent sentiments of joy than are consistent with the mildness of her character.

*Lady Easy.* O the soft treasure! O the dear reward of long-desiring love.—Thus! thus to have you mine, is something more than happiness; 'tis double life, and madness of abounding joy.

The following instances are descriptions rather than sentiments, which compose a *third* class.

Of this descriptive manner of painting the passions, there is in the *Hippolytus* of Euripides, *act v.* an illustrious instance, *viz.* the speech of Theseus, upon hearing of his son's dismal exit. In Racine's tragedy of *Esther*, the queen hearing of the decree issued against her people, instead of expressing sentiments suitable to the occasion, turns her attention upon herself, and describes with accuracy her own situation.

Juste ciel! tout mon sang dans mes veines se glace.

*Act 1. sc. 3.*

Again,

*Aman.* C'en est fait. Mon orgueil est forcé de plier.  
L'inexorable Aman est réduit à prier.

*Esther, act 3. sc. 5.*

*Athalie.* Quel prodige nouveau me trouble et m'embarrasse?

La douceur de sa voix, son enfance, sa grace,  
Font insensiblement à mon inimitié  
Succéder — Je serois sensible à la pitié?

*Athalie, act 2. sc. 7.*

*Titus.* O de ma passion fureur desespérée!

*Brutus of Voltaire, act 3. sc. 6.*

What other are the foregoing instances but describing the passion another feels?

The *fourth* class is of sentiments expressed too early or too late.

Some examples mentioned above belong to this class. Add the following from *Venice Preserved*, *act 5.* at the close of the scene between Belvidera and her father Priuli. The account given by Belvidera of the danger she was in, and of her husband's threatening to murder her, ought naturally to have alarmed her relenting father, and to have made him express the most perturbed sentiments. Instead of which, he dissolves into tenderness and love for his daughter, as if he had already delivered her from danger, and as if there were a perfect tranquillity:

Canst thou forgive me all my follies past!  
I'll henceforth be indeed a father; never,  
Never more thus expose, but cherish thee,  
Dear as the vital warmth that feeds my life,  
Dear as those eyes that weep in fondness o'er thee:  
Peace to thy heart.

Immoral sentiments exposed in their native colours, instead of being concealed or disguised, compose the *fifth* class.

The Lady Macbeth, projecting the death of the king, has the following soliloquy:

————— 'The raven himself's not hoarse  
That croaks the fatal entrance of Duncan  
Under my battlements. Come, all you spirits  
That tend on mortal thoughts, unsex me here,  
And fill me from the crown to the toe, top full  
Of direct cruelty; make thick my blood,  
Stop up th' access and passage to remorse,  
That no compunctious visitings of nature  
Shake my fell purpose. *Macbeth, act 1. sc. 7.*

This speech is not natural. A treacherous murder was never perpetrated even by the most hardened miscreant without compunction: and that the lady here must have been in horrible agitation, appears from her invoking the infernal spirits to fill her with cruelty, and to stop up all avenues to remorse. But in that state of mind it is a never-failing artifice of self-deceit to draw the thickest veil over the wicked action, and to extenuate it by all the circumstances that imagination can suggest: and if the crime cannot bear disguise, the next attempt is to thrust it out of mind altogether, and to rush on to action without thought. This last was the husband's method.

Strange things I have in head, that will to hand;  
Which must be acted ere they must be scann'd.

*Act 3. sc. 5.*

The lady follows neither of these courses, but in a deliberate manner endeavours to fortify her heart in the commission of an execrable crime, without even attempting to colour it. This, we think, is not natural; we hope there is no such wretch to be found as is here represented.

The *last* class comprehends sentiments that are unnatural, as being suited to no character nor passion. These may be subdivided into three branches: first, sentiments unsuitable to the constitution of man, and to the laws of his nature; second, inconsistent sentiments; third, sentiments that are pure rant and extravagance.

When the fable is of human affairs, every event, every incident, and every circumstance, ought to be natural, otherwise the imitation is imperfect. But an imperfect imitation is a venial fault, compared with that of running cross to nature. In the *Hippolytus* of Euripides (*act iv. sc. 5.*), Hippolytus, wishing for another self in his own situation, "How much (says he) should I be touched with his misfortune!" as if it were natural to grieve more for the misfortune of another than for one's own.

*O'myn.* Yet I behold her—yet—and now no more.  
Turn your lights inward, eyes, and view my thought;  
So shall you still behold her—"I will not be.

*Sentiments.* O Impotence of sight! mechanic sense,  
Which to exterior objects ow't thy faculty,  
Not seeing of election, but necessity.  
Thus do our eyes, as do all common mirrors,  
Successively reflect succeeding images.  
Nor what they would, but must; a star or toad;  
Just as the hand of chance administers!

*Mourning Bride, act 2. sc. 8.*

No man, in his senses, ever thought of applying his eyes to discover what passes in his mind; far less of blamming his eyes for not seeing a thought or idea. In *Moliere's l'Avare* (*act iv. sc. 7*) Harpagon, being robbed of his money, seizes himself by the arm, mistaking it for that of the robber. And again he expresses himself as follows:

Je veux aller querir la justice, et faire donner la question à toute ma maison; à servantes, à valets, à fils, à fille, et à moi aussi.

This is so absurd as scarce to provoke a smile, if it be not at the author.

Of the second branch the following example may suffice:

————— Now bid me run,  
And I will strive with things impossible,  
Yea, get the better of them.

*Julius Caesar, act 2. sc. 3.*

Of the third branch, take the following samples. Lucan, talking of Pompey's sepulchre,

————— Romanum nomen, et omne  
Imperium magno est tumuli modus. Obruè saxa  
Crimine plena desum. Si tota est Herculis Oete,  
Et juga tota vacant Bromio Nyseia; quare  
Unus in Egypto Magno lapis? Omnia Lagi  
Rura tenere potest, si nullo cespite nomen  
Hæserit. Eiremus populi, cinerumque tuorum,  
Magne, metu nullas Nili calcemus arenas.

*L. viii. l. 798.*

Thus, in Rowe's translation:

Where there are seas, or air, or earth, or skies,  
Where'er Rome's empire stretches, Pompey lies.  
Far be the vile memorial then convey'd!  
Nor let this stone the partial gods upbraid.  
Shall Hercules all Oeta's heights demand,  
And Nyssa's hill for Bacchus only stand;  
While one poor pebble is the warrior's doom  
That fought the cause of liberty and Rome?  
If Fate decrees he must in Egypt lie,  
Let the whole fertile realm his grave supply,  
Yield the wide country to his awful shade,  
Nor let us dare on any part to tread,  
Fearful we violate the mighty dead.

The following passages are pure rant. *Coriolanus*, speaking to his mother,

What is this?  
Your knees to me? to your corrected son?  
'Then let the pebbles on the hungry beach  
Fillop the stars: then let the mutinous winds  
Strike the proud cedars 'gainst the fiery sun:  
Murd'ring impossibility, to make  
What cannot be, slight work.

*Coriolanus, act 5. sc. 3.*

VOL. XVII. Part I.

*Cæsar.* — Danger knows full well,  
That Cæsar is more dangerous than he.  
We were two lions litter'd in one day,  
And I the elder and more terrible.

*Julius Cæsar, act 2. sc. 4.*

*Ventidius.* But you, ere love misled your wand'ring eyes,

Were sure the chief and best of human race,  
Fram'd in the very pride and boast of nature,  
So perfect, that the gods who form'd you wonder'd  
At their own skill, and cry'd, A lucky hit  
Has mended our design. *Dryden, All for Love, act 1.*

Not to talk of the impiety of this sentiment, it is ludicrous instead of being lofty.

The famous epitaph on Raphael is not less absurd than any of the foregoing passages:

Raphael, timuit, quo sospite, vincit,  
Rerum magna parens, et moriente mori.

Imitated by Pope, in his epitaph on Sir Godfrey Kneller:

Living, great Nature fear'd he might outvie  
Her works; and dying, fears herself may die.

Such is the force of imitation; for Pope of himself would never have been guilty of a thought so extravagant.

**SENTINEL, or SENTRY,** in military affairs, a private soldier placed in some post to watch the approach of the enemy, to prevent surprises, to stop such as would pass without orders or discovering who they are. They are placed before the arms of all guards, at the tents and doors of general officers, colonels of regiments, &c.

*SENTINEL Perdu,* a soldier posted near an enemy, or in some very dangerous post where he is in hazard of being lost.

All sentinels are to be vigilant on their posts; neither are they to sing, smoke tobacco, nor suffer any noise to be made near them. They are to have a watchful eye over the things committed to their charge. They are not to suffer any light to remain, or any fire to be made, near their posts in the night-time; neither is any sentry to be relieved or removed from his post but by the corporal of the guard. They are not to suffer any one to touch or handle their arms, or in the night-time to come within ten yards of their post.

No person is to strike or abuse a sentry on his post; but when he has committed a crime, he is to be relieved, and then punished according to the rules and articles of war.

A sentinel, on his post in the night, is to know nobody but by the counter-sign: when he challenges, and is answered, *Relief,* he calls out, *Stand, relief! advance, corporal!* upon which the corporal halts his men, and advances alone within a yard of the sentry's firelock (first ordering his party to rest, on which the sentry does the same), and gives him the counter-sign, taking care that no one hear it.

**SEPIA, the CUTTLE-FISH,** a genus belonging to the order of vermes molusca. There are eight brachia interspersed on the interior side, with little round ferrated cups, by the contraction of which the animal lays fast hold of any thing. Besides these eight arms,

*Sepia.* it has two tentacula longer than the arms, and frequently pedunculated. The mouth is situated in the centre of the arms, and is horny and hooked, like the bill of a hawk. The eyes are below the tentacula, towards the body of the animal. The body is fleshy, and received into a sheath as far as the breast. Their food are tunnies, sprats, lobsters, and other shell-fish. With their arms and trunks they fasten themselves, to resist the motion of the waves. Their beak is like that of a parrot. The females are distinguished by two papæ. They copulate as the polypi do, by a mutual embrace, and lay their eggs upon sea-weed and plants, in parcels like bunches of grapes. Immediately after they are laid they are white, and the males pass over and impregnate them with a black liquor, after which they grow larger. On opening the egg, the embryo-cuttle is found alive. The males are very constant, accompany their females everywhere, face every danger in their defence, and rescue them intrepidly at the hazard of their own lives. The timorous females fly as soon as they see the males wounded. The noise of a cuttle-fish, on being dragged out of the water, resembles the grunting of a hog. When the male is pursued by the sea-wolf or other ravenous fish, he shuns the danger by stratagem. He squirts his black liquor, sometimes to the quantity of a dram, by which the water becomes black as ink, under shelter of which he baffles the pursuit of his enemy. This ink or black liquor has been denominated by Mr le Cat *æthiops animal*, and is reserved in a particular gland. In its liquid state it resembles that of the choroid in man; and would then communicate an indelible dye; when dry, it might be taken for the product of the black liquor in negroes dried, and made a precipitate by spirit of wine. This *æthiops animal* in negroes as well as in the cuttle-fish, is more abundant after death than even during life. It may serve either for writing or printing; in the former of which ways the Romans used it. It is said to be an ingredient in the composition of Indian ink mixed with rice. There are five species.

1. The *lologo*, or great cuttle, with short arms and long tentacula; the lower part of the body rhomboid and pinnated, the upper thick and cylindric. They inhabit all our seas, where having blackened the water by the effusion of their ink, they abscond, and with their tail leap out of the water. They are gregarious and swift in their motions: they take their prey by means of their arms; and embracing it, bring it to their central mouth. They adhere to the rocks, when they wish to be quiescent, by means of the concave discs that are placed along their arms.

2. The *octopodia*, with eight arms, connected at their bottom by a membrane. This is the *polypus* of Pliny, which he distinguishes from the *lologo* and *sepia* by the want of the tail and tentacula. They inhabit our seas, but are most at home in the Mediterranean. In hot climates these are found of an enormous size. The Indians affirm, that some have been seen two fathoms broad over their centre, and each arm nine fathoms long. When the Indians navigate their little boats, they go in dread of them; and lest these animals should sling their arms over and sink them, they never sail without an ax to cut them off. When used for food they are served up red from their own liquor,

which from boiling with the addition of nitre becomes red. Barthol. says, upon cutting one of them open, so great a light broke forth, that at night, upon taking away the candle, the whole house seemed to be in a blaze.

3. The *media*, or middle cuttle, with a long, slender, cylindric body; tail finned, pointed, and earinated on each side; two long tentacula; the body almost transparent, green, but convertible into a dirty brown; confirming the remark of Pliny\*, that they change their colour through fear, adapting it, chameleon-like, to that of the place they are in. The eyes are large and smaragdine.

4. The *sepia*, or small cuttle, with a short body, rounded at the bottom, has a round fin on each side and two tentacula. They are taken off Flintshire, but chiefly inhabit the Mediterranean.

5. The *officinalis*, or officinal cuttle, with an ovated body, has fins along the whole of the sides, almost meeting at the bottom; and two long tentacula. The body contains the bone, the cuttle-bone of the shops, which was formerly used as an absorbent. The bones are frequently flung on all our shores; the animal very rarely. The conger eels bite off their arms, or feet; but they grow again, as does the lizard's tail (Plin. ix. 29). They are preyed upon by the plaice. This fish emits (in common with the other species), when frightened or pursued, the black liquor which the ancients supposed darkened the circumambient wave, and concealed it from the enemy.

The endanger'd cuttle thus evades his fears,  
And native hoards of fluid safety bears.  
A pitchy ink peculiar glands supply,  
Whose shades the sharpest beam of light defy.  
Pursu'd, he bids the fable fountains flow,  
And, wrapt in clouds, eludes th' impending foe.  
The fish retreats unseen, while self-born night,  
With pious shade befriends her parent's flight.

The ancients sometimes made use of it instead of ink. Perus mentions the species in his description of the noble student.

*Jam liber, et bicolor possis membrana capillis,  
Inque munus chartæ, nodasque venit arundo.  
Tum querimur, crassus calamo quod pendeat humor;  
Nigra quod infusa venescat sepia lymphæ.  
At length, his book he spreads, his pen he takes;  
His papers here in learned order lays,  
And there his parchment's smoother side displays.  
But oh! what crosses wait on studious men!  
'The cuttle's juice hangs clotted at our pen.  
In all my life such stuff I never knew,  
So gummy thick—Dilute it, it will do.  
Nay, now 'tis water! DRYDEN.*

This animal was esteemed a delicacy by the ancients, and is eaten even at present by the Italians. Rondeletius gives us two receipts for the dressing, which may be continued to this day. Athenæus also leaves us the method of making an antique cuttle-fish sausage; and we learn from Aristotle, that those animals are in highest season when pregnant.

SEPIARIÆ, (from *sepes*, "a hedge"), the name of the 44th order of Linnæus's Fragments of a Natural Method,

Septs  
||  
Septentrio.

Method, consisting of a beautiful collection of woody plants, some of which, from their size and elegance, are very proper furniture for hedges. See BOTANY, p. 467.

SEPS, in zoology, a species of LACERTA.

SEPTARIÆ, in natural history, a large class of fossils, commonly known by the names of *tudus Helmontii* and *waxen veins*.

They are defined to be fossils not inflammable, nor soluble in water; of a moderately firm texture and dusky hue, divided by several septa or thin partitions, and composed of a sperry matter greatly debased by earth; not giving fire with steel; fermenting with acids, and in great part dissolved by them; and calcining in a moderate fire.

Of this class there are two distinct orders of bodies, and under those six genera. The septariæ of the first order are those which are usually found in large masses, of a simple uniform construction, but divided by large septa either into larger and more irregular portions, or into smaller and more equal ones, called *talæ*. The genera of this order are four. 1. Those divided by septa of spar, called *secomia*: 2. Those divided by septa of earthy matter, called *gaiophragmia*: 3. Those divided by septa of the matter of the pyrites, called *pyritercia*: And, 4. Those divided by septa of spar, with an admixture of crystal, called *diagogphragmia*.

Those of the second order are such as are usually found in smaller masses, of a crustated structure, formed by various incrustations round a central nucleus, and divided by very thin septa. Of this order are only two genera. 1. Those with a short roundish nucleus, inclosed within the body of the mass; and, 2. Those with a long nucleus, standing out beyond the ends of the mass.

SEPTAS, in botany: A genus of plants belonging to the order of *Heptagynia*, and the class of *Heptandria*; and in the natural system ranged under the 13th order, *Succulenta*. The calyx is divided into seven parts; the petals are seven; the germens seven: the capsules are also seven, and contain many seeds. There is only one species, the *Capensis*, which is a native of the Cape of Good Hope, is round-leaved, and flowers in August or September.

SEPTEMBER, the ninth month of the year, consisting of only thirty days; it took its name as being the seventh month, reckoning from March, with which the Romans began their year.

SEPTENNIAL, any thing lasting seven years.

SEPTENNIAL Elections. Blackstone, in his Commentaries, Vol. I. p. 189. says, (after observing that the utmost extent of time allowed the same parliament to sit by the stat. 6 W. and M. c. 2. was three years), "But, by the statute 1 Geo. I. st. 2. c. 38. (in order *professedly* to prevent the great and continued expences of frequent elections, and the violent heats and animosities consequent thereupon, and for the peace and security of the government, just then recovering from the late rebellion), this term was prolonged to seven years; and what alone is an instance of the vast authority of parliament, the very same house that was chosen for three years enacted its own continuance for seven."

SEPTENTRIO, in astronomy, a constellation, more usually called *ursa minor*.

In cosmography, the term *septentrio* denotes the same with *north*: and hence septentrional is applied to any thing belonging to the north; as *septentrional signs, parallels, &c.*

Septies,  
Septiz n.

SEPTICS, are those substances which promote putrefaction, chiefly the calcareous earths, magnesia, and testaceous powders. From the many curious experiments made by Sir John Pringle to ascertain the *septic* and *antiseptic* virtues of natural bodies, it appears that there are very few substances of a truly *septic* nature. Those commonly reputed such by authors, as the alkaline and volatile salts, he found to be no wise *septic*. However, he discovered some, where it seemed least likely to find any such quality; these were chalk, common salt, and testaceous powders. He mixed twenty grains of crabs eyes, prepared with six drams of ox's gall, and an equal quantity of water. Into another phial he put an equal quantity of gall and water, but no crabs-eyes. Both these mixtures being placed in the furnace, the putrefaction began much sooner, where the powder was, than in the other phial. On making a like experiment with chalk, its *septic* virtue was found to be much greater than that of the crabs-eyes: nay, what the doctor had never met with before, in a mixture of two drams of flesh, with two ounces of water and thirty grains of prepared chalk, the flesh was resolved into a perfect mucus in a few days.

To try whether the testaceous powders would also dissolve vegetable substances, the doctor mixed them with barley and water, and compared this mixture with another of barley and water alone. After a long maceration by a fire, the plain water was found to swell the barley, and turn mucilaginous and sour; but that with the powder kept the grain to its natural size, and though it softened it, yet made no mucilage, and remained sweet.

Nothing could be more unexpected, than to find sea salt a hastener of putrefaction; but the fact is thus; one dram of salt preserves two drams of fresh beef in two ounces of water, above thirty hours uncorrupted, in a heat equal to that of the human body; or, which is the same thing, this quantity of salt keeps flesh sweet twenty hours longer than pure water; but then half a dram of salt does not preserve it above two hours longer. Twenty-five grains have little or no antiseptic virtue, and ten, fifteen, or even twenty grains, manifestly both hasten and heighten the corruption. The quantity which had the most putrefying quality, was found to be about ten grains to the above proportion of flesh and water.

Many inferences might be drawn from this experiment: one is, that since salt is never taken in aliment beyond the proportion of the corrupting quantities, it would appear that it is subservient to digestion chiefly by its *septic* virtue, that is, by softening and resolving meats; an action very different from what is commonly believed.

It is to be observed, that the above experiments were made with the salt kept for domestic uses. See Pringle's Observ. on the Diseases of the army, p. 34<sup>th</sup>, et seq.

SEPTIZON, or SEPTIZONIUM, in Roman antiquity, a celebrated mausoleum, built by Septimus Severus, in the tenth region of the city of Rome: it was to

Septuaginta,  
Septuaginta.

called from *setem* and *zona*, by reason it consisted of seven stories, each of which was surrounded by a row of columns.

SEPTUAGESIMA, in the calendar, denotes the third Sunday before Lent, or before Quadragesima Sunday: supposed by some to take its name from its being about seventy days before Easter.

SEPTUAGINTI, the name given to a Greek version of the books of the Old Testament, from its being supposed to be the work of seventy-two Jews, who are usually called the *seventy interpreters*, because seventy is a round number.

The history of this version is expressly written by Aristæus, an officer of the guards to Ptolemy Philadelphus, the substance of whose account is as follows: Ptolemy having erected a fine library at Alexandria, which he took care to fill with the most curious and valuable books from all parts of the world, was informed that the Jews had one containing the laws of Moses, and the history of that people; and being desirous of enriching his library with a Greek translation of it, applied to the high priest of the Jews; and to engage him to comply with his request, set at liberty all the Jews whom his father Ptolemy Soter had reduced to slavery. After such a step, he easily obtained what he desired; Eleazar the Jewish high-priest sent back his ambassadors with an exact copy of the Mosaical law, written in letters of gold, and six elders of each tribe, in all seventy-two; who were received with marks of respect by the king, and then conducted into the isle of Pharos, where they were lodged in a house prepared for their reception, and supplied with every thing necessary. They set about the translation without loss of time, and finished it in seventy-two days: and the whole being read in the presence of the king, he admired the profound wisdom of the laws of Moses; and sent back the deputies laden with presents, for themselves, the high-priest, and the temple.

Aristobulus, who was tutor to Ptolemy Physcon, Philo who lived in our Saviour's time, and was contemporary with the apostles, and Josephus, speak of this translation as made by 72 interpreters, by the care of Demetrius Phalereus in the reign of Ptolemy Philadelphus. All the Christian writers, during the first 15 centuries of the Christian era, have admitted this account of the Septuagint as an undoubted fact. But since the reformation, critics have boldly called it in question, because it was attended with circumstances which they think inconsistent, or, at least, improbable. Du Pin has asked, why were 72 interpreters employed, since 12 would have been sufficient? Such an objection is trifling. We may as well ask, why did king James I. employ 54 translators in rendering the Bible into English, since Du Pin thinks 12 would have been sufficient?

1. Prideaux objects, that the Septuagint is not written in the Jewish, but in the Alexandrian, dialect; and could not therefore be the work of natives of Palestine. But these dialects were probably at that time the same, for both Jews and Alexandrians had received the Greek language from the Macedonians about 50 years before.

2. Prideaux farther contends, that all the books of the Old Testament could not be translated at the same time; for they exhibit great difference of style. To this it is

sufficient to reply, that they were the work of 72 men, each of whom had separate portions assigned them.

3. The Dean also urges, that Aristæus, Aristobulus, Philo, and Josephus, all directly tell us, that the law was translated without mentioning any of the other sacred books. But nothing was more common among writers of the Jewish nation than to give this name to the Scriptures as a whole. In the New Testament law is used as synonymous with what we call the Old Testament. Besides, it is expressly said by Aristobulus, in a fragment quoted by Eusebius (*Præp. Evan.* l. 1.), that the whole Sacred Scripture was rightly translated through the means of Demetrius Phalereus, and by the command of Philadelphus. Josephus indeed, says the learned Dean, asserts, in the preface to his Antiquities, that the Jewish interpreters did not translate for Ptolemy the whole Scriptures, but the law only. Here the evidence is contradictory, and we have to determine, whether Aristobulus or Josephus be most worthy of credit. We do not mean, however, to accule either of forgery, but only to inquire which had the best opportunities of knowing the truth. Aristobulus was an Alexandrian Jew, tutor to an Egyptian king, and lived within 100 years after the translation was made, and certainly had access to see it in the royal library. Josephus was a native of Palestine, and lived not until 300 years or more after the translation was made, and many years after it was burnt along with the whole library of Alexandria in the wars of Julius Cæsar. Supposing the veracity of these two writers equal, as we have no proof of the contrary, which of them ought we to consider as the best evidence? Aristobulus surely. Prideaux, indeed, seems doubtful whether there was ever such a man; and Dr Hody supposes that the Commentaries on the five books of Moses, which bear the name of Aristobulus, were a forgery of the second century. To prove the existence of any human being, who lived 2000 years before us, and did not perform such works as no mere man ever performed, is a task which we are not disposed to undertake; and we believe it would not be less difficult to prove that Philo and Josephus existed, than that such a person as Aristobulus did not exist. If the writings which have passed under his name were a forgery of the second century, it is surprising that they should have imposed upon Clemens Alexandrinus, who lived in the same century, and was a man of abilities, learning, and well acquainted with the writings of the ancients. Eusebius, too, in his *Præp. Evan.* quotes the commentaries of Aristobulus. But, continues the learned Dean, "Clemens Alexandrinus is the first author that mentions them. Now, had any such commentaries existed in the time of Philo and Josephus, they would surely have mentioned them. But is the circumstance of its not being quoted by every succeeding author a sufficient reason to disprove the authenticity of any book? Neither Philo nor Josephus undertook to give a list of preceding authors, and it was by no means the uniform practice of these times always to name the authors from whom they derived their information."

4. Prideaux farther contends, that the sum which Ptolemy is said to have given to the interpreters is too great to be credible. If his computation were just, it certainly would be so. He makes it L. 2,000,000

sterling,



Septuagint. Sterling, but other writers \* reduce it to L. 85,421, and some to L. 56,947; neither of which is a sum so very extraordinary in so great and magnificent a prince as Philadelphus, who spent, according to a passage in Athenæus (lib. v.), no less than 10,000 talents on the furniture of one tent; which is six times more than what was spent in the whole of the embassy and translation, which amounted only to 1552 talents.

5. Prideaux says, "that what convicts the whole story of Aristæus of falsity is, that he makes Demetrius Phalereus to be the chief actor in it, and a great favourite of the king; whereas Philadelphus, as soon as his father was dead, cast him into prison, where he soon after died." But it may be replied, that Philadelphus reigned two years jointly with his father Lagus, and it is not said by Hermippus that Demetrius was out of favour with Philadelphus during his father's life. Now, if the Septuagint was translated in the beginning of the reign of Philadelphus, as Eusebius and Jerome think, the difficulty will be removed. Demetrius might have been librarian during the reign of Philadelphus, and yet imprisoned on the death of Lagus. Indeed, as the cause of Philadelphus's displeasure was the advice which Demetrius gave to his father, to prefer the sons of Arsinoë before the son of Berenice, he could scarcely show it till his father's death. The Septuagint translation might therefore be begun while Philadelphus reigned jointly with his father, but not be finished till after his father's death.

6. Besides the objections which have been considered, there is only one that deserves notice. The ancient Christians not only differ from one another concerning the time in which Aristobolus lived, but even contradict themselves in different parts of their works. Sometimes they tell us, he dedicated his book to Ptolemy Philometer, at other times they say, it was addressed to Philadelphus and his father. Sometimes they make him the same person who is mentioned in 2 Maccabees, chap. 1. and sometimes one of the 72 interpreters 152 years before. It is difficult to explain how authors fall into such inconsistencies, but it is probably occasioned by their quoting from memory. This was certainly the practice of almost all the early Christian writers, and sometimes of the apostles themselves. Mistakes were therefore inevitable. Josephus has varied in the circumstances of the same event, in his antiquities and wars of the Jews, probably from the same cause; but we do not hence conclude, that every circumstance of such a relation is entirely false. In the account of the Marquis of Argyle's death in the reign of Charles II. we have a very remarkable contradiction. Lord Clarendon relates, that he was condemned to be hanged, which was performed the same day: on the contrary, Burnet, Woodrow, Heath, Echard, concur in stating, that he was beheaded; and that he was condemned upon the Saturday and executed upon the Monday †. Was any reader of English history ever sceptic enough to raise from hence a question, whether the Marquis of Argyle was executed or not? Yet this ought to be left in uncertainty according to the way of reasoning in which the facts respecting the translation of the Septuagint is attempted to be disproved.

Such are the objections which the learned and ingenious Prideaux has raised against the common account of the Septuagint translation, and such are the answers

which may be given to them. We have chosen to support that opinion which is sanctioned by historical evidence, in preference to the conjectures of modern critics however ingenious; being persuaded, that there are many things recorded in history, which, though perfectly true, yet, from our imperfect knowledge of the concomitant circumstances, may, at a distant period, seem liable to objections. To those who require positive evidence, it may be stated thus. Aristæus, Aristobolus, Philo, and Josephus, assure us, that the law was translated. Taking the law in the most restricted sense, we have at least sufficient authority to assert, that the Pentateuch was rendered into Greek under Ptolemy Philadelphus. Aristobolus affirms, that the whole Scriptures were translated by the 72. Josephus confines their labours to the books of Moses. He therefore who cannot determine to which of the two the greatest respect is due, may suspend his opinion. It is certain, however, that many of the other books were translated before the age of our Saviour; for they are quoted both by him and his apostles: and, perhaps, by a minute examination of ancient authors, in the same way that Dr Lardner has examined the Christian fathers to prove the antiquity of the New Testament, the precise period in which the whole books of the Septuagint were composed might, with considerable accuracy, be ascertained.

For 400 years this translation was in high estimation with the Jews. It was read in their synagogues in preference to the Hebrew; not only in those places where Greek was the common language, but in many synagogues of Jerusalem and Judea. But when they saw that it was equally valued by the Christians, they became jealous of it, and at length, in the second century, Aquila, an apostate Christian, attempted to substitute another Greek translation in its place. In this work he was careful to give the ancient prophecies concerning the Messiah a different turn from the Septuagint, that they might not be applicable to Christ. In the same design he was followed by Symmachus and Theodotion, who also, as St Jerome informs us, wrote out of hatred to Christianity.

In the mean time, the Septuagint, from the ignorance, boldness, and carelessness of transcribers, became full of errors. To correct these, Origen published a new edition in the beginning of the third century, in which he placed the translations of Aquila, Symmachus, and Theodotion. This edition was called *Tetrapla*, the translations being arranged opposite to one another in four columns. He also added one column, containing the Hebrew text in Hebrew letters, and another exhibiting it in Greek. In a second edition he published two additional Greek versions; one of which was found at Nicopolis, and the other at Jericho: this was called the *Hexapla*. By comparing so many translations, Origen endeavoured to form a correct copy of the Scriptures. Where they all agreed, he considered them right. The passages which he found in the LXX, but not in the Hebrew text, he marked with an obelisk: what he found in the Hebrew, but not in the LXX, he marked with an asterisk. St Jerome says, that the additions which Origen made to the LXX, and marked with an asterisk, were taken from Theodotion. From this valuable work of Origen the version of the LXX was transcribed in a separate volume, with the asterisks and obelisks.

*Septuagint.* obelisks for the use of the churches; and from this circumstance the great work itself was neglected and lost.

About the year 300 two new editions of the LXX were published; the one by Hefychius an Egyptian bishop, and the other by Lucian a presbyter of Antioch. But as these authors did not mark with any note of distinction the alterations which they had made, their edition does not possess the advantages of Origen's.

The best edition of the LXX is that of Dr Grabe, which was published in the beginning of the present century. He had access to two MSS, nearly of equal antiquity, the one found in the Vatican library at Rome, the other in the Royal library at St James's, which was presented to Charles I. by Cyril, patriarch of Alexandria, and hence is commonly called the *Alexandrine MS.* Anxious to discover which of these was according to the edition of Origen, Dr Grabe collected the fragments of the Hexapla, and found they agreed with the Alexandrian MS. but not with the Vatican where it differed with the other. Hence he concluded that the Alexandrine MS. was taken from the edition of Origen. By comparing the quotations from scripture in the works of Athanasius and St Cyril (who were patriarchs of Alexandria at the time St Jerome says Hefychius's edition of the LXX was there used) with the Vatican MS. he found they agreed so well that he justly inferred that that MS. was taken from the edition of Hefychius.

This version was in use to the time of our blessed Saviour, and is that out of which most of the citations in the New Testament, from the Old, are taken. It was also the ordinary and canonical translation made use of by the Christian church in the earliest ages; and it still subsists in the churches both of the east and west.

Those who desire a more particular account of the Septuagint translations may consult Hody *de Bibliorum Textibus*, Prideaux's *Connections*, Owen's *Inquiry into the Septuagint Version*, Blair's *Lectures on the Canon*, and Michaelis's *Introduction to the New Testament*, last edition.

*SEPTUAGINT Chronology*, the chronology which is formed from the dates and periods of time mentioned in the Septuagint translation of the Old Testament. It reckons 1500 years more from the creation to Abraham than the Hebrew bible. Dr Kennicot, in the dissertation prefixed to his Hebrew bible, has shown it to be very probable that the chronology of the Hebrew scriptures, since the period just mentioned, was corrupted by the Jews, between the years 175 and 200, and that the chronology of the Septuagint is more agreeable to truth. It is a fact, that during the second and third centuries the Hebrew scriptures were almost entirely in the hands of the Jews, while the Septuagint was confined to the Christians. The Jews had therefore a very favourable opportunity for this corruption. The following is the reason which is given by oriental writers: It being a very ancient tradition, that the Messiah was to come in the sixth chiliad, because he was to come in the last days (founded on a mystical application of the six days creation), the contrivance was to shorten the age of the world from about 5500 to 3760; and thence to prove that Jesus could not be the Messiah. Dr Kennicot adds, that some Hebrew copies having the larger chro-

nology were extant till the time of Eusebius, and some till the year 700.

SEPTUM, in anatomy, an inclosure or partition; a term applied to several parts of the body, which serve to separate one part from another; as, *septum narium*, or partition between the nostrils, &c.

SEPULCHRAL, something belonging to sepulchres or tombs: thus a sepulchral column is a column erected over a tomb, with an inscription on its shaft; and sepulchral lamps, those said to have been found burning in the tombs of several martyrs and others. See LAMP.

SEPULCHRE, a tomb or place destined for the interment of the dead. This term is chiefly used in speaking of the burying-places of the ancients, those of the moderns being usually called *tombs*.

Sepulchres were held sacred and inviolable; and the care taken of them has always been held a religious duty, grounded on the fear of God, and the belief of the soul's immortality. Those who have feared or violated them have been thought odious by all nations, and were always severely punished.

The Egyptians called sepulchres *eternal houses*, in contradistinction to their ordinary houses or palaces, which they called *inns*, on account of their short stay in the one in comparison of their long abode in the other. See TOMB.

*Regular Canons of St SEPULCHRE*, a religious order, formerly instituted at Jerusalem, in honour of the holy sepulchre, or the tomb of Jesus Christ.

Many of these canons were brought from the Holy Land into Europe, particularly into France, by Louis the Younger; into Poland, by Jaxa, a Polish gentleman; and into Flanders, by the counts thereof; many also came into England. This order was, however, suppressed by pope Innocent VIII. who gave its revenues and effects to that of our Lady of Bethlehem: which also becoming extinct, they were bestowed on the knights of St John of Jerusalem. But the suppression did not take effect in Poland, where they still subsist, as also in several provinces of Germany. These canons follow the rule of St Augustine.

*Knights of the Holy SEPULCHRE*, a military order, established in Palestine about the year 1114.

The knights of this order in Flanders chose Philip II. king of Spain, for their master, in 1558, and afterwards his son; but the grand-master of the order of Malta prevailed on the last to resign; and when afterwards the duke of Nevers assumed the same quality in France, the same grand-master, by his interest and credit, procured a like renunciation of him, and a confirmation of the union of this order to that of Malta.

SEQUANI, a people anciently forming a part of Gallia Celtica, but annexed to Belgica by Augustus, separated from the Helvetii by mount Jura, with the Rhine on the east (Strabo), bordering on the Aedui, and Segusiano to the south, and Lingones to the west (Tacitus). Now Franche Comte.

SEQUESTRATION, in common law, is setting aside the thing in controversy from the possession of both the parties that contend for it. In which sense it is either voluntary, as when done by the consent of the parties; or necessary, as where it is done by the

judge, of his own authority, whether the parties will or not.

SEQUESTRATION, in the civil law, is the act of the ordinary, disposing of the goods and chattels of one deceased, whose estate no man will meddle with.

A widow is also said to sequester, when she disclaims having any thing to do with the estate of her deceased husband.

Among the Romanists, in questions of marriage, where the wife complains of impotency in the husband, she is to be sequestered into a convent, or into the hands of matrons, till the process be determined.

SEQUESTRATION is also used for the act of gathering the fruits of a benefice void, to the use of the next incumbent.

Sometimes a benefice is kept under sequestration for many years, when it is of so small value, that no clergyman fit to serve the cure will be at the charge of taking it by institution; in which case the sequestration is committed either to the curate alone, or to the curate and church-wardens jointly. Sometimes the profits of a living in controversy, either by the consent of the parties, or the judge's authority, are sequestered and placed for safety in a third hand, till the suit is determined, a minister being appointed by the judge to serve the cure, and allowed a certain salary out of the profits. Sometimes the profits of a living are sequestered for neglect of duty, for dilapidations, or for satisfying the debts of the incumbent.

SEQUESTRATION, in claustrum, is a commission usually directed to seven persons therein named, empowering them to seize the defendant's personal estate, and the profits of his real, and to detain them, subject to the order of the court. It issues on the return of the serjeant at arms, wherein it is certified, that the defendant had secreted himself.

Sequestrations were first introduced by Sir Nicholas Bacon, lord keeper in the reign of Queen Elizabeth; before which the court found some difficulty in enforcing its process and decrees; and they do not seem to be in the nature of process to bring in the defendant, but only intended to enforce the performance of the court's decree.

A sequestration is also made, in London, upon an action of debt; the course of proceeding in which case is this: The action being entered, the officer goes to the defendant's shop or warehouse, when no person is there, and takes a padlock, and hangs it on the door, uttering these words: "I do sequester this warehouse, and the goods and merchandize therein, of the defendant in this action, to the use of the plaintiff," &c. after which he sets on his seal, and makes a return of the sequestration in the comptex; and four days being passed after the return made, the plaintiff may, at the next court, have judgment to open the shop or warehouse, and to have the goods appraised by two freemen, who are to be sworn at the next court held for that comptex; and then the serjeant puts his hand to the bill of appraisement, and the court grants judgment thereon; but yet the defendant may put in bail before satisfaction, and by that means dissolve the sequestration; and after satisfaction, may put in bail to disprove the debt, &c.

In the time of the civil wars, sequestration was used

for a seizing of the estates of delinquents for the use of the commonwealth.

SEQUESTRATION, in Scots law. See LAW, p. 683.

SEQUIN, a gold coin, struck at Venice, and in several parts of the Grand Signior's dominions. In Turkey it is called *dahab*, or piece of gold, and according to Volney is in value about 6s. 3d. Sterling. It varies, however, considerably in its value in different countries. At Venice it is equal to about 9s. 2d. Sterling.

The Venetian sequins are in great request in Syria, from the aneness of their standard, and the practice they have of employing them for womens trinkets. The fashion of these trinkets does not require much art; the piece of gold is simply pierced, in order to suspend it by a chain, likewise of gold, which flows upon the breast. The more sequins that are attached to this chain, and the greater the number of these chains, the more is a woman thought to be ornamented. This is the favourite luxury, and the emulation of all ranks. Even the female peasants, for want of gold, wear pialtres or smaller pieces; but the women of a certain rank disdain silver; they will accept of nothing but sequins of Venice, or large Spanish pieces, and crusadoes. Some of them wear 200 or 300, as well lying flat, as strung one on another, and hung near the forehead, at the edge of the head-dress. It is a real load: but they do not think they can pay too dearly for the satisfaction of exhibiting this treasure at the public bath, before a crowd of rivals, to awaken whose jealousy constitutes their chief pleasure. The effect of this luxury on commerce, is the withdrawing considerable sums from circulation, which remain dead; besides, that when any of these pieces return into common use, having lost their weight by being pierced, it becomes necessary to weigh them. The practice of weighing money is general in Syria, Egypt, and all Turkey. No piece, however effaced, is refused there; the merchant draws out his scales and weighs it, as in the days of Abraham, when he purchased his sepulchre. In considerable payments, an agent of exchange is sent for, who counts paras by thousands, rejects a great many pieces of false money, and weighs all the sequins, either separately or together.

SERAGLIO, formed from the Persian word *seraw*, or Turkish word *sarai*, which signifies a house, and is commonly used to express the house or palace of a prince. In this sense it is frequently used at Constantinople; the houses of foreign ambassadors are called *seraglios*. But it is commonly used by way of eminence for the palace of the grand signior at Constantinople, where he keeps his court, and where his concubines are lodged, and where the youth are trained up for the chief posts of the empire.

It is a triangle about three Italian miles round, wholly within the city, at the end of the promontory Chrysoceeras, now called the *Seraglio Point*. The buildings run back to the top of the hill, and from thence are gardens that reach to the edge of the sea. It is inclosed with a very high and strong wall, upon which there are several watch towers: and it has many gates, some of which open towards the sea-side, and the rest into the city; but the chief gate is one of the latter, which is constantly guarded by a company of capoochees, or porters; and in the night it is well guarded towards

Sequestration  
||  
Seraglio.

the.

Seraglio.

the sea. The outward appearance is not very beautiful, the architecture being irregular, consisting of separate edifices in the form of pavilions and domes.

The ladies of the seraglio are a collection of beautiful young women, chiefly sent as presents from the provinces and the Greek islands, most of them the children of Christian parents. The brave prince Heraclius hath for some years past abolished the infamous tribute of children of both sexes, which Georgia formerly paid every year to the Porte. The number of women in the harem depends on the taste of the reigning monarch or sultan. Selim had 2000, Achmet had but 300, and the late sultan had nearly 1600. On their admission they are committed to the care of old ladies, taught sewing and embroidery, music, dancing, and other accomplishments, and furnished with the richest clothes and ornaments. They all sleep in separate beds, and between every fifth there is a preceptress. Their chief governess is called *Katon Kiaga*, or governess of the noble young ladies. There is not one servant among them, for they are obliged to wait on one another by rotation; the last that is entered serves her who preceded her and herself. These ladies are scarcely ever suffered to go abroad, except when the grand signior removes from one place to another, when a troop of black eunuchs conveys them to the boats, which are inclosed with lattices and linen curtains; and when they go by land they are put into close chariots, and signals are made at certain distances, to give notice that none approach the roads through which they march. The boats of the harem, which carry the grand signior's wives, are manned with 24 rowers, and have white covered tilts, shut alternately by Venetian blinds. Among the emperor's attendants are a number of mutes, who act and converse by signs with great quickness, and some dwarfs, who are exhibited for the diversion of his majesty.

When he permits the women to walk in the gardens of the seraglio, all people are ordered to retire, and on every side there is a guard of black eunuchs, with sabres in their hands, while others go their rounds in order to hinder any person from seeing them. If, unfortunately, any one is found in the garden, even thro' ignorance or inadvertence, he is undoubtedly killed, and his head brought to the feet of the grand signior, who gives a great reward to the guard for their vigilance. Sometimes the grand signior passes into the gardens to amuse himself when the women are there; and it is then that they make use of their utmost efforts, by dancing, singing, seducing gestures, and amorous blandishments, to ensnare the affections of the monarch. It is not permitted that the monarch should take a virgin to his bed, except during the solemn festivals, and on occasion of some extraordinary rejoicings, or the arrival of some good news. Upon such occasions, if the sultan chooses a new companion to his bed, he enters into the apartment of the women, who are ranged in files by the governesses, to whom he speaks, and intimates the person he likes best: the ceremony of the handkerchief, which the grand signior is said to throw to the girl that he elects, is an idle tale, without any foundation. As soon as the grand signior has chosen the girl that he has destined to be the partner of his bed, all the others follow her to the bath, washing and perfuming her, and dressing her superbly, conducting her singing,

dancing, and rejoicing, to the bed-chamber of the grand signior, who is generally, on such an occasion, already in bed. Scarcely has the new-elected favourite entered the chamber, introduced by the grand eunuch who is upon guard, than she kneels down, and when the sultan calls her, she creeps into bed to him at the foot of the bed, if the sultan does not order her, by especial grace, to approach by the side: after a certain time, upon a signal given by the sultan, the governess of the girls, with all her suite, enter the apartment, and take her back again, conducting her with the same ceremony to the women's apartments; and if by good fortune she becomes pregnant, and is delivered of a boy, she is called *afaki sultaness*, that is to say, sultaness-mother; for the first son she has the honour to be crowned, and she has the liberty of forming her court. Eunuchs are also assigned for her guard, and for her particular service. No other ladies, though delivered of boys, are either crowned or maintained with such costly distinction as the first; however, they have their service apart, and handsome appointments. After the death of the sultan, the mothers of the male children are shut up in the old seraglio, from whence they can never come out any more, unless any of their sons ascend the throne. Baron de Tott informs us, that the female slave who becomes the mother of a sultan, and lives long enough to see her son mount the throne, is the only woman who at that period alone acquires the distinction of *sultan-mother*; she is till then in the interior of her prison with her son. The title of *bache kudan*, principal woman, is the first dignity of the grand signior's harem; and she hath a larger allowance than those who have the title of second, third, and fourth woman, which are the four free women the Koran allows.

This is a description of the grand signior's seraglio: we shall now add an account of the seraglio or *harem*, as it is often called, of the emperor of Morocco, from the very interesting tour of Mr Lempricre. This gentleman being a surgeon by profession, was admitted into the harem to prescribe for some of the ladies who were indisposed, and was therefore enabled to give a particular account of this female prison, and, what is still more curious, of the manners and behaviour of its inhabitants.

The harem forms a part of the palace. The apartments, which are all on the ground floor, are square, very lofty, and four of them inclose a spacious square court, into which they open by means of large folding doors. In the centre of these courts, which are floored with blue and white chequered tiling, is a fountain, supplied by pipes from a large reservoir on the outside of the palace, which serves for the frequent ablutions recommended by the Mahometan religion, as well as for other purposes. The whole of the harem consists of about twelve of these square courts, communicating with each other by narrow passages, which afford a free access from one part of it to another, and of which all the women are allowed to avail themselves.

The apartments are ornamented on the outside with beautiful carved wood. In the inside most of the rooms are hung with rich damask of various colours; the floors are covered with beautiful carpets, and there are mattresses disposed at different distances, for the purposes of sitting and sleeping.

*eraglio.* Besides these, the apartments are furnished at each extremity with an elegant European mahogany bedstead, hung with damask, having on it several mattresses placed one over the other, which are covered with various coloured silks; but these beds are merely placed there to ornament the room. In all the apartments, without exception, the ceiling is wood, carved and painted. The principal ornaments in some were large and valuable looking-glasses, hung on different parts of the walls. In others, clocks and watches of different sizes, in glass cases, were disposed in the same manner.

The sultana Lalla Batoom and another favourite were indulged with a whole square to themselves; but the concubines were only each allowed a single room.

Each female had a separate daily allowance from the emperor, proportioned to the estimation in which they were held by him. The late emperor's allowance was very trifling: Lalla Douyaw, the favourite sultana, had very little more than half-a-crown English a-day, and the others less in proportion. It must be allowed, that the emperor made them occasional presents of money, dress, and trinkets; but this could never be sufficient to support the number of domestics and other expences they must incur. Their greatest dependence therefore was on the presents they received from those Europeans and Moors who visited the court, and who employed their influence in obtaining some particular favour from the emperor. This was the most successful mode that could be adopted. When Mr Lempriere was at Morocco, a Jew, desirous of obtaining a very advantageous favour from the emperor, for which he had been a long time unsuccessfully soliciting, sent to all the principal ladies of the harem presents of pearls to a very large amount; the consequence was, that they all went in a body to the emperor, and immediately obtained the wished-for concession.

The ladies separately furnish their own rooms, hire their own domestics, and, in fact, do what they please in the harem, but are not permitted to go out without an express order from the emperor, who very seldom grants them that favour, except when they are to be removed from one palace to another. In that case, a party of soldiers is dispatched a little distance before them, to disperse the male passengers in particular, and to prevent the possibility of their being seen. This previous step being taken, a piece of linen cloth is tied round the lower part of the face, and afterwards these miserable females cover themselves entirely with their haicks, and either mount mules, which they ride like men, or, what is more usual, are put into a square carriage or litter, constructed for this purpose, which by its lattice-work allows them to see without being seen. In this manner they set off, under the charge of a guard of black eunuchs. This journey, and sometimes a walk within the bounds of the palace, with which they are, however, seldom indulged, is the only exercise they are permitted to take.

The late emperor's harem consisted of between 60 and 100 females, besides their domestics and slaves, which were very numerous. Many of the concubines were Moorish women, who had been presented to the emperor, as the Moors consider it an honour to have their daughters in the harem; several were European slaves, who had either been made captives, or purchased by the emperor; and some were Negroes.

VOL. XVII. Part I.

In this group the Europeans, or their descendants, had by far the greatest claim to the character of handsome. There was one in particular, who was a native of Spain, and taken into the harem at about the same age as Lalla Douyaw, who was indeed a perfect beauty. Nor was this lady quite singular in that respect, for many others were almost equally handsome.

The eunuchs, who have the entire charge of the women, and who in fact live always among them, are the children of Negro slaves. They are generally either very short and fat, or else tall, deformed, and lame. Their voices have that particular tone which is observable in youths who are just arriving at manhood; and their persons altogether afford a disgusting image of weakness and effeminacy.

The same gentleman gives us a very curious account of the manners and ignorance of these immured females, from his own observation, when visiting the prince's harem. "Attended by an eunuch (says he), after passing the gate of the harem, which is always locked, and under the care of a guard of eunuchs, we entered a narrow and dark passage, which soon brought us to the court, into which the women's chambers open. We here saw numbers of both black and white women and children; some concubines, some slaves, and others hired domestics.

"Upon their observing the unusual figure of an European, the whole multitude in a body surrounded me, and expressed the utmost astonishment at my dress and appearance. Some stood motionless, with their hands lifted up, their eyes fixed, and their mouths open, in the usual attitude of wonder and surprise. Some burst into immoderate fits of laughter; while others again came up, and with uncommon attention eyed me from head to foot. The parts of my dress which seemed most to attract their notice were my buckles, buttons, and stockings; for neither men nor women in this country wear any thing of the kind. With respect to the curl of my hair, they seemed utterly at a loss in what view to consider it; but the powder which I wore they conceived to be employed for the purpose of destroying vermin. Most of the children, when they saw me, ran away in the most perfect consternation; and on the whole, I appeared as singular an animal, and I dare say had the honour of exciting as much curiosity and attention, as a lion or a man-tiger just imported from abroad, and introduced into a country town in England on a market-day. Every time I visited the harem, I was surrounded and laughed at by this curious mob, who, on my entering the gate, followed me close to the very chamber to which I was proceeding, and on my return universally escorted me out.

"The greatest part of the women were uncommonly fat and unwieldy; had black and full eyes, round faces, with small noses. They were of different complexions; some very fair, some fallow, and others again perfect Negroes.

"One of my new patients being ready to receive me, I was desired to walk into her room; where, to my great surprise, I saw nothing but a curtain drawn quite across the apartment, similar to that of a theatre which separates the stage from the audience. A female domestic brought a very low stool, placed it near the curtain, and told me I was to sit down there, and feel her mistress's pulse.

O o

"The

Seraglio.

"The lady, who had by this time summoned up courage to speak, introduced her hand from the bottom of the curtain, and desired me to inform her of all her complaints, which she conceived I might perfectly do by merely feeling the pulse. It was in vain to ask her where her pain was seated, whether in her stomach, head, or back; the only answer I could procure was a request to feel the pulse of the other hand, and then point out the seat of the disease, and the nature of the pain.

"Having neither satisfied my curiosity by exhibiting her face, nor made me acquainted with the nature of her complaint, I was under the necessity of informing her in positive terms, that to understand the disease, it was absolutely necessary to see the tongue as well as to feel the pulse; and that without it I could do nothing for her. My eloquence, or rather that of my Jewish interpreter, was, however, for a long time exerted in vain; and I am persuaded she would have dismissed me without any further inquiry, had not her invention supplied her with a happy expedient to remove her embarrassment. She contrived at last to cut a hole through the curtain, through which she extruded her tongue, and thus complied with my injunction as far as it was necessary in a medical view, but most effectually disappointed my curiosity.

"I was afterwards ordered to look at another of the prince's wives, who was affected with a serophulous swelling in her neck. This lady was, in the same manner as the other, at first excluded from my sight; but as she was obliged to show me her complaint, I had an opportunity of seeing her face, and observed it to be very handsome."

It is curious to observe the strange and childish notions of persons who have been totally secluded from the world. All the ladies of the harem expected that our author should have instantly discovered their complaints upon feeling the pulse, and that he could cure every disease instantaneously. He found them proud and vain of their persons, and extremely ignorant. "Among many ridiculous questions, they asked my interpreter (says Mr Lempriere) if I could read and write; upon being answered in the affirmative, they expressed the utmost surprise and admiration at the abilities of the Christians. There was not one among them who could do either; these rudiments of learning are indeed only the lot of a few of their men, who on that account are named *Talbs*, or explainers of the Mahometan law."

It is melancholy to reflect on the situation of these unfortunate women. Being considered as the mere instruments of pleasure, no attention is paid to the improvement of their minds. They have no employment to occupy their time. Their needle-work is performed by Jewesses; their food is dressed, and their chambers taken care of, by slaves and domestics. They have no amusement but a rude and barbarous kind of melancholy music, without melody, variety, or taste; and conversation with one another, which must indeed be very confined, uniform, and inanimate, as they never see a new object. Excluded from the enjoyment of fresh air and exercise, so necessary for the support of health and life; deprived of all society but that of their fellow sufferers, a society to which most of them would prefer solitude itself; they are only to be considered as

the most abject of slaves—slaves to the vices and caprice of a licentious tyrant, who exacts even from his wives themselves a degree of submission and respect which borders upon idolatry, and which God and nature never meant should be paid to a mortal.

SERAI, a building on the high-road, or in large cities in India, erected for the accommodation of travellers.

SERAPH, or SERAPHIM, a spirit of the highest rank in the hierarchy of angels; who are thus called from their being supposed to be most inflamed with divine love, by their nearer and more immediate attendance at the throne of God, and to communicate their fervour to the remoter and inferior orders. See AN-GEL.

SERAPHIC, burning or inflamed with love or zeal, like a seraphim: thus St Bonaventure is called the *seraphic doctor*, from his abundant zeal and fervour.

SERAPIAS, in botany: A genus of plants belonging to the order of diandria, and to the class of gynandria; and in the natural system arranged under the 7th order, *Orchidee*. The nectarium is egg-shaped and gibbous, with an egg-shaped lip. The species, according to Linnæus, are ten. 1. *Latifolia*; 2. *Longifolia*; 3. *Grandiflora*, or *ensifolia*; 4. *Lancifolia*; 5. *Rubra*; 6. *Lingua*; 7. *Cordigera*; 8. *Capensis*; 9. *Erecta*; 10. *Falcata*. The three first are natives of Britain.

1. The *Latifolia*, or broad-leaved helleborine, is distinguished by fibrous bulbs, by ovate stem-clasping leaves, and pendulous flowers. The stalk is erect, about a cubit high, and furnished with six or eight nervous oval leaves; the spike is about six inches long; the three upper petals are of a green colour, and of an oval acute form; the lateral ones are a little shorter, and of a white colour, with a little tinge of green. 2. The *Palustris*, or marsh helleborine, grows in rough boggy pastures and marshes, and flowers in July. It is distinguished by fibrous bulbs, sword-shaped sessile leaves, pendulous flowers; and the lip of the nectarium is obtuse, somewhat serrated, and longer than the petals. The flowers grow to the number of 15 or 20 in a loose spike. The three exterior petals are green mixed with red; the lateral ones are white with a red blush; and the nectarium is marked with red lines and yellow tuberculous spots. 3. The *Grandiflora*, or white-flowered helleborine, grows in woods, and flowers in June. Its characteristics are, fibrous bulbs, sword-shaped leaves, erect flowers; and the lip of the nectarium is obtuse and shorter than the petals. The flowers are large and erect, and consisting of six or eight in a thin spike; the petals are all white, and connive together; the lip of the nectarium is inclosed within the petals, is white and streaked with three yellow prominent lines.

SERAPION, a physician of Alexandria. He and Philinus of the isle of Cos were both scholars of Herophilus, and were founders of the empiric sect; which happened about 287 B. C.

SERAPIS, in mythology, an Egyptian deity, who was worshipped under various names and attributes, as the tutelary god of Egypt in general, and as the patron of several of their principal cities. Tacitus informs us, that he was worshipped as a kind of universal deity that represented Esculapius, Osiris, Jupiter, and Pluto; and he was sometimes taken for Jupiter Ammon, the Sun, and Neptune; and the honours that were rendered to

Serap  
II  
Serapis

**Serapis** || **Serap. e.**  
him at Alexandria were more solemn and extraordinary than those of any other place.

**Serap. e.**  
**Tac. Hist.** Plutarch and Clemens of Alexandria, as well as Tacitus, inform us, that while the first Ptolemy was employed in fortifying Alexandria with walls, adorning it with temples and stately buildings, there appeared to him in his sleep a young man of extraordinary beauty, of a stature more than human, admonishing him to dispatch into Pontus some of his most trusty friends to bring from thence his statue: he assured him, that the city and kingdom which possessed it should prove happy, glorious, and powerful. The young man having thus spoke, disappeared, mounting up into heaven in a blaze of fire.

Ptolemy discovered his vision to the priests; but finding them ignorant of Pontus, he had recourse to an Athenian, who informed him that near Sinope, a city of Pontus, there was a temple much resorted to by the natives, which was consecrated to Pluto, where he had a statue, near which stood that of a woman. Ptolemy, neglecting the injunctions of the apparition, it again appeared to him in a menacing attitude; and the king immediately dispatched ambassadors to the Serapian monarch, loaded with presents. The king of Sinope consented; but his subjects opposed the removal of the statue. The god, however, of his own accord, as we are informed, conveyed himself to the ambassador's ship, and in three days landed in Alexandria. The statue of Serapis was erected in one of the suburbs of the city, where a magnificent temple was afterwards reared.

The statue of Serapis, according to Macrobius, was of a human form, with a basket or bushel on his head, signifying plenty; his right hand leaned on the head of a serpent, whose body was wound round a figure with three heads, of a dog, a lion, and a wolf; in his left hand he held a measure of a cubit length, as it were to take the height of the waters of the Nile. The figure of Serapis is found on many ancient medals.

The famous temple of Serapis at Alexandria was destroyed by order of Theodosius; and the celebrated statue of this deity was broken in pieces, and its limbs carried first in triumph by the Christians through the city, and then thrown into a fierce fire, kindled for that purpose in the amphitheatre. As the Egyptians ascribed the overflowing of the Nile, to which was owing the fertility of their country, to the benign influence of their god Serapis, they concluded, that now he was destroyed, the river would no longer overflow, and that a general famine would ensue; but when they observed, on the contrary, that the Nile swelled to a greater height than had been known in the memory of man, and thereby produced an immense plenty of all kinds of provisions, many of the pagans renouncing the worship of idols, adored the God of the Christians.

**SERENA GUTTA**, the same as *amaurefsi*. See **MEDICINE**, n° 360.

**SERENADE**, a kind of concert given in the night by a lover to his mistress, under her window. These sometimes only consist of instrumental music, but at other times voices are added; the music and songs composed for these occasions are also called *serenades*.

**SERENE**, a title of honour given to several princes and to the principal magistrates of republics. The king of Britain, the republic and doge of Venice, and the children of the king of Spain, are called *most serene*;

and when the pope or the sacred college write to the emperor, to kings, or to the doge, they give them no other title. In like manner, the emperor gives no other title to any king, except to the king of France.

**SERENUS** (Sammonicus), a celebrated physician in the reigns of the emperor Severus and Caracalla, in and about the year 200. He wrote several treatises on history and the works of nature; but there is only one of them extant, which is a very indifferent poem on the Remedies of Diseases. He was murdered at a festival by the order of Caracalla. He had a library that contained 62,000 volumes, which Quintus Serenus Sammonicus his son gave to Gordian the Younger, to whom he was preceptor.

**SERES** (Ptolemy); a people of the Farther Asia; bounded on the west by Seythia extra Imaum; on the north and east, by Terra Incognita; and on the south, by India extra Gangem. According to these limits, their country answers nearly to Cathoy or North China. Other authors vary greatly in placing them, though the generality agree in placing them far to the east. Mela places them between the Indi and Scythia; and perhaps beyond the Indi, if we distinguish the Sinae from them. The ancients commend them for their cotton manufactures, different from the produce of the bombyces or silk-worms, called *seres* by the Greeks; whence *serica* "silk."

**SERGE**, a woollen quilted stuff, manufactured on a loom with four treddles, after the manner of rateens, and other stuffs that have the whale. The goodness of serges is known by the quilting, as that of cloths by the spinning. Of serges there are various kinds, denominated either from the different qualities thereof, or from the places where they are wrought. The most considerable is the London serge, now highly valued abroad, particularly in France, where a manufacture is carried on with considerable success, under the title of *serge façon de Londres*.

The method of making the London serge we shall now describe: For wool, the longest is chosen for the warp, and the shortest for the woof. Before either kind is used, it is first scoured, by putting it in a copper of liquor, somewhat more than lukewarm, composed of three parts of fair water and one of urine. After having stayed long enough therein for the liquor to dissolve, and take off the grease, &c. it is stirred briskly about with a wooden peel; taken out of the liquor, drained, and washed in a running water, dried in the shade, beaten with sticks on a wooden rack to drive out the coarser dust and filth, and then picked clean with the hands. Thus far prepared, it is greased with oil of olives, and the longest part, destined for the warp, is combed with large combs, heated in a little furnace for the purpose. To clear off the oil again, the wool is put in a liquor composed of hot water, with soap melted therein: whence being taken out, wrung, and dried, it is spun on the wheel.

As to the shorter wool, intended for the woof, it is only carded on the knee with small cards, and then spun on the wheel, without being scoured of its oil. It must be remarked, that the thread for the warp is always to be spun much finer, and better twisted than that of the woof. The wool both for the warp and the woof being spun, and the thread divided into skains, that of the woof is put on spools (unless it have been

**Serenus** || **Serap. e.**

Sergeant.

(spun upon them) fit for the cavity or eye of the shuttle; and that for the warp is wound on a kind of wooden bobbins to fit it for warping. When warped, it is stiffened with a kind of size, whereof that made of the shreds of parchment is held the best; and when dry is put on the loom.

When mounted on the loom, the workman raising and lowering the threads (which are passed through a reed), by means of four trestles placed underneath the loom, which he makes to act transversely, equally, and alternately, one after another, with his feet, in proportion as the threads are raised and lowered, throws the shuttle across from one side to the other; and each time that the shuttle is thrown, and the thread of the woof is crossed between those of the warp, strikes it with the frame to which the reed is fastened, through those teeth the threads of the warp pass; and this stroke he repeats twice or thrice, or even more, till he judges the crossing of the serge sufficiently close: thus he proceeds till the warp is all filled with woof.

The serge now taken off the loom is carried to the fuller, who scours it in the trough of his mill with a kind of fat earth, called *fuller's earth*, first purged of all stones and filth. After three or four hours scouring, the fuller's earth is washed out in fair water, brought by little and little into the trough, out of which it is taken when all the earth is cleared; then, with a kind of iron pincers or plyers, they pull off all the knots, ends, straws, &c. sticking out on the surface on either side; and then returning it into the fulling trough, where it is worked with water somewhat more than lukewarm, with soap dissolved therein for near two hours: it is then washed out till such time as the water becomes quite clear, and there be no signs of soap left; then it is taken out of the trough, the knots, &c. again pulled off, and then put on the tenter to dry, taking care as fast as it dries to stretch it out both in length and breadth till it be brought to its just dimensions. When well dried, it is taken off the tenter, and dyed, shorn, and pressed.

**SERGEANT**, or **SERJEANT at Law**, or *of the Coif*, is the highest degree taken at the common law, as that of Doctor is of the civil law; and as these are supposed to be the most learned and experienced in the practice of the courts, there is one court appointed for them to plead in by themselves, which is the common pleas, where the common law of England is most strictly observed: but they are not restricted from pleading in any other court, where the judges, who cannot have that honour till they have taken the degree of serjeant at law, call them *brothers*.

**SERGEANT at Arms**, or *Mace*, an officer appointed to attend the person of the king; to arrest traitors, and such persons of quality as offend; and to attend the lord high steward, when sitting in judgment on a traitor.

Of these, by statute 13 Rich. II. cap. 6. there are not to be above 30 in the realm. There are now nine at court at *L. 100 per annum* salary each; they are called the *king's sergeants at arms*, to distinguish them from others: they are created with great ceremony, the person kneeling before the king, his majesty lays the mace on his right shoulder, and says, *Rise up, serjeant at arms, and esquire for ever*. They have, besides, a patent for the office, which they hold for life.

They have their attendance in the presence-chamber,

where the band of gentlemen-pensioners wait; and, receiving the king at the door, they carry the maces before him to the chapel door, whilst the band of pensioners stand foremost, and make a lane for the king, as they also do when the king goes to the house of lords.

There are four other sergeants at arms, created in the same manner; one, who attends the lord chancellor; a second, the lord treasurer; a third, the speaker of the house of commons; and a fourth, the lord mayor of London on solemn occasions.

They have a considerable share of the fees of honour, and travelling charges allowed them when in waiting, *viz.* five shillings per day when the court is within ten miles of London, and ten shillings when twenty miles from London. The places are in the lord chamberlain's gift.

There are also sergeants of the mace of an inferior kind, who attend the mayor or other head officer of a corporation.

**COMMON SERGEANT**, an officer in the city of London, who attends the lord mayor and court of aldermen on court days, and is in council with them on all occasions, within and without the precincts or liberties of the city. He is to take care of orphans estates, either by taking account of them, or to sign their indentures, before their passing the lord mayor and court of aldermen: and he was likewise to let and manage the orphans estates, according to his judgment to their best advantage. See **RECORDER**.

**SERGEANT**, in war, is an uncommissioned officer in a company of foot or troop of dragoons, armed with an halbert, and appointed to see discipline observed, to teach the soldiers the exercise of their arms, to order, straiten, and form their ranks, files, &c. He receives the orders from the adjutant, which he communicates to his officers. Each company generally has two sergeants.

**SERGEANTY** (*Serjeantia*), signifies, in law, a service that cannot be due by a tenant to any lord but the king; and this is either *grand serjeanty*, or *petit*. The first is a tenure by which the one holds his lands of the king by such services as he ought to do in person to the king at his coronation; and may also concern matters military, or services of honour in peace; as to be the king's butler, carver, &c. *Petit serjeanty* is where a man holds lands of the king to furnish him yearly with some small thing towards his wars; and in effect payable as rent. Though all tenures are turned into *socage* by the 12 Car. II. cap. 24. yet the honorary services of grand serjeanty still remain, being therein excepted. See **KNIGHT-SERVICE**.

**SERIES**, in general, denotes a continual succession of things in the same order, and having the same relation or connection with each other: in this sense we say, a series of emperors, kings, bishops, &c.

In natural history, a series is used for an order or subdivision of some class of natural bodies; comprehending all such as are distinguished from the other bodies of that class, by certain characters which they possess in common, and which the rest of the bodies of that class have not.

**SERIES**, in arithmetic and algebra, a rank or number of terms in succession, increasing or diminishing in some certain ratio or proportion. There are several kinds of series; as *arithmetical*, *geometrical*, *infinite*, &c. Various kinds of series. The

Sergeant Series.

Series.

Various kinds of series.

The



Series. The two first of these are, however, more generally known or distinguished by the names of *arithmetical* and *geometrical progression*. These series have already been explained and illustrated in the article ALGEBRA, particularly the two first: it therefore only remains, in this place, to add a little to what has already been done to the last of these; namely,

INFINITE SERIES,

3 Is formed by dividing the numerator of a fraction by its denominator, that denominator being a compound quantity; or by extracting the root of a surd.

4 An infinite series is either *converging* or *diverging*. A converging series is that in which the magnitude of the several terms gradually diminish; and a diverging series is that in which the successive terms increase in magnitude.

5 The law of an infinite series is the order in which the terms are observed to proceed. This law is often easily discovered from a few of the first terms of the series; and then the series may be continued as far as may be thought necessary, without any farther division or evolution.

6 An infinite series, as has already been observed, is obtained by division or evolution; but as that method is very tedious, various other methods have been proposed for performing the same in a more easy manner; as, by assuming a series with unknown coefficients, by the binomial theorem, &c.

I. Of the Method of Series by Division and Evolution.

RULE.

6 Let the division or evolution of the given fraction, which is to be converted into an infinite series, be performed as in Chapters I. and IV. of our article ALGEBRA, and the required series will be obtained.

EXAMPLES.

1. Convert the fraction  $\frac{1}{1-x}$  into an infinite series?

$$\begin{array}{r} (1-x)1 \quad (1+x+x^2+x^3+x^4, \&c. \\ \hline 1-x \\ \quad x \\ \quad \quad x-x^2 \\ \quad \quad \quad \quad x^2 \\ \quad \quad \quad \quad \quad x^2-x^3 \\ \quad \quad \quad \quad \quad \quad \quad x^3 \\ \quad \quad \quad \quad \quad \quad \quad \quad x^3-x^4 \\ \quad \quad \quad \quad \quad \quad \quad \quad \quad \quad x^4 \\ \quad \quad \quad \quad \quad \quad \quad \quad \quad \quad \quad x^4-x^5 \\ \quad \quad \quad \quad \quad \quad \quad \quad \quad \quad \quad \quad \quad x^5 \end{array}$$

Hence the fraction  $\frac{1}{1-x} = 1 + x + x^2 + x^3 + x^4, \&c.$

From inspection of the terms of this series, it appears that each term is formed by multiplying the preceding term by  $x$ ; and hence it may be continued as far as may be thought necessary without continuing the division.

2. Let the fraction  $\frac{ay}{1+x}$  be converted into an infinite series?

$$\begin{array}{r} (ay-ayx+ayx^2-ayx^3+ayx^4, \&c. \\ ay+ayx \\ \hline \quad -ayx \\ \quad \quad -ayx-ayx^2 \\ \quad \quad \quad \quad ayx^2 \\ \quad \quad \quad \quad \quad ayx^2+ayx^3 \\ \quad \quad \quad \quad \quad \quad \quad -ayx^3 \\ \quad \quad \quad \quad \quad \quad \quad \quad -ayx^3-ayx^4 \\ \quad \quad \quad \quad \quad \quad \quad \quad \quad \quad ayx^4 \\ \quad \quad \quad \quad \quad \quad \quad \quad \quad \quad \quad ayx^4+ayx^5 \\ \quad \quad \quad \quad \quad \quad \quad \quad \quad \quad \quad \quad \quad -ayx^5 \end{array}$$

Hence  $\frac{ay}{1+x} = ay \times \frac{1}{1-x-x^2-x^3-x^4, \&c.}$  and the law of the series is obvious.

3. Reduce the fraction  $\frac{m^2+x^2}{m+x}$  into an infinite series?

$$\begin{array}{r} (m+x)m^2+x^2 \quad (m-x+\frac{2x^2}{m}-\frac{2x^3}{m^2}+\frac{2x^4}{m^3}, \&c. \\ \hline m^2+mx \\ \quad \quad -mx+x^2 \\ \quad \quad \quad \quad -mx-x \\ \quad \quad \quad \quad \quad \quad \quad 2x^2 \\ \quad \quad \quad \quad \quad \quad \quad \quad 2x^2+\frac{2x^3}{m} \\ \quad \quad \quad \quad \quad \quad \quad \quad \quad \quad -2x^3 \\ \quad \quad \quad \quad \quad \quad \quad \quad \quad \quad \quad \quad \quad \frac{2x^3}{m} \\ \quad \quad \quad \quad \quad \quad \quad \quad \quad \quad \quad \quad \quad \quad -\frac{2x^3}{m}-\frac{2x^4}{m^2} \\ \quad \frac{2x^4}{m^2}, \&c. \end{array}$$

Hence  $\frac{m^2+x^2}{m+x} = m-x + \frac{2x}{m} \times \frac{1}{1-\frac{x}{m}+\frac{x^2}{m^2}}, \&c.$  and the law of the series is evident.

4. Convert the quantity  $\frac{a^2}{a^2+2ay+y^2}$  into an infinite series?

$$\begin{array}{r} (a^2+2ay+y^2)a^2 \quad (1-\frac{2y}{a}+\frac{3y^2}{a^2}-\frac{4y^3}{a^3}, \&c.) \\ \hline a^2+2ay+y^2 \\ \quad \quad -2ay-y^2 \\ \quad \quad \quad \quad -2ay-4y^2-\frac{2y^3}{a} \\ \quad \quad \quad \quad \quad \quad \quad 3y^2+\frac{2y^3}{a} \\ \quad \quad \quad \quad \quad \quad \quad \quad 3y^2+\frac{6y^3}{a}+\frac{3y^4}{a^2} \\ \quad \quad \quad \quad \quad \quad \quad \quad \quad \quad -\frac{4y^3}{a}-\frac{3y^4}{a^2} \end{array}$$

Whence

Series. Whence  $\frac{a^2}{a^2+2ay+y^2} = 1 - \frac{2y}{a} + \frac{3y^2}{a^2} - \frac{4y^3}{a^3}$ , &c.; and each term is found by multiplying the preceding by  $\frac{y}{a}$  and increasing the coefficient by unity.

Andevolution. 7. Let  $\sqrt{a^2+x^2}$  be converted into an infinite series?

$$\begin{aligned} & \left( \frac{a^2+x^2}{a^2} \right) a + \frac{x^2}{2a} - \frac{x^4}{8a^3} + \frac{x^6}{16a^5} - \frac{x^8}{128a^7} \\ & \frac{2a + \frac{x^2}{2a}}{a^2} \left( \frac{x^2}{2a} + \frac{x^4}{4a^3} \right) \\ & \frac{2a + \frac{x^2}{a} - \frac{x^4}{8a^3}}{a^2} \left( \frac{x^2}{4a^2} + \frac{x^4}{8a^4} + \frac{x^6}{64a^6} \right) \\ & \frac{2a + \frac{x^2}{a} - \frac{x^4}{4a^3} + \frac{x^6}{16a^5}}{a^2} \left( \frac{x^2}{8a^4} + \frac{x^4}{16a^6} - \frac{x^6}{64a^8} + \frac{x^8}{256a^{10}} \right) \\ & \frac{2a + \frac{x^2}{a} - \frac{x^4}{4a^3} + \frac{x^6}{16a^5} - \frac{x^8}{64a^7} + \frac{x^{10}}{64a^9} - \frac{x^{12}}{256a^{11}}}{a^2} \end{aligned}$$

Hence the square root of  $a^2+x^2 = a + \frac{x^2}{2a} - \frac{x^4}{8a^3} + \frac{x^6}{16a^5} - \frac{x^8}{128a^7}$ , &c.

In continuing the operation, those terms may be neglected whose dimensions exceed those of the last term to which the root is to be continued.

II. Of the Method of Series by assuming a Series with unknown Coefficients.

8. By means of an assumed series; RULE. Assume a series with unknown coefficients to represent that required. Let this series be multiplied or involved, according to the nature of the question; and the quantities of the same dimension being put equal to each other, the coefficients will be determined; and hence the required series will be known.

EXAMPLES. I. Let  $\frac{1}{a-x}$  be converted into an infinite series? Assume  $\frac{1}{a-x} = A + Bx + Cx^2 + Dx^3 + Ex^4$ , &c.

Then this assumed series, multiplied by  $a-x$ , gives  $1 = aA + aBx + aCx^2 + aDx^3 + aEx^4$ , &c.  $-Ax - Bx^2 - Cx^3 - Dx^4$ , &c.

Now, by equating the coefficients of the same powers of  $x$ , we have  $aA = 1, aB - A = 0, aC - B = 0, aD - C = 0, aE - D = 0$ , &c. Hence  $A = \frac{1}{a}, B = \frac{A}{a} = \frac{1}{a^2}, C = \frac{B}{a} = \frac{1}{a^3}, D = \frac{C}{a} = \frac{1}{a^4}, E = \frac{D}{a} = \frac{1}{a^5}$ , &c.; whence, by substitution, we have  $\frac{1}{a-x} = \frac{1}{a} + \frac{x}{a^2} + \frac{x^2}{a^3} + \frac{x^3}{a^4} + \frac{x^4}{a^5}$ , &c.

2. Convert the quantity  $\frac{c^2}{c^2+2cy-y^2}$  into an infinite series?

Let the assumed series be  $A + By + Cy^2 + Dy^3$ , &c. which multiplied by  $c^2 + 2cy - y^2$ , gives  $c^2 = c^2A + c^2By + c^2Cy^2 + c^2Dy^3$ , &c.  $+ 2cAy + 2cBy^2 + 2cCy^3 - Ay^2 - By^3$ .

Now, by equating the coefficients of the homologous terms, we have  $c^2 = c^2A, c^2B + 2cA = 0, c^2C + 2cB - A = 0, c^2D + 2cC - B = 0$ , &c.; whence  $A = 1, B = -\frac{2A}{c} = -\frac{2}{c}, C = \frac{A - 2cB}{c^2} = \frac{1 + 4}{c^2} = \frac{5}{c^2}, D = \frac{B - 2cC}{c^2} = \frac{-2 - 10}{c^2} = -\frac{12}{c^2}$ , &c.; whence  $\frac{c^2}{c^2+2cy-y^2} = 1 - \frac{2y}{c} + \frac{5y^2}{c^2} - \frac{12y^3}{c^3}$ , &c.

3. Required the square root of  $a^2 - x^2$ ?

Let  $\sqrt{a^2 - x^2} = A + Bx^2 + Cx^4 + Dx^6$ , &c. which being squared gives  $a^2 - x^2 = A^2 + 2ABx^2 + B^2x^4 + 2ADx^6$ , &c.  $+ 2ACx^4 + 2BCx^6$ .

Hence  $A^2 = a^2, 2AB + 1 = 0, B^2 + 2AC = 0, 2AD + 2BC = 0$ , &c. Then  $A = a, B = -\frac{1}{2a}, C = -\frac{1}{2A} = -\frac{1}{2a}, D = -\frac{BC}{A} = \frac{1}{16a^3}$ , &c.; whence  $\sqrt{a^2 - x^2} = a - \frac{x^2}{2a} - \frac{x^4}{8a^3} + \frac{x^6}{16a^5}$ , &c.

III. Of the Method of reducing a fractional Quantity into an Infinite Series by the Binomial Theorem.

As this method has already been illustrated in the article ALGEBRA, we shall therefore briefly state the theorem, and add a few examples.

Binomial Theorem.

$$\begin{aligned} (a+b)^{\frac{m}{n}} &= a^{\frac{m}{n}} + \frac{m}{n} a^{\frac{m-n}{n}} b + \frac{m}{n} \times \frac{m-n}{2n} \times a^{\frac{m-2n}{n}} b^2 \\ &+ \frac{m}{n} \times \frac{m-n}{2n} \times \frac{m-2n}{3n} \times a^{\frac{m-3n}{n}} b^3, \&c. \\ \text{Or } a^{\frac{m}{n}} \times \left( 1 + \frac{b}{a} \right)^{\frac{m}{n}} &= a^{\frac{m}{n}} \times \left( 1 + \frac{m}{n} \times \frac{b}{a} + \frac{m}{n} \times \frac{m-n}{2n} \times \frac{b^2}{a^2} \right. \\ &\left. + \frac{m}{n} \times \frac{m-n}{2n} \times \frac{m-2n}{3n} \times \frac{b^3}{a^3} \right), \&c. \end{aligned}$$

EXAMPLES.

1. Let  $\frac{a}{ax-x^2}^{\frac{1}{2}}$  be converted into an infinite series? Now  $\frac{a}{ax-x^2}^{\frac{1}{2}} = a \times \frac{1}{ax-x^2}^{-\frac{1}{2}} = \frac{a}{ax} \left( 1 - \frac{x}{a} \right)^{-\frac{1}{2}}$ . And this last expression, being compared with the general theorem, gives  $\frac{b}{a} = \frac{x}{a}, m = -1, n = 2$ . Hence, by substitution, we have  $\frac{a}{ax-x^2}^{\frac{1}{2}} = \frac{a}{x} \left( 1 - \frac{x}{a} \right)^{-\frac{1}{2}} = \frac{a}{x} \times \left( 1 + \frac{1}{2} \times \frac{x}{a} + \frac{1 \times 3}{4} \times \frac{x^2}{a^2} + \frac{1 \times 3 \times 5}{8} \times \frac{x^3}{a^3} + \frac{1 \times 3 \times 5 \times 7}{128} \times \frac{x^4}{a^4} + \dots \right)$

Series.  $\frac{-1-2}{4} \times \frac{-1-4}{6} \times \frac{x^3}{a^1}$ , &c. =  $\frac{a}{x} \Big| \frac{1}{2} + 1 + \frac{x}{2a} + \frac{3x^2}{8a^2}$   
 $+ \frac{5x^3}{16a^3} + \frac{35x^4}{128a^4}$ , &c.

Series.  $\frac{374y^{11}}{19683x^{21}} = \frac{174}{19683} \times \frac{88}{7171}$ , = 0.0000008  
 $\frac{935y^{14}}{59049x^{24}} = \frac{935}{59049} \times \frac{88}{7171}$ , = 0.0000001

2. Required the square root of  $a^2+x^2$ ?  
 By comparing this with the general theorem, we have  $a=a^2$ ,  $b=x^2$ ,  $m=1$ ,  $n=2$ . Hence, by substitution, the series becomes  $a \times 1 + \frac{1}{2} \times \frac{x^2}{a^2} + \frac{1}{2} \times \frac{1-2}{2 \times 2} \times \frac{x^4}{a^4} + \frac{1}{2} \times \frac{1-2}{2 \times 2} \times \frac{1-4}{3 \times 2} \times \frac{x^6}{a^6}$ , &c. =  $a \times 1 + \frac{x^2}{2a} - \frac{x^4}{8a^3} + \frac{5x^6}{16a^5} - \frac{5x^8}{128a^7}$ , &c. And  $a^2-b^2 \Big| \frac{1}{2} = a \times 1 - \frac{x^2}{2a} + \frac{x^4}{8a^3} - \frac{x^6}{16a^5} + \frac{5x^8}{128a^7}$ , &c.

In order to apply this to numbers, let the square root of 85 be required? Now, the square root of 85 =  $\sqrt{81+4}$ ; hence  $a=9$ , and  $x^2=4$ .

Then  $\frac{1}{9} = 0.1000000$   
 $\frac{x^2}{2a^2} = \frac{4}{2 \times 81} = 0.024691$   
 $\frac{x^4}{8a^4} = \frac{4 \times 4}{8 \times 81 \times 81} = 0.000304$   
 $\frac{x^6}{16a^6} = \frac{4 \times 4 \times 4}{16 \times 81 \times 81 \times 81} = 0.000007$   
 1.024394  
 9

Square root of 85 = 9.219546, true except the last decimal.

3. Required the cube root of  $a^3+b^3$ ?  
 This being compared with the general theorem gives  $a=a^3$ ,  $b=b^3$ ,  $m=1$ ,  $n=3$ . Hence  $a^3+b^3 \Big| \frac{1}{3} = a \times 1 + \frac{1}{3} \times \frac{b^3}{a^3} + \frac{1}{3} \times \frac{1-3}{6} \times \frac{b^6}{a^6} + \frac{1}{3} \times \frac{1-3}{6} \times \frac{1-6}{9} \times \frac{b^9}{a^9}$ , &c. =  $a \times 1 + \frac{b^3}{3a^3} - \frac{b^6}{9a^6} + \frac{5b^9}{81a^9} - \frac{10b^{12}}{243a^{12}}$ , &c. And  $a^3-b^3 \Big| \frac{1}{3} = a \times 1 - \frac{b^3}{3a^3} + \frac{b^6}{9a^6} - \frac{5b^9}{81a^9} + \frac{10b^{12}}{243a^{12}}$ , &c.

Let the cube root of 600 be required? Now  $\sqrt[3]{600} = 8 \times 1 + \frac{88}{512} \Big| \frac{1}{3}$ . Then  $y^3=88$ ,  $x^3=512$ ,  $m=1$ , and  $n=3$ .

Then  $\frac{1}{8} = 0.10000000$   
 $\frac{y^3}{3x^3} = \frac{88}{3 \times 512} = 0.05729166$   
 $\frac{y^6}{9x^6} = \frac{1}{3} \times \frac{88}{512} = 0.00328233$   
 $\frac{5y^9}{81x^9} = \frac{5}{81} \times \frac{88}{512} = 0.00031341$   
 $\frac{10y^{12}}{243x^{12}} = \frac{10}{243} \times \frac{88}{512} = 0.00003591$   
 $\frac{22y^{15}}{729x^{15}} = \frac{22}{729} \times \frac{88}{512} = 0.0000453$   
 $\frac{15+y^{18}}{6561x^{18}} = \frac{15}{6561} \times \frac{88}{512} = 0.0000060$

Sum of the positive terms, 1.05760968  
 Sum of the negative terms, 0.00331885  
 Difference, 1.05429083  
 8

Cube root of 600, = 8.43432664

In operations of this kind, the nearest power to the given number, whether greater or less than it, is to be used, as by that means the series will converge more quickly. An infinite series may be involved to any given Involution power, or any proposed root of a given series may be extracted by means of the following general theorem.  $z^m \times (a+bx+cx^2+dx^3+ex^4, \&c.)^m = z^m$ , multiplied by

$$a^m + mba^{m-1}x + m \cdot \frac{m-1}{2} \cdot a^{m-2}b^2x^2 + m \cdot \frac{m-1}{2} \cdot a^{m-1}c \Big\} x^2$$

$$+ m \cdot \frac{m-1}{2} \cdot \frac{m-2}{3} \cdot a^{m-3}b^3x^3 + m \cdot \frac{m-1}{2} \cdot 2a^{m-2}bcx^2 + m \cdot a^{m-1}d \Big\} x^4$$

$$+ m \cdot \frac{m-1}{2} \cdot \frac{m-2}{3} \cdot \frac{m-3}{4} \cdot a^{m-4}b^4x^4 + m \cdot \frac{m-1}{2} \cdot \frac{m-2}{3} \cdot 3a^{m-3}b^2c^2x^4 + m \cdot \frac{m-1}{2} \cdot a^{m-2} \cdot \{ 2b^2d + c^2 \} x^4 + m \cdot a^{m-1}e \Big\} x^6$$

$$+ m \cdot \frac{m-1}{2} \cdot \frac{m-2}{3} \cdot \frac{m-3}{4} \cdot \frac{m-4}{5} \cdot a^{m-5}b^5x^6 + m \cdot \frac{m-1}{2} \cdot \frac{m-2}{3} \cdot \frac{m-3}{4} \cdot 4a^{m-4}b^3c^2x^6 + m \cdot \frac{m-1}{2} \cdot \frac{m-2}{3} \cdot 3a^{m-3} \cdot \{ bc^2 + b^2d \} x^6 + m \cdot \frac{m-1}{2} \cdot 2a^{m-2} \cdot \{ cd + b^2e \} x^6 + m \cdot a^{m-1}f \Big\} x^8$$

$$+ m \cdot \frac{m-1}{2} \cdot \frac{m-2}{3} \cdot \frac{m-3}{4} \cdot \frac{m-4}{5} \cdot \frac{m-5}{6} \cdot a^{m-6}b^6x^8 + m \cdot \frac{m-1}{2} \cdot \frac{m-2}{3} \cdot \frac{m-3}{4} \cdot \frac{m-4}{5} \cdot 5a^{m-5}b^4c^2x^8 + m \cdot \frac{m-1}{2} \cdot \frac{m-2}{3} \cdot \frac{m-3}{4} \cdot a^{m-4} \cdot \{ 6b^2c^2 + 4b^3d \} x^8 + m \cdot \frac{m-1}{2} \cdot \frac{m-2}{3} \cdot 3a^{m-3} \cdot \{ 3b^2e + 6bcd \} x^8 + m \cdot \frac{m-1}{2} \cdot a^{m-2} \cdot \{ 2b^2f + 2ce + d^2 \} x^8 + m \cdot a^{m-1}g$$

&c.

Now

Series.

Now each term of the given series is to be compared with the correspondent terms in the first part of the several terms of the required series will be obtained.

Series.

EXAMPLES.

1<sup>st</sup>. What is the square of the series  $y - y^3 + y^5 - y^7 + \&c.$ ?

By comparing this with the general theorem, we find  $z = y, a = 1, b = 0, c = -1, d = 0, g = -1, \&c.$  and  $m = 2$ ; whence  $y - y^3 + y^5 - y^7 + \&c.$   $\square = y^2 \times (1 - 2ax^2 + c^2x^4 - 2ccx^6) + 2cx^4 - 2gx^6, \&c. = y^2 \times (1 - 2y^2 + 3y^4 - 4y^6) + 2ey^4 - 2gy^6, \&c.$

2<sup>d</sup>. Required the fourth power of the series  $1 + x + x^2 + x^3, \&c.$ ?

Here  $z = 1, a = 1, b = 1, c = 1, d = 1, \& m = 4.$   
Then  $(1 + x + x^2 + x^3, \&c.)^4 = 1 + 4bx + 6b^2x^2 + 4b^3x^3 + b^4x^4, \&c.$   
 $+ 4c + 12bc + 12b^2c$   
 $+ 4d + 6c^2$   
 $+ 12bd$   
 $+ 4e$   
 $= 1 + 4x + 10x^2 + 20x^3 + 35x^4, \&c.$

3<sup>d</sup>. What is the square of  $\frac{1}{x} + \frac{1}{x^2} + \frac{1}{x^3} + \frac{1}{x^4}, \&c.$

In this case  $z = \frac{1}{x}, x = \frac{1}{x}, a = 1, b = 1, c = 1, d = 1, \& m = 2.$

Then  $(\frac{1}{x} + \frac{1}{x^2} + \frac{1}{x^3}, \&c.)^2 = \frac{1}{x^2} \times (1 + 2b \times \frac{1}{x} + b^2 \times \frac{1}{x^2} + 2bc \times \frac{1}{x^3} + 2bd \times \frac{1}{x^4}, \&c.)$   
 $+ 2c + 2d + c^2 + 2e$   
 $= \frac{1}{x^2} \times (1 + \frac{2}{x} + \frac{3}{x^2} + \frac{4}{x^3} + \frac{5}{x^4}, \&c.)$   
 $= \frac{1}{x^2} + \frac{2}{x^3} + \frac{3}{x^4} + \frac{4}{x^5} + \frac{5}{x^6}, \&c.$

4<sup>th</sup>. What is the square root of  $\frac{1}{r^2 - \frac{z^2}{2} + \frac{z^4}{4r^2} - \frac{z^6}{6r^4} + \frac{z^8}{8r^6}, \&c.$

The quantity reduced is  $\frac{1}{r^2} \times \frac{1}{1 - \frac{z^2}{2r^2} + \frac{z^4}{4r^2} - \frac{z^6}{6r^4} + \frac{z^8}{8r^6}, \&c.$

In this example  $z = \frac{1}{r}, x = z^2, a = 1, b = -\frac{1}{2r^2}, c = \frac{1}{4r^4}, d = -\frac{1}{6r^6}, \&c.$  and  $m = -\frac{1}{2}, \frac{m-1}{2} = -\frac{3}{4}$

$\frac{3}{4}, \frac{m-2}{3} = -\frac{5}{6}, \frac{m-3}{4} = -\frac{7}{8}, \&c.$

Then  $\frac{1}{r^2 - \frac{z^2}{2} + \frac{z^4}{4r^2}, \&c.} = \frac{1}{r} \times (1 + \frac{x}{4r^2} + \frac{3x^2}{32r^4} + \frac{5x^3}{128r^6}, \&c.)$

$$= \frac{1}{r} + \frac{x}{4r^3} + \frac{x^2}{32r^5} + \frac{11x^3}{384r^7}, \&c.$$

Of an harmonical series.

**HARMONICAL SERIES**, a series of terms formed in harmonical proportion. It has been already observed in the article PROPORTION, that if three numbers be in harmonical proportion, the first is to the third as the difference between the first and second is to the difference between the second and third.

Let  $a, b,$  and  $x$  be three terms in harmonical proportion: then  $a : x :: a - b : b - x$   
whence  $ax - bx = ab - ax,$   
and  $2ax - bx = ab$

then  $x = \frac{ab}{2a-b}$ . Hence the three

first terms of this series is  $a, b, \frac{ab}{2a-b}$

Again, let  $x$  be the fourth term, to find which in terms of  $a$  and  $b,$  we have

$$b : x :: b - \frac{ab}{2a-b} : \frac{ab}{2a-b} - x$$

Then  $b \times \frac{ab}{2a-b} - x = \frac{ab^2}{2a-b} - bx$

$$\frac{3ab - 2b^2}{2a-b} \cdot x = \frac{ab^2}{2a-b}$$

$$x = \frac{ab^2}{2a-b} \cdot \frac{2a-b}{3ab - 2b^2} = \frac{ab}{3a - 2b};$$

therefore the four first terms are  $a, b, \frac{ab}{2a-b}, \frac{ab}{3a-2b}.$

Whence the law of the series is obvious, and it may be continued

The method of extending this series.

continued as follows,  $a, b, \frac{ab}{2a-b}, \frac{ab}{3a-2b}, \frac{ab}{4a-3b},$   
 $\frac{ab}{5a-4b},$  &c. and the  $n^{\text{th}}$  term is  $\frac{ab}{n-1.a-n-2.b}$ .

If, in a series of terms in harmonical proportion,  $a$  and  $b$  be two affirmative quantities, and such that  $a < b$ ; then this series, which is positive at first, will become negative as soon as  $n-2 \cdot b$  exceeds  $n-1 \cdot a$ . But if  $a > b$ , the series will converge, and although produced to infinity will not become negative.

Let  $a$  and  $b$  be equal to 2 and 1 respectively; then this series becomes  $\frac{2}{1}, \frac{2}{2}, \frac{2}{3},$  &c. and since, if each term of an harmonical series be divided by the same quantity, the series will still be harmonical. Therefore  $\frac{1}{2}, \frac{1}{3}, \frac{1}{4}, \frac{1}{5},$  &c. is an harmonical series; whence the denominators of this series form a series of numbers in arithmetical progression; and conversely, the reciprocals of an arithmetical progression are in harmonical proportion.

Recurring SERIES, a series of which any term is formed by the addition of a certain number of preceding terms, multiplied or divided by any determinate numbers whether positive or negative. Thus 2, 3, 19, 101, 543, 2917, 15671, &c. is a recurring series, each term of which is formed by the addition of the two preceding terms, the first of which being previously multiplied by the constant quantity 2 and the other by 5. Thus the third term 19 = 2 × 2 + 3 × 5; the fourth term 101 = 3 × 2 + 19 × 5, &c.

The principal operation in a series of this nature is that of finding its sum.—For this purpose, the two first and two last terms of the series must be given, together with the constant multipliers.

Let  $a, b, c, d, e, f,$  &c. be any number of terms of a series formed according to the above law, each successive term being equal to the sum of the products of the two preceding terms, the first being multiplied by the given quantity  $m$ , and the other by the given quantity  $n$ . Hence we will have the following series of equations  $c = ma + nb, d = mb + nc, e = mc + nd, f = md + ne,$  &c. Then adding these equations, we obtain  $c + d + e + f = m \times a + b + c + d + n \times b + c + d + e$ . Now the first member of this equation is the sum of all the terms except the two first; the quantity by which  $m$  is multiplied in the second member is the sum of all the terms except the two last; and that by which  $n$  is multiplied is the sum of all the terms except the first and last. Now let  $s =$  sum of the series; then  $s - a - b = m \times s - e - f + n \times s - a - f$

Hence  $s = \frac{m \times e + f + n \times a + f - a - b}{m + n - 1}$

Let the sum of the first seven terms of the above series be required?

Two last terms	$\begin{cases} 15671 \\ 2917 \end{cases}$	First term	2
Sum	18588	Last term	15671
	$\frac{2}{m}$	Sum	15673
	$\frac{37176}{78365}$	$n$	5
Sum	115541		
$-2+3$	$\frac{5}{115536}$		
$2+5-1=6$	$\frac{115536}{19256}$		

= Sum of the series.

Reversion of SERIES is the method of finding the value of the quantity whose several powers are involved in a series, in terms of the quantity which is equal to the given series.

In order to this, a series must be assumed, which being involved and substituted for the quantity equal to the series, and its powers, neglecting those terms whose powers exceed the highest power to which it is proposed to extend the series.

Let it be required to revert the series  $ax + bx^2 + cx^3 + dx^4 + ex^5,$  &c. =  $y$ ; or, to find  $x$  in an infinite series expressed in the powers of  $y$ .

Substitute  $y^n$  for  $x$ , and the indices of the powers of  $y$  in the equation will be  $n, 2n, 3n,$  &c. and 1, therefore  $n=1$ ; and the differences are 0, 1, 2, 3, 4, 5, &c. Hence, in this case, the series to be assumed is  $Ay + By^2 + Cy^3 + Dy^4,$  &c. which being involved and substituted for the respective powers of  $x$ , then we have

$$\begin{aligned} ax &= aAy + aBy^2 + aCy^3 + aDy^4, \text{ \&c. } \\ bx^2 &= +bA^2y^2 + 2bABy^3 + 2bACy^4 \text{ \&c. } \\ cx^3 &= +cA^3y^3 + 3cA^2By^4, \text{ \&c. } \\ dx^4 &= +dA^4y^4, \text{ \&c. } \end{aligned} \quad \Bigg\} = y$$

Whence, by comparing the homologous terms, we have  $aAy = y$ ; therefore  $A = \frac{1}{a}, B = \frac{b}{a^2}, C = \left( -\frac{2bAB + cA^3}{a} \right) = \frac{2b^2 - ac}{a^3}; D = \left( -\frac{2bAC + bB^2 + 3cA^2B + dA^4}{a} \right) = \frac{5abc - 5b^3 - a^2d}{a^7},$  &c. and consequently  $x = \frac{y}{a} - \frac{by^2}{a^3} + \frac{2b^2 - ac}{a^5} \times y^3 - \frac{5b^3 - 5abc + a^2d}{a^7} \times y^4,$  &c.

Examples.

1<sup>st</sup>, Let  $x - \frac{x^2}{2} + \frac{x^3}{3} - \frac{x^4}{4},$  &c. =  $y$ . There  $a$  being in this case equal to 1,  $b = -\frac{1}{2}, c = \frac{1}{3}, d = -\frac{1}{4},$  &c. we shall, by substituting these values, have  $x = y + \frac{y^2}{2} + \frac{y^3}{6} + \frac{y^4}{24},$  &c.

2<sup>d</sup>, Let  $x - x^2 + x^3 - x^4 + x^5,$  &c. =  $y$ ; to find  $x$ ?

In this example we have  $x = x, a = 1, b = -1, c = 1, d = -1,$  &c.; whence  $x = \frac{y}{1} + \frac{1}{1}y^2 + \frac{2-1}{1}y^3 + \frac{-5+5-1}{1}y^4,$  &c. =  $y + y^2 + y^3 + y^4,$  &c.

3<sup>d</sup>, Let  $a = r - \frac{x^2}{2r} + \frac{x^4}{24r^3} - \frac{x^6}{720r^5} + \frac{x^8}{4032r^7}$  &c. to find  $x$ ?

Put  $r - a = v$ ; then  $v = \frac{x^2}{2r} - \frac{x^4}{24r^3} + \frac{x^6}{720r^5} - \frac{x^8}{4032r^7},$  &c. By comparison we find  $x = x^2, y = v,$   
 $a = \frac{1}{2r}, b = -\frac{1}{24r^3}, c = \frac{1}{720r^5}, d = -\frac{1}{4032r^7},$  &c.  
 Pp Hence

Series.

$$\text{Hence } x^2 = 2rv - \frac{24r^3}{8r^3}v^2 + \frac{288r^6}{32r^3}v^3 + \frac{1}{1440r^5}v^4$$

$$v^3, \&c. = 2rv + \frac{1}{3}v^2 + \frac{4}{45r}v^3 + \frac{1}{35r^2}v^4, \&c.$$

$$\text{whence } x = \sqrt{2rv} \times \left( 1 + \frac{v}{12r} + \frac{3v^2}{160r^2} + \frac{5v^3}{896r^3} \right)$$

*Summation of SERIES* is the method of finding the sum of the terms of an infinite series produced to infinity, or the sum of any number of terms of such a series.

The value of any arithmetical series, as  $1^2 + 2^2 + 3^2 + 4^2 \dots n^2$ , varies according as ( $n$ ) the number of its terms varies; and therefore, if it can be expressed in a general manner, it must be explicable by  $n$  and its powers with determinate coefficients; and those powers, in this case, must be rational, or such whose indices are whole positive numbers; because the progression, being a whole number, cannot admit of surd quantities. Lastly, it will appear that the greatest of the said indices cannot exceed the common index of the series by more than unity: for, otherwise, when  $n$  is taken indefinitely great, the highest power of  $n$  would be indefinitely greater than the sum of all the rest of the terms.

Thus the highest power of  $n$ , in an expression exhibiting the value of  $1^2 + 2^2 + 3^2 + 4^2 \dots n^2$ , cannot be greater than  $n^3$ ; for  $1^2 + 2^2 + 3^2 + 4^2 \dots n^2$  is manifestly less than  $n^3$ , or  $n^2 + n^2 + n^2 + \dots$  continued to  $n$  terms; but  $n^4$ , when  $n$  is indefinitely great, is indefinitely greater than  $n^3$ , or any other inferior power of  $n$ , and therefore cannot enter into the equation. This being premised, the method of investigation may be as follows:

EXAMPLES.

1. Required the sum of  $n$  terms of the series  $1 + 2 + 3 + 4 + \dots n^2$

Let  $A n^2 + B n$  be assumed, according to the foregoing observations, as an universal expression for the value of  $1 + 2 + 3 + 4 \dots n$ , where  $A$  and  $B$  represent unknown but determinate quantities. Therefore, since the equation is supposed to hold universally, whatsoever is the number of terms, it is evident, that if the number of terms be increased by unity, or, which is the same thing, if  $n + 1$  be wrote therein instead of  $n$ , the equation will still subsist; and we shall have  $A \times n + 1 + B \times n + 1 = 1 + 2 + 3 + 4 \dots n + n + 1$ . From which the first equation being subtracted, there remains  $A \times n + 1 + B \times n + 1 - A n^2 + B n = n + 1$ ; this contracted will be  $2 A n + A + B = n + 1$ ; whence we have  $2 A - 1 \times n + A + B - 1 = 0$ : Wherefore, by taking  $2 A - 1 = 0$ , and  $A + B - 1 = 0$ , we have  $A = \frac{1}{2}$ , and  $B = \frac{1}{2}$ ; and consequently  $1 + 2 + 3 + 4 \dots n (= A n^2 + B n) = \frac{n^2}{2} + \frac{n}{2} = \frac{n \times n + 1}{2}$ .

What is the sum of the ten first terms of the series  $1 + 2 + 3, \&c.$ ?

In this case  $n = 10$ , then  $\frac{n \times n + 1}{2} = \frac{10 \times 11}{2} = 55$ .

2. Required the sum of the series  $1^2 + 2^2 + 3^2 \dots n^2$ , or  $1 + 4 + 9 + 16 \dots n^2$ ?

Let  $A n^3 + B n^2 + C n$ , according to the foregoing observations, be assumed  $= 1^2 + 2^2 + 3^2 \dots n^2$ ; then, as in the preceding case, we shall have  $A \times n + 1 + B \times n + 1 + C \times n + 1 = 1^2 + 2^2 + 3^2 \dots n^2 \times n + 1^2$ ; that is, by involving  $n + 1$  to its several powers,  $A n^3 + 3 A n^2 + 3 A n + A + B n^2 + 2 B n + B + C n + C = 1^2 + 2^2 + 3^2 \dots n^2 + n + 1^2$ ; from which subtracting the former equation, we obtain  $3 A n^2 + 3 A n + A + 2 B n + B + C (= n + 1^2) = n^2 + 2 n + 1$ ; and consequently  $3 A - 1 \times n^2 + 3 A + 2 B - 2 \times n + A + B + C - 1 = 0$ ; whence  $3 A - 1 = 0$ ,  $3 A + 2 B - 2 = 0$ , and  $A + B + C - 1 = 0$ ; therefore  $A = \frac{1}{3}$ ,  $B = \frac{2 - 3 A}{3} = \frac{1}{3}$ ,  $C = 1 - A - B = \frac{1}{3}$ , and consequently  $1 + 4 + 9 + 16 \dots n^2 = \frac{n^3}{3} + \frac{n^2}{2} + \frac{n}{6}$ , or  $\frac{n \times n + 1 \times 2 n + 1}{6}$ .

What is the sum of the ten first terms of the series  $1^2 + 2^2 + 3^2, \&c.$ ?

Here  $n = 10$ , then  $\frac{n \times n + 1 \times 2 n + 1}{6} = \frac{10 \times 11 \times 21}{6} = 385$ .

3. Required the sum of the series  $1^3 + 2^3 + 3^3 + 4^3 \dots n^3$ , or  $1 + 8 + 27 + 64 \dots n^3$ ?

By putting  $A n^4 + B n^3 + C n^2 + D n = 1 + 8 + 27 + 64 \dots n^3$ ; and proceeding as above, we shall have  $4 A n^3 + 6 A n^2 + 4 A n + A + 3 B n^3 + 3 B n + B + 2 C n + C + D (= n + 1^3) = n^3 + 3 n^2 + 1$ , and therefore  $4 A - 1 \times n^3 + 6 A + 3 B - 3 \times n^2 + 4 A + 3 B + 2 C - 3 \times n + A + B + C + D - 1 = 0$ . Hence  $A = \frac{1}{4}$ ,  $B \left( = \frac{3 - 6 A}{3} \right) = \frac{1}{4}$ ,  $C \left( = \frac{3 - 4 A - 3 B}{2} \right) = \frac{1}{4}$ ,  $D (= 1 - A - B - C) = 0$ ; and therefore  $1^3 + 2^3 + 3^3 + 4^3 \dots n^3 = \frac{n^4}{4} + \frac{n^3}{2} + \frac{n^2}{4}$ , or  $= \frac{n^2 \times n + 1^2}{4}$ .

In the very same manner it will be found, that

$$1^4 + 2^4 + 3^4 \dots n^4 = \frac{n^5}{5} + \frac{n^4}{2} + \frac{n^3}{3} - \frac{n}{30}$$

$$1^5 + 2^5 + 3^5 \dots n^5 = \frac{n^6}{6} + \frac{n^5}{2} + \frac{5 n^4}{12} - \frac{n^2}{12}$$

$$1^6 + 2^6 + 3^6 \dots n^6 = \frac{n^7}{7} + \frac{n^6}{2} + \frac{n^5}{2} - \frac{n}{6} + \frac{n}{42}$$

What is the sum of the ten first terms of the series  $1^3 + 2^3 + 3^3, \&c.$ ?

$n = 10$ , then  $\frac{n^2 \times n + 1^2}{4} = \frac{100 \times 121}{4} = 25 \times 121 = 3025$ .

4. Required the sum of  $n$  terms of the series of triangular numbers  $0, 1, 3, 6, 10 \dots n$ ?

Let  $A n^2 + B n + C = 0, 1, 2, 3 \dots n$ ,  $= s$ . Now the  $n + 1$ th term of this series, by Example 2. is  $\frac{n^2}{2} + \frac{n}{2}$ . Then  $A \times n + 1 + B \times n + 1 + C$ .  $n + 1 = s + \frac{n^2}{2} + \frac{n}{2}$ . Now, the first equation being subtracted from this, we have  $3 A n^2 + 3 A + 2 B \times n + A + B + C = \frac{n^2}{2} + \frac{n}{2}$ . Or,  $3 A n^2 + 3 A n +$

*Series.*  $A + C = \frac{n^3}{2} + \frac{1}{2} - 2B \times n - B.$

Whence, by equating the homologous terms, we have  $3A = \frac{1}{2}$ , and  $A = \frac{1}{6}$ :  $\frac{1}{6} - 2B = 3A$ ; whence  $2B = \frac{1}{6} - \frac{1}{2} = 0$ ,  $A + C = -B$ . Hence  $C = -\frac{1}{6}$ . Now, these values being substituted in the above equation, gives the sum  $= \frac{n^3}{6} - \frac{n}{6} =$

$\frac{n \cdot n - 1 \cdot n + 1}{1 \cdot 2 \cdot 3}$ ; and if  $n + 1$  be put for  $n$ , the sum of  $n$  terms of this series will be  $\frac{n \cdot n + 1 \cdot n + 2}{1 \cdot 2 \cdot 3}.$

By proceeding in the same manner, the sum of  $n$  terms of pyramidal numbers, 1, 4, 10, 20, 35, &c....  $n$  will be found  $= \frac{n \cdot n + 1 \cdot n + 2 \cdot n + 3}{1 \cdot 2 \cdot 3 \cdot 4}$ . And the sum of any series of figurate numbers is determined by a like formula, the law of continuation being obvious.

What is the sum of the ten first terms of triangular numbers 1, 3, 6, 10, 15, &c.?

Here  $n = 10$ ; then  $\frac{n \cdot n + 1 \cdot n + 2}{1 \cdot 2 \cdot 3} = \frac{10 \times 11 \times 12}{6} = 220.$

5. Let the sum of the series  $\frac{1}{R} + \frac{2}{R^2} + \frac{3}{R^3}$  continued to  $n$  terms be required?

If we multiply this series indefinitely continued by  $R - 1$ , or  $R^2 - 2R + 1$ , the product is  $R$ ; therefore the amount of the indefinite series is  $\frac{R}{R - 1}$ , and the sum of  $n$  terms may be found by subtracting the terms after the  $n$ th from that amount. Now, the terms after the  $n$ th are  $\frac{n + 1}{R^{n+1}} + \frac{n + 2}{R^{n+2}}$ , &c. which may be divided into the two following series:

First,  $\frac{n}{R^n} \times \frac{1}{R} + \frac{1}{R^2} + \frac{1}{R^3}$ , &c.  $= \frac{n}{R^n} \times \frac{1}{R - 1}.$   
 Second,  $\frac{1}{R^n} \times \frac{1}{R} + \frac{2}{R^2} + \frac{3}{R^3}$ , &c.  $= \frac{1}{R^n} \times \frac{R}{R - 1}.$

Now, if we write  $a$  for  $\frac{1}{R^n}$ , and  $r$  for  $R - 1$ , and subtract the sum of these two series from the amount of the proposed series indefinitely continued, the remainder will be found  $= \frac{1 - a}{r} \times R - \frac{n \cdot a}{r}.$

6. Let the sum of the series  $\frac{n - 1}{nR} + \frac{n - 2}{nR^2} + \frac{n - 3}{nR^3}$  &c. be required?

This series is equal to the difference of the two following.

First,  $\frac{n}{nR} + \frac{n}{nR^2} + \frac{n}{nR^3}$ , &c.  $= \frac{1}{R} + \frac{1}{R^2} + \frac{1}{R^3}$ , &c.  $= \frac{1 - a}{r}.$

Second,  $\frac{1}{nR} + \frac{2}{nR^2} + \frac{3}{nR^3}$ , &c.  $= \frac{1}{n} \times \frac{1}{R} + \frac{1}{R^2} + \frac{1}{R^3}$   
 &c.  $= \frac{1}{n} \times \frac{1 - a}{r} \times R - \frac{a}{r}.$

The difference of these series is  $\frac{1 - a}{r} - \frac{R}{n} \times \frac{1 - a}{r} + \frac{a}{r}$ , Seringapatam.  
 which reduced becomes  $\frac{n + a - 1 \times r + a - 1}{n r^2}.$

To proceed farther would lead us far beyond the limits assigned for this article; we must therefore refer those who require more information on this subject to the following authors.—Bertrand's *Developpement*, &c. vol. 1; Dodson's *Mathematical Repository*, vol. 1; Emerson's *Algebra*; Appendix to *Gravesend's Algebra*; Hutton's *Paper on Cubic Equations and Infinite Series*, in the *Philosophical Transactions* for 1780; Maclaurin's *Fluxions*; Malcolm's *Arithmetic*; Masere's *Annuities*; and *Scriptores Logarithmici*, &c.; De Moivre's *Doctrine of Chances*, and a *Paper* by the same author in the *Philosophical Transactions*, n<sup>o</sup> 240; Simpson's *Algebra, Essays, Fluxions, and Miscellanies*; Sterling's *Summatio et Interpolatio Serierum*; *Syntagma Mathematico*, &c.

**SERINGAPATAM**, the capital of Mysore, the dominions of Tippoo Sultan, is situated in an island of the Cavery river, about 290 or 300 miles from Madras. The island, upon survey, appeared to be about four miles in length by one and a half in breadth, across the middle, where it is likewise highest, whence it gradually falls and narrows towards the extremities. The west end of the island, on which there is a fort of considerable strength, slopes more, especially towards the north; and the ground rising on the opposite side of the river commands a distinct view of every part of the fort. The fort and outworks occupy about a mile of the west end of the island, and are distinguished by magnificent buildings, and ancient Hindoo pagodas, contrasted with the more lofty and splendid monuments lately raised in honour of the Mahometan faith. The great garden, called the *Laul Baug*, covers about as much of the east end of the island as the fort and outworks do of the west; and the whole intermediate space, except a small inclosure on the north bank near the fort, was, before the last war, filled with houses, and formed an extensive suburb, of which the greatest part was destroyed by Tippoo to make room for batteries to defend the island when attacked by the combined forces of Earl Cornwallis and the Mahratta chiefs in February 1792. This suburb, or town of modern structure, is about half a mile square, divided into regular cross streets, all wide, and shaded on each side by trees. It is surrounded by a strong mud wall, contains many good houses, and seems to have been preserved by the Sultan for the accommodation of merchants, and for the convenience of troops stationed on that part of the island for its defence. A little to the eastward of the town is the entrance to the great garden, which was laid out in regular shady walks of large cypress trees, and abounding with fruit-trees, flowers, and vegetables of every description. It possessed all the beauty and elegance of a country retirement, and was dignified by the mausoleum of Hyder the late sultan, and a superb new palace built by his son. This noble garden was devoted to destruction; and the trees which had shaded their proud master, and contributed to his pleasures, were formed into the means of protecting his enemies in subverting his empire. Before that event, so glorious to the arms of England, this insulated metropolis

Seringham  
Seriphus.

(says Major Dirom) must have been the richest, most convenient, and beautiful spot possessed in the present age by any native prince in India; but when the allies left it, the Sultan's fort and city only remained in repair amidst all the wrecks of his former grandeur, the island presenting nothing but the appearance of wretched barrenness. Tippoo is a man of talents, enterprise, and great wealth; but, in the opinion of our author, the remaining years of his ill-fated life will be unequal to renew the beauties of his terrestrial paradise. N. Lat. 12° 31' 45". E. Long. 96° 46' 45".

SERINGHAM, an island of Indostan, formed about six miles north-west of Trinchinopoly by the river Cavery, which divides itself into two branches: that to the northward takes the name of *Coleroon*, but the southern branch preserves its old name the *Cavery*. Each of these rivers, after a course of about 90 miles, empty themselves into the sea; the Coleroon at Devicottah, and the Cavery near Tranquebar, at about 20 miles distance from one another. In this island, facing Trinchinopoly, stood a famous pagoda surrounded by seven square walls of stone, 25 feet high and four feet thick. The space between the outward and second walls measured 310 feet, and so proportionably of the rest. Each inclosure had four large gates, with a high tower; which were placed, one in the middle of each side of the inclosure, and opposite to the four cardinal points. The outward wall was about four miles in circumference, and its gateway to the south was ornamented with pillars, some of which were single stones 33 feet in length and five in diameter; while those that formed the roof were still larger; and in the inmost inclosure were the chapels.—About half a mile to the east was another large pagoda called *Jumbikijina*, which had but one inclosure.

The pagoda of Seringham was held in great veneration, from a belief that it contained the identical image of the god Wisnoui worshipped by Bramas; and pilgrims came here from all parts of India with offerings of money to procure absolution. A large part of the revenue of the island was allotted for the maintenance of the Bramins who inhabited the pagoda; and these, with their families, formerly amounted to no fewer than 40,000 persons, all maintained by the superstitious liberality of the adjacent country.

SERIOLA, in botany: A genus of plants belonging to the order of polygamia æqualis, and to the class of syngenesia; and in the natural system ranged under the 49th order, *Composita*. The receptacle is paleaceous; the calyx simple; and the pappus is somewhat plumose. There are four species; 1. The *Levigata*. 2. *Æthnensis*. 3. *Cretensis*. 4. *Urens*. The first is a native of the island of Candia, and flowers in July and August; the second is a native of Italy; and the fourth is a native of the south of Europe.

SERIPHUUM, in botany; a genus of plants belonging to the order of monogamia, and to the class of syngenesia. The calyx is imbricated; the corolla is monopetalous and regular, with one oblong seed under it. There is only one species, the *cinereum*, which is a native of the Cape of Good Hope.

SERIPHUS (anc. geog.), one of the Cyclades or islands in the Ægean sea, called *Saxum Seriphium* by Tacitus, as if all a rock; one of the usual places of banishment among the Romans. The people, *Seriphii*;

who, together with the Siphni, joined Greece against Xerxes, were almost the only islanders who refused to give him earth and water in token of submission, (Herodotus). *Seripbia Rana*, a proverbial saying concerning a person who can neither sing nor say; frogs in this island being said to be dumb, (Pliny).

SERMON, a discourse delivered in public, for the purpose of religious instruction and improvement.

*Funeral SERMON.* See *FUNERAL ORATIONS*.

SERON OF ALMONDS, is the quantity of two hundred weight; of anise seed, it is from three to four hundred; of Castile soap, from two hundred and an half to three hundred and three quarters.

SEROSITY, in medicine, the watery part of the blood.

SERPENS, in astronomy, a constellation in the northern hemisphere, called more particularly *Serpens Ophiuchi*. The stars in the constellation Serpens, in Ptolemy's catalogue, are 18; in Tycho's, 13; in Hevelius's, 22; and in the Britannic catalogue, 64.

*SERPENS Biceps*, or *Double-headed Snake*; a monster of the serpent kind, there being no permanent species of this conformation. That represented on Plate CCCCXLIX. and copied from Edwards, came from the island of Barbadoes; and was said to have been taken out of an egg of the size of a small pullet's egg by a man who found it under-ground as he was digging. The heads were not in an horizontal position when the snake lay on its belly, but inclined to each other on their under-sides, leaving an opening for the throat to come in between the two heads underneath, as is expressed at A. The upper-side, for the whole length, was covered with small scales, falling one over another; the belly was covered with single scales running across it, in the form of half rings. It was all over of a yellowish colour, without any spots or variation. Mr Edwards also informs us, that a person brought to him a common English snake, which had two heads quite separate from each other, the necks parting about an inch from the head.

SERPENS, *Serpent*, in the Linnæan system of zoology, an order of animals belonging to the class of *amphibia*, and comprehending six genera, viz. the *crotalus*, or rattle-snake; the *boa*, including ten species; the *coluber*, or viper; the *anguis*, or snake; the *amphisbana*, or annulated snake, the body and tail of which are composed of annular segments; and the *cæcilia*, or tentaculated snake, the body and tail of which are wrinkled, without scales, and the upper part furnished with two feelers; and including two species. See an account of these genera under their respective names.

The characters of serpents, according to Linnæus, Distinguishing characters of serpents are these: They are amphibious animals, breathing through the mouth by means of lungs only; having a tapering body, no distinct neck; the jaws not articulated, but dilatible, and destitute of feet, fins, and ears.

The serpent has from the beginning been the enemy of man; and it has hitherto continued to terrify and annoy him, notwithstanding all the arts which have been practised to destroy it. Formidable in itself, it deters the invader from the pursuit; and from its figure, capable of finding shelter in a little space, it is not easily discovered by those who would venture to encounter it. Thus possessed at once of potent arms, and inaccessible or secure retreats, it baffles all the arts.

Sermon  
Serpen

Distin-  
guishin-  
g charac-  
ters of  
serpen-

General  
observa-  
tions.



*Sepia or Cuttle fish.*

Fig. 1.

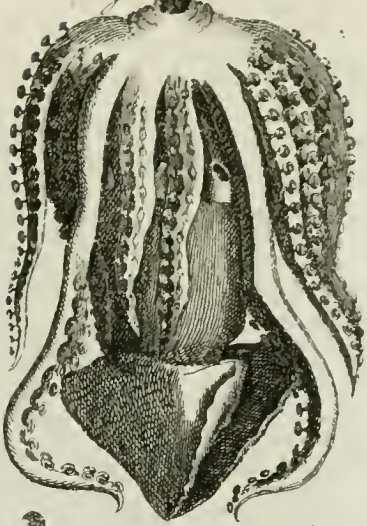

Fig. 2.



Fig. 3.



Fig. 5.

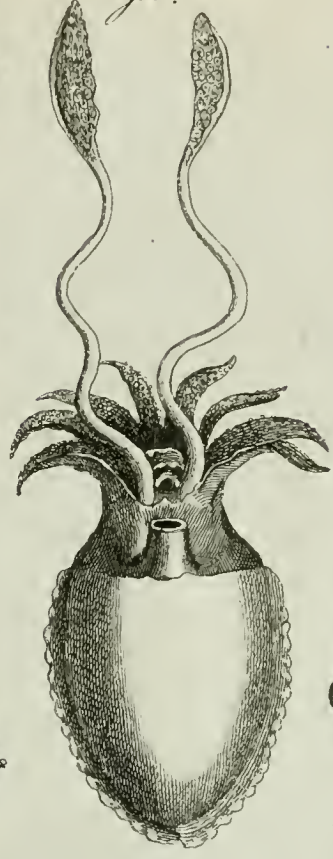

*Althropis nova Hollandiae*



*Sea Dragon.*



*Serpens Biceps.*





Serpens.

arts of man, though ever so earnestly bent upon its destruction. For this reason, there is scarce a country in the world that does not still give birth to this poisonous brood, that seems formed to quell human pride, and repress the boasts of security. Mankind have driven the lion, the tiger, and the wolf, from their vicinity; but the snake and the viper still defy their power.

Their numbers, however, are thinned by human audacity; and it is possible some of the kinds are wholly destroyed. In none of the countries of Europe are they sufficiently numerous to be truly terrible. The various malignity that has been ascribed to European serpents of old is now utterly unknown; there are not above three or four kinds that are dangerous, and their poison operates in all in the same manner. The drowsy death, the starting of the blood from every pore, the insatiable and burning thirst, the melting down the solid mass of the whole form into one heap of putrefaction, said to be occasioned by the bites of African serpents, are horrors with which we are entirely unacquainted.

But though we have thus reduced these dangers, having been incapable of wholly removing them, in other parts of the world they still rage with all their ancient malignity. In the warm countries that lie within the tropics, as well as in the cold regions of the north, where the inhabitants are few, the serpents propagate in equal proportion. But of all countries those regions have them in the greatest abundance where the fields are unpeopled and fertile, and where the climate supplies warmth and humidity. All along the swampy banks of the river Niger or Oroonoko, where the sun is hot, the forests thick, and the men but few, the serpents cling among the branches of the trees in infinite numbers, and carry on an unceasing war against all other animals in their vicinity. Travellers have assured us, that they have often seen large snakes twining round the trunk of a tall tree, encompassing it like a wreath, and thus rising and descending at pleasure.—We are not, therefore, to reject as wholly fabulous the accounts left us by the ancients of the terrible devastations committed by a single serpent. It is probable, in early times, when the arts were little known, and mankind were but thinly scattered over the earth, that serpents, continuing undisturbed possessors of the forest, grew to an amazing magnitude; and every other tribe of animals fell before them. It then might have happened, that serpents reigned the tyrants of a district for centuries together. To animals of this kind, grown by time and rapacity to 100 or 150 feet in length, the lion, the tiger, and even the elephant itself, were but feeble opponents. That horrible factor, which even the commonest and the most harmless snakes are still found to diffuse, might, in these larger ones, become too powerful for any living being to withstand; and while they preyed without distinction, they might thus also have poisoned the atmosphere around them. In this manner, having for ages lived in the hidden and unpeopled forest, and finding, as their appetites were more powerful, the quantity of their prey decreasing, it is possible they might venture boldly from their retreats into the more cultivated parts of the country, and carry consternation among mankind, as they had before desolation among the lower ranks of nature. We have many histories of antiquity, presenting us such a pic-

Serpens.

ture, and exhibiting a whole nation sinking under the ravages of a single serpent. At that time man had not learned the art of uniting the efforts of many to effect one great purpose. Opposing multitudes only added new victims to the general calamity, and increased mutual embarrassment and terror. The animal was therefore to be singly opposed by him who had the greatest strength, the best armour, and the most undaunted courage. In such an encounter, hundreds must have fallen; till one, more lucky than the rest, by a fortunate blow, or by taking the monster in its torpid interval, and surcharged with spoil, might kill, and thus rid his country of the destroyer. Such was the original occupation of heroes; and those who first obtained that name, from their destroying the ravagers of the earth, gained it much more deservedly than their successors, who acquired their reputation only for their skill in destroying each other. But as we descend into more enlightened antiquity, we find these animals less formidable, as being attacked in a more successful manner. We are told, that while Regulus led his army along the banks of the river Bagrada in Africa, an enormous serpent disputed his passage over. We are assured by Pliny, that it was 120 feet long, and that it had destroyed many of the army. At last, however, the battering engines were brought out against it; and these assailing it at a distance, it was soon destroyed. Its spoils were carried to Rome, and the general was decreed an ovation for his success. There are, perhaps, few facts better ascertained in history than this: an ovation was a remarkable honour; and was given only for some signal exploit that did not deserve a triumph: no historian would offer to invent that part of the story at least, without being subject to the most shameful detection. The skin was kept for several years after in the Capitol; and Pliny says he saw it there. At present, indeed, such ravages from serpents are scarce seen in any part of the world; not but that, in Africa and America, some of them are powerful enough to brave the assaults of men to this day.

*Nequent expleri corda tuendo  
Terribiles oculos villosaque fetis petiore.*

If we take a survey of serpents in general, they have marks by which they are distinguished from all the rest of animated nature. They have the length and the suppleness of the eel, but want fins to swim with; they have the scaly covering and pointed tail of the lizard, but they want legs to walk with; they have the crawling motion of the worm, but, unlike that animal, they have lungs to breathe with: like all the reptile kind, they are resentful when offended; and nature has supplied them with terrible arms to revenge every injury.

Though they are possessed of very different degrees of malignity, yet they are all formidable to man, and have a strong similitude of form to each other. With respect to their conformation, all serpents have a very wide mouth in proportion to the size of the head; and, what is very extraordinary, they can gape and swallow the head of another animal which is three times as big as their own. However, it is noway surprising that the skin of the snake should stretch to receive so large a morsel; the wonder seems how the jaws could take it

in.

Serpens.

in. To explain this, it must be observed, that the jaws of this animal do not open as ours, in the manner of a pair of hinges, where bones are applied to bones, and play upon one another: on the contrary, the serpent's jaws are held together at the roots by a stretching muscular skin; by which means they open as widely as the animal chooses to stretch them, and admit of a prey much thicker than the snake's own body. The throat, like stretching leather, dilates to admit the morsel; the stomach receives it in part, and the rest remains in the gullet, till putrefaction and the juices of the serpent's body unite to dissolve it.

4  
Their  
teeth.

Some serpents have fangs or canine teeth, and others are without them. The teeth in all are crooked and hollow; and, by a peculiar contrivance, are capable of being erected or depressed at pleasure.

5  
Eyes.

The eyes of all serpents are small, if compared to the length of the body; and though differently coloured in different kinds, yet the appearance of all is malign and heavy; and, from their known qualities, they strike the imagination with the idea of a creature meditating mischief. In some, the upper eyelid is wanting, and the serpent winks only with that below; in others, the animal has a nictitating membrane or skin, resembling that which is found in birds, which keeps the eye clean and preserves the sight. The substance of the eye in all is hard and horny; the crystalline humour occupying a great part of the globe.

The holes for hearing are very visible in all; but there are no conduits for smelling; though it is probable that some of them enjoy that sense in tolerable perfection.

6  
Tongue.

The tongue in all these animals is long and forked. It is composed of two long fleshy substances, which terminate in sharp points, and are very pliable. At the root it is connected very strongly to the neck by two tendons, that give it a variety of play. Some of the viper kind have tongues a fifth part of the length of their bodies; they are continually darting them out; but they are entirely harmless, and only terrify those who are ignorant of the real situation of their poison.

7  
Gullet.

If from the jaws we go on to the gullet, we shall find it very wide for the animal's size, and capable of being distended to a great degree; at the bottom of this lies the stomach, which is not so capacious, and receives only a part of the prey, while the rest continues in the gullet for digestion. When the substance in the stomach is dissolved into chyle, it passes into the intestines, and from thence goes to nourishment, or to be excluded by the vent.

8  
Lungs and  
heart.

Like most other animals, serpents are furnished with lungs, which we suppose are serviceable in breathing, though we cannot perceive the manner in which this operation is performed; for though serpents are often seen apparently to draw in their breath, yet we cannot find the smallest signs of their ever respiring it again. Their lungs, however, are long and large, and doubtless are necessary to promote their languid circulation. The heart is formed as in the tortoise, the frog, and the lizard kinds, so as to work without the assistance of the lungs. It is single; the greatest part of the blood flowing from the great vein to the great artery by the shortest course. By this contrivance of nature we easily gather two consequences; that snakes are amphibious, being equally capable of living on land

and in the water; and that also they are torpid in winter, like the bat, the lizard, and other animals formed in the same manner.

Serpens.

The vent in these animals serves for the emission of the urine and the feces, and for the purposes of generation. The instrument of generation in the male is double, being forked like the tongue; the ovaries in the female are double also; and the aperture is very large, in order to receive the double instrument of the male. They copulate in their retreats; and it is said by the ancients, that in this situation they appear like one serpent with two heads.

12  
Number of  
joints in  
the back-  
bone.

As the body of this animal is long, slender, and capable of bending in every direction, the number of joints in the back-bone are numerous beyond what one would imagine. In the generality of quadrupeds, they amount to not above 30 or 40; in the serpent kind they amount to 145 from the head to the vent, and 25 more from that to the tail. The number of these joints must give the back-bone a surprising degree of pliancy; but this is still increased by the manner in which each of these joints are locked into the other. In man and quadrupeds, the flat surfaces of the bones are laid one against the other, and bound tight by sinews; but in serpents, the bones play one within the other like ball and socket, so that they have full motion upon each other in every direction.

17  
Number of  
ribs.

Though the number of joints in the back-bone is great, yet that of the ribs is still greater; for, from the head to the vent, there are two ribs to every joint, which makes their number 290 in all. These ribs are furnished with muscles, four in number; which being inserted into the head, run along to the end of the tail, and give the animal great strength and agility in all its motions.

13  
Scales.

The skin also contributes to its motions, being composed of a number of scales, united to each other by a transparent membrane, which grows harder as it grows older, until the animal changes, which is generally done twice a-year. This cover then bursts near the head, and the serpent creeps from it by an undulatory motion, in a new skin, much more vivid than the former. If the old slough be then viewed, every scale will be distinctly seen like a piece of net-work, and will be found greatest where the part of the body they covered was largest.

There is much geometrical neatness in the disposal of the serpent's scales, for assisting the animal's sinuous motion. As the edges of the foremost scales lie over the ends of their following scales, so those edges, when the scales are erected, which the animal has a power of doing in a small degree, catch in the ground, like the nails in the wheel of a chariot, and so promote and facilitate the animal's progressive motion. The erecting these scales is by means of a multitude of distinct muscles with which each is supplied, and one end of which is tacked each to the middle of the foregoing.

In some of the serpent kind there is the exactest symmetry in these scales; in others they are disposed more irregularly. In some there are larger scales on the belly, and often answering to the number of ribs; in others, however, the animal is without them. Upon this slight difference, Linnæus has founded his distinctions of the various classes of the serpent tribe.

13  
Their size,  
the

When we come to compare serpents with each other,

**Serpent.** the first great distinction appears in their size; no other tribe of animals differing so widely in this particular. This tribe of animals, like that of fishes, seems to have no bounds put to their growth: their bones are in a great measure cartilaginous, and they are consequently capable of great extension: the older, therefore, a serpent becomes, the larger it grows; and as they seem to live to a great age, they arrive at an enormous size.

Leguat assures us, that he saw one in Java that was 50 feet long. Carli mentions their growing to above 40 feet; and we have now the skin of one in the British Museum that measures 32. Mr Wentworth, who had large concerns in the Barbices in America, assures us, that in that country they grow to an enormous length. He one day sent out a soldier, with an Indian, to kill wild-fowl for the table; and they accordingly went some miles from the fort: in pursuing their game, the Indian, who generally marched before, beginning to tire, went to rest himself upon the fallen trunk of a tree, as he supposed it to be; but when he was just going to sit down, the enormous monster began to move; and the poor savage perceiving that he had approached a *boa*, the greatest of all the serpent kind, dropped down in an agony. The soldier, who perceived at some distance what had happened, levelled at the serpent's head, and by a lucky aim shot it dead: however, he continued his fire until he was assured that the animal was killed; and then going up to rescue his companion, who was fallen motionless by its side, he, to his astonishment, found him dead likewise, being killed by the fright. Upon his return to the fort, and telling what had happened, Mr Wentworth ordered the animal to be brought up, when it was measured, and found to be 36 feet long. He had the skin stuffed, and then sent to Europe as a present to the prince of Orange, in whose cabinet it was lately to be seen at the Hague: but the skin is shrunk, by drying, two or three feet. In the East Indies they grow also to an enormous size, particularly in the island of Java, where, we are assured, that one of them will destroy and devour a buffalo. See BOA.

**14** **utteny,** But it is happy for mankind that the rapacity of these frightful creatures is often their punishment; for whenever any of the serpent kind have gorged themselves in this manner, whenever their body is seen particularly distended with food, they then become torpid, and may be approached and destroyed with safety. Patient of hunger to a surprising degree, whenever they seize and swallow their prey, they seem, like surfeited gluttons, unwieldy, stupid, helpless, and sleepy: they at that time seek some retreat, where they may lurk for several days together, and digest their meal in safety: the smallest effort at that time is capable of destroying them; they can scarce make any resistance; and they are equally unqualified for flight or opposition: that is the happy opportunity of attacking them with success; at that time the naked Indian himself does not fear to assail them. But it is otherwise when this sleepy interval of digestion is over; they then issue, with famished appetites, from their retreats, and with accumulated terrors, while every animal of the forest flies before them.

**15** **and absti-** But though these animals are of all others the most voracious, and though the morsel which they swallow without chewing, is greater than what any other crea-

**Serpent** ture, either by land or water, can devour; yet no animals upon earth bear abstinence so long as they. A single meal, with many of the snake kind, seems to be the adventure of a season; it is an occurrence, of which they have been for weeks, nay sometimes for months, in patient expectation. When they have seized their prey, their industry for several weeks is entirely discontinued; the fortunate capture of an hour often satisfies them for the remaining period of their annual activity. As their blood is colder than that of most other terrestrial animals, and as it circulates but slowly through their bodies, so their powers of digestion are but feeble. Their prey continues, for a long time, partly in the stomach, partly in the gullet, and is often seen in part hanging out of the mouth. In this manner it digests by degrees; and in proportion as the part below is dissolved, the part above is taken in. It is not therefore till this tedious operation is entirely performed, that the serpent renews its appetite and its activity. But should any accident prevent it from issuing once more from its cell, it still can continue to bear famine for weeks, months, nay for years together. Vipers \* are often kept in boxes for six or eight months, without any food whatever; and there are little serpents sometimes sent over to Europe from Grand Cairo, that live for several years in glasses, and never eat at all, nor even stain the glass with their excrements.

Other creatures have a choice in their provision: but the serpent indiscriminately preys upon all; the buffalo, the tiger, and the gazelle. One would think that the porcupine's quills might be sufficient to protect it; but whatever has life serves to appease the hunger of these devouring creatures: porcupines, with all their quills, have frequently been found in their stomachs when killed and opened; nay, they most frequently are seen to devour each other.

**17** **Places** A life of savage hostility in the forest offers the imagination one of the most tremendous pictures in nature. In those burning countries, where the sun dries up every brook for hundreds of miles round; when what had the appearance of a great river in the rainy season, becomes, in summer, one dreary bed of sand; in those countries, a lake that is never dry, or a brook that is perennial—is considered by every animal as the greatest convenience of nature. When they have discovered this, no dangers can deter them from attempting to slake their thirst. Thus the neighbourhood of a rivulet, in the heart of the tropical continents, is generally the place where all the hostile tribes of nature draw up for the engagement. On the banks of this little envied spot, thousands of animals of various kinds are seen venturing to quench their thirst, or preparing to seize their prey. The elephants are perceived in a long line, marching from the darker parts of the forest; the buffaloes are there, depending upon numbers for security; the gazelles relying solely upon their swiftness; the lion and tiger waiting a proper opportunity to seize; but chiefly the larger serpents are upon guard there, and defend the access of the lake. Not an hour passes without some dreadful combat; but the serpent, defended by its scales, and naturally capable of sustaining a multitude of wounds, is, of all others, the most formidable. It is the most wakeful also; for the whole tribe sleep with their eyes open, and are consequently for ever upon the watch: so that, till their rapacity is satisfied,

<sup>Serpens</sup> few other animals will venture to approach their station.

<sup>18</sup>  
The sound which they utter. In comparing serpents as to their voices, some are found silent, some have a peculiar cry; but hissing is the sound which they most commonly send forth, either as a call to their kind, or as a threat to their enemies. In the countries where they abound, they are generally silent in the middle of the day, when they are obliged to retire from the heat of the climate; but as the cool of the evening approaches, they are then heard issuing from their cells with continued hissings; and such is the variety of their notes, that some have assured us they very much resemble the music of an English grove. This some will hardly credit; at any rate, such notes, however melodious, can give but very little delight, when we call to mind the malignity of the minstrel. If considered, indeed, as they answer the animal's own occasions, they will be found well adapted to its nature, and fully answering the purposes of terrifying such as would venture to offend it.

<sup>19</sup>  
How they move. With respect to motion, some serpents, particularly those of the viper kind, move slowly; while others dart with amazing swiftness. The motion in all is similar; but the strength of body in some gives a very different appearance. The viper, that is but a slow feeble-bodied animal, makes way in a heavy undulating manner; advancing its head, then drawing up its tail behind, and bending the body into a bow; then from the spot where the head and tail were united, advancing the head forward as before. This, which is the motion of all serpents, is very different from that of the earth-worm or the naked snail. The serpent, as was said above, has a back-bone, with numerous joints; and this bone the animal has a power of bending in every direction, but without being able to shorten or lengthen it at pleasure. The earth-worm, on the other hand, has no back-bone; but its body is composed of rings, which, like a barber's puff, it can lengthen or shorten as it finds necessary. The earth-worm, therefore, in order to move forward, lengthens the body; then by the fore part clings to the ground where it has reached, and then contracts and brings up its rear: then, when the body is thus shortened, the fore-part is lengthened again for another progression, and so on. The serpent, instead of shortening the body, bends it into an arch; and this is the principal difference between serpentine and vermicular progression.

We have instanced this motion in the viper, as most easily discerned; but there are many serpents that dart with such amazing swiftness, that they appear rather to leap than crawl. It is most probable, however, that no serpent can dart upon even ground farther than its own length at one effort. Our fears indeed may increase the force of their speed, which is sometimes found so fatal. We are told by some, that they will dart to a very great distance; but this we have never been able to ascertain. The manner of progression in the swiftest serpent we know, which is the jaculus, is by instantly coiling itself upon its tail, and darting from thence to its full extent: then carrying the tail, as quick as lightning, to the head; coiling and darting again; and by this means proceeding with extreme rapidity, without ever quitting the ground. Indeed, if we consider the length and the weakness of the back-bone in all these animals; if we regard the make

of the vertebrae, in which we shall find the junctures all formed to give play, and none to give power; we cannot be of opinion that they have a faculty of springing from the ground, as they entirely want a *fulcrum*, if we may so express it, from whence to take their spring; the whole body being composed of unsupported muscles and joints that are yielding.

<sup>20</sup>  
Though all serpents are amphibious, some are much fonder of the water than others; and though destitute of fins or gills, remain at the bottom, or swim along the surface, with great ease. From their internal structure, we see how well adapted they are for either element: and how capable their blood is of circulating at the bottom as freely as in the frog or the tortoise. They can, however, endure to live in fresh water only; for salt is an effectual bane to the whole tribe. The greatest serpents are most usually found in fresh water, either choosing it as their favourite element, or finding their prey in such places in the greatest abundance. But that all will live and swim in liquids, appears from an experiment of Redi; who put a serpent into a large glass vessel of wine, where it lived swimming about six hours; though, when it was by force immersed and put under that liquid, it lived only one hour and a half. He put another in common water, where it lived three days; but when it was kept under water, it lived only about 12 hours. Their motion there, however, is perfectly the reverse of what it is upon land; for, in order to support themselves upon an element lighter than their bodies, they are obliged to increase their surface in a very artificial manner. On earth their windings are perpendicular to the surface; in water they are parallel to it: in other words, if a person should wave his hand up and down, it will give an idea of the animal's progress on land; if to the right and left, it will give some idea of its progress on the water.

<sup>21</sup>  
Factor. Some serpents have a most horrible factor attending them, which is alone capable of intimidating the brave. This proceeds from two glands near the vent, like those in the weasel or polecat; and, like those animals, in proportion as they are excited by rage or by fear the secret grows stronger. It would seem, however, that such serpents as are most venomous are least offensive in this particular; since the rattlesnake and the viper have no smell whatever; nay, we are told, that at Calcutt and Cranganon, in the East Indies, there are some very noxious serpents, who are so far from being disagreeable, that their excrements are sought after, and kept as the most pleasing perfume. The Esculapian serpent is also of this number.

<sup>22</sup>  
Some viviparous, others oviparous. Some serpents bring forth their young alive, as the viper; some bring forth eggs, which are hatched by the heat of their situation, as the common black snake, and the majority of the serpent tribe. When a reader, ignorant of anatomy, is told, that some of those animals produce their young alive, and that some produce eggs only, he is apt to suppose a very great difference in the internal conformation, which makes such a variety in the manner of bringing forth. But this is not the case: these animals are internally alike, in whatever manner they produce their young; and the variety in their bringing forth is rather a slight than a real discrimination. The only difference is, that the viper hatches her eggs, and brings them to maturity, within her body; the snake is more premature in her productions,

tions, and sends her eggs into the light some time before the young ones are capable of leaving the shell. Thus, if either are opened, the eggs will be found in the womb, covered with their membranous shell, and adhering to each other like large beads on a string. In the eggs of both, the young ones will be found, though at different stages of maturity: those of the viper will crawl and bite in the moment the shell that incloses them is broke open: those of the snake are not yet arrived at their perfect form.

Father Labat took a serpent of the viper kind that was nine feet long, and ordered it to be opened in his presence. He then saw the manner in which the eggs of these animals lie in the womb. In this creature there were six eggs, each of the size of a goose egg, but longer, more pointed, and covered with a membranous skin, by which also they were united to each other. Each of these eggs contained from 13 to 15 young ones, about six inches long, and as thick as a goose-quill. Though the female from whence they were taken was spotted, the young seemed to have a variety of colours very different from the parent; and this led the traveller to suppose that the colour was no characteristic mark among serpents. These little mischievous animals were no sooner let loose from the shell, than they crept about, and put themselves into a threatening posture, coiling themselves up and biting the stick with which he was destroying them. In this manner he killed 74 young ones; those that were contained in one of the eggs escaped at the place where the female was killed, by the bursting of the egg and their getting among the bushes.

The fascinating power ascribed to serpents, especially to rattlesnakes, by which they are said to draw animals to them, is very curious. It has been described by so many different persons, who affirmed that they had seen instances of it, and has been believed by so many men of penetration and discernment, that it deserves at least to be mentioned. The rattlesnake fixes its eyes upon any animal, such as a bird or squirrel. When the animal spies the snake, it skips from spray to spray, hovering and approaching nearer the enemy; descending, with distracted gestures and cries, from the top of the loftiest trees to the mouth of the snake, who opens his jaws, and in an instant swallows the unfortunate animal.

The following instances of fascination have so much the appearance of fiction, that it would require a very uncommon degree of evidence to render them credible. They are extracted from a paper in the Gentleman's Magazine for the year 1767, p. 511. which was communicated by Mr Peter Collinson from a correspondent in Philadelphia.

"A person of good credit was travelling by the side of a creek or small river, where he saw a ground squirrel running to and fro between the creek and a great tree a few yards distant; the squirrel's hair looking very rough, which showed he was scared, and his returns being shorter and shorter, the man stood to observe the cause, and soon spied the head and neck of a rattlesnake pointing at the squirrel through a hole of the great tree, it being hollow; the squirrel at length gave over running, and laid himself quietly down with his head close to the snake's; the snake then opened his mouth wide, and took in the squirrel's head; upon which the man gave

the snake a whip across the neck, and so the squirrel being released, he ran into the creek.

"When I was about 13 years old, I lived with William Atkinson, an honest man in Bucks county, who, returning from a ride in warm weather, told us, that while his horse was drinking at a run, he heard the cry of a blackbird, which he spied on the top of a sapling, fluttering and straining the way he seemed unwilling to fly, and holding so fast the sprigs he was perched upon that the sapling top bent. After he had viewed the bird a few minutes, it quitted the place, and made a circle or two higher in the air, and then resumed its former standing, fluttering and crying: Thereupon William rode the way the bird strained, and soon spied a large black snake in coil, steadily eyeing the bird. He gave the snake a lash with his whip, and this taking off the snake's eye from his prey, the charm was broken, and away fled the bird, changing its note to a song of joy.

"Mr Nicholas Scull, a surveyor, told me, that when he was a young man, as he happened once to be leaning upon a fence, and looking over it, he saw a large rattlesnake in coil, looking stedfastly at him. He found himself surpris'd and listless immediately, and had no power for about a minute (as he thinks) but to look at the snake, and then he had the resolution to push himself from the fence, and turn away, feeling such horror and confusion as he would not undergo again for any consideration.

"Doctor Chew tells me, a man in Maryland was found fault with by his companion that he did not come along; the companion stepping towards him, observed that his eyes were fixed upon a rattlesnake which was gliding slowly towards him, with his head raised as if he was reaching up at him; the man was leaning towards the snake, and saying to himself, *he will bite me! he will bite me!* Upon which his companion caught him by the shoulder, and pulled him about, and cried out, *What the devil ails you? He will bite you sure enough!* This man found himself very sick after his enchantment."

The fascinating power of serpents was believed by Dr Mead and other eminent men, who certainly thought they had sufficient evidence for admitting it. Incredible therefore as it appears, it ought not to be rejected without examination; though being of a very extraordinary nature, it cannot be received without unquestionable evidence. Scepticism is no less absurd than incredulity; and the true philosopher will carefully avoid both. Human knowledge is founded on observation and experience; not, however, on every man's personal observation and experience, but on the united observation and experience of all mankind. But this presupposes the credibility of human testimony in every case that does not involve an impossibility. All the laws of nature are not yet known, nor all the wonderful powers of which she is possessed. It is not more incredible *a priori*, that the eye of a serpent should attract an animal than that a magnet should attract a piece of iron, or a piece of iron attract electrical matter. The evidence of these facts rests entirely on personal observation or authentic testimony. The only thing requisite with respect to objects of testimony is, when the fact is so extraordinary as has not fallen within the observation of the generality of men, the strength

Serpent

of the evidence must be in proportion to the extraordinary nature of the fact. To apply this to the present case: We have the testimony of many persons that some serpents have a power of fascination; but the generality of men have never observed this; it is therefore an extraordinary fact, and requires extraordinary evidence. But the evidence is not satisfactory; therefore we do not receive it as a fact: on the other hand, it is unphilosophical to reject it *à priori*.

23  
How their  
poison ope-  
rates.

No subject has excited more philosophical controversy than the poison of serpents, with regard to its nature and mode of operating. Antiquity has not been sparing in conjecture and fiction upon this subject, and its errors have been retained with the most reverential obstinacy by the vulgar: among these we are to reckon the fictitious sting fixed in the tail of the serpent, as the painters sometimes have groundlessly enough represented it; some have invented a similar fiction of a black forked tongue, which the serpent vibrates on both sides, and have ascribed its power of producing such noxious effect to this; while others, affecting an air of superior discernment, have, upon equally good reasons, ascribed it to the teeth in general: these are all errors of a magnitude that the most desultory attention to the subject would have been sufficient to have removed. There is a very small bone closely fixed to the upper jaw, in the inside of the lip of a poisonous serpent, which has a power of moving backward or forward; to this two or three fangs are annexed larger than the teeth, which the serpent, by its assistance, when enraged, darts forward, or withdraws and conceals at his pleasure, in a similar manner to the claws of a cat: these fangs, which the common people name the large teeth of the serpent, are excellently described by Tyson in the anatomy of the rattlesnake, which he has given in the Philosophical Transactions. "In these (the fangs) we observed a considerable cavity near the base; and near the point a very discernible fissure of some length like the slit of a pen: the part of the tooth from the fissure to the root was manifestly channelled, which we first discovered by lightly pressing the gums; we then saw the poison ascend through the cavity of the fang and flow out of the fissure; and as these fangs are so very acute, so firm and solid toward the point (the fissure being on the external and convex, not the internal side), nothing could be conceived more convenient either for inflicting a wound, or to insure the infusion of the poison." Each of the fangs is surrounded with a vesicle furnished with glands secreting a certain fluid; which, upon the vesicle being pressed, seems to flow out of the point of the fang. The serpent when incensed, raising his head, extends the small bone armed with the fangs mentioned above; and attacking his enemy with a force combined of the weight of his body and the action of the muscles, he wounds him with the expanded fangs, and the vesicle being compressed the poison immediately flows into the wound: this is clear from the experience of those who, having broken off their fangs with a pair of forceps, handled the serpent thus disarmed without any hurt. The North Americans, after carefully extracting these venomous fangs, suffer the rattlesnake to bite and gnaw them with his teeth till the blood flows freely, with total impunity.

Antiquity amused itself with a fable destitute of all appearance of truth, that anger was excited by black

bile: they applied this fiction without hesitation to the present subject, and founded an hypothesis upon it, to account for the effects of the bite of an incensed serpent; pretending to have discovered an ideal canal which conducted the bile from its vesicle to the mouth of the serpent, whence it flowed into the part bitten, and produced the most fatal symptoms. But toward the end of the last century, this subject was greatly illustrated under the auspices of Ferdinand II Great Duke of Tuscany: This prince, desirous of inquiring into that mysterious question, the nature of serpents, invited Steno, Rhedi, and some other philosophers of the first eminence, to his court; and a multitude of the most poisonous serpents being collected, Rhedi made several experiments upon them, which discovered to him a number of particulars before unknown; of which the following seem to have the best claim to our attention. When he either caused a living viper to bite a dog, or wounded him with the teeth of one newly dead (the poisonous vesicle remaining unbroken), the event was the same. If the bite was repeated, its effect became weaker, and at last was lost, the poison contained in the vesicle being totally exhausted. That the teeth of serpents, when extended to bite, were moistened over with a certain liquor; and when the vesicle at the base was pressed, a drop of poison flowed to the point of the fang. When the poison thus flowing from the vesicle was received in soft bread or a sponge, an animal bitten by the serpent received no more harm from the wound than from being pricked by a needle, till after a few days, when the venom was restored afresh: but when an animal was wounded with the point of a needle dipped in the poison, it was tormented with the same pains as if it had been bitten by the viper itself. Preserving some of this poison in a glass, and totally evaporating the moisture in the sun, when the residuum was diluted again with water, and the point of a needle dipped in the solution, Rhedi found to his great surprise that it had the same effect as when recent. But the boldness of Tozzi, one who charmed vipers, struck all these men who were deeply versed in natural philosophy into the utmost astonishment. They happening to fall into discourse (while the prince was present) upon the certain death which would attend any person's swallowing this poison of the viper by mistake, instead of spirit of wine or water; Tozzi, confiding in his art, drank a considerable portion of it without hesitation: they were all astonished at his apparent rashness, and predicted instant death to the man; however, he escaped as safely as if he had drunk only so much water. This event, which struck the prince and his illustrious associates in these philosophical inquiries by its novelty, was well known to the ancients. Lucan, in the 9th book of the Pharsalia, speaking of the serpent, says,

*Noxia serpentum est admisso sanguine pestis  
Morsu virus habent et satum dente minantur,  
Pocula morte carent.* Phar. l. 9. v. 614.

Mix'd with the blood that venom slays alone,  
His bite is poison; death is in his fang;  
Yet is the draught innocuous.

Nor must we omit observing, that barbarous nations are perfectly acquainted with the property of the poison of serpents by which it retains its deadly power af-

ter



ter it has been long kept: they have been possessed of this fatal secret for ages past; it being their custom to tinge the points of their arrows with the juice of spurge, putrid flesh, or oil of tobacco, but more particularly with the poison of vipers. Some modern Indians continue the practice to this day; and we have the testimony of Pliny, in his Natural History, that the Scythians had long ago the same custom: "The Scythians (says that author) dip their arrows in the poison of vipers and human blood; a horrid practice, as the slightest wound inflicted by one of them defies all the art of medicine."

The poison of serpents produces fatal effects only by mixing with the blood. To confirm this principle, the Florentine philosophers collected a quantity of poison, and gave it to different animals without producing the least inconvenience; but when applied to an external wound, every one of those horrid symptoms which accompany the real bite followed, viz. inflammatory and malignant fevers, ending in death, unless nature, by a spontaneous hemorrhage, or some other evacuation, discharged this poison. With respect to the experiments of Rhedi, every one of his observations prove, that the liquid pressed out of the vesicle which moistens the fangs of the serpents is only noxious by being conveyed into the blood, by means of a puncture or wound; and the case of Tozzi, who drank a considerable quantity of this poison without suffering injury, proves that it hurts the blood only when externally mixed with it.

The symptoms of the bite of the viper have already been described under MEDICINE, n<sup>o</sup> 408. with the cures recommended by Dr Mead for the bite of serpents in general. Under the article POISON, p. 269. we have mentioned the Abbé Fontana's method of cure, viz. ligatures, and the beneficial effects of the volatile alkali. We shall now therefore supply what has been omitted in these articles, by describing the symptoms which accompany the bite of other serpents.

The symptoms attending the bite of the *coluber presler*, a native of Sweden, are, pain in the wound, tumor, thirst, asthma, anxieties, convulsions, and death.

There is a serpent still more dreadful than any of the former, found in Sweden, called *coluber carcia*. The bite of this is followed by immediate change of colour, coldness, stupor, palpitation of the heart, acute pain all over the body, and death. Linnæus tried oil in this case, but it proved ineffectual.

The *crotalus horridus* of Linnæus, the rattlesnake, kills in a very sudden manner; his bite usually producing death within twelve hours.

The following account of the poison serpent of the East Indies is given by M. d'Obsonville. "Among the serpents of India, that which I believe to be most formidable is but about two feet long, and very small. Its skin is freckled with little traits of brown or pale red, and contrasted with a ground of dirty yellow: it is mostly found in dry and rocky places, and its bite mortal in less than one or two minutes. In the year 1759, and in the province of Cadapet, I saw several instances of it; and among others, one very singular, in the midst of a corps of troops commanded by M. de Buffly. An Indian Gentoo merchant perceived a Mahometan soldier of his acquaintance going to kill one of these reptiles, which he had found sleeping under his packet,

the Gentoo flew to beg its life, protesting it would do no hurt if it was not first provoked; passing at the same time his hand under its belly to carry it out of the camp, when suddenly it twisted round, and bit his little finger; upon which this unfortunate martyr of a fanatic charity gave a shriek, took a few steps, and fell down insensible. They flew to his assistance, applied the serpent stone, fire, and scarifications, but they were all ineffectual, his blood was already coagulated. About an hour after, I saw the body as they were going to burn it, and I thought I perceived some indications of a complete dissolution of the blood.

"The *serpens bruians*, or burning serpent, is nearly of the same form with the last mentioned; its skin is not quite of so deep a brown, and is speckled with dark green spots; its poison is almost as dangerous, but it is less active, and its effects are very different: in some persons it is a devouring fire, which, as it circulates through the veins, presently occasions death; the blood dissolves into a lymphatic liquor, resembling thin broth, without apparently having passed through the intermediate state of coagulation, and runs from eyes, nose, and ears, and even through the pores. In other subjects, the poison seems to have changed the very nature of the humours in dissolving them; the skin is chapped and becomes scaly, the hair falls off, the members are tumefied, the patient feels all over his body the most racking pains, numbness, and is not long in perishing. It is said, however, that people have been cured by remedies well and soon applied. Be that as it may, it seems to me that the poison of these different reptiles is in general more powerful the more they live in hot and dry places, where they feed upon insects that are full of saline, volatile, and acrimonious particles."

We are ignorant of what specie the *hemorrhoidis* was, which is described by Lucan as causing by its bite a flux of blood from every part of the body. But the bite of an American serpent named *de ia crux* kills in the same manner.

The *dipsas* is at present likewise unknown. Lucan informs us, that the person wounded by it was attacked by an unquenchable thirst. This is finely painted by him; where A. Tufcus, standard-bearer of Cato, is described as bitten by that serpent:

*Non decus imperii, nor mæsti jura Catonis  
Ardentem tenuere virum, quin spargere signa  
Auderet, totisque furens exquereret agris  
Quas poscebat aquas sitiens in corde venenum.*

Pharsal. l. 9.

His wild impatience, not his honour'd state,  
Nor sorrowing Cato's high command, restrain;  
Furious, dishonour'd in the dust, he flings  
His sacred eagle, and o'er all the fields  
Rapid he hurries to seek the cooling stream,  
To quench the thirsty poison in his breast.

And a few verses after:

*Scrutatur venas penitus squalentis arenæ  
Nunc redit ad Syrtes, et fluctus accipit are,  
Aqueasque placet, sed non sibi sufficit humor,  
Nec sentit fatigue genus, mortemque veneni,  
Sed putat esse suum; ferroque aperire tumentes  
Sustinuit venas, atque os implete cruore.*

Q 9 2

New

Serpent.

Now tearing up the sands, some latent vein  
Frustrate he seeks; now to the Syrtes shore  
Return'd, he swallows down the briny flood  
Mix'd with its rolling sands; nor knows his fate  
And the sad poison's death, but calls it thirst;  
Then with his sword opens his spouting veins,  
And drinks the burbling blood. —

The *phytas*, or *amodytes* of Linnæus, or, according to others, the *coluber aspis*, seems to have been the serpent made use of by Cleopatra to destroy herself. This woman, to terminate a dissipated life with an easy death, ordered her physicians to prepare a poison for her which might best effect this purpose. Having tried a number of different experiments upon condemned criminals, they at last discovered this species of asp, which brings on death without any previous appearance of distemper or hiccough: the face seems in a slight perspiration, an easy insensibility and lethargy creeps upon the whole frame, and the person bitten seems almost totally ignorant of his approaching dissolution. Having acquainted the queen with their discovery, she applied the asp either to her bosom or her arms; or, according to some authors, dipping the point of a needle in the poison, and pricking herself with it, she expired in an easy sleep.

The bite of the *naja* is so fatal, that a man dies by it in the space of an hour, his flesh entirely falling off his bones in a semidissolved putrid state: this makes it probable that it is the same serpent which the ancients named the *sepe*.

The experiments of Rhedi have not, in the opinion of some celebrated philosophers, so far cleared the theory of the operation of the poison of the viper, as to leave nothing further to be desired upon that subject. Fontana and Carminati have endeavoured to investigate its operations more clearly. Carminati, from 11 experiments, deduces the following conclusions: 1. That if poison be infused into a nerve, the animal wounded dies almost instantly; and the whole nervous system, to which it is rapidly conveyed, is deprived of its quality called *sensibility*. 2. If a muscle be wounded, it is deprived of its irritability. This is confirmed by the experiments of Fontana. 3. The poison injected into a wounded muscle or tendon is considerably longer in killing an animal than that introduced into a nerve. 4. The symptoms which precede the death of the animal bitten are, a stupor, lethargy, tremors, convulsions, paralysis of the legs (part wounded), entire dissolution of the limbs. The blood is not always coagulated, nor its crasis dissolved. Marks of inflammation are sometimes discovered in certain parts of the animal after death, sometimes not: these are the effects of spasms and convulsions, not of the poison. 5. Not the least sign of the jaundice was discoverable in the eyes of any of the animals upon which Carminati made his experiments. 6. The stomach in every one of them was very much inflated; a symptom remarked only by Fallopius and Albertini. 7. A ligature applied instantly above the part bitten, if it be so placed as to admit one, was found by some experiments a good preventative against the diffusion of the poison: its compression should be considerable, but not excessive.

As few serpents, comparatively speaking, are poisonous, it may be interesting to our readers to know what

are the characteristics which distinguish poisonous from harmless serpents. The external characteristics of the poisonous tribe are these:

“1. A broad head, covered with small scales, though it be not a certain criterion of venomous serpents, with some few exceptions, a general character of them.”

“2. A tail under one-fifth of the whole length is also a general character of venomous serpents; but, since many of those which are not venomous have tails as short, little dependence can be placed upon that circumstance alone. On the other hand, a tail exceeding that proportion, is a pretty certain mark that the species to which it belongs is not venomous.”

“3. A thin and acute tail is by no means to be considered as peculiar to venomous serpents; though a thick and obtuse one is only to be found among those which are not venomous.”

“4. Carinated scales are, in some measure, characteristic of venomous serpents, since in them they are more common than smooth ones, in the proportion of nearly four to one; whereas smooth scales are, in those serpents which are not venomous, more common, in the proportion of nearly three to one.”

“Upon the whole, therefore, it appears, that though a pretty certain conjecture may, in many instances, be made from the external characters, yet, in order to determine with certainty whether a serpent be venomous or not, it becomes necessary to have recourse to some certain diagnostic. This can only be sought for in the mouth: we must therefore next consider how the fangs, with which the mouths of venomous serpents are furnished, are to be distinguished from common teeth.”

“To those who form their ideas of the fangs of a venomous serpent, from those of the rattlesnake, or even from those of the English viper, it will appear strange that there should be any difficulty in distinguishing those weapons from common teeth; and indeed the distinction would really be very easy, were all venomous serpents furnished with fangs as large as those of the fore-mentioned species. But the fact is, that in many species the fangs are full as small as common teeth, and consequently cannot, by their size, be known from them; this is the case with the *coluber laticaudatus*, *laeteus*, and several others.”

Linnæus thought that the fangs might be distinguished by their mobility and situation; but other naturalists have not found it a general fact that fangs are loose in their sockets, nor have they observed any difference in situation between the fangs of venomous serpents and the teeth of others. The following distinction is established by Dr Gray in a paper inserted in the Philosophical Transactions, Vol. lxxix. *All venomous serpents have only two rows of teeth in the upper jaw, and all others have four.*

In the preface to the *Museum Regis*, and in the introduction to the class amphibia in the *Systema Naturæ*, Linnæus says, that the proportion of venomous serpents to others is one in ten; yet, in the *Systema Naturæ*, of which the sum total in species is 131, he has marked 23 as venomous, which is somewhat more than one in six. How he came to be so much at variance with himself, it is not easy to say; but the last mentioned proportion seems to be not far from the truth, as Dr Gray, after examining 154 species of serpents, found only 26 that seemed to be venomous.

The

*Serpent.* The *coluber solatus* and *myterizans*, though marked by Linnæus, we are assured by Dr Gray are not poisonous: he thinks the same may be said of the *leberis* and *dypsis*. On the other hand, he observes, that the *boa conortrix*, *coluber cerastes*, *laticaudatus*, and *coluber fulvus*, none of which are marked in the *Systema Nature*, are all poisonous.

In addition to the method of cure mentioned in the articles referred to above, we shall subjoin the prescription of a new author, Dr Moseley\*, who spent 12 years in the West Indies, and whose abilities and extensive practice very justly intitle his opinion to a place in this work, to the attention of the public, and to all medical gentlemen going to the West Indies.

26  
Mose-  
y, m-  
d of  
e.  
p. 32.  
The bites and stings of all venomous animals are cured by the same local means; which are very simple, if they were always at hand. The injured part must be instantly destroyed or be cut out. Destroying it is the most safe, and equally certain: and the best application for that purpose is the lapis infernalis or the butter of antimony.—These are preferable to an hot iron, which the ancients used, because an hot iron forms a crust, which acts as a defence to the under parts, instead of destroying them. The lapis infernalis is much better than any other caustic, as it melts and penetrates during its application. The bitten part must be destroyed to the bottom, and where there is any doubt that the bottom of the wound is not sufficiently exposed, butter of antimony should be introduced into it on the following day, as deep as possible; and incisions should be made to lay every part open to the action of these applications. Besides destroying, burning, or cutting out the part, incisions should be made round the wound, to prevent the communication of the virus. The wound is to be dressed for some time with poultices, to alluage the inflammation caused by the caustics; and afterwards with acrid dressings and hot digestives to drain the injured parts.

“Where the above-mentioned caustics cannot be procured, corrosive sublimate, oil of vitriol, aquafortis, spirit of salt, common caustic, or a plaster made of quicklime and soap, may be applied to the wound. Gunpowder laid on the part, and fired, has been used with success. When a person is bitten remote from any assistance, he should make a tight ligature above the part, until proper application can be made. The Spanish writers say, that the *habilla de Cartagena*, or Cartagena bean, is a specific for poisonous bites, taken inwardly.

“Ulloa says, it is ‘one of the most effectual antidotes known in that country (Cartagena) against the bites of vipers and serpents: for a little of it being eaten immediately after the bite, it presently stops the effects of the poison; and accordingly all who frequent the woods, either for selling trees or hunting, never fail to eat a little of this habilla fasting, and repair to their work without any apprehension.

‘The natives tell you, that this habilla being hot in the highest degree, much of it cannot be eaten; that

the common dose of it is less than the fourth part of a kernel; and that no hot liquor, as wine, brandy, &c. must be drunk immediately after taking it.’

“The Cartagena bean, or habilla, is found in great abundance in the West Indian islands, where it is generally known by the name of *Antidote* or *Cocoon*, or *Antidote Cocoon*. In small doses it is stomachic and diaphoretic; and in large doses emetic and purgative. In several disorders it is a powerful remedy; but its virtues are not sufficiently known, except among the Indians and negroes, who chiefly use an infusion or tincture of it made in rum. This is externally as well as internally used for many complaints (A).

“I have been informed by some intelligent Indians, that any of the red peppers, such as bird pepper, or bell pepper, or what is called *Cayenne pepper*, powdered and taken in a glass of rum as much as the stomach can possibly bear, so as to cause, and keep up for some time, great heat and inflammation in the body and a vigorous circulation, will stop the progress of the poison of serpents, even after its effects are visible; and that the bitten part only afterwards mortifies and separates, and that the patient, with bark, wine, and cordials, soon recovers.

“This fiery practice is certainly agreeable to that of the ancients, and probably the only internal treatment that can have any good effect; as in these cases the powers of life, and the action of the heart, are suddenly enfeebled, and the pulse in strength and frequency observes almost a regular declension from the time of the bite until it entirely ceases in death.”

*Polygala senega*, or rattle-snake-root, was formerly considered as a sovereign remedy for the bite of the rattle-snake; but this opinion is now exploded. <sup>27</sup> Why some serpents are poisonous.

If it be asked for what purpose were serpents created with such destructive weapons? we answer, that they were given for self-defence. Without these, serpents, of all other animals, would be the most exposed and defenceless; without feet for escaping a pursuit, without teeth capable of inflicting a dangerous wound, or without strength for resistance; incapable, from their size, of finding security in very small retreats like the earthworm, and disgusting all from their deformity, nothing was left for them but a speedy extirpation. But furnished as they are with powerful poison, every rank of animals approach them with dread, and never seize them but at an advantage. Nor is this all the benefit they derive from it. The malignity of a few serves for the protection of all. Though not above a tenth of their number are actually venomous, yet the similitude they all bear to each other excites a general terror of the whole tribe; and the uncertainty of their enemies about what serpents are poisonous, makes even the most harmless formidable. Thus Providence seems to have acted with double precaution: it has given some of them poison for the general defence of a tribe naturally feeble; but it has thinned the numbers of those which are venomous, lest they should become too powerful for the rest of animated nature.

From

(A) “This bean is the seed of the *Fevillea foliis cordatis* of Plumier, Ed. Burmanni, p. 203. tab. 209<sup>o</sup> *Fevillea foliis cordatis*, angulatis, of Linnæus, Spec. P. *Fevillea foliis crassioribus*, glabris, quandoque cordatis, quandoque trilobis, or *Antidote Cocoon*, of Brown, p. 374.”

serpent.

28  
Enemies  
of  
serpents.

\* See VI.  
VERRA and  
DU.

From these noxious qualities in the serpent kind, it is no wonder that not only man, but beasts and birds, carry on an unceasing war against them. The ichneumon of the Indians, and the peccary\* of America, destroy them in great numbers. These animals have the art of seizing them near the head; and it is said that they can skin them with great dexterity. The vulture and the eagle also prey upon them in great abundance; and often, sailing down from the clouds, drop upon a long serpent, which they snatch up struggling and writhing in the air. Dogs also are bred up to oppose them. Father Feuillée tells us, that being in the woods of Martinico, he was attacked by a large serpent, which he could not easily avoid, when his dog immediately came to his relief, and seized the assailant with great courage. The serpent entwined him, and pressed him so violently, that the blood came out of his mouth, and yet the dog never ceased till he had torn it to pieces. The dog was not sensible of his wounds during the fight; but soon after his head swelled prodigiously, and he lay on the ground as dead. But his master having found a banana tree hard by, he applied its juice mixed with treacle to the wounds, which recovered the dog, and quickly healed his sores.

§ See  
ASTELL.

29  
Some per-  
sons fa-  
mous for  
charming  
them.

The Pylli of old were famous for charming and destroying serpents. Some moderns pretend to the same art. Casaubon says that he knew a man who could at any time summon 100 serpents together, and draw them into the fire. Upon a certain occasion, when one of them, bigger than the rest, would not be brought in, he only repeated his charm, and it came forward, like the rest, to submit to the flames. Philostratus describes particularly how the Indians charm serpents, "They take a scarlet robe, embroidered with golden letters, and spread it before a serpent's hole.—The golden letters have a fascinating power; and by looking stedfastly, the serpent's eyes are overcome and laid asleep." These and many other feats have been often practised upon these animals by artful men, who had first prepared the serpents for their exercise, and then exhibited them as adventitiously assembled at their call. In India there is nothing so common as dancing serpents, which are carried about in a broad flat vessel, somewhat resembling a sieve. These erect and put themselves in motion at the word of command. When their keeper sings a slow tune, they seem by their heads to keep time; when he sings a quicker measure, they appear to move more brisk and lively. All animals have a certain degree of docility; and we find that serpents themselves can be brought to move and approach at the voice of their master. From this trick, successfully practised before the ignorant, it is most probable has arisen most of the boasted pretensions which some have made to charming of serpents; an art to which the native Americans pretend at this very day, but the existence of which we are assured of by Mr Hasselquist amongst the native Egyptians.

30  
Regarded  
with veneration  
in  
some coun-  
tries.

Though the generality of mankind regard this formidable race with horror, yet there have been some nations, and there are some at this day, that consider them with veneration and regard. The adoration paid by the ancient Egyptians to a serpent is well known: many of the nations at present along the western coast of Africa retain the same unaccountable veneration. Up-

on the gold and slave coasts, a stranger, upon entering the cottages of the natives, is often surpris'd to see the roof swarming with serpents, that cling there without molesting and unmolested by the natives. But his surprize will increase upon going farther southward to the kingdom of Widah, when he finds that a serpent is the god of the country. This animal, which travellers describe as a huge overgrown creature, has its habitation, its temple, and its priests. These impress the vulgar with an opinion of its virtues; and numbers are daily seen to offer not only their goods, their provisions, and their prayers, at the shrine of their hideous deity, but also their wives and daughters. These the priests readily accept of, and after some days of peace return them to their suppliants, much benefited by the serpent's supposed embraces.

SERPENT, a musical instrument, serving as a basis to the cornet, or *small shawm*, to sustain a chorus of fingers in a large edifice. It has its name *serpent* from its figure, as consisting of several folds or wreaths, which serve to reduce its length, which would otherwise be six or seven feet.

It is usually covered with leather, and consists of three parts, a mouth-piece, a neck, and a tail. It has six holes, by means whereof it takes in the compass of two octaves.

Mersennus, who has particularly described this instrument, mentions some peculiar properties of it, *e. gr.* that the sound of it is strong enough to drown 20 robust voices, being animated merely by the breath of a boy, and yet the sound of it may be attuned to the softness of the sweetest voice. Another peculiarity to this instrument is, that great as the distance between the third and fourth hole appears, yet whether the third hole be open or shut, the difference is but a tone.

SERPENT, in mythology, was a very common symbol of the sun, and he is represented biting his tail, and with his body formed into a circle, in order to indicate the ordinary course of this luminary, and under this form it was an emblem of time and eternity. The serpent was also the symbol of medicine, and of the gods which presided over it, as of Apollo and Æsculapius: and this animal was the object of very ancient and general worship, under various appellations and characters. In most of the ancient rites we find some allusion to the serpent, under the several titles of Oh, Ops, Python, &c. This idolatry is alluded to by Moses, (Lev. xx. 27.) The woman at Endor who had a familiar spirit is called Oub, or Ob, and it is interpreted Pythonissa. The place where she resided, says the learned Mr Bryant, seems to have been named from the worship then instituted; for Endor is compounded of *En-ador*, and signifies *sons Pythonis*, "the fountain of light, the oracle of the god Ador, which oracle was probably founded by the Canaanites, and had never been totally suppressed. His pillar was also called *Abbadir*, or *Abadir*, compounded of *ab* and *adir*, and meaning the serpent deity Addir, the same as Adorus.

In the orgies of Bacchus, the persons who partook of the ceremony used to carry serpents in their hands, and with horrid screams call upon Eva! Eva! Eva being, according to the writer just mentioned, the same as epha, or opha, which the Greeks rendered *ophis*, and by it denoted a serpent. These ceremonies and

Serpent

*serpent*  
*serpentarius.*  
this symbolic worship began among the Magi, who were the sons of Chus; and by them they were propagated in various parts. Wherever the Amonians founded any places of worship, and introduced their rites, there was generally some story of a serpent. There was a legend about a serpent at Colchis, at Thebes, and at Delphi; and likewise in other places. The Greeks called Apollo himself Python, which is the same as Opis, Oupis, and Oub.

In Egypt there was a serpent named Thermuthis, which was looked upon as very sacred; and the natives are said to have made use of it as a royal tiara, with which they ornamented the statues of Isis. The kings of Egypt wore high bonnets, terminating in a round ball, and surrounded with figures of asps; and the priests likewise had the representation of serpents upon their bonnets.

Abaddon, or Abaddon, mentioned in the Revelations xx. 2. is supposed by Mr Bryant to have been the name of the Ophite god, with whose worship the world had been so long infected. This worship began among the people of Chaldea, who built the city of Ophis upon the Tigris, and were greatly addicted to divination, and to the worship of the serpent. From Chaldea the worship passed into Egypt, where the serpent deity was called Canoph, Can-oph, and C'neph. It had also the name of Ob or Oub, and was the same as the Basiliscus or royal serpent, the same as the Thermuthis, and made use of by way of ornament to the statues of their gods. The chief deity of Egypt is said to have been Vulcan, who was styled Opas. He was the same as Osiris, the Sun, and hence was often called Ob-el, or Pytho-sol; and there were pillars sacred to him, with curious hieroglyphical inscriptions bearing the same name; whence among the Greeks, who copied from the Egyptians, every thing gradually tapering to a point was styled obelos, or obeliscus.

As the worship of the serpent began among the sons of Chus, Mr Bryant conjectures, that from thence they were denominated Ethiopians and Aethiopiens, from Ath-ope or Ath-opes, the god whom they worshipped, and not from their complexion: the Ethiopians brought these rites into Greece, and called the island where they first established them *Ellopia*, *Solis Serpentis insula*, the same with *Eubia*, or *Oubaia*, i. e. "the serpent island." The same learned writer discovers traces of the serpent worship among the Hyperboreans, at Rhodes, named Ophiusa, in Purygia, and upon the Hellespont, in the island Cyprus, in Crete, among the Athenians, in the name of Cecrops, among the natives of Thebes in Bœotia, among the Lacedæmonians, in Italy, in Syria, &c. and in the names of many places, as well as of the people where the Ophites settled. One of the most early heresies introduced into the Christian church was that of the Ophites. Bryant's *Analysis of Ancient Mythology*, vol. i. p. 43, &c. p. 473, &c.

*Serpent Stones.* See *Column Ammonis*.

*Sea-Serpent.* See *SEA-Serpent*.

*SERPENTARIA*, SNAKE-ROOT; a species of *ARISTOLOCHIA*.

*SERPENTARIUS*, in astronomy, a constellation of the northern hemisphere, called also Ophiuchus, and anciently *Æsculapius*. The stars in the constellation *Serpentarius*, in Ptolemy's catalogue, are 29; in Tycho's

15; in Hevelius's 40; in the *Britannic catalogue* they are 74. *Serpentine.*

*SERPENTINE*, in general, denotes any thing that resembles a serpent; hence the worm or pipe of a still, twined in a spiral manner, is termed a *serpentine worm*.

*Serpentine Stone*, a genus of magnesian earths, of which there are different species: 1. The fibrous, composed of fibrous and coherent particles. This resembles the asbestos so much that it might be confounded with it, were not the fibres of the serpentine so closely coherent, that they cannot be distinguished when the stone is cut or polished. The fibres themselves are large, and seem to be twined. There are two varieties, a dark green and a light one; the former from Germany, the latter from Sweden. 2. The zoeblytz serpentine, found near that place, of many different colours, as black, deep green, light green, red, bluish-grey, and white; but the green colour is most predominant. 3. Porcelain earth mixed with iron. It is met with either dissoluble in water or indurated. The former is found of a red colour from China and Montmartre. The water-clinkers, imported from some places in Germany, seem to be made of this kind of earth. There are two varieties of the indurated kind, viz. the martial soap-earth, of a red colour, from Jafberg and other places in Norway, or black from some parts of Sweden. 4. The telgison of the Swedes, the same with the lapis ollaris. It is found in various places of Norway, as light grey, dark grey, whitish-yellow, and dark green. It is employed with great advantage for building fire-places, furnaces, &c. the extremities of the strata being turned towards the fire when it is flaty.

M. Magellan observes, that there is a great variety of colour as well as composition in this kind of stones; it being found either white, green, brown, yellow, light-blue, black, spotted, or streaked with veins of different colours. Its texture is either indistinct, obscurely laminar, or fibrous. The specific gravity is from 2400 to 2650; and it is harder than soap-rock or steatites; though not hard enough to strike fire with steel; being less smooth to the touch than steatites, but susceptible of a good polish, looking like marble; and is often met with in thin semitransparent plates. It melts in a strong heat without addition, and corrodes the crucibles, but hardens in a lower degree of heat. It is slowly and partially soluble in acids, but does not effervesce with them. According to Bayou's analysis, 100 parts of it contain about 41 of silice, or rather mica; 33 of magnesia; 10 of argillaceous earth; 12 of water, and about 3 of iron. That brought from Corsica contains a greater proportion of argil, and a smaller one of silice. The serpentine commonly so called, according to Fabroni, is a true lapis ollaris; but has its name from being variegated with green, yellowish, and brown spots, like the skin of some serpents; great quantities of it are found in Italy and Switzerland, where it is frequently worked into dishes and other vessels.

*Serpentine vers.*, are such as begin and end with the same word. As,

*Ambo florentes atatibus, Arcades ambo.*

*Serpentine*, in the *Manege*. A horse is said to have a serpentine tongue, if it is always frisking and moving, and sometimes passing over the bit, instead of keeping

*Serpicula* keeping in the void space, called the liberty of the tongue.

*Serratula*.

SERPICULA, in botany; a genus of plants belonging to the class of monocœcia, and to the order of tetrandria. The male calyx is quadridentate, and the corolla consists of four petals: The female calyx is divided into four parts, and the pericarpium is a tomentose nut. There are two species, the verticillata and repens.

SERPIGO, in surgery, a kind of herpes, popularly called a letter or ringworm. See SURGERY.

SERPULA, in natural history; a genus belonging to the class of vermes, and to the order of testacea. The shell is single, tubular, and adhering to other bodies. The animal which inhabits it is the terebella.

SERRANUS (Joannes), or John de Serres, a learned French Protestant, was born about the middle of the sixteenth century. He acquired the Greek and Latin languages at Laufanne, and grew very fond of the philosophy of Aristotle and Plato. On his return to France he studied divinity. He began to distinguish himself in 1572 by his writings, but was obliged to forsake his country after the dreadful massacre of St Bartholomew. He became minister of Nismes in 1582, but was never regarded as a very zealous Calvinist: he has even been suspected, though without reason, of having actually abjured the Protestant religion. He was one of the four clergymen whom Henry IV. consulted about the Romish religion, and who returned for answer, that Catholics might be saved. He wrote afterwards a treatise in order to reconcile the two communions, entitled *De fide Catholica, sive de principiis religionis Christianæ, communi omnium Christianorum consensu, semper et ubique ratæ*. This work was disliked by the Catholics, and received with such indignation by the Calvinists of Geneva, that many writers have affirmed that they poisoned the author. It is certain at least that he died at Geneva in 1598, at the age of 50. His principal works are, 1. A Latin translation of Plato, published by Henry Stephens, which owes much of its reputation to the elegance of the Greek copy which accompanies it. 2. A Treatise on the Immortality of the Soul. 3. *De statu religionis et reipublicæ in Francia*. 4. *Mémoire de la 3me guerre civile et derniers troubles de France sous Charles IX. &c.* 5. *Inventaire general de l'Hist. stoire de France, illustre par la conference de l'Eglise et de l'Empire, &c.* 6. *Recueil de chose memorable avenue en France sous Henri II. François II. Charles IX. Henri III.* These three historical treatises have been justly accused of partiality and passion; faults which it is next to impossible for a contemporary writer to avoid, especially if he bore any part in the transactions which he describes. His style is exceedingly incorrect and inelegant; his mistakes too and misstatements of facts are very numerous.

SERRATED, in general, something indented or notched in the manner of a saw; a term much used in the description of the leaves of plants. See BOTANY.

SERRATULA, SAW-WORT, in botany: A genus of plants belonging to the class of syngenesia, and to the order of polygama æqualis. In the natural system it is ranged under the 49th order, *Compositæ*. The calyx is subcylindrical, imbricated; the scales of it pointed, but not spinous. There are 15 species: The tinctoria, alpina, arvensis, coronata, japonica, falicifolia, multiflora, noveboracensis, præalta, glauca, squarrosa, scariofa, spicata, amara, and centauroides. The three first species

are British. 1. The tinctoria is distinguished by a stem erect and slender, branched at the top, and three feet high. The leaves are smooth, pinnatifid, and serrated: The flowers are purple, in umbels, and terminal. The down of the seed is glossy, with a brown or gold tinge. It grows in woods and wet pastures. It dyes cloth of an exceeding fine yellow colour, which stands well when fixed with alum. Goats eat this plant; horses are not fond of it; cattle, swine, and sheep, leave it untouched. 2. The alpina, or mountain saw-wort. The root and stem are woody; the latter being from one to two feet high. The leaves are numerous, triangular, long, pointed, substantial, dark green above, white beneath, and serrated, with round intervals between the teeth, on footstalks. The flowers are purple. The scales of the calyx are very short and downy. It grows on high mountains, and flowers commonly in July or August. 3. The arvensis, corn saw-wort, or way-thistle. The stem is generally erect, branched, and two or three feet high. The leaves are sinuated, serrated, and spinous; those above being almost entire. The flowers are of a pale purple; the down is very long. This plant grows in cultivated grounds and by waysides, and flowers in July or August. When burned it yields good ashes for making glass or fixed alkali.

SERRATUS, in anatomy, a name given to several muscles, from their resemblance to a saw. See ANATOMY, *Table of the Muscles*.

SERTORIUS (Quintus), an eminent Roman general; (see SPAIN), under the history of which his exploits are related.

SERTULARIA, in natural history, a genus belonging to the class of vermes, and to the order of zoophyta. The stem is radicated, fibrous, naked, and jointed; the florets are hydræ, and there is one at each joint. This genus comprehends 42 species of corallines.

SERVAL, mountain cat. See FELIS, xvi.

SERVANDONI (John Nicolas), was born at Florence in 1695. He rendered himself famous by his exquisite taste in architecture, and by his genius for decorations, fetes, and buildings. He was employed and rewarded by most of the princes in Europe. He was honoured in Portugal with the order of Christ: In France he was architect and painter to the king, and member of the different academies established for the advancement of these arts. He received the same titles from the kings of Britain, Spain, Poland, and from the duke of Wirtemberg. Notwithstanding these advantages, his want of economy was so great, that he left nothing behind him. He died at Paris in 1766. Paris is indebted to him for many of its ornaments. He made decorations for the theatres of London and Dresden. The French king's theatre, called *la salle des Machines*, was under his management for some time. He was permitted to exhibit shows consisting of simple decorations: Some of these were astonishingly sublime; his "Descent of Æneas into Hell" in particular, and his "Enchanted Forest," are well known. He built and embellished a theatre at Chambor for Marechal Saxe; and furnished the plan and the model of the theatre royal at Dresden. His genius for fetes was remarkable; he had the management of a great number in Paris, and even in London. He conducted one at Lisbon given on account of a victory gained by the duke of Cumberland. He was employed frequently by the king of Portugal,

*servant.* Portugal, to whom he presented several elegant plans and models. The prince of Wales, too, father to the present king, engaged him in his service; but the death of that prince prevented the execution of the designs which had been projected. He presided at the magnificent *fete* given at Vienna on account of the marriage of the archduke Joseph and the Infanta of Parma. But it would be endless to attempt an enumeration of all his performances and exhibitions.

**SERVANT**, a term of relation; signifying a person who owes and pays obedience for a certain time to another in quality of a master.

As to the several sorts of servants: It was observed, under the article **LIBERTY**, that pure and proper slavery does not, nay cannot, subsist in Britain: such we mean wheteby an absolute and unlimited power is given to the master over the life and fortune of the slave. And indeed it is repugnant to reason, and the principles of natural law, that such a state should subsist anywhere. See **SLAVERY**.

The law of England therefore abhors, and will not endure, the existence of slavery within this nation: so that when an attempt was made to introduce it, by statute 1 Edw. VI. c. 3. which ordained, that all idle vagabonds should be made slaves, and fed upon bread, water, or small drink, and refuse-meat; should wear a ring of iron round their necks, arms, or legs; and should be compelled, by beating, chaining, or otherwise, to perform the work assigned them, were it ever so vile; the spirit of the nation could not brook this condition, even in the most abandoned rogues; and therefore this statute was repealed in two years afterwards. And now it is laid down, that a slave or negro, the instant he lands in Britain, becomes a freeman; that is, the law will protect him in the enjoyment of his person and his property. Yet, with regard to any right which the master may have lawfully acquired to the perpetual service of John or Thomas, this will remain exactly in the same state as before: for this is no more than the same state of subjection for life which every apprentice submits to for the space of seven years, or sometimes for a longer term. Hence, too, it follows, that the infamous and unchristian practice of withholding baptism from negro-servants, lest they should thereby gain their liberty, is totally without foundation, as well as without excuse. The law of England acts upon general and extensive principles: it gives liberty, rightly understood, that is, protection, to a Jew, a Turk, or a Heathen, as well as to those who profess the true religion of Christ; and it will not dissolve a civil obligation between master and servant, on account of the alteration of faith in either of the parties; but the slave is entitled to the same protection in England before as after baptism; and, whatever service the Heathen negro owed of right to his American master, by general, not by local law, the same (whatever it be) is he bound to render when brought to England and made a Christian.

1. The first sort of servants, therefore, acknowledged by the laws of England, are *menial servants*; so called from being *intra mania*, or domestics. The contract between them and their masters arises upon the hiring. If the hiring be general, without any particular time limited, the law construes it to be a hiring for a year; upon a principle of natural equity, that the servant shall serve and the master maintain him, throughout all the

*servant.* revolutions of the respective seasons; as well when there is work to be done, as when there is not: but the contract may be made for any larger or smaller term. All single men between 12 years old and 60, and married ones under 30 years of age, and all single women between 12 and 40, not having any visible livelihood, are compellable by two justices to go out to service in husbandry or certain specific trades, for the promotion of honest industry; and no matter can put away his servant, or servant leave his master, after being so retained, either before or at the end of his term, without a quarter's warning; unless upon reasonable cause, to be allowed by a justice of the peace: but they may part by consent, or make a special bargain.

2. Another species of servants are called *apprentices*, (from *apprendre*, to learn); and are usually bound for a term of years, by deed indented or indentures, to serve their masters, and be maintained and instructed by them. This is usually done to persons of trade, in order to learn their art and mystery; and sometimes very large sums are given with them as a premium for such their instruction: but it may be done to husbandmen, nay, to gentlemen and others. And children of poor persons may be apprenticed out by the overseers, with consent of two justices, till 24 years of age, to such persons as are thought fitting; who are also compellable to take them: and it is held, that gentlemen of fortune, and clergymen, are equally liable with others to such compulsion: for which purposes our statutes have made the indentures obligatory, even though such parish-apprentice be a minor. Apprentices to trades may be discharged on reasonable cause, either at the request of themselves or masters, at the quarter-sessions, or by one justice, with appeal to the sessions; who may, by the equity of the statute, if they think it reasonable, direct restitution of a rateable share of the money given with the apprentice: and parish-apprentices may be discharged in the same manner by two justices. But if an apprentice, with whom less than 10 pounds hath been given, runs away from his master, he is compellable to serve out his time of absence, or make satisfaction for the same, at any time within seven years after the expiration of his original contract. See **APPRENTICE** and **APPRENTICESHIP**.

3. A third species of servants are *labourers*, who are only hired by the day or the week, and do not live *intra mania*, as part of the family; concerning whom the statutes before-cited have made many very good regulations; 1. Directing that all persons who have no visible effects may be compelled to work; 2. Defining how long they must continue at work in summer and in winter; 3. Punishing such as leave or desert their work; 4. Empowering the justices at sessions, or the sheriff of the county, to settle their wages; and, 5. Inflicting penalties on such as either give or exact more wages than are so settled.

4. There is yet a fourth species of servants, if they may be so called, being rather in a superior, a ministerial, capacity; such as *stewards*, *factors*, and *baillifs*; whom, however, the law considers as servants *pro tempore*, with regard to such of their acts as affect their master's or employer's property.

As to the manner in which this relation affects the master, the servant himself, or third parties, see the article *Master and Servant*.

Servetus,  
Servetus,

For the condition of servants by the law of Scotland, see LAW.

SERVETISTS, a name given to the modern Antitrinitarians, from their being supposed to be the followers of Michael Servetus; who, in the year 1553, was burnt at Geneva, together with his books.

SERVETUS (Michael), a learned Spanish physician, was born at Villaneuva, in Arragon, in 1509. He was sent to the university of Toulouse to study the civil law. The Reformation, which had awakened the most polished nations of Europe, directed the attention of thinking men to the errors of the Romish church and to the study of the Scriptures. Among the rest Servetus applied to this study. From the love of novelty, or the love of truth, he carried his inquiries far beyond the other reformers, and not only renounced the false opinions of the Roman Catholics, but went so far as to question the doctrine of the Trinity. Accordingly, after spending two or three years at Toulouse, he determined to go into Germany to propagate his new opinions, where he could do it with most safety. At Basil he had some conferences with Oecolampadius. He went next to Strasburg to visit Bucer and Capito, two eminent reformers of that town. From Strasburg he went to Hugenau, where he printed a book, intitled *De Trinitatis Erroribus*, in 1531. The ensuing year he published two other treatises on the same subject: in an advertisement to which, he informs the reader that it was not his intention to retract any of his former sentiments, but only to state them in a more distinct and accurate manner. To these two publications he had the courage to put his name, not suspecting that in an age when liberty of opinion was granted, the exercise of that liberty would be attended with danger. After publishing these books, he left Germany, probably finding his doctrines not so cordially received as he expected. He went first to Basil, and thence to Lyons, where he lived two or three years. He then removed to Paris, where he studied medicine under Sylvius, Fernelius, and other professors, and obtained the degree of master of arts and doctor of medicine. His love of controversy involved him in a serious dispute with the physicians of Paris; and he wrote an Apology, which was suppressed by an edict of the Parliament. The misunderstanding which this dispute produced with his colleagues, and the chagrin which so unfavourable a termination occasioned, made him leave Paris in disgust. He settled two or three years in Lyons, and engaged with the Frellons, eminent printers of that age, as a corrector to their press. At Lyons he met with Pierre Palmier, the archbishop of Vienne, with whom he had been acquainted at Paris. That Prelate, who was a great encourager of learned men, pressed him to accompany him to Vienne, offering him at the same time an apartment in his palace. Servetus accepted the offer, and might have lived a tranquil and happy life at Vienne, if he could have confined his attention to medicine and literature. But the love of controversy, and an eagerness to establish his opinions, always possessed him. At this time Calvin was at the head of the reformed church at Geneva. With Servetus he had been acquainted at Paris, and had there opposed his opinions. For 16 years Calvin kept up a correspondence with him, endeavouring to reclaim him from his errors. Servetus had read the works of Calvin, but did not think they merited the

high eulogies of the reformers, nor were they sufficient to convince him of his errors. He continued, however, to consult him; and for this purpose sent from Lyons to Geneva three questions which respected the divinity of Jesus Christ, regeneration, and the necessity of baptism. To these Calvin returned a civil answer. Servetus treated the answer with contempt, and Calvin replied with warmth. From reasoning he had recourse to abusive language; and this produced a polemical hatred, the most implacable disposition in the world. Calvin having obtained some of Servetus's papers, by means, it is said, not very honourable, sent them to Vienne along with the private letters which he had received in the course of their correspondence. The consequence was, that Servetus was arrested; but having escaped from prison, he resolved to retire to Naples, where he hoped to practise medicine with the same reputation which he had so long enjoyed at Vienne. He imprudently took his route through Geneva, though he could not but know that Calvin was his mortal enemy. Calvin informed the magistrates of his arrival; Servetus was apprehended, and appointed to stand trial for heresy and blasphemy. It was a law at Geneva, that every accuser should surrender himself a prisoner, that if the charge should be found false, the accuser should suffer the punishment in which he meant to involve the accused. Calvin not choosing to go to prison himself, sent one of his domestics to present the impeachment against Servetus. The articles brought against him were collected from his writings with great care; an employment which took up three days. One of these articles was, "that Servetus had denied that Judæa was a beautiful, rich, and fertile country; and affirmed, on the authority of travellers, that it was poor, barren, and disagreeable." He was also charged with "corrupting the Latin Bible, which he was employed to correct at Lyons, by introducing impertinent, trifling, whimsical, and impious notes of his own through every page." But the main article, which was certainly fatal to him, was, "that in the person of Mr Calvin, minister of the word of God in the church of Geneva, he had defamed the doctrine that is preached, uttering all imaginable injurious, blasphemous words against it."

Calvin visited Servetus in prison, and had frequent conferences with him; but finding that, in opposition to all the arguments he could employ, the prisoner remained inflexible in his opinions, he left him to his fate. Before sentence was passed, the magistrates of Geneva consulted the ministers of Bale, of Bern, and Zurich; and, as another account informs us, the magistrates of the Protestant Cantons of Switzerland. And to enable them to form a judgment of the criminality of Servetus, they transmitted the writings of Calvin, with his answers. The general opinion was, that Servetus ought to be condemned to death for blasphemy. He was accordingly sentenced to be burnt alive on the 27th of October 1553. As he continued alive in the midst of the flames more than two hours, it is said, finding his torment thus protracted, he exclaimed, "Unhappy wretch that I am! Will the flames be insufficient to terminate my misery! What then! Will the hundred pieces of gold, and the rich collar which they took from me, not purchase wood enough to consume me more quickly!" "Though the sentence of death was passed against Servetus by the magistrates of Geneva, with the

appro-



approbation of a great number of the magistrates and ministers of Switzerland, yet it is the opinion of most historians that this dreadful sentence was imposed at the instigation of Calvin. This act of severity for holding a speculative opinion, however erroneous and absurd, has left a stain on the character of this illustrious reformer, which will attend the name of Calvin as long as history shall preserve it from oblivion. The address and art which he used in apprehending Servetus, his inhumanity to him during his trial, his dissimulation and malice after his condemnation, prove that he was as much influenced by personal hatred as by a desire to support the interest of religion, though probably, during the trial, Calvin believed he was performing a very pious action. This intolerant spirit of Calvin and the magistrates of Geneva gave the Roman Catholics a favourable opportunity to accuse the Protestants of inconsistency in their principles, which they did not fail to embrace. "How could the magistrates (says the author of the *Dictionnaire des Heresies*), who acknowledged no infallible interpretation of the Scriptures, condemn Servetus to death because he explained them differently from Calvin; since every man has the privilege to expound the Scripture, according to his own judgment, without having recourse to the church? It is a great injustice to condemn a man because he will not submit to the judgment of an enthusiast, who may be wrong as well as himself."

Servetus was a man of great acuteness and learning, and well versed in the arts and sciences. In his own profession his genius exerted itself with success. In his tract intitled *Christianismi Restitutio*, published in 1553, he remarks, that the whole mass of blood passes through the lungs by the pulmonary artery and vein, in opposition to the opinion which was then universally entertained, that the blood passes through the partition which divides the two ventricles. This was an important step towards the discovery of the circulation of the blood.

His works consist of Controversial Writings concerning the Trinity; an edition of Pagninus's Version of the Bible, with a preface and notes, published under the name of Michael Villanovanus; an Apology to the Physicians of Paris; and a book intitled *Ratio Sympliciorum*. Mosheim has written in Latin a History of the Heresy and Misfortunes of Servetus, which was published at Helmstadt, in 4to, in 1728. From the curious details which it gives it is extremely interesting.

SERVIA, a province of Turkey in Europe, bounded on the north by the rivers Danube and Save, which separate it from Hungary; on the east, by Bulgaria; on the west, by Bosnia; and on the south, by Albania and Macedonia. It is about 190 miles in length from east to west; 95 in breadth from north to south; and is divided into four sangiacates. Two of these were ceded to the Christians in 1718, who united them into one. This continued till 1739, when the Turks were victorious; and then they were abandoned to the Turks by the treaty of Belgrade. Belgrade is the capital town.

SERVICE, in law, is a duty which a tenant, on account of his fee, owes to his lord.

There are many divisions of services; as, 1. Into personal, where something is to be done by the tenant in person; as homage and fealty. 2. Real, such as wards, marriages, &c. 3. Accidental, including heriots, reliefs, and the like. 4. Entire, where, on the

alienation of any part of the lands by a tenant, the services become multiplied. 5. Frank-service, which was performed by freemen, who were not obliged to perform any base service, but only to find a man and horse to attend the lord into the army or to court. 6. Knight's service, by which lands were anciently held of the king, on paying homage, service in war, &c.

As in every free and well regulated society there must be a diversity of ranks, there must be a great number of persons employed in service, both in agriculture and domestic affairs. In this country, service is a contract into which the servant voluntarily enters; and the master's authority extends no farther than to the performance of that species of labour for which the agreement was made.

"The treatment of servants (says that respectable moralist Mr Paley), as to diet, discipline, and accommodation, the kind and quantity of work to be required of them, the intermission, liberty, and indulgence to be allowed them, must be determined in a great measure by custom; for where the contract involves so many particulars, the contracting parties express a few perhaps of the principal, and by mutual understanding refer the rest to the known custom of the country in like cases.

"A servant is not bound to obey the unlawful commands of his master; to minister, for instance, to his unlawful pleasures; or to assist him in unlawful practices in his profession; as in smuggling or adulterating the articles which he deals in. For the servant is bound by nothing but his own promise; and the obligation of a promise extends not to things unlawful.

"For the same reason, the master's authority does not justify the servant in doing wrong; for the servant's own promise, upon which that authority is founded, would be none.

"Clerks and apprentices ought to be employed entirely in the profession or trade which they are intended to learn. Instruction is their wages; and to deprive them of the opportunities of instruction, by taking up their time with occupations foreign to their business, is to defraud them of their wages.

"The master is responsible for what a servant does in the ordinary course of his employment; for it is done under a general authority committed to him, which is in justice equivalent to a specific direction. Thus, if I pay money to a banker's clerk, the banker is accountable: but not if I had paid it to his butler or his footman, whose business it is not to receive money. Upon the same principle, if I once send a servant to take up goods upon credit, whatever goods he afterwards takes up at the same shop, so long as he continues in my service, are justly chargeable to my account.

"The law of this country goes great lengths in intending a kind of concurrence in the master, so as to charge him with the consequences of his servant's conduct. If an innkeeper's servant rob his guests, the innkeeper must make restitution; if a farrier's servant lame your horse, the farrier must answer for the damage; and still farther, if your coachman or carter drive over a passenger in the road, the passenger may recover from you a satisfaction for the hurt he suffers. But these determinations stand, I think, rather upon the authority of the law, than any principle of natural justice."

There is a grievance which has long and justly been

Service.

been complained of, the giving of good characters to bad servants. This is perhaps owing to carelessness, to a desire of getting rid of a bad servant, or to mistaken compassion. But such carelessness is inexcusable. When a man gives his sanction to the character of a bad servant, he ought to reflect on the nature and consequences of what he is doing. He is giving his name to a falsehood; he is deceiving the honest man who confides in his veracity; and he is deliberately giving a man an opportunity of cheating an honest man. To endeavour to get quit of a bad servant in this way, is surely not less criminal than concealing the faults and disadvantages of an estate which is advertised for sale, and ascribing to it advantages which it does not possess. In this case, we know the sale would be reduced, and the advertiser disgraced. Many masters give characters to servants out of compassion; but it is to this mistaken compassion that the disorderly behaviour of servants is perhaps principally owing: for if the punishment of dishonesty be only a change of place (which may be a reward instead of a punishment), it ceases to be a servant's interest to be true to his trust.

We have said above that a master's authority over his servant extends no farther than the terms of contract; by which we meant, that a master could give no unreasonable orders to his servant, or such as was inconsistent with the terms of contract. But the relation between a master and servant is certainly closer than the mere terms of a contract: it is a moral as well as a legal relation. A master of a family ought to superintend the morals of his servants, and to restrain them from vices. This he may do by his example, by his influence, and authority. Indeed every man possessed of authority is guilty of criminal negligence if he does not exert his authority for promoting virtue in his inferiors; and no authority is so well adapted for this purpose as that of masters of families, because none operates with an influence so immediate and constant. It is wonderful how much good a nobleman or gentleman of fortune can do to his domestics by attending to their morals; and every master may be a blessing to individuals and to society, by exerting prudently that influence which his situation gives him over the conduct of his servant.

*Choral SERVICE*, in church-history, denotes that part of religious worship which consists in chanting and singing. The advocates for the high antiquity of singing, as a part of church-music, urge the authority of St Paul in its favour (Ephes. chap. v. ver. 19. and Colos. chap. iii. ver. 16). On the authority of which passages it is asserted, that songs and hymns were, from the establishment of the church, sung in the assemblies of the faithful; and it appears from undoubted testimony, that singing, which was practised as a sacred rite among the Egyptians and Hebrews, at a very early period, and which likewise constituted a considerable part of the religious ceremonies of the Greeks and Romans, made a part of the religious worship of Christians, not only before churches were built, and their religion established by law, but from the first profession of Christianity. However, the era from whence others have dated the introduction of music into the service of the church, is that period during which Leontius governed the church of Antioch, *i. e.* between the year of Christ 347 and 356. See *ANTIPHONY*.

Service.

From Antioch the practice soon spread through the other churches of the East; and in a few ages after its first introduction into the divine service, it not only received the sanction of public authority, but those were forbid to join in it who were ignorant of music. A canon to this purpose was made by the council of Laodicea, which was held about the year 372; and Zonaras informs us, that these canonical singers were reckoned a part of the clergy. Singing was introduced into the western churches by St Ambrose about the year 374, who was the initiator of the Ambrosian chant established at Milan about the year 386; and Eusebius (lib. ii. cap. 17.) tells us, that a regular choir, and method of singing the service, were first established, and hymns used, in the church at Antioch during the reign of Constantine, and that St Ambrose, who had long resided there, had his melodies thence. This was about 230 years afterwards amended by pope Gregory the Great, who established the Gregorian chant; a plain, unisonous kind of melody, which he thought consistent with the gravity and dignity of the service to which it was to be applied. This prevails in the Roman church even at this day: it is known in Italy by the name of *canto fermo*; in France by that of *plain chant*; and in Germany and most other countries by that of the *cantus Gregorianus*. Although no satisfactory account has been given of the specific difference between the Ambrosian and Gregorian chants, yet all writers on this subject agree in saying, that St Ambrose only used the four authentic modes, and that the four plagal were afterwards added by St Gregory. Each of these had the same final, or key-note, as its relative authentic; from which there is no other difference, than that the melodies in the four authentic or principal modes are generally confined within the compass of the eight notes above the key-note, and those in the four plagal or relative modes, within the compass of the eight notes below the fifth of the key. See *MODE*.

Ecclesiastical writers seem unanimous in allowing that Pope Gregory, who began his pontificate in 590, collected the musical fragments of such ancient psalms and hymns as the first fathers of the church had approved and recommended to the first Christians; and that he selected, methodized, and arranged them in the order which was long continued at Rome, and soon adopted by the chief part of the western church. Gregory is also said to have banished from the church the *canto figurato*, as too light and dissolute; and it is added, that his own chant was called *canto fermo*, from its gravity and simplicity.

It has been long a received opinion, that the ecclesiastical tones were taken from the reformed modes of Ptolemy; but Dr Burney observes, that it is difficult to discover any connection between them, except in their names; for their number, upon examination, is not the same; those of Ptolemy being seven, the ecclesiastical eight; and indeed the Greek names given to the ecclesiastical modes do not agree with those of Ptolemy in the single instance of key, but with those of higher antiquity. From the time of Gregory to that of Guido, there was no other distinction of keys than that of authentic and plagal; nor were any semitones used but those from E to F, B to C, and occasionally A to Bb.

With respect to the music of the primitive church, it

may

may be observed, that though it consisted in the singing of psalms and hymns, yet it was performed in many different ways; sometimes the psalms were sung by one person alone, whilst the rest attended in silence; sometimes they were sung by the whole assembly; sometimes alternately, the congregation being divided into separate choirs; and sometimes by one person, who repeated the first part of the verse, the rest joining in the close of it. Of the four different methods of singing now recited, the second and third were properly distinguished by the names of *symphony* and *antiphony*; and the latter was sometimes called *responsaria*, in which women were allowed to join. St Ignatius, who, according to Socrates (lib. vi. cap. 8.), conversed with the apostles, is generally supposed to have been the first who suggested to the primitive Christians in the East the method of singing hymns and psalms alternately, or in dialogue; and the custom soon prevailed in every place where Christianity was established; though Theodoret in his history (lib. ii. cap. 24.) tells us, that this manner of singing was first practised at Antioch. It likewise appears, that almost from the time when music was first introduced into the service of the church, it was of two kinds, and consisted in a gentle inflection of the voice, which they termed plain song, and a more elaborate and artificial kind of music, adapted to the hymns and solemn offices contained in its ritual; and this distinction has been maintained even to the present day.

Although we find a very early distinction made between the manner of singing the hymns and chanting the psalms, it is, however, the opinion of the learned Martini, that the music of the first five or six ages of the church consisted chiefly in a plain and simple chant of unisons and octaves, of which many fragments are still remaining in the *canto fermo* of the Romish missals. For with respect to music in parts, as it does not appear, in these early ages, that either the Greeks or Romans were in possession of harmony or counterpoint, which has been generally ascribed to Guido, a monk of Arezzo in Tuscany, about the year 1022, though others have traced the origin of it to the eighth century, it is in vain to seek it in the church. The choral music, which had its rise in the church of Antioch, and from thence spread through Greece, Italy, France, Spain, and Germany, was brought into Britain by the singers who accompanied Aulin the monk, when he came over, in the year 596, charged with a commission to convert the inhabitants of this country to Christianity. Bede tells us, that when Aulin and the companions of his mission had their first audience of king Ethelbert, in the isle of Thanet, they approached him in procession, singing litanies; and that afterwards, when they entered the city of Canterbury, they sung a litany, and at the end of it Allelujah. But though this was the first time the Anglo-Saxons had heard the Gregorian chant, yet Bede likewise tells us, that our British ancestors had been instructed in the rites and ceremonies of the Gallican church by St Germanus, and heard him sing Allelujah many years before the arrival of St Aulin. In 680, John, præcentor of St Peter's in Rome, was sent over by pope Agatho to instruct the monks of Weremouth in the art of singing; and he was prevailed upon to open schools for teaching music in other places in Northumberland. Benedict Biscop, the preceptor of Bede, Adrian the monk, and many others, contributed to disseminate

the knowledge of the Roman chant. At length the successors of St Gregory, and of Aulin his missionary, having established a school for ecclesiastical music at Canterbury, the rest of the island was furnished with masters from that seminary. The choral service was first introduced in the cathedral church of Canterbury; and till the arrival of Theodore, and his settlement in that see, the practice of it seems to have been confined to the churches of Kent; but after that, it spread over the whole kingdom; and we meet with records of very ample endowments for the support of this part of public worship. This mode of religious worship prevailed in all the European churches till the time of the Reformation: the first deviation from it is that which followed the Reformation by Luther, who, being himself a lover of music, formed a liturgy, which was a musical service, contained in a work entitled *Psalmodia*, h. e. *Cantica sacra Veteris Ecclesiæ selecta*, printed at Norimberg in 1553, and at Wittenberg in 1561. But Calvin, in his establishment of a church at Geneva, reduced the whole of divine service to prayer, preaching, and singing; the latter of which he restrained. He excluded the offices of the antiphon, hymn, and motet, of the Romish service, with that artificial and elaborate music to which they were sung; and adopted only that plain metrical psalmody, which is now in general use among the reformed churches, and in the parochial churches of our own country. For this purpose he made use of Marot's version of the Psalms, and employed a musician to set them to easy tunes only of one part. In 1553, he divided the Psalms into pauses or small portions, and appointed them to be sung in churches. Soon after they were bound up with the Geneva catechism; from which time the Catholics, who had been accustomed to sing them, were forbid the use of them, under a severe penalty. Soon after the Reformation commenced in England, complaints were made by many of the dignified clergy and others, of the intricacy and difficulty of the church-music of those times: in consequence of which it was once proposed, that organs and curious singing should be removed from our churches. Latimer, in his diocese of Worcester, went still farther, and issued injunctions to the prior and convent of St Mary, forbidding in their service all manner of singing. In the reign of Edward VI. a commission was granted to eight bishops, eight divines, eight civilians, and eight common lawyers, to compile a body of such ecclesiastical laws as should in future be observed throughout the realm. The result of this compilation was a work first published by Fox the martyrologist, in 1571, and afterwards in 1640, under the title of *Reformatio Legum Ecclesiasticarum*. These 32 commissioners, instead of reprobating church-music, merely condemned figurative and operose music, or that kind of singing which abounded with fugues, responsive passages, and a commixture of various and intricate proportions; which, whether extemporary or written, is by musicians termed *descant*. However, notwithstanding the objections against choral music, and the practice of some of the reformed churches, the compilers of the English liturgy in 1548, and the king himself, determined to retain musical service. Accordingly the statute 2 & 3 Edw. VI. cap. 1. though it contains no formal obligation on the clergy, or others, to use or join in either vocal or instrumental music in the common prayer, does clearly recognise the practice of singing;

border  
of  
Serym.

and in 1550, then two years after the compiling of King Edward's liturgy, a formula was composed, which continues, with scarce any variation, to be the rule for choral service even at this day. The author of this work was John Marbecke, or Marbeike; and it was printed by Richard Grafton, in 1550, under the title of the Book of Common Prayer, noted. Queen Mary laboured to re-establish the Romish choral service; but the accession of Elizabeth was followed by the act of uniformity; in consequence of which, and of the queen's injunctions, the Book of Common Prayer, noted by Marbecke, was considered as the general formula of choral service. In 1560, another musical service, with some additions and improvements, was printed by John Day; and in 1565, another collection of offices, with musical notes. Many objections were urged by Cartwright and other Puritans against the form and manner of cathedral service, to which Hooker replied in his Ecclesiastical Polity. In 1664, the statutes of Edward VI. and Elizabeth, for uniformity in the Common Prayer, were repealed; and the Directory for Public Worship, which allows only of the singing of psalms, established. But upon the restoration of Charles II. choral service was again revived, and has since uniformly continued. See on this subject Hawkins's History of Music, vol. i. p. 404. vol. ii. p. 264. vol. iii. p. 58—468, &c. vol. iv. p. 44—347.

*SERVICER-Trees.* See *SORBUS*.

*SERVITES*, a religious order in the church of Rome, founded about the year 1233, by seven Florentine merchants, who, with the approbation of the bishop of Florence, renounced the world, and lived together in a religious community on mount Senar, two leagues from that city.

*SERVITOR*, in the university of Oxford, a student who attends on another for his maintenance and learning. See *SIZAR*.

*SERVITUDE*, the condition of a servant, or rather slave.

Under the declension of the Roman empire, a new kind of servitude was introduced, different from that of the ancient Romans; it consisted in leaving the lands of subjugated nations to the first owners, upon condition of certain rents, and servile offices, to be paid in acknowledgment. Hence the names of *servi censiti*, *ascriptitii*, and *addicti glebæ*; some whereof were taxable at the reasonable discretion of the lord; others at a certain rate agreed on; and others were mainmortable, who, having no legitimate children, could not make a will to above the value of five pence, the lord being heir of all the rest; and others were prohibited marrying, or going to live out of the lordship. Most of these services existed lately in France; but they were long ago abolished in England. Such, however, was the original of our tenures, &c. See *SLAVE*.

*SERVITUDE*, in Scots law. See *LAW*, Part III. Sect. ix.

*SERVIUS* (Maurus Honoratus), a celebrated grammarian and critic of antiquity, who flourished about the time of Arcadius and Honorius; now chiefly known by his Commentaries on Virgil. There is also extant a piece of Servius upon the feet of verses and the quantity of syllables, called *Cerimætrum*.

*SEKUM*, a thin, transparent, saltish liquor, which

makes a considerable part of the mæs of blood, See *SEFAMOIDEA*, n<sup>o</sup> 126. and *BLOOD*.

*SESAMOIDEA OSSA*, certain small bones somewhat resembling the seeds of sesamum, whence their name. They are placed at the under part of the bones of the last joints of the fingers and toes.

*SESAMUM, OILY GRAIN*, in botany; A genus of plants belonging to the class of didynamia, and to the order of angiospermia; and in the natural system ranging under the 20th order, *Luride*. The calyx is divided into five parts. The corolla is campanulated, the tube of which is nearly the length of the calyx; the throat is inflated, and very large; the border is divided into five parts, four of which are spreading and nearly equal; the fifth is the lowest and largest. There are four filaments, and the rudiments of a fifth. The stigma is lanceolated, and the capsule has four cells. There are only two species, the *orientale* and *indicum*. 1. The *orientale* has ovate, oblong, entire leaves. It is an annual, and grows naturally on the coast of Malabar and in the island of Ceylon; rising with an herbaceous four-cornered stalk, two feet high, sending out a few short side-branches; the leaves are oblong, oval, a little hairy, and stand opposite. The flowers terminate the stalks in loose spikes; they are small, of a dirty white colour, shaped somewhat like those of the fox-glove. After the flowers are past, the germen turns to an oval acute-pointed capsule with four cells, filled with oval compressed seeds, which ripen in autumn. 2. The *indicum*, with trifid lower leaves, grows naturally in India; this is also an annual plant; the stalk rises taller than that of the former; the lower leaves are cut into three parts, which is the only difference between them.

The first sort is frequently cultivated in all the eastern countries, and also in Africa, as a pulse; and of late years the seeds have been introduced into Carolina by the African negroes, where they succeed extremely well. The inhabitants of that country make an oil from the seed, which will keep good many years, without having any rancid smell or taste, but in two years become quite mild; so that when the warm taste of the seed, which is in the oil when first drawn, is worn off, they use it as a salad-oil, and for all the purposes of sweet oil. The seeds of this plant are also used by the negroes for food; which seeds they parch over the fire, and then mix them with water, and stew other ingredients with them, which makes an hearty food. Sometimes a sort of pudding is made of these seeds, in the same manner as with millet or rice, and is by some persons esteemed, but is rarely used for these purposes in Europe. This is called *bonny* or *bonny* in Carolina. In England these plants are preserved in botanic gardens as curiosities. Their seeds must be sown in the spring upon a hot bed; and when the plants are come up, they must be transplanted into a fresh hot-bed to bring them forward. After they have acquired a tolerable degree of strength, they should be planted into pots, and plunged into another hot-bed, managing them as hath been directed for amaranth; for if these plants are not thus brought forward in the former part of the summer, they will not produce good seeds in this country.

From nine pounds of this seed which came from Carolina,

Sesamoide  
de  
Sesamum

*efeli*  
*llion.*  
folina, there were upwards of two quarts of oil drawn, which is as great a quantity as hath been obtained from any vegetable whatever. This might occasion its being called the *oily grain*.

**SESELI**, MEADOW SAXIFRAGE, in botany: A genus of plants belonging to the class of pentandria, and to the order of digynia; and in the natural system ranging under the 45th order, *Umbellatae*. The umbels are globular; the involucre consists of one or two leaflets; the fruit is egg-shaped and streaked. There are 11 species, the *pininelloides montanum*, *glaucum annuum*, *ammoides*, *tortuosum*, *turbith*, *hyppomarathrum*, *pyrenaum*, *saxifragum*, and *elutum*. The *montanum* grows naturally in France and Italy; the *glaucum* is a native of France; the *ammoides* and *tortuosum* grow in the south of Europe; and the *hyppomarathrum* is a native of Austria.

**SESOSTRIS**, king of Egypt. See EGYPT, p. 368.

**SEQUI**, a Latin particle, signifying a whole and a half; which, joined with *altera*, *terza*, *quarta*, &c. is much used in the Italian music to express a kind of ratios, particularly several species of triples.

*Sesqui-Alternate*, in geometry and arithmetic, is a ratio between two lines, two numbers, or the like, where one of them contains the other once, with the addition of a half.

Thus 6 and 9 are in a sesqui-alterate ratio; since 9 contains 6 once, and 3, which is half of 6, over; and 20 and 30 are in the same; as 30 contains 20, and half 20 or 10.

*Sesqui-Duplicate* ratio, is when of two terms the greater contains the less twice, and half the less remains; as 15 and 6; 50 and 20.

*Sesqui-Tertional* proportion, is when any number or quantity contains another once and one third.

**SESSILE**, among botanists. See BOTANY.

**SESSION**, in general, denotes each sitting or assembly of a council, &c.

*Session of Parliament*, is the season or space from its meeting to its prorogation. See PARLIAMENT.

*Kirk-Session*, the name of a petty ecclesiastical court in Scotland. See *Kirk-Session*.

**SESSIONS** for weights and measures. In London, four justices from among the mayor, recorder, and aldermen (of whom the mayor or recorder is to be one), may hold a session to inquire into the offences of selling by false weights and measures, contrary to the statutes; and to receive indictments, punish offenders, &c. Char. king Charles I.

*Court of Session*. See LAW, Part III. Sect. ii.

*Court of Quarter-Sessions*, an English court that must be held in every county once in every quarter of a year; which, by statute 2 Hen. V. c. 4. is appointed to be in the first week after Michaelmas-day, the first week after the epiphany, the first week after the close of Easter, and in the week after the translation of St Thomas the martyr, or the 7th of July. It is held before two or more justices of the peace, one of which must be of the quorum. The jurisdiction of this court, by 34 Edw. III. c. 1. extends to the trying and determining all felonies and trespasses whatsoever: though they seldom, if ever, try any greater offence than small felonies with-in the benefit of clergy; their commission providing, that if any case of difficulty arises, they shall not pro-

ceed to judgment, but in the presence of one of the justices of the courts of king's-bench or common-pleas, or one of the judges of assize: and therefore murders, and other capital felonies, are usually remitted for a more solemn trial to the assizes. They cannot also try any new-created offence, without express power given them by the statute which creates it. But there are many offences and particular matters which, by particular statutes, belong properly to this jurisdiction, and ought to be prosecuted in this court; as, the smaller misdemeanors against the public or commonwealth, not amounting to felony; and especially offences relating to the game, highways, alehouses, bastard children, the settlement and provision for the poor, vagrants, servants wages, and Popish recusants. Some of these are proceeded upon by indictment: others in a summary way, by motion, and order thereupon; which order may for the most part, unless guarded against by particular statutes, be removed into the court of king's-bench by writ of *certiorari facias*, and be there either quashed or confirmed. The records or rolls of the sessions are committed to the custody of a special officer, denominated *custos rotulorum*, who is always a justice of the quorum; and among them of the quorum (saith Lambard) a man for the most part especially picked out, either for wisdom, countenance, or credit. The nomination of the *custos rotulorum* (who is the principal officer in the county, as the lord-lieutenant is chief in military command) is by the king's sign-manual: and to him the nomination of the clerk of the peace belongs; which office he is expressly forbidden to sell for money.

In most corporation-towns there are quarter-sessions kept before justices of their own, within their respective limits; which have exactly the same authority as the general quarter-sessions of the county, except in a very few instances; one of the most considerable of which is the matter of appeals from orders of removal of the poor, which, though they be from the orders of corporation-justices, must be to the sessions of the county, by statute 8 and 9 W. III. c. 30. In both corporations and counties at large, there is sometimes kept a special or petty session, by a few justices, for dispatching smaller business in the neighbourhood between the times of the general sessions; as for licensing alehouses, passing the account of parish-officers, and the like.

**SESTERCE**, **SESTERTIUS**, a silver coin, in use among the ancient Romans, called also simply *nummus*, and sometimes *nummus sestertius*. The sestertius was the fourth part of the denarius, and originally contained two asses and a half. It was at first denoted by LLS; the two L's signifying two libræ, and the S half. But the librarii, afterwards converting the two L's into an H, expressed the sestertius by HS. The word *sestertius* was first introduced by way of abbreviation for *semisestertius*, which signifies two, and a half of a third, or, literally, only half a third; for in expressing half a third, it was understood that there were two before.

Some authors make two kinds of sesterces; the less called *sestertius*, in the masculine gender; and the great one, called *sestertium*, in the neuter: the first, that we have already described; the latter containing a thousand of the other. Others will have any such distinction of great and little sesterces unknown to the Romans: *sestertius*, say they, was an adjective, and signified as *sester-*

*Session,*  
*Sesterce.*

Sestertius.

cus, or two asses and a half; and when used in the plural, as in *quinguinta sestertium*, or *sestertia*, it was only by way of abbreviation, and there was always understood *centena millia*, &c.

This matter has been accurately stated by Mr Raper, in the following manner. The substantive to which *sestertius* referred is either *as*, or *penulus*; and *sestertius as* is two asses and a half; *sestertium pondus*, two pondera and a half, or two hundred and fifty denarii. When the denarius passed for ten asses, the *sestertius* of two asses and a half was a quarter of it; and the Romans continued to keep their accounts in these *sesterties* long after the denarius passed for sixteen asses; till, growing rich, they found it more convenient to reckon by quarters of the denarius, which they called *nummi*, and used the words *nummus* and *sestertius* indifferently, as synonymous terms, and sometimes both together, as *sestertius nummus*; in which case the word *sestertius*, having lost its original signification, was used as a substantive; for *sestertius nummus* was not two *nummi* and a half, but a single *nummus* of four asses. They called any sum under two thousand *sesterties* so many *sestertii* in the masculine gender; two thousand *sesterties* they called *duo* or *bina sestertia*, in the neuter; so many quarters making five hundred denarii, which was twice the *sestertium*; and they said *dena*, *vicena*, &c. *sestertia*, till the sum amounted to a thousand *sestertia*, which was a million of *sesterties*. But, to avoid ambiguity, they did not use the neuter *sestertium* in the singular number, when the whole sum amounted to no more than a thousand *sesterties*, or one *sestertium*. They called a million of *sesterties* *decies nummum*, or *decies sestertium*, for *decies centena millia nummorum*, or *sestertiorum* (in the masculine gender), omitting *centena millia* for the sake of brevity. They likewise called the same sum *decies sestertium* (in the neuter gender) for *decies centies sestertium*, omitting *centies* for the same reason; or simply *decies*, omitting *centena millia sestertium*, or *centies sestertium*; and with the numeral adverbs *decies*, *vicies*, *centies*, *millies*, and the like, either *centena millia* or *centies* was always understood. These were their most usual forms of expression; though for *bina*, *dena*, *vicena sestertia*, they frequently said *bina*, *dena*, *vicena millia nummum*. If the consular denarius contained 60 troy grains of fine silver, it was worth somewhat more than eight-pence farthing and a half sterling; and the *as*, of 16 to the denarius, a little more than a half-penny. To reduce the ancient *sesterties* of two asses and a half, when the denarius passed for 16, to pounds sterling, multiply the given number by 5454, and cut off six figures on the right hand for decimals. To reduce *nummi sestertii*, or quarters of the denarius, to pounds sterling; if the given sum be consular money, multiply it by 8727, and cut off six figures on the right hand for decimals; but for imperial money diminish the said product by one eighth of itself. Phil. Trans. vol. lxi. part ii. art. 48.

To be qualified for a Roman knight, an estate of 400,000 *sesterties* was required; and for a senator, of 800,000.

Authors also mention a copper *sestertius*, worth about one third of a penny English.

*Sestercius*, or *sestertius*, was also used by the ancients for a thing containing two wholes and an half of another, as *as* was taken for any whole or integer.

SESTOS, a noted fortress of European Turkey, situated at the entrance of the Hellespont or Dardanelles, 24 miles south-west of Gallipoli. This place is famous for the loves of HERO and LEANDER, sung by the poet Musæus.

SESUVIUM, in botany; a genus of plants belonging to the class of icofandria, and to the order of trigynia. The calyx is coloured and divided into five parts; there are no petals; the capsule is egg-shaped, three-celled, opening horizontally about the middle, and containing many seeds. There is only one species, the *portulacastrum*, purslane-leaved *sesuvium*, which is a native of the West Indies.

SET, or SETS, a term used by the farmers and gardeners to express the young plants of the white thorn and other shrubs, with which they use to raise their quick or quick-set hedges. The white thorn is the best of all trees for this purpose; and, under proper regulations, its sets seldom fail of answering the farmer's utmost expectations.

SET-off, in law, is an act whereby the defendant acknowledges the justice of the plaintiff's demand on the one hand; but, on the other, sets up a demand of his own, to counterbalance that of the plaintiff, either in the whole, or in part: as, if the plaintiff sues for 10l. due on a note of hand, the defendant may set off 9l. due to himself for merchandise sold to the plaintiff; and, in case he pleads such set-off, must pay the remaining balance into court. This answers very nearly to the *compensatio* or stoppage of the civil law, and depends upon the statutes 2 Geo. II. cap. 22. and 8 Geo. II. cap. 24.

SETACEOUS WORM, in natural history, a name given by Dr Lister to that long and slender water-worm, which so much resembles a horse-hair, that it has been supposed by the vulgar to be an animated hair of that creature. These creatures, supposed to be living hairs, are a peculiar sort of insects, which are bred and nourished within the bodies of other insects, as the worms of the ichneumon flies are in the bodies of the caterpillars.

Aldrovand describes the creature, and tells us it was unknown to the ancients; but called *feta aquatica*, and *vermis setarius*, by the moderns, either from its figure resembling that of a hair, or from the supposition of its once having been the hair of some animal. We generally suppose it, in the imaginary state of the hair, to have belonged to a horse; but the Germans say it was once the hair of a calf, and call it by a name signifying *vitulus aquaticus*, or the "water calf."

Albertus, an author much revered by the common people, has declared that this animal is generated of a hair; and adds, that any hair thrown into standing water, will, in a very little time, obtain life and motion. Other authors have dissented from this opinion, and supposed them generated of the fibrous roots of water-plants; and others, of the parts of grasshoppers fallen into the water. This last opinion is rejected by Aldrovand as the most improbable of all. Standing and foul waters are most plentifully stored with them; but they are sometimes found in the clearest and purest springs, and sometimes out of the water, on the leaves of trees and plants, as on the fruit-trees in our gardens, and the elms in hedges. They are from three to five inches long, of the thickness of a large hair; and are brown,

S-899

Setaceous

**Seth** ||  
**Severance.** brown upon the back, and white under the belly, and the tail is white on every part.

**SETH**, the third son of Adam, the father of Enos, was born 3874 B. C. and lived 912 years.

**SETHIANS**, in church-history, Christian heretics; so called because they paid divine worship to Seth, whom they looked upon to be Jesus Christ the son of God, but who was made by a third divinity, and substituted in the room of the two families of Abel and Cain, which had been destroyed by the deluge. These heretics appeared in Egypt in the second century; and as they were addicted to all sorts of debauchery, they did not want followers; and continued in Egypt above 200 years.

**SETTIMO**, a town of Italy, in the province of Piedmont, situated on the river Po, eight miles north of Turin.

**SETON**, in surgery, a few horse hairs, small threads, or large packthread, drawn through the skin, chiefly the neck, by means of a large needle or probe, with a view to relieve or preserve health.

We find by experience, that setons are very useful in catarrhs, inflammations, and other disorders, particularly those of the eyes, as a gutta serena, cataract, and incipient suffusion; to these we may add intense headaches, with stupidity, drowsiness, epilepsies, and even the apoplexy itself.

**SETTEE**, in sea-language, a vessel very common in the Mediterranean with one deck and a very long and sharp prow. They carry some two masts, some three, without top-masts. They have generally two masts, equipped with triangular sails, commonly called *luteen sails*. The least of them are of 60 tons burden. They serve to transport cannon and provisions for ships of war and the like. These vessels are peculiar to the Mediterranean sea, and are usually navigated by Italians, Greeks, or Mahometans.

**SETTING**, in astronomy, the withdrawing of a star or planet, or its sinking below the horizon. Astronomers and poets make three different kinds of setting of the stars, viz the COSMICAL, ACRONYCAL, and HELICAL. See these articles.

**SETTING**, in the sea-language. To set the land or the sun by the compass, is to observe how the land bears on any point of the compass, or on what point of the compass the sun is. Also when two ships sail in sight of one another, to mark on what point the chased bears, is termed *setting the chase by the compass*.

**SETTING**, among sportsmen, a term used to express the manner of taking partridges by means of a dog peculiarly trained to that purpose. See SHOOTING.

**ACT OF SETTLEMENT**, in British history, a name given to the statute 12 and 13 W. III. cap. 2. whereby the crown was limited to his present majesty's illustrious house; and some new provisions were added, at the same fortunate era, for better securing our religion, laws, and liberties; which the statute declares to be the birthright of the people of England, according to the ancient doctrine of the common law.

**SEVENTH**, in music, an interval called by the Greeks *heptabordon*. See INTERVAL.

**SEVERANCE**, in law, the singling or severing two or more that join or are joined in the same writ or action. As if two join in a writ, *de libertate probando*, and the one be afterwards nonsuited; here severance is

permitted, so as notwithstanding the nonsuit the one, the other may severally proceed.

There is also severance of the tenants in assize; when one, two, or more disseisers appear upon the writ, and not the other. And severance in debt, where two executors are named plaintiffs, and the one refuses to prosecute. We also meet with severance of summons, severance in attainments, &c. An estate in joint tenancy may be severed and destroyed by destroying any of its unities. 1. That of time, which respects only the original commencement of the joint estate, cannot indeed (being now part) be affected by any subsequent transaction. But, 2. The joint-tenants estate may be destroyed without any alienation, by merely disuniting their possession. 3. The jointure may be destroyed, by destroying the unity of title. And, 4. By destroying the unity of interest.

**SEVERIA**, a province of the Russian empire, with the title of a duchy, bounded on the north by Smolensko and Muscovy, on the east by Vorotinski and the country of the Cossacks, on the south by the same, and on the west by Zernegovia. It is a country overrun with woods, and on the south part is a forest of great length. Novogrodek, or Novogorod, is the capital town.

**St SEVERINA**, a town of Italy, in the kingdom of Naples, and in Lower Calabria, with an archbishop's see. It is very well fortified, and seated on a craggy rock, on the river Necto; in E. Long. 17. 14. N. Lat. 39. 15.

**SEVERINO**, a town of Italy, in the territory of the church, and in the Marche of Ancona, with a bishop's see. It has fine vineyards, and is seated between two hills on the river Petenza, in E. Long. 13. 6. N. Lat. 43. 16.

**SEVERN**, a river which rises near Plimlimmon-Hill in Montgomeryshire, and before it enters Shropshire receives about 30 streams, and passes down to Ludring, where it receives the Morda, that flows from Oswestry. When it arrives at Monford, it receives the river Mon, passing on to Shrewsbury, which it almost surrounds, then to Bridgworth; afterwards it runs through the skirts of Staffordshire, enters Worcester

Lucemb.  
English G.  
zeller. shire, and passes by Worcester; then it runs to Tewkesbury, where it joins the Avon, and from thence to Gloucester, keeping a north-westerly course, till it falls into the Bristol Channel. It begins to be navigable for boats at Welchpool, in Montgomeryshire, and takes in several other rivers in its course, besides those already mentioned, and is the second in England. By the late inland navigation, it has communication with the rivers Mersey, Dee, Ribble, Ouse, Trent, Derwent, Humber, Thames, Avon, &c. which navigation, including its windings, extends above 500 miles in the counties of Lincoln, Nottingham, York, Lancashire, Westmoreland, Chester, Stafford, Warwick, Leicester, Oxford, Worcester, &c. A canal from Stroud-Water, a branch of the Severn, to join the Thames, has lately been undertaken, by which great undertaking of conveying a tunnel 16 feet high and 16 feet wide, under Sapperton Hill and Hayley-Wood (very high ground), for two miles and a quarter in length, through a very hard rock, lined and arched with brick, is entirely completed, and boats passed through it the 21st of May 1789. By this opening, a communication is made between the river Severn at

Severus.

Traniload and the Thames near Lechlade, and will be continued over the Thames near Ingletham, into deep water in the Thames below St John-Bridge, and so to Oxford, &c. and London, for conveyance of coals, goods, &c. It is now navigable from the Severn to Themsford, by way of Stroud, Cirencester, Cricklade, &c. being filled with water for that purpose near 40 miles.

SEVERUS (Cornelius), an ancient Latin poet of the Augustan age; whose *Ætas*, together with a fragment *De morte Ciceronis*, were published, with notes and a prose interpretation, by Le Clerc. 12mo, Amsterdam, 1723. They were before inserted among the *Cataloga Virgilia* published by Scaliger; whose notes, with others, Le Clerc has received among his own.

SEVERUS (Septimus), a Roman emperor, who has been so much admired for his military talents, that some have called him the most valiant of the Roman emperors. As a monarch he was cruel, and it has been observed that he never did an act of humanity or forgave a fault. In his diet he was temperate, and he always showed himself an open enemy to pomp and splendor. He loved the appellation of a man of letters, and he even composed an history of his own reign, which some have praised for its correctness and veracity. However cruel Severus may appear in his punishments and in his revenge, many have endeavoured to exculpate him, and observed that there was need of severity in an empire where the morals were so corrupted, and where no less than 3000 persons were accused of adultery during the space of 17 years. Of him, as of Augustus, some were fond to say, that it would have been better for the world if he had never been born, or had never died. See ROME, n<sup>o</sup> 372.

SEVERUS'S Wall, in British topography, the fourth and last barrier erected by the Romans against the incursions of the North Britons. See the articles ADRIAN, and ANTONINUS'S Wall.

We learn from several hints in the Roman historians, that the country between the walls of Hadrian and Antoninus continued to be a scene of perpetual war and subject of contention between the Romans and Britons, from the beginning of the reign of Commodus to the arrival of the emperor Septimius Severus in Britain, A. D. 206. This last emperor having subdued the Maata, and repulsed the Caledonians, determined to erect a stronger and more impenetrable barrier than any of the former, against their future incursions.

Though neither Dio nor Herodian make any mention of a wall built by Severus in Britain for the protection of the Roman province, yet we have abundant evidence from other writers of equal authority, that he really built such a wall. "He fortified Britain (says Spartian) with a wall drawn cross the island from sea to sea; which is the greatest glory of his reign. After the wall was finished, he retired to the next station (York), not only a conqueror, but the founder of an eternal peace." To the same purpose, Aurelius Victor and Orosius, to say nothing of Eutropius and Cassiodorus: "Having repelled the enemy in Britain, he fortified the country, which was suited to that purpose, with a wall drawn cross the island from sea to sea."—"Severus drew a great ditch, and built a strong wall, fortified with several turrets, from sea to sea, to protect that part of the island which he had recovered from

the yet unconquered nations." As the residence of the emperor Severus in Britain was not quite four years, it is probable that the two last of them were employed in building this wall; according to which account, it was begun A. D. 209, and finished A. D. 210.

This wall of Severus was built nearly on the same track with Hadrian's rampart, at the distance only of a few paces north. The length of this wall, from Cousins' house near the mouth of the river Tyne on the east, to Boulness on the Solway frith on the west, hath been found, from two actual measurements, to be a little more than 68 English miles, and a little less than 74 Roman miles. To the north of the wall was a broad and deep ditch, the original dimensions of which cannot now be ascertained, only it seems to have been larger than that of Hadrian. The wall itself, which stood on the south brink of the ditch, was built of free-stone, and where the foundation was not good, it is built on piles of oak; the interstices between the two faces of this wall is filled with broad thin stones, placed not perpendicularly, but obliquely on their edges; the running mortar or cement was then poured upon them, which, by its great strength and tenacity, bound the whole together, and made it firm as a rock. But though these materials are sufficiently known, it is not easy to guess where they were procured, for many parts of the wall are at a great distance from any quarry of free stone; and, though stone of another kind was within reach, yet it does not appear to have been anywhere used. The height of this wall was 12 feet besides the parapet, and its breadth 8 feet, according to Bede, who lived only at a small distance from the east end of it, and in whose time it was almost quite entire in many places. Such was the wall erected by the command and under the direction of the emperor Severus in the north of England; and, considering the length, breadth, height, and solidity, it was certainly a work of great magnificence and prodigious labour. But the wall itself was but a part, and not the most extraordinary part, of this work. The great number and different kinds of fortresses which were built along the line of it for its defence, and the military ways with which it was attended, are still more worthy of our admiration, and come now to be described.

The fortresses which were erected along the line of Severus's wall for its defence, were of three different kinds, and three different degrees of strength; and were called by three different Latin words, which may be translated *stations*, *castles*, and *turrets*. Of each of these in their order.

The *stations*, stations, were so called from their stability and the stated residence of garrisons. They were also called *castra*, which hath been converted into *chestsres*, a name which many of them still bear. These were by far the largest, strongest, and most magnificent of the fortresses which were built upon the wall, and were designed for the head-quarters of the cohorts of troops which were placed there in garrison, and from whence detachments were sent into the adjoining castles and turrets. These stations, as appears from the vestiges of them which are still visible, were not all exactly of the same figure nor of the same dimensions; some of them being exactly squares, and others oblong, and some of them a little larger than others. These variations were no doubt occasioned by the difference of situation



Severus. tuation and other circumstances. The stations were fortified with deep ditches and strong walls, the wall itself coinciding with and forming the north wall of each station. Within the stations were lodgings for the officers and soldiers in garrison; the smallest of them being sufficient to contain a cohort, or 600 men. Without the walls of each station was a town, inhabited by labourers, artificers, and others, both Romans and Britons, who chose to dwell under the protection of these fortresses. The number of the stations upon the wall was exactly 18; and if they had been placed at equal distances, the interval between every two of them would have been four miles and a few paces; but the intervention of rivers, marshes, and mountains; the conveniency of situations for strength, prospect, and water; and many other circumstances to us unknown, determined them to place these stations at unequal distances. The situation which was always chosen by the Romans, both here and everywhere else in Britain where they could obtain it, was the gentle declivity of a hill, near a river, and facing the meridian sun. Such was the situation of the far greatest part of the stations on this wall. In general, we may observe, that the stations stood thickest near the two ends and in the middle, probably because the danger of invasion was greatest in these places. But the reader will form a clearer idea of the number of these stations, their Latin and English names, their situation and distance from one another, by inspecting the following table, than we can give him with equal brevity in any other way. The first column contains the number of the station, reckoning from east to west; the second contains its Latin, and the third its English name; and the three last its distance from the next station to the west of it, in miles, furlongs, and chains.

No.	Latin Name.	English Name.	M.	F.	C.
1	Segedunum	Cousins'-house	3	5	1½
2	Pons Ælii	Newcastle	2	0	9
3	Condercum	Benwell hill	6	6	5
4	Vindobala	Rutchester	7	0	3½
5	Hunnun	Halton-chesters	5	1	7
6	Cilurnum	Walwick-chesters	3	1	8
7	Procolitia	Carrawburgh	4	5	3¼
8	Borcovicus	Housesteads	1	3	8
9	Vindolana	Little-chesters	3	6	4
10	Æfeca	Great-chesters	2	1	6½
11	Magna	Carrvoran	2	6	0
12	Amboglanna	Burdoswald	6	2	8
13	Petriana	Cambeck	2	6	6
14	Aballaba	Watchetofs	5	1	9
15	Congavata	Stanwix	3	3	4
16	Axelodunum	Brugh	4	0	9
17	Gabrotentum	Brumburgh	3	4	1
18	Iunnoecium	Boulness	0	0	0
Length of the wall			68	3	3

The *castella*, or castles, were the second kind of fortifications which were built along the line of this wall for its defence. These castles were neither so large nor so strong as the stations, but much more numerous, being no fewer than 81. The shape and dimensions of the castles, as appears from the foundations of many

of them which are still visible, were exact squares of 66 feet every way. They were fortified on every side with thick and lofty walls, but without any ditch, except on the north side; on which the wall itself, raised much above its usual height, with the ditch attending it, formed the fortification. The castles were situated in the intervals between the stations, at the distance of about seven furlongs from each other; though particular circumstances sometimes occasioned a little variation. In these castles, guards were constantly kept by a competent number of men detached from the nearest stations.

The *turres*, or turrets, were the third and last kind of fortifications on the wall. These were still much smaller than the castles, and formed only a square of about 12 feet, standing out of the wall on its south side. Being so small, they are more entirely ruined than the stations and castles, which makes it difficult to discover their exact number. They stood in the intervals between the castles; and from the faint vestiges of a few of them, it is conjectured that there were four of them between every two castles, at the distance of about 300 yards from one another. According to this conjecture, the number of the turrets amounted to 324. They were designed for watch-towers and places for sentinels, who, being within hearing of one another, could convey an alarm or piece of intelligence to all parts of the wall in a very little time.

Such were the stations, castles, and turrets, on the wall of Severus; and a very considerable body of troops was constantly quartered in them for its defence. The usual complement allowed for this service was as follows:

1. Twelve cohorts of foot, consisting of 600 men each, 7,200
  2. One cohort of mariners in the station at Boulness, 600
  3. One detachment of Moors, probably equal to a cohort, 600
  4. Four ala or wings of horse, consisting, at the lowest computation, of 400 each, 1,600
- 
- 10,000

For the conveniency of marching these troops from one part of the wall to another, with the greater ease and expedition, on any service, it was attended with two military ways, paved with square stones, in the most solid and beautiful manner. One of these ways was smaller, and the other larger. The smaller military way ran close along the south side of the wall, from turret to turret, and castle to castle, for the use of the soldiers in relieving their guards and centinels, and such services. The larger way did not keep so near the wall, nor touch at the turrets or castles, but pursued the most direct course from one station to another, and was designed for the conveniency of marching larger bodies of troops.

It is to be regretted, that we cannot gratify the reader's curiosity, by informing him by what particular bodies of Roman troops the several parts of this great work were executed; as we were enabled to do with regard to the wall of Antoninus Pius from inscriptions. For though it is probable that there were

Severus.

stones with inscriptions of the same kind, mentioning the several bodies of troops, and the quantity of work performed by each of them, originally inserted in the face of this wall, yet none of them are now to be found. There have indeed been discovered, in or near the ruins of this wall, a great number of small square stones, with very short, and generally imperfect, inscriptions upon them; mentioning particular legions, cohorts, and centuries; but without directly asserting that they had built any part of the wall, or naming any number of paces. Of these inscriptions, the reader may see no fewer than twenty-nine among the Northumberland and Cumberland inscriptions in Mr Horsley's *Britannia Romana*. As the stones on which these inscriptions are cut are of the same shape and size with the other facing-stones of this wall, it is almost certain that they have been originally placed in the face of it. It is equally certain, from the uniformity of these inscriptions, that they were all intended to intimate some one thing, and nothing so probable as that the adjacent wall was built by the troops mentioned in them. This was, perhaps, so well understood, that it was not thought necessary to be expressed; and the distance of these inscriptions from one another showed the quantity of work performed. If this was really the case, we know in general, that this great work was executed by the second and sixth legions, these being the only legions mentioned in these inscriptions. Now, if this prodigious wall, with all its appendages of ditches, stations, castles, turrets, and military ways, was executed in the space of two years by two legions only, which, when most complete, made no more than 12,000 men, how greatly must we admire the skill, the industry, and excellent discipline of the Roman soldiers, who were not only the valiant guardians of the empire in times of war, but its most active and useful members in times of peace?

This wall of Severus, and its fortresses, proved an impenetrable barrier to the Roman territories for near 200 years. But about the beginning of the 5th century, the Roman empire being assaulted on all sides, and the bulk of their forces withdrawn from Britain, the *Mæatæ* and *Caledonians*, now called *Scots* and *Picts*, became more daring; and some of them breaking through the wall, and others sailing round the ends of it, they carried their ravages into the very heart of Provincial Britain. These invaders were indeed several times repulsed after this by the Roman legions sent to the relief of the Britons. The last of these legions, under the command of *Gallio* of *Ravenna*, having, with the assistance of the Britons, thoroughly repaired the breaches of Severus's wall and its fortresses, and exhorted the Britons to make a brave defence, took their final farewell of Britain. It soon appeared, that the strongest walls and ramparts are no security to an undisciplined and dastardly rabble, as the unhappy Britons then were. The *Scots* and *Picts* met with little resistance in breaking through the wall, while the towns and castles were tamely abandoned to their destructive rage. In many places they levelled it with the ground, that it might prove no obstruction to their future inroads.—From this time no attempts were ever made to repair this noble work. Its beauty and grandeur procured it no respect in the dark and tasteless ages which succeeded. It became the common quarry for more than a thousand years, out of which all the towns and vil-

lages around were built; and is now so entirely ruined, that the penetrating eyes of the most poring and patient antiquarian, can hardly trace its vanishing foundations.

SEVIGNÉ (*Marie de Rabutin, Marquise de*), a French lady, was born in 1626. When only a year old she lost her father, who was killed in the descent of the English on the isle of *Rhé*, where he commanded a company of volunteers. In 1644 he married the *Marquis d'Albret*, who was slain in a duel by the *Chevalier d'Albret*, in 1651. She had by him a son and a daughter, to the education of whom she afterwards religiously devoted herself. Her daughter was married in 1660 to the *Count of Grignan*, who conducted her to *Provence*. *Madame de Sevigné* consoled herself by writing frequent letters to her daughter. She fell at last the victim to her maternal tenderness. In one of her visits to *Grignan*, she fatigued herself so much during the sickness of her daughter, that she was seized with a fever, which carried her off on the 14th of January 1696. We have two portraits of *Madame de Sevigné*; the one by the *Compte de Bussi*, the other by *Madame de la Fayette*. The first exhibits her defects; the second her excellencies. *Bussi* describes her as a lively gay coquette, a lover of flattery, fond of titles, honour, and distinction: *M. de la Fayette* as a woman of wit and good sense, as possessed of a noble soul, torned for dispensing benefits, incapable of debasing herself by avarice, and blessed with a generous, obliging, and faithful heart. Both these portraits are in some measure just. That she was vain-glorious, appears evident from her own letters, which, on the other hand, exhibit undoubted proofs of her virtue and goodness of heart.

This illustrious lady was acquainted with all the wits of her age. It is said that she decided the famous dispute between *Perrault* and *Boileau* concerning the preference of the ancients to the moderns, thus, "The ancients are the finest, and we are the prettiest." She left behind her a most valuable collection of letters, the best edition of which is that of 1775, in 8 vols 12mo. "These letters (says *Voltaire*) are filled with anecdotes, written with freedom, and in a natural and animated style; are an excellent criticism upon studied letters of wit, and still more upon those fictitious letters which aim at the epistolary style, by a recital of false sentiments and feigned adventures to an imaginary correspondent." It were to be wished that a proper selection had been made of these letters. It is difficult to read eight volumes of letters, which, though inimitably written, present frequent repetitions, and are often filled with trifles. What makes them in general perhaps so interesting is, that they are in part historical. They may be looked upon as a relation of the manners, the ton, the genius, the fashions, the etiquette, which reigned in the court of *Louis XIV.* They contain many curious anecdotes nowhere else to be found: But these excellencies would be still more striking, were they sometimes stripped of that multitude of domestic affairs and minute incidents which ought naturally to have died with the mother and the daughter. A volume entitled *Sevigniana* was published at *Paris* in 1756, which is nothing more than a collection of the fine sentiments, literary and historical anecdotes, and moral apothegms, scattered throughout these letters.

SEVILLE,

Sevigné.

*St. de Louis XIV*  
tom. ii.

ville. SEVILLE, a large and populous city of Spain, stands on the banks of the Guadalquivir, in the midst of a rich, and to the eye a boundless plain; in W. Long. 5° 5' N. Lat. 37° 20'. This city is supposed to have been founded by the Phœnicians, who gave it the name of *Hispalis*. When it fell under the power of the Romans, it was called *Julia*; and at last, after a variety of corruptions, was called *Selilla* or *Sevilla*; both of which names are retained by the Spaniards. The Romans embellished it with many magnificent edifices; of which scarce any vestige now remains. The Gothic kings for some time made it their residence: but in process of time they removed their court to Toledo; and Seville was taken by storm soon after the victory obtained at Xeres over the Gothic king Rodrigo.— In 1027, Seville became an independent monarchy; but was conquered 70 years afterwards by Yusuf Almoravides, an African prince. At last it was taken by Ferdinand III. after a year's siege; and 300,000 Moors were then obliged to leave the place. Notwithstanding this prodigious emigration, Seville continued to be a great and populous city, and soon after it was enlarged and adorned with many magnificent buildings, the chief of which is the cathedral. Seville arrived at its utmost pitch of grandeur a little after the discovery of America, the reason of which was, that all the valuable productions of the West Indies were carried thither. Its court was then the most splendid in Europe; but in the course of a few years all this grandeur disappeared, owing to the impediments in navigating the Guadalquivir. The superior excellence of the port of Cadiz induced government to order the galleons to be stationed there in time to come.

Seville is of a circular form, and is surrounded by a wall about five miles and a half in circumference, containing 176 towers. The ditch in many places is filled up. The streets of Seville are crooked and dirty, and most of them so narrow that two carriages can scarcely pass one another abreast.

Seville is said to contain 83,268 souls, and is divided into 30 parishes. It has 84 convents, with 24 hospitals.

Of the public edifices of this city the cathedral is the most magnificent. Its dimensions are 420 feet in length, 263 in breadth within the walls, and 126 feet in height. It has nine doors, 80 altars, at which 500 masses are daily celebrated, and 80 windows of painted glass, each of which cost 1000 ducats. At one angle stands a tower of Moorish workmanship 350 feet high. On the top of it is the giralda, or large brazen image, which, with its palm branch, weighs near one ton and a half, yet turns as a weather-cock with the slightest variation of the wind. The whole work is brick and mortar. The passage to the top is an inclined plane, which winds about in the inside in the manner of a spiral staircase, so easy of ascent that a horse might trot from the bottom to the top; at the same time it is so wide that two horsemen may ride abreast. What appears very unaccountable, the solid masonry in the upper half is just as thick again as that in the lower, tho' on the outside the tower is all the way of the same dimensions. In the opinion of Mr Swinburne, this cathedral is inferior to Yorkminster. Its treasures are inestimable; one altar with all its ornaments is solid silver; of the same metal are the images of St Isidore

and St Leander, which are as large as the life; and a tabernacle for the host more than four yards high, adorned with eight and forty columns. Before the choir of the cathedral is the tomb of the celebrated Christopher Columbus, the discoverer of America. His monument consists of one stone only, on which these words are inscribed, *A Castilla y Arragon otro mundo dio Colon*; that is, "To Castile and Arragon Columbus gave another world:" an inscription simple and expressive, the justness of which will be acknowledged by those who have read the adventures of this illustrious but unfortunate man. The cathedral was begun by Don Sancho the Brave, about the close of the 13th century, and finished by John II. about an hundred years after. To the cathedral belongs a library of 20,000 volumes, collected by Hernando the son of Columbus; but, to the disgrace of the Spaniards, it has scarcely received any addition since the death of the founder. The organ in this cathedral is a very ingenious piece of mechanism †. "I was much pleased (says Mr Townsend in his interesting travels) with the construction of a new organ, containing 5300 pipes, with 110 stops, which latter, as the builder told me, is 50 more than are in the famous one of Harlem; yet, so ample are the bellows, that when stretched they supply the full organ 15 minutes. The mode of filling them with air is singular; for instead of working with his hands, a man walks backwards and forwards along an inclined plane of about 15 feet in length, which is balanced in the middle on its axis; under each end is a pair of bellows, of about six feet by three and an half. These communicate with five other pair united by a bar; and the latter are so contrived, that when they are in danger of being overstrained, a valve is lifted up, and gives them relief. Passing 10 times along the inclined plane fills all these vessels."

The Canos de Carmone, or great aqueduct of Seville, is reckoned by the historians of this city one of the most wonderful works of antiquity. Mr Swinburne, however, remarks, that it is ugly, crooked, the arches unequal, and the architecture neglected. The conduit is so leaky, that a rivulet is formed by the waste water. Nevertheless, it still conveys to the city an ample supply of water sufficient to turn several mills, and to give almost every house in town the benefit of it.

Many of the convents are remarkable for the beauty of their architecture; but in Seville the eye covets only pictures, of which there is a wonderful profusion. Among these are the works of the famous painter Murillo, with many others universally admired.

The convent of the Franciscans contains 15 cloisters, with apartments for 200 monks, though, when Mr Townsend visited them, they amounted only to 140. The annual expenditure of these, who are all fed on charity, is about L. 4000 Sterling. "In the principal cloister (says the same intelligent traveller), which is entirely inclosed by a multitude of little chapels, are represented, in 14 pictures, each called a *station*, all the sufferings of the Redeemer. These are so arranged as to mark given distances by walking round the cloister from the first to the second, and so in order to the rest. Over them is mentioned the number of steps taken by our Lord between the several incidents of his passion in his way to Calvary; and these precisely are the paces

Seville.

Bourgoigne's Travels, vol. ii.

† Vol. ii. p. 318.

Swinburne's Travels, p. 203.

Townsend's Travels, vol. ii. p. 315.

Seville.

measured for the penitents in their progress from one station to another. Over one is the following inscription: 'This station consists of 1087 steps. Here the blessed Redeemer fell a second time under the weight of his cross, and here is to be gained the indulgence of seven years and forty quarantines. Mental prayer, the Paternoster, and the Ave Maria.' This may serve as an example for the rest."

The principal manufacture of Seville is snuff. Mr Townsend, who paid particular attention to it, informs us, that the building in which it is carried on is elegant and simple in its form, and is about 600 feet by 480, and not less than 60 feet in height, with four regular fronts, inclosing 28 quadrangles. It cost 37,000,000 of reals, or about L. 370,000. At present (1787), no more than 1700 workmen are employed, and 100 horses or mules; but formerly 3000 men were engaged, and near 400 horses. This falling off is attributed by Mr Swinburne to a practice which the directors followed, of adulterating the tobacco with the red earth of Almazarron. When Mr Townsend visited this manufacture, they had changed their system. From the year 1787, he informs us, the annual sale of tobacco from Brazil has been 1,500,000 pounds, purchased from the Portuguese at three reals a pound; and of snuff from the produce of their own colonies 1,600,000 pounds, beside *cigars* (A) to a very considerable amount. They have lying by them more than 5,000,000 of pounds of snuff unrolled; but as it will not suffer by age, they are not uneasy at this accumulation. Besides the peculiar kind of snuff with which Spain was accustomed to supply the market, they have lately introduced the manufacture of rappee. In this branch alone are employed 220 persons, old and young, with 16 mules.

"All the workmen (continues Mr Townsend) deposit their cloaks at the door; and when they go out are so strictly examined, that they have little chance of being able to conceal tobacco; yet they sometimes venture to hide it about their persons. An officer and a guard is always attending to take delinquents into custody; and that they may prevent resistance, no workman is permitted to enter with a knife. Were it not for this precaution, the consequence of a detection might be fatal. The whole business is conducted by a director, with a salary of 40,000 reals a-year, and 54 superior officers, assisted by as many subordinate to them. For grinding their snuff, they have 40 mills, each consisting of a stone roller, moved by a large horse or mule, with the traces fastened to a beam of eight feet in length, in the angle of 45 degrees, consequently losing precisely half his force."

Before Mr Townsend left Seville, according to his usual practice, which was truly laudable, he enquired into the prices of labour and provisions. As a piece of curious and useful information, and as an example to other travellers, we present them to our readers. They are as follow:

Day-labourers	-	4½ reals, about	L. 0 0 10½
Carpenters from 7 to 11	—		
Joiners, if good workmen,	-	24 — or	- 0 4 9

Weavers, if good workmen,	15 reals,		
about	-	L. 0 3 0	
Bread, for 3 lb. of 16 oz. or 16 quartos, or		0 0 4½	
— sometimes 28 quartos, or		0 0 7¾	
Beef, 30 quartos for 32 oz. per lb. about		0 0 4½	
Mutton, 38 do. do.	-	0 0 5½	
Kid, 24 do.	-	0 0 3½	

Pork from 36 to 42 quartos, do.	{	or 0 0 5½
	{	to 0 0 5½

The price of wheat has at different periods been very remarkable. In 1652, it sold at the rate of 15s. 3½d. the bushel; and in 1657, it fell so low as 1s. 4½d. per bushel, reckoning the fanega at 109½ lb. and the bushel at 70.

SEVUM MINERALF, mineral tallow; a substance somewhat resembling tallow, found on the sea-coasts of Finland in the year 1736. It burns with a blue flame, and smell of grease, leaving a black viscid matter which cannot easily be consumed. It is extremely light; being only of the specific gravity of 0.770; whereas tallow is not less than 0.969. It is partly soluble in highly rectified spirit of wine; but entirely so in expressed oils when boiling. It is met with in some of the rocky parts of Persia, but there it appears to be mixed with petroleum. Dr Herman of Strafburg mentions a spring in the neighbourhood of that city which contains a substance of this sort distilled through it, separating, and capable of being collected on ebullition. — A fat mineral matter resembling butter or tallow has lately been extracted from peat in Lancashire. See PEAT.

SEWAURY, a Hindoo word used in Bengal, and signifying the train of attendants that accompany a nabob or great man.

SEWER, in the Household, an officer who arranges on the table the dishes of a king or nobleman.

SEWER is also a passage or gutter made to carry water into the sea or a river, whereby to preserve the land, &c. from inundations and other annoyances.

Court of Commissioners of SEWERS in England, a temporary tribunal, erected by virtue of a commission under the great seal; which formerly used to be granted *pro re nata* at the pleasure of the crown, but now at the discretion and nomination of the lord chancellor, lord treasurer, and chief justices, pursuant to the statute 23 Hen. VIII. c. 5. Their jurisdiction is to overlook the repairs of sea-banks and sea-walls, and the cleansing of rivers, public streams, ditches, and other conduits, whereby any waters are carried off; and is confined to such county or particular district as the commission shall expressly name. The commissioners are a court of record, and may fine and imprison for contempts; and in the execution of their duty may proceed by jury, or upon their own view, and may take order for the removal of any annoyances, or the safeguard and conservation of the sewers within their commission, either according to the laws and customs of Romney-marsh, or otherwise at their own discretion. They may also assess such rates or scots upon the owners of lands within their district as they shall judge necessary: and if any person refuses to pay them, the commissioners may levy the

Sevum  
||  
Sewer.

(A) These are little rolls of tobacco which the Spaniards smoke without a pipe.

wer. the same by distress of his woods and charters; or they may, by statute 23 Hen. VIII. c. 5. sell his freehold-lands (and by the 7 Ann. c. 10. his copyhold also), in order to pay such scots or assessments. But their conduct is under the controul of the court of King's-bench, which will prevent or punish any illegal or tyrannical proceedings. And yet in the reign of King James I. (8th Nov. 1616.), the privy-council took upon them to order, that no action or complaint should be prosecuted against the commissioners unless before that board; and committed several to prison who had brought such actions at common law, till they should release the same: and one of the reasons for discharging Sir Edward Coke from his office of lord chief-justice, was for countenancing those legal proceedings. The pretence for these arbitrary measures was no other than the tyrant's plea of the necessity of unlimited powers in works of evident utility to the public, "the supreme reason above all reasons, which is the salvation of the king's lands and people." But now it is clearly held, that this (as well as all other inferior jurisdictions) is subject to the discretionary coercion of his majesty's court of King's-bench.

son's  
in Hi- Common SEWERS, in Rome, were executed at a great expence. It was proposed that they should be of sufficient dimensions to admit a waggon loaded with hay. When these common sewers came to be obstructed, or out of repair, under the republic, the censors contracted to pay a thousand talents, or about 193,000*l.* for clearing and repairing them. They were again in disrepair at the accession of Augustus Cæsar, and the re-instating them is mentioned among the great works of Agrippa. He is said to have turned the course of seven rivers into these subterraneous passages, to have made them navigable, and to have actually passed in barges under the streets and buildings of Rome. These works are still supposed to remain; but as they exceed the power and resources of the present city to keep them in repair, they are quite concealed, except at one or two places. They were in the midst of the Roman greatness, and still are, reckoned among the wonders of the world; and yet they are said to have been works of the elder Tarquin, a prince whose territory did not extend, in any direction, above 16 miles; and, on this supposition, they must have been made to accommodate a city that was calculated chiefly for the reception of cattle, herdsmen, and banditti. Rude nations sometimes execute works of great magnificence, as fortresses and temples, for the purposes of war and superstition; but seldom palaces, and still more seldom works of mere convenience and cleanliness, in which for the most part they are long defective. It is not unreasonable, therefore, to question the authority of tradition in respect to this singular monument of antiquity, which so greatly exceeds what the best accommodated city of modern Europe could undertake for its own convenience. And as those works are still entire, and may continue so for thousands of years, it may be suspected that they were even prior to the settlement of Romulus, and may have been the remains of a more ancient city, on the ruins of which the followers of Romulus settled, as the Arabs now live or encamp on the ruins of Palmyra and Balbeck. Livy owns, that the common sewers were not accommodated to the plan of Rome, as

it was laid out in his time; they were carried in directions across the streets, and passed under buildings of the greatest antiquity. This derangement indeed he imputes to the hasty rebuilding of the city after its destruction by the Gauls; but hatte, it is probable, would have determined the people to build on their old foundations, or at least not to change them so much as to cross the direction of former streets.

SEX, the property by which any animal is male or female.

Lavater has drawn the following characteristic distinctions between the male and female of the human species.

"The primary matter of which women are constituted appears to be more flexible, irritable, and elastic, than that of man. They are formed to maternal mildness and affection; all their organs are tender, yielding, easily wounded, sensible, and receptive. Among a thousand females there is scarcely one without the generic feminine signs; the flexible, the circular, and the irritable.

"They are the counterpart of man, taken out of man, to be subject to man; to comfort him like angels, and to lighten his cares." "She shall be saved in child-bearing, if they continue in faith, and charity, and holiness, with sobriety" (1 Tim. ii. 15) This tenderness, this sensibility, this light texture of their fibres and organs, this volatility of feeling, render them so easy to conduct and to tempt; so ready of submission to the enterprise and power of the man; but more powerful through the aid of their charms than man, with all his strength. The man was not first tempted, but the woman, afterward the man by the woman. And, not only easy to be tempted, she is capable of being formed to the purest, noblest, most seraphic virtue; to every thing which can deserve praise or affection. Highly sensible of purity, beauty, and symmetry, she does not always take time to reflect on internal life, internal death, internal corruption. "The woman saw that the tree was good for food, and that it was pleasant to the eyes, and a tree to be desired to make one wise, and she took of the fruit thereof." (Gen. iii. 6.)

"The female thinks not profoundly; profound thought is the power of the man. Women feel more. Sensibility is the power of woman. They often rule more effectually, more sovereignly, than man. They rule with tender looks, tears, and sighs; but not with passion and threats; for if, or when, they so rule, they are no longer women but abortions. They are capable of the sweetest sensibility, the most profound emotion, the utmost humility, and the excess of enthusiasm. In their countenance are the signs of sanctity and inviolability, which every feeling man honours, and the effects of which are often miraculous. Therefore, by the irritability of their nerves, their incapacity for deep inquiry and firm decision, they may easily from their extreme sensibility become the most irreclaimable, the most rapturous enthusiasts. Their love, strong and rooted as it is, is very changeable; their hatred almost incurable, and only to be effaced by continued and artful flattery. Men are most profound; women are more sublime.

"Men most embrace the whole; women remark individually, and take more delight in selecting the minutæ which form the whole. Man hears the bursting thunder,

Sex.

thunder, views the destructive bolt with serene aspect, and stands erect amidst the fearful majesty of the streaming clouds. Woman trembles at the lightning, and the voice of distant thunder; and shrinks into herself or sinks into the arms of man. Man receives a ray of light single, woman delights to view it through a prism in all its dazzling colours. She contemplates the rainbow as the promise of peace; he extends his inquiring eye over the whole horizon. Woman laughs, man smiles; woman weeps, man remains silent. Woman is in anguish when man weeps, and in despair when man is in anguish; yet has the often more faith than man. Man without religion, is a diseased creature, who would persuade himself he is well, and needs not a physician; but woman without religion, is raging and monstrous. A woman with a beard is not so disgusting as a woman who acts the freethinker; her sex is formed to piety and religion; to them Christ first appeared; but he was obliged to prevent them from too ardently, and too hastily, embracing him: 'Touch me not.' They are prompt to receive and seize novelty, and become its enthusiasts. The whole world is forgotten in the emotion caused by the presence and proximity of him they love. They sink into the most incurable melancholy, as they also rise to the most enraptured heights.

"Male sensation is more imagination, female more heart. When communicative, they are more communicative than man; when secret, more secret. In general they are more patient, long-suffering, credulous, benevolent, and modest. Woman is not a foundation on which to build. She is the gold, silver, precious stones, wood, hay, stubble (1 Cor. iii. 12.); the materials for building on the male foundation. She is the leaven, or more expressly the oil to the vinegar of man: the second part of the book of man.

"Man singly is but half man; at least but half human; a king without a kingdom. Woman, who feels properly what she is, whether still or in motion, rests upon the man; nor is man what he may and ought to be, but in conjunction with woman: therefore, 'it is not good that man should be alone, but that he should leave father and mother, and cleave to his wife, and they two shall be one flesh.'

They differ also in their exterior form and appearance.

"Man is the most firm; woman the most flexible. Man is the straightest; woman the most bending. Man stands steadfast; woman gently retreats. Man surveys and observes; woman glances and feels. Man is ferocious; woman is gay. Man is the tallest and broadest; woman the smallest and weakest. Man is rough and hard; woman smooth and soft. Man is brown; woman is fair. Man is wrinkly; woman is not. The hair of man is more strong and short; of woman more long and pliant. The eyebrows of man are compressed; of woman less frowning. Man has most convex lines; woman most concave. Man has most straight lines; woman most curved. The countenance of man taken in profile is more seldom perpendicular than that of the woman. Man is most angular; woman most round."

*Fitzsch's new's  
Letters.*

In determining the comparative merit of the two sexes, it is no derogation from female excellency that it differs in kind from that which distinguishes the male part of our species: and it, in general, it should be found (what upon an impartial inquiry will most cer-

tainly be found) that women fill up their appointed circle of action with greater regularity than men, the claim of preference cannot justly be decided in our favour. In the prudential and economical parts of life, it is undeniable that they rise far above us: and if true fortitude of mind is best discovered by a cheerful resignation to the measures of Providence, we shall not find reason, perhaps, to claim that most singular of the human virtues as our peculiar privilege. There are numbers of the other sex who, from the natural delicacy of their constitution, pass through one continued scene of suffering from their cradles to their graves, with a firmness of resolution that would deterve to many statues to be erected to their memories, if heroism were not esteemed more by the splendor than the merit of actions.

But whatever real difference there may be between the moral or intellectual powers of the male and female mind, Nature does not seem to have marked the distinction so strongly as our vanity is willing to imagine; and after all, perhaps, education will be found to constitute the principal superiority. It must be acknowledged, at least, that in this article we have every advantage over the softer sex that art and industry can possibly secure to us. The most animating examples of Greece and Rome are set before us, as early as we are capable of any observation; and the noblest compositions of the ancients are given into our hands almost as soon as we have strength to hold them; while the employments of the other sex, at the same period of life, are generally the reverse of every thing that can open and enlarge their minds, or fill them with just and rational notions. The truth of it is, female education is so much worse than none, as it is better to leave the mind to its natural and uninstructed suggestions, than to lead it into false pursuits, and contract its views, by turning them upon the lowest and most trifling objects. We seem, indeed, by the manner in which we suffer the youth of that sex to be trained, to consider women agreeably to the opinion of certain Mahometan doctors, and treat them as if we believed they had no souls: why else are they

Bred only, and completed to the taste

Of lustful appetite, to sing, to dance,

To dress, and troul the tongue, and roll the eye.

MILTON.

This strange neglect of cultivating the female mind can hardly be allowed as good policy, when it is considered how much the interest of society is concerned in the rectitude of their understandings. That season of every man's life which is most susceptible of the strongest impressions, is necessarily under female direction; as there are few instances, perhaps, in which that sex is not one of the secret springs which regulates the most important movements of private or public transactions. What Cato observes of his countrymen is in one respect true of every nation under the sun: "The Romans (said he) govern the world, but it is the women that govern the Romans."

If it be true then (as true beyond all peradventure it is) that female influence is thus extensive, nothing certainly can be of more importance than to give it a proper tendency, by the assistance of a well directed education. Far are we from recommending any attempts

to render women learned; yet surely it is necessary they should be raised above ignorance. Such a general tincture of the most useful sciences as may serve to free the mind from vulgar prejudices, and give it a relish for the rational exercise of its powers, might very justly enter into a plan of female erudition. That sex might be taught to turn the course of their reflections into a proper and advantageous channel, without any danger of rendering them too elevated for the feminine duties of life. In a word, they ought to be considered as designed by Providence for use as well as show, and trained up, not only as women, but as rational creatures.

*SEX of Bees.* See BEE.

*SEX of Plants.* See BOTANY, p. 448.

**SEXAGENARY**, something relating to the number sixty: thus sexagenary or sexagesimal arithmetic is a method of computation proceeding by sixties; such is that used in the division of a degree into sixty minutes, of the minute into sixty seconds, of the second into sixty thirds, &c. Also sexagenary tables are tables of proportional parts, showing the product of two sexagenaries that are to be multiplied, or the quotient of the two that are to be divided.

**SEXAGESIMA**, the second Sunday before Lent, or the next to Shrove-Sunday, so called as being about the 62th day before Easter.

**SEXAGESIMALS**, or *SEXAGESIMAL Fractions*, fractions whose denominators proceed in a sexagecuple ratio; that is, a prime, or the first minute,  $= \frac{1}{60}$ ; a second  $= \frac{1}{3600}$ ; a third  $= \frac{1}{216000}$ . Anciently, there were no other than sexagesimals used in astronomy; and they are still retained in many cases, though decimal arithmetic begins to grow in use now in astronomical calculations. In these fractions, which some call *astronomical fractions*, the denominator being always 60, or a multiple thereof, is usually omitted, and the numerator only written down: thus, 4°, 59', 32", 50'", 16"', is to be read, 4 degrees, 59 minutes, 32 seconds, 50 thirds, 16 fourths, &c.

**SEXTANS**, **SEXTANT**, a sixth part of certain things. The Romans having divided their *as* into 12 ounces or uncia, the sixth part of that, or two uncia, was the sextans.—*Sextans* was also a measure which contained two ounces of liquor, or two cyathi.

**SEXTANS**, in astronomy, a constellation of the southern hemisphere, made by Hevelius out of unformed stars. In Hevelius's catalogue it contains 11, but in the Britannic catalogue 41 stars.

**SEXTANT**, in mathematics, denotes the sixth part of a circle, or an arch comprehending 60 degrees.

The word *sextant* is more particularly used for an astronomical instrument made like a quadrant, excepting that its limb only comprehends 60 degrees. The use and application of the sextant is the same with that of the quadrant. See **QUADRANT**; and **NAVIGATION**, p. 737, &c.

**SEXTILE**, *sextilis*, the position or aspect of two planets when at 60 degrees distance, or at the distance of two signs from one another. It is marked thus (\*). See **ASPECT**.

**SEXTIUS** (**Quintus**), a Pythagorean philosopher, flourished in the time of Augustus. He seemed formed to rise in the republic; but he shrunk from civil honours, and declined accepting the rank of senator when it was offered him by Julius Cæsar, that he might have

time to apply to philosophy. It appears that he wished to establish a school at Rome, and that his tenets, though chiefly drawn from the doctrines of Pythagoras, in some particulars resembled those of the Stoics.

He soon found himself involved in many difficulties. His laws were tinctured with great severity; and in an early period of his establishment, he found his mind so harassed, and the harshness of the doctrines which he wished to establish so repulsive to his feelings, that he had nearly worked himself up to such an height of desperation as to resolve on putting a period to his existence.

Of the school of Sextius were Fabianus, Sotion, Flavianus, Crassitius, and Celsus. Of his works only a few fragments remain; and whether any of them formed a part of the work which Seneca admired so much, cannot now be determined. Some of his maxims are valuable. He recommended an examination of the actions of the day to his scholars when they retired to rest; he taught, that the road to Heaven (*ad astra*) was by frugality, temperance, and fortitude. He used to recommend holding a looking-glass before persons disordered with passion. He enjoined his scholars to abstain from animal food.

**SEXTON**, a church-officer, thus called by corruption of the Latin *sacrista*, or Saxon *segerstone*, which denotes the same. His office is to take care of the vessels, vestments, &c. belonging to the church; and to attend the minister, church-warden, &c. at church. He is usually chosen by the parson only. Sextons, as well as parish-clerks, are regarded by the common law as persons who have freehold in their offices; and, therefore, though they may be punished, yet they cannot be deprived, by ecclesiastical censures.

The office of sexton in the pope's chapel is appropriated to the order of the hermits of St Augustine. He is generally a bishop, though sometimes the pope only gives a bishopric, *in partibus*, to him on whom he confers the post. He takes the title of *Presb. of the Pope's Sacrify*, and has the keeping the vessels of gold and silver, the relics, &c. When the pope says mass, the sexton always tastes the bread and wine first. If it be in private he says mass, his holiness, of two wafers, gives him one to eat; and, if in public, the cardinal, who assists the pope in quality of deacon, of three wafers, gives him two to eat. When the pope is desperately sick, he administers to him the sacrament of extreme unction, &c. and enters the conclave in quality of first conclavist.

The office of a sexton in Sweden is somewhat singular. During M. Outhier's stay at Stockholm in 1736 he visited the church of St Clara, and during divine service he observed a sexton going about with a long rod, waking those persons who had fallen asleep.

**SEXTUPLE**, in music, denotes a mixed sort of triple, which is beaten in double time.

**SEXTUS EMPIRICUS**, a famous Pyrrhonian philosopher, lived in the second century, under the reign of Antoninus the Debonair. He was a physician of the sect of the Empirics, and is said to have been one of the preceptors of Antoninus the philosopher. There are still extant his Pyrrhonian Institutions, and a large work against the mathematicians, &c. The best edition of Sextus Empiricus is that of Fabricius in Greek and Latin, printed at Leipzig in 1718, folio.

Sexualistæ  
||  
Sforza.

**SEXUALISTÆ**, among botanical writers, those who have established the classes of plants upon the differences of the sexes and parts of fructification in plants, according to the modern method; as Linnæus, &c.

**SEZAWUL**, a Hindoo word, used in Bengal to express an officer employed at a monthly salary to collect the revenues.

**SFORZA** (James), was the founder of the illustrious house of Sforza, which acted so conspicuous a part in Italy during the 15th and 16th centuries, which gave six dukes to Milan, and contracted alliances with almost every sovereign in Europe. James Sforza was born on the 28th of May 1369, at Catignola, a small town in Italy, lying between Imola and Faenza. His father was a day-labourer, or, according to Commines, a shoemaker. A company of soldiers happening one day to pass through Catignola, he was seized with the desire of accompanying them to the wars. "I will go (said he to himself), and dart my hatchet against that tree, and if it stick fast in the wood, I will immediately become a soldier." The hatchet accordingly stuck fast, and our adventurer enlisted; and because, says the Abbé de Choisi, he had thrown the axe with all his force, he assumed the name of Sforza; for his true name was Giacomuzzo, or James Attendulo. He rose rapidly in the army, and soon became commander of 7000 men. He defended the cause of Jane II. queen of Naples for many years, and was made constable of her kingdom. He was created Count of Catignola by pope John XXII. by way of paying a debt of 14000 ducats which the church of Rome owed him. His exploits became every day more illustrious: he obliged Alphonso king of Arragon to raise the siege of Naples; and reduced several places that had revolted in Abruzzo and Le Labour; but while in pursuit of his enemies he was unfortunately drowned in the river Aterno on the 3d January 1424, at the age of 54 years. His heroic qualities and the continual wars in which he was engaged, did not hinder him from forming an attachment to the fair sex. In his youth he fell in love with a woman called *Lucia Trezana*, whom he married after she had born him several children. He married afterwards Antoinette Salembini, who brought him several excellent estates; she bore him Bosio Sforza, comte of Santa-Flor, a warrior and governor of Orvietta for Pope Martin V. His third wife was Catharine Alopa, sister of Rodolpho, grand chamberlain to the sovereign of Naples. His last wife, for he was four times married, was Mary Marzana, daughter to the duke of Sessa. She bore him Charles Sforza, who was general of the order of Augustines, and archbishop of Milan.

**SFORZA** (Francis), the son of James Sforza by Lucia Trezana, was born in 1401, and trained up by his father to the profession of arms. At the age of 23 he defeated the troops of Braccio, who disputed with him the passage of the Aterno. In this action his father was drowned, and Francis, though illegitimate, succeeded him. He fought successfully against the Spaniards, and contributed a great deal both towards raising the siege of Naples, and to the victory which was gained over the troops of Braccio near Aquila in 1425, where that general was killed. After the death of queen Jane, in 1435, he espoused the interests of the duke of Anjou, to whom she had left her crown, and by his courage and abilities ably supported

that unfortunate prince. He made himself master of several places in Ancona, from which he was driven by pope Eugenius IV. who defeated and excommunicated him; but he soon reestablished his affairs by a victory. His reputation was now so great, that the pope, the Venetians, and the Florentines, chose him for their general against the duke of Milan. Sforza had already conducted Venetian armies against that prince, though he had espoused his daughter. The duke dying in 1447, the inhabitants of Milan invited Sforza, his son-in-law, to lead them against that duke. But, after some exertions in their favour, he turned his arms against themselves, laid siege to Milan, and obliged them to receive him as duke, notwithstanding the rights of Charles duke of Orleans, the son of Valentine of Milan. In 1464, Louis XI. who hated Orleans, gave up to Sforza the rights which the crown of France had over Genoa, and even put into his hands Savona, a town belonging to that republic. The duke of Milan soon after made himself master of Genoa. He died in 1466, with the reputation of a man who was willing to sell his blood to the best purchaser, and who was not too scrupulous an observer of his word. His second wife was Blanche Marie, natural daughter of Philip Marie duke of Milan. She bore him Galeas Marie, and Ludovie Marie, dukes of Milan, Philip Marie count of Pavia, Sforza Marie duke of Bari, Ascagne Marie bishop of Pavia and Cremona, and a cardinal. He was taken prisoner by the troops of Louis XII. and confined for some time in the tower of Bourges. He was a cunning man, and deceived Cardinal d'Amboise when that prelate aspired at the papacy. His daughters were Hyppolita, married to Alphonso of Arragon, afterwards king of Naples; and Elizabeth, married to William marquis of Montferrat. He had besides several natural children.

**SHACK**, in ancient customs, a liberty of winter-pasturage. In the counties of Norfolk and Suffolk, the lord of the manor has shack, *i. e.* a liberty of feeding his sheep at pleasure in his tenants lands during the six winter months. In Norfolk, shack also extends to the common for hogs, in all men's grounds, from the end of harvest till seed-time. Whence to go *a-shack*, is to feed at large.

**SHACKLES**, aboard a ship, are those oblong iron rings, bigger at one end than at the other, with which the ports are shut fast, by thrusting the wooden bar of the port through them. There is also a sort of shackles to lift the hatches up with, of a like figure, but smaller. They are fastened at the corners of the hatches.

**SHAD**, in ichthyology, a species of **CLUPEA**.

**SHADDOCK**, a species of **CITRUS**.

**SHADOW**, in optics, a privation or diminution of light by the interposition of an opaque body: or it is a plane where the light is either altogether obstructed, or greatly weakened, by the interposition of some opaque body between it and the luminary.

**SHADOW**, in painting, an imitation of a real shadow, effected by gradually heightening and darkening the colours of such figures as by their dispositions cannot receive any direct rays from the luminary that is supposed to enlighten the piece.

**SHADOW**, in perspective, the appearance of an opaque body, and a luminous one, whose rays diverge (*e. gr.* a candle, lamp, &c.), being given; to find the just appearance

Sforza  
||  
Shadow.



Shadwell appearance of the shadow, according to the laws of perspective. The method is this: From the luminous body, which is here considered as a point, let fall a perpendicular to the perspective plane or table; *i. e.* find the appearance of a point upon which a perpendicular, drawn from the middle of the luminary, falls on the perspective plane; and from the several angles, or raised points of the body, let fall perpendiculars to the plane. These points, whereon the perpendiculars fall, connect by right lines, with the point upon which the perpendicular let fall from the luminary falls; and continue the lines to the side opposite to the luminary. Lastly, through the raised points draw lines through the centre of the luminary, intersecting the former; the points of intersection are the terms or bounds of the shadow.

SHADWELL (Thomas), descended of an ancient family in Staffordshire, was born in 1640, and educated at Caius college, Cambridge. He then was placed in the Middle Temple to study the laws; where having spent some time, he travelled abroad. Upon his return home, he became acquainted with the most celebrated persons of wit in that age. He applied himself chiefly to dramatic writing, in which he had great success; and upon the Revolution was made poet-laureat and historiographer to king William and queen Mary, in the room of Mr Dryden. These employments he enjoyed till his death, which happened in 1692. Beside his dramatic writings, he composed several other pieces of poetry; the chief of which are his congratulatory poem on the prince of Orange's coming to England; another on queen Mary; his translation of Juvenal's 10th satire, &c. Mr Dryden treats him with great contempt, in his satire called *Mac-Fleckno*. The best judges of that age, however, gave their testimony in favour of his comedies; which have in them fine strokes of humour; the characters are often original, strongly marked, and well sustained. An edition of his works, with some account of his life and writings prefixed, was published in 1720, in 4 vols 8vo.

SHAFT of a COLUMN, in building, is the body thereof between the base and capital; so called from its straightness. See ARCHITECTURE.

SHAFT, in mining, is the pit or hollow entrance into the mine. In the tin-mines, after this is sunk about a fathom, they leave a little, long, square place, which is called a *shamble*.

Shafts are sunk some ten, some twenty fathoms deep into the earth, more or less. Of these shafts, there is the landing or working shaft, where they bring up the work or ore to the surface; but if it be worked by a horse engine or whim, it is called a *whim-shaft*; and where the water is drawn out of the mine, it is indifferently named an *engine-shaft*, or the *rod-shaft*. See MINE.

SHAFT, in ornithology. See TROCHILUS.

SHAFTESBURY, a town of Dorsetshire in England, in W. Long. 2. 20. N. Lat. 51. 0. It stands on a high hill, and is built in the form of a bow. It enjoys a serene wholesome air, and has a fine prospect. It is a good thoroughfare, is governed by a mayor, and sends two members to parliament. This town is supposed to have been built in the 8th century, and to have been enlarged by king Alfred, and had 12 churches, besides a Benedictine monastery, in the time of the Saxons, but has now only three. St Edward the martyr was

buried here. It had three mints before the conquest, and, in the reign of Henry VIII. was the see of a suffragan bishop. It was incorporated by queen Elizabeth and Charles II. and is governed by a mayor, recorder, twelve aldermen, bailiffs, and a common-council. It contains about 320 houses, many of which are of free-stone. Water is so scarce, that it used to be supplied from Motcomb; but it was obtained more commodiously in 1718, by means of engines, which raised the water above 300 feet perpendicular, and conveyed it to a large cistern in the middle of the town, from the distance of two miles. Yet even this is laid aside, and they have dug several pits, in which they preserve the rain-water; and the poor get their living to this day by fetching it in pails or on horses. It gives the title of earl to the noble family of Cooper.

SHAFESBURY (earl of). See COOPER.

SHAG, in ornithology. See PELICANUS.

SHAGREEN, or CHAGREEN, in commerce, a kind of grained leather prepared of the skin of a species of SQUALUS, much used in covering cases, books, &c.

*Manner of preparing SHAGREEN.* The skin, being flayed off, is stretched out, covered over with mustard-seed, and the seed bruised on it; and thus it is exposed to the weather for some days, and then tanned.

The best is that brought from Constantinople, of a brownish colour; the white is the worst. It is extremely hard; yet, when steeped in water, it becomes very soft and pliable; whence it is of great use among case-makers. It takes any colour that is given it, red, green, yellow, or black. It is frequently counterfeited by morocco, formed like shagreen; but this last is distinguished by its peeling off, which the first does not.

SHAIK properly signifies an old man. In the east it is used to denote a lord or chief, a man of eminence and property. See SCHIECHS.

SHAKE, in singing. See TRILL.

SHAKESPEARE or SHAKSPEARE (William), the prince of dramatic writers, was born at Stratford upon Avon in Warwickshire, on the 23d of April 1564. From the register of that town, it appears that a plague broke out there on the 30th of June following, which raged with great violence; but fortunately it did not reach the house in which this infant prodigy lay. His father, John Shakespeare, enjoyed a small patrimonial estate, and was a considerable dealer in wool; his mother was the daughter and heir of Robert Arden of Wellingcote. Our illustrious poet being designed for the business of his father, received no better education than the instructions which the free-school of Stratford could afford. After applying some time to the study of Latin, he was called home to assist his father, who seems by some accident to have been reduced in his circumstances. Before arriving at the age of 19, he married the daughter of Mr Hathaway, a substantial yeoman in the neighbourhood of Stratford. This lady was eight years older than her husband. Having the misfortune to fall into bad company, he was seduced into some profligate actions, which drew on him a criminal prosecution, and at length forced him to take refuge in the capital. In concert with his associates, he broke into a park belonging to Sir Thomas Lucy of Charlecote, and carried off some of his deer. Every admirer of Shakespeare will regret that such a blemish should have stained his character:

Shake-  
speare.

but, perhaps, if any thing can extenuate his guilt, we might ascribe it to the opinions of the age, which, perhaps, as was formerly the case in Scotland, might not distinguish the killing of deer by any mark of disgrace, or any charge of criminality. One thing at least is certain, that Shakespeare himself thought that the prosecution which Sir Thomas raised against him was carried on with too great severity; an opinion which he could not have entertained had this action been at that time viewed in the same criminal light as it is at present. Shakespeare testified his resentment against Sir Thomas, by writing a satirical ballad, which exasperated him so much, that the process was carried on with redoubled violence; and the young poet, in order to avoid the punishment of the law, was obliged to make his escape. This ballad would be considered as a curious relic, on account of its being the first production of Shakespeare; it would also be interesting to peruse a poem which could irritate the baronet to so high a degree. Tradition has preserved the first stanza:

A parliamente member, a justice of peace,  
At home a poor scate-crow, at London an asse.  
If lowsie is Lucy, as some volke miscalle it,  
Then Lucy is lowsie whatever befall it:  
He thinks himself greate,  
Yet an asse in his state,  
We allowe by his cars, but with asses to mate.  
If Lucy is lowsie, as some volke miscalle it,  
Sing lowsie Lucy whatever befall it.

If the rest of the ballad was of a piece with this stanza, it might assist us to form some opinion of the irritability of the baronet, but will enable us to form no idea of the opening genius of Shakespeare.

Thus expelled from his native village, he repaired to London, where he was glad to accept a subordinate office in the theatre. It has been said that he was first engaged, while the play was acting, in holding the horses of those who rode to the theatre; but this story rests on a slender foundation. As his name is found printed among those of the other players before some old plays, it is probable that he was some time employed as an actor; but we are not informed what characters he played; we are only told, that the part which he acted best was that of the Ghost in Hamlet; and that he appeared in the character of Adam in *As you like it*. If the names of the actors prefixed to Ben Jonson's play of *Every Man in his Humour* were arranged in the same order as the persons represented, which is very probable, Shakespeare played the part of Old Knowell. We have reason therefore to suppose, as far as we can argue from these few facts, that he generally represented old men. See Malone's Chronology, in his edition of Shakespeare.

But though he was not qualified to shine as an actor, he was now in the situation which could most effectually rouse those latent sparks of genius which afterwards burst forth with so resplendent a flame. Being well acquainted with the mechanical business of the theatre and the taste of the times; possessed of a knowledge of the characters of men resembling intuition, an imagination that ranged at large through nature, selecting the grand, the sublime, and the beautiful; a judicious caution, that disposed him to prefer those plots which had already been found to please; an uncommon

fluency and force of expression; he was qualified at once to eclipse all who had gone before him.

Notwithstanding the unrivalled genius of Shakespeare, most of his plots were the invention of others; which, however, he certainly much improved, if he did not entirely new-model. We are assured, that prior to the theatrical compositions of Shakespeare, dramatic pieces were written on the following subjects, viz. King John, King Richard II. and III. King Henry IV. and V. King Henry VIII. King Lear, Antony and Cleopatra, Measure for Measure, the Merchant of Venice, the Taming of a Shrew, and the Comedy of Errors.

Among his patrons, the earl of Southampton is particularly honoured by him, in the dedication of two poems, Venus and Adonis, and Lucrece; in the latter especially, he expressed himself in such terms as gives countenance to what is related of that patron's distinguished generosity to him. In the beginning of king James I.'s reign (if not sooner) he was one of the principal managers of the playhouse, and continued in it several years afterwards; till, having acquired such a fortune as satisfied his moderate wishes and views in life, he quitted the stage, and all other business, and passed the remainder of his time in an honourable ease, at his native town of Stratford, where he lived in a handsome house of his own purchasing, to which he gave the name of *New Place*; and he had the good fortune to save it from the flames in the dreadful fire that consumed the greatest part of the town in 1614.

In the beginning of the year 1616, he made his will, wherein he testified his respect to his quondam partners in the theatre: he appointed his youngest daughter, jointly with her husband, his executors, and bequeathed to them the best part of his estate, which they came into the possession of not long after. He died on the 23d of April following, being the 53d year of his age; and was interred among his ancestors on the north side of the chancel, in the great church of Stratford, where there is a handsome monument erected for him, inscribed with the following elegiac distich in Latin:

*Judicio Pylum, genio Socratem, arte Maronem,  
Terra tegit, Populus marcet, Olympus habet.*

In the year 1740, another very noble one was raised to his memory, at the public expence, in Westminster-abbey; an ample contribution for this purpose being made upon exhibiting his tragedy of Julius Cæsar, at the theatre-royal in Drury-Lane, April 28th 1738.

Nor must we omit mentioning another testimony of the veneration paid to his manes by the public in general, which is, that a mulberry-tree planted upon his estate by the hands of this reverend bard, was cut down not many years ago; and the wood being converted to several domestic uses, was all eagerly bought at a high price, and each single piece treasured up by its purchaser as a precious memorial of the planter.

The character of Shakespeare as a dramatic writer has been often drawn, but perhaps never with more accuracy than by the pen of Dr Johnson: "Shakespeare (says he) is above all writers, at least above all modern writers, the poet of nature; the poet that holds up to his readers a faithful mirror of manners and of life.

Shake-  
speare

His characters are not modified by the customs of particular places, unpractised by the rest of the world; by the peculiarities of studies or professions, which can operate but upon small numbers; or by the accidents of transient fashions or temporary opinions: they are the genuine progeny of common humanity, such as the world will always supply, and observation will always find. His persons act and speak by the influence of those general passions and principles by which all minds are agitated, and the whole system of life is continued in motion. In the writings of other poets, a character is too often an individual; in those of Shakespeare, it is commonly a species.

“It is from this wide extension of design that so much instruction is derived. It is this which fills the plays of Shakespeare with practical axioms and domestic wisdom. It was said of Euripides, that every verse was a precept; and it may be said of Shakespeare, that from his works may be collected a system of civil and economical prudence. Yet his real power is not shown in the splendor of particular passages, but by the progress of his fable, and the tenor of his dialogue; and he that tries to recommend him by select quotations, will succeed like the pedant in Hierocles, who, when he offered his house to sale, carried a brick in his pocket as a specimen.

“Upon every other stage the universal agent is love, by whose power all good and evil is distributed, and every action quickened or retarded. But love is only one of many passions; and as it has no great influence upon the sum of life, it has little operation in the dramas of a poet who caught his ideas from the living world, and exhibited only what he saw before him. He knew that any other passion, as it was regular or exorbitant, was a cause of happiness or calamity.

“Characters thus ample and general were not easily discriminated and preserved; yet perhaps no poet ever kept his personages more distinct from each other.

“Other dramatists can only gain attention by hyperbolical or aggravated characters, by fabulous and unexampled excellence or depravity, as the writers of barbarous romances invigorated the reader by a giant and a dwarf; and he that should form his expectations of human affairs from the play, or from the tale, would be equally deceived. Shakespeare has no heroes, his scenes are occupied only by men, who act and speak as the reader thinks that he should himself have spoken or acted on the same occasion: Even where the agency is supernatural, the dialogue is level with life. Other writers disguise the most natural passions and most frequent incidents; so that he who contemplates them in the book will not know them in the world: Shakespeare approximates the remote, and familiarizes the wonderful; the event which he represents will not happen, but if it were possible, its effects would probably be such as he has assigned; and it may be said, that he has not only shown human nature as it acts in real exigencies, but as it would be found in trials to which it cannot be exposed.

“This therefore is the praise of Shakespeare, that his drama is the mirror of life; that he who has mazed his imagination, in following the phantoms which other writers raise up before him, may here be cured of his delirious ecstasies, by reading human sentiments in human language; by scenes from which a hermit may esti-

mate the transactions of the world, and a confessor predict the progress of the passions.”

The learning of Shakespeare has frequently been a subject of inquiry. That he possessed much classical knowledge does not appear, yet he was certainly acquainted with the Latin poets, particularly with Terence, as Colman has justly remarked, which appears from his using the word *troufonical*. Nor was he unacquainted with French and Italian. We are indeed told, that the passages in which these languages occur might be impertinent additions of the players; but is it probable, that any of the players so far surpassed Shakespeare?

That much knowledge is scattered over his works is very justly observed by Pope; but it is often such knowledge as books did not supply. “There is, however, proof enough (says Dr Johnson) that he was a very diligent reader; nor was our language then so indigent of books, but that he might very liberally indulge his curiosity without excursion into foreign literature. Many of the Roman authors were translated, and some of the Greek; the Reformation had filled the kingdom with theological learning; most of the topics of human disquisition had found English writers; and poetry had been cultivated, not only with diligence, but success. This was a stock of knowledge sufficient for a mind so capable of appropriating and improving it.”

The works of Shakespeare consist of 35 dramatic pieces. The following is the chronological order which Mr Malone has endeavoured to establish, after a minute investigation, in which he has in general been successful:

1. First Part of King Henry VI.	-	1589
2. Second Part of King Henry VI.	-	1591
3. Third Part of King Henry VI.	-	1591
4. A Midsummer Night's Dream	-	1592
5. Comedy of Errors	-	1593
6. Taming of the Shrew	-	1594
7. Love's Labour Lost	-	1594
8. Two Gentlemen of Verona	-	1595
9. Romeo and Juliet	-	1595
10. Hamlet	-	1596
11. King John	-	1596
12. King Richard II.	-	1597
13. King Richard III.	-	1597
14. First Part of King Henry IV.	-	1597
15. Second Part of King Henry IV.	-	1598
16. The Merchant of Venice	-	1598
17. All's Well that Ends Well	-	1598
18. King Henry V.	-	1599
19. Much Ado About Nothing	-	1600
20. As you like it	-	1600
21. Merry Wives of Windsor	-	1601
22. King Henry VIII.	-	1601
23. Troilus and Cressida	-	1602
24. Measure for Measure	-	1603
25. The Winter's Tale	-	1604
26. King Lear	-	1605
27. Cymbeline	-	1605
28. Macbeth	-	1606
29. Julius Caesar	-	1607
30. Antony and Cleopatra	-	1608
31. Timon of Athens	-	1609
32. Coriolanus	-	1610

Shake-  
speare

33. Othello	- - - - -	1611
34. The Tempest	- - - - -	1612
35. Twelfth Night	- - - - -	1614

The three first of these, Mr Malone thinks, there is very strong reason to believe are not the original productions of Shakespeare; but that he probably altered them, and added some new scenes.

In the first folio edition in 1623, these plays were entitled "Mr William Shakespeare's Comedies, Histories, and Tragedies." They have been published by various editors. The first folio edition by Isaac Jaggard and Edward Blount; the second, folio, 1632, by Thomas Cotes for Robert Allot; the third, 1664, for P. C.; the fourth, 1685, for H. Herringman, E. Brewster, and R. Bentley. Rowe published an 8vo edition in 1709, in 7 vols, and a 12mo edition in 1714, in 9 vols; for which he received L. 36, 10s. Pope published a 4to edition in 1725, in 6 vols, and a 12mo in 1728, in 10 vols; for which he was paid L. 217, 12s. Theobald gave a new edition in 8vo in 1733, in 7 vols, another in 12mo in 1740, in 8 vols; and received for his labour L. 652, 10s. Sir Thomas Hanmer published an edition in 1744, in 6 vols 4to. Dr Warburton's 8vo edition came out in 1747, in 8 vols; for which he was paid L. 560. The editions published since that time, are Dr Johnson's in 1765, in 8 vols 8vo. Stevens's in 1766, in 4 vols 8vo. Capell's in 1768, in 10 vols, crown 8vo; for this the author was paid L. 300. A second edition of Hanmer's in 1771, 6 vols. Johnson's and Stevens's in 1773, in 20 vols 8vo; a second edition in 1778; a third by Reed in 1785; and Malone's crown 8vo edition in 1789, in 10 vols.

The most authentic of the old editions is that of 1623. "At last (says Dr Johnson) an edition was undertaken by Rowe; not because a poet was to be published by a poet, for Rowe seems to have thought very little on correction or explanation, but that our author's works might appear like those of his fraternity, with the appendages of a life and commendatory preface. Rowe has been clamorously blamed for not performing what he did not undertake, and it is time that justice be done him, by confessing, that though he seems to have had no thought of corruption beyond the printer's errors, yet he has made many emendations, if they were not made before, which his successors have received without acknowledgment, and which, if they had produced them, would have filled pages with censures of the stupidity by which the faults were committed, with displays of the absurdities which they involved, with ostentatious expositions of the new reading, and self-congratulations on the happiness of discovering it."

The nation had been for many years content enough with Mr Rowe's performance, when Mr Pope made them acquainted with the true state of Shakespeare's text, showed that it was extremely corrupt, and gave reason to hope that there were means of reforming it. Mr Pope's edition, however, he observes, fell below his own expectations; and he was so much offended, when he was found to have left any thing for others to do, that he passed the latter part of his life in a state of hostility with verbal criticism.

The only task, in the opinion of Mr Malone, for which Pope was eminently and indisputably qualified,

was to mark the faults and beauties of his author.— When he undertook the office of a commentator, every anomaly of language, and every expression that was currently in use, were considered as errors or corruptions, and the text was altered or amended, as it was called, at pleasure. Pope is openly charged with being one of the great corrupters of Shakespeare's text.

Pope was succeeded by Theobald, who collated the ancient copies, and rectified many errors. He was, however, a man of narrow comprehension and of little learning, and what is worse, in his reports of copies and editions, he is not to be trusted without examination. From the liberties taken by Pope, the edition of Theobald was justly preferred, because he professed to adhere to the ancient copies more strictly, and illustrated a few passages by extracts from the writers of our poet's age. Still, however, he was a considerable innovator; and while a few arbitrary changes made by Pope were detected, innumerable sophistications were silently adopted.

Sir Thomas Hanmer, who comes next, was a man of critical abilities, and of extensive learning. His corrections are commonly just, but sometimes capricious. He is censurable, too, for receiving without examination almost all the innovations of Pope.

The original and predominant error of Warburton's commentary, is acquiescence in his first thoughts; that precipitation which is produced by consciousness of quick discernment; and that confidence which presumes to do, by surveying the surface, what labour only can perform, by penetrating to the bottom. His notes exhibit sometimes perverse interpretations, and sometimes improbable conjectures; he at one time gives the author more profundity of meaning than the sentence admits, and at another discovers absurdities where the sense is plain to every other reader. But his emendations are likewise often happy and just; and his interpretation of obscure passages learned and sagacious.

It has indeed been said by his defenders, that his great object was to display his own learning; and certainly, in spite of the clamour raised against him for substituting his own chimerical conceits instead of the genuine text of Shakespeare, his work increased his reputation. But as it is of little value as a commentary on Shakespeare, since Warburton is now gone, his work will probably soon sink into oblivion.

In 1765 Dr Johnson's edition, which had long been impatiently expected, was given to the public. His vigorous and comprehensive understanding threw more light on his author than all his predecessors had done. The character which he gave of each play is generally just. His refutation of the false glosses of Theobald and Warburton, and his numerous explications of involved and difficult passages, entitle him to the gratitude of every admirer of Shakespeare.

The last editor is Mr Malone, who was eight years employed in preparing his edition. By collating the most authentic copies, he has been careful to purify the text. He has been so industrious, in order to discover the meaning of the author, that he has ransacked many volumes, and trusts that, besides his additional illustrations, not a single valuable explication of any obscure passage in these plays has ever appeared, which he has not inserted in his edition. He rejects Titus Andronicus, as well as the three plays formerly mentioned, as

Shake-  
speare

ake-  
pare  
ll  
mans.

not being the authentic productions of Shakspeare. To the whole he has added an appendix, and a copious glossary.—Of this work a less expensive edition has been published in 7 vols 12mo, in which the general introductory observations prefixed to the different plays are preserved, and the numerous notes abridged.

This judicious commentator has certainly done more for the elucidation and correction of Shakspeare than all who came before him, and has followed with indefatigable patience the only road which a commentator of Shakspeare ought to observe.

Within 50 years after our poet's death, Dryden says that he was become "a little obsolete;" and in the beginning of the present century Lord Shaftesbury complains of his rude unpolished style, and his antiquated phrase and wit. These complaints were owing to the great revolution which the English language has undergone, and to the want of an enlightened commentator. These complaints are now removed, for an enlightened commentator has been found in Mr Malone.

We have only farther to add, that in the year 1790 a copious index to the remarkable passages and words in the plays of Shakspeare was published by the Reverend Mr Aycough; a gentleman to whom the literary world is much indebted for several very valuable keys of knowledge. In fine, the admirers of Shakspeare are now, by the labours of several eminent men, furnished with every help that can enable them to understand the sense and to taste the beauties of this illustrious poet.

SHAKLES. See SHACKLES.

SHALE, in natural history, a species of SCHISTUS. It is a black stony substance, or a clay hardened into a stony consistence, and so much impregnated with bitumen that it becomes somewhat like a coal. The acid emitted from shale, during its calcination, uniting itself to the argillaceous earth of the shale, forms alum. About 120 tons of calcined shale will make one ton of alum. The shale, after being calcined, is steeped in water, by which means the alum, which is formed during the calcination of the shale, is dissolved: this dissolved alum undergoes various operations before it is formed into the alum of the shops. Watson's Chemical Essays, vol. ii. p. 315. See ALUM.

This kind of slate forms large strata in Derbyshire; and that which lies near the surface of the earth is of a softer and more shivery texture than that which lies deeper. It is also found in large strata, generally above the coal, in most coal counties of this kingdom. Dr Short informs us, that the shale wastes the lead ore near it, by its strong acid; and that it corrodes and destroys all minerals near it except iron or coal, of whose vitriol it partakes.

SHALLOP, SHALLOOP, or SLOOP, is a small light vessel, with only a small main-mast, and fore-mast, and lug-sails, to hale up, and let down, on occasion.—Shallops are commonly good sailers, and are therefore often used as tenders upon men of war.

SHALLOT, or ESCHALOT. See ALLIUM.

SHAMANS are wizards or conjurers, in high repute among several idolatrous nations inhabiting different parts of Russia. By their enchantments they pretend to cure diseases, to divert misfortunes, and to foretel futurity. They are great observers of dreams, by the interpretation of which they judge of their good

or bad fortune. They pretend likewise to chiromancy, and to foretel a man's good or ill success by the lines of his hand. By these and such like means they have a very great ascendancy over the understandings, and a great influence on the conduct, of those people.

SHAMBLES, among miners, a sort of niches or landing places, left at such distances in the adits of the mines, that the shovel-men may conveniently throw up the ore from shamble to shamble, till it comes to the top of the mine.

SHAMOIS, CHAMOIS, or SHAMMY, a kind of leather, either dressed in oil or tanned, much esteemed for its softness, pliancy, &c. It is prepared from the skin of the chamois, or shamois, a kind of rupicapra, or wild goat, called also isard, inhabiting the mountains of Dauphiny, Savoy, Piedmont, and the Pyrenees. Besides the softness and warmth of the leather, it has the faculty of bearing soap without damage; which renders it very useful on many accounts.

In France, &c. some wear the skin raw, without any preparation. Shammy leather is used for the purifying of mercury, which is done by passing it through the pores of this skin, which are very close. The true chamois leather is counterfeited with common goat, kid, and even with sheep skins, the practice of which makes a particular profession, called by the French *chamoisfure*. The last, though the least esteemed, is yet so popular, and such vast quantities of it are prepared, especially about Orleans, Marseilles, and Tholouse, that it may not be amiss to give the method of preparation.

*Manner of shamoying, or of preparing sheep, goat, or kid skins in oil, in imitation of shammy.*—The skins, being washed, drained, and smeared over with quicklime on the fleshy side, are folded in two lengthwise, the wool outwards, and laid on heaps, and so left to ferment eight days, or, if they had been left to dry after flaying, then fifteen days.

Then they are washed out, drained, and half dried; laid on a wooden leg, or horse, the wool stripped off with a round staff for that purpose, and laid in a weak pit, the lime whereof had been used before, and has lost the greatest part of its force.

After 24 hours they are taken out, and left to drain 24 more; they are then put in another stronger pit. This done, they are taken out, drained, and put in again, by turns; which begins to dispose them to take oil; and this practice they continue for six weeks in summer, or three months in winter: at the end whereof they are washed out, laid on the wooden leg, and the surface of the skin on the wool side peeled off, to render them the softer; then made into parcels, steeped a night in the river, in winter more, stretched six or seven over one another on the wooden leg, and the knife passed strongly on the flesh side, to take off any thing superfluous, and render the skin smooth. Then they are steeped, as before, in the river, and the same operation is repeated on the wool side; they are then thrown into a tub of water, with bran in it, which is brewed among the skins till the greatest part sticks to them, and then separated into distinct tubs, till they swell, and rise of themselves above the water. By this means the remains of the lime are cleared out; they are then wrung out, hung up to dry on ropes, and sent to the mill, with the quantity of oil necessary to scour them: the best oil is that of stock-fish. Here they are first thrown in bundles

Shambles,  
Shamois.

Shamrois  
||  
Shannon.

bundles into the river for 12 hours, they laid in the mill-trough, and filled without oil till they be well softened; then oiled with the hawl, one by one, and thus formed into parcels of four skins each; which are milled and dried on cords a second time; then a third; and then oiled again, and dried. This process is repeated as often as necessity requires; when done, if there be any moisture remaining, they are dried in a stove, and made up into parcels wrapped up in wool; after some time they are opened to the air, but wrapped up again as before, till such time as the oil seems to have lost all its force, which it ordinarily does in 24 hours. The skins are then returned from the mill to the chamoiser to be scoured: which is done by putting them in a lixivium of wood-ashes, working and beating them in it with poles, and leaving them to steep till the ley hath had its effect; then they are wrung out, steeped in another lixivium, wrung again; and this is repeated till all the grease and oil be purged out. When this is done, they are half dried, and passed over a sharp-edged iron instrument, placed perpendicular in a block, which opens, softens, and makes them gentle. Lastly, they are thoroughly dried, and passed over the same instrument again; which finishes the preparation, and leaves them in form of shammy.

Kid and goat skins are shamoyed in the same manner as those of sheep, excepting that the hair is taken off without the use of any lime; and that when brought from the mill they undergo a particular preparation called *r.malling*, the most delicate and difficult of all the others. It consists in this, that, as soon as brought from the mill, they are steeped in a fit lixivium, taken out, stretched on a round wooden leg, and the hair is scraped off with the knife; this makes them smooth, and in working to cast a kind of fine knap. The difficulty is in scraping them evenly.

SHANK, or *SHANK-PAINTER*, in a ship, is a short chain fastened under the foremast-shrouds, by a bolt, to the ship's sides, having at the other end a rope fastened to it. On this shank-painter the whole weight of the aft part of the anchor rests, when it lies by the ship's side. The rope, by which it is hauled up, is made fast about a timber-head.

SHANK, in the manege, that part of a horse's fore-leg which lies between the knee and the fetlock.

SHANKER, or *CHANCRE*, in medicine, a malignant ulcer, usually occasioned by some venereal disorder. See *MEDICINE*, n<sup>o</sup> 350.

SHANNON, the largest river in Ireland, and one of the finest in the British dominions, not only on account of its rolling 200 miles, but also of its great depth in most places, and the gentleness of its current, by which it might be made exceedingly serviceable to the improvement of the country, the communication of its inhabitants, and consequently the promoting of inland trade, through the greatest part of its long course. But the peculiar prerogative of the Shannon is its situation, running from north to south, and separating the province of Connaught from Leinster and Munster, and of consequence dividing the greatest part of Ireland into what lies on the east and that on the west of the river; watering in its passage the valuable county of Leitrim, the plentiful shire of Roscommon, the fruitful county of Galway, and the pleasant county of Clare; the small but fine shire of Longford, the King's coun-

ty, and fertile county of Meath in Leinster, the populous county of Tipperary, the spacious shire of Limerick, and the rough but pleasant county of Kerry in Munster; visiting 10 counties in its passage, and having on its banks the following remarkable places, viz. Leitrim, Jamestown, Laneshorough, Athlone, Clonsfert, Killaloe, and Limerick; at 20 leagues below the latter it spreads gradually several miles in extent, so that some have considered its expansion as a lake. It at last joins its waters to the sea, being navigable all that way for the largest vessels.

SHANSCRIT, the language of the Bramins of Hindostan. See *PHILOLOGY*, sect. v.

SHARE of a *PLOUGH*, that part which cuts the ground; the extremity forwards being covered with a sharp-pointed iron, called the *point of the share*, and the end of the wood behind the *tail of the share*.

SHARK, in ichthyology. See *SQUALUS*.

SHARON, a name common to three cantons of Palestine. The first lay between mount Tabor and the sea of Tiberias; the second between the city of Casarea of Palestine, and Joppa; and the third lay beyond Jordan. To give an idea of perfect beauty, Isaiah said, the glory of Lebanon and the beauty of Carmel must be joined to the abundance of Sharon. (Isaiah xxxiii. 9. xxxi. 2.) The plains of Sharon are of vast extent; and, when surveyed by the Abbé Mariti a few years ago, they were sown with cucumbers; and he informs us, that such a number is annually produced, as not only to supply the whole neighbourhood, but also all the coasts of Cyprus and the city of Damietta. In the middle of the plain, between Arfus and Lydda, rises a small mountain, upon the ridge of which there is a small village called Sharon, from the name of the ancient city whose king was conquered by Joshua.

SHARP (James), archbishop of St Andrew's, was born of a good family in Banffshire in 1618. He devoted himself very early to the church, and was educated for that purpose in the University of Aberdeen. When the solemn league and covenant was framed in 1638, the learned men in that seminary, and young Sharp in particular, declared themselves decidedly against it. To avoid the insults and indignities to which he was subjected in consequence of this conduct, he retired to England, where he contracted an acquaintance with some of the most celebrated divines in that country.

At the commencement of the civil war he returned to Scotland. During his journey thither, he accidentally met with Lord Oxenford, who was so charmed with his conversation, that he invited him to his house. While he resided with that nobleman, he became known to the earl of Rothes, who procured him a professorship at St Andrew's. By the interest of the earl of Crawford he was soon after appointed minister of Crail; where he conducted himself, it is said, in an exemplary manner.

Sharp had always inclined to the cause of royalty, and had for some time kept up a correspondence with his exiled prince. After the death of the protector he began to declare himself more openly, and seems to have enjoyed a great share of the confidence of Monk, who was at that time planning the restoration of Charles II. When that general marched to London, the presbyterians sent Sharp to attend him in order to support their interests. At the request of general Monk and the chief presbyterians in Scotland, Mr Sharp was so trea-

ter sent over to the king at Breda to procure from him, if possible, the establishment of presbyterianism. On his return, he assured his friends that "he had found the king very affectionate to Scotland, and resolved not to wrong the settled government of the church: but he apprehended they were mistaken who went about to establish the presbyterian government."

Charles was soon after restored without any terms. All the laws passed in Scotland since the year 1633 were repealed; the king and his ministers resolved at all hazards to restore prelacy. Mr Sharp, who had been commissioned by the Scotch presbyterians to manage their interests with the king, was prevailed upon to abandon the party; and, as a reward for his compliance, he was made archbishop of St Andrew's. This conduct rendered him very odious in Scotland; he was accused of treachery and perfidy, and reproached by his old friends as a traitor and a renegade. The absurd and wanton cruelties which were afterwards committed, and which were imputed in a great measure to the archbishop, rendered him still more detested. Nor is it probable that these accusations were without foundation: the very circumstance of his having been formerly of the presbyterian party would induce him, after forsaking them, to treat them with severity. Besides, it is certain, that when after the rout at Pentland-hills he received an order from the king to stop the executions, he kept it for some time before he produced it to council.

There was one Mitchell a preacher, and a desperate fanatic, who had formed the design of taking vengeance for these cruelties by assassinating the archbishop. He fired a pistol at him as he was sitting in his coach; but the bishop of Orkney, lifting up his hand at the moment, intercepted the ball. Though this happened in the midst of Edinburgh, the primate was so much detested, that nobody stopped the assassin; who, having walked leisurely home, and thrown off his disguise, returned, and mixed unsuspected with the crowd. Some years after, the archbishop observing a man eyeing him with keanness, suspected that he was the assassin, and ordered him to be brought before him. It was Mitchell. Two loaded pistols were found in his pocket. The primate offered him a pardon if he would confess the crime: the man complied; but Sharp, regardless of his promise, conducted him to the council. The council also gave him a solemn promise of pardon if he would confess his guilt, and discover his accomplices. They were much disappointed to hear that only one man was privy to his purpose, who was since dead. Mitchell was then brought before a court of justice, and ordered to make a third confession, which he refused. He was imprisoned for several years, and then tried. His own confession was urged against him. It was in vain for him to plead the illegality of that evidence, and to appeal to the promise

VOL. XVII. Part I.

of pardon previously given. The council took an oath that they had given no such promise; and Mitchell was condemned. Lauderdale, who at that time governed Scotland, would have pardoned him, but the primate insisted on his execution; observing, that if assassins were permitted to go unpunished, his life must be continually in danger. Mitchell was accordingly executed.

Sharp had a servant, one Carmichael, who by his cruelty had rendered himself particularly odious to the zealots. Nine men formed the resolution of waylaying him in Magus-muir, about three miles from St Andrew's. While they were waiting for this man, the primate himself appeared with very few attendants. This they looked upon as a declaration of heaven in their favour; and calling out, "the Lord has delivered him into our hands," they ran up to the carriage. They fired at him without effect; a circumstance which was afterwards imputed to magic. They then dispatched him with their swords, regardless of the tears and intreaties of his daughter, who accompanied him (A).

Thus tell archbishop Sharp, whose memory is even at present detested by the common people of Scotland. His abilities were certainly good, and in the early part of his life he appears with honour and dignity. But his conduct afterwards was too cruel and insincere to merit approbation. His treatment of Mitchell was mean and vindictive. How far he contributed to the measures adopted against the presbyterians is not certain. They were equally cruel and impolitic: nor did their effects cease with the measures themselves. The unheard-of cruelties exercised by the ministers of Cha. II. against the adherents of the covenant, raised such a flame of enthusiasm and bigotry as is not yet entirely extinguished.

SHARP (Dr John), archbishop of York, was descended from the Sharps of Little Norton, a family of Bradford Dale in Yorkshire; and was son of an eminent tradesman of Bradford, where he was born in 1644. He was educated at Cambridge, and in 1667 entered into orders. That same year he became domestic chaplain to Sir Heneage Finch, then attorney-general. In 1672 he was collated to the archdeaconry of Berkshire. In 1675 he was installed a prebendary in the cathedral church of Norwich; and the year following was instituted into the rectory of St Bartholomew near the Royal Exchange, London. In 1681 he was, by the interest of his patron Sir Heneage Finch, then lord high chancellor of England, made dean of Norwich; but in 1686 was suspended for taking occasion, in some of his sermons, to vindicate the doctrine of the church of England in opposition to Popery. In 1688 he was sworn chaplain to king James II. being then probably restored after his suspension; for it is certain that he was chaplain to king Charles II. and attended as a court chaplain

U u

Sharp.

(A) Such is the account given by all our historians of the murder of archbishop Sharp; and that he fell by the hands of fanatics, whom he persecuted, is certain. A tradition, however, has been preserved in different families descended from him, which may be mentioned, and is in itself certainly not incredible. The primate, it seems, who, when minister of Craig, was peculiarly severe in punishing the sin of fornication, had, in the plenitude of his archiepiscopal authority, taken notice of a criminal amour carried on between a nobleman high in office and a lady of some fashion who lived within his diocese. This interference was in that licentious age deemed very impertinent; and the archbishop's descendants believe that the proud peer instigated the deluded rabble to murder their ancestor.

Sharp,  
Shafter.

plain at the coronation of king James II. In 1689 he was declared dean of Canterbury; but never could be persuaded to fill up any of the vacancies made by the deprived bishops. Upon the death of Dr Lamplugh, he was promoted to the see of York. In 1702 he preached the sermon at the coronation of queen Anne; and the same year was sworn of the privy-council, and made lord almoner to her majesty. He died at Bath in 1713; and was interred in the cathedral of York, where a monument is erected to his memory.—His sermons, which were collected after his death and published in 7 vols 8vo, are justly admired.

SHARP, in music. See INTERVAL.

SHASTER, or BEDANG, the name of a sacred book, in high estimation among the idolaters of Hindostan, containing all the dogmas of the religion of the bramins, and all the ceremonies of their worship; and serving as a commentary on the VEDAM.

The term *Shafter* denotes "science" or "system;" and is applied to other works of astronomy and philosophy, which have no relation to the religion of the Indians. None but the bramins and rajahs of India are allowed to read the Vedam; the priests of the Banians, called *shuderers*, may read the Shafter; and the people, in general, are allowed to read only the Paran or Pauran, which is a commentary on the Shafter.

The Shafter is divided into three parts: the first containing the moral law of the Indians; the second, the rites and ceremonies of their religion; and the third, the distribution of the people into tribes or classes, with the duties pertaining to each class.

The principal precepts of morality contained in the first part of the Shafter are the following: that no animal be killed, because the Indians attribute souls to brute animals as well as to mankind; that they neither hear nor speak evil, nor drink wine, nor eat flesh, nor touch any thing that is unclean; that they observe the feasts, prayers, and washings, which their law prescribes; that they tell no lies, nor be guilty of deceit in trade; that they neither oppress nor offer violence to one another; that they celebrate the solemn feasts and fasts, and appropriate certain hours of ordinary sleep to cultivate a disposition for prayer; and that they do not steal or defraud one another.

The ceremonies contained in the second part of the Shafter are such as these: that they wash often in the rivers, hereby obtaining the pardon of their sins; that they mark their forehead with red, in token of their relation to the Deity; that they present offerings and prayers under certain trees, set apart for this purpose; that they pray in the temples, make oblations to their pagodas, or idols, sing hymns, and make processions, &c. that they make pilgrimages to distant rivers, and especially to the Ganges, there to wash themselves and make offerings; that they make vows to particular saints, according to their respective departments; that they render homage to the Deity at the first sight of the sun; that they pay their respect to the sun and moon, which are the two eyes of the Deity; and that they treat with particular veneration those animals that are deemed more pure than others; as the cow, buffalo, &c.; because the souls of men have transmigrated into these animals.

The third part of the Shafter records the distribution of the people into four classes: the first being that

of the bramins or priests, appointed to instruct the people; the second, that of the kutteris or nobles, who are the magistrates; the third, that of the shudderis or merchants; and the fourth, that of the mechanics. Each person is required to remain in the class in which he was born, and to pursue the occupation assigned to him by the Shafter. According to the bramins, the Shafter was imparted by God himself to Brahma, and by him to the bramins; who communicated the contents of it to the people.

Modern writers have given us very different accounts of the antiquity and importance of the Shafter. Mr Holwell, who had made considerable progress in the translation of this book, apprehends, that the mythology as well as the cosmogony of the Egyptians, Greeks, and Romans, were borrowed from the doctrines of the bramins, contained in it, even to the copying of their exteriors of worship, and the distribution of their idols, though grossly mutilated and adulterated. With respect to the Vedam and Shafter, or scriptures of the Gentoos, this writer informs us, that *Vedam*, in the Malabar language, signifies the same as *Shafter* in the Shanferit; and that the first book is followed by the Gentoos of the Malabar and Coromandel coasts, and also of the island of Ceylon. The Shafter is followed by the Gentoos of the provinces of Bengal, and by all the Gentoos of the rest of India, commonly called *India Proper*, along the course of the rivers Ganges and Jumna to the Indus. Both these books (he says) contain the institutes of their respective religion and worship, as well as the history of their ancient rajahs and princes, often couched under allegory and fable. Their antiquity is contended for by the partisans of each; but he thinks, that the similitude of their names, idols, and great part of their worship, leaves little room to doubt, may plainly evince, that both these scriptures were originally one. He adds, if we compare the great purity and chaste manners of the Shafter with the great absurdities and impurities of the Vedam, we need not hesitate to pronounce the latter a corruption of the former.

With regard to the high original of these scriptures, the account of the bramins is as follows. Brahma (that is, "Mighty Spirit"), about 4866 years ago, assumed the form of man and the government of Hindostan. He translated the divine law (designed for the restoration of mankind, who had offended in a pre-existent state, and who are now in their last scene of probation, to the dignity from which they were degraded) out of the language of angels into the well known Shanferit language, and called his translation the *Chartah Bhade Shastab of Birmah*, or the *Six Scriptures of Divine Words of the Mighty Spirit*. He appointed the bramins, deriving their name from him, to preach the word of God; and the doctrines of the Shafter were accordingly preached in their original purity 1000 years. About this time there was published a paraphrase on the Chartah Bhade; and about 500 years afterwards, a second exposition, called the *Aughtorrah Bhade Shasta*, or *Eighteen Books of Divine Words*, written in a character compounded of the common Hindostan and the Shanferit. This innovation produced a schism among the Gentoos; on which occasion, it is said, those of Coromandel and Malabar formed a scripture of their own, which they pretended to be founded on the Chartah Bhade



Shafter. Bhade of Bramah, and called it the *Vedam of Brimha*, or *Divine Words of the Mighty Spirit*. The original Chartah Bhade was thrown aside, and at length wholly unknown, except to a few families; who can still read and expound it in the Shanferit character. With the establishment of the Aughtorrah Bhade, and Vedam, which, according to the Gentoo account, is 3366 years ago, their polytheism commenced; and the principles of religion became so obscure, and their ceremonies so numerous, that every head of a family was obliged to keep a bramin as a guide both in faith and practice. Mr Hollwell is of opinion, that the Chartah Bhade, or Original Scriptures, are not copied from any other system of theology, promulgated to or obtruded upon mankind. The Gentoos do not attribute them to Zoroaster; and Mr Holwell supposes, that both Zoroaster and Pythagoras visited Indostan, not to instruct, but to be instructed.

From the account of Mr Dow, we learn, that the books which contain the religion and philosophy of the Hindoos are distinguished by the name of *Bedas*; that they are four in number, and, like the sacred writings of other nations, said to be penned by the Divinity. Bada, he says, in the Shanferit language, literally signifies *science*; and these books treat not only of religion and moral duties, but of every branch of philosophic knowledge. The bramins maintain, that the Bedas are the divine laws, which Brimha, at the creation of the world, delivered for the instruction of mankind; but they affirm, that their meaning was perverted in the first age by the ignorance and wickedness of some princes, whom they represent as evil spirits, who then haunted the earth.

The first credible account we have of the Bedas is, that about the commencement of the Cal Jug, of which era the year 1768 was the 4886th year, they were written, or rather collected, by a great philosopher and reputed prophet, called *Beäfs Muni*, or *Beäfs the Inspired*.

The Hindoos, says Mr Dow, are divided into two great religious sects: the followers of the doctrine of Bedang, which is the original Shafter, or commentary upon the Bedas; and those who adhere to the principles of the Neadirfen. The original Shafter is called *Bedang*, and is a commentary upon the Bedas. This book, he says, is erroneously called in Europe the *Vedam*. It is ascribed to Beäfs Muni, and is said to have been revised some years after by one Serrider Swami, since which it has been reckoned sacred, and not subject to any farther alterations.

Almost all the Hindoos of the Decan, and those of the Malabar and Coromandel coasts, are of this sect. The followers of the Bedang Shafter do not allow that any physical evil exists; they maintain that God created all things perfectly good; but that man, being a free agent, may be guilty of moral evil, which may be injurious to himself, but can be of no detriment to the general system of nature. God, they say, being perfectly benevolent, never punished the wicked otherwise than by the pain and affliction which are the natural consequences of evil actions; and hell, therefore, is no other than a consciousness of evil.

The Neadirfen Shafter is said to have been written by a philosopher called *Goutam*, near four thousand years ago. The bramins, from Mr Dow's account of their

sacred books, appear to believe invariably in the unity, eternity, omniscience, and omnipotence of God; and the polytheism of which they have been accused is no more than a symbolical worship of the divine attributes, which they divide into three classes. Under the name of *Brimha*, they worship the wisdom and creative power of God; under the appellation of *Bisben*, his providential and preserving quality; and under that of *Shibah*, that attribute which tends to destroy.

As few of our readers may have an opportunity of perusing the Shafter, we shall, by way of specimen, subjoin a passage from it, which, though it contains some metaphysical mysteries concerning the creation, yet discovers views of God so enlightened that they would not disgrace more refined nations. The passage which we shall quote is the first chapter of the Shafter, which is a dialogue between Brimha the Wisdom of the Divinity, and Narud or Reason, who is represented as the son of Brimha. Narud desires to be instructed by his father; and for that purpose puts the following questions to him:

“*Narud*. O father! thou first of God, thou art said to have created the world, and thy son Narud, astonished at what he beholds, is desirous to be instructed how all these things were made.

“*Brimha*. Be not deceived, my son! do not imagine that I was the creator of the world, independent of the Divine Mover, who is the great original essence and creator of all things. Look, therefore, only upon me as the instrument of the great will, and a part of his being, whom he called forth to execute his eternal designs.

“*Narud*. What shall we think of God?

“*Brimha*. Being immaterial, he is above all conception; being invisible, he can have no form; but, from what we behold in his works, we may conclude that he is eternal, omnipotent, knowing all things, and present everywhere.

“*Narud*. How did God create the world?

“*Brimha*. Affection dwelt with God from all eternity. It was of three different kinds; the creative, the preserving, and the destructive. This first is represented by Brimha, the second by Bisben, and the third by Shibah. You, O Narud! are taught to worship all the three in various shapes and likenesses, as the Creator, the Preserver, and the Destroyer. The affection of God then produced power, and power, at a proper conjunction of time and fate, embraced goodness, and produced matter. The three qualities then acting upon matter, produced the universe in the following manner: From the opposite actions of the creative and destructive quality in matter, self-motion first arose. Self-motion was of three kinds; the first inclining to plasticity, the second to discord, and the third to rest. The discordant actions then produced the Akash (a kind of celestial element), which invisible element possessed the quality of conveying sound; it produced air, a palpable element; fire, a visible element; water, a fluid element; and earth, a solid element.

“The Akash dispersed itself abroad. Air formed the atmosphere; fire, collecting itself, blazed forth in the host of heaven; water rose to the surface of the earth, being forced from beneath by the gravity of the latter element. Thus broke forth the world from the veil of darkness, in which it was formerly comprehend-

Shaw.

ed by God. Order rose over the universe. The seven heavens were formed, and the seven worlds were fixed in their places; there to remain till the great dissolution, when all things shall be absorbed into God.

"God seeing the earth in full bloom, and that vegetation was sprung from its seeds, called forth for the first time intellect, which he endued with various organs and shapes, to form a diversity of animals upon the earth. He endued the animals with five senses; feeling, seeing, smelling, tasting, and hearing; but to man he gave reflection, to raise him above the beasts of the field.

"The creatures were created male and female, that they might propagate their species upon the earth. Every herb bore the seed of its kind, that the world might be clothed with verdure, and all animals provided with food.

"*Narud.* What dost thou mean, O father! by intellect?

"*Brimba.* It is a portion of the great soul of the universe breathed into all creatures, to animate them for a certain time.

"*Narud.* What becomes of it after death?

"*Brimba.* It animates other bodies, or returns, like a drop, into that unbounded ocean from which it first arose.

"*Narud.* Shall not then the souls of good men receive rewards? nor the souls of the bad meet with punishment?

"*Brimba.* The souls of men are distinguished from those of other animals; for the first are endued with reason, and with a consciousness of right and wrong. If therefore man shall adhere to the first, as far as his powers shall extend, his soul, when disengaged from the body by death, shall be absorbed into the divine essence, and shall never more reanimate flesh: But the souls of those who do evil are not, at death, disengaged from all the elements. They are immediately clothed with a body of fire, air, and akash, in which they are for a time punished in hell. After the season of their grief is over, they reanimate other bodies; but till they shall arrive at a state of purity they can never be absorbed into God.

"*Narud.* What is the nature of that absorbed state which the souls of good men enjoy after death?

"*Brimba.* It is a participation of the divine nature, where all passions are utterly unknown, and where consciousness is lost in bliss.

"*Narud.* Thou sayest, O father, that unless the soul is perfectly pure it cannot be absorbed into God: now, as the actions of the generality of men are partly good and partly bad, whither are their spirits sent immediately after death?

"*Brimba.* They must atone for their crimes in hell, where they must remain for a space proportioned to the degree of their iniquities; then they rise to heaven to be rewarded for a time for their virtues; and from thence they will return to the world to reanimate other bodies.

"*Narud.* What is time?

"*Brimba.* Time existed from all eternity with God: but it can only be estimated since motion was produced, and only be conceived by the mind, from its own constant progress.

"*Narud.* How long shall this world remain?

"*Brimba.* Until the four Ings shall have revolved.

Then Rudder (the same with *Shibah*, the destroying quality of God), with the ten spirits of dissolution, shall roll a comet under the moon, that shall involve all things in fire, and reduce the world into ashes. God shall then exist alone, for matter will be totally annihilated."

Those who desire more information on this subject may consult *Dow's History of Indostan*, and *Holwell's Interesting Historical Events*.

SHAW (Dr Thomas), known to the learned world by his travels to Barbary and the Levant, was born at Kendal in Westmoreland about the year 1692. He was appointed chaplain to the English consul at Algiers, in which station he continued for several years; and from thence took proper opportunities of travelling into different parts. He returned in 1733; was elected fellow of the Royal Society; and published the account of his travels at Oxford, folio, 1738. In 1740 he was nominated principal of St Edmond-hall, which he raised from a ruinous state by his munificence; and was regius professor of Greek at Oxford until his death, which happened in 1751. Dr Clayton, Bp. of Clogher, having attacked these Travels in his Description of the East, Dr Shaw published a supplement by way of vindication, which is incorporated into the second edition of his Travels, prepared by himself, and published in 4to, 1757.

SHAWLS, are woollen handkerchiefs, an ell wide, and near two long. The wool is so fine and silky, that the whole handkerchief may be contained in the two hands closed. It is the produce of a Tibet sheep; but some say that no wool is employed but that of lambs torn from the belly of their mother before the time of birth. The most beautiful shawls come from Cashmere: their price is from 150 livres (about six guineas) to 1200 livres (or L. 50 Sterling.)

In the Transactions of the Society for Encouraging Arts, Manufactures, &c. for the year 1792, we are informed that a shawl counterpane, four yards square, manufactured by Mr P. J. Knights of Norwich, was presented to the society; and that, upon examination, it appeared to be of greater breadth than any goods of equal fineness and texture that had ever before been presented to the society, or to their knowledge woven in this country. The shawls of Mr Knights's manufacture, it is said, can scarcely be distinguished from Indian shawls, though they can be afforded at one-twentieth part of the price. When the shawl is 16 quarters square, Mr Knights says it may be retailed at L. 20; if it consisted of 12 quarters, and embroidered as the former, it will cost L. 15; if plain, with a fringe only, a shawl of 16 quarters square may be sold at L. 8, 8 s.; if 12 quarters and fringed, at L. 6, 6 s.

Mr Knights maintains, that his counterpane of four yards square is equal in beauty, and superior in strength, to the Indian counterpanes which are sold at 200 guineas. The principal consumption of this cloth is in train-dresses for ladies; as likewise for long scarfs, in imitation of the real Indian scarfs, which are sold from L. 60 to L. 80; whereas scarfs of this fabric are sold for as many shillings, and the ladies square shawls in proportion.

SHEADING, a riding, tything, or division, in the Isle of Man; the whole island being divided into six sheadings; in every one of which is a coroner or chief constable,

Shaw  
Sheading

ear-bill  
||  
sheep.  
constable, appointed by the delivery of a rod at the annual convention.

**SHEARBILL**, the *Rhynchops Nigra* of Linnæus, the *Black Skimmer* of Pennant and Latham, and *Cut-water* of Catesby. Its bill is much compressed; the edges are sharp; the lower mandible is four inches and a half long; the upper only three; the base red; the rest is black: the forehead, chin, front of the neck, the breast, and belly, are white: the head and whole upper part of the body are black: the wings are of the same colour: the lower part of the inner webs of the primaries is white: the tail is short, and a little forked; the middle feathers are dusky; the others are white on their sides: the legs are weak and red: the length is one foot eight inches: the extent is three feet seven inches. It inhabits America from New York to Guiana. It skims nimbly along the water, with its under mandible just beneath the surface, feeding on the insects and small fish as it proceeds. It frequents also oyster-banks; its bill being partly like that of the oyster-catcher, adapted for preying on those shell-fish.

**SHEATHING**, in the sea-language, is the casing that part of a ship which is to be under water with fir-board of an inch thick; first laying hair and tar mixed together under the boards, and then nailing them on, in order to prevent worms from eating the ship's bottom.—Ships of war are now generally sheathed with copper: but copper sheathing is liable to be corroded by the action of salt water, and something is still wanting to effect this purpose. It is very probable that tar might answer very well.

In the Cornish mines, copper or brass pumps are often placed in the deepest parts, and are consequently exposed to the vitriolic or other mineral waters with which some of these mines abound, and which are known to have a much stronger effect on copper than sea-water. These pumps are generally about six feet long, and are screwed together, and made tight by the interposition of a ring of lead, and the joinings are afterwards tarred. One of these pumps was so much corroded as to render it unfit for use; but the spots of tar, which by accident had dropped on it, preserved the parts they covered from the action of the water. These projects in some places more than a quarter of an inch; and the joints were so far defended by the thin coat of tar, that it was as perfect as when it came from the hands of the manufacturer. If tar thus effectually defends copper from these acrimonious waters, can there remain a doubt of its preserving it from the much milder waters of the sea?

**SHEATS**, in a ship, are ropes bent to the clews of the sails; serving in the lower sails to haul aft the clews of the sail; but in top-sails they serve to haul home the clew of the sail close to the yard-arm.

**SHEEP**, in zoology. See **Ovis** and **Wool**.

Amongst the various animals with which Divine Providence has stored the world for the use of man, none is to be found more innocent, more useful, or more valu-

able, than the sheep. The sheep supplies us with food and clothing, and finds ample employment for our poor at all times and seasons of the year, whereby a variety of manufactures of woollen cloth is carried on without interruption to domestic comfort and loss to friendly society or injury to health, as is the case with many other occupations. Every lock of wool that grows on its back becomes the means of support to staplers, dyers, pickers, scourers, scriblers, carders, combers, spinners, spoolers, warpers, queelers, weavers, fullers, tuckers, burlers, shearmen, pressers, clothiers, and packers, who, one after another, tumble and tofs, and twist, and bake, and boil, this raw material, till they have each extracted a livelihood out of it; and then comes the merchant, who, in his turn, ships it (in its highest state of improvement) to all quarters of the globe, from whence he brings back every kind of riches to his country, in return for this valuable commodity which the sheep affords.

Besides this, the useful animal, after being deprived of his coat, produces another against the next year; and when we are hungry, and kill him for food, he gives us his skin to employ the fell-mongers and parchment-makers, who supply us with a durable material for securing our estates, rights, and possessions; and if our enemies take the field against us, supplies us with a powerful instrument for rousing our courage to repel their attacks. When the parchment-maker has taken as much of the skin as he can use, the glue-maker comes after and picks up every morsel that is left, and therewith supplies a material for the carpenter and cabinet-maker, which they cannot do without, and which is essentially necessary before we can have elegant furniture in our houses; tables, chairs, looking-glasses, and a hundred other articles of convenience: and when the winter nights come on, while we are deprived of the cheering light of the sun, the sheep supplies us with an artificial mode of light, whereby we preserve every pleasure of domestic society, and with whose assistance we can continue our work, or write or read, and improve our minds, or enjoy the social mirth of our tables. Another part of the slaughtered animal supplies us with an ingredient necessary for making good common soap, a useful store for producing cleanliness in every family, rich or poor. Neither need the horns be thrown away; for they are converted by the button-makers and turners into a cheap kind of buttons, tips for bows, and many useful ornaments. From the very trotters an oil is extracted useful for many purposes, and they afford good food when baked in an oven.

Even the bones are useful also; for by a late invention of Dr Higgins, they are found, when reduced to ashes, to be an useful and essential ingredient in the composition of the finest artificial stone in ornamental work for chimney-pieces, cornices of rooms, houses, &c. which renders the composition more durable by effectually preventing its cracking (A).

If it is objected to the meek inoffensive creature, that

he

(A) Any curious person would be much entertained to see the manufactory of bone-ash, now carried on by Mr Minish of White chapel, New Road, wherein the bones of sheep and cows undergo many ingenious processes. 1. There is a mill to break them; 2. A cauldron to extract their oil, marrow, and fat; 3. A reverberatory to heat them red-hot; 4. An oven for those bones to moulder to ashes; 5. A hill to collect the fumes of the burnt

Sheep.

he is expensive while living, in eating up our grafs, &c. it may be answered that it is quite the contrary; for he can feed where every other animal has been before him and grazed all they could find; and that if he takes a little grafs on our downs or in our fields, he amply repays us for every blade of grafs in the richnefs of the manure which he leaves behind him. He protects the hands from the cold wintry blaft, by providing them with the foftelt leather gloves. Every gentleman's library is alfo indebted to him for the neat binding of his books, for the sheath of his fword, and for cafes for his inftruments; in fhort, not to be tedious in mentioning the various ufes of leather, there is hardly any furniture or utenfil of life but the fheep contributes to render either more ufeul, convenient, or ornamental.

As the fheep is fo valuable an animal, every piece of information concerning the proper method of managing it muft be of importance. It will not therefore be ufelefs nor unentertaining to give fome account of the manner of managing fheep in Spain, a country famous for producing the beft wool in the world.

<sup>2</sup>  
Account of  
the Spanifh  
fheep

In Spain there are two kinds of fheep: the coarfe-wooled fheep, which always remain in their native country, and are houfed every night in winter; and the fine-wooled fheep, which are always in the open air, and travel every fummer from the cool mountains of the northern parts of Spain, to feed in winter on the fouthern warm plains of Andaluſia, Mancha, and Eſtramadura. Of thefe latter, it appears from accurate computations, that there are about five millions (B); and that the wool and flefh of a flock of 10,000 fheep produce yearly about 24 reals a-head, or about the value of 12 Englifh fhipences, one of which belongs to the owner, three to the king, and the other eight are allowed for the expences of paſture, tythes, fhepherds, dogs, falt, fhearing, &c. Ten thouſand fheep form a flock, which is divided into ten tribes, under the management of one perfon, who has abſolute dominion over fifty fhepherds and fifty dogs.

<sup>3</sup>  
Of Segovia,

M. Bourgoanne, a French gentleman, who refided many years in Spain, and directed his inquiries chiefly to the civil government, trade, and manufactures, of that country, gives the following account of the wandering fheep of Segovia. "It is (ſays he) in the neighbouring mountains that a part of the wandering fheep feed during the fine feaſon. They leave them in the month of October, paſs over thoſe which ſeparate the two Caſtles, croſs New Caſtile, and diſperſe themſelves in the plains of Eſtramadura and Andaluſia. For ſome years paſt thoſe of the two Caſtles, which are within reach of the Sierra-Morena, go thither to paſs the win-

<sup>3</sup>  
Bourgo-  
anne's Tra-  
vels, vol. i.  
p. 53.

ter; which, in that part of Spain, is more mild: the length of their day's journey is in proportion to the paſture they meet with. They travel in flocks from 1000 to 1200 in number, under the conduct of two fhepherds; one of whom is called the *Mayorat*, the other the *Zagal*. When arrived at the place of their deſtination, they are diſtributed in the paſtures previously aſſigned them. They return in the month of April; and whether it be habit or natural inſtinct that draws them towards the climate, which at this feaſon becomes moſt proper for them, the inquietude which they manifeſt might, in caſe of need, ſerve as an almanac to their conductors."

Mr Arthur Young, in that patriotic work which he conducted with great induſtry and judgment, the *Annals of Agriculture*, gives us a very accurate and intereſting account of the Pyrenean or Catalonian fheep.

"On the northern ridge, bearing to the weſt, are <sup>4</sup> the paſtures of the Spanifh flocks. This ridge is not, <sup>4</sup> however, the whole; there are two other mountains, <sup>4</sup> quite in a different ſituation, and the fheep travel from <sup>4</sup> one to another as the paſtorage is ſhort or plentiful. I <sup>4</sup> examined the foil of theſe mountain paſtures, and found <sup>4</sup> it in general ſtony; what in the weſt of England would <sup>4</sup> be called a *ſtone braſh*, with ſome mixture of loam, and <sup>4</sup> in a few places a little peaty. The plants are many of <sup>4</sup> them untouched by the fheep; many ferns, narcifſus, <sup>4</sup> violets, &c. but burnet (*poterium ſanguiferba*) and the <sup>4</sup> narrow-leaved plantain (*plantago lanceolata*) were eaten, <sup>4</sup> as may be ſuppoſed, cloſe. I looked for trefoils, but <sup>4</sup> found ſcarcely any: it was very apparent that foil and <sup>4</sup> peculiarity of herbage had little to do in rendering theſe <sup>4</sup> heights proper for fheep. In the northern parts of Eu- <sup>4</sup> rope, the tops of mountains half the height of theſe <sup>4</sup> (for we were above ſnow in July) are boys, all are fo <sup>4</sup> which I have ſeen in our iſlands, or at leaſt the pro- <sup>4</sup> portion of dry land is very trifling to that which is <sup>4</sup> extremely wet: Here they are in general very dry. Now <sup>4</sup> a great range of dry land, let the plants be what they <sup>4</sup> may, will in every country ſuit fheep. The flock is <sup>4</sup> brought every night to one ſpot, which is ſituated at <sup>4</sup> the end of the valley on the river I have mentioned, and <sup>4</sup> near the port or paſſage of Picada: it is a level ſpot <sup>4</sup> ſheltered from all winds. The foil is 8 or 9 inches deep <sup>4</sup> of old dung, not at all incloſed: from the freedom from <sup>4</sup> wood all around, it ſeems to be choſen partly for ſafety <sup>4</sup> againſt wolves and bears. Near it is a very large ſtone, <sup>4</sup> or rather rock, fallen from the mountain. This the <sup>4</sup> fhepherds have taken for a ſhelter, and have built a hut <sup>4</sup> againſt it; their beds are ſheep ſkins, and their door fo <sup>4</sup> ſmall that they crawl in. I ſaw no place for fire; but <sup>4</sup> they have it, ſince they dreſs here the flefh of their fheep, <sup>4</sup> and

Sheep.

bones into a brown fluid, from whence hartſhorn is made; 6. Furnaces for making parts thereof into Glauber's ſalts; 7. A ſand heat containing twelve jars, for collecting a cryſtallizing vapour into ſal-ammoniac.

(B) In the 16th century the travelling fheep were eſtimated at ſeven millions: under Philip III. the number was diminiſhed to two millions and a half. Uſtariz, who wrote at the beginning of this century, made it amount to four millions. The general opinion is, that at preſent it does not exceed five millions. If to this number the eight millions of ſtationary fheep be added, it will make nearly thirteen millions of animals, all managed contrary to the true intereſts of Spain, for the advantage of a few individuals. For the proprietors of ſtationary flocks alſo have privileges which greatly reſemble thoſe of the members of the Meſta. According to Arriquebar, Spain contains eight millions of fine-wooled fheep, ten millions of coarſe-wooled, and five hundred thouſand bulls, oxen, and cows.

Sheep. and in the night sometimes keep off the bears, by whirling fire-brands: four of them belonging to the flock mentioned above lie here. I viewed their flock very carefully, and by means of our guide and interpreter, made some inquiries of the shepherds, which they answered readily, and very civilly. A Spaniard at Venafque, a city in the Pyrenees, gives 600 livres French (the livre is 10½d. English) a-year for the pasturage of this flock of 2000 sheep. In the winter he sends them into the lower parts of Catalonia, a journey of 12 or 13 days, and when the snow is melted in the spring, they are conducted back again. They are the whole year kept in motion, and moving from spot to spot, which is owing to the great range they everywhere have of pasture. They are always in the open air, never housed or under cover, and never taste of any food but what they can find on the hills.

“Four shepherds, and from four to six large Spanish dogs, have the care of this flock: the latter are in France called of the *Pyrenees breed*; they are black and white, of the size of a large wolf, a large head and neck, armed with collars stuck with iron spikes. No wolf can stand against them; but bears are more potent adversaries: if a bear can reach a tree, he is safe; he rises on his hind legs, with his back to the tree, and sets the dogs at defiance. In the night the shepherds rely entirely on their dogs; but on hearing them bark are ready with fire-arms, as the dogs rarely bark if a bear is not at hand. I was surprised to find that they are fed only with bread and milk. The head shepherd is paid 120 livres a-year wages and bread; the others 80 livres and bread: But they are allowed to keep goats, of which they have many which they milk every day. Their food is milk and bread, except the flesh of such sheep or lambs as accidents give them. The head shepherd keeps on the mountain top, or an elevated spot, from whence he can the better see around while the flock traverses the declivities. In doing this the sheep are exposed to great danger in places that are stony; for by walking among the rocks, and especially the goats, they move the stones, which, rolling down the hills, acquire an accelerated force enough to knock a man down, and sheep are often killed by them; yet we saw how alert they were to avoid such stones, and cautiously on their guard against them. I examined the sheep attentively. They are in general polled, but some have horns; which in the rams turn backwards behind the ears and project half a circle forward; the ewes horns turn also behind the ears, but do not project: the legs white or reddish; speckled faces, some white, some reddish; they would weigh fat, I reckon, on an average, from 15 lb. to 18 lb. a quarter. Some tails short, some left long. A few black sheep among them: some with a very little tuft of wool on their foreheads. On the whole they resemble those on the South Downs; their legs are as short as those of that breed: a point which merits observation, as they travel so much and so well. Their shape is very good; round ribs and flat straight backs; and would with us be reckoned handsome sheep; all in good order and flesh. In order to be still better acquainted with them, I desired one of the shepherds to catch a ram for me to feel, and examine the wool, which I found very thick and good of the carding sort, as may be supposed. I took a specimen of it,

and also of a hoggit, or lamb of last year. In regard to the mellow softness under the skin, which, in Mr Bakewell's opinion, is a strong indication of a good breed, with a disposition to fatten, he had it in a much superior degree to many of our English breeds, to the full as much so as the South Downs, which are for that point the best short-woolled sheep which I know in England. The fleece was on his back, and weighed, as I guessed, about 8 lb. English; but the average, they say, of the flock is from four to five, as I calculated by reducing the Catalonian pound of 12 oz. to ours of 16, and is all sold to the French at 30s. the lb. French. This ram had the wool of the back part of his neck tied close, and the upper tuft tied a second knot by way of ornament; nor do they ever shear this part of the fleece for that reason: we saw several in the flock with this species of decoration. They said that this ram would sell in Catalonia for 20 livres. A circumstance which cannot be too much commended, and deserves universal imitation, is the extreme docility they accustom them to. When I desired the shepherd to catch one of his rams, I supposed he would do it with his crook, or probably not be able to do it at all; but he walked into the flock, and singling out a ram and a goat, bid them follow him, which they did immediately; and he talked to them while they were obeying him, holding out his hand as if to give them something. By this method he brought me the ram, which I caught, and held without difficulty.”

The best sort of sheep for fine wool are those bred in Herefordshire, Devonshire, and Worcestershire; but they are small, and black-faced, and bear but a small quantity. Warwick, Leicestershire, Buckingham, and Northamptonshire, breed a large boned sheep, of the best shape and deepest wool we have. The marshes of Lincolnshire breed a very large kind of sheep, but their wool is not good, unless the breed be mended by bringing in sheep of other counties among them, which is a scheme of late very profitably followed there. In this county, it is no uncommon thing to give fifty guineas for a ram, and a guinea for the admission of an ewe to one of these valuable males, or twenty guineas for the use of it for a certain number of ewes during one season. Suffolk also breeds a very valuable kind of sheep. The northern counties in general breed sheep with long but hairy wool: however, the wool which is taken from the neck and shoulders of the Yorkshire sheep is used for mixing with Spanish wool in some of their finest cloths.

Wales bears a small hardy kind of sheep, which has the best tasted flesh, but the worst wool of all. Nevertheless it is of more extensive use than the finest Segovian fleeces; for the benefit of the flannel manufacture is universally known. The sheep of Ireland vary like those of Great Britain: those of the south and east being large and their flesh rank: those of the north and the mountainous parts small and their flesh sweet. The fleeces in the same manner differ in degrees of value. Scotland breeds a small kind, and their fleeces are coarse.

But the new Leicestershire breed is the most fashionable, and of course the most profitable breed in the island. Joseph Altom of Clifton, who raised himself from a plough-boy, was the first who distinguished him-

Sheep.

What sheep  
produce the  
best wool?

Sheep. self in the midland counties of England for a superior breed of sheep. How he improved his breed is not known; but it was customary for eminent farmers in his time to go to Clifton in summer to choose and purchase ram-lambs, for which they paid two or three guineas. This man was succeeded by Mr Bakewell; and it may reasonably be supposed that the breed, by means of Alton's flock, had passed the first stage of improvement before Mr Bakewell's time. Still, however, it must be acknowledged, that the Leicestershire breed of sheep owes its present high state of improvement to the ability and care of Mr Bakewell.

6 Account of Mr Bakewell's breed. Marshall's Midland Counties, vol. i. P. 382. "The manner in which Mr Bakewell raised his sheep to the degree of celebrity in which they deservedly stand, is, notwithstanding the recentness of the improvement, and its being done in the day of thousands now living, a thing in dispute; even among men high in the profession, and living in the very district in which the improvement has been carried on!

7 How it is supposed he improved it. "Some are of opinion that he effected it by a cross with the Wiltshire breed; an improbable idea, as their form altogether contradicts it: others, that the Ryeland breed were used for this purpose; and with some show of probability. If any cross whatever was used, the Ryeland breed, whether we view the form, the size, the wool, the flesh, or the fatting quality, is the most probable instrument of improvement.

"These ideas, however, are registered merely as matters of opinion. It is more than probable that Mr Bakewell alone is in possession of the several minutiae of improvement; and the public can only hope that at a proper time the facts may be communicated for the direction of future improvers.

"Whenever this shall take place, it will most probably come out that no cross with any alien breed whatever has been used; but that the improvement has been effected by selecting individuals from kindred breeds; from the several breeds or varieties of long-woolled sheep, with which Mr Bakewell was surrounded on almost every side, and by breeding, *inandin* (c), with this selection: solicitously seizing the superior accidental varieties produced; associating these varieties; and still continuing to select, with judgment, the superior individuals.

8 Description of his ewes and wedders. "It now remains to give a description of the superior class of individuals of this breed, especially ewes and wedders, in full condition, but not immoderately fat. The rams will require to be distinguished afterwards.

"The head is long, small, and hornless, with ears somewhat long, and standing backward, and with the nose shooting forward. The neck thin, and clean toward the head; but taking a conical form; standing low, and enlarging every way at the base; the fore-end altogether short. The bosom broad, with the shoulders, ribs, and chine extraordinary full. The loin broad, and the back level. The haunches comparatively full toward the hips, but light downward; being altogether small in proportion to the fore-parts. The legs, at present, of a moderate length; with the bone extremely fine. The bone throughout remarkably light. The

carcase, when fully fat, takes a remarkable form; much wider than it is deep, and almost as broad as it is long. Full on the shoulder, widest on the ribs, narrowing with a regular curve towards the tail; approaching the form of the turtle nearer perhaps than any other animal. The pelt is thin, and the tail small. The wool is shorter than long wools in general, but much longer than the middle wools; the ordinary length of staple five to seven inches, varying much in fineness and weight."

This breed surpasses every other in beauty of form; they are full and weighty in the fore quarters; and are remarkable for smallness of bone. Mr Marshall, who has been of so much benefit to agriculture and his country by his publications, informs us, in his Rural Economy of the Midland Counties, that he has seen a rib of a sheep of this breed contrasted with one of a Norfolk sheep: the disparity was striking; the latter nearly twice the size; while the meat which covered the former was three times the thickness: consequently the proportion of meat to bone was in the one incomparably greater than in the other. Therefore, in this point of view, the improved breed has a decided preference: for surely while mankind continue to eat flesh and throw away bone, the former must be, to the consumer at least, the more valuable.

The criterions of good and bad flesh while the animal is alive differ in different species, and are not properly settled in the same species. One superior breeder is of opinion, that if the flesh is not loose, it is of course good; holding, that the flesh of sheep is never found in a state of hardness, like that of ill-fleshed cattle: while others make a fourfold distinction of the flesh of sheep; as looseness, mellowness, firmness, hardness: considering the first and the last equally exceptionable, and the second and third equally desirable; a happy mixture of the two being deemed the point of perfection.

The flesh of sheep, when slaughtered, is well known to be of various qualities. Some is composed of large coarse grains, interspersed with wide empty pores like a sponge: others, of large grains, with wide pores filled with fat; others, of fine close grains, with smaller pores filled with fat: and a fourth, of close grains, without any intermixture of fatness.

The flesh of sheep, when dressed, is equally well known to possess a variety of qualities: some mutton is coarse, dry, and insipid; a dry sponge, affording little or no gravy of any colour. Another sort is somewhat firmer, imparting a light-coloured gravy only. A third plump, short, and palatable; affording a mixture of white and red gravy. A fourth likewise plump and well-flavoured, but discharging red gravy, and this in various quantities.

It is likewise observable, that some mutton, when dressed, appears covered with a thick, tough, parchment-like integument; others with a membrane comparatively fine and flexible. But these, and some of the other qualities of mutton, may not be wholly owing to breed, but in part to the age and the state of fatness at the time of slaughter. Examined in this light, whether

(c) *Inandin* is a term used in the midland counties of England to express breeding from the same family.

then we consider the degree of fatness, or their natural propensity to a state of fatness, even at an early age, the improved breed of Leicestershire sheep appear with many superior advantages.

The degree of fatness to which the individuals of this breed are capable of being raised, will perhaps appear incredible to those who have not had an opportunity of being convinced by their own observation. "I have seen widders (says Mr Marshall) of only two shear (two to three years old) so loaded with fat as to be scarcely able to make a run; and whose fat lay so much without the bone, it seemed ready to be shaken from the ribs on the smallest agitation.

"It is common for the sheep of this breed to have such a projection of fat upon the ribs, immediately behind the shoulder, that it may be easily gathered up in the hand, as the flank of a fat bullock. Hence it has gained, in technical language, the name of the *fore-flank*; a point which a modern breeder never fails to touch in judging of the quality of this breed of sheep.

"What is, perhaps, still more extraordinary, it is not rare for the rams, at least of this breed, to be 'cracked on the back;' that is, to be cloven along the top of the chine, in the manner fat sheep generally are upon the rump. This mark is considered as an evidence of the best blood.

"Extraordinary, however, as are these appearances while the animals are living, the facts are still more striking after they are slaughtered. At Litchfield, in February 1785, I saw a fore quarter of mutton, fattened by Mr Princep of Croxall, and which measured upon the ribs four inches of fat. It must be acknowledged, however, that the Leicestershire breed do not produce so much wool as most other long-woolled sheep."

As the practice of letting rams by the season is now become profitable, it may be useful to mention the method of rearing them.

"The principal ram-breeders save annually twenty, thirty, or perhaps forty ram lambs; castration being seldom applied, in the first instance, to the produce of a valuable ram. for in the choice of these lambs they are led more by blood, or parentage, than by form; on which, at an early age, little dependence can be placed. Their treatment from the time they are weaned, in July or August, until the time of shearing, the first week in June, consists in giving them every indulgence of keep, in order to push them forward for the show; it being the common practice to let such as are fit to be let the first season, while they are yet yearlings—provincially 'sharhogs.'

"Their first pasture, after weaning, is pretty generally, I believe, clover that has been mown early, and has got a second time into head; the heads of clover being considered as a most forcing food of sheep. After this goes off, turnips, cabbages, colewort, with hay, and (report says) with corn. But the use of this the breeders severally deny, though collectively they may be liable to the charge.

"Be this as it may, something considerable depends on the art of making up, not lambs only, but rams of all ages. Fat, like charity, covers a multitude of faults; and besides, is the best evidence of their fattening quality which their owners can produce (*i.e.* their natural propensity to a state of fatness), while in the fatness of the

sharhogs is seen their degree of inclination to fat at an early age.

"Fattening quality being the one thing needful in grazing stock, and being found, in some considerable degree at least, to be hereditary, the fattest rams are of course the best; though other attachments, well or ill placed, as to form or fashionable points, will perhaps have equal or greater weight in the minds of some men, even in this enlightened age. Such shearlings as will not make up sufficiently as to form and fatness, are either kept on to another year to give them a fair chance, or are castrated, or butchered while sharhogs."

From the first letting, about 40 years ago, to the year 1780, the prices kept gradually rising from fifteen shillings to a guinea, and from one to ten. In 1780 Mr Bakewell let several at ten guineas each; and, what is rather inexplicable, Mr Parkinson of Quarndon let one the same year for twenty-five guineas; a price which then astonished the whole country.

From that time to 1786 Mr Bakewell's stock rose rapidly from ten to a hundred guineas; and that year he let two thirds of one ram (reserving one third of the usual number of ewes to himself) to two principal breeders, for a hundred guineas each, the entire services of the ram being rated at three hundred guineas! Mr Bakewell making that year, by letting twenty rams only, more than a thousand pounds!

Since that time the prices have been still rising. Four hundred guineas have been repeatedly given. Mr Bakewell, this year (1789) makes, says Mr Marshall, twelve hundred guineas by three rams (brothers, we believe); two thousand of seven; and of his whole letting, full three thousand guineas!

Beside this extraordinary sum made by Mr Bakewell, there are six or seven other breeders who make from five hundred to a thousand guineas each. The whole amount of monies produced that year in the Midland Counties, by letting rams of the modern breed for one season only, is estimated, by those who are adequate to the subject, at the almost incredible sum of ten thousand pounds.

Rams previous to the season are reduced from the cumbersome fat state in which they are shown. The usual time of sending them out is the middle of September. They are conveyed in carriages of two wheels with springs, or hung in slings, 20 or 30 miles a-day, sometimes to the distance of 200 or 300 miles. They are not turned loose among the ewes, but kept apart in a small inclosure, where a couple of ewes only are admitted at once. When the season is over every care is taken to make the rams look as fat and handsome as possible.

In the choice of ewes the breeder is led by the same criterions as in the choice of rams. Breed is the first object of consideration. Excellency, in any species or variety of live-stock, cannot be attained with any degree of certainty, let the male be ever so excellent, unless the females employed likewise inherit a large proportion of the genuine blood, be the species or variety what it may. Hence no prudent man ventures to give the higher prices for the Dishley rams, unless his ewes are deeply tinged with the Dishley blood. Next to breed is flesh, fat, form, and wool.

After the lambs are weaned, the ewes are kept in common feeding places, without any alteration of pas-

Sheep.

11  
What sums  
Mr Bake-  
well re-  
ceived for  
letting  
them.

12  
The treat-  
ment of  
the rams  
and choice  
of ewes.

**Sheep.** ture, previous to their taking the ram. In winter they are kept on grass, hay, turnips, and cabbages. As the heads of the modern breed are much finer than most others, the ewes lamb with less difficulty.

The female lambs, on being weaned, are put to good keep, but have not such high indulgence shown them as the males, the prevailing practice being to keep them from the ram the first autumn.

At weaning time, or previously to the admission of the ram, the ewes are culled, to make room for the thieves or shearlings, whose superior blood and fashion entitle them to a place in the breeding flock. In the work of culling, the ram-breeder and the mere grazier go by somewhat different guides. The grazier's guide is principally age, seldom giving his ewes the ram after they are four shear. The ram-breeder, on the contrary, goes chiefly by merit; an ewe that has brought him a good ram or two is continued in the flock so long as she will breed. There are instances of ewes having been prolific to the tenth or twelfth year; but in general the ewes of this breed go off at six or seven shear.

In the practice of some of the principal ram-breeders, the culling ewes are never suffered to go out of their hands until after they are slaughtered, the breeders not only fattening them, but having them butchered, on their premises. There are others, however, who sell them; and sometimes at extraordinary prices. Three, four, and even so high as ten, guineas each have been given for these outcasts.

There are in the flocks of several breeders ewes that would fetch at auction twenty guineas each. Mr Bakewell is in possession of ewes which, if they were now put up to be sold to the best bidder, would, it is estimated, fetch no less than fifty each, and perhaps, through the present spirit of contention, much higher prices.

13  
Instructions  
for purcha-  
sing sheep.

The following instructions for purchasing sheep, we hope, will be acceptable to our country readers.—The farmer should always buy his sheep from a worse land than his own, and they should be big-boned, and have a long greasy wool, curling close and well. These sheep always breed the finest wool, and are also the most approved of by the butcher for sale in the market. For the choice of sheep to breed, the ram must be young, and his skin of the same colour with his wool, for the lambs will be of the same colour with his skin. He should have a large long body; a broad forehead, round, and well rising; large eyes; and straight and short nostrils. The polled sheep, that is, those which have no horns, are found to be the best breeders. The ewe should have a broad back; a large bending neck; small, but short, clean, and nimble legs; and a thick, deep wool covering her all over.

To know whether they be found or not, the farmer should examine the wool that none of it be wanting, and see that the gums be red, the teeth white and even, and the bristles skin red, the wool firm, the breath sweet, and the feet not hot. Two years old is the best time for beginning to breed; and their first lambs should not be kept too long, to weaken them by suckling, but be sold as soon as conveniently may be. They will breed advantageously till they are seven years old. The farmers have a method of knowing the age of a sheep, as a horse's is known, by the mouth. When a sheep

is one shear, as they express it, it has two broad teeth before; when it is two shear, it will have four; when three, six; and when four, eight. After this their mouths begin to break.

The difference of land makes a very great difference in the sheep. The fat pastures breed straight tall sheep, and the barren hills and downs breed square short ones; woods and mountains breed tall and slender sheep; but the best of all are those bred upon new-ploughed land and dry grounds. On the contrary, all wet and moist lands are bad for sheep, especially such as are subject to be overflowed, and to have sand and dirt left on them. The salt marshes are, however, an exception to this general rule, for their saltness makes amends for their moisture; salt, by reason of its drying quality, being of great advantage to sheep.

As to the time of putting the rams to the ewes, the farmer must consider at what time of the spring his grasses will be fit to maintain them and their lambs, and whether he has turnips to do it till the grass comes; for very often both the ewes and lambs are destroyed by the want of food; or if this does not happen, if the lambs are only stinted in their growth by it, it is an accident that they never recover. The ewe goes 20 weeks with lamb, and according to this it is easy to calculate the proper time. The best time for them to yearn is in April, unless the owner has very forward grass or turnips, or the sheep are field sheep. Where you have not inclosures to keep them in, then it may be proper they should yearn in January, that the lambs may be strong by May-day, and be able to follow the dam over the fallows and water-turrows; but then the lambs that come so early must have a great deal of care taken of them, and so indeed should all other lambs at their first falling, else while they are weak the crows and magpies will pick their eyes out.

When the sheep are turned into fields of wheat or rye to feed, it must not be too rank at first, for if it be, it generally throws them into scourings. Ewes that are big should be kept but bare, for it is very dangerous to them to be fat at the time of their bringing forth their young. They may be well fed, indeed, like cows, a fortnight beforehand, to put them in heart. Mortimer's Husbandry, p. 243.

The feeding sheep with turnips is one great advantage to the farmers. When they are made to eat turnips they soon fatten, but there is some difficulty in bringing this about. The old ones always refuse them at first, and will sometimes fast three or four days, till almost famished; but the young lambs fall to at once. The common way, in some places, of turning a flock of sheep at large into a field of turnips, is very disadvantageous, for they will thus destroy as many in a fortnight as would keep them a whole winter. There are three other ways of feeding them on this food, all of which have their several advantages.

The first way is to divide the land by hurdles, and allow the sheep to come upon such a portion only at a time as they can eat in one day, and so advance the hurdles farther into the ground daily till all be eaten. This is infinitely better than the former random method; but they never eat them clean even this way, but leave the bottoms and outsides scooped in the ground: the people pull up these indeed with iron crooks, and lay them before the sheep again, but they are commonly



ly so fouled with the creature's dung and urine, and with the dirt from their feet, that they do not care for them; they eat but little of them, and what they do eat does not nourish them like the fresh roots.

The second way is by inclosing the sheep in hurdles, as in the former; but in this they pull up all the turnips which they suppose the sheep can eat in one day, and daily remove the hurdles over the ground whence they have pulled up the turnips: by this means there is no waste, and less expence, for a person may in two hours pull up all those turnips; the remaining shells of which would have employed three or four labourers a-day to get up with their crooks out of the ground trodden hard by the feet of the sheep; and the work is, that as in the method of pulling up first, the turnips are eaten up clean; in this way, by the hook, they are wasted, the sheep do not eat any great part of them, and when the ground comes to be tilled afterwards for a crop of corn, the fragments of the turnips are seen in such quantities on the surface, that half the crop at least seems to have been wasted.

The third manner is to pull up the turnips, and remove them in a cart or waggon to some other place, spreading them on a fresh place every day; by this method the sheep will eat them up clean, both root and leaves. The great advantage of this method is, when there is a piece of land not far off which wants dung more than that where the turnips grew, which perhaps is also too wet for the sheep in winter, and then the turnips will, by the too great moisture and dirt of the soil, sometimes spoil the sheep, and give them the rot. Yet such ground will often bring forth more and larger turnips than dry land, and when they are carried off, and eaten by the sheep on ploughed land, in dry weather, and on green sward in wet weather, the sheep will succeed much better; and the moist soil where the turnips grew not being trodden by the sheep, will be much fitter for a crop of corn than if they had been fed with turnips on it. The expence of hurdles, and the trouble of moving them, are saved in this case, which will counterbalance at least the expence of pulling the turnips and carrying them to the places where they are to be eaten. They must always be carried off for oxen.

The diseases to which sheep are subject are these, rot, red-water, foot-rot and hoving, scab, dunt, rickets, fly-struck, flux, and bursting. Of each of these we shall give the best description in our power, with the most approved remedies.

The rot, which is a very pernicious disease, has of late engaged the attention of scientific farmers. But neither its nature nor its cause has yet been fully ascertained. Some valuable and judicious observations have, however, been made upon it, which ought to be circulated, as they may perhaps, in many cases, furnish an antidote for this malignant distemper, or be the means of leading others to some more efficacious remedy. Some have supposed the rot owing to the quick growth of grass or herbs that grow in wet places. Without pretending, that all-bounteous Providence has given to every animal its peculiar taste, by which it distinguishes the food proper for its preservation and support, if not vitiated by fortuitous circumstances, it seems very difficult to discover on philosophical principles why the quick growth of grass should render it noxious, or why any herb should at one season pro-

duce fatal effects, by the admission of pure water only into its component parts, which at other times is perfectly innocent, although brought to its utmost strength and maturity by the genial influence of the sun. Besides, the constant practice of most farmers in the kingdom, who with the greatest security feed their meadows in the spring, when the grass shoots quick and is full of juices, militates directly against this opinion.

Mr Arthur Young, to whom agriculture is much indebted, ascribes this disease to moisture. In confirmation of this opinion, which has been generally adopted, we are informed, in the Bath Society papers\*, by a cor-<sup>\* Vol. I. art. XLVI.</sup> respondent, that there was a paddock adjoining to his park which had for several years caused the rot in most of the sheep which were put into it. In 1769 he drained it, and from that time his sheep were free from this malady. But there are facts which render it doubtful that moisture is the sole cause. We are told, the dry limed land in Derbyshire will produce the rot as well as water meadows and stagnant marshes; and that in some wet grounds sheep sustain no injury for many weeks.

Without attempting to enumerate other hypotheses<sup>20</sup> which the ingenious have formed on this subject, we shall pursue a different method in order to discover the cause. On dissecting sheep that die of this disorder, a great number of insects called *flukes* (see *FASCIOLA*) are found in the liver. That these flukes are the cause of the rot, therefore, is evident; but to explain how they come into the liver is not so easy. It is probable that they are swallowed by the sheep along with their food while in the egg state. The eggs deposited in the tender germ are conveyed with the food into the stomach and intestines of the animals, whence they are received into the lacteal vessels, carried off in the chyle, and pass into the blood; nor do they meet with any obstruction until they arrive at the capillary vessels of the liver. Here, as the blood filtrates through the extreme branches, answering to those of the *vena porta* in the human body, the secreting vessels are too minute to admit the impregnated ova, which, adhering to the membrane, produce those animalcules that feed upon the liver and destroy the sheep. They much resemble the flat fish called plaice, are sometimes as large as a silver two-pence, and are found both in the liver and in the pipe (answering to that of the *vena cava*) which conveys the blood from the liver to the heart.

The common and most obvious objection to that opinion is, that this insect is never found but in the liver, or in some parts of the viscera, of sheep that are diseased more or less; and that they must therefore be bred there. But this objection will lose its force, when we consider that many insects undergo several changes, and exist under forms extremely different from each other. Some of them may therefore appear and be well known under one shape, and not known to be the same under a second or third. The fluke may be the last state of some aquatic animal which we at present very well know under one or other of its previous forms.

If this be admitted, it is easy to conceive that sheep may, on wet ground especially, take multitudes of these ova or eggs in with their food; and that the stomach and viscera of the sheep being a proper nidus for them, they of course hatch, and appearing in their fluke

Sheep.

or lull slate, feed on the liver of the animal, and occasion this disorder.

It is a singular fact, "that no ewe ever has the rot while she has a lamb by her side." The reason of this may be, that the impregnated ovum passes into the milk, and never arrives at the liver. The rot is fatal to sheep, hares, and rabbits, and sometimes to calves; but never infests animals of a larger size.

21  
And most  
approved  
cure.

Miller says that parsley is a good remedy for the rot in sheep. Perhaps a strong decoction of this plant, or the oil extracted from its seeds, might be of service. Salt is also a useful remedy. It seems to be an acknowledged fact that salt marshes never produce the rot. Salt indeed is pernicious to most insects. Common salt and water expel worms from the human body; and sea-weed, if laid in a garden, will drive away insects; but if the salt is separated by steeping it in the purest spring-water for a few days, it abounds with animalculæ of various species.

Little, in his book of husbandry, informs us of a farmer who cured his whole flock of the rot by giving each sheep a handful of Spanish salt for five or six mornings successively. The lint was probably taken from the Spaniards, who frequently give their sheep salt to keep them healthy. On some farms perhaps the utmost caution cannot always prevent this disorder. In wet and warm seasons the prudent farmer will remove his sheep from the lands liable to rot. Those who have it not in their power to do this may give each sheep a spoonful of common salt, with the same quantity of flour, in a quarter of a pint of water, once or twice a-week. When the rot is recently taken, the same remedy given four or five mornings successively will in all probability effect a cure. The addition of the flour and water (in the opinion of Mr Prie of Salisbury, to whose excellent paper in the Bath Society's Transactions we own ourselves much indebted) will not only abate the pungency of the salt, but dispose it to mix with the chyle in a more gentle and efficacious manner.

A farmer of a considerable lordship in Bohemia visiting the hot-wells of Carlsbad, related how he preferred his flocks of sheep from the mortal distemper which raged in the wet year 1769, of which so many perished. His preservative was very simple and very cheap: "He fed them every night, when turned under a shed, cover, or flables, with hashed fodder straw; and, by eating it greedily, they all escaped."

22  
Red-water.

"Red-water is a disorder most prevalent on wet grounds. I have heard (says Mr Arthur Young) that it has sometimes been cured by tapping, as for a drop-sy. This operation is done on one side of the belly towards the flank, just below the wool.

23  
Foot-rot.

"The foot-rot and hoving, which is very common on low fenny grounds, is cured by keeping the part clean, and lying at rest in a dry pasture."

24  
Scab.

The scab is a cutaneous disease owing to an impurity of the blood, and is most prevalent in wet lands or in rainy seasons. It is cured by tobacco-water, brim-

stone, and alum, boiled together, and then rubbed over the sheep. If only partial, tar and grease may be sufficient. But the simplest and most efficacious remedy for this disease was communicated to the Society for the Encouragement of Arts, &c. by Sir Joseph Banks.

"Take one pound of quicksilver, half a pound of Venice turpentine, half a pint of oil of turpentine, and four pounds of hogs lard (c). Let them be rubbed in a mortar till the quicksilver is thoroughly incorporated with the other ingredients; for the proper mode of doing which, it may be proper to take the advice, or even the assistance, of some apothecary or other person used to make such mixtures.

"The method of using the ointment is this: Beginning at the head of the sheep, and proceeding from between the ears along the back to the end of the tail, the wool is to be divided in a furrow till the skin can be touched; and as the furrow is made, the finger slightly dipped in the ointment is to be drawn along the bottom of it, where it will leave a blue stain on the skin and adjoining wool: from this furrow similar ones must be drawn down the shoulders and thighs to the legs, as far as they are woolly; and if the animal is much infected, two more should be drawn along each side parallel to that on the back, and one down each side between the fore and hind legs.

"Immediately after being dressed, it is usual to turn the sheep among other flock, without any fear of the infection being communicated; and there is scarcely an instance of a sheep suffering any injury from the application. In a few days the blotches dry up, the itching ceases, and the animal is completely cured: it is generally, however, thought proper not to delay the operation beyond Michaelmas.

"The *hippobosca ovina*, called in Lincolnshire *sheep fagg*, an animal well known to all shepherds, which lives among the wool, and is hurtful to the thriving of sheep both by the pain its bite occasions and the blood it sucks, is destroyed by this application, and the wool is not at all injured. Our wool-buyers purchase the fleeces on which the stain of the ointment is visible, rather in preference to others, from an opinion that the use of it having preserved the animal from being vexed either with the scab or faggs, the wool is less liable to the defects of joints or knots; a fault observed to proceed from every sudden stop in the thriving of the animal, either from want of food or from disease.

"This mode of curing was brought into that part of Lincolnshire where my property is situated about 12 years ago, by Mr Stephenson of Mareham, and is now so generally received, that the scab, which used to be the terror of the farmers, and which frequently deterred the more careful of them from taking the advantage of pasturing their sheep in the fertile and extensive commons with which that district abounds, is no longer regarded with any apprehension: by far the most of them have their flock anointed in autumn, when they return from the common, whether they show any symptoms of scab or not; and having done so, conclude them

(c) By some unaccountable mistake the last ingredient, the four pounds of hogs lard, is omitted in the receipt published in the Transactions of the Society; a circumstance that might be productive of bad effects.—The leaf which contained the receipt has since been cancelled, and a new one printed.

<sup>sheep.</sup> them safe for some time from either giving or receiving infection. There are people who employ themselves in the business, and contract to anoint our large sheep at five shillings a score, insuring for that price the success of the operation; that is, agreeing, in case many of the sheep break out afresh, to repeat the operation gratis even some months afterwards."

<sup>26</sup> The *dunt*, The *dunt* is a distemper caused by a bladder of water gathering in the head. No cure for this has yet been discovered.

<sup>27</sup> Rickets, The *rickets* is a hereditary disease for which no antidote is known. The first symptom is a kind of light-headedness, which makes the affected sheep appear wilder than usual when the shepherd or any person approaches him. He bounces up suddenly from his laze, and runs to a distance, as though he were pursued by dogs. In the second stage the principal symptom is the sheep's rubbing himself against trees, &c. with such fury as to pull off his wool and tear away his flesh. "The distressed animal has now a violent itching in his skin, the effect of an highly inflamed blood; but it does not appear that there is ever any cutaneous eruption or salutary critical discharge. In short, from all circumstances, the fever appears now to be at its height."—The last stage of this disease "seems only to be the progress of dissolution, after an unfavourable crisis. The poor animal, as condemned by Nature, appears stupid, walks irregularly (whence probably the name *rickets*), generally lies, and eats little: these symptoms increase in degree till death, which follows a general consumption, as appears upon dissection of the carcass; the juices and even solids having suffered a general dissolution."

In order to discover the seat and nature of this disease, sheep that die of it ought to be dissected. This is said to have been done by one gentleman, Mr Beal; and he found in the brain or membranes adjoining a maggot about a quarter of an inch long, and of a brownish colour. A few experiments might easily determine this fact.

<sup>28</sup> Fly-struck, The *fly-struck* is cured by clipping the wool off as far as infected, and rubbing the parts dry with lime or wood-ashes; turpentine oil will heal the wounds, and prevent their being struck any more; or they may be cured with care, without clipping, with oil of turpentine, which will kill all the vermin where it goes; but the former is the surest way.

<sup>29</sup> Flux, The *flux* is another disease to which sheep are subject. The best remedy is said to be, to house the sheep immediately when this distemper appears. To keep them very warm, and feed them on dry hay, giving them frequent glisters of warm milk and water. The cause of that distemper is either their feeding on wet lands, or on grass that is become mossy by the lands having been sed many years without being ploughed. When the farmer perceives his sheep-walks to become mossy, or to produce bad grass, he should either plough or manure with hot lime, making kilns either very near or in the sheep walks, because the hotter the lime is put on, the sweeter the grass comes up, and that early in the year.

<sup>30</sup> nd burst, *Burbling*, or as it is called in some places the *Ugfl*, attacks sheep when driven into fresh grass or young clover. They overeat themselves, foam at the mouth, swell exceedingly, breathe very quick and short, then jump up, and instantly fall down dead. In this case,

the only chance of saving their life is by stabbing them in the maw with an instrument made for the purpose. The instrument is a hollow tube, with a pointed weapon passing through it. A hole is made with the pointed weapon; which is immediately withdrawn, and the hole is kept open by inserting the tube till the wind is discharged.

sheep are infested with worms in their nose called *astrus oves*, and produced from the egg of a large two-winged fly. The frontal sinuses above the nose in sheep and other animals are the places where these worms live and attain their full growth. These sinuses are always full of a soft white matter, which furnishes these worms with a proper nourishment, and are sufficiently large for their habitation; and when they have here acquired their destined growth, in which they are fit to undergo their changes for the fly-state, they leave their old habitation, and, falling to the earth, bury themselves there; and when these are hatched into flies, the female, when she has been impregnated by the male, knows that the nose of a sheep or other animal is the only place for her to deposit her eggs, in order to their coming to maturity. Mr Vallinieri, to whom the world owes so many discoveries in the insect class, is the first who has given any true account of the origin of these worms. But though their true history had been till that time unknown, the creatures themselves were very early discovered, and many ages since were esteemed great medicines in epilepsies.

The fly produced from this worm has all the time of its life a very lazy disposition, and does not like to make any use either of its legs or wings. Its head and corselet together are about as long as its body, which is composed of five rings, streaked on the back; a pale yellow and brown are there disposed in irregular spots; the belly is of the same colours, but they are there more regularly disposed, for the brown here makes three lines, one in the middle, and one on each side, and all the intermediate spaces are yellow. The wings are nearly of the same length with the body, and are a little inclined in their position, so as to lie upon the body: they do not, however, cover it; but a naked space is left between them. The ailerons or petty wings which are found under each of the wings are of a whitish colour, and perfectly cover the balancers, so that they are not to be seen without lifting up these.

The fly will live two months after it is first produced, but will take no nourishment of any kind; and possibly it may be of the same nature with the butterflies, which never take any food during the whole time of their living in that state. Reaumur, Hist. Inf. vol. iv. p. 552, &c.

To find a proper composition for marking sheep is <sup>31</sup> a matter of great importance, as great quantities of wool from are every year rendered useless by the pitch and tar with which they are usually marked. The requisite qualities for such a composition are, that it be cheap, that the colour be strong and lasting, so as to bear the changes of weather, and not to injure the wool. Dr Lewis recommends for this purpose melted tallow, with so much charcoal in fine powder stirred into it as is sufficient to make it of a full black colour, and of a thick consistence. This mixture, being applied warm with a marking iron, on pieces of flannel, quickly fixed or hardened, bore moderate rubbing, resisted the sun and rain, and

<sup>sheep.</sup> <sup>31</sup> Account of the rose-worms which infest sheep.

Sheep  
||  
Sheffield.

and yet could be washed out freely with soap, or ley, or slide urine. In order to render it still more durable, and prevent its being rubbed off, with the tallow may be melted an eighth, sixth, or fourth, of its weight of tar, which will readily wash out along with it from the wool. Lewis's Com. Phil. Techn. p. 361.

*SHEEP-Stealing.* See THEFT.

**SHEERING**, in the sea-language. When a ship is not steered steadily, they say the sheers, or goes sheering; or when, at anchor, she goes in and out by means of the current of the tide, they also say she sheers.

**SHEERNESS**, a fort in Kent, seated on the point where the river Medway falls into the Thames. It was built by king Charles II. after the insult of the Dutch, who burnt the men of war at Chatham. The buildings belonging to it, in which the officers lodge, make a pretty little neat town; and there is also a yard and a dock, a chapel and a chaplain. Mr Lyons, who sailed with the Honourable Captain Phipps in his voyage towards the pole, fixed the longitude of Sheerness to o. 48'. E. its latitude 51° 25'.

**SHEERS**, a name given to an engine used to hoist or displace the lower masts of a ship. The sheers employed for this purpose in the royal navy are composed of several long masts, whose heels rest upon the side of the hull, and having their heads declining outward from the perpendicular, so as to hang over the vessel whose masts are to be fixed or displaced. The tackles, which extend from the head of the mast to the sheer-heads, are intended to pull in the latter toward the mast-head, particularly when they are charged with the weight of a mast after it is raised out of any ship, which is performed by strong tackles depending from the sheer-heads. The effort of these tackles is produced by two capsterns; fixed on the deck for this purpose.

In merchant ships this machine is composed of two masts or props, erected in the same vessel wherein the mast is to be planted, or from whence it is to be removed. The lower ends of these props rest on the opposite sides of the deck, and their upper parts are fastened across, so as that a tackle which hangs from the intersection may be almost perpendicularly above the station of the mast to which the mechanical powers are applied. These sheers are secured by stays, which extend forward and aft to the opposite extremities of the vessel.

**SHEET-LEAD.** See PLUMBERY.

**SHEET**, in sea-language, a rope fastened to one or both the lower corners of a sail, to extend and retain it in a particular station. When a ship sails with a lateral wind, the lower corner of the main and fore sail are fastened by a tack and a sheet; the former being to windward, and the latter to leeward; the tack, however, is entirely diffused with a stern wind, whereas the sail is never spread without the assistance of one or both of the sheets. The stay-sails and fludding-sails have only one tack and one sheet each: the stay-sail tacks are always fastened forward, and the sheet drawn aft; but the fludding-sail tack draws the under clue of the sail to the extremity of the boom, whereas the sheet is employed to extend the in-mast.

**SHEFFIELD**, a town in the west riding of Yorkshire, about 162 miles from London, is a large, thriving, populous town on the borders of Derbyshire; has a fine stone bridge over the Don, and another over the Sheaf, and a church built in the reign of Henry I.

It had a castle built in the reign of Henry III. in Sheffield which, or else in the manor-house of the Park, Mary Queen of Scots was prisoner 16 or 17 years; but after the death of Charles I. it was, with several others, by order of parliament demolished. In 1673 an hospital was erected here, and endowed with 200l. a-year. There is a charity-school for 30 boys, and another for 30 girls. This town has been noted several hundred years for cutlers and smiths manufactures, which were encouraged and advanced by the neighbouring mines of iron, particularly for files and knives, or whittles; for the last of which especially it has been a staple for above 300 years; and it is reputed to excel Birmingham in these wares, as much as it is surpassed by it in locks, hinges, nails, and polished steel. The first mills in England for turning grindstones were also set up here. The houses look black from the continual smoke of the forges. Here are 600 master cutlers, incorporated by the style of the *Cutlers of Hallamshire* (of which this is reckoned the chief town), who employ not less than 40,000 persons in the iron manufactures; and each of the masters gives a particular stamp to his wares. There is a large market on Tuesday for many commodities, but especially for corn, which is bought up here for the whole West Riding, Derbyshire, and Nottinghamshire. It has fairs on Tuesday after Trinity-Sunday, and November 28. In the new market-place, erected by the Duke of Norfolk, the shambles are built upon a most excellent plan, and strongly inclosed. There are several other new good buildings, such as a large and elegant octagon chapel belonging to the hospital or almshouses; likewise a good assembly-room and theatre. We must not omit the large steam-engine, lately finished, for the purpose of polishing and grinding the various sorts of hardware. The parish being very large, as well as populous, Mary I. incorporated 12 of the chief inhabitants, and their successors for ever, by the style of the *Twelve Capital Burgesses of Sheffield*, empowering them to elect and ordain three priests to assist the vicar, who were to be paid out of certain lands and rents which she gave out of the crown; and since this settlement two more chapels have been built in two hamlets of this parish, which are served by two of the assistants, while the third, in his turn, helps the vicar in his parish church. James I. founded a free grammar-school here, and appointed 13 school burgesses to manage the revenue, and appoint the master and usher. A new chapel was built lately by the contributions of the people of the town and of the neighbouring nobility and gentry. Water is conveyed by pipes into Sheffield, whose inhabitants pay but a moderate rent for it. In the neighbourhood there are some mines of alum. The remains of the Roman fortification between this town and Rotheram, which is six miles lower down the river, are still visible; and here is also the famous trench of five miles long, by some called *Devil's* or *Dane's Bank*, and by others *Kemp Bank* and *Temple's Bank*. W. Long. i. 29. N. Lat. 53. 20.

**SHEFFIELD** (John), duke of Buckinghamshire, an eminent writer of the last and present century, of great personal bravery, and an able minister of state, was born about 1650. He lost his father at nine years of age; and his mother marrying lord Ossulston, the care of his education was left entirely to a governor, who did not greatly improve him in his studies. Finding that he was deficient in many parts

field, of literature, he resolv'd to devote a certain number of hours every day to his studies; and thereby improv'd himself to the degree of learning he afterwards attained. Though possess'd of a good estate, he did not abandon himself to pleasure and indolence, but enter'd a volunteer in the second Dutch war; and accordingly was in that famous naval engagement where the duke of York commanded as admiral: on which occasion his lordship behaved so gallantly, that he was appointed commander of the Royal Catharine. He afterward made a campaign in the French service under M. de Turenne. As Tangier was in danger of being taken by the Moors, he offer'd to head the forces which were sent to defend it; and accordingly was appointed to command them. He was then earl of Mulgrave, and one of the lords of the bed-chamber to king Charles II. The Moors retir'd on the approach of his majesty's forces; and the result of the expedition was the blowing up of Tangier. He continu'd in several great posts during the short reign of king James II. till that unfortunate prince was dethroned. Lord Mulgrave, though he paid his respects to king William before he was advanced to the throne, yet did not accept of any post in the government till some years after. In the sixth year of William and Mary he was created marquis of Normanby in the county of Lincoln. He was one of the most active and zealous opposers of the bill which took away Sir John Fenwick's life; and exerted the utmost vigour in carrying through the Treason Bill, and the bill for Triennial Parliaments. He enjoy'd some considerable posts under king William, and enjoy'd much of his favour and confidence. In 1702 he was sworn lord privy-seal; and in the same year was appointed one of the commissioners to treat of an union between England and Scotland. In 1703 he was created duke of Normanby, and soon after duke of Buckinghamshire. In 1711 he was made steward of her majesty's household, and president of the council. During queen Anne's reign he was but once out of employment; and then he voluntarily resign'd, being attach'd to what were call'd the *Tory principles*. Her majesty offer'd to make him lord-chancellor: but he declined the office. He was instrumental in the change of the ministry in 1710. A circumstance that reflects the highest honour on him is, the vigour with which he acted in favour of the unhappy Catalans, who afterward were so inhumanly sacrific'd. He was surviv'd by only one legitimate son (who died at Rome in 1735); but left several natural children. His worst enemies allow that he liv'd on very good terms with his last wife, natural daughter to king James II. the late duchess of Buckingham, a lady who always behav'd with a dignity suitable to the daughter of a king. He died in 1721. He was admir'd by the poets of his age; by Dryden, Prior, and Garth. His Essay on Poetry was applauded by Addison, and his Rehearsal is still read with pleasure. His writings were splendidly printed in 1723, in two volumes 4to; and have since been reprinted in 1729, in two vols 8vo. The first contains his poems on various subjects: the second, his prose works; which consist of historical memoirs, speeches in parliament, characters, dialogues, critical observations, essays, and letters. It may be proper to observe, that the edition of 1729 is castrated; some particulars relating to the revolution in that of 1723 having given offence.

**SHEFFIELDIA**, in botany; a genus of plants

belonging to the class of pentandria, and to the order of monogynia. The corolla is bell-shaped; the filaments are 10, of which every second is barren. The capsule consists of one cell, which has four valves. There is only one species, the *repens*.

**SHEIK**, in the oriental customs, the person who has the care of the mosques in Egypt; his duty is the same as that of the imams at Constantinople. There are more or fewer of these to every mosque, according to its size or revenue. One of these is head over the rest, and answers to a parish-priest with us; and has under him, in large mosques, the readers, and people who cry out to go to prayers; but in small mosques the sheik is oblig'd to do all this himself. In such it is their business to open the mosque, to cry to prayers, and to begin their short devotions at the head of the congregation, who stand rank and file in great order, and make all their motions together. Every Friday the sheik makes an harangue to his congregation.

**SHEIK-BELLET**, the name of an officer in the Oriental nations. In Egypt the sheik-bellet is the head of a city, and is appointed by the pacha. The business of this officer is to take care that no innovations be made which may be prejudicial to the Porte, and that they send no orders which may hurt the liberties of the people. But all his authority depends on his credit and interest, not his office: for the government of Egypt is of such a kind, that often the people of the least power by their posts have the greatest influence; and a caia of the janizaries or Arabs, and sometimes one of their meanest officers, an oda-basha, finds means, by his parts and abilities, to govern all things.

**SHEILDS**. See **SHIELDS**.

**SHEKEL**, the name of a weight and coin current among the ancient Jews. Dr Arbuthnot makes the weight of the shekel equal to 9 pennyweights  $2\frac{1}{2}$  grains Troy weight; and the value equal to 2s.  $3\frac{1}{2}$ d. Sterling. The golden shekel was worth L 1 : 16 : 6.

**SHELDRAKE**, in ornithology. See **ANAS**.

**SHELL**, among miners, the same with what they otherwise call *soil ground* or *soil country*; being that part of the internal structure of the earth which they find lying even and in an orderly manner, and evidently retaining its primitive form and situation.

**SHELL**, in natural history, a hard, and, as it were, stony covering, with which certain animals are defend'd, and thence call'd *shell-fish*.

The singular regularity, beauty, and delicacy in the structure of the shells of animals, and the variety and brilliancy in the colouring of many of them, at the same time that they strike the attention of the most in-curious observers, have at all times excited philosophers to inquire into and detect, if possible, the causes and manner of their formation. But the attempts of naturalists, ancient and modern, to discover this process, have constantly prov'd unsuccessful. M. de Reaumur hitherto appears alone to have given a plausible account, at least, of the formation of the shell of the garden-snail in particular, founded on a course of very ingenious experiments, related in the Paris Memoirs\*. He there endeavours to show, that this substance is produced merely by the perspirable matter of the animal condensing and afterwards hardening on its surface, and accordingly taking the figure of its body, which has perform'd the office of a mould to it; in short, that the shell of a snail, and, as he suppos'd, of all other animals pos-  
See Mem. de l'Acad. des Sciences, 1709. p. 473. Edit. de Haller, in 1710.

Sheik

||

Shell

Formation  
of shells..

Shell, fessed of shells, was only the product of a viscous transudation from the body of the animal, containing earthy particles united by mere juxtaposition. This hypothesis, however, is liable to very great and insurmountable difficulties, if we apply it to the formation of some of the most common shells: for how, according to this system, it may be asked, can the oyster, for instance, considered simply as a mould, form to itself a covering so much exceeding its own body in dimensions?

1  
Are composed of an earthy and an animal substance.

M. Herissant, in the Memoirs of the Academy of Sciences for 1766, has discovered the structure of shells to be organical. In the numerous experiments that he made on an immense number, and a very great variety, of animal shells, he constantly found that they were composed of two distinct substances; one of which is a cretaceous or earthy matter; and the other appeared, from many experiments made upon it by burning, distillation, and otherwise, to be evidently of an animal nature. These two substances he dexterously separated from each other by a very easy chemical analysis; by the gentle operation of which they were exhibited distinctly to view, without any material alteration from the action of the solvent, or instrument employed for that purpose. On an entire shell or a fragment of one, contained in a glass vessel, he poured a sufficient quantity of the nitrous acid, considerably diluted either with water or spirit of wine. After the liquor has dissolved all the earthy part of the shell (which may be collected after precipitation by a fixed or volatile alkali), there remains floating in it a soft substance, consisting of innumerable membranes of a retiform appearance, and disposed, in different shells, in a variety of positions, which constitutes the animal-part of it. This, as it has not been affected by the solvent, retains the exact figure of the shell; and, on being viewed through a microscope, exhibits satisfactory proofs of a vascular and organical structure. He shows that this membranous substance is an appendix to the body of the animal, or a continuation of the tenacious fibres that compose the ligaments by which it is fixed to its shell; and that this last owes its hardness to the earthy particles conveyed through the vessels of the animal, which fix themselves into, and incrust, as it were, the meshes formed by the reticular filaments of which this membranous substance is composed. In the shell called *porcelaine*, in particular, the delicacy of these membranes was so great, that he was obliged to put it into spirit of wine, to which he had the patience to add a single drop of spirit of nitre day by day, for the space of two months; lest the air generated, or let loose by the action of the acid on the earthy substance, should tear the compasses of its fine membranous structure into shatters; as it certainly would have done in a more hasty and less gentle dissolution. The delicate reticulated film, left after this operation, had all the tenuity of a spider's web; and accordingly he does not attempt to delineate its organization. In other shells he employed even five or six months in demonstrating the complicated membranous structure of this animal-substance by this kind of chemical anatomy. In general, however, the process does not require much time.

3  
Their membranous structure produces great variety of colours.

Of the many singular configurations and appearances of the membranous part of different shells, which are described in this memoir, and are delineated in several well executed plates, we shall mention only, as a spe-

cimen, the curious membranous structure observed in the laminae of mother-of-pearl, and other shells of the same kind, after having been exposed to the operation of the author's solvent. Beside the great variety of fixed or permanent colours with which he found the animal-filaments of these shells to be adorned, it is known, that the shell itself presents to the view a succession of rich and changeable colours, the production of which he easily explains from the configurations of their membranes. Nature, he observes, always magnificent in her designs, but singularly frugal in the execution of them, produces these brilliant decorations at a very small expence. The membranous substance above-mentioned is plaited and ruffled, as it were, in such a manner, that its exterior laminae, incrustated with their earthy and semi-transparent matter, form an infinite number of little prisms, placed in all kinds of directions, which refract the rays of light, and produce all the changes of colour observable in these shells.

With respect to the figures and colours of shells, it is observed, that river shells have not so agreeable or diversified a colour as the land and sea shells; but the variety in the figure, colours, and other characters of sea shells, is almost infinite. The number of distinct species we find in the cabinets of the curious is very great; and doubtless the deep bottoms of the sea, and the shores yet unexplored contain multitudes still unknown to us. Even the same species differ in some degree in almost every individual; so that it is rare to find any two shells which are alike in all respects.

This wonderful variety, however, is not all the produce of one sea or one country; the different parts of the world afford us their different beauties. Bonani observes, that the most beautiful shells we are acquainted with come from the East Indies and from the Red sea. This is in some degree countenanced by what is found to this day; and from the general observations of the curious, it seems, that the sun, by the great heat that it gives to the countries near the line, exalts the colours of the shells produced there, and gives them a lustre and brilliancy that those of colder climates always want: and it may be, that the waters of those vast seas, which are not subject to be weakened by fresh rivers, give a nourishment to the fish, that may add to the brilliancy of their shells.

The shores of Asia furnish us with the pearl-oysters and scallops in great perfection. About Amboyna are found the most beautiful specimens of the cabbage-shell, the arrosor, the ducal mantle, and the coral oysters, or echinated oysters. Here also are found a great variety of extremely beautiful muscels, tellinæ, and volutæ; some fine buccinums, and the shell called the *Ethiopian crown*, in its greatest perfection. The dolia, the murices, and the cassandras, are also found on these coasts in great beauty. Many elegant snails and screw-shells are also brought from thence; and finally, the serapion and spider-shells. The Maldive and Phillipine islands, Bengal, and the coast of Malabar, abound with the most elegant of all the species of snails, and furnish many other kinds of shells in great abundance and perfection. China abounds in the finest species of porcelain shells, and has also a great variety of beautiful snails. Japan furnishes us with all the thicker and larger bivalves; and the isle of Cyprus is famous above all other parts of the world for the beauty and variety of the patella or limpet found there.

America

6  
Amc.

America affords many very elegant shells, but neither in so great abundance nor beauty as the shores of Asia. Panama is famous for the cylinders or rhombi, and we have beside, from the same place, some good porcelains, and a very fine species of *dolium*, or *concha globosa*, called from this place the *Panama purple shell*. One of the most beautiful of the cylinders is also known among our naturalists under the name of the *Panama shell*. About Brasil, and in the gulf of Mexico, there are found murices and dolia of extreme beauty; and also a great variety of porcelains, purpuræ, pectens, neritæ, bucardiæ or heart-shells, and elegant limpets. The isle of Cayenne affords one of the most beautiful of the buccinum kind, and the Midas ear is found principally about this place. Jamaica and the island of Barbadoes have their shores covered with porcelains, chamæ, and buccina; and at St Domingo there are found almost all the same species of shells that we have from the East Indies; only they are less beautiful, and the colours more pale and dead. The pearl-oyster is found also on this coast, but smaller than in the Persian gulf. At Martinico there are found in general the same shells as at St Domingo, but yet less beautiful. About Canada are found the violet chamæ, and the lakes of that country abound with muscles of a very elegant pale blue and pale red colours. Some species of these are remarkably light and thin; others are very thick and heavy. The Great Bank of Newfoundland is very barren in shells: the principal kind found there are muscles of several species, some of which are of considerable beauty. About Carthage there are many mother-of-pearl shells, but they are not of so brilliant colours as those of the Persian gulf. The island of Magellan, at the southern point of America, furnishes us with a very remarkable species of muscle called by its name; and several very elegant species of limpets are found there, particularly the pyramidal.

7  
Africa.

In Africa, on the coast of Guinea, there is a prodigious quantity of that small species of porcelain which is used there as money; and there is another species of porcelain on the same coast which is all over white: the women make bracelets of these, and the people of the Levant adorn their hair with them. The coast of Zanguebar is very rich in shells: we find there a vast variety of the large porcelains, many of them of great beauty; and the *nux maris* or sea-nut is very frequent there. Beside these, and many other shells, there are found on this coast all the species of nautili, many of which are very beautiful. The Canary isles abound with a vast variety of the murices, and some other good shells; and we have from Madeira great variety of the echini or sea-eggs different from those of the European seas. Several species of muscles are also common there, and the *aurea marina* is nowhere more abundant. The Red sea is beyond all other parts of the world abundant in shells, scarce any kind is wanting there; but what we principally have from thence are the purpuræ, porcelains, and echini marini.

s  
nd. of  
Medi-  
tanean  
the  
A. Jur.  
ndig.

The Mediterranean and Northern ocean contain a great variety of shells, and many of very remarkable elegance and beauty; they are upon the whole, however, greatly inferior to those of the East Indies. The Mediterranean abounds much more in shells than the Ocean. The gulf of Tarentum affords great variety of purpuræ, of porcelains, nautili, and elegant oysters; the coasts of Naples and Sardinia afford also the same, and

with them a vast number of the solens of all the known species. The island of Sicily is famous for a very elegant kind of oyster which is white all over; pinnæ marinæ and porcelains are also found in great plenty there, with tellinæ and chamæ of many species, and a great variety of other beautiful shells. Corsica is famous, beyond all other places, for vast quantities of the pinnæ marinæ; and many other very beautiful shells are found there. (Lister, Hist. Conchyl.) About Syracuse are found the gondola shell, the alated murex, and a great variety of elegant snails, with some of the dolia and neritæ. The Adriatic sea, or gulf of Venice, is less furnished with shells than almost any of the seas thereabout. Muscles and oysters of several species are however found there, and some of the cordiform or heart-shells; there are also some tellinæ. About Ancona there are found vast numbers of the pholades buried in stone; and the *aurea marina* are particularly frequent about Puzzoli. (*Bonani, Recreat. Ment. et Ocul.*)

9  
On the  
coast of  
France,

The ports of Marseilles, Toulon, and Antibes, are full of pinnæ marinæ, muscles, tellinæ, and chamæ. The coasts of Bretagne afford great numbers of the *conchæ anatifera* and *poussépieds*; they are found on old rotten boards, on sea substances, and among clusters of sponges. The other ports of France, as Rochelle, Dunkirk, Brest, St Maloes, and others, furnish oysters excellent for the table, but of the common kind, and of no beauty in their shells; great numbers of muscles are also found there; and the common tellinæ, the onion-peel oysters, the solens, and *conchæ anatifera*, are also frequent there. At Granville, in Lower Normandy, there are found very beautiful pectens, and some of the cordiform or heart-shells.

10  
Of Britain,

Our own English coasts are not the least fruitful in shells, tho' they do not produce such elegantly painted ones as the Indies. About Plymouth are found oysters, muscles, and solens, in great abundance; and there, and on most of our other shores, are numbers of the *aurea marina* and dentalia, with pectens, which are excellent food; and many elegant species of the chamæ and tellinæ are fished up in the sea about Scarborough and other places. Ireland affords us great numbers of muscles, and some very elegant scallop-shells in great abundance, and the pholades are frequent on most of our shores. We have also great variety of the buccina and cochleæ, some volutæ; and, on the Guernsey coast, a peculiarly beautiful snail, called thence the *Guernsey snail*.

11  
Of Spain  
and Portu-  
gal, &c.

The coasts of Spain and Portugal afford much the same species of shells with the East Indies, but they are of much fainter colours, and greatly inferior in beauty. There are, according to Tavernier and others, some rivers in Bavaria in which there are found pearls of a fine water. About Cadiz there are found very large pinnæ marinæ, and some fine buccina. The isles of Majorca and Minorca afford a great variety of extremely elegant shells. The pinnæ marinæ are also very numerous there, and their silk is wrought into gloves, stockings, and other things. The Baltic affords a great many beautiful species, but particularly an orange-coloured pecten, or scallop-shell, which is not found in any other part of the world.

12  
Fresh wa-  
ter shells.

The fresh water shells are found much more frequently, and in much greater plenty than the sea kinds; there is scarce a pond, a ditch, or a river of fresh water in any part of the world in which there

Shells.

are not found vast numbers of these shells with the fish living in them. All these shells are small, and they are of very little beauty, being usually of a plain greyish or brownish colour. Our ditches afford us *chama*, *buccina*, *neritæ*, and some *patellæ*; but the Nile, and some other rivers, furnished the ancients with a species of *tellina* which was large and eatable, and so much superior to the common sea *tellina* in flavour, that it is commonly known by the name of *tellina regia*, "the royal *tellina*." We have a small species of *buccinum* common in our fresh waters, which is very elegant, and always has its operculum in the manner of the larger *buccina*; a small kind of muscle is also very common, which is so extremely thin and tender, that it can hardly be handled without breaking to pieces. The large fresh water muscle, commonly called in England the *barf-muscle*, is too well known to need a description; and the size sufficiently distinguishes it from all other fresh water shells.

In collecting shells, it is most advisable, whenever it can be done, to get those which have in them the living animals; because we shall thus obtain the natural history of the animals, and the shells themselves in their natural beauty, and the full glow of their colours. Shells should be also procured from the deeper parts of their resorts, and immediately after storms on the sea beaches and shores; because, by being much exposed to the sun, their colours fade, and they are liable to other accidents that injure them. In order to kill the fish that inhabits them, Mr Da Costa advises to give them a quick dip in boiling water, and when they are cooled, to lay them in cold water till they are cleaned; and in this operation they should not be touched with aquafortis, or any other acid, nor exposed to the heat of the fire and sun.

13  
Art of polishing shells.

The art of polishing shells arrived but lately at its present state of perfection; and as the love of sea-shells is become so common among us, it may not be disagreeable to the reader to find some instructions in executing so pleasing a method of adding to their natural beauty, the rules for which are at present so little known, though the effect of them be so much esteemed.

Among the immense variety of shells which we are acquainted with, some are taken up out of the sea, or found on its shores in all their perfection and beauty; their colours being all spread by nature upon the surface, and their natural polish superior to any thing that art could give. Where nature is in herself thus perfect, it were madness to attempt to add any thing to her charms: but in others, where the beauties are latent and covered with a coarser outer skin, art is to be called in; and the outer veil being taken off, all the internal beauties appear.

Among the shells which are found naturally polished are the porcelains, or cowries; the cassanders; the *dolia*, or *conchæ globosæ*, or tuns; some *buccina*, the *volute*, and the *cylianders*, or *olives*, or, as they are generally though improperly called, the *rhombi*; excepting only two or three, as the *tiara*, the *plumb*, and the *butter-tub rhombus*, where there is an unpromising film on the surface, hiding a very great share of beauty within. Though the generality of the shells of these genera are taken out of the sea in all their beauty, and in their utmost natural polish, there are several other genera, in which all or most of the species are taken up naturally rough and foul, and covered with an epidermis, or coarse

outer skin, which is in many rough and downy or hairy. The *tellinæ*, the *muscles*, the *cochleæ*, and many others, are of this kind. The more nice collectors, as naturalists; insist upon having all their shells in their native and genuine appearance, as they are found when living at sea; but the ladies, who make collections, hate the disagreeable outides, and will have all such polished. It would be very advisable, however, for both kinds of collectors to have the same shells in different specimens both rough and polished: the naturalist would by this means, besides knowing the outside of the shell, be better acquainted with its internal characters than he otherwise could be, and the lady would have a pleasure in comparing the beauties of the shell, in its wrought state, to its coarse appearance as nature gives it. How many elegancies in this part of the creation must be wholly lost to us, if it were not for the assistance of an art of this kind! Many shells in their native state are like rough diamonds; and we can form no just idea of their beauties till they have been polished and wrought into form.

Though the art of polishing shells is a very valuable one, yet it is very dangerous to the shells; for without the utmost care, the means used to polish and beautify a shell often wholly destroy it. When a shell is to be polished, the first thing to be examined is whether it have naturally a smooth surface, or be covered with tubercles or prominences.

A shell which has a smooth surface, and a natural dull polish, need only be rubbed with the hand, or with a piece of chamoy leather, with some tripoli, or fine rotten stone, and will become of a perfectly bright and fine polish. Emery is not to be used on this occasion, because it wears away too much of the shell. This operation requires the hand of an experienced person, that knows how superficial the work must be, and where he is to stop; for in many of these shells the lines are only on the surface, and the wearing away ever so little of the shell defaces them. A shell that is rough, foul, and crusty, or covered with a tartareous coat, must be left a whole day sleeping in hot water: when it has imbibed a large quantity of this, it is to be rubbed with rough emery on a stick, or with the blade of a knife, in order to get off the coat. After this, it may be dipped in diluted aquafortis, spirit of salt, or any other acid; and after remaining a few moments in it, be again plunged into common water. This will add greatly to the speed of the work. After this it is to be well rubbed with lincn cloths, impregnated with common soap; and when by these several means it is made perfectly clean, the polishing is to be finished with fine emery and a hair-brush. If after this the shell when dry appears not to have so good a polish as was desired, it must be rubbed over with a solution of gum arabic; and this will add greatly to its gloss, without doing it the smallest injury. The gum-water must not be too thick, and then it gives no sensible coat, only heightening the colours. The white of an egg answers this purpose also very well; but it is subject to turn yellow. If the shell has an epidermis, which will by no means admit the polishing of it, it is to be dipped several times in diluted aquafortis, that this may be eaten off; and then the shell is to be polished in the usual way with putty, fine emery, or tripoli, on the hair of a fine brush. When it is only a pellicle that hides the colours, the shells must be steeped in hot water, and after that the

Shell.



skin worked off by degrees with an old file. This is the case with several of the cylinders, which have not the natural polish of the rest.

When a shell is covered with a thick and fatty epidermis, as is the case with several of the muscles and tellinæ; in this case aquafortis will do no service, as it will not touch the skin: then a rough brush and coarse emery are to be used; and if this does not succeed, seal-skin, or, as the workmen call it, *fish-skin* and *pumice-stone*, are to be employed.

When a shell has a thick crust, which will not give way to any of these means, the only way left is to plunge it several times into strong aquafortis, till the stubborn crust is wholly eroded. The limpets, *auris marina*, the helmet-shells, and several other species of this kind, must have this sort of management; but as the design is to show the hidden beauties under the crust, and not to destroy the natural beauty and polish of the inside of the shell, the aquafortis must be used in this manner: A long piece of wax must be provided, and one end of it made perfectly to cover the whole mouth of the shell; the other end will then serve as a handle, and the mouth being stopped by the wax, the liquor cannot get in to the inside to spoil it; then there must be placed on a table a vessel full of aquafortis, and another full of common water.

The shell is to be plunged into the aquafortis; and after remaining a few minutes in it, is to be taken out, and plunged into the common water. The progress the aquafortis makes in eroding the surface is thus to be carefully observed every time it is taken out: the point of the shell, and any other tender parts, are to be covered with wax, to prevent the aquafortis from eating them away; and if there be any worm-holes, they also must be stopped up with wax, otherwise the aquafortis would soon eat through in those places. When the repeated dippings into the aquafortis show that the coat is sufficiently eaten away, then the shell is to be wrought carefully with fine emery and a brush; and when it is polished as high as can be by this means, it must be wiped clean, and rubbed over with gum-water or the white of an egg. In this sort of work the operator must always have the caution to wear gloves; otherwise the least touch of the aquafortis will burn the fingers, and turn them yellow; and often, if it be not regarded, will eat off the skin and the nails.

These are the methods to be used with shells which require but a moderate quantity of the surface to be taken off; but there are others which require to have a larger quantity taken off, and to be uncovered deeper: this is called entirely scaling a shell. This is done by means of a horizontal wheel of lead or tin, impregnated with rough emery; and the shell is wrought down in the same manner in which stones are wrought by the lapidary. Nothing is more difficult, however, than the performing this work with nicety: very often shells are cut down too far by it, and wholly spoiled; and to avoid this, a coarse vein must be often left standing in some place, and taken down afterwards with the file, when the cutting it down at the wheel would have spoiled the adjacent parts.

After the shell is thus cut down to a proper degree, it is to be polished with fine emery, tripoli, or rotten stone, with a wooden wheel turned by the same machine

as the leaden one, or by the common method of working with the hand with the same ingredients. When a shell is full of tubercles, or protuberances, which must be preserved, it is then impossible to use the wheel: and if the common way of dipping into aquafortis be attempted, the tubercles being harder than the rest of the shell, will be eat through before the rest is sufficiently scaled, and the shell will be spoiled. In this case, industry and patience are the only means of effecting a polish. A camel's-hair pencil must be dipped in aquafortis; and with this the intermediate parts of the shell must be wetted, leaving the protuberances dry: this is to be often repeated; and after a few moments the shell is always to be plunged into water to stop the erosion of the acid, which would otherwise eat too deep, and destroy the beauty of the shell. When this has sufficiently taken off the foulness of the shell, it is to be polished with emery of the finest kind, or with tripoli, by means of a small stick, or the common polishing-stone used by the goldsmiths may be used.

This is a very tedious and troublesome thing, especially when the echinated oysters and murices, and some other such shells, are to be wrought: and what is worst of all is, that when all this labour has been employed, the business is not well done; for there still remain several places which could not be reached by any instrument, so that the shell must necessarily be rubbed over with gum-water or the white of an egg afterwards, in order to bring out the colours and give a gloss; in some cases it is even necessary to give a coat of varnish.

These are the means used by artists to brighten the colours and add to the beauty of shells; and the changes produced by polishing in this manner are so great, that the shell can scarcely be known afterwards to be the same it was; and hence we hear of new shells in the cabinets of collectors, which have no real existence as separate species, but are shells well known, disguised by polishing. To caution the reader against errors of this kind, it may be proper to add the most remarkable species thus usually altered.

The onyx-shell or volute, called by us the *purple* or *violet-tip*, which in its natural state is of a simple pale brown, when it is wrought slightly, or polished with just the superficies taken off, is of a fine bright yellow; and when it is eaten away deeper, it appears of a fine milk-white, with the lower part bluish: it is in this state that it is called the *onyx-shell*; and it is preserved in many cabinets in its rough state, and in its yellow appearance, as different species of shells.

The *violet shells*, so common among the curious, is a species of porcelain, or common cowry, which does not appear in that elegance till it has been polished; and the common *auris marina* shows itself in two or three different forms, as it is more or less deeply wrought. In its rough state it is dusky and coarse, of a pale brown on the outside, and pearly within; when it is eaten down a little way below the surface, it shows variegations of black and green; and when still farther eroded, it appears of a fine pearly hue within and without.

The *nautilus*, when it is polished down, appears all over of a fine pearly colour; but when it is eaten away but to a small depth, it appears of a nice yellowish colour with dusky hairs. The *burgau*, when entirely cleared of its coat, is of the most beautiful pearl colour;

14  
Some shells are so much disguised by polishing as not to be known, such as

15  
The onyx-shell.

16  
Violet shells.

17  
Nautilus.

Shells

four; but when but slightly eroded, it appears of a variegated mixture of green and red; whence it has been called the *parrot shell*. The common helmet-shell, when wrought, is of the colour of the finest agate; and the muscles, in general, though very plain shells in their common appearance, become very beautiful when polished, and show large veins of the most elegant colours. The Persian shell, in its natural state, is all over white, and covered with tubercles; but when it has been ground down on a wheel, and polished, it appears of a grey colour, with spots and veins of a very bright and highly polished white. The limpets, in general, become very different when polished, most of them showing very elegant colours; among these the tortoise-shell limpet is the principal; it does not appear at all of that colour or transparency till it has been wrought.

18  
Jas. Guil-  
chama

That elegant species of shell called the *junquil-chama*, which has deceived so many judges of these things into an opinion of its being a new species, is only a white chama with a reticulated surface; but when this is polished, it loses at once its reticular work and its colour, and becomes perfectly smooth, and of a fine bright yellow. The violet-coloured chama of New England, when worked down and polished, is of a fine milk-white, with a great number of blue veins, disposed like the variegations in agates.

19  
The aff-  
car shell.

The *aff-car shell*, when polished after working it down with the file, becomes extremely glossy, and obtains a fine rose-colour all about the mouth. These are some of the most frequent among an endless variety of changes wrought on shells by polishing; and we find there are many of the very greatest beauties of this part of the creation which must have been lost but for this method of searching deep in the substance of the shell for them.

20  
Dutch me-  
thod of po-  
lishing  
shells.

The Dutch are very fond of shells, and are very nice in their manner of working them: they are under no restraint, however, in their works; but use the most violent methods, so as often to destroy all the beauty of the shell. They file them down on all sides, and often take them to the wheel, when it must destroy the very characters of the species. Nor do they stop at this: but, determined to have beauty at any rate, they are for improving upon nature, and frequently add some lines and colours with a pencil, afterwards covering them with a fine coat of varnish, so that they seem the natural lineations of the shell: the Dutch cabinets are by these means made very beautiful, but they are by no means to be regarded as instructors in natural history. There are some artificers of this nation who have a way of covering shells all over with a different tinge from that which nature gives them; and the curious are often enticed by these tricks to purchase them for new species.

There is another kind of work bestowed on certain species of shells, particularly the nautilus; namely, the engraving on it lines and circles, and figures of stars, and other things. This is too obvious a work of art to suffer any one to suppose it natural. Buonani has figured several of these wrought shells at the end of his work; but this was applying his labour to very little purpose; the shells are spoiled as objects of natural history by it, and the engraving is seldom worth any thing.— They are principally done in the East Indies.

Shells are subject to several imperfections; some of which are natural and others accidental. The natural defects are the effect of age, or sickness in the fish. The greatest mischief happens to shells by the fish dying in them. The curious in these things pretend to be always able to distinguish a shell taken up with the fish alive from one found on the shores: they call the first a *living*, the second a *dead shell*; and say that the colours are always much tainter in the dead shells. When the shells have lain long dead on the shores, they are subject to many injuries, of which the being eaten by sea-worms is not the least: age renders the finest shells livid or dead in their colours.

Besides the imperfections arising from age and sickness in the fish, shells are subject to other deformities, such as morbid cavities, or protuberances, in parts where there should be none. When the shell is valuable, these faults may be hid, and much added to the beauty of the specimen, without at all injuring it as an object of natural history, which should always be the great end of collecting these things. The cavities may be filled up with mastic, dissolved in spirit of wine, or with isinglass: these substances must be either coloured to the tinge of the shell, or else a pencil dipped in water-colours must finish them up to the resemblance of the rest; and then the whole shell being rubbed over with gum-water, or with the white of an egg, scarce any eye can perceive the artifice: the same substances may also be used to repair the battered edge of a shell provided the pieces chipped off be not too large. And when the excrescences of a shell are faulty, they are to be taken down with a fine file. If the lip of a shell be so battered that it will not admit of repairing by any cement, the whole must be filed down or ground on the wheel till it become even.

*Fossil SHELLS.* Those found buried at great depths in the earth.

Of these some are found remaining almost entirely in their native state, but others are variously altered by being impregnated with particles of stone and of other fossils; in the place of others there is found mere stone or spar, or some other native mineral body, expressing all their lineaments in the most exact manner, as having been formed wholly from them, the shell having been first deposited in some solid matrix, and thence dissolved by very slow degrees, and this matter left in its place, on the cavities of stone and other solid substances, out of which shells had been dissolved and washed away, being afterwards filled up less slowly with these different substances, whether spar or whatever else: these substances, so filling the cavities, can necessarily be of no other form than that of the shell, to the absence of which the cavity was owing, though all the nicer lineaments may not be so exactly expressed. Besides these, we have also in many places masses of stone formed within various shells; and these having been received into the cavities of the shells while they were perfectly fluid, and having therefore nicely filled all their cavities, must retain the perfect figures of the internal part of the shell, when the shell itself should be worn away or perished from their outside. The various species we find of these are, in many genera, as numerous as the known recent ones; and as we have in our own island not only the shells of our own shores, but those of many other very distant ones, so we have

Shells. also many species, and those in great numbers, which are in their recent state, the inhabitants of other yet unknown or unsearched seas and shores. The cockles, muscles, oysters, and the other common bivalves of our own seas, are very abundant: but we have also an amazing number of the nautilus kind, particularly of the nautilus græcorum, which though a shell not found living in our own or any neighbouring seas, yet is found buried in all our clay-pits about London and elsewhere; and the most frequent of all fossil shells in some of our counties are the conchæ anomizæ, which yet we know not of in any part of the world in their recent state. Of this sort also are the cornua ammonis and the gryphitæ, with several of the echinitæ and others.

The exact similitude of the known shells, recent and fossil, in their several kinds, will by no means suffer us to believe that these, though not yet known to us in their living state, are, as some have idly thought, a sort of *lusus nature*. It is certain, that of the many known shores, very few, not even those of our own island, have been yet carefully searched for the shell-fish that inhabit them; and as we see in the nautilus græcorum an instance of shells being brought from very distant parts of the world to be buried here, we cannot wonder that yet unknown shores, or the unknown bottoms of deep seas, should have furnished us with many unknown shell-fish, which may have been brought with the rest; whether that were at the time of the general deluge, or the effect of any other catastrophe of a like kind, or by whatever other means, to be left in the yet unhardened matter of our stony and clayey strata.

SHELLS, in gunnery, are hollow iron balls to throw out of mortars or howitzers, with a fuse-hole of about an inch diameter, to load them with powder, and to receive the fuse. The bottom, or part opposite to the fuse, is made thicker than the rest, that the fuse may fall uppermost. But in small elevations this does not always happen, nor indeed is it necessary; for, let the shell fall as it will, the fuse sets fire to the powder within, which bursts the shell, and causes great devastation. The shells had much better be of an equal thickness; for then they burst into more pieces.

*Bestige* SHELLS, are nothing more than howitz-shells, in the inside of which a letter or other papers are put; the fuse hole is stopped up with wood or cork, and the shells are fired out of a royal or howitz, either into a garrison or camp. It is supposed, that the person to whom the letter is sent knows the time, and accordingly appoints a guard to look out for its arrival.

*SHALL-Fish*. These animals are in general oviparous, very few instances having been found of such as are viviparous. Among the oviparous kinds, anatomists have found that some species are of different sexes, in the different individuals of the same species; but others are hermaphrodites, every one being in itself both male and female. In both cases their increase is very numerous, and scarce inferior to that of plants, or of the most fruitful of the insect class. The eggs are very small, and are hung together in a sort of clusters by means of a glutinous humour, which is always placed about them, and is of the nature of the jelly of frog's spawn. By means of this, they are not only kept together in the parcel, but the whole cluster is fastened to the rocks, shells, or other solid substances; and thus

they are preserved from being driven on shore by the waves, and left where they cannot succeed. See TESTACEA.

*SHELL-Gold*. See GOLD.

SHELLIE, a small but strong kind of horse, so called from Shetland, or Zetland, where they are produced.

SHELVES, in sea-language, a general name given to any dangerous shallows, sand banks, or rocks, lying immediately under the surface of the water, so as to intercept any ship in her passage, and endanger her destruction.

SHENAN. See *Dying of LEATHER*, vol. ix. p. 750, foot-note.

SHENSTONE (William), an admired English poet, the eldest son of a plain country gentleman, who farmed his own estate in Shropshire, was born in November 1714. He learned to read of an old dame, whom his poem of the "School-mistress" has delivered to posterity; and soon received such delight from books, that he was always calling for new entertainment, and expected that, when any of the family went to market, a new book should be brought him, which, when it came, was in fondness carried to bed, and laid by him. It is said, that when his request had been neglected, his mother wrapped up a piece of wood of the same form, and pacified him for the night. As he grew older, he went for a while to the grammar-school in Hales-Owen, and was placed afterwards with Mr Crumpton, an eminent school-master at Solihul, where he distinguished himself by the quickness of his progress. When he was young (June 1724), he was deprived of his father; and soon after (August 1726) of his grandfather; and was, with his brother, who died afterwards unmarried, left to the care of his grandmother, who managed the estate. From school he was sent, in 1732, to Pembroke college in Oxford, a society which for half a century has been eminent for English poetry and elegant literature. Here it appears that he found delight and advantage; for he continued his name there ten years, though he took no degree. After the first four years he put on the civilian's gown, but without showing any intention to engage in the profession. About the time when he went to Oxford, the death of his grandmother devolved his affairs to the care of the reverend Mr Dolman, of Bromes, in Staffordshire, whose attention he always mentioned with gratitude. — At Oxford he applied to English poetry; and, in 1737, published a small Miscellany, without his name. He then for a time wandered about, to acquaint himself with life, and was sometimes at London, sometimes at Bath, or any place of public resort; but he did not forget his poetry. He published, in 1740, his "Judgment of Hercules," addressed to Mr Lyttleton, whose interest he supported with great warmth at an election; this was two years afterwards followed by the "School-mistress." Mr Dolman, to whose care he was indebted for his ease and leisure, died in 1745, and the care of his fortune now fell upon himself. He tried to escape it a while, and lived at his house with his tenants, who were distantly related; but, finding that imperfect possession inconvenient, he took the whole estate into his own hands, an event which rather improved its beauty than increased its produce. Now began his delight in rural pleasures, and his passion of rural elegance; but in time his expences

occasionally

She bore  
it  
Sherbet.

occasioned clamours that overpowered the lamb's bleat and the linnet's song, and his groves were haunted by beings very different from fawns and fairies. He spent his estate in adorning it, and his death was probably hastened by his anxieties. He was a lamp that spent its oil in blazing. It is said, that if he had lived a little longer, he would have been assisted by a pension; such bounty could not have been more properly bestowed, but that it was ever asked is not certain; it is too certain that it never was enjoyed — He died at the Leasowes, of a putrid fever, about five on Friday morning, Feb. 11. 1763; and was buried by the side of his brother, in the churchyard of Hales-Owen.

In his private opinions, our author adhered to no particular sect, and hated all religious disputes. Tenderness, in every sense of the word, was his peculiar characteristic; and his friends, domestics, and poor neighbours, daily experienced the effects of his benevolence. This virtue he carried to an excess that seemed to border upon weakness; yet if any of his friends treated him ungenerously, he was not easily reconciled. On such occasions, however, he used to say, "I never will be a revengeful enemy; but I cannot, it is not in my nature, to be half a friend." He was no economist; for the generosity of his temper prevented his paying a proper regard to the use of money: he exceeded therefore the bounds of his paternal fortune. But, if we consider the perfect paradise into which he had converted his estate, the hospitality with which he lived, his charities to the indigent, and all out of an estate that did not exceed 300 l. a-year, one should rather wonder that he left any thing behind him, than blame his want of economy: he yet left more than sufficient to pay all his debts, and by his will appropriated his whole estate to that purpose. Though he had a high opinion of many of the fair sex, he forbore to marry. A passion he entertained in his youth was with difficulty surmounted. The lady was the subject of that admirable pastoral, in four parts, which has been so universally and so justly admired, and which, one would have thought, must have softened the proudest and most obdurate heart. His works have been published by Mr Doddsley, in 3 vols 8vo. The first volume contains his poetical works, which are particularly distinguished by an amiable elegance and beautiful simplicity; the second volume contains his prose works; the third his letters, &c. *Biographical Dictionary.*

**SHEPPEY**, an island at the mouth of the river Medway, about 20 miles in circumference. It is separated from the main land by a narrow channel, and has a fertile soil, which feeds great flocks of sheep. The borough-town of Queenborough is seated thereon; besides which it has several villages.

**SHERARDIA**, in botany: A genus of the monogynia order, belonging to the tetrandria class of plants; and in the natural method ranking under the 47th order, *Stellate*. The calyx is small, quadridentate; the corolla monopetalous, long, and funnel shaped. The two seeds are naked, and crowned with the calyx. There are three species, viz. 1. *Atrientis*; 2. *Muralis*; 3. *Fruticosa*.

**SHERBET**, or **SHERBIT**, a compound drink, first brought into England from Turkey and Persia, consisting of water, lemon juice, and sugar, in which are dis-

solved perfumed cakes made of excellent Damascus fruit, containing an infusion of some drops of rose water. Another kind of it is made of violets, honey, juice of raisins, &c.

**SHERIDAN** (Thomas), D. D. the intimate friend of Dean Swift, is said by Shield, in Cibber's "Lives of the Poets," to have been born about 1684, in the county of Cavan, where, according to the same authority, his parents lived in no very elevated state. They are described as being unable to afford their son the advantages of a liberal education; but he, being observed to give early indications of genius, attracted the notice of a friend to his family, who sent him to the college of Dublin, and contributed towards his support while he remained there. He afterwards entered into orders, and set up a school in Dublin, which long maintained a very high degree of reputation, as well for the attention bestowed on the morals of the scholars as for their proficiency in literature. So great was the estimation in which this seminary was held, that it is asserted to have produced in some years the sum of L. 1000. It does not appear that he had any considerable preferment; but his intimacy with Swift, in 1725, procured for him a living in the south of Ireland worth about L. 150 a-year, which he went to take possession of, and, by an act of inadvertence, destroyed all his future expectations of rising in the church; for being at Corke on the 1st of August, the anniversary of King George's birth-day, he preached a sermon, which had for its text, "Sufficient for the day is the evil thereof." On this being known, he was struck out of the list of chaplains to the lord lieutenant, and forbidden the ca. de.

This living Dr Sheridan afterwards changed for that of Dunboyne, which, by the knavery of the farmers, and power of the gentlemen in the neighbourhood, fell so low as L. 80 *per annum*. He gave it up for the free school of Cavan, where he might have lived well in so cheap a country on L. 80 a-year salary, besides his scholars; but the air being, as he said, too moist and unwholesome, and being disgusted with some persons who lived there, he sold the school for about L. 400; and having soon spent the money, he fell into bad health, and died Sept. 10. 1738, in his 55th year.

Lord Corke has given the following character of him: "Dr Sheridan was a school-master, and in many instances perfectly well adapted for that station. He was deeply versed in the Greek and Roman languages, and in their customs and antiquities. He had that kind of good nature which abstinence of mind, indolence of body, and carelessness of fortune, produce; and although not over strict in his own conduct, yet he took care of the morality of his scholars, whom he sent to the university remarkably well founded in all kinds of classical learning, and not ill instructed in the social duties of life. He was slovenly, indigent, and cheerful. He knew books much better than men; and he knew the value of money least of all. In this situation, and with this disposition, Swift fastened upon him as upon a prey with which he intended to regale himself whenever his appetite should prompt him." His Lordship then mentions the event of the unlucky sermon, and adds: "This ill-starred, good-natured, improvident man, returned to Dublin, unhinged from all favour at court, and even banished from the castle. But still he remained a punter, a quibbler, a fiddler, and a wit. Not a

day

Sheridan,  
Sheriff

day passed without a rebus, an anagram, or a madrigal. His pen and his fiddlestick were in continual motion; and yet to little or no purpose, if we may give credit to the following verses, which shall serve as the conclusion of his poetical character:

"With music and poetry equally blest'd,  
"A bard thus Apollo most humbly address'd;  
"Great author of poetry, music, and light,  
"Instructed by thee, I both fiddle and write;  
"Yet unheeded I serape, or I scribble all day,  
"My tunes are neglected, my verse flung away.  
"Thy substitute here, Vice-Apollo disdains  
"To vouch for my numbers, or list to my strains.  
"Thy manual sign he refuses to put  
"To the airs I produce from the pen or the gut:  
"Be thou then propitious, great Phœbus, and grant  
"Relief, or reward, to my merit or want.  
"Tho' the Dean and Delany transcendently shine,  
"O! brighten one solo or sonnet of mine:  
"Make one work immortal, 'tis all I request.  
"Apollo look'd pleas'd, and resolving to jest,  
"Replied—Honest friend, I've consider'd your case,  
"Nor dislike your unmeaning and innocent face.  
"Your petition I grant, the boon is not great,  
"Your works shall continue, and here's the receipt,  
"On rondeaus hereafter your fiddle-strings spend,  
"Write verses in circles, they never shall end."

"One of the volumes of Swift's miscellanies consists almost entirely of letters between him and the Dean. He published a prose translation of Persius; to which he added the best notes of former editors, together with many judicious ones of his own. This work was printed at London, 1739, in 12mo. *Biographical Dictionary*.

SHERIDAN (Mrs Frances), wife to Thomas Sheridan, M. A. was born in Ireland about the year 1724, but descended from a good English family which had removed thither. Her maiden name was Chamberlaine, and she was grand-daughter of Sir Oliver Chamberlaine. The first literary performance by which she distinguished herself was a little pamphlet at the time of a violent party-dispute relative to the theatre, in which Mr Sheridan had newly embarked his fortune. So well timed a work exciting the attention of Mr Sheridan, he by an accident discovered his fair patroness, to whom he was soon afterwards married. She was a person of the most amiable character in every relation of life, with the most engaging manners. After lingering some years in a very weak state of health, she died at Blois, in the south of France, in the year 1767. Her "Sydney Biddulph" may be ranked with the first productions of that class in ours or in any other language. She also wrote a little romance in one volume called *Nourjabad*, in which there is a great deal of imagination productive of an admirable moral. And she was the authoress of two comedies, "The Discovery" and "The Dupe."

Lackford's  
Commentaries,  
vol. i.  
339.

SHERIFF, an officer, in each county in England, nominated by the king, invested with a judicial and ministerial power, and who takes place of every nobleman in the county during the time of his office.

The sheriff is an officer of very great antiquity in this kingdom, his name being derived from two Saxon words, signifying the *reeve*, *bailiff*, or *officer* of the shire. He is called in Latin *vice-comes*, as being the deputy of the earl or *comes*, to whom the custody of

the shire is said to have been committed at the first division of this kingdom into counties. But the earls, in process of time, by reason of their high employments and attendance on the king's person, not being able to transact the business of the county, were delivered of that burden; reserving to themselves the honour, but the labour was laid on the sheriff. So that now the sheriff does all the king's business in the county; and tho' he be still called *vice-comes*, yet he is entirely independent of, and not subject to, the earl; the king, by his letters patent, committing *custodiam comitatus* to the sheriff, and to him alone.

Sheriff.

Sheriffs were formerly chosen by the inhabitants of the several counties. In confirmation of which it was ordained, by statute 28 Edw. I. c. 8. that the people should have an election of sheriffs in every shire where the shrievalty is not of inheritance. For anciently in some counties the sheriffs were hereditary; as we apprehend they were in Scotland till the statute 20 Geo. II. c. 43; and still continue in the county of Westmorland to this day; the city of London having also the inheritance of the shrievalty of Middlesex vested in their body by charter. The reason of these popular elections is assigned in the same statute, c. 13. "that the commons might choose such as would not be a burden to them." And herein appears plainly a strong trace of the democratical part of our constitution; in which form of government it is an indispensable requisite, that the people should choose their own magistrates. This election was in all probability not absolutely vested in the commons, but required the royal approbation. For in the Gothic constitution, the judges of their county-courts (which office is executed by the sheriff) were elected by the people, but confirmed by the king; and the form of their election was thus managed; the people, or *incola territorii*, chose twelve electors, and they nominated three persons, *ex quibus rex unum confirmabat*. But, with us in England, these popular elections, growing tumultuous, were put an end to by the statute 9 Edw. II. st. 2. which enacted, that the sheriffs should from thenceforth be assigned by the chancellor, treasurer, and the judges; as being persons in whom the same trust might with confidence be reposed. By statutes 14 Edw. III. c. 7. 23 Hen. VI. c. 8. and 21 Hen. VIII. c. 20. the chancellor, treasurer, president of the king's council, chief justices, and chief baron, are to make this election; and that on the morrow of All Souls, in the exchequer. And the king's letters patent, appointing the new sheriffs, used commonly to bear date the sixth day of November. The statute of Cambridge, 12 Ric. II. c. 2. ordains, that the chancellor, treasurer, keeper of the privy seal, steward of the king's house, the king's chamberlain, clerk of the rolls, the justices of the one bench and the other, barons of the exchequer, and all other that shall be called to ordain, name, or make justices of the peace, sheriffs, and other officers of the king, shall be sworn to act indifferently, and to name no man that sueth to be put in office, but such only as they shall judge to be the best and most sufficient. And the custom now is (and has been at least ever since the time of Fortescue, who was chief justice and chancellor to Henry the sixth), that all the judges, together with the other great officers, meet in the exchequer chamber on the morrow of All Souls yearly, (which day is now altered to the morrow

Sheriff

of St Martin by the last act for abbreviating Michaelmas term), and then and there propose three persons to the king, who afterwards appoints one of them to be sheriff. This custom of the twelve judges proposing three persons seems borrowed from the Gothic constitution before-mentioned: with this difference, that among the Goths the 12 nominors were first elected by the people themselves. And this usage of ours, at its first introduction, there is reason to believe, was founded upon some statute, though not now to be found among our printed laws; first, because it is materially different from the direction of all the statutes before-mentioned; which it is hard to conceive that the judges would have countenanced by their concurrence, or that Fortescue would have inserted in his book, unless by the authority of some statute; and also, because a statute is expressly referred to in the record, which Sir Edward Coke tells us he transcribed from the council-book of 2d March, 24 Hen. VI. and which is in substance as follows. The king had of his own authority appointed a man sheriff of Lincolnshire, which office he refused to take upon him; whereupon the opinions of the judges were taken, what should be done in this behalf. And the two chief justices, Sir John Fortescue and Sir John Prifot, delivered the unanimous opinion of them all; "that the king did an error when he made a person sheriff that was not chosen and presented to him according to the statute; that the person refusing was liable to no fine for disobedience, as if he had been one of the three persons chosen according to the tenor of the statute; that they would advise the king to have recourse to the three persons that were chosen according to the statute, or that some other thrity man be intrusted to occupy the office for this year; and that, the next year, to eschew such inconveniences, the order of the statute in this behalf made be observed." But, notwithstanding this unanimous resolution of all the judges of England, thus entered in the council-book, and the statute 34 and 35 Hen. VIII. c. 26. § 61. which expressly recognizes this to be the law of the land, some of our writers have affirmed, that the king, by his prerogative, may name whom he pleases to be sheriff, whether chosen by the judges or not. This is grounded on a very particular case in the fifth year of queen Elizabeth, when, by reason of the plague, there was no Michaelmas term kept at Westminster; so that the judges could not meet there *in crastino animurum* to nominate the sheriffs: whereupon the queen named them herself, without such previous assembly, appointing for the most part one of two remaining in the last year's list. And this case, thus circumstanced, is the only authority in our books for the making these extraordinary sheriffs. It is true, the reporter adds, that it was held that the queen by her prerogative might make a sheriff without the election of the judges, *non obstante aliquo statute in contrarium*; but the doctrine of *non obstante*, which sets the prerogative above the laws, was effectually demolished by the bill of rights at the revolution, and abdicated Westminster-hall when king James abdicated the kingdom. However, it must be acknowledged, that the practice of occasionally naming what are called *pocket-sheriffs*, by the sole authority of the crown, hath uniformly continued to the reign of his present majesty; in which, it is believed, few (if any) instances have occurred.

Sheriffs, by virtue of several old statutes, are to con-

tinue in their office no longer than one year; and yet it hath been said that a sheriff may be appointed *durante bene placito*, or during the king's pleasure; and so is the form of the royal writ. Therefore, till a new sheriff be named, his office cannot be determined, unless by his own death, or the demise of the king; in which last case it was usual for the successor to send a new writ to the old sheriff; but now, by statute 1 Anne st. 1. c. 8. all officers appointed by the preceding king may hold their offices for six months after the king's demise, unless sooner displaced by the successor. We may farther observe, that by statute 1 Ric. II. c. 11. no man that has served the office of sheriff for one year can be compelled to serve the same again within three years after.

We shall find it is of the utmost importance to have the sheriff appointed according to law, when we consider his power and duty. These are either as a judge, as the keeper of the king's peace, as a ministerial officer of the superior courts of justice, or as the king's bailiff.

In his judicial capacity he is to hear and determine all causes of 40 shillings value and under, in his county-court: and he has also a judicial power in divers other civil cases. He is likewise to decide the elections of knights of the shire, (subject to the controul of the House of Commons), of coroners, and of verderors; to judge of the qualification of voters, and to return such as he shall determine to be duly elected.

As the keepers of the king's peace, both by common law and special commission, he is the first man in the county, and superior in rank to any nobleman therein, during his office. He may apprehend, and commit to prison, all persons who break the peace, or attempt to break it; and may bind any one in a recognizance to keep the king's peace. He may, and is bound, *ex officio*, to pursue and take all traitors, murderers, felons, and other misdoers, and commit them to gaol for safe custody. He is also to defend his county against any of the king's enemies when they come into the land; and for this purpose, as well as for keeping the peace and pursuing felons, he may command all the people of his county to attend him; which is called the *posse comitatus*, or power of the county; which summons, every person above 15 years old, and under the degree of a peer, is bound to attend upon warning, under pain of fine and imprisonment. But though the sheriff is thus the principal conservator of the peace in his county, yet, by the express directions of the great charter, he, together with the constable, coroner, and certain other officers of the king, are forbidden to hold any pleas of the crown, or, in other words, to try any criminal offence. For it would be highly unbecoming, that the executioners of justice should be also the judges; should impose, as well as levy, fines and amercements; should one day condemn a man to death, and personally execute him the next. Neither may he act as an ordinary justice of the peace during the time of his office; for this would be equally inconsistent, he being in many respects the servant of the justices.

In his ministerial capacity, the sheriff is bound to execute all process issuing from the king's courts of justice. In the commencement of civil causes, he is to serve the writ, to arrest, and to take bail; when the cause comes to trial, he must summon and return the jury; when it is determined, he must see the judgment

Sheriff

of the court carried into execution. In criminal matters, he also arrests and imprisons, he returns the jury, he has the custody of the delinquent, and he executes the sentence of the court, thought extend to death itself.

As the king's bailiff, it is his business to preserve the rights of the king within his bailiwick; for so his county is frequently called in the writs: a word introduced by the princes of the Norman line; in imitation of the French, whose territory is divided into bailiwicks, as that of England into counties. He must seize to the king's use all lands devolved to the crown by attainder or escheat; must levy all fines and forfeitures, must seize and keep all waifs, wrecks, estrays, and the like, unless they be granted to some subject; and must also collect the king's rents within his bailiwick, if commanded by process from the exchequer.

To execute these various offices, the sheriff has under him many inferior officers; an under-sheriff, bailiffs, and gaolers, who must neither buy, sell, nor farm their offices, on forfeiture of 500*l*.

The under-sheriff usually performs all the duties of the office; a very few only excepted, where the personal presence of the high-sheriff is necessary. But no under-sheriff shall abide in his office above one year; and if he does, by statute 23 Hen. VI. c. 8. he forfeits 200*l*. a very large penalty in those early days. And no under-sheriff or sheriff's officer shall practise as an attorney during the time he continues in such office: for this would be a great inlet to partiality and oppression. But these salutary regulations are shamefully evaded, by practising in the names of other attorneys, and putting in sham deputies by way of nominal under-sheriffs: by reason of which, says Dalton, the under-sheriffs and bailiffs do grow so cunning in their several places, that they are able to deceive, and it may well be feared that many of them do deceive, both the king, the high-sheriff, and the county.

SHERIFF, in Scotland. See LAW, Part iii. sect. 3.

SHERLOCK (William), a learned English divine in the 17th century, was born in 1641, and educated at Eaton school, where he distinguished himself by the vigour of his genius and his application to study. Thence he was removed to Cambridge, where he took his degrees. In 1669 he became rector of the parish of St George, Botolph-lane, in London; and in 1681 was collated to the prebend of Pancras, in the cathedral of St Paul's. He was likewise chosen master of the Temple, and had the rectory of Therfield in Hertfordshire. After the Revolution he was suspended from his preferment, for refusing the oaths to king William and queen Mary; but at last he took them, and publicly justified what he had done. In 1691 he was installed dean of St Paul's. His Vindication of the Doctrine of the Trinity engaged him in a warm controversy with Dr South and others. Bishop Burnet tells us, he was "a clear, a polite, and a strong writer; but apt to assume too much to himself, and to treat his adversaries with contempt." He died in 1707. His works are very numerous; among these are, 1. A Discourse concerning the Knowledge of Jesus Christ, against Dr Owen. 2. Several pieces against the Papists, the Socinians, and Dissenters. 3. A practical Treatise on Death, which is much admired. 4. A practical Discourse on Providence. 5. A practical Discourse on the future Judgment; and many other works.

VOL. XVII. Part I.

SHERLOCK (Dr Thomas), bishop of London, was the son of the preceding Dr William Sherlock, and was born in 1678. He was educated in Catharine-hall, Cambridge, where he took his degrees, and of which he became master: he was made master of the Temple very young, on the resignation of his father; and it is remarkable, that this mastership was held by father and son successively for more than 70 years. He was at the head of the opposition against Dr Hoadley bishop of Bangor; during which contest he published a great number of pieces. He attacked the famous Collins's "Grounds and Reasons of the Christian Religion," in a course of six sermons, preached at the Temple church, which he intitled "The Use and Intent of Prophecy in the several Ages of the World." In 1728, Dr Sherlock was promoted to the bishopric of Bangor; and was translated to Salisbury in 1734. In 1747 he refused the archbishopric of Canterbury, on account of his ill state of health; but recovering in a good degree, accepted the see of London the following year. On occasion of the earthquakes in 1750, he published an excellent Pastoral Letter to the clergy and inhabitants of London and Westminster: of which it is said there were printed in 4to, 5000; in 8vo, 20,000; and in 12mo, about 30,000; beside pirated editions, of which not less than 50,000 were supposed to have been sold. Under the weak state of body in which he lay for several years, he revised and published 4 vols of Sermons in 8vo, which are particularly admired for their ingenuity and elegance. He died in 1762, and by report worth 150,000*l*. "His learning," says Dr Nicholls, "was very extensive: God had given him a great and an understanding mind, a quick comprehension, and a solid judgment. These advantages of nature he improved by much industry and application. His skill in the civil and canon law was very considerable; to which he had added such a knowledge of the common law of England as few clergymen attain to. This it was that gave him that influence in all causes where the church was concerned; as knowing precisely what it had to claim from its constitutions and canons, and what from the common law of the land." Dr Nicholls then mentions his constant and exemplary piety, his warm and fervent zeal in preaching the duties and maintaining the doctrines of Christianity, and his large and diffusive munificence and charity; particularly by his having given large sums of money to the corporation of clergymen's sons, to several of the hospitals, and to the society for propagating the gospel in foreign parts: also his bequeathing to Catharine-hall in Cambridge, the place of his education, his valuable library of books, and his donations for the founding a librarian's place and a scholarship, to the amount of several thousand pounds.

SHERRIFFE of Mecca, the title of the descendants of Mahomet by Hassan Ibn Ali. These are divided into several branches, of which the family of Ali Bunemi, consisting at least of three hundred individuals, enjoy the sole right to the throne of Mecca. The Ali Bunemi are, again, subdivided into two subordinate branches, Darii Sajid, and Darii Barkad; of whom sometimes the one, sometimes the other, have given sovereigns to Mecca and Medina, when these were separate states.

Not only is the Turkish Sultan indifferent about the order of succession in this family, but he seems even to

**Sheriffe.** foment the diffensions which arise among them, and favours the strongest, merely that he may weaken them all. As the order of succession is not determinately fixed, and the sherriffes may all aspire alike to the sovereign power, this uncertainty of right, aided by the intrigues of the Turkish officers, occasions frequent revolutions. The grand sherriffe is seldom able to maintain himself on the throne; and it still seldomer happens that his reign is not disturbed by the revolt of his nearest relations. There have been instances of a nephew succeeding his uncle, an uncle succeeding his nephew; and sometimes of a person, from a remote branch, coming in the room of the reigning prince of the ancient house.

When Niebuhr was in Arabia, in 1763, the reigning Sherriffe Mesad had sitten fourteen years on the throne, and, during all that period, had been continually at war with the neighbouring Arabs, and with his own nearest relations sometimes. A few years before, the Pacha of Syria had deposed him, and raised his younger brother to the sovereign dignity in his stead. But after the departure of the caravan, Jasar, the new sherriffe, not being able to maintain himself on the throne, was obliged to resign the sovereignty again to Mesad. Achmet, the second brother of the sherriffe, who was much beloved by the Arabs, threatened to attack Mecca while Niebuhr was at Jidda. Our traveller was soon after informed of the termination of the quarrel, and of Achmet's return to Mecca, where he continued to live peaceably in a private character.

These examples show that the Mussulmans observe not the law which forbids them to bear arms against their holy places. An Egyptian Bey even presumed, a few years since, to plant some small cannons within the compass of the Kaba, upon a small tower, from which he fired over that sacred mansion, upon the palace of Sherriffe Mesad, with whom he was at variance.

The dominions of the sherriffe comprehend the cities of Mecca, Medina, Jambo, Taaif, Sadie, Ghunfude, Hali, and thirteen others less considerable, all situated in Hedjas. Near Taaif is the lofty mountain of Gazvan, which, according to Arabian authors, is covered with snow in the midst of summer. As these dominions are neither opulent nor extensive, the revenue of their sovereign cannot be considerable.

He finds a rich resource, however, in the imposts levied on pilgrims, and in the gratuities offered him by Mussulman monarchs. Every pilgrim pays a tax of from ten to an hundred crowns, in proportion to his ability. The Great Mogul remits annually sixty thousand roupes to the sherriffe, by an assignment upon the government of Surat. Indeed, since the English made themselves masters of this city, and the territory belonging to it, the Nabob of Surat has no longer been able to pay the sum. The sherriffe once demanded it of the

English, as the possessors of Surat; and, till they should satisfy him, forbade their captains to leave the port of Jidda. But the English disregarding this prohibition, the sherriffe complained to the Ottoman Porte, and they communicated his complaints to the English ambassador. He at the same time opened a negociation with the nominal Nabob, who resides in Surat. But these steps proved all fruitless: and the sovereign of Mecca seems not likely to be ever more benefited by the contribution from India.

The power of the sherriffe extends not to spiritual matters; these are entirely managed by the heads of the clergy, of different sects, who are resident at Mecca. Rigid Mussulmans, such as the Turks, are not very favourable in their sentiments of the sherriffes, but suspect their orthodoxy, and look upon them as secretly attached to the tolerant sect of the Zeidi.

**SHETLAND**, the name of certain islands belonging to Scotland, and lying to the northward of Orkney. There are many convincing proofs that these islands were very early inhabited by the Picts, or rather by those nations who were the original possessors of the Orkneys; and at the time of the total destruction of these nations, if any credit be due to tradition, their woods were entirely ruined (A). It is highly probable that the people in Shetland, as well as in the Orkneys, flourished under their own princes dependent upon the crown of Norway; yet this seems to have been rather through what they acquired by fishing and commerce, than by the cultivation of their lands. It may also be reasonably presumed, that they grew thinner of inhabitants after they were annexed to the crown of Scotland; and it is likely that they revived again, chiefly by the very great and extensive improvements which the Dutch made in the herring-fishery upon their coasts, and the trade that the crews of their buffes, then very numerous, carried on with the inhabitants, necessarily resulting from their want of provisions and other conveniences, which in those days could not be very considerable.

There are many reasons which may be assigned why these islands, though part of our dominions, have not hitherto been better known to us. They were commonly placed two degrees too far to the north in all the old maps, in order to make them agree with Ptolemy's description of Thule, which he asserted to be in the latitude of 63 degrees; which we find urged by Camden as a reason why Thule must be one of the Shetland isles, to which Speed also agrees, though from their being thus wrong placed he could not find room for them in his maps. Another, and that no light cause, was the many false, fabulous, and impertinent relations published concerning them (B), as if they were countries inhospitable and uninhabitable; and lastly, the indolence, or rather indifference, of the natives, who, contenting themselves

(A) The tradition is, that this was done by the Scots when they destroyed the Picts; but is more probably referred to the Norwegians rooting out the original possessors of Shetland.

(B) They represented the climate as intensely cold; the soil as composed of crags and quagmire, so barren as to be incapable of bearing corn; to supply which, the people, after drying fish-bones, powdered them, then kneaded and baked them for bread. The larger fish-bones were said to be all the fuel they had. Yet, in so dreary a country, and in such miserable circumstances, they were acknowledged to be very long-lived, cheerful, and contented.



Shetland. themselves with those necessaries and conveniences procured by their intercourse with other nations, and conceiving themselves neglected by the mother country, have seldom troubled her with their applications.

There are few countries that have gone by more names than these islands; they were called in Icelandic, *Hiablandia*, from *hialt*, the "hilt of a sword;" this might be possibly corrupted into *Hetland*, *Hiland*, or *Hebland*, though some tell us this signifies a "high land." They have been likewise, and are still in some maps, called *Zetland* and *Zealand*, in reference, as has been supposed, to their situation. By the Danes, and by the natives, they are styled *Teatland*; and notwithstanding the oddness of the orthography, this differs very little, if at all, from their manner of pronouncing *Zetland*, out of which pronunciation grew the modern names of *Shetland* and *Shotland*.

The islands of *Shetland*, as we commonly call them, are well situated for trade. The nearest continent to them is Norway; the port of Bergen lying 44 leagues east, whereas they lie 46 leagues north north-east from Buchanefs; east north-east from Sanda, one of the Orkneys, about 16 or 18 leagues; six or seven leagues north-east from Fair Isle; 58 leagues east from the Ferroe isles; and at nearly the same distance north-east from Lewis. The southern promontory of the main land, called *Sumburgh Head*, lies in 59 degrees and 59 minutes of north latitude; and the northern extremity of *Unst*, the most remote of them all, in the latitude of 61 degrees 15 minutes. The meridian of London passes through this last island, which lies about 2 degrees 30 minutes west from Paris, and about 5 degrees 15 minutes east from the meridian of Cape Lizard. According to Gifford's "Historical Description of *Zetland*," the inhabited islands are 33, of which the principal is styled *Main Land*, and extends in length from north to south about 60 miles, and is in some places 20 broad, though in others not more than two.

It is impossible to speak with precision; but, according to the best computation which we have been able to form, the Shetland isles contain near three times as much land as the Orkneys: they are considered also as equal in size to the island of Madeira; and not inferior to the provinces of Utrecht, Zealand, and all the rest of the Dutch islands taken together; but of climate and soil they have not much to boast. The longest day in the island of *Unst* is 19 hours 15 minutes, and of consequence the shortest day 4 hours and 45 minutes. The spring is very late, the summer very short; the autumn also is of no long duration, dark, foggy, and rainy; the winter sets in about November, and lasts till April, and sometimes till May. They have frequently in that season storms of thunder, much rain, but little frost or snow. High winds are indeed very frequent and very troublesome, yet they seldom produce any terrible effects. The aurora borealis is as common here as in any of the northern countries. In the winter season the sea swells and rages in such a manner, that for five or six months their ports are inaccessible, and of course the people during that space have no correspondence with the rest of the world.

The soil in the interior part of the main land, for the most part, is mountainous, moorish, and boggy, yet not to such a degree as to render the country utterly impassable; for many of the roads here, and in some of

the northern isles, are as good as any other natural roads, and the people travel them frequently on all occasions. Near the coast there are sometimes for miles together flat pleasant spots, very fertile both in pasture and corn. The mountains produce large crops of very nutritive grass in the summer; and they cut considerable quantities of hay, with which they feed their cattle in the winter. They might with a little attention bring more of their country into cultivation: but the people are so much addicted to their fishery, and feel so little necessity of having recourse to this method for subsistence, that they are content, how strange soever that may seem to us, to let four parts in five of their land remain in a state of nature.

They want not considerable quantities of marble in different islands, though they use but little; hitherto there has been no chalk found; limestone and freestone there are in the southern parts of the main land in great quantities, and also in the neighbouring islands, particularly *Fetlar*; and considerable quantities of slate, very good in its kind. No mines have been hitherto wrought, though there are in many places visible appearances of several kinds of metal. Some solid pieces of silver, it is said, have been turned up by the plough. In some of the smaller isles there are strong appearances of iron; but, through the want of proper experiments being made, there is, in this respect at least, hitherto nothing certain. Their meadows are inclosed with dikes, and produce very good grass. The little corn they grow is chiefly barley, with some oats; though even in the northern extremity of *Unst* the little land which they have is remarkable for its fertility. The hills abound with medicinal herbs; and their kitchen-gardens thrive as well, and produce as good greens and roots, as any in Britain. Of late years, and since this has been attended to, some gentlemen have had even greater success than they expected in the cultivating of tulips, roses, and many other flowers. They have no trees, and hardly any shrubs except juniper, yet they have a tradition that their country was formerly overgrown with woods; and it seems to be a confirmation of this, that the roots of timber-trees have been, and are still, dug up at a great depth; and that in some, and those too inaccessible, places, the mountain ash is still found growing wild. That this defect, *viz.* the want of wood at present, does not arise entirely from the soil or climate, appears from several late experiments; some gentlemen having raised ash, maple, horse-chestnuts, &c. in their gardens. Though the inhabitants are without either wood or coals, they are very well supplied with fuel, having great plenty of heath and peat. The black cattle in this country are in general of a larger sort than in Orkney, which is owing to their having more extensive pastures; a clear proof that still farther improvements might be made in respect to size. Their horses are small, but strong, stout, and well shaped, live very hardy, and to a great age. They have likewise a breed of small swine, the flesh of which, when fat, is esteemed very delicious. They have no goats, hares, or foxes; and in general no wild or venomous creatures of any kind except rats in some few islands. They have no moor-fowl, which is the more remarkable, as there are everywhere immense quantities of heath; but there are many sorts of wild and water fowl, particularly the dunter-goose, clack-goose, solan-goose, swans, ducks,

Shetland

ducks, teal, whaps, foists, lyres, kittiwaks, maws, plovers, cormorants, &c. There is likewise the ember-goose, which is said to hatch her egg under her wing. Eagles and hawks, as also ravens, crows, mews, &c. abound here.

All these islands are well watered; for there are everywhere excellent springs, some of them mineral and medicinal. They have indeed no rivers; but many pleasant rills or rivulets, which they call *burns*, of different sizes; in some of the largest they have admirable trouts, some of which are of 15 and even of 20 pounds weight. They have likewise many fresh-water lakes, well stored with trout and eels, and in most of them there are also large and fine flounders; in some very excellent cod. These fresh water lakes, if the country was better peopled, and the common people more at their ease, are certainly capable of great improvements. The sea-coasts of the main land of Shetland, in a straight line, are 55 leagues; and therefore there cannot be a country conceived more proper for establishing an extensive fishery. What the inhabitants have been hitherto able to do, their natural advantages considered, does not deserve that name, notwithstanding they export large quantities of cod, tusk, ling, and skate, inasmuch that the bounty allowed by acts of parliament amounts from L. 1400 to L. 2000 annually. They have, besides, haddocks, whittings, turbot, and a variety of other fish. In many of the inlets there are prodigious quantities of excellent oysters, lobsters, muscles, cockles, and other shell-fish. As to amphibious creatures, they have multitudes of otters and seals; add to these, that amber, ambergris, and other spoils of the ocean, are frequently found upon the coasts.

The inhabitants are a stout, well-made, comely people; the lower sort of a swarthy complexion. The gentry are allowed, by all who have conversed with them, to be most of them polite, shrewd, sensible, lively, active, and intelligent persons; and these, to the number of 100 families, have very handsome, strong, well-built houses, neatly furnished; their tables well served, polished in their manners, and exceedingly hospitable and civil to strangers. Those of an inferior rank are a hardy, robust, and laborious people, who, generally speaking, get their bread by fishing in all weathers in their yawls, which are little bigger than Gravesend wherries; live hardily, and in the summer season mostly on fish; their drink, which, in reference to the British dominions, is peculiar to the country, is called *blaud*, and is a sort of butter-milk, long kept, and very sour. Many live to great ages, though not so long as in former times. In respect, however, to the bulk of the inhabitants, from the poorness of living, from the nature of it, and from the drinking great quantities of corn-spirits of the very worst sort, multitudes are afflicted with an inveterate scurvy; from which those in better circumstances are entirely free, and enjoy as good health as in any other country in Europe. As they have no great turn to agriculture, and are persuaded that their country is not fit for it, they do not (though probably they might) raise corn enough to support them for more than two-thirds of the year. But they are much more successful in their pasture-grounds, which are kept well inclosed, in good order, and, together with their commons, supply them plentifully with beef and mutton. They pay their

rents generally in butter at Lammas, and in money at Martinmas. As to manufactures, they make a strong coarse cloth for their own use, as also linen. They make likewise of their own wool very fine stockings. They export, besides the different kinds of fish already mentioned, some herrings, a considerable quantity of butter and train-oil, otter and seal skins, and no inconsiderable quantity of the fine stockings just mentioned. Their chief trade is to Leith, London, Hamburgh, Spain, and to the Straits. They import timbers, deals, and some of their best oats, from Norway; corn and flour from the Orkneys, and from North Britain; spirits and some other things from Hamburgh; cloths and better sort of linen from Leith; grocery, household furniture, and other necessaries, from London. The superior-duties to the earl of Morton are generally let in farm; and are paid by the people in butter, oil, and money. The remains of the old Norwegian constitution are still visible in the division of their lands; and they have some udalmen or freeholders amongst them. But the Scots laws, customs, manners, dress, and language, prevail; and they have a sheriff, and other magistrates for the administration of justice, as well as a customhouse, with a proper number of officers. In reference to their ecclesiastical concerns, they have a presbytery, 12 ministers, and an itinerant for Foula, Fair Island, and the Skerries. Each of these ministers has a stipend of between 40 and 50 pounds, besides a house and a glebe free from taxes. The number of souls in these islands may be about 20,000.

SHEW-BREAD, the loaves of bread which the priest of the week put every Sabbath-day upon the golden-table in the sanctuary, before the Lord, in the temple of the Jews. They were twelve in number, and were offered to God in the name of the twelve tribes of Israel. They were shaped like a brick, were ten palms long and five broad, weighing about eight pounds each. They were unleavened, and made of fine flour by the Levites. The priests set them on the table in two rows, six in a row, and put frankincense upon them to preserve them from moulding. They were changed every Sabbath, and the old ones belonged to the priest upon duty. Of this bread none but the priests might eat, except in cases of necessity. It was called the *bread of faces*, because the table of the shew-bread, being almost over-against the ark of the covenant, the loaves might be said to be set before the face of God. The original table was carried away to Babylon, but a new one was made for the second temple. It was of wood overlaid with gold. This, with the candlestick and some other spoils, was carried by Titus to Rome.

SHIELD, an ancient weapon of defence, in form of a light buckler, borne on the arm to fend off lances, darts, &c. The form of the shield is represented by the escutcheon in coats of arms. The shield was that part of the ancient armour on which the persons of distinction in the field of battle always had their arms painted; and most of the words used at this time to express the space that holds the arms of families are derived from the Latin name for a shield, *scutum*. The French *escu* and *escuison*, and the English word *escutcheon*, or, as we commonly speak it, *scutcheon*, are evidently from this origin; and the Italian *scudo* signifies both the shield of arms and that used in war. The Latin name *clypeus*, for the same thing, seems also to be derived from

Shew  
bread,  
shield.

the

Shield. the Greek word *γλυφίον*, to engrave; and it had this name from the several figures engraved on it, as marks of distinction of the person who wore it.

The shield in war, among the Greeks and Romans, was not only useful in the defence of the body, but it was also a token, or badge of honour, to the wearer; and he who returned from battle without it was always treated with ignominy afterwards. People have at all times thought this honourable piece of the armour the properest place to engrave, or figure on the figure of dignity of the possessor of it; and hence, when arms came to be painted for families in aftertimes, the heralds always chose to represent them upon the figure of a shield, but with several exterior additions and ornaments; as the helmet, supporters, and the rest.

The form of the shield has not only been found different in various nations, but even the people of the same nation, at different times, have varied its form extremely; and among several people there have been shields of several forms and sizes in use, at the same period of time, and suited to different occasions. The most ancient and universal form of shields, in the earlier ages, seems to have been the triangular. This we see instances of in all the monuments and gems of antiquity: our own most early monuments show it to have been the most antique shape also with us, and the heralds have found it the most convenient for their purposes, when they had any odd number of figures to represent; as if three, then two in the broad bottom part, and one in the narrow upper end, it held them very well; or if five, they stood as conveniently, as three below, and two above. The other form of a shield, now universally used, is square, rounded, and pointed at the bottom: this is taken from the figure of the Samnitic shield used by the Romans, and since copied very generally by the English, French, and Germans.

The Spaniards and Portuguese have the like general form of shields, but they are round at the bottom without the point; and the Germans, beside the Samnitic shield, have two others pretty much in use: these are, 1. The bulging shield, distinguished by its swelling or bulging out at the flanks; and, 2. The indented shield, or shield chancree, which has a number of notches and indentings all round its sides. The use of the ancient shield of this form was, that the notches served to rest the lance upon, that it might be firm while it gave the thrust; but this form being less proper for the receiving armorial figures, the two former have been much more used in the heraldry of that nation.

Beside this different form of the shields in heraldry, we find them also often distinguished by their different positions, some of them standing erect, and others slanting various ways, and in different degrees; this the heralds express by the word *pendant*, "hanging," they seeming to be hung up not by the centre, but by the right or left corner. The French call these *ecu pendant*, and the common antique triangular ones *ecu ancien*. The Italians call this *scuto pendente*; and the reason given for exhibiting the shield in these figures in heraldry is, that in the ancient tilts and tournaments, they who were to just at these military exercises, were obliged to hang up their shields with their armories, or coats of arms on them, out at the windows and balconies of the houses near the place; or upon trees, pavilions, or the barriers of the

ground, if the exercise was to be performed in the field.

Those who were to fight on foot, according to Columbian, had their shields hung up by the right corner, and those who were to fight on horseback had theirs hung up by the left. This position of the shields in heraldry is called *couche* by some writers, though by the generality *pendant*.

It was very frequent in all parts of Europe, in arms given between the 11th and 14th centuries; but it is to be observed, that the hanging by the left corner, as it was the token of the owner's being to fight on horseback, so it was esteemed the most honourable and noble situation; and all the pendant shields of the sons of the royal family of Scotland and England, and of our nobility at that time, are thus hanging from the left corner. The hanging from this corner was a token of the owner's being of noble birth, and having fought in the tournaments before; but no sovereign ever had a shield pendant any way, but always erect, as they never formally entered the lists of the tournament.

The Italians generally have their shields of arms of an oval form; this seems to be done in imitation of those of the popes and other dignified clergy: but their herald Petro Sancto seems to regret the use of this figure of the shield, as an innovation brought in by the painters and engravers as most convenient for holding the figures, but derogatory to the honour of the possessor, as not representing either antiquity or honours won in war, but rather the honours of some citizen or person of learning. Some have carried it so far as to say, that those who either have no ancient title to nobility, or have sullied it by any unworthy action, cannot any longer wear their arms in shields properly figured, but were obliged to have them painted in an oval or round shield.

In Flanders, where this author lived, the round and oval shields are in the disrepute he speaks of; but in Italy, beside the popes and dignified prelates, many of the first families of the laity have them.

The secular princes, in many other countries, also retain this form of the shield, as the most ancient and truly expressive of the Roman clypeus.

SHIELD, in heraldry, the escutcheon or field on which the bearings of coats of arms are placed. See HERALDRY.

SHIELDRAKE, in ornithology. See ANAS.

SHIELDS, North and South, two sea-port towns, the one north of the Tyne in Northumberland, the other on the south of the Tyne in the county of Durham. South Shields contains above 200 salt-pans, and on both banks of the river are many convenient houses for the entertainment of seamen and colliers; most of the Newcastle coal-fleet having their station here usually till their coals are brought down in the barges and lighters from Newcastle. A very large Roman altar, of one entire stone, was found some years ago near this place, and put into the hands of the learned Dr Lister, who, in his account of it sent to the Royal Society, says it was erected to Marcus Aurelius Antoninus Caracalla, when he took upon him the command of the empire and the whole army (after his father's death at York), for his safe return from his successful expedition against the Scots and Picts. W. Long. 1. 12. N. Lat. 55. 44.

Shield  
||  
Shields.

Shillers  
H  
Shilling.

**SHIFTERS**, on board a man of war, certain men who are employed by the cooks to shift and change the water in which the flesh or fish is put, and laid for some time, in order to fit it for the kettle.

**SHIFTING A TACKLE**, in sea-language, the act of removing the blocks of a tackle to a greater distance from each other, on the object to which they are applied, in order to give a greater scope or extent to their purchase. This operation is otherwise called *fleeting*. Shifting the helm denotes the alteration of its position, by pushing it towards the opposite side of the ship. Shifting the voyal, signifies changing its position on the capstern, from the right to the left, and *vice versa*.

**SHILLING**, an English silver coin, equal to twelve pence, or the twentieth part of a pound.

Preherus derives the Saxon *scilling*, whence our shilling, from a corruption of *siliqua*; proving the derivation by several texts of law, and, among others, by the 26th law, *De annis legatis*. Skinner deduces it from the Saxon *scild* "shield," by reason of the escutcheon of arms thereon.

Bishop Hooper derives it from the Arabic *scheele*, signifying a *weight*; but others, with greater probability, deduce it from the Latin *scillicus*, which signified in that language a *quarter of an ounce*, or the 48th part of a Roman pound. In confirmation of this etymology it is alleged, that the shilling kept its original signification, and bore the same proportion to the Saxon pound as scillicus did to the Roman and the Greek, being exactly the 48th part of the Saxon pound; a discovery which we owe to Mr Lambard\*.

However, the Saxon laws reckon the pound in the round number at 50 shillings, but they really coined out of it only 48; the value of the shilling was fivepence; but it was reduced to fourpence above a century before the conquest; for several of the Saxon laws, made in Athelstan's reign, oblige us to take this estimate. Thus it continued to the Norman times, as one of the Conqueror's laws sufficiently ascertains; and it seems to have been the common coin by which the English payments were adjusted. After the conquest, the French *solidus* of twelvepence, which was in use among the Normans, was called by the English name of shilling; and the Saxon shilling of fourpence took a Norman name, and was called the *groat*, or great coin, because it was the largest English coin then known in England.

It has been the opinion of the bishops Fleetwood and Gibbon, and of the antiquaries in general, that, though the method of reckoning by pounds, marks, and shillings, as well as by pence and farthings, had been in constant use even from the Saxon times, long before the Norman conquest, there never was such a coin in England as either a pound or a mark, nor any shilling, till the year 1504 or 1505, when a few silver shillings or twelve-pences were coined, which have long since been solely confined to the cabinets of collectors.

Mr Clarke combats this opinion, alleging that some coins mentioned by Mr Folkes, under Edward I. were probably Saxon shillings new minted, and that archbishop Aelfric expressly says†, that the Saxons had three names for their money, viz. mancuses, shillings, and pennies. He also urges the different value of the Saxon shilling at different times, and its uniform proportion to the pound, as an argument that their shil-

ling was a coin; and the testimony of the Saxon gospel, in which the word we have translated *pieces of silver* is rendered *shillings*, which, he says, they would hardly have done, if there had been no such coin as a shilling then in use. Accordingly the Saxons expressed their shilling in Latin by *scelus* and *argenteus*. He farther adds, that the Saxon shilling was never expressed by *solidus* till after the Norman settlements in England; and howsoever it altered during the long period that elapsed from the conquest to the time of Henry VII. it was the most constant denomination of money in all payments, though it was then only a species of account or the twentieth part of the pound Sterling; and when it was again revived as a coin, it lessened gradually as the pound Sterling lessened, from the 28th of Edward III. to the 43d of Elizabeth.

In the year 1560 there was a peculiar sort of shilling struck in Ireland, of the value of ninepence English, which passed in Ireland for twelpence. The motto on the reverse was, *posui Deum adiutorem meum*. Eighty-two of these shillings, according to Malynes, went to the pound; they therefore weighed 20 grains, one-fourth each, which is somewhat heavier in proportion than the English shilling of that time, 62 whereof went to the pound, each weighing 92 grains seven-eighths; and the Irish shilling being valued at the Tower at ninepence English, that is, one-fourth part less than the English shilling, it should therefore proportionably weigh one fourth part less, and its full weight be somewhat more than 62 grains; but some of them found at this time, though much worn, weighed 69 grains. In the year 1598, five different pieces of money of this kind were struck in England for the service of the kingdom of Ireland. These were shillings to be current in Ireland at twelpence each; half shillings to be current at sixpence, and quarter shillings at threepence. Pennies and halfpennies were also struck of the same kind, and sent over for the payment of the army in Ireland. The money thus coined was of a very base mixture of copper and silver; and two years after there were more pieces of the same kinds struck for the same service, which were still worse; the former being three ounces of silver to nine ounces of copper; and these latter only two ounces eighteen pennyweights to nine ounces two pennyweights of the alloy.

The Dutch, Flemish, and Germans, have likewise their shilling, called *schelin*, *schilling*, *scalin*, &c. but these not being of the same weight or fineness with the English shilling, are not current at the same value. The English shilling is worth about 23 French sols; those of Holland and Germany about 11 sols and an half; those of Flanders about nine. The Dutch shillings are also called *sols de gros*, because equal to twelve gros. The Danes have copper shillings worth about one-fourth of a farthing Sterling.

**SHILOH** is a term famous among interpreters and commentators upon Scripture. It is found (Gen. xlix. 10.) to denote the Messiah. The patriarch Jacob foretels his coming in these words; "The sceptre shall not depart from Judah, nor a lawgiver from between his feet, until Shiloh come; and unto him shall the gathering of the people be." The Hebrew text reads, *עד כי יבא שלה* until *Shiloh* come. All Christian commentators agree, that this word ought to be understood of the Messiah, or Jesus Christ; but all are not agreed about

Shilling  
Shiloh.

\* *Explicatio*  
*Rerum et*  
*Verborum in*  
*Leg. Sax.*  
*vic. Libra.*

† *Gram.*  
*Saxon,*  
*p. 52.*

**Shiloh.** about its literal and grammatical signification. St Jerome, who translates it by *Qui mittendus est*, manifestly reads *Shiloch* "sent," instead of *Shiloh*. The Septuagint have it *Εως αν ελθη τα αποσπειρινα αυτου; οτ, Εως αν ελθωμ ε αποσπειρινα,* (as if they had read שלו instead of שלה), i. e. "Until the coming of him to whom it is reserved;" or, "Till we see arrive that which is reserved for him."

It must be owned, that the signification of the Hebrew word *Shiloh* is not well known. Some translate, "the sceptre shall not depart from Judah, till he comes to whom it belongs;" שלה or שלי instead of שלו. Others, "till the coming of the peace-maker;" or, "the pacific;" or, "of prosperity," שלה *prosperatus est*. *Shalab* signifies, "to be in peace, to be in prosperity;" others, "till the birth of him who shall be born of a woman that shall conceive without the knowledge of a man," שול or שוליא *secundina*, *Auxust*; otherwise, "the sceptre shall not depart from Judah, till its end, its ruin; till the downfall of the kingdom of the Jews," שאל or שלו *it has ceased, it has finished* ¶. Some Rabbins have taken the name *Silob* or *Shilob*, as if it signified the city of this name in Palestine: "The sceptre shall not be taken away from Judah till it comes to Shiloh; till it shall be taken from him to be given to Saul at Shiloh." But in what part of Scripture is it said, that Saul was acknowledged as king or consecrated at Shiloh? If we would understand it of Jeroboam the son of Nebat, the matter is still as uncertain. The Scripture mentions no assembly at Shiloh that admitted him as king. A more modern author derives *Shilob* from שלה, *fatigare*, which sometimes signifies *to be weary, to suffer*; "till his labours, his sufferings, his passion, shall happen."

But not to amuse ourselves about seeking out the grammatical signification of Shiloh, it is sufficient for us to show, that the ancient Jews are in this matter agreed with the Christians: they acknowledge, that this word stands for the *Messiah the King*. It is thus that the paraphrasts Onkelos and Jonathan, that the ancient Hebrew commentaries upon Genesis, and that the Talmudists themselves, explain it. If Jesus Christ and his apostles did not make use of this passage to prove the coming of the Messiah, it was because then the completion of this prophecy was not sufficiently manifest. The sceptre still continued among the Jews; they had still kings of their own nation in the persons of the Herods; but soon after the sceptre was entirely taken away from them, and has never been restored to them since.

The conceited Jews seek in vain to put forced meanings upon this prophecy of Jacob; saying, for example, that the sceptre intimates the dominion of strangers, to which they have been in subjection, or the hope of seeing one day the sceptre or supreme power settled again among themselves. It is easy to perceive, that all this is contrived to deliver themselves out of perplexity. In vain likewise they take refuge in certain princes of the captivity, whom they pretend to have subsisted beyond the Euphrates, exercising an authority over their nation little differing from absolute, and being of the race of David. This pretended succession of princes is perfectly chimerical; and though at certain times they could show a succession, it continued but a short time, and their authority was too obscure, and too much limited, to be the object of a prophecy so remarkable as this was.

**SHINGLES**, in building, small pieces of wood, or quartered oaken boards, sawn to a certain scantling, or, as is more usual, cleft to about an inch thick at one end, and made like wedges, four or five inches broad, and eight or nine inches long.

Shingles are used instead of tiles or slates, especially for churches and steeples; however, this covering is dear; yet, where tiles are very scarce, and a light covering is required, it is preferable to thatch: and where they are made of good oak, cleft, and not sawed, and well seasoned in water and the sun, they make a sure, light, and durable covering.

The building is first to be covered all over with boards, and the shingles nailed upon them.

**SHIP**, a general name for all large vessels, particularly those equipped with three masts and a bowsprit; the masts being composed of a lowermast, topmast, and top-gallant-mast: each of these being provided with yards, sails, &c. Ships, in general, are either employed for war or merchandize.

*SHIPS of War* are vessels properly equipped with artillery, ammunition, and all the necessary martial weapons and instruments for attack or defence. They are distinguished from each other by their several ranks or classes, called *rates*, as follows: Ships of the first rate mount from 100 guns to 110 guns and upwards; second rate, from 90 to 98 guns; third rate, from 64 to 74 guns; fourth rate, from 50 to 60 guns; fifth rate, from 32 to 44 guns; and sixth rates, from 20 to 28 guns. See the article *RATE*. Vessels carrying less than 20 guns are denominated *sloops, cutters, fire-ships, and bombs*. It has lately been proposed to reduce the number of these rates, which would be a saving to the nation, and also productive of several material advantages.

In Plate CCCCL. is the representation of a first rate, with rigging, &c. the several parts of which are as follow:

Parts of the hull.—A, The cathead; B, The fore-chain-wales, or chains; C, The main-chains; D, The mizen-chains; E, The entering port; F, The hawse-holes; G, The poop-lanterns; H, The cheff-tree; I, The head; K, The stern.

1, The bowsprit. 2, Yard and sail. 3, Gammoning. 4, Manrop. 5, Bobstay. 6, Spritsail-sheets. 7, Pendants. 8, Braces and pendants. 9, Halliards. 10, Lifts. 11, Clue-lines. 12, Spritsail-horfs. 13, Buntlines. 14, Standing lifts. 15, Bowsprit-throw. 16, Jib-boom. 17, Jibstay and sail. 18, Halliards. 19, Sheets. 20, Horfs. 21, Jib-guy. 22, Spritsail-top-sail yard. 23, Horfs. 24, Sheets. 25, Lifts. 26, Braces and pendants. 27, Cap of bowsprit. 28, Jack staff. 29, Truck. 30, Jack flag.—31, *Foremast*. 32, Runner and tackle. 33, Shrouds. 34, Laniards. 35, Stay and laniard. 36, Preventer-stay and laniard. 37, Wooding of the mast. 38, Fore-yard and sail. 39, Horfs. 40, Top. 41, Crowfoot. 42, Jeers. 43, Yard-tackles. 44, Lifts. 45, Braces and pendants. 46, Sheets. 47, Foretacks. 48, Bow-lines and bridles. 49, Fore bunt-lines. 50, Fore leech-lines. 51, Preventer-brace. 52, Futtock-shrouds.—53, *Foretop-mast*. 54, Shrouds and laniards. 55, Foretop-sail yard and sail. 56, Stay and sail. 57, Runner. 58, Back-stays. 59, Halliards. 60, Lifts. 61, Braces and pendants. 62, Horfs. 63, Clue-lines. 64, Bow-lines and bridles. 65, Reef-tackles. 66, Sheets. 67, Buntlines.

Ship. Bunt-lines. 68, Cross trees. 69, Cap. 70, Foretop-gallant-mast. 71, Shrouds. 72, Yard and fail. 73, Backstays. 74, Stay. 75, Lifts. 76, Clew-lines. 77, Braces and pendants. 78, Bowlines and bridles. 79, Flag-staff. 80, Truck. 81, Flag-stay-staff. 82, Flag of the lord high admiral.—83, *Mainmast*. 84, Shrouds. 85, Laniards. 86, Runner and tackle. 87, Futtock-shrouds. 88, Top-lantern. 89, Crank of ditto. 90, Stay. 91, Preventer stay. 92, Stay-tackles. 93, Wooding of the mast. 94, Jeers. 95, Yard-tackles. 96, Lifts. 97, Braces and pendants. 98, Horses. 99, Sheets. 100, Tacks. 101, Bowlines and bridles. 102, Crow-foot. 103, Cap. 104, Top. 105, Bunt-lines. 106, Leech-lines. 107, Yard and fail.—108, *Main-topmast*. 109, Shrouds and laniards. 110, Yard and fail. 111, Futtock shrouds. 112, Backstays. 113, Stay. 114, Stayfail and halliards. 115, Tye. 116, Halliards. 117, Lifts. 118, Clew-lines. 119, Braces and pendants. 120, Horses. 121, Sheets. 122, Bowlines and bridles. 123, Buntlines. 124, Reef-tackles. 125, Cross-trees. 126, Cap.—127, *Main-top-gallant-mast*. 128, Shrouds and laniards. 129, Yard and fail. 130, Backstays. 131, Stay. 132, Stayfail and halliards. 133, Lifts. 134, Braces and pendants. 135, Bowlines and bridles. 136, Clew-lines. 137, Flagstaff. 138, Truck. 139, Flagstaff-stay. 140, Flag standard.—141, *Mizen-mast*. 142, Shrouds and laniards. 143, Cap. 144, Yard and fail. 145, Block for signal halliards. 146, Sheet. 147, Pendant lines. 148, Peck-brails. 149, Stayfail. 150, Stay. 151, Derrick and span. 152, Top. 153, Cross-jack-yard. 154, Cross-jack lifts. 155, Cross-jack braces. 156, Cross-jack slings.—157, *Mizen-top-mast*. 158, Shrouds and laniards. 159, Yard and fail. 160, Backstays. 161, Stay. 162, Halliards. 163, Lifts. 164, Braces and pendants. 165, Bowlines and bridles. 166, Sheets. 167, Clew-lines. 168, Stayfail. 169, Cross-trees. 170, Cap. 171, Flag-staff. 172, Flagstaff-stay. 173, Truck. 174, Flag, union. 175, Ensign-staff. 176, Truck. 177, Ensign. 178, Stern ladder. 179, Bower cable.

Fig. 2. Plate CCCCLI. is a vertical longitudinal section of a first rate ship of war, with references to the principal parts; which are as follow:

A, Is the head, containing,—1, The stem; 2, The knee of the head or cutwater; 3, The lower and upper cheek; 4, The trail-board; 5, The figure; 6, The gratings; 7, The brackets; 8, The false stem; 9, The breast hooks; 10, The haufe holes; 11, The bulkhead forward; 12, The cat-head; 13, The cat-hook; 14, Necessary seats; 15, The manger within board; 16, The bowsprit.

B, Upon the forecastle—17, The gratings; 18, The partners of the mast; 19, The gunwale; 20, The hel-fry; 21, The funnel for smoke; 22, The gangway going off the forecastle; 23, The forecastle guns.

C, In the forecastle—24, The door of the bulkhead forward; 25, Officers cabins; 26, Staircase; 27, Fore-top-sail sheet bits; 28, The beams; 29, The carlings.

D, The middle gundeck forward—30, The fore-jeer bits; 31, The oven and furnace of copper; 32, The captain's cook room; 33, The ladder or way to the forecastle.

E, The lower gun-deck forward—34, The knees fore and aft; 35, The spirketings, or the first streak next

to each deck, the next under the beams being called *clamps*; 36, The beams of the middle gun deck fore and aft; 37, The carlings of the middle gun-deck fore and aft; 38, The fore-bits; 39, The after or main bits; 40, The hatchway to the gunner's and boatfswain's store-rooms; 41, The jeer capstan.

F, The orlop—42, 43, 44, The gunner's, boatfswain's, and carpenter's store-rooms; 45, The beams of the lower gun-deck; 46, 47, The pillars and the riders, fore and aft; 48, The bulkhead of the store-rooms.

G, The hold—49, 50, 51, The foot-hook rider, the floor rider, and the standard, fore and aft; 52, The pillars; 53, The step of the foremast; 54, The kelson, or false keel, and dead rising; 55, The dead-wood.

H, At midships in the hold—56, The floor-timbers; 57, The keel; 58, The well; 59, The chain-pump; 60, The step of the mainmast; 61, 62, Beams and carlings of the orlop, fore and aft.

I, The orlop amidships—63, The cable tire; 64, The main hatchway.

K, The lower gun-deck amidships—65, The ladder leading up to the middle gun-deck; 66, The lower tire of ports.

L, The middle gun-deck amidship—67, The middle tire of ports; 68, The entering port; 69, The main jeer bits; 70, Twitted pillars or stanchions; 71, The capitan; 72, Gratings; 73, The ladder leading to the upper deck.

M, The upper gun-deck amidships—74, The maintop-sail-sheet bits; 75, The upper partners of the mainmast; 76, The gallows on which spare topmasts &c. are laid; 77, The foresheet blocks; 78, The remnets; 79, The gunwale; 80, The upper gratings; 81, The drift brackets; 82, The pifs dale; 83, The capstan pall.

N, Aft of the mainmast—84, The gangway off the quarterdeck; 85, The bulkhead of the coach; 86, The staircase down to the middle gun-deck; 87, The beams of the upper deck; 88, The gratings about the mainmast; 89, The coach or council-chamber; 90, The staircase up to the quarterdeck.

O, The quarterdeck—91, The beams; 92, The carlings; 93, The partners of the mizenmast; 94, The gangway up to the poop; 95, The bulkhead of the cuddy.

P, The poop—96, The trumpeter's cabin; 97, The tafforel.

Q, The captain's cabin.

R, The cuddy, usually divided for the master and secretary's officers.

S, The stateroom, out of which is made the bed-chamber and other conveniences for the commander in chief; 98, The entrance into the gallery; 99, The bulkhead of the great cabin; 100, The stern lights and after galleries.

T, The ward-room, allotted for the lieutenants and marine officers; 101, The lower gallery; 102, The steerage and bulkhead of the wardroom; 103, The whipstaff, commanding the tiller; 104, The after staircase leading down to the lower gun-deck.

V, Several officers cabins about the mainmast, where the soldiers generally keep guard.

W, The gun-room—105, The tiller commanding the rudder; 106, The rudder; 107, The stern-post; 108, The tiller-transom; 109, The several transoms, viz. 1, 2, 3, 4, 5; 110, The gun-room ports, or stern-chafe;

A FIRST RATE SHIP of WAR with Rigging &c. at Anchor.

Fig. 1.

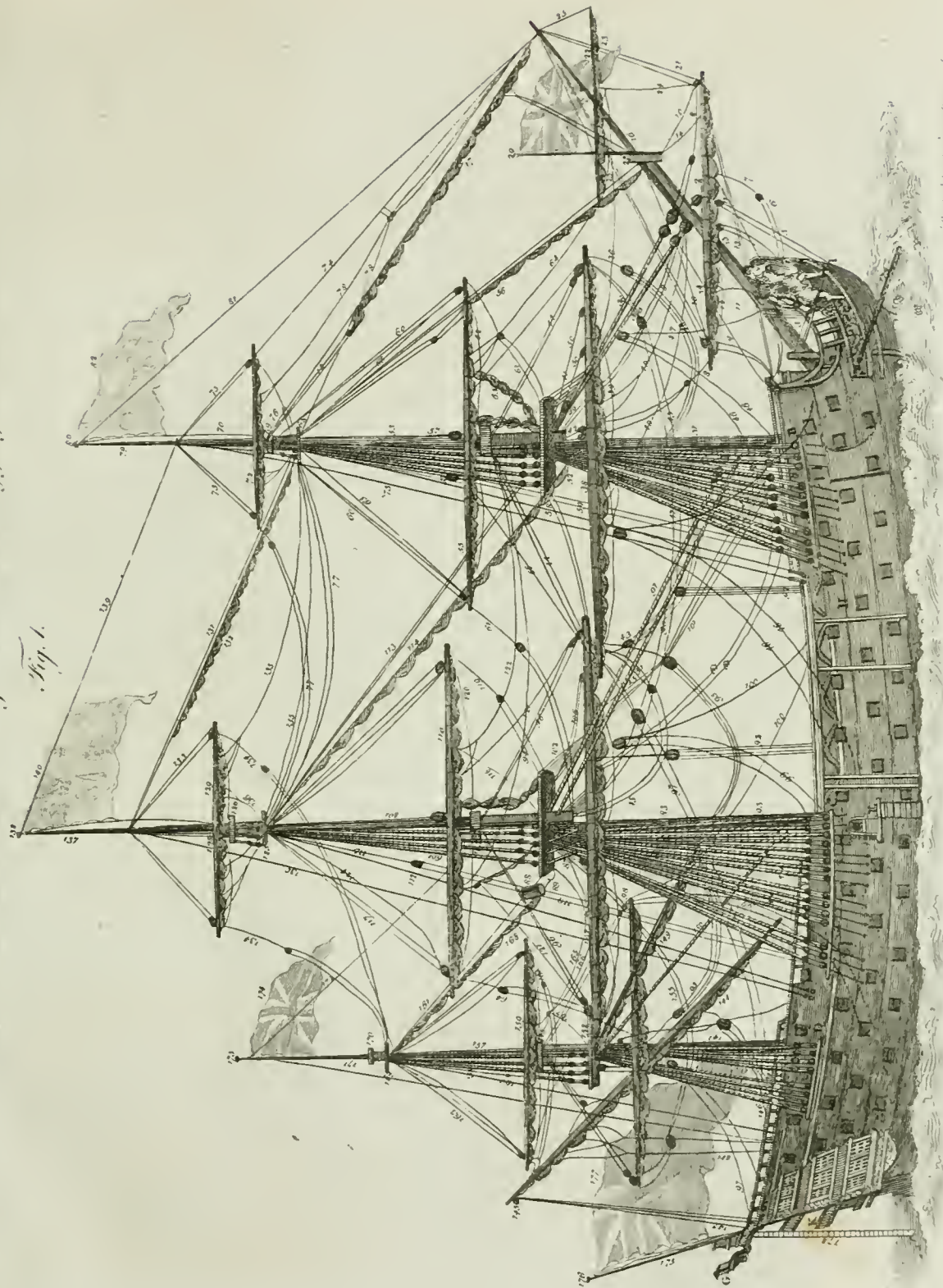

Albert D. N. S. Proprietor.





Fig. 1.

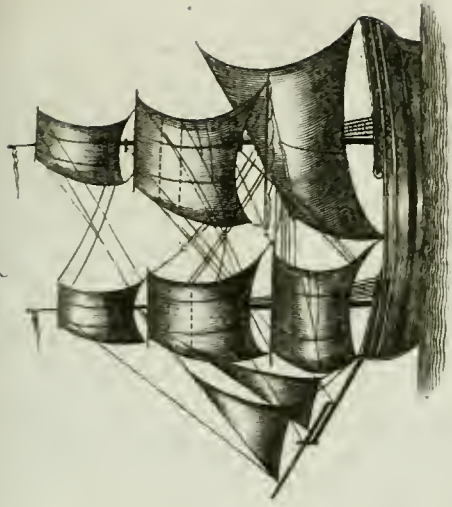
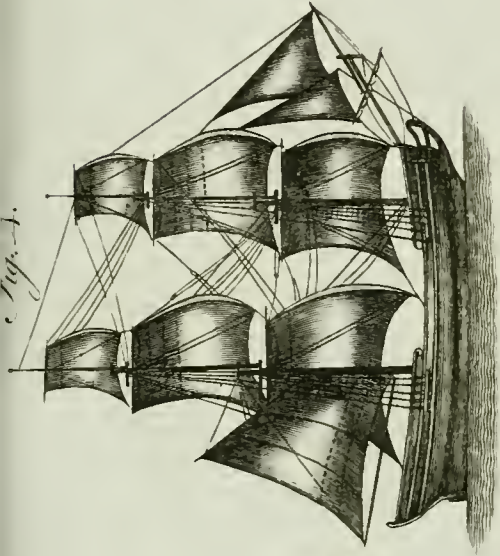
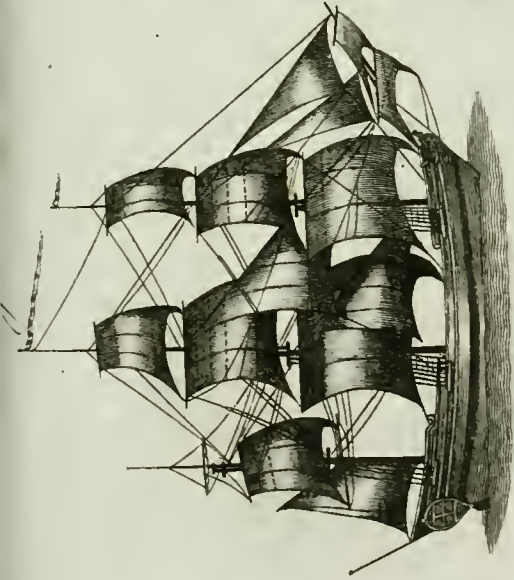
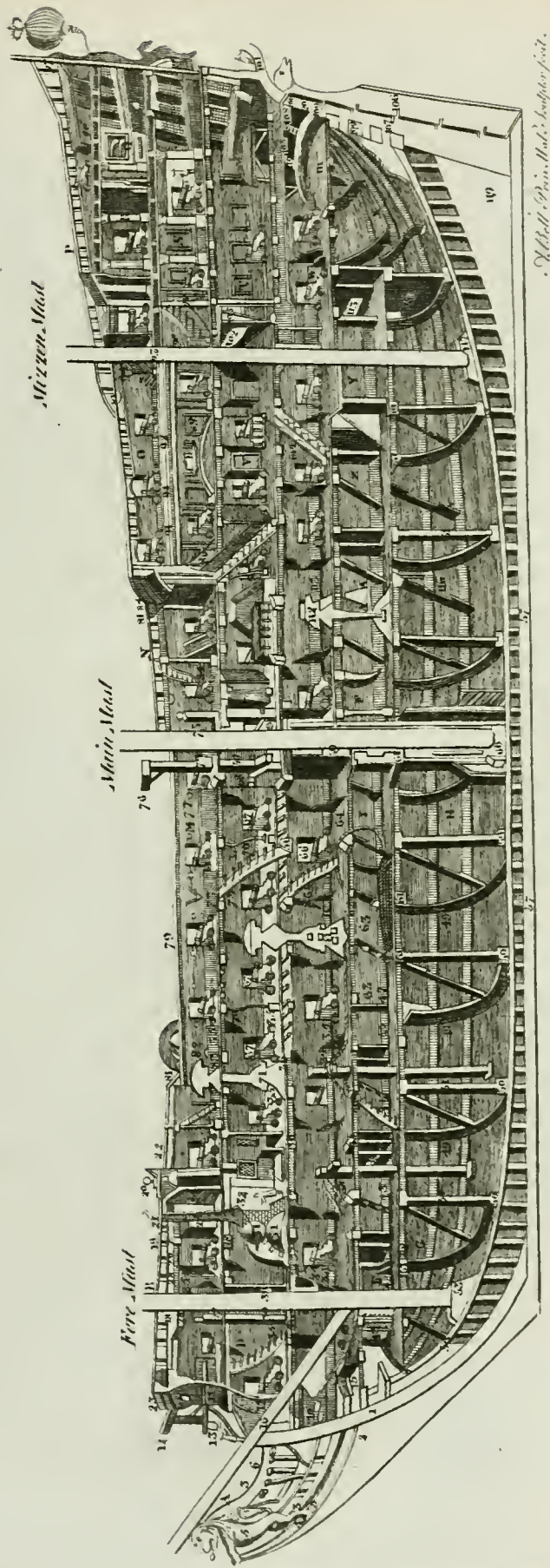
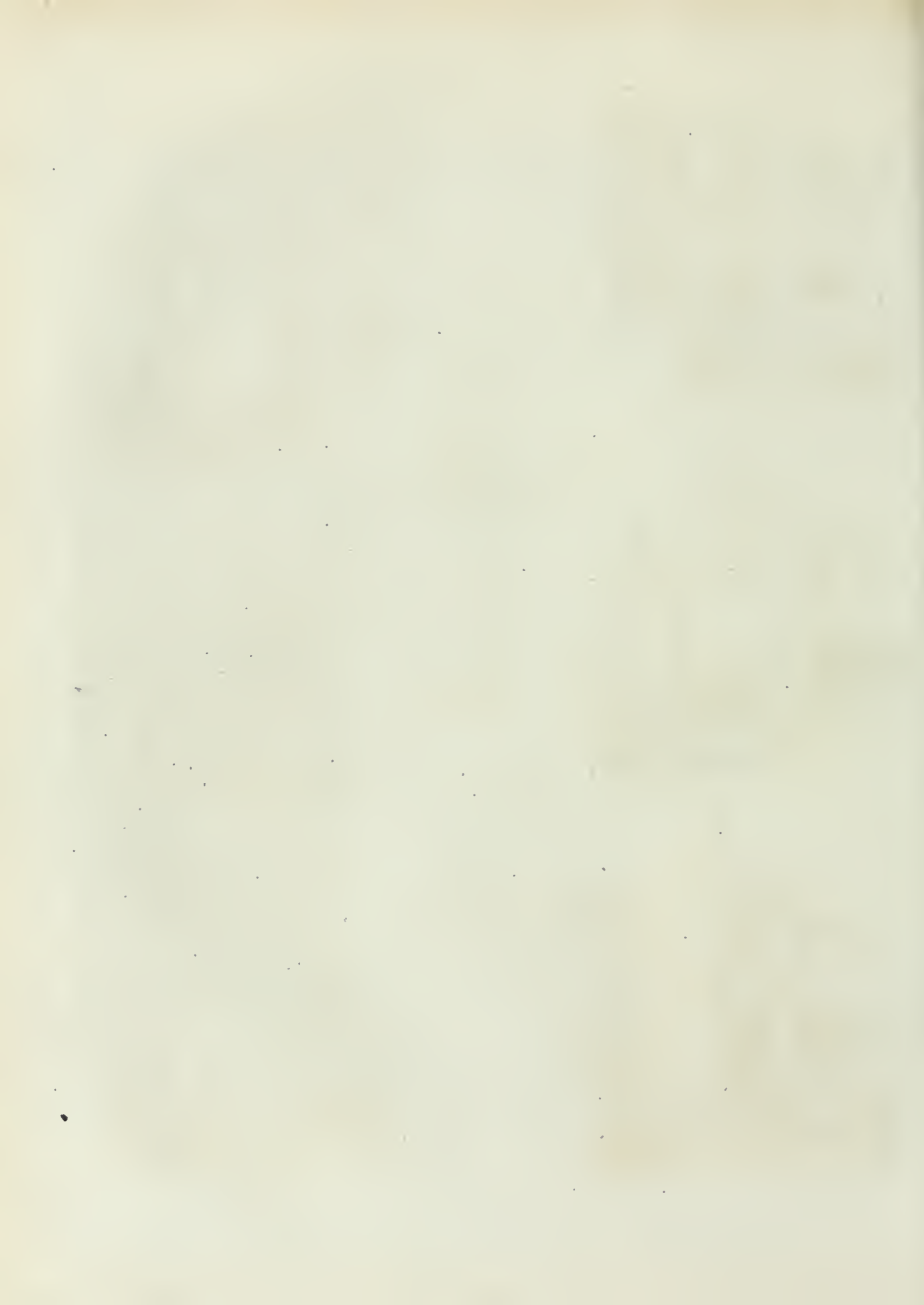

Fig. 2.

The Section of a First-Rate Ship of War, Shewing its various Timbers and Apartments.



W. Bell & Co. Print. & Lith. & Engr. & Co. London.



SHIP.

Plate CCCCLII.

*Fig. 8.*

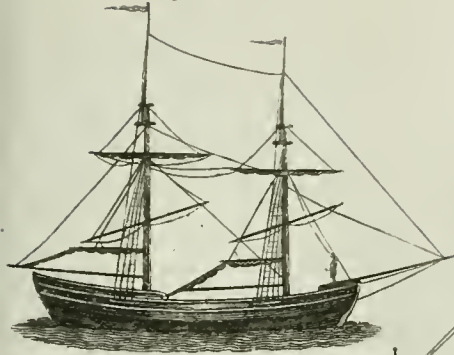

*Fig. 7.*



*Fig. 6.*

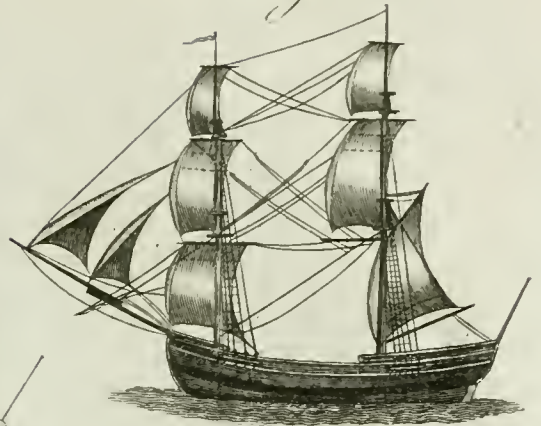

*Fig. 10.*



*Fig. 12.*



*Fig. 9.*



*Fig. 14.*



*Fig. 13.*

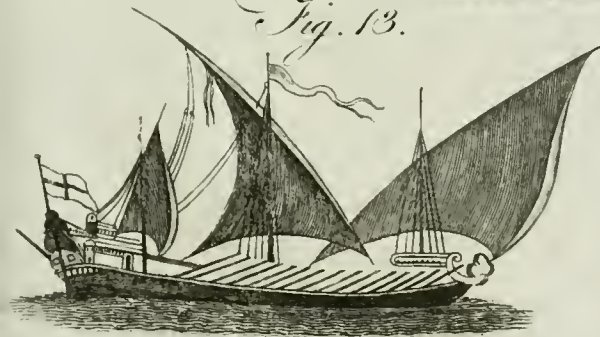

*Fig. 11.*

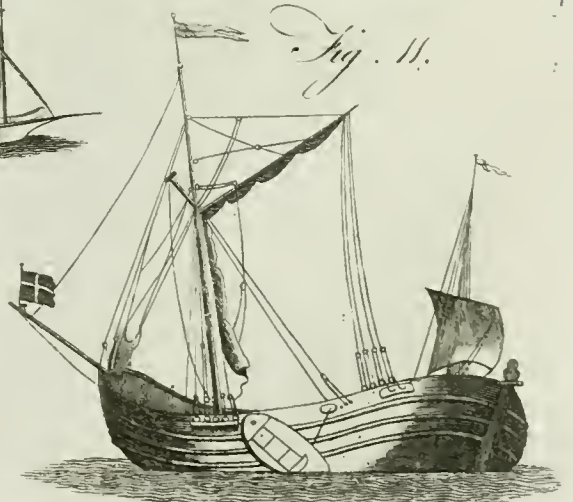

*W. Bell & Son, N. York, Sculptors, fecit.*





*Machine for drawing  
SHIP BOLTS.*

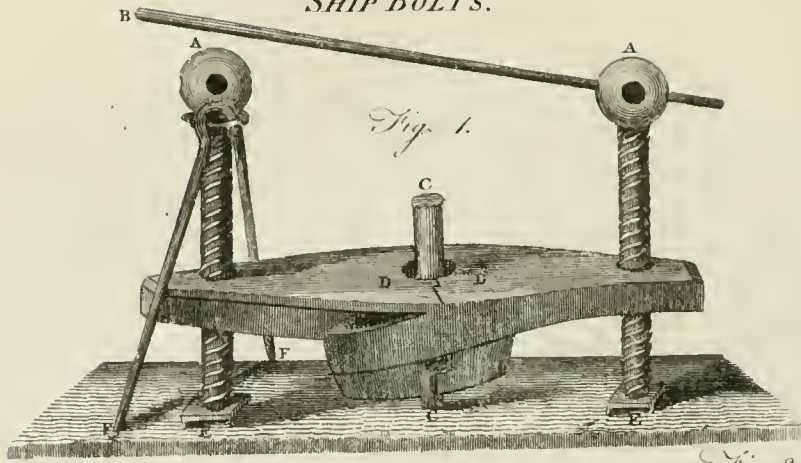

*Fig. 1.*

*Fig. 2.*



*Fig. 3.*



*Fig. 4.*

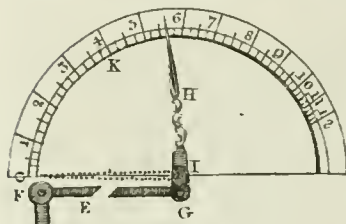
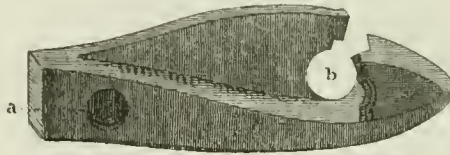

*Fig. 5.*



*Fig. 6.*



*Fig. 7.*

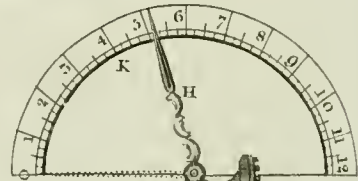
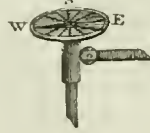

*Fig. 8.*

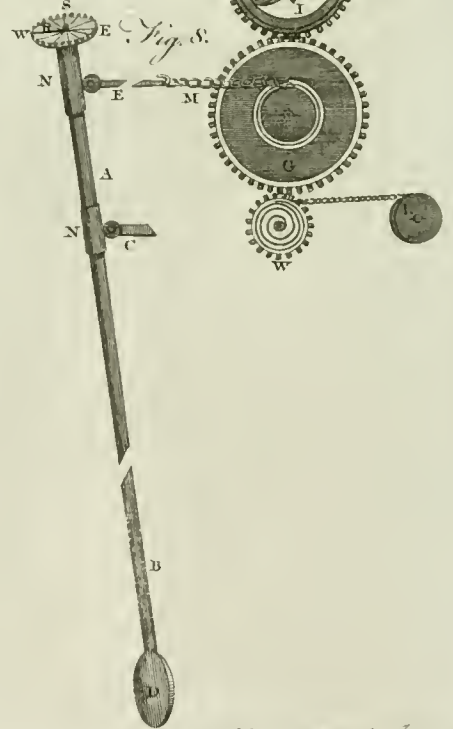

*Fig. 9.*

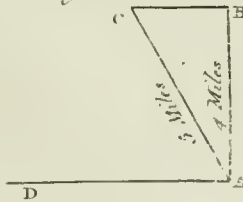

Ship. 111, The bread-room scuttle, out of the gun-room; 112, The main capstan; 113, The pall of the capstan; 114, The partner; 115, The bulkhead of the bread-room.

X, The bread-room.

Y, The steward's room, where all provisions are weighed and served out.

Z, The cockpit, where are subdivisions for the purser, the surgeon, and his mates.

AA, The platform or orlop, where provision is made for the wounded in the time of service; 116, The hold abaft the main-mast; 117, The step of the mizen-mast; 118, The kelson, or false keel; 119, The dead wood, or rifting.

Ships of war are fitted out either at the expence of the state or by individuals. Those fitted out at the public expence are called *King's ships*, and are divided into *ships of the line, frigates, sloops, &c.* For an account of each of these, see the respective articles. Ships of war fitted out by individuals are called *privateers*. See the article *PRIVATEER*.

*Armed-SHIP*. See *ARMED-SHIP*.

*Bomb-SHIP*. See *BOMB-Vessels*.

*Double-SHIP*. See *SHIP-Building*.

*Fire-SHIP*. See *FIRE-SHIP*.

*Hospital-SHIP*, a vessel fitted up to attend on a fleet of men of war, and receive their sick or wounded; for which purpose her decks should be high, and her ports sufficiently large. Her cables ought also to run upon the upper deck, to the end that the beds or cradles may be more commodiously placed between decks, and admit a free passage of the air to disperse that which is offensive or corrupted.

*Merchant-SHIP*, a vessel employed in commerce to carry commodities of various sorts from one port to another.

The largest merchant ships are those employed by the different companies of merchants who trade to the East Indies. They are in general larger than our 40 gun ships; and are commonly mounted with 20 guns on their upper-deck, which are nine pounders; and six on their quarter-deck, which are six pounders.

*Register-SHIP*. See *REGISTER-SHIP*.

*Store-SHIP*, a vessel employed to carry artillery or naval stores for the use of a fleet, fortrefs, or garrison.

*Transport-SHIP*, is generally used to conduct troops from one place to another.

Besides the different kinds of ships abovementioned, which are denominated from the purpose for which they are employed, vessels have also, in general, been named according to the different manner of rigging them. It would be an endless, and at the same time an unnecessary task, to enumerate all the different kinds of vessels with respect to their rigging; and therefore a few only are here taken notice of. Fig. 3. Plate CCCCLII. is a *ship* which would be converted into a *bark* by stripping the mizen mast of its yards and the sails belonging to them. If each mast, its corresponding topmast and topgallant-mast, instead of being composed of separate pieces of wood, were all of one continued piece, then this vessel with very little alteration would be a *polacre*. Fig. 4. represents a *snorv*; fig. 5. a *bilander*; fig. 6. a *brig*; fig. 7. a *ketch*; fig. 8. a *schooner*; fig. 9. a *fl-op*; fig. 10. a *zebec*; fig. 11. a *galliot*; fig. 12. a *dogger*; fig. 13. a *galley* under sail; fig. 14. ditto rowing.

Vol. XVII. Part I.

Ships are also sometimes named according to the different modes of their construction. Thus we say, a *cat-built ship, &c.*

To *SHIP*, is either used actively, as to embark any person or put any thing aboard ship; or passively, to receive any thing into a ship; as, "we shipped a heavy sea at three o'clock in the morning."

To *SHIP*, also implies to fix any thing in its place; as, to ship the oars, that is, to put them in their rowlocks; to ship the swivel guns, is to fix them in their sockets; to ship the handspokes, &c.

*Machine for drawing Bolts out of SHIPS*, an instrument invented by Mr William Hill for this purpose. His account of which is as follows\*.

"First, The use of this machine is to draw the kelson and dead wood bolts out, and to draw the knee of the head bolts.—Secondly, The heads of the kelson bolts heretofore were all obliged to be driven thro' the kelson floor-timbers, and keel, to get them out: by this means the kelson is often entirely destroyed, and the large hole the head makes materially wounds the floors; and frequently, when the bolt is much corroded, it scars, and the bolt comes out of the side of the keel.—Thirdly, The dead-wood bolts that are driven with two or three drifts, are seldom or never got out, by which means the dead-wood is condemned, when some of it is really serviceable.—Fourthly, In drawing the knee of the head-bolts, sometimes the knee starts off, and cannot be got to again, but furs up, and with this machine may be drawn in; for it has been proved to have more power in starting a bolt than the maul."

In fig. 1. "A, A, represent two strong male screws, working in female screws near the extremities of the cheeks, against plates of iron E, E. C C is the bolt to be drawn: which, being held between the chaps of the machine at DD, is, by turning the screws by the lever B, forced upwards out of the wood or plank of the ship. F, F, are two dogs, with hooks at their lower extremities; which, being driven into the plank, serve to support the machine till the chaps have got fast hold of the bolt. At the upper part of these dogs are rings passing thro' holes in a collar, moveable near the heads of the screws. Fig. 2. is a view of the upper side of the cheeks when joined together; a, a, the holes in which the screws work; b, the chaps by which the bolts are drawn. Fig. 3. The under side of the cheek: a, a, the holes in which the screws work; b, the chaps by which the bolts are drawn, and where the teeth that gripe the bolt are more distinctly shown. Fig. 4. One of the cheeks separated from the other, the letters referring as in fig. 2. and 3.

This machine was tried in his majesty's yard at Deptford, and was found of the greatest utility.—"First, it drew a bolt that was driven down so tight as only to go one inch in sixteen blows with a double-headed maul, and was well clenched below: the bolt drew the ring a considerable way into the wood, and wire drew itself through, and left the ring behind. Secondly, it drew a bolt out of the Venus's dead-wood that could not be got out by the maul. That part of it which went through the keel was bent close up to the lower part of the dead-wood, and the machine drew the bolt straight, and drew it out with ease. It also drew a kelson bolt out of the Stanley West Indiaman, in Messrs Wells's yard, Deptford; which being a bolt of two drifts, could not be driven out.

Ship.

*Management of Ships at single anchor*, is the method of taking care of a ship while riding at single anchor in a tide-way, by preventing her from fouling her anchor, &c. The following rules for this purpose, with which we have been favoured by Mr Henry Taylor\* of North Shields, will be found of the utmost consequence.

keep it standing until it shakes; then brace all the yards sharp forward, especially if it is likely to blow strong.

If laying in the aforesaid position, and she breaks her sheer, brace about the main-yard immediately; if she recovers and brings the buoy on the lee or larboard quarter, let the main-yard be again braced about; but if she come to a sheer the other way, by bringing the buoy on the other quarter, change the helm and brace the fore-yard to.

Riding leeward tide with more cable than the windward service, and expecting the ship will go to windward of her anchor, begin as soon as the tide eales to shorten in the cable. This is often hard work; but it is necessary to be done, otherwise the anchor may be fouled by the great length of cable the ship has to draw round; but even if that could be done, the cable would be damaged against the bows or cut-water. It is to be observed, that when a ship rides windward tide the cable should be cackled from the short service towards the anchor, as far as will prevent the bare part touching the ship.

When the ship tends to windward and must be set ahead, hoist the fore-stay-fail as soon as it will stand, and when the buoy comes on the lee-quarter, haul down the fore-stay-fail, brace to the fore-yard, and put the helm a-lee; for till then the helm must be kept a-weather and the yards full.

When the ship rides leeward tide, and the wind increases, care should be taken to give her more cable in time, otherwise the anchor may start, and probably it will be troublesome to get her brought up again; and this care is the more necessary when the ship rides in the haufe of another ship. Previous to giving a long service it is usual to take a weather-bit, that is, a turn of the cable over the windlass end, so that in veering away the ship will be under command. The service ought to be greased, which will prevent its chafing in the haufe.

If the gale continues to increase, the topmasts should be struck in time; but the fore-yard should seldom, if ever, be lowered down, that in case of parting the fore-fail may be ready to be set. At such times there should be more on deck than the common anchor-watch, that no accident may happen from inattention or falling asleep.

In a tide-way a second anchor should never be let go but when absolutely necessary; for a ship will sometimes ride easier and safer, especially if the sea runs high, with a very long scope of cable and one anchor, than with

7

lefs

(A) It has been thought by some theorists, that ships should be sheered to leeward of their anchors; but experience and the common practice of the best informed seamen are against that opinion: for it is found, that when a ship rides leeward tide and sheered to windward, with the helm two or three points upon the bow, and blowing hard in the interval between the squalls, the sheer will draw her towards the wind's eye; so that when the next squall comes, before she be pressed astream of her anchor, it is probable there will be a lull again, and the spring which the cable got by the sheer will greatly ease it during the squall.

Every seaman knows that no ship without a rudder, or the helm left loose, will wear; they always in such situations fly to: this proves that the wind pressing upon the quarter and the helm alee, a ship will be less liable to break her sheer than when the helm is a-weather. Besides, if the helm is a-lee when she breaks her sheer, it will be a-weather when the wind comes on the other quarter, as it ought to be until she either swing to leeward, or bring the buoy on the other quarter. Now if the ship breaks her sheer with the helm a-weather, it throws her head to the wind so suddenly as scarce to give time to brace the yards about, and very probably she will fall over her anchor before the fore-stay-fail can be got up.

\* Taylor's Instructions to Young Mariners Riding at Anchor in moderate Weather.

1 When the ship will back.

2 How the yards ought to be braced.

3 Riding windward tide in danger of breaking her sheer.

4 Tending to leeward when the ship must be set ahead.

Ship.

5 How to manage when the ship breaks her sheer.

6 When a long service is out and the ship is likely to go to windward.

7 How to manage in a storm.



hips. lefs length and two cables; however, it is advifable, as a preventive, when fhips have not room to drive, and the night is dark, to let fall a fecond anchor under foot, with a range of cable along the deck. It this is not thought neceffary to be done, the deep-fea lead fhould be thrown overboard, and the line frequently handled by the watch, that they may be affured the rides fail.

8  
ion  
ding  
chor  
h.  
If at any time the anchor-watch, prefuming on their own knowledge, fhould wind the fhip, or fuffer her to break her fheer without calling the mate, he fhould immediately, or the very firft opportunity, oblige the crew to heave the anchor in fight; which will prevent the commiffion of the like fault again; for befides the fhare of trouble the watch will have, the reft of the crew will blame them for neglecting their duty.

9  
p-ri-  
duty  
e chief  
Prudent mates feldom lie a week in a road-ftead without heaving their anchor in fight; even though they have not the leaft fufpicion of its being foul. There are other reafons why the anchor fhould be looked at; fometimes the cable receives damage by fweeping wrecks or anchors that have been loft, or from rocks or ftones; and it is often neceffary to trip the anchor, in order to take a clearer birth, which fhould be done as often as any fhip brings up too near.

*Method for the safe removal of fuch Snares as have been driven on fhore.* For this purpofe empty casks are ufually employed to float off the vefTel, efpecially if the is fmall, and at the fame time near the port to which it is propofed to conduct her. In other cafes, the following method adopted by Mr Barnard \* will answer.

10  
ofophi-  
r and  
r,  
ax.  
1.  
“ On January 1. 1779 (fays Mr Barnard), in a moft dreadful ftorm, the York Eaft In liaman, of eight hundred tons, homeward bound, with a pepper cargo, parted her cables in Margate roads, and was driven on fhore, within one hundred feet of the head and thirty feet of the fide of Margate pier, then drawing twenty-two feet fix inches water, the flow of a good fpring tide being only fourteen feet at that place.

“ On the third of the fame month I went down, as a fhip-builder, to affift, as much as lay in my power, my worthy friend Sir Richard Hotham, to whom the fhip belonged. I found her perfectly upright, and her ftern (or fide appearance) the fame as when firft built, but funk to the twelve feet water-mark fore and aft in a bed of chalk mixed with a ftiff blue clay, exactly the fhape of her body below that draft of water; and from the rudder being torn from her as fhe ftruck coming on fhore, and the violent agitation of the fea after her being there, her ftern was fo greatly injured as to admit free accefs thereto, which filled her for four days equal to the flow of the tide. Having fully informed myfelf of her fituation and the flow of fpring-tides, and being clearly of opinion fhe might be again got off, I recommended, as the firft neceffary ftep, the immediate difcharge of the cargo; and, in the progress of that bufinefs, I found the tide always flowed to the fame height on the fhip; and when the cargo was half difcharged, and I knew the remaining part fhould not make her draw more than eighteen feet water, and while I was obferving the water at twenty-two feet fix inches by the fhip’s marks, fhe infantly lifted to feventeen feet eight inches; the water and air being before excluded by her prefure on the clay, and the atmosphere acting upon her upper part equal to fix hundred tons, which is the

weight of water difplaced at the difference of thefe two drafts of water.

Ship.

“ The moment the fhip lifted, I difcovered fhe had received more damage than was at firft apprehended, her leaks being fuch as filled her from four to eighteen feet water in an hour and a half. As nothing effectual was to be expected from pumping, feveral fcuttles or holes in the fhip’s fide were made, and valves fixed thereto, to draw off the water at the loweft ebb of the tide, to facilitate the difcharge of the remaining part of the cargo; and, after many attempts, I fucceeded in an external application of fheep-fkins fewed on a fail and thruft under the bottom, to flop the body of water from ruftling fo furioufly into the fhip. This bufinefs effected, moderate pumping enabled us to keep the fhip to about fix feet water at low water, and by a vigorous effort we could bring the fhip fo light as (when the cargo fhould be all difcharged) to be eafily removed into deeper water. But as the external application might be difturbed by fo doing, or totally removed by the agitation of the fhip, it was abfolutely neceffary to provide fome permanent fecurity for the lives of thofe who were to navigate her to the river Thames. I then recommended as the cheapelt, quickeft, and moft effectual plan, to lay a deck in the hold, as low as the water could be pumped to, framed fo folidly and fe curely, and caulked fo tight, as to fwim the fhip independent of her own leaky bottom.

“ Beams of fir-timber twelve inches fquare were placed in the hold under every lower-deck beam in the fhip, as low as the water would permit; thefe were in two pieces, for the conveniency of getting them down, and alfo for the better fixing them of an exact length, and well bolted to ether when in their places. Over thefe were laid long Dantzic deals of two inches and an half thick, well nailed and caulked. Againft the fhip’s fide, all fore and aft, was well nailed a piece of fir twelve inches broad and fix inches thick on the lower and three inches on the upper edge, to prevent the deck from rifing at the fide. Over the deck, at every beam, was laid a crofs piece of fir timber fix inches deep and twelve inches broad, reaching from the pillar of the hold to the fhip’s fide, on which the fhores were to be placed to refift the prefure of the water beneath. On each of thefe, and againft the lower-deck beam, at equal diftances from the fide and middle of the fhip, was placed an upright fhore, fix inches by twelve, the lower end let two inches into the crofs piece. From the foot of this fhore to the fhip’s fide, under the end of every lower deck beam, was placed a diagonal fhore fix inches by twelve, to eafe the fhip’s deck of part of the ftain by throwing it on the fide. An upright fhore of three inches by twelve was placed from the end of every crofs piece to the lower deck beams at the fide, and one of three inches by twelve on the midfhip end of every crofs piece to the lower deck beam, and nailed to the pillars in the hold. Two firm tight bulkheads or partitions were made as near the extremes of the fhip as poffible. The ceiling or infide plank of the fhip was very fecurely caulked up to the lower deck, and the whole formed a complete fhip with a flat bottom within fide, to fwim the outside leaky one; and that bottom being deprefed fix feet below the external water, refifted the fhip’s weight above it equal to five hundred and eighty-one tons, and fafely conveyed her to the dry-dock at Deptford.”

## S H I P - B U I L D I N G .

1  
Definition.

**S**HIP-BUILDING, or NAVAL ARCHITECTURE, is the art of constructing a ship so as to answer a particular purpose either of war or merchandize.

2  
History.

To whom the world is indebted for the invention of ships, is, like all other things of equal antiquity, uncertain.

A very small portion of art or contrivance was seen in the first ships: they were neither strong nor durable; but consisted only of a few planks laid together, without beauty or ornament, and just so compacted as to keep out the water. In some places they were only the hulks or stocks of trees hollowed, and then consisted only of one piece of timber. Nor was wood alone applied to this use; but any other buoyant materials, as the Egyptian reed papyrus; or leather, of which the primitive ships were frequently composed; the bottom and sides being extended on a frame of thin battens or scantlings, of flexible wood, or begirt with wickers, such as we have frequently beheld amongst the American savages. In this manner they were often navigated upon the rivers of Ethiopia, Egypt, and Sabæan Arabia, even in latter times. But in the first of them, we find no mention of any thing but leather or hides sewed together. In a vessel of this kind, Dardanus secured his retreat to the country afterwards called *Troas*, when he was compelled by a terrible deluge to forsake his former habitation of Samothrace. According to Virgil, Chæon's infernal boat was of the same composition.

But as the other arts extended their influence, naval architecture likewise began to emerge from the gloom of ignorance and barbarism; and as the ships of those ages were increased in bulk, and better proportioned for commerce, the appearance of those floating citadels of unusual form, full of living men, flying with seemingly expanded wings over the surface of the untravelled ocean, struck the ignorant people with terror and astonishment; and hence, as we are told by Aristophanes, arose the fable of Perseus flying to the Gorgons, who was actually carried thither in a ship! Hence, in all probability, the famous story of Triptolemus riding on a winged dragon is deduced, only because he sailed from Athens, in the time of a great dearth, to a more plentiful country, to supply the necessities of his people. The fiction of the flying horse Pegasus may be joined with these, who, as several mythologists report, was nothing but a ship with sails, and thence said to be the offspring of Neptune the sovereign of the sea; nor does there appear any other foundation for the stories of griffins, or of ships transformed into birds and fishes, which we so often meet with in the ancient poets. So acceptable to the first ages of the world were inventions of this nature, that whoever made any improvements in navigation or naval architecture, building new ships better fitted for strength or swiftness than those used before, or rendered the old more commodious by additional contrivances, or discovered countries unknown to former travellers, were thought worthy of the greatest honours, and often associated into the number of their deified heroes. Hence we have in astronomy the signs of Aries and Taurus, which were no other than two ships: the former trans-

ported Phryxus from Greece to Colchos, and the latter Europa from Phœnicia to Crete. Argo, Pegasus, and Perseus, were likewise new ships of a different sort from the former, which being greatly admired by the barbarous and uninstructed people of those times, were translated amongst the stars, in commemoration of their inventors, and metamorphosed into constellations by the poets of their own and of succeeding ages.

The chief parts, of which ships anciently consisted, were three, viz. the belly, the prow, and the stern: these were again composed of other smaller parts, which shall be briefly described in their order. In the description, we chiefly follow Schæfer, who hath so copiously treated this subject, and with such industry and learning collected whatever is necessary to illustrate it, that very little room is left for enlargement by those who incline to pursue this investigation.

1. In the belly, or middle part of the ship, there was *τροπισ*, *carina*, or the "keel," which was composed of wood: it was placed at the bottom of the ship, being designed to cut and glide through the waves, and therefore was not broad, but narrow and sharp; whence it may be perceived that not all ships, but only the *μαριραι*, which ships of war were called, whose bellies were straight and of a small circumference, were provided with keels, the rest having usually flat bottoms. Around the outside of the keel were fixed pieces of wood, to prevent it from being damaged when the ship was first launched into the water, or afterwards struck on any rocks; these were called *χιλισματα*, in Latin *cunei*.

Next to the keel was *φαλλικς*, the "pump-well, or well room," within which was contained the *ανταλιον*, or "pump;" through which water was conveyed out of the ship.

After this, there was *δευτερα τροπισ*, or the "second keel," somewhat resembling what is now called the *keelson*; it was placed beneath the pump, and called *λιθειν*, *χαλωννι*, *κλιτισσοδεν*: by some it is falsely supposed to be the same with *φαλλικς*.

Above the pump was an hollow place, called by Herodotus *κοιλη της ντρος*, by Pollux *κυτος* and *γατρα*, because large and capacious, after the form of a belly; by the Latins, *testudo*. This was formed by crooked ribs, with which it was surrounded, which were pieces of wood rising from the keel upwards, and called by Hesychius *νγκις*, and by others, *εγκοιλια*, the belly of the ship being contained within them: in Latin, *costæ*; and in English, *timbers*. Upon these were placed certain planks, which Aristophanes calls *εντερωειας*, or *εντερωιδæ*.

The *πλευραι*, *lateræ*, or "sides" of the ship, encompassed all the former parts on both hands; these were composed of large rafters extended from prow to stern, and called *ζωστρος*, and *ζωμιαματα*, because by them the whole fabric was begirt or surrounded.

In both these sides the rowers had their places, called *τοιχοι* and *εβωλια*, in Latin *fori* and *transstra*, placed above one another; the lowest was called *θαλαμος*, and those that laboured therein *θαλαμοι* the middle, *ζυγα*, and the men *ζυγοι*; the uppermost *ερανοι*, whence the rowers

History.

History.

owers were termed ἄραιται. In these apartments were spaces through which the rowers put their oars; these were sometimes one continued vacuity from one end to the other, called τραιεῖς, but more usually distinct holes, each of which was designed for a single oar; these were styled τρημαίη, τρημαίηατα, as also ὀφθαλμοί, because not unlike the eyes of living creatures. All of them were by a more general name termed ὄφθαλα, from containing the oars; but ὀφθαλμοί seems to have been another thing, signifying the spaces between the banks of oars on each side, where the passengers appear to have been placed. On the top of all there was a passage or place to walk, called παρὰδεις, and παρὰδεις, as joining to the ἄραιται, or uppermost bank of oars.

2. Πρῶον, the "prow or fore-deck," whence it is sometimes called μετώπῳ, and commonly distinguished by other metaphorical titles taken from human faces. In some ships there is mention of two prows, as also two sterns; such was Danaus's ship adorned by Minerva when he fled from Egypt. It was usual to beautify the prow with gold and various sorts of paint and colours; in the primitive times red was most in use; whence Homer's ships were commonly dignified with the titles of μελιτοπαροῖ, and τοῖμοπαροῖ, or "red faced;" the blue likewise, or ilky-colour, was frequently made use of, as bearing a near resemblance to the colour of the sea; whence we find ships called by Homer κυανοπαροῖ, by Aristophanes κυανοβουλι. Several other colours were also made use of; nor were they barely varnished over with them, but very often annealed by wax melted in the fire, so as neither the sun, winds, nor water, were able to deface them. The art of doing this was called from the wax κρηγορατισσ, from the fire ἑκαυσιν, which is described by Vitruvius, and mentioned in Ovid.

————— *Pisa coloribus uestis*  
*Ceruleam matrem concava puppis habet.*

The painted ship with melted wax anneal'd  
Had Pethys for its deity—————

In these colours the various forms of gods, animals, plants, &c. were usually drawn, which were likewise often added as ornaments to other parts of the ships, as plainly appears from the ancient monuments presented to the world by Baysius.

The sides of the prow were termed πτερά, or "wings," and πτερο, according to Scheffer, or rather πτεραι; for since the prow is commonly compared to a human face, it will naturally follow that the sides should be called cheeks. These are now called βόωα by our mariners.

3. Περύσσον, "the hind-deck or poop," sometimes called ὄπισθον, the "tail," because the hindmost part of the ship; it was of a figure more inclining to round than the prow, the extremity of which was sharp, that it might cut the waters; it was also built higher than the prow, and was the place where the pilot sat to steer; the outer-bending part of it was called πτερύσσον, answering to our term quarter.

They had various ornaments of sculpture on the prow; as helmets, animals, triumphal wreaths, &c.—The stern was more particularly adorned with wings, shields, &c. Sometimes a little mast was erected whereon to hang ribbands of divers colours, which served instead of a flag to distinguish the ship; and a weather-cock, to signify the part from whence the wind blew,

On the extremity of the prow was placed a round piece of wood, called the ὀφθαλμῶν, from its bending; and sometimes ὀφθαλμοῦ, the "eye" of the ship, because fixed in the fore-deck; on this was inscribed the name of the ship, which was usually taken from the figure painted on the flag. Hence comes the frequent mention of ships called *Pegasi, Scyllæ, bulls, rams, tigers*, &c. which the poets took the liberty to represent as living creatures that transported their riders from one country to another.

The whole fabric being completed, it was fortified with pitch, and sometimes a mixture of rosin, to secure the wood from the waters; whence it comes that Homer's ships are everywhere mentioned with the epithet of μελαίναι, or "black." The first that made use of pitch were the inhabitants of Phœacia, since called Corsica; sometimes wax was employed in the same use; whence Ovid,

*Ceruleæ ceratas accipit unda rates.*

The azure waves receive the waxed ships.

After all, the ship being bedecked with garlands and flowers, the mariners also adorned with crowns, she was launched into the sea with loud acclamations and other expressions of joy; and being purified by a priest with a lighted torch, an egg and brimstone, or after some other manner, was consecrated to the god whose image she bore.

The ships of war of the ancients were distinguished from other kinds of vessels by various turrets and accessions of building, some to defend their own soldiers, and others to annoy the enemy; and from one another, in latter ages, by several degrees or ranks of oars, the most usual number of which was four or five, which appear not to have been arranged, as some imagine, on the same level in different parts of the ship; nor yet, as others have supposed, directly above one another's heads; but their seats being placed one behind another, ascended gradually, like stairs. Ptolemy Philopater, urged by a vain-glorious desire of exceeding all the world besides in naval architecture, is said to have farther enlarged the number of banks to 40; and the ship being otherwise in equal proportion, this raised her to such an enormous bulk, that she appeared at a distance like a floating mountain or island; and, upon a nearer view, like a prodigious castle on the ocean. She was 280 cubits long, 38 broad, and 48 high (each cubit being 1 English foot 5 1/2 inches), and carried 400 rowers, 400 sailors, and 3000 soldiers. Another which the same prince made to sail on the Nile, we are told, was half a stadium long. Yet these were nothing in comparison of Hiero's ship, built under the direction of Archimedes; on the structure whereof Moschion wrote a whole volume. There was wood enough employed in it to make 50 galleys; it had all the variety of apartments of a palace; such as banqueting-rooms, galleries, gardens, fish-ponds, stables, mills, baths, and a temple to Venus. The floors of the middle apartment were all inlaid, and represented in various colours the stories of Homer's Iliad. The ceilings, windows, and all other parts, were finished with wonderful art, and embellished with all kinds of ornaments. In the uppermost apartment there was a spacious gymnasium, or place for exercise, and water was conveyed to the garden by pipes, some

some of hardened clay, and others of lead. The floors of the temple of Venus were inlaid with agates and other precious stones; the inside lined with cypress wood; the windows adorned with ivory paintings and small statues. There was likewise a library. This vessel was adorned on all sides with fine paintings. It had 20 benches of oars, and was encompassed with an iron rampart, eight towers, with walls and bulwarks, furnished with machines of war, particularly one which threw a stone of 300 pounds, or a dart 12 cubits long, the space of half a mile, with many other particulars related by Athenæus. Caligula likewise built a vessel adorned with jewels in the poop, with sails of many colours, and furnished with large porticoes, bagnios, and banqueting-rooms, besides rows of vines, and fruit-trees of various kinds. But these, and all such monstrous fabrics, served only for show and ostentation, being rendered by their vast bulk unwieldy and unfit for service. Athenæus informs us, the common names they were known by, were *Cyclads*, or *Æina*, i. e. "islands, or mountains," to which they seemed nearly equal in bigness; consisting, as some report, of as many materials as would have composed 50 triremes, or ships of three banks.

The vessels employed by the northern nations appear to have been still more imperfect than those of the Romans; for a law was enacted in the reign of the emperor Honorius, 24th September, A. D. 418, inflicting capital punishment on any who should instruct the barbarians in the art of ship-building; a proof at once of the great estimation in which this science was then held, and of the ignorance of the barbarians with regard to it.

The fleet of Richard I. of England, when he weighed anchor for the holy war from Messina, in Sicily, where he had passed the winter, A. D. 1190-1, is said to have consisted of 150 great ships and 53 galleys, besides barks, tartans, &c. What kinds of ships these were is not mentioned. To the crusades, however pernicious in other respects, this science seems to owe some improvements; and to this particular one we are indebted for Richard's marine code, commonly called the *Laws of Oleron*, from the name of a small island on the coast of France, where he composed them, and which most of the nations in Europe have made the basis of their maritime regulations. Those ships, if they merited the name of ships, were probably very small, as we find that so long after as the time of Edward I. anno 1304, 40 men were deemed sufficient to man the best and largest vessels in England; and that Edward the Third, anno 1335, ordained the mayor and sheriffs of London to "take up all ships in their port, and all other ports in the kingdom, of the burden of 40 tons and upwards, and to furnish the same with armed men and other necessaries of war, against the Scots his enemies, confederated with certain persons of foreign nations." Edward the Third's fleet before Calais, anno 1347, consisted of 738 English ships, carrying 14,956 mariners, being on an average but 20 men to each ship; 15 ships and 459 mariners, from Bayonne in Guienne, being 30 men to each ship; 7 ships and 184 men from Spain, which is 26 men to each ship; one from Ireland, carrying 25 men; 14 from Flanders, with 133 men,

being scarcely 10 men to each ship; and one from Guelderland, with 24 mariners. Fifteen of these were called the king's own ships, manned with 419 mariners, being somewhat under 17 to each ship.

Historians represent the vessels of Venice and Genoa as the largest and the best about this time, but they were soon exceeded in size by the Spanish vessels called *carriacks*, some of which carried cannon; and these again were exceeded by the vessels built by the northern people, particularly those belonging to the Hanse-towns.— In the 14th century, the Hanseatics were the sovereigns of the northern seas, as well without as within the Baltic; and their ships were so large, that foreign princes often hired them in their wars. According to Hakluyt, an English ship from Newcastle, of 200 tons burden, was seized in the Baltic by those of Wismar and Roslock, anno 1394; and another English vessel of the same burden was violently seized in the port of Lisbon, anno 1412.

Soon after ships of a much larger size were constructed. It is mentioned that a very large ship was built, anno 1449, by John Taverner of Hull; and in the year 1455, king Henry IV. at the request of Charles king of Sweden, granted a licence for a Swedish ship of the burden of a thousand tons or under, laden with merchandize, and having 120 persons on board, to come to the ports of England, there to dispose of their lading, and to relate back with English merchandize, paying the usual customs. The inscription on the tomb of William Canning, an eminent merchant, who had been five times mayor of Bristol, in Ratcliff-church at Bristol, anno 1474, mentions his having forfeited the king's peace, for which he was condemned to pay 300 merks; in lieu of which sum, king Edward IV. took of him 2470 tons of shipping, amongst which there was one ship of 900 tons burden, another of 500 tons, and one of 400 tons, the rest being smaller.

In the year 1506, king James IV. of Scotland built the largest ship which had hitherto been seen, but which was lost in her way to France in the year 1512, owing probably to a defective construction, and the unskillfulness of the crew in managing so large a ship.— About this time a very large ship was likewise built in France. In the fleet fitted out by Henry VIII. anno 1512, there was one ship, the Regent, of 1000 tons burden, one of 500, and three of 400 each. A ship still larger than the Regent was built soon after, called *Henri Grace Dieu*! In the year 1522 the first voyage round the globe was finished.

The English naval historians think that ships carried cannon on their upper decks only, and had not gun-ports before the year 1545: and it is certain that many of the largest ships in former times were fitted out from harbours, where ships of a moderate size now would not have water enough to float them. In 1575 the whole of the royal navy did not exceed 24 ships, and the number of merchant ships belonging to England amounted to no more than 135 vessels above 100 tons, and 656 between 40 and 100 tons. At queen Elizabeth's death, anno 1603, there were not above four merchant-ships in England of 400 tons burden each.— The largest of queen Elizabeth's ships of war was 1000 tons burden, carrying but 340 men, and 40 guns, and the

Fadava, vol. ii. p. 943.

Ib. vol. iv. p. 664.

Fadava, vol. viii. p. 727.

Ib. vol. i. p. 258.

Ib. vol. x. p. 364.

Johnson's Naval Tracts, p. 294.

the smallest 600 tons, carrying 150 men and 30 guns. Smaller vessels were occasionally hired by her from private owners.

In the memorable sea-fight of Lepanto between the Turks and Chrillians, anno 1571, no vessels were employed but galleys; and it would appear from the carcasses of some of them, which are still preserved in the arsenal at Venice, that even these were not so large or so well constructed as those of our times. The Invincible Armada, as Spanish vanity styled it, once the terror and admiration of nations, in the pompous and exaggerated descriptions of which the Spanish authors of those times dwelt with so much apparent pleasure, consisted of 130 ships, near 100 of which were the stateliest that had yet been seen on the ocean. The largest of these, however, would be no more than a third rate vessel in our navy, and they were so ill constructed, that they would neither move easily, sail near the wind, nor be properly worked in tempestuous weather. The whole of the naval force collected by Queen Elizabeth to oppose this formidable fleet, including hired vessels, tenders, store-ships, &c. amounted to no more than 143.

Ship-building began now to make a considerable progress in Britain. Both war and trade required an increase of shipping; so that, in the year 1670, the annual charge of the navy was reported to be £. 500,000; and in 1678 the navy consisted of 83 ships, of which 58 were of the line. At this time the exports amounted to ten millions *per annum*; and the balance of trade was two millions. In 1689 there were 173 ships, great and small, in the royal navy, and it has been constantly increasing; so that in 1761 the ships in the navy amounted to 372, of which 129 were of the line; and in the beginning of the year 1795, the total amount was above 430.

As ships of the common construction are found to be very defective in many particulars, various methods have therefore from time to time been proposed to remove some of the bad qualities they possessed. As it would be an endless task to enumerate the different inventions for this purpose, therefore a few of them only will be mentioned.

In 1663 Sir William Petty constructed a double ship, or rather a single ship with a double bottom, which was found to sail considerably faster than any of the ships with which it had an opportunity of being tried. Her first voyage was from Dublin to Holyhead; and in her return she turned into that narrow harbour against wind and tide, among rocks and ships, with such dexterity as many ancient seamen confessed they had never seen the like. This vessel with 70 more were lost in a dreadful tempest.

This subject was again revived by Mr Gordon, in his Principles of Naval Architecture, printed at Aberdeen anno 1784; where, having delivered his sentiments on the construction of large masts, he says; "These ex-

periments likewise point out to us methods by which two vessels may be laterally connected together, though at a considerable distance from each other, in a manner sufficiently strong, with very little increase of weight or expence of materials, and without exposing much surface to the action or influence of the wind or the waves, or obstructing their motion in any considerable degree, and consequently without being much opposed by them on that account under any circumstances; and if vessels are judiciously constructed with a view to such a junction, it would be no easy matter to enumerate all the advantages that may be obtained by this means." He then enumerates the advantages that double vessels would have over those of the common construction. Soon after double ships were actually built by Mr Miller of Dalswinton.

Another plan was proposed by Mr Gordon to make a ship sail fast, draw little water, and to keep a good wind. For this purpose, "the bottom (he says) should be formed quite flat, and the sides made to rise perpendicular from it, without any curvature; which would not only render her more steady, as being more opposed to the water in rolling, but likewise more convenient for stowage, &c. while the simplicity of the form would contribute greatly to the ease and expedition with which she might be fabricated. Though diminishing the draught of water is, *ceteris paribus*, undoubtedly the most effectual method of augmenting the velocity with which vessels go before the wind; yet, as it proportionally diminishes their hold of the water, it renders them extremely liable to be driven to leeward, and altogether incapable of keeping a good wind. This defect, may, however, be remedied, in a simple and effectual manner, by proportionally augmenting the depth of keel, or, as so large a keel would be inconvenient on many accounts, proportionally increasing their number; as, in place of adding a keel eight feet deep to a vessel drawing six feet water, to affix to different parts of her flat bottom, which would be well adapted for receiving them, six different keels of two feet deep each at equal distances from each other, with proper intervals between; which will be found equally effectual for preventing these pernicious effects. Four such, indeed, would have answered the purpose as well as the eight feet keel, were it not for the superior pressure or resistance of the lower water (A).

Thus then it appears, that a vessel drawing eight feet water only, keels and all, may be made to keep as good a wind, or be as little liable to be driven to leeward, as the sharpest built vessel of the same length drawing 14, nay 20 or upwards, if a few more keels are added, at the same time that she would be little more resisted in moving in the line of the keels than a vessel drawing six feet water only. These keels, besides, would strengthen the vessel considerably, would render her more steady, and less liable to be overlet, and thereby enable

7  
And lately constructed by Mr Miller.  
Principles of Naval Architecture, p. 76.  
Draught of water proposed to be diminished in order to obtain velocity, &c.  
9  
Inconvenience of plan.  
10  
Remedied by augmenting the depth of the keel.  
11  
Or by increasing the number of keels.

(A) This is frequently repeated on the authority of Mr Gordon and others. Theory says otherwise; and the experiments of Sir Isaac Newton show in the most unexceptionable manner, that the resistance of a ball descending through the water is the same at all depths; nay, the heaping up of the water on the bow, occasioning a hydrostatical pressure in addition to the real resistance, will make the whole opposition to an equal surface, but of greater horizontal dimensions, greater, because it bears a greater proportion to the resistance.

History.

enable her to carry more fail; and Mr Gordon then enumerates the several advantages that a ship of this construction will possess.

12  
The plan  
further im-  
proved by  
the adop-  
tion of li-  
ding keels.

This plan has lately been put into execution by Captain Schank, with this difference only, that instead of the keels being fixed as proposed by Mr Gordon, Captain Schank constructed them so as to slide down to a certain depth below the bottom, or to be drawn up within the ship as occasion might require.

13  
The utility  
of sliding  
keels pro-  
ved by ex-  
periment.

Captain Schank having communicated his plans to the Navy Board, two vessels were in consequence ordered to be built of 13 tons each, and similar in dimensions, one on the old construction, and the other flat-bottomed, with sliding keels. In 1790 a comparative trial in presence of the commissioners of the navy was made on the river Thames, each having the same quantity of sail; and although the vessel on the old construction had leeboards, a greater quantity of ballast, and two Thames pilots aboard, yet Captain Schank's vessel with three sliding keels beat the other vessel, to the astonishment of all present, one half of the whole distance sailed; and no doubt she would have beat her much more had she been furnished with a Thames pilot.

14  
And actu-  
ally put in  
practice  
upon a  
larger scale.

This trial gave so much satisfaction, that a king's cutter of 120 tons was immediately ordered to be built on the same construction, and Captain Schank was requested to superintend its building. This vessel was launched at Plymouth in 1791, and named the *Trial*. The length of this vessel is 66 feet, breadth 21 feet, and depth of the hold seven feet: her bottom is quite flat, and draws only six feet water, with all her guns, stores, &c. whereas all other vessels of her tonnage on the old construction draw 14 feet; so that she can go with safety into almost any harbour or creek. She has three sliding keels inclosed in a case or well; they are each 14 feet in length; the fore and the after keels are three feet broad each, and the middle keel is six feet broad. The keels are moveable by means of a winch, and may be let down seven feet below the real keel; and they work equally well in a storm as in still water. Her hold is divided into several compartments, all water-tight, and so contrived, that should even a plank or two start at sea in different parts of the vessel, she may be navigated with the greatest security to any place. If she should be driven on shore in a gale of wind, she will not soon become a wreck, as her keels will be driven up into their cases, and the ship being flat-bottomed, will not be easily overset; and being able to go into such shallow water, the crew may all be easily saved. By means of her sliding keels she is kept steady in the greatest gale; she is quite easy in a great sea, does not strain in the least, and never takes in water on her deck; and when at anchor, she rides more upright and even than any other ship can do: she sails very fast either before or upon a wind; no vessel she has ever been in company with, of equal size, has been able, upon many trials, to beat her in sailing; and yet her sails seem too small.

It has also been proposed to construct vessels of other materials than wood; and lately a vessel was built whose bottom, instead of being plank, was copper.

BOOK I. *Containing the Method of delineating the several Sections of a Ship.*

CHAP. I. *Of the Properties of Ships.*

A SHIP ought to be constructed so as to answer the particular purpose for which she is intended. It would be an easy matter to determine the form of a ship intended to sail by means of oars; but, when sails are used, a ship is then acted upon by two elements, the wind and water: and therefore it is much more difficult than is commonly imagined to ascertain the form of a ship so as to answer in an unfavourable as well as a favourable wind; the ship at the same time having a cargo of a certain weight and magnitude.

Every ship ought to sail well, but particularly when the wind is upon the beam; for this purpose a considerable length in proportion to the breadth is necessary, and the plane of resistance should be the least possible. The main frame should also be placed in a proper situation; but according to the experiments of Mr Chapman\*, its plane is variable with the velocity of the ship: the mean place of the main frame has, however, been generally estimated to be about one-twelfth of the length of the keel before the middle. Without a sufficient degree of stability a ship will not be able to carry a press of sail: a great breadth in proportion to the length and low upper-works will augment the stability. The following particulars being attended to, the above property will be gained, and the ship will also steer well. The wing transom should be carried pretty high; the fashion-pieces well formed, and not full below the load water-line: the lower part of the stem to be a portion of a circle, and to have a considerable rake: the sternpost to be nearly perpendicular to the keel; and all the upper works kept as low as possible.

Many ships from construction are liable to make much leeway. This may in a great measure be avoided by giving the ship a long keel, little breadth, and a considerable depth in the hold: whence the bow will meet with little resistance in comparison to the side, and therefore the ship will not fall much to the leeward.

Another very great retardation to the velocity of a ship is her pitching. The principal remedy for this is to increase the length of the keel and floor, to diminish the rising afore and abaft, and to construct the hull in such a manner that the contents of the fore-body may be duly proportioned to the contents of the after-body.

In a ship of war the lower tier of guns ought to be of a sufficient height above the water, otherwise it will be impossible to work the lee-guns when it blows hard. This property will be obtained by giving her a long floor-timber, little rising, a full midship frame, light upper works, and the wing transom not too high: And in every ship the extreme breadth ought always to be higher afore and abaft than at midships.

A merchant-ship, besides being a fast sailer, ought to carry a considerable cargo in proportion to its length, to sail with little ballast, and to be navigated with few hands.

That a ship may take in a considerable cargo, it

Propo

of sh

Princi  
of ship  
buildiPropo  
that a  
must p  
fels to  
a good  
er.\* Tra  
la Con  
sion des  
Jcaux,To m  
a ship  
a good  
wind,And t  
smoot  
w the  
pitchi  
hard.In shi  
lower  
guns  
suffici  
high  
the wPropo  
of a r  
chanTo t  
shoul  
a gre  
go,



*Fig. 1.*

PIECES of the HULL.

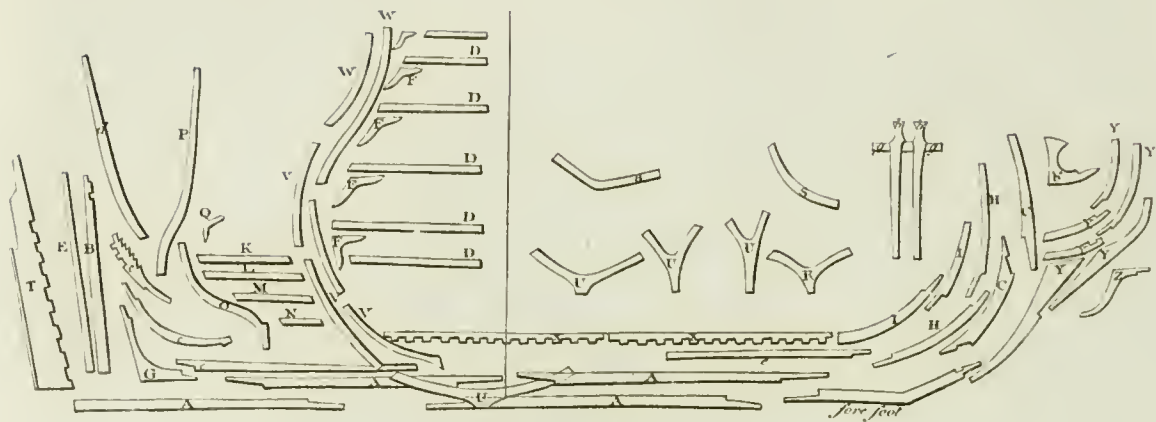

*Fig. 2.*

FRAMES of a SHIP.

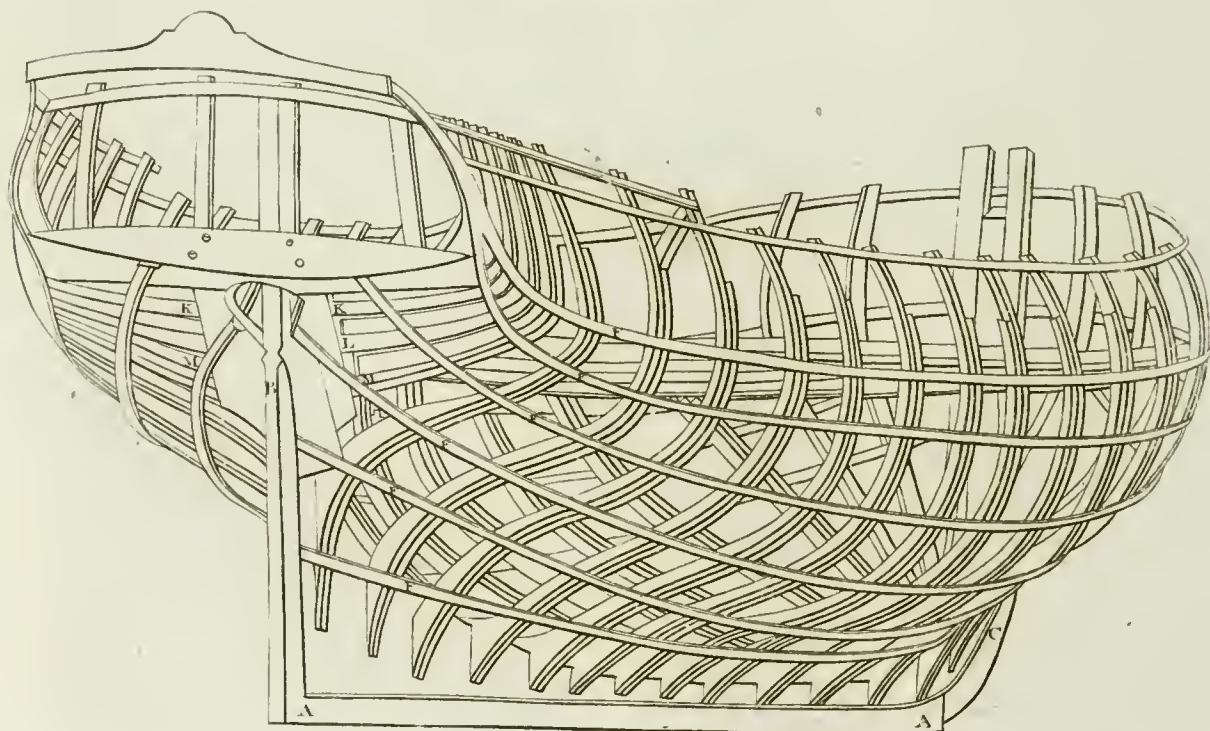

*W. Hill Pin. and Sculptor fecit.*



proper ties  
of ships.

Properties  
of Ships.

22  
d to  
re sta-  
ty.

should have a great breadth and depth in proportion to its length, a full bottom, and a long and flat floor. But a ship of this construction will neither sail fast, nor carry much sail.

If a ship be filled out much towards the line of floatation, together with low upper works, she will require little ballast : and that ship which is stiff from construction is much better adapted for sailing fast than one which, in order to carry the same quantity of canvas, is obliged to be loaded with a much greater weight : for the resistance is as the quantity of water to be removed, or nearly as the area of a transverse section of the immersed part of the body at the midship frame ; and a body that is broad and shallow is much stiffer than one of the same capacity that is narrow and deep.

The advantages (says Mr Gordon) are numerous, important, and obvious. For it is evident, that by enlarging, perhaps doubling, the breadth of vessels, and forming their bottoms flat and well furnished with keels, they must, in the first place, become much steadier, roll little, if any, and be enabled to carry greatly more sail, and that in a better direction, at the same time that they would be in no danger of being dismasted or overfet, unless the masts were of a most extraordinary height indeed. Secondly, They would have little or no occasion for ballast, and if any was used, could incur less danger from its shifting. Thirdly, That there would be much more room upon deck, as well as accommodation below ; the breadth being so much increased without any diminution of the height above the load-water line. Fourthly, That they would deviate much less from the intended course, and penetrate the water much easier in the proper direction : for doubling the breadth, without any increase of weight, would diminish the depth or draught of water one half ; and though the extent of the directly opposing surface would be the same as before, yet the vessel in moving would meet with half the former resistance only : for so great is the difference between the pressure, force, or reaction, of the upper and the under water. Fifthly,

That they would by this means be adapted for lying unsupported in docks and harbours when dry, be rendered capable of being navigated in shallow water, and of being benefited by all the advantages attending that very important circumstance ; and it is particularly to be observed, that making vessels which may be navigated in shallow water, may, in many respects, justly be regarded as a matter of equal importance with increasing the number of harbours, and improving them, as having identically the same effects with regard to navigation ; at the same time, that the benefits which would result from such circumstances are obtained by this means without either expence, trouble, or inconveniency : besides, it would not only enable vessels to enter many rivers, bays, and creeks, formerly inaccessible to ships of burden, but to proceed to such places as are most land locked, where they can lie or ride most secure, and with least expence of men and ground tackle. As ships of war would carry their guns well by being so steady, there could be but little occasion for a high topside, or much height of hull above water ; and as little or no ballast would be required, there would be no necessity, as in other vessels, for increasing their weight on that account, and thereby pressing them deeper into the water. These are very important circum-

stances, and would contribute much to improve the sailing of such vessels." From whence it appears, that there would be united, what has hitherto been deemed irreconcilable, the greatest possible stability, which is nearly as the area of a transverse section of the immersed part of the body at the midship frame : and a body that is broad and shallow is much stiffer than one of the same capacity that is narrow and deep. A ship of this construction may take in a considerable cargo in proportion to her size ; but if deeply loaded will not sail fast, for then the area of a section of the immersed part at the midship frame will be very considerable, and as the sails of such a ship must necessarily be large, more hands will therefore be required.

The less the breadth of a ship, the fewer hands will be necessary to work her ; as in that case the quantity of sail will be less, and the anchors also of less weight. We shall gain much (says M. Bouguer) by making the extreme breadth no more than the fifth or sixth part of the length, if, at the same time, we diminish the depth proportionally ; and likewise this most surprising circumstance, that by diminishing these two dimensions, or by increasing the length, a ship may be made to go sometimes as fast as the wind.

In order to obtain the preceding properties, very opposite rules must be followed ; and hence it appears to be impossible to construct a ship so as to be possessed of them all. The body, however, must be so formed, that as many of these properties may be retained as possible, always observing to give the preference to those which are most required. If it is known what particular trade the ship is to be employed in, those qualities are then principally to be adhered to which are most essentially necessary for that employment.

It may easily be demonstrated that small ships will not have the same advantages as large ones of a similar form, when employed in the same trade : for a large ship will not only sail faster than a small one of a similar form, but will also require fewer hands to work her. Hence, in order that a small ship may possess the same advantages as a large one, the corresponding dimensions will not be proportional to each other. The reader will see in Chapman's *Architectura Navalis Mercatoria* ample tables of the several dimensions of ships, of different classes and sizes, deduced from theory combined with experiment. Tables of the dimensions of the principal ships of the British navy, and of other ships, are contained in the Ship-builder's Repository, and in Murray's *Treatise on Ship-building*.

CHAP. II. Of the different Plans of a Ship.

WHEN it is proposed to build a ship, the proportional size of every part of her is to be laid down : from whence the form and dimensions of the timbers, and of every particular piece of wood that enters into the construction, is to be found. As a ship has length, breadth, and depth, three different plans at least are necessary to exhibit the form of the several parts of a ship : these are usually denominated the *sheer plan*, the *half breadth* and *body plans*.

The *sheer plan* or *draught*, otherwise called the *plan of elevation*, is that section of the ship which is made by a vertical plane passing through the keel. Upon this plan are laid down the length of the keel ; the height and rake of the stem and sternpost ; the situation

24  
And to be  
navigate d  
with few  
hands.  
Traite de  
Navire.

25  
Impossible  
to unite all  
the quali-  
ties in the  
same ship.

26  
Small ships  
inferior to  
large ones  
in point of  
sailing, &c.

27  
hee:  
draught, or  
elevation.

Different  
Plans of a  
Ship.

and height of the midship and other frames; the place of the masts and channels; the projection of the head and quarter gallery, and their appendages; and in a ship of war the position and dimensions of the gun-ports. Several imaginary lines, namely, the upper and lower height of breadth lines, water lines, &c. are also drawn in this plan.

28  
Half  
breadth  
plan or  
horizontal  
plane.

The *half breadth* or *floor plan*, or, as it is frequently called, the *horizontal* plane, contains the several half-breadths of every frame of timbers at different heights; ribbands, water lines, &c. are also described on this plane.

29  
Body plan,  
or projec-  
tion.

The *body plan*, or *plane of projection*, is a section of the ship at the midship frame or broadest place, perpendicular to the two former. The several breadths, and the particular form of every frame of timbers, are described on this plane. As the two sides of a ship are similar to each other, it is therefore unnecessary to lay down both; hence the frames contained between the main frame and the stem are described on one side of the middle line, commonly on the right hand side, and the after frames are described on the other side of that line.

30  
The vari-  
ous lines  
laid down  
on these  
plans.

Several lines are described on these planes, in order the more readily to assist in the formation of the timbers; the principal of which are the following:

The *top-timber line*, is a curve limiting the height of the ship at each timber.

The *top-timber half breadth line*, is a section of the ship at the height of the top-timber line, perpendicular to the plane of elevation.

The *height of breadth lines*, are two lines named the *upper* and *lower* heights of breadth. These lines are described on the plane of elevation to determine the height of the broadest part of the ship at each timber; and being described in the body plan, limits the height and breadth of each frame at its broadest part.

*Main half breadth*, is a section of the ship at the broadest part, perpendicular to the sheer plan, and represents the greatest breadth at the outside of every timber.

*Water lines*, are lines supposed to be described on the bottom of a ship when afloat by the surface of water; and the uppermost of these lines, or that described by the water on the ship's bottom when sufficiently loaded, is called the *load water line*. According as the ship is lightened, she will rise higher out of the water; and hence new water lines will be formed. If she be lightened in such a manner that the keel may preserve the same inclination to the surface of the water, these lines will be parallel to each other; and if they are parallel to the keel, they will be represented by straight lines parallel to each other in the body plan; otherwise by curves. In the half breadth plan, these lines are curves limiting the half breadth of the ship at the height of the corresponding lines in the sheer plan. In order to distinguish these lines, they are usually drawn in green.

*Riband lines*, are curves on a ship's bottom by the intersection of a plane inclined to the plane of elevation; and are denominated *diagonal* or *horizontal*, according as they are measured upon the diagonal, or in a direction perpendicular to the plane of elevation. Both these answer to the same curve on the ship's bottom, but give very different curves when described on the half breadth plan.

*Frames*, are circular pieces of timber bolted together, and raised upon the keel at certain distances, and to which the planks are fastened. A frame is composed of one floor-timber, two or three futtocks, and a top-timber on each side: which being united together, form a circular inclosure, and that which incloses the greatest space is called the *midship* or *main* frame. The arms of the floor-timber of this frame form a very obtuse angle; but in the other frames this angle decreases with the distance of the frame from midships. Those floor timbers which form very acute angles are called *crutches*. The length of the midship floor timber is in general about half the length of the main frame.

A frame of timbers is commonly formed by arches of circles called *sweeps*. There are generally five sweeps: 1<sup>st</sup>, The *floor sweep*; which is limited by a line in the body plan perpendicular to the plane of elevation, a little above the keel; and the height of this line above the keel at the midship frame is called the *dead rising*. The upper part of this arch forms the head of the floor timber. 2<sup>d</sup>, The *lower breadth sweep*; the centre of which is in the line representing the lower height of breadth. 3<sup>d</sup>, The *reconciling sweep*. This sweep joins the two former, without intersecting either; and makes a fair curve from the lower height of breadth to the rising line. If a straight line is drawn from the upper edge of the keel to touch the back of the floor sweep, the form of the midship frame below the lower height of breadth will be obtained. 4<sup>th</sup>, The *upper breadth sweep*; the centre of which is in the line representing the upper height of breadth of the timber. This sweep described upwards forms the lower part of the top timber. 5<sup>th</sup>, The *top timber sweep* is that which forms the hollow of the top timber. This hollow is, however, very often formed by a mould, so placed as to touch the upper breadth sweep, and pass through the point limiting the half breadth of the top timber.

The main frame, or as it is usually called *dead-flat*, is denoted by the character  $\oplus$ . The timbers before dead-flat are marked A, B, C, &c. in order; and those abaft dead-flat by the figures 1, 2, 3, &c. The timbers adjacent to dead-flat, and of the same dimensions nearly, are distinguished by the characters (A), (B), &c. and (1), (2), &c. That part of the ship abaft the main frame is called the *after body*; and that before it the *fore body*.

All timbers are perpendicular to the half breadth plan. Those timbers whose planes are perpendicular to the sheer plan, are called *square timbers*; and those whose planes are inclined to it are called *canted timbers*.

The *rising line*, is a curve drawn in the sheer plan, at the heights of the centres of the floor sweeps in the body plan. As, however, this line, if drawn in this manner, would extend beyond the upper line of the figure, it is therefore usually so drawn that its lower part may touch the upper edge of the keel. This is performed by taking the heights of each of the centres in the body plan, from the height of the centre of the sweep of dead-flat, and setting them off on the corresponding timbers in the sheer plan from the upper edge of the keel.

*Half breadth of the rising*, is a curve in the floor plan, which limits the distances of the centres of the floor sweeps from the middle line of the body plan.

Different  
Plans of a  
Ship

Different  
Plans of a  
Ship

*The rising of the floor*, is a curve drawn in the sheer plan, at the height of the ends of the floor timbers. It is limited at the main frame or dead flat by the dead rising, and in flat ships is nearly parallel to the keel for some timbers afore and abaft the midship frame; for which reason these timbers are called *flats*: but in sharp ships it rises gradually from the main frame, and ends on the stem and post.

*Cutting down line*, is a curve drawn on the plane of elevation. It limits the depth of every floor timber at the middle line, and also the height of the upper part of the dead wood afore and abaft.

*Timber and room, or room and space*, is the distance between the moulding edges of two timbers, which must always contain the breadth of two timbers and an interval of about two or three inches between them. In forming the timbers, one mould serves for two, the fore-side of the one being supposed to unite with the aft-side of the other, and so make only one line, which is called *the joint of the timbers*.

34  
Principal  
pieces that  
compose  
a ship.

In order to illustrate the above, and to explain more particularly the principal pieces that compose a ship, it will be necessary to give a description of them. These pieces are for the most part represented according to the order of their disposition in fig. 1. Plate CCCCLIV.

A, Represents the pieces of the keel to be securely bolted together and clinched.

B, The sternpost, which is tenanted into the keel, and connected to it by the knee G.

E, The back of the post, which is also tenanted into the keel, and securely bolted to the post; the intention of it is to give sufficient breadth to the port, which seldom can be got broad enough in one piece. C is the false post, which is fayed (B) to the fore part of the sternpost.

C, The stem, in two pieces, to be scarfed together. The stem is joined to the fore foot, which makes a part of both.

H, The apron, in two pieces, to be scarfed together, and fayed on the inside of the stem, to support the scarf thereof; and therefore the scarf of the apron must be at some distance from that of the stem.

I, The stemson, in two pieces, to support the scarf of the apron.

D, The beams which support the decks; and F the knees by which the beams are fastened to the sides of the ship.

K, The wing transom: it is fayed across the sternpost, and bolted to the head of it, and its extremities are fastened to the fashion pieces. L, Is the deck transom, parallel to the wing transom. M, N, Two of the lower transoms: these are fastened to the sternpost and fashion pieces in the same manner as the wing transom.

Q, The knee which fastens the transom to the ship's side. And, O, The fashion piece, of which there is one on each side. The keel of the fashion piece is connected with the dead wood, and the head is fastened to the wing transom.

R, S, Breast-hooks: these are fayed in the inside of the stem, and to the bow on each side of it, to which they are fastened with proper bolts. There are gene-

rally four or five in the hold, in the form of that marked R, and one in the form of that marked S, into which the lower deck planks are rabbeted: There is also one immediately under the hause holes, and another under the second deck.

T, The rudder, which is joined to the sternpost by the rudder irons, upon which it turns round in the googings, fastened to the sternpost for that purpose. There is a mortise cut in the head of the rudder, into which a long bar is fitted called the *tiller*, and by which the rudder is turned.

U, A floor timber: it is laid across the keel, to which it is fastened by a bolt through the middle. V, V, V, V, The lower, the second, third, and fourth futtocks. W, W, The top timbers. These represent the length and scarf of the several timbers in the midship frame.

X, The pieces which compose the kelson. They are scarfed together in the same manner as the keel, and placed over the middle of the floor timbers, being scored about an inch and a half down upon each side of them, as represented in the figure.

Y, The several pieces of the knee of the head; the lower part of which is fayed to the stem, and its keel is scarfed to the head of the forefoot. It is fastened to the bow by two knees, called *checks*, in the form of that represented by Z; and to the stem, by a knee called a *standard*, in the form of that marked ⊕.

a, The cathead, of which there is one on each side of the bow, projecting so far as to keep the anchor clear of the ship when it is hove up.

b, The bits, to which the cable is fastened when the ship is at anchor.

d, The side counter-timbers, which terminate the ship abaft within the quarter gallery.

e, e, Two pieces of dead wood, one afore and the other abaft, fayed on the keel.

Fig. 2. is a perspective representation of a ship framed and ready for the planking; in which A, A is the keel; B, the sternpost; C, the stem; K, L, M, the transoms; F, F, F, F, F, F, the ribbands.

CHAP. III. Containing Preliminary Problems, &c.

THE general dimensions of a ship are the *length*, *breadth*, and *depth*.

To ascertain those dimensions that will best answer the intended purpose is, no doubt, a problem of considerable difficulty; and, from theory, it may be shown that there are no determinate proportions subsisting between the length, breadth, and depth, by which these dimensions may be settled; yet, by combining theory and practice, the proportional dimensions may be approximated to pretty nearly.

As ships are constructed for a variety of different purposes, their principal dimensions must therefore be altered accordingly, in order to adapt them as nearly as possible to the proposed intention; but since there is no fixed standard whereby to regulate these dimensions, the methods therefore introduced are numerous, and in a great measure depend upon custom and fancy.

With regard, however, to the proportional dimensions,

(B) To fay, is to join two pieces of timber close together.

Preliminary Problems.

37 And also from the circle.

† Practical Seamanship, page 25.

\* See Book ii. Chap. 2.

sions, they perhaps may be inferred from the circle. Thus, if the extreme breadth be made equal to the diameter, the length at the load water line, or the distance between the rabbets of the stem and post at that place, may be made equal to the circumference of the same circle; and the depth of the hold equal to the radius, the upper works being continued upwards according to circumstances. A ship formed from these dimensions, with a bottom more or less full according as may be judged necessary, will no doubt answer the proposed intention. Nevertheless, one or other of these dimensions may be varied in order to gain some essential property, which the trade that the vessel is intended for may require.

The following hints are given by Mr Hutchinson † towards fixing rules for the best construction of ships bottoms.

1. "I would recommend (says he), to prevent ships bottoms from hogging \* upwards amidship, to have the fore and after part of their keels deep enough, that the upper part may be made to admit a rabbet for the garboard streak, that the main body and bearing part of the ships bottoms may be made to form an arch downwards in their length, suppose with the same sweep as their bends, at the rate of about 2 inches for every 30 feet of the extreme length of the keel towards the midship or main frame, which may be reckoned the crown of the arch; and the lower part of the keel to be made straight, but laid upon blocks so that it may form a regular convex curve downwards at the rate of an inch for every 30 feet of the extreme length of the keel, the lowest part exactly under the main frame; which curve, I reckon, is only a sufficient allowance for the keel to become straight below, after they are launched afloat, by the pressure of the water upward against their floors amidship, which causes their tendency to hog. And certainly a straight keel is a great advantage in sailing, as well as to support them when laid upon level ground or on straight blocks in a repairing dock, without taking damage.

2. "As square sterned ships, from experience, are found to answer all trades and purposes better than round or pink sterned ships, I would recommend the fore part of the sternpost, on account of drawing the water lines in the draught, only to have a few inches rake, that the after part may stand quite upright perpendicular to the keel: and for the rake of the stem I would propose the rabbet for the hudding ends for the entrance, and bows from the keel upwards, to form the fine curve as the water line from the stem at the harpin towards the main breadth, and the bows at the harpin to be formed by a sweep of a circle of half the three-fourths of the main breadth; and the main transom to be three-fourths of the main-breadth; and the buttocks, at the load or sailing mark aft, to be formed, in the same manner as the bows at the harpin, with a sweep of a circle of half the three fourths of the main breadth, to extend just as far from the stem and stern post as to admit a regular convex curve to the main frame, and from these down to the keel to form regular convex water-lines, without any of those unnatural, hollow, concave ones, either in the entrance or run; which rules, in my opinion, will agree with the main body of the ship, whether she is designed to be built full for burden or sharp below for sailing.

3. "This rule for raking the stem will admit all the

water-lines in the ship's entrance to form convex curves all the way from the stem to the midship or main frame, which answers much better for sailing as well as making a ship more easy and lively in bad weather. And the bows should flange off, rounding in a circular form from the bends up to the gunwale, in order to meet the main breadth the sooner, with a sweep of half the main breadth at the gunwale amidships; which will not only prevent them greatly from being plunged under water in bad weather, but spread the standing fore-rigging the more, to support these material masts and sails forward to much greater advantage than in those over sharp bowed ships, as has been mentioned. And as the sailing trim of ships in general is more or less by the stem, this makes the water lines of the entrance in proportion the sharper to divide the particles of water the easier, so that the ship may pass through it with the least resistance.

4. "The run ought to be formed shorter or longer, fuller or sharper, in proportion to the entrance and main body, as the ship is designed for burden or sailing fast. The convex curves of the water lines should lessen gradually from the load or sailing mark aft, as has been mentioned, downwards, till a fair straight taper is formed from the after part of the floor to the sternpost below, without any concavity in the water lines; which will not only add buoyancy and burden to the after body and run of the ship, but, in my opinion, will help both her sailing and steering motions; for the pressure of the water, as it closes and rises upon it to come to its level again, and fill up that hollow which is made by the fore and main body being pressed forward with sail, will impinge, and act with more power to help the ship forward in her progressive motion, than upon those unnatural concave runs, which have so much more flat dead wood, that must, in proportion, be a hinderance to the stern being turned so easily by the power of the helm to steer the ship to the greatest advantage."

Many and various are the methods which are employed to describe the several parts of a ship. In the following problems, however, those methods only are given which appear to be most easily applied to practice, and which, at the same time, will answer any proposed purpose.

PROB. I. To describe in the plane of elevation the sheer or curvature of the top timbers.

Let QR (fig. 3.) be the length of the ship between the wing transom and the rabbet of the stem. Then since it is generally agreed, especially by the French constructors, that the broadest part of the ship ought to be about one-twelfth of the length before the main frame or dead flat; therefore make R⊕ equal to five-twelfths of QR, and ⊕ will be the station of the main frame; space the other frames on the keel, and from middle of these points let perpendiculars be drawn to the keel. Let ⊗P be the height of the ship at the main frame, V† the height at the aftermost frame, and RK the height at the stem. Through P draw EPL paral. lel to the keel; describe the quadrants PGI, PMN, the radius being P⊕; make PH equal to EF, and PO equal KL, and draw the parallels GH, OM: Divide GH similar to ⊕C, and OM similar to ⊕R. Through these points of division draw lines perpendicular to EL, and the several positions of these perpendiculars contained between EL and the arch will be the risings of the

Preliminary Problems.

Plate CCCLV 38 The place of the main frame about one-twelfth before the middle of the ship. 39 Method of describing the top timber line.

Fig. 3.

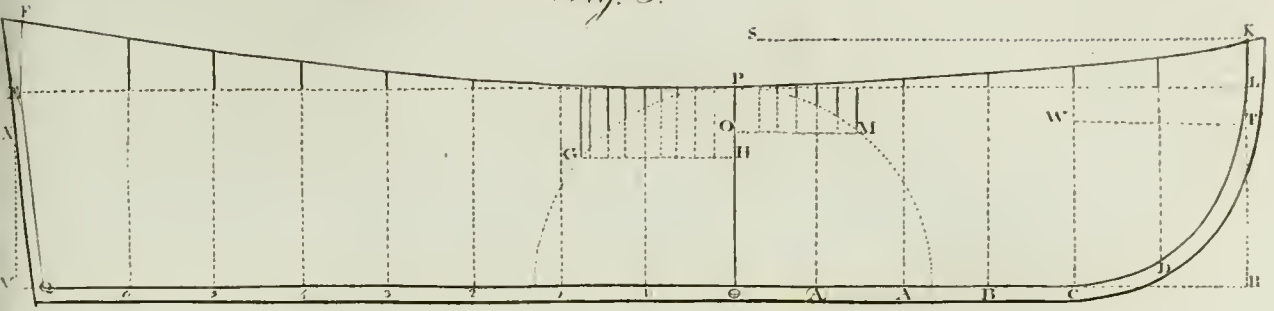

Fig. 4.

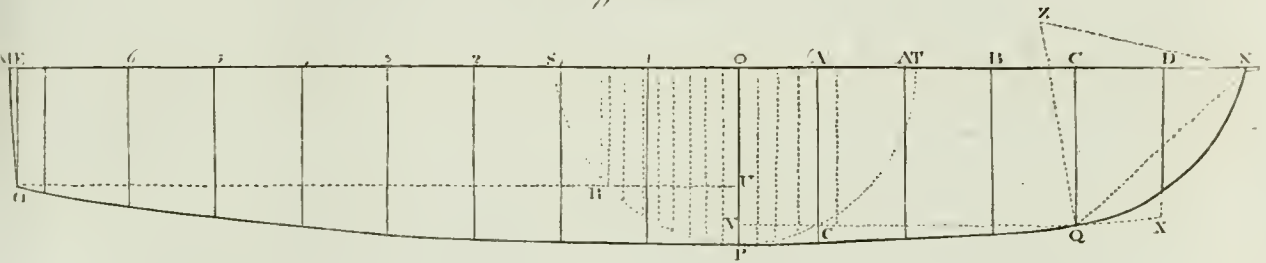

Fig. 5.

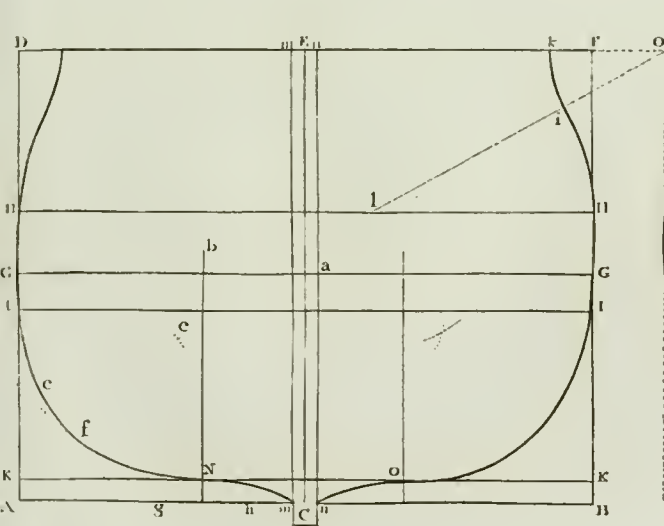
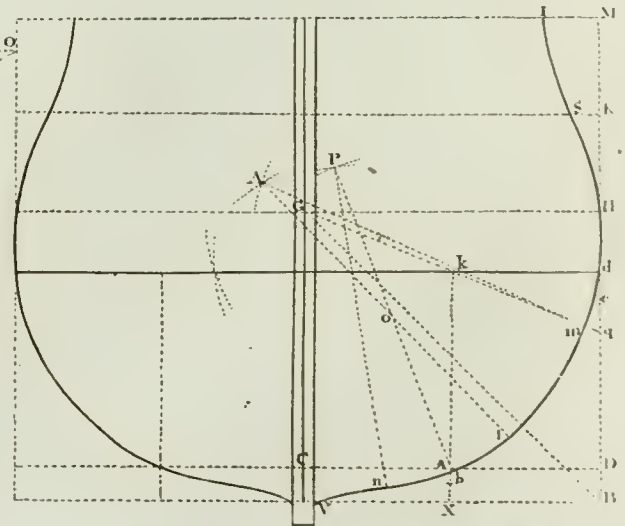

Fig. 6.



A. Hill, Pirat, Author of the text.



Preliminary Problems. top-timber line above EL. A curve drawn through these points will form the toptimber line.

This line is more easily drawn by means of a curved or bent ruler, so placed that it may touch the three points F, P, and K.

PROB. II. To describe the stem:

Let K (fig. 3.) be the upper part of the stem, thro' which draw KS parallel to the keel, and equal to twice KR: Through the termination of the wales on the stem draw JW parallel to QR. Then from the centre S, with the distance SK, describe an arch: Take an extent equal to the nearest distance between the parallels WI, QR; and find the point W, such that one point of the compass being placed there, the other point will just touch the nearest part of the above arch; and from this point as a centre describe an arch until it meets the keel, and the stem will be formed.

PROB. III. To describe the sternpost.

Set off QV (fig. 3.) for the rake of the post: draw VX perpendicular to the keel, and equal to the height of the wing transom, join QX, and it will represent the aft side of the post.

PROB. IV. To describe the half breadth line.

Let MN (fig. 4.) be the given length: Make N⊙ equal to five-twelfths of MN; draw the line ⊕P perpendicular to MN, and equal to the proposed extreme half breadth. Let ME be the round aft of the stern or wing transom; make EO perpendicular to MN, and equal to the given half breadth at the stern, which is generally between two-thirds and three-fourths of the main half breadth; and describe the arch MO, the centre of which is in the middle line. Space the frames (A), B, &c. and (1), 2, &c. From the centre ⊕, with the radius ⊕P, describe the quadrant PRS; describe also the quadrant PCT. Through the point O draw ORU parallel to MN; divide the straight line RU similar to M⊙; and through these points of division draw lines perpendicular to MN, and meeting the arch. Transfer these lines to the correspondent frames each to each, and a curve drawn through the extremities will represent that part of the side contained between the main frame and the stern. Again, thro' Q, the extremity of the foremost frame, draw QV parallel to MN. Or make PV a fourth or third part of PU, according as it is intended to make the ship more or less full towards the bow. Divide VC similar to ⊙C; through these points draw lines perpendicular to MN, and terminating in the quadrantal arch: Transfer these lines to the corresponding timbers in the fore part, and a curve drawn through the extreme points will limit that part of the ship's side contained between P and Q. Continue the curve to the next timber at X. From Q draw QZ perpendicular to QX; make the angle ZNQ equal to ZQN, and the point Z will be the centre of the arch forming the bow. Remark, if it is proposed that the breadth of the ship at the frames adjacent to the main frame shall be equal to the breadth at the main frame; in this case, the centres of the quadrantal arches will be at the points of intersection of these frames with the line MN; namely at (A) and (1). Also, if the height of the ship at the frames (A) and (1) is to be the same as at dead flat, the quadrantal arches in fig. 3. are to be described from the points of intersection of these frames with the line EL.

These rules, it is evident, are variable at pleasure; and any person acquainted with the first principles of mathematics may apply calculation to find the radii of the several sweeps.

PROB. V. To describe the main frame or dead-flat.

This frame is that which contains the greatest space, and the particular form of each of the other frames depends very much on it. If the ship is intended to carry a great burden in proportion to her principal dimensions, this frame is made very full; but if she is intended to sail fast, it is usually made sharp. Hence arises diversity of opinions respecting its form; each contractor using that which to him appears preferable. In order to save repetition, it is judged proper to explain certain operations which necessarily enter into all the different methods of constructing this frame.

In the plane of the upper side of the keel produced, draw the line AB (fig. 5.) equal to the proposed breadth of the ship; bisect AB in C, and draw AD, CE, and BF, perpendicular to AB. Then, since the two sides of a ship are similar, it is therefore thought sufficient to describe the half of each frame between the main frame and the stern on one side of the middle line CE, and the half of each of those before the main frame on the other side of it. The first half is called the *after-body*, and the other the *fore-body*. The after-body is commonly described on the left side of the middle line; and the fore-body on the right side of it: hence the line AD is called the *side line* of the *after* body, and BF the side line of the *fore* body. Make AD and BF each equal to the height of the ship at the main frame. Make AG, BG, and AH, BH, equal to the lower and upper heights of breadth respectively, taken from the sheer plan. Let II be the load water line, or line of floatation when the ship is loaded, and KK the height of the rising line of the floor at this frame. Make CN, CO, each equal to half the length of the floor timber, and N, O, will be the heads of the floor timber, thro' which draw perpendiculars to AB. Make Cm, Em, each equal to half the thickness of the sternpost, and Cn, En, equal to half the thickness of the stern, and join mm, nn.

Method I. Of describing a main frame.—From the centre a (fig. 5.), in the lower breadth line, describe the lower breadth sweep Ge; make Nb equal to the proposed radius of the floor sweep, and from the centre b describe the floor sweep Nf. Let the radius of the reconciling sweep be Ag, equal to about the half of AC; then make Ab equal to Nb, and Am equal to Ga. Now from the centre a, with an extent equal to gm, describe an arch, and from the centre b, with the extent gb, describe an arch intersecting the former in c, which will be the centre of the reconciling sweep cf. Join Nm by an inverted curve, the centre of which may be in the line bN produced downwards; or it may be joined by two curves, or by a straight line if there is little rising; and hence the lower part of the main frame will be described.

In order to form the top timber, make Fk equal to such part of the half breadth, agreeable to the proposed round of the side, as one-seventh; join Hk, and make ki equal to about two-thirds of Hk: make the angle Hki equal to iHl; and from the centre l at the distance

Preliminary Problems.

43  
Of the midship frame.

45  
General precepts for describing it.

Preliminary Problems.

distance  $lH$  describe the arch  $Hi$ ; and from the centre  $o$ , the intersection of  $li$  and  $kF$  produced, describe the arch  $ik$ , and the top timber will be formed.

II. *To describe a main frame of an intermediate capacity, that is, neither too flat nor too sharp.*—Divide the line  $AX$  (fig. 6), which limits the head of the floor timber, into three equal parts; and make  $ab$  equal to one of them. Divide the line  $dB$ , the perpendicular distance between the load water line and the plane of the upper side of the keel, into seven equal parts; and set off one of these parts from  $d$  to  $c$ , and from  $c$  to  $m$ . Let  $GH$  be the lower deck, join  $Gm$ , and produce it to  $q$ . Draw the straight line  $Va$ , bisect it in  $n$ , and from the points  $n, a$ , describe arches with the radius  $Gq$  intersecting each other in  $P$ , which will be the centre of the arch  $na$ . The centre of the arch  $Vn$  is found by describing arches downwards with the same radius.

With an extent equal to once and a half of  $Be$ , describe arches from the points  $b, e$ , intersecting each other in  $A$ , and from this point as a centre describe the arch  $eb$ ; make  $al$  equal to  $dm$ , and join  $Am, Al$ . Then, in order to reconcile two arches so as to make a fair curve, the centres of these arches and of the points of contact must be in the same straight line. Hence the point  $k$  will be the centre of the arch  $dm$ , and  $o$  the centre of the arch  $al$ . The arch  $lm$  is described from the centre  $A$ .

To form the top timber, set back the tenth part of the half breadth from  $K$  to  $S$  upon the line of the second deck; then with an extent equal to two-thirds of the whole breadth describe an arch through the points  $S$  and  $H$ , the upper height of breadth. Again, make  $MI$  equal to the fifth part of the half breadth; describe an arch of a circle through the points  $S$  and  $T$ , taking the diagonal  $GB$  for the radius. As this arch is inverted in respect of the arch  $dS$ , the centre will be without the figure. Hence one-half of the main frame is formed, and the other half is described by similar operations.

*Remark.* This frame may be made more or less full by altering the several radii.

III. *To describe a main frame of a circular form.*—Let the several lines be drawn as before: Then make  $Oa$  (fig. 7.) equal to the half breadth  $Ga$ , and from the centre  $a$ , with the radius  $Ga$ , describe the arch  $bGcO$ . Let  $d$  be the head of the floor-timber, and  $dX$  the rising. Assume the point  $f$  in the arch, according to the proposed round of the second futtock, and describe the arch  $df$ ; the centre of which may be found as in the former method: from the centre  $a$ , with the distance  $ad$ , describe the arch  $dcO$ ; make  $dc$  equal to one-third of  $dO$ , and the angle  $dcb$  equal to  $cdh$ , and from the centre  $b$  describe the arch  $dc$ . The inverted arch  $cO$  may be described as before.

IV. *To describe a very full main frame.*—Let the vertical and horizontal lines be drawn as before: let  $b$ , fig. 8. be the floor-head, and  $bX$  the rising. Divide  $Gc$  into two equal parts in the point  $d$ , and upon  $cd$  describe the square  $dbac$ , in which inscribe the quadrant  $dea$ . Divide the line  $bd$  into any number of equal parts in the points  $O, N, M, L$ , and draw the lines  $Lm, Mc, Nn, Ob$ , perpendicular to  $db$ . Divide the line  $Gc$ , the depth of the hold, the rising being deducted, into the same number of equal parts in the points  $E, F, I, K$ , and make the lines  $E\phi, Fq, Ir, Kt$ , in the frame,

equal to the lines  $Ob, Nn, Mc, Lm$ , in the square, each to each respectively; and through the points  $G, \phi, q, r, s, b$ , describe a curve. The remaining part of the frame may be described by the preceding methods.

Preliminary Problems.

V. *To describe the main frame of a ship intended to be a fast sailer.*—The principal lines being drawn as before, let the length of the floor-timber be equal to half the breadth of the ship, and the rising one-fifth or one-sixth of the whole length of the floor-timber, which lay off from  $x$  to  $E$ , fig. 9. Through the point  $E$  draw the line  $Tx$  perpendicular to  $GC$ , and  $dE$  perpendicular to  $AG$ . Join  $Td$ , which bisect in  $B$ , and draw  $BF$  perpendicular thereto, and meeting  $CG$  produced in  $F$ , from the centre  $F$ , at the distance  $FT$ , describe the semicircle  $TdD$ . Divide  $G'l$  into any number of parts,  $VW$ , &c. and bisect the intervals  $DV, DW$ , &c. in the points  $X, Z$ , &c.; then, from the centre  $X$ , with the extent  $XV$ , describe the semicircle  $D\phi V$ , intersecting  $AG$  in  $b$ . Let  $VP$  be drawn perpendicular to  $GT$ , and  $bP$  perpendicular to  $AG$ , and the point of intersection  $P$  will be one point through which the curve is to pass. In like manner proceed for the others, and a curve drawn through all the points of intersection will be part of the curve of the main frame. The remaining part of the curve from  $E$  to  $Y$  will be composed of two arches, the one to reconcile with the former part of the curve at  $E$ , and the other to pass through the point  $Y$ , the centre of which may be found by any of the preceding methods. In order to find the centre of that which joins with the curve at  $E$ , make  $TR$  equal to the half of  $GD$ , and join  $ER$ , in which a proper centre for this arch may be easily found.

The portion  $G\phi E$  of the curve is a parabola, whose vertex is  $G$  and parameter  $GD$ .

For  $GD : G\phi : : G\phi : GV$  by construction.

Hence  $DG \times GV = G\phi^2$ , which is the equation for a parabola.

VI. *To describe a main frame of a middling capacity.*—

Let the length of the floor timber be equal to one-half of the breadth of the ship. Make  $Od$ , fig. 10. equal to one-fourth of the length of the floor timber, and draw the perpendicular  $dc$  equal to the rising, and divide it into two equal parts in the point  $e$ . Describe an arch through  $e$ , and the extremity  $a$  of the floor timber, the radius being equal to the half breadth, or more or less according to the proposed round of the floor head.—Then with the radius  $Ol$ , half the length of the floor timber, describe the arch  $eY$ .

Draw  $lm$  perpendicular to  $OA$ : bisect  $An$  in  $\phi$ , and draw the perpendicular  $\phi q$ . From the middle of  $A\phi$  draw the perpendicular  $rs$ , and from the middle of  $Ar$  draw the perpendicular  $tu$ . Make  $nz, \phi g$ , each equal to  $ln$ : make the distances  $\phi y, rb$ , each equal to  $ag$ ;  $rF, tE$ , each equal to  $ab$ ; and  $tx$  equal to  $aE$ . Then a curve drawn through the points  $a, z, y, F, x, T$ , will form the under part of the midship frame.

We shall finish these methods of describing the main frame of a ship with the following remark from M. Vial du Clairbois †. “It seems (says he) that they have affected to avoid straight lines in naval architecture; yet, geometrically speaking, it appears that a main frame formed of straight lines will have both the advantage and simplicity over others.” To illustrate this, draw the straight line  $MN$  (fig. 9.) in such a manner that the mixtilineal space  $Mad$  may be equal to the mix-

† *Architecture Navale*, p. 22.



elimina- y Pro- lems.   
 ité du vire de guer, 01.   
 mixtilineal space  $DNY$ . Hence the capacity of the main frame formed by the straight lines  $MN$ ,  $NY$  will be equal to that of the frame formed by the curve  $MaDY$ ; and the frame formed by the straight lines will for the most part be always more susceptible of receiving a bow that will easily divide the fluid. It is also evident, that the cargo or ballast, being lower in the frame formed of straight lines than in the other, it will therefore be more advantageously placed, and will enable the ship to carry more sail ( $c$ ); so that having a bow equally well or better formed, she will sail faster.

PROB. VI. To describe a stern having a square tuck.

Let  $AB$  (fig. 11.) be the middle line of the post, and let  $CD$  be drawn parallel thereto at a distance equal to half the thickness of the post. Make  $CE$  equal to the height of the lower part of the fashion-piece above the keel: make  $CT$  equal to the height of the extremity  $G$  of the transom above the plane of the keel produced, and  $CH$  equal to the height of the transom on the post,  $HT$  being equal to above one-ninth or one-tenth of  $GT$ , and describe the arch  $GH$ , the centre of which will be in  $BA$  produced: make  $EK$  equal to five-twelfths of  $ET$ : through  $K$  draw  $KL$  perpendicular to  $CD$ , and equal to  $EK$ ; and with an extent equal to  $EL$  describe the arch  $EL$ . Make  $GI$  equal to the half of  $ET$ , and from the centre  $I$  describe the arch  $GM$ , and draw the reconciling curve  $ML$ .— Let the curve of the fashion-piece be produced upwards to the point representing the upper height of breadth, as at  $O$ . Make  $ON$  equal to the height of the top-timber, and  $BN$  equal to the half breadth at that place, and join  $ON$ . Through  $N$  and the upper part of the counter, let arches be described parallel to  $GH$ . The taffarel, windows, and remaining part of the stern, may be finished agreeable to the fancy of the artist.

In fig. 12. the projection of the stern on the plane of elevation is laid down, the method of doing which is obvious from inspection.

If the transom is to round aft, then since the fashion pieces are always sided straight, their planes will intersect the sheer and floor planes in a straight line. Let  $Gg$  (fig. 14.) be the intersection of the plane of the fashion-piece with the floor plane. From the point  $g$  draw  $gW$  perpendicular to  $gM$ : make  $yk$  equal to the height of the tuck, and  $Wk$  being joined will be the intersection of the plane of the fashion-piece with the sheer plane. Let the water lines in the sheer plane produced meet the line  $kW$  in the points  $a, s, b$ , and draw the perpendiculars  $aa, ss, bb$ . From the points  $a, s, b$  (fig. 14.) draw lines parallel to  $Gg$  to intersect each corresponding water line in the floor plane in the points  $3, 2, 1$ . From the points  $G, 3, 2, 1$  in the floor plane draw lines perpendicular to  $gM$ , intersecting the water lines (fig. 13.) in the points  $G, 3, 2, 1$ ; and through these points describe the curve  $G321k$ ; and  $WG32, 1k$  will be the projection of the plane of the fashion-piece on the sheer plane. Through the points  $G, 3, 2, 1$  (fig. 13.) draw the lines  $GF, 3A, 2S, 1H$ , perpendicular to  $Wk$ ; and make the lines  $WF, aA, sS,$

$bH$ , equal to the lines  $gG, a3, s2, b1$  (fig. 14.) respectively, and  $WFASHk$  will be the true form of the plane of the aft side of the fashion-piece. When it is in its proper position, the line  $WF$  will be in the same plane with the sheer line; the line  $aA$  in the same plane with the water line  $a3$ ; the line  $sS$  in the same plane with the water line  $s2$ ; and the line  $bH$  in the same plane with the water line  $b1$ . If lines be drawn from the several points of intersection of the water lines with the rabbet of the post (fig. 13), perpendicular to  $gM$ , and curved lines being drawn from these points to  $G, 3, 2, 1$  (fig. 14.) respectively, will give the form and dimensions of the tuck at the several water lines.

PROB. VII. To bevel the fashion-piece of a square tuck by water-lines.

As the fashion-piece both rakes and cants, the planes of the water-lines will therefore intersect it higher on the aft than on the fore-side: but before the heights on the fore-side can be found, the breadth of the timber must be determined; which let be  $bn$  (fig. 15.) Then, as it cants, the breadth in the direction of the water-line will exceed the true breadth. In order to find the true breadth, form the aft-side of the fashion-piece as directed in the last problem.

Let  $t5$  (fig. 13.) be the aft-side of the rabbet on the outside of the post,  $WM$  the common section of the plan of the fashion-piece and the sheer-plan. Before this last line can be determined, the several water-lines 1, 2, 3, 4, and 5, must be drawn parallel to the keel, which may represent so many transoms.— Let these water lines be formed and ended at the aft-side of the rabbet, as in fig. 14. where the rounds aft of the several transoms are described, limiting the curves of the water lines. Now the line  $WM$  must rake so as to leave room for half the thickness of the post, at the tuck: in order to which, produce  $Wg$  to  $r$ ; make  $rg$  half the thickness of the post; through  $r$  draw a line parallel to  $gM$  to intersect  $gG$  in  $b$ : then with the radius  $rb$ , from  $x$  the point of the tuck as a centre, describe an arch, and draw the line  $WM$  just to touch the back of that arch.

The line  $WM$  being drawn, let any point  $k$  in it be assumed at pleasure: from  $k$  draw  $ky$  perpendicular to  $gM$ : through  $y$  draw  $yf$  (fig. 14.) parallel to  $gG$ , intersecting the line  $Mf$  drawn perpendicular to  $gM$  in the point  $f$ . From  $M$  draw  $Mi$  perpendicular to  $yf$ , and from  $y$  draw  $yn$  perpendicular to  $WM$  (fig. 13.) Make  $Mn$  (fig. 15.) equal to  $Mi$  (fig. 14.); then  $Mi$  (fig. 15.) being equal to  $yk$  (fig. 13), join  $ni$ , and the angle  $inM$  will be the bevelling to the horizontal plane. Again, make  $Mz, Mj$  (fig. 15.) respectively equal to  $yn$  (fig. 13.) and  $Mf$  (fig. 14.), and join  $zj$ ; and the angle  $Mzj$  will be the bevelling to the sheer plane.

The bevelling being now found, draw the line  $ab$  (fig. 15.) parallel to  $zn, az$  or  $bn$  being the scantling of the timber. Then  $nx$  will be the breadth of the timber on the horizontal plane, and  $xc$  its breadth on the sheer plane, and  $ac$  what it is within a square.

Now as the lines  $gG, a3, s2, b1, yi$ , represent the

(c) It is not a general rule, that lowering the cargo of a ship augments her stability. This is demonstrated by the Chevalier de Borda, in a work published by M. de Goinpy upon this subject. See also *L'Architecture Navale par M. Vial du Clairbois*, p. 23.

Preliminary Problems.

the aft side of the fashion-piece on the horizontal plane (fig. 14.), dotted lines may be drawn parallel to them to represent the fore-side, making  $nx$  (fig. 15.) the perpendicular distance between the lines representing fore and aft sides of the fashion-piece. By these lines form the fore-side of the fashion-piece in the same manner as the aft-side was formed. The water lines on the fore-side of the plane of the fashion piece must, however, be first drawn in fig. 13. thus: Draw the lines  $eb, cd$  parallel to  $WM$ , and whose perpendicular distances therefrom may be equal to  $ac$  and  $ze$  (fig. 15.) respectively. Draw a line parallel to  $WF$  (fig. 13.) through the point where the line  $cd$  intersects the fifth water line. Draw a line parallel to  $aA$  through the point where the fourth water line intersects the line  $cd$ ; in like manner proceed with the other water lines. The fore-side of the fashion-piece is now to be described by means of these new water lines, observing that the distances in the floor plane must be set off from the line  $eb$ , and not from  $WM$ , as in the former case; and a curve described through the points 5, 3, 2, 1, where these distances reach to, will represent the fore-side of the fashion-piece.

The nearest distance between the points 5, 3, 2, 1 and the aft side of the fashion-piece is what the bevelling is beyond the square when both stock and tongue of the bevel are perpendicular to the timber. Make  $M\rho$  (fig. 16.) equal to the breadth of the timber, and  $M5$  equal to the perpendicular distance of the point 5 (fig. 13.) from the aft side of the fashion piece, and join  $5\rho$ . In like manner proceed with the others, and the bevellings at these parts will be obtained; but, in order to avoid confusion, the perpendiculars 4, 3, 2, (fig. 13.), instead of being laid off from  $M$  (fig. 16.), were set off from points as far below  $M$  as the other extremities of the lines drawn from these points are below the point  $\rho$ .

PROB. VIII. To describe the transoms of a round poop.

The transoms are fastened to the stern-post in the same manner that the floor-timbers are fastened to the keel, and have a rising called the *flight* similar to the rising of the floor-timbers. The upper transom is called the *wing* transom, the next the *deck* transom, and the others the *first*, *second*, and *third* transoms in order. The wing transom has a round aft and a round up: the round up of the deck transom is the same as that of the beams.

The fashion-piece of a square tuck must be first described, together with the three adjacent frames, by the method to be explained. The part of the stern above the wing transom is to be described in the same manner as before, and may therefore be omitted in this place. The part below the keel of the fashion-piece is also the same in both cases. Let fig. 17. represent the fashion-piece of a square tuck, and the three adjoining frames. Divide the interval  $AB$  into four equal parts in the points  $C, D, E$ , and draw the perpendiculars  $AF, CG, DH, EI$ , and  $EK$ : these will be portions of water lines answering to the several transoms.

Let these water lines be described on the floor plan (fig. 18.), in which  $ABC$  represents the wing transom. Describe the arch  $bC$  to reconcile the curves  $Ab$  and  $CE$ . Let  $LFG$  be the water line answering to the lower part of the fashion-piece, the distance be-

tween the points  $L$  and  $A$  being equal to the excess of the projection of the point  $A$  beyond that of  $B$  (fig. 20.). Draw  $CK$  (fig. 18.) perpendicular to  $AM$ , and make the angle  $KCM$  equal to about 25 degrees, and  $CN$  will be the projection of the fashion-piece on the floor-plane. Make  $AB$  (fig. 19.) equal to  $AB$  (fig. 17.) Divide it into four equal parts, and draw the perpendiculars  $AF, CH, DI, EK$ , and  $BG$ . Make  $AF$  equal to  $CM$ , and  $BG$  equal to  $MN$ , and draw the curve  $FHIKG$ , having a less curvature than the fashion-piece of the square tuck  $scpgn$ . Make  $MO, MP, MQ$ , equal to  $CH, DI$ , and  $EK$  respectively. Divide  $AL$  (fig. 18.) into four equal parts, and to these points of division draw curves through the points  $O, P, Q$ , so as to partake partly of the curvature of  $AbCE$  and partly of that of  $LNF$ , but most of the curvature of that to which the proposed curve is nearest; and hence the form of the several transoms will be obtained.

In order to represent the curve of the fashion-piece on the plane of projection, make the lines  $AF, CG, DH, EI$ , and  $BK$  (fig. 17.) respectively equal to the perpendicular distance of the points  $C, O, P, Q$ , and  $N$ . From the line  $AN$  (fig. 18.), and through the extremities of these lines, draw the curve  $FGHIK$ .

It remains to lay down the projection of the fashion-piece on the plane of elevation. In order to which, divide the line  $AB$ , fig. 20. (equal to  $AB$ , fig. 17.) into four equal parts, and through the points of division draw the perpendiculars  $AF, CG, DH, EI$ , and  $BK$ ; make  $AF$  (fig. 20.) equal to the perpendicular distance of the point  $C$  from the line  $BL$  (fig. 18.) In like manner make the lines  $CG, DH, EI$ , and  $BK$  (fig. 20.) respectively equal to the perpendicular distances of the points  $O, P, Q$ , and  $N$ , from the line  $BL$  (fig. 18.); and a curve drawn through these points will be the projection of the fashion-piece on the plane of elevation.

PROB. IX. To describe the intermediate frames in the after body.

For this purpose the midship and stern frames must be drawn in the plane of projection. As the main frame contains the greatest capacity, and the stern frame is that having the least, it hence follows that the form and dimensions of the intermediate frames will be between these; each frame, however, partaking most of the form of that to which it is nearest.

Let  $ACDE$  (fig. 21.) be the main frame on the plane of projection, and  $FGH$  the stern frame; and let there be any convenient number of intermediate frames, as *nine*. Draw the floor ribband  $CF$ , and the breadth ribband  $GD$ . Divide the curves  $CD, FG$ , each into the same number of equal parts, as three, in the points  $K, M; L, N$ ; and draw the second and third ribbands  $KL, MN$ . In order to divide these ribbands so as to form fair curves in different sections, various methods have been proposed. One of the best of these, being that which is chiefly employed by the French constructors, is by means of an equilateral triangle, which is constructed as follows.

Draw the line  $ME$  (fig. 22.), limited at  $M$ , but produced towards  $E$ : take  $M1$  equal to any convenient extent; make 1, 2 equal to thence that extent, 2, 3 equal to five times, and 3, 4 equal to seven times the above extent; and continue this division to  $E$ , always increasing by two, until there be as many points as there are

Plate  
cccclviii

Fig. 7.

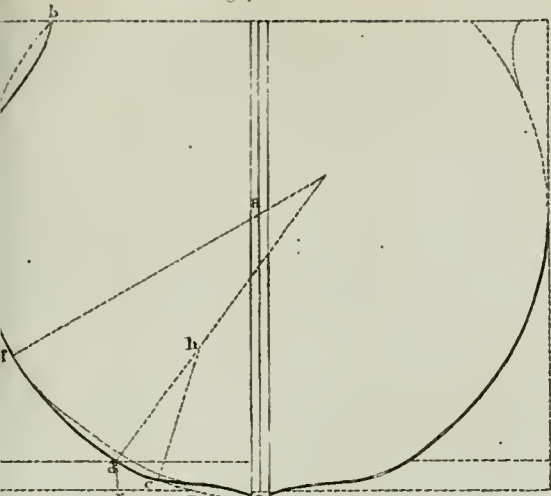

Fig. 8.

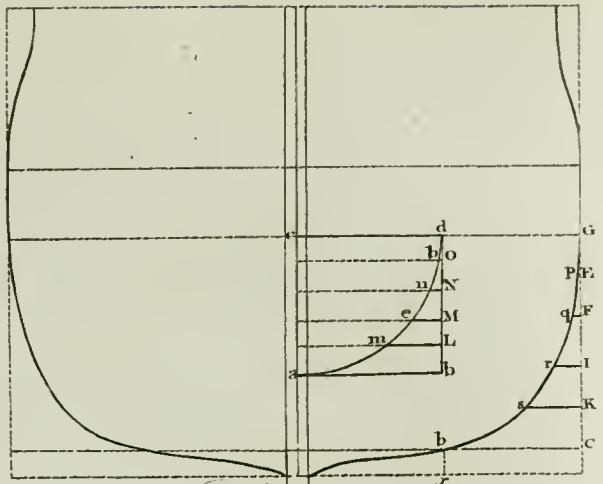

Fig. 9.

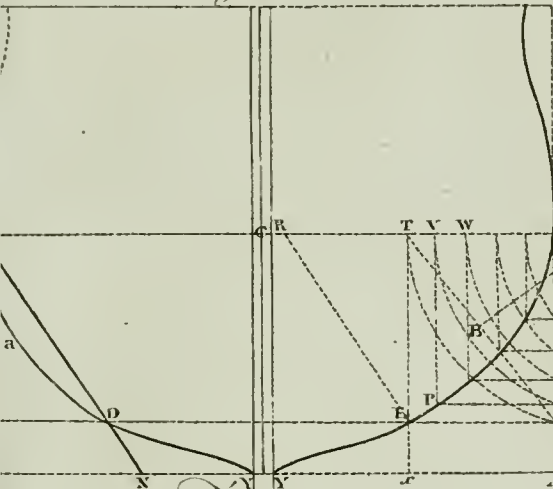

Fig. 10.

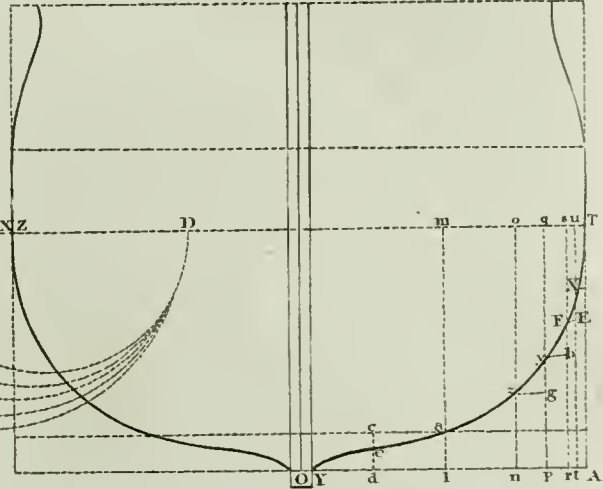

Fig. 11.

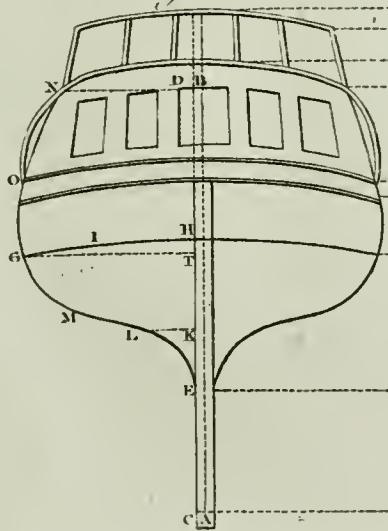
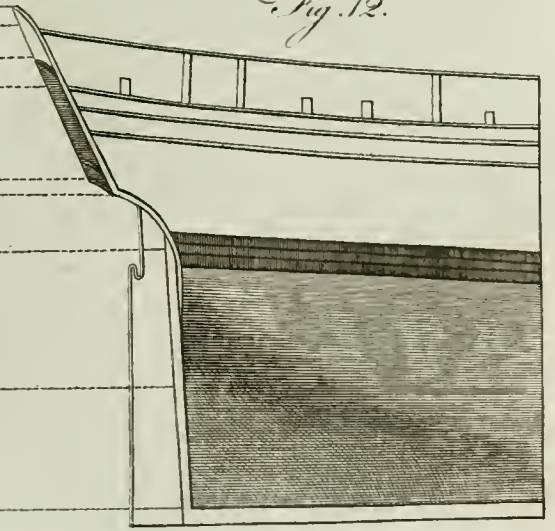

Fig. 12.





SHIP - BUILDING

*Fig. 13.*

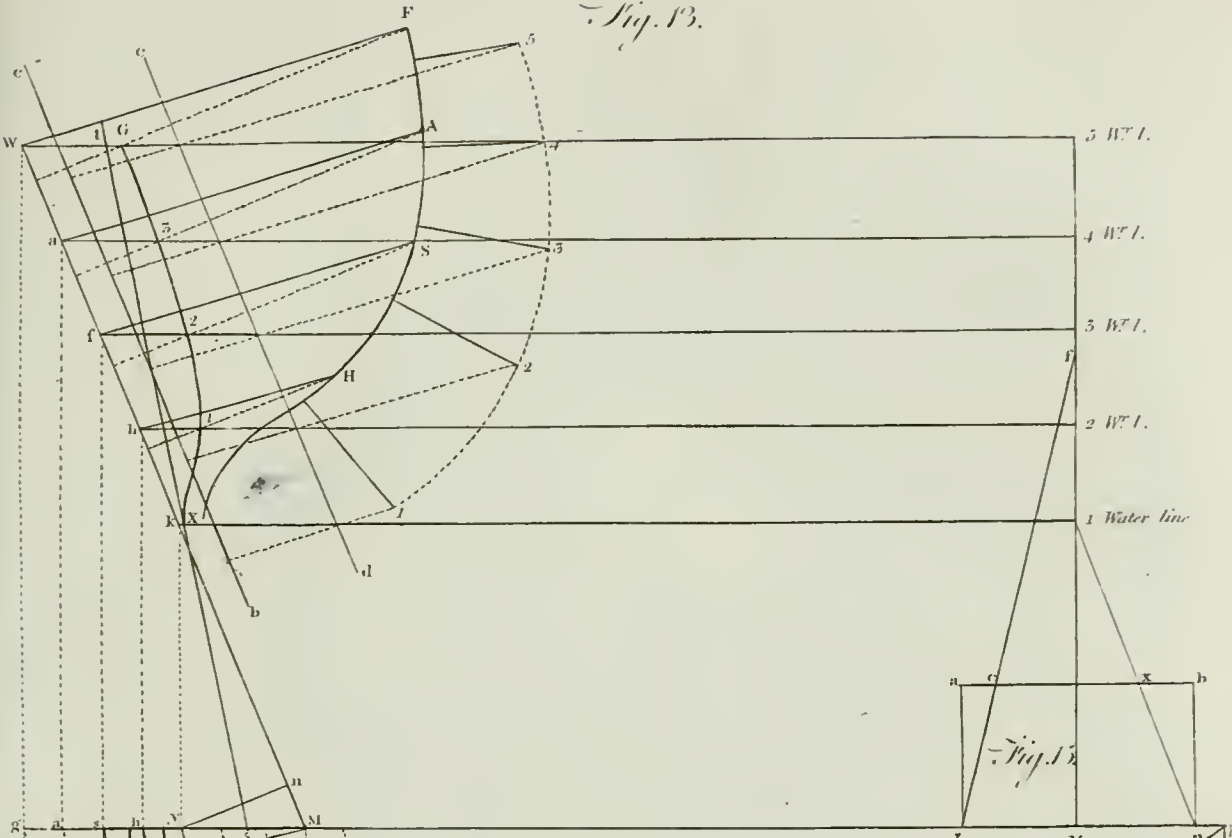

*Fig. 14.*

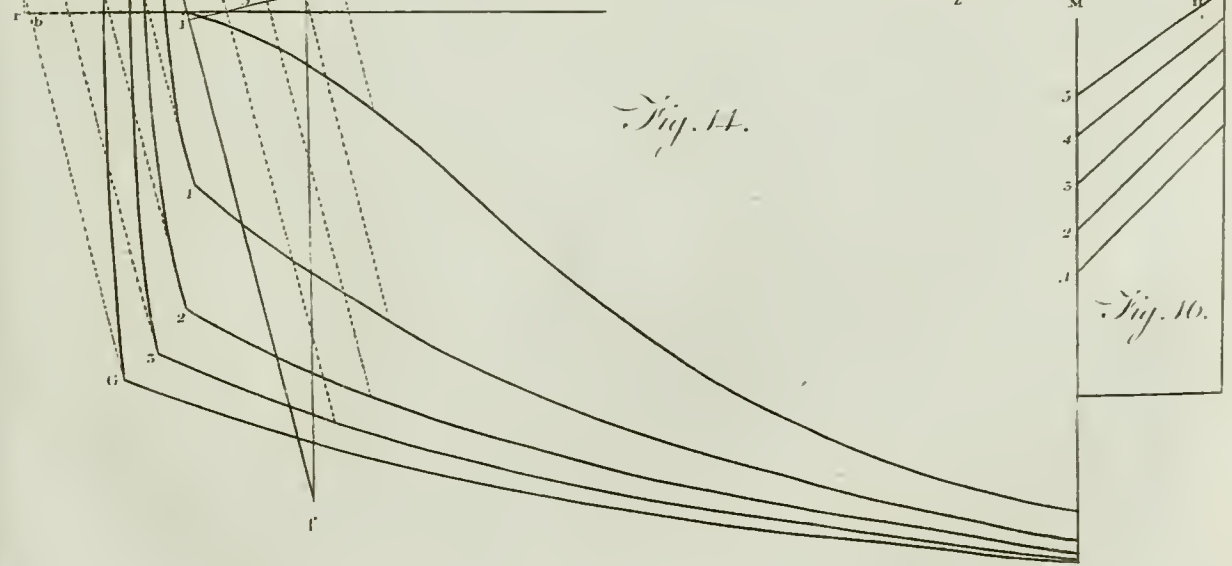



limina- are frames, including the main and stern frames. Up- Preliminary Pro-blems. on ME describe the equilateral triangle MSE, and draw lines from the vertex S to each point of division; then the line SM will be that answering to the main frame, and SE that corresponding to the post; and the other lines will be those answering to the intermediate frames in order.

Let fig. 23. be the projection of part of the stern on the plane of elevation, together with the eighth and ninth frames. From the points L, N, G, (fig. 21.) draw the lines LO, NP, GQ, perpendicular to the plane of the upper edge of the keel. Make AB (fig. 23.) equal to AF (fig. 21.), and draw the water line BCD. Draw the line BC (fig. 22.) so that it may be parallel to the base of the triangle, and equal to CD (fig. 23.), which produce indefinitely towards H. Make BD equal to BC (fig. 23.), and draw the dotted line SD (fig. 22.) The ribband FC (fig. 21.) is to be applied to the triangle, so that it may be parallel to the base, and contained between the line MS and the dotted line SD. Let *cf* represent this line; then transfer the several divisions from *cf* to the ribband CF (fig. 21.), and number them accordingly. Again, make EF (fig. 23.) equal to LO (fig. 21.), and draw the water line FGH; make BF (fig. 22.) equal to FG (fig. 23.), and draw the dotted line SF; apply the second ribband LK to the triangle, so that the extremity K may be on the line SM, and the other extremity L on the dotted line SF, and making with SM an angle of about  $62\frac{1}{2}$  degrees. Let *kl* be this line, and transfer the divisions from it to the ribband KL. In like manner make IK (fig. 23.) equal to NP (fig. 21.), and draw the water line KLM. Make BG (fig. 22.) equal to KL (fig. 23.), and draw the dotted line SG; then the ribband MN is to be applied to the triangle in such a manner that its extremities M and N may be upon the lines SM, SG respectively, and that it may make an angle of about 68 degrees with the line SM; and the divisions are to be transferred from it to the ribband MN. The same process is to be followed to divide the other ribbands, observing to apply the fourth ribband to the triangle, so that it may make an angle of 86 degrees with the line SM; the fifth ribband to make an angle of 65 degrees, and the sixth an angle of 60 degrees with the line SM.

The quantities of these angles are, however, far from being precisely fixed. Some constructors, in applying the ribbands to the triangle, make them all parallel to its base; and others vary the measures of these angles according to fancy. It may also be remarked, that a different method of dividing the base of the triangle is used by some. It is certainly proper to try different methods; and that is to be preferred which best answers the intended purpose.

Beside the frames already mentioned, there are other two laid down by some constructors in the several plans, called *balance frames*. The after balance frame is placed at one fourth of the length of the ship before the stern-post; and the other, commonly called the *loof frame*, at one fourth of the ship's length aft of a perpendicular to

the keel from the rabbet of the stem. Let the dotted line at X, between the fifth and sixth frames, (fig. 23.) be the place of the after balance frame in the plane of elevation. Then, in order to lay down this frame in the plane of projection, its representation must be previously drawn in the triangle. To accomplish this, draw the line SV (fig. 22.) so that the interval *5V* may have the same ratio to *56* (fig. 22.) that *5X* has to *56* (fig. 23.) (D). Then the several points in the ribbands in the plane of projection answering to this frame are to be found by means of the triangle in the same manner as before.

The loof frame is nearly of the same dimensions as the after balance frame, or rather of a little greater capacity, in order that the centre of gravity of that part of the ship may be nearly in the plane of the midship frame. Hence the loof frame may be easily drawn in the plane of projection, and hence also the other frames in the fore body may be readily described.

PROB. X. To describe the frames in the fore body.

Draw the middle line of the stem AB (fig. 24.); make AC, BD each equal to half the thickness of the stem, and draw the line CD; describe also one half of the main frame CEFGLH. Let *eE*, *fF*, *gG*, *hH*, be water lines at the heights of the ribbands on the main frame; also let *a* be the termination of the floor ribband, and *b* that of the breadth ribband on the stem. Divide the interval *ab* into three equal parts in the points *c*, *d*, and draw the ribbands *aE*, *cF*, *dG*, and *bH*. Make *ei*, *fk*, *gl*, *hm* (fig. 24.) equal to *ei*, *fk*, *gl*, *hm* (fig. 21.) respectively, and draw the curve *Ciklm*, which will be the projection of the loof frame. Or since it is necessary that the capacity of the loof frame should be a little greater than that of the after balance frame, each of the above lines may be increased by a proportional part of itself, as one-tenth or one-twentieth, as may be judged proper.

Construct the triangle (fig. 25.) in the same manner as fig. 22. only observing, that as there are fewer frames in the fore than in the after body, its base will therefore be divided into fewer parts. Let there be eight frames in the fore body, then there will be eight divisions in the base of the triangle beside the extremes.

Let fig. 26. represent the stem and part of the fore-body in the plane of elevation, and let O be the place of the loof frame. Divide the interval *4, 5* (fig. 25.) so that *4, 5* may be to *4Z* as *4, 5* to *4, 0* (fig. 26.), and draw the dotted line SZ, which will be the line denoting the loof frame in the triangle.

Draw the lines AB, CD, EF, GH (fig. 26.) parallel to the keel, and whose perpendicular distances therefrom may be equal to *Ca*, *Cc*, *Cd*, *Cb*, (fig. 24.) the interfections of these lines with the rabbet of the stem, namely, the points I, K, L, M will be the points of termination of the several ribbands on the stem in the plane of elevation. Divide *8A* (fig. 25.) so that *8B*, *8C*, *8D*, and *8E*, may be respectively equal to *BI*, *DK*, *FL*, and *HM* (fig. 26.), and draw the dotted lines SB, SC, SD, SE (fig. 25.) Apply the edge of a slip of card to the first ribband (fig. 24.), and mark thereon

(D) It is evident, from the method used to divide the base of the triangle, that this proportion does not agree exactly with the construction: the difference, however, being small, is therefore neglected in practice.

Preli-  
minary  
Pro-  
blems.

thereon the extremities of the ribband  $a, E$ , and also the point of intersection of the loof frame. Then apply this slip of card to the triangle in such a manner that the point  $a$  may be on the dotted line  $SB$ , the point  $E$  on the line  $SM$ , and the point answering to the loof frame on the dotted line  $SZ$ ; and mark upon the card the several points of intersection of the lines  $S1, S2, \&c.$  Now apply the card to the ribband  $aE$  (fig. 24.) as before, and transfer the several points of division from it to the ribband. In like manner proceed with the other ribbands; and lines drawn through the corresponding points in the ribbands will be the projection of the lower part of the frames in the fore body. The projections of the top-timbers of the several frames may be taken from the half breadth plan; and hence each top-timber may be easily described.

In large ships, particularly in those of the French navy, a different method is employed to form the top-timbers in the fore body, which is as follows:

Plate  
CCCLIX.

Let  $BI$  (fig. 27.) be one fourth of the breadth of the ship, and draw  $IK$  parallel to  $AB$ . Take the height of the foremost frame from the plane of elevation, and lay it off from  $A$  to  $B$ : from the point  $B$  draw  $BII$  perpendicular to  $AB$ , and equal to half the length of the wing transom. Let  $E$  be the place of the breadth ribband on the main frame, and  $F$  its place on the stem at the height of the wing transom. With a radius equal to five-sixths of half the greatest breadth of the ship describe the quadrant  $EFG$  (fig. 28.): Make  $EH$  equal to  $FG$  (fig. 27.), the point  $F$  being at the height of the wing transom. Through  $H$  draw  $HO$  perpendicular to  $EH$ , and intersecting the circumference in  $O$ ; then draw  $OL$  parallel to  $HE$ , and  $EL$  parallel to  $HO$ . Divide  $EL$  into as many equal parts as there are frames in the fore body, including the main frame, and from these points of division draw the perpendiculars  $11, 22, \&c.$  meeting the circumference as in the figure. Take the distance  $11$ , and lay it off from  $G$  (fig. 27.) towards  $F$  to the point  $1$ ; and from the same point  $G$  lay off towards  $F$  the several perpendiculars contained between the straight line and the curve to the points  $2, 3, \&c.$  and through these points draw lines parallel to  $EG$ .

Take any line  $AB$  (fig. 29.) at pleasure: divide it equally in two in the point  $8$ ; divide  $8B$  in two parts in the point  $7$ , and continue this method of division until there are as many points as there are frames in the fore body, including the main frame. Upon  $AB$  construct the equilateral triangle  $ACB$ , and draw the lines  $C8, C7, \&c.$  Place a slip of card on the parallel  $aK8$  (fig. 27.), and mark thereon the points opposite to  $a, K$ , and  $8$ ; and let them be denoted accordingly. Then apply this slip of card to the triangle, so that the point  $a$ , which is that answering to the rabbet of the stem, may be on the line  $AC$ ; that the point answering to  $K$  may be on  $C8$ , and the extremity  $8$  on the line  $CB$ ; and mark on the card the points of intersection of the lines  $C7, C6, \&c.$  and number them accordingly. Now apply this slip of card to the seventh parallel (fig. 23.), the point  $a$  being on the line  $CD$ , and mark on this parallel the point of intersection  $7$ ; slide the card down to the sixth parallel, to which transfer the point  $n^o 6$ . In like manner proceed with the other parallels.

The point  $K$ , at the intersection of the line  $IK$  with

the eighth parallel, is one point through which the eighth frame passes. From this point upwards a curve is to be described so as to reconcile with the lower part of this frame already described, and the upper part, forming an inverted arch, which is to terminate at  $H$ . This top-timber may be formed by two sweeps, whose radii and centres are to be determined partly from circumstances and partly according to fancy. It however may be more readily formed by hand.

Let  $LM$  (fig. 27.) be the line of the second deck at the main frame, and let  $LN$  be the difference of the draught of water, if any. Make  $GN$  (fig. 28.) equal to  $LN$ ; draw  $NM$  perpendicular to  $GN$ , meeting the circle in  $M$ ; and through the points  $G$  and  $M$  draw the parallels  $GV$  and  $MV$ ; divide  $GN$  as before, and from the several points of division draw perpendiculars terminating in the curve. Transfer these perpendiculars from  $L$  upwards (fig. 27.), and through the points thus found draw the lines  $11, 22, \&c.$  parallel to  $LM$ . Apply a slip of card to the eighth parallel, and mark upon it the point answering to the stem, the eighth and main frames: carry this to the triangle, and place it so that these points may be on the corresponding lines. Then the points of intersection of the lines  $C7, C6, \&c.$  are to be marked on the card, which is now to be applied first to the eighth parallel (fig. 27.), then to the seventh,  $\&c.$  transferring the several points of division in order as before.

Draw the line  $HO$  (fig. 27.); mark its length on a slip of card, and apply it to the triangle, so that it may be parallel to its base, and its extremities one on the eighth and the other on the main frame: mark on the card the points of intersection of the several intermediate lines as before; then apply the card to  $HO$ , and transfer the divisions.

There are now three points determined through which each top-timber must pass, namely, one in the breadth ribband, one in the fifth, and one in the upper ribband. Through these curves are to be described, so as to reconcile with the lower part of the frame, and partake partly of the curvature of the eighth frame, and partly of that of the main frame, but most of that of the frame to which it is nearest; and hence the plane of projection is so far finished, that it only remains to prove the several frames by water lines.

Another method of describing the frames in the body plan is by sweeps. In this method it is necessary, in the first place, to describe the height of the breadth lines, and the rising of the floor, in the plane of elevation. The half breadth lines are next to be described in the floor plan. The main frame is then to be described by three or more sweeps, and giving it such a form as may be most suitable to the service the ship is designed for. The lower, upper, and top-timber heights of breadth, and the risings of the floor, are to be set upon the middle line in the body plan, and the several half breadths are then to be laid off on lines drawn through these points perpendicular to the middle line. A mould may then be made for the main frame, and laid upon the several risings, as in whole mouldings, explained in Chapter V. with this difference, that here an under breadth sweep is described to pass through the point which limits the half breadth of the timber, the centre of which will be in the breadth line of that timber. The proper centres for all the frames being found, and the



*Fig. 17.*

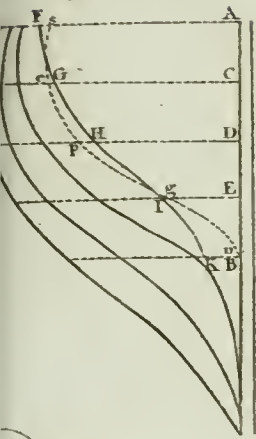

*Fig. 18.*

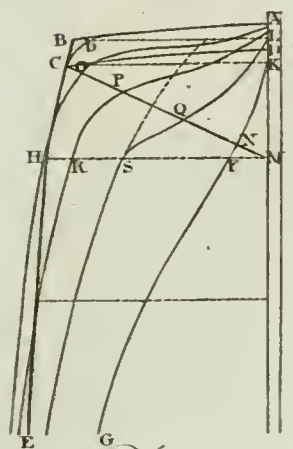

*Fig. 19.*

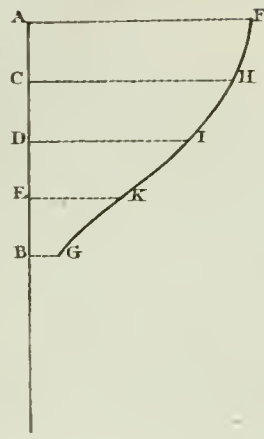

*Fig. 20.*

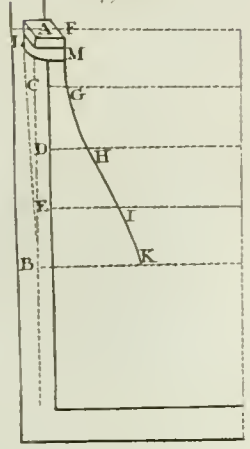

*Fig. 21.*

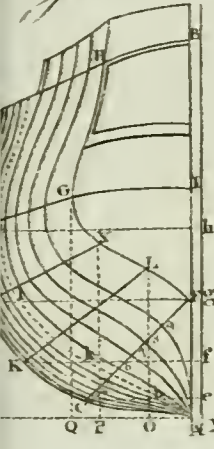

*Fig. 22.*

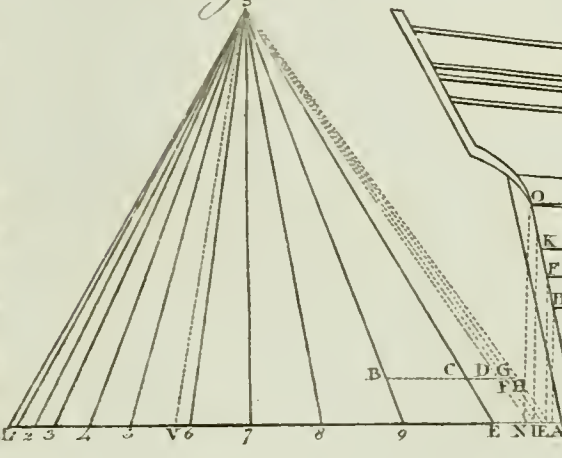

*Fig. 23.*

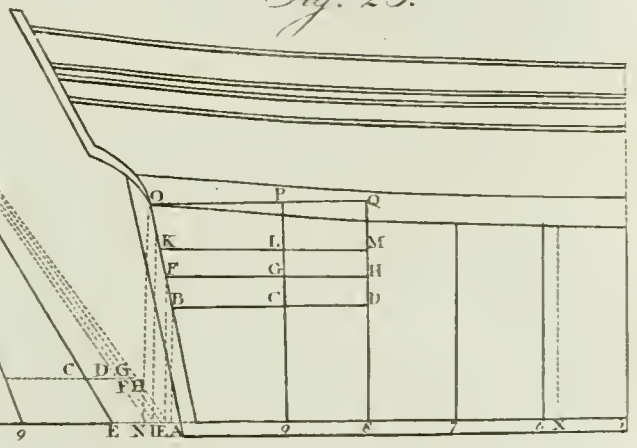

*Fig. 24.*

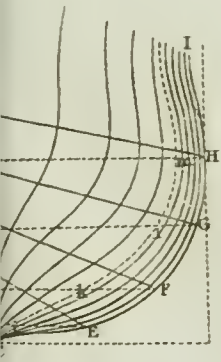

*Fig. 25.*

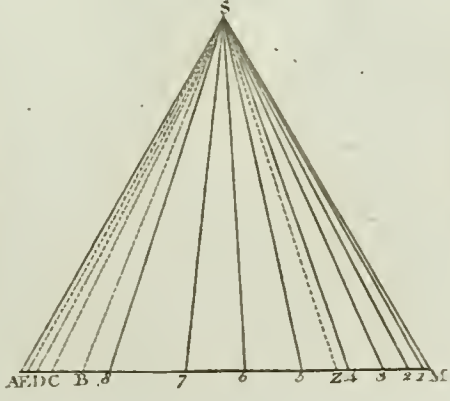

*Fig. 26.*

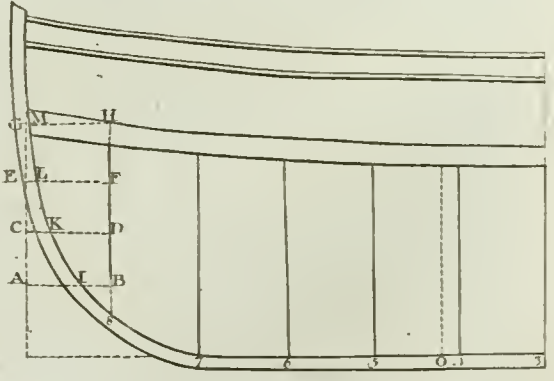

*Ed. de l'Im. de la France par.*



limina- the arches described, the bend mould must be so placed on the rising line of the floor, that the back of it may touch the back of the under breadth sweep. But the general practice is, to describe all the floor sweeps with compasses, as well as the under breadth sweeps, and to reconcile these two by a mould which is an arch of a circle, its radius being the same with that of the reconciling sweep by which the midship frame was formed. It is usual for all the floor sweeps to be of the same radius; and in order to find their centres a line is formed on the floor plan for the half breadth of the floor. As this line cannot be described on the surface of a ship, it is therefore only an imaginary line. Instead of it some make use of a diagonal in the body plan to limit the half breadth of the floor upon every rising line, and to erect perpendiculars at the several intersections, in the same manner as for the midship frame.

After the sweeps are all described, recourse is had to moulds, or some such contrivance, to form the hollow of the timbers, much in the same manner as in whole moulding; and when all the timbers are formed, they must be proved by ribband and water lines, and altered, if necessary, to make fair curves.

The preceding methods of describing the several planes or sections of a ship being well understood, it will be a very easy matter to construct draughts for any proposed ship: and as the above planes were described separately and independent of each other, it is therefore of little consequence which is first described. In the following application, however, the plane of elevation will be first drawn, then part of the floor plan, and lastly the body plan: and in connecting these plans the most rational and simple methods will be employed.

CHAP. IV. *Application of the foregoing Rules to the Construction of Ships.*

SECT. I. *To construct a Ship intended to carry a considerable Burden in Proportion to her general Dimensions, and to draw little Water.*

DIMENSIONS.

Length between the wing transom and a perpendicular from the rabbet of the stem at the height of breadth line	F.	In.
Main half breadth moulded	11	0
Half breadth at the height of breadth line at the stern	7	6
Top-timber half breadth	10	6
Height of the stem above the upper edge of the keel	17	0
Height of the breadth line at the stem	13	6
Height of the breadth line at the stern	12	3
Upper height of breadth at the main frame	7	4
Lower height of breadth	5	10
Height of middle line of wales at the stem	10	0
Height of middle line of wales at the main frame	6	10
Height of middle line of wales at the stern	10	6
Breadth of the wales	1	9
Height of top-timber at midships	14	0
----- at stern	18	0

Draw the line  $ab$  (fig. 30.) equal to 80 feet, from a convenient scale: divide it into as many equal parts plus one as there are to be frames, which let be 16, and through each point of division draw perpendiculars. Make  $bc$  equal to 17 feet, the perpendicular height of the top of the stem above the upper edge of the keel, and describe the stem by Prob. II. Make  $ad$  equal to  $10\frac{1}{2}$  feet, the height of the middle line of the wales at the stern, and  $ae$  equal to the proposed rake of the post, which may be about 2 feet; join  $de$ ; and draw the line  $fg$  representing the aft-side of the post. Describe the counter and stern by Problem VI. and VII. Make  $\odot b$  equal to 14 feet, the top-timber height at the main frame, and  $ik$  equal to 18 feet, the height at the stern; and through the three points  $c, b, k$ , describe the curve limiting the top-timbers by Problem I. Make  $bd$  equal to 10 feet, the height of the middle line of the wales at the stem, and  $\odot H$  equal to 6 feet 10 inches, the height at the main frame; and the curve  $dHd$  being described will represent the middle line of the wales. At the distance of  $10\frac{1}{2}$  inches on each side of this line draw two curves parallel thereto, and the wales will be completed in this plan. Make  $bl$  equal to  $13\frac{1}{2}$  feet, the height of the breadth line at the stem;  $am$  equal to  $12\frac{1}{2}$  feet, the height at the stern; and  $I \odot K \odot$  equal to 5 feet 10 inches and 7 feet 4 inches respectively; and draw the upper breadth line  $iKm$  and lower breadth line  $IIm$ . From the line  $ab$  lay downwards the breadth of the keel, which may be about one foot, and draw the line  $Ll$  parallel to  $ab$ .

Let the line  $Lr$ , which is the lower edge of the keel, represent also the middle line of the floor plan. Produce all the perpendiculars representing the frames: make  $\odot M$  (fig. 31.) equal to 11 feet, the main half breadth at midships; through  $m$  (fig. 30.) draw the line  $mN$  perpendicular to  $ab$ , and make  $pN$  equal to  $7\frac{1}{2}$  feet, and draw the main half breadth line  $NMr$  by Problem IV. Describe also the top-timber half breadth line  $POr$ ,  $\odot O$  being equal to  $10\frac{1}{2}$  feet, and form the projecting part of the stem  $qrst$ .

In order that the top-timber line may look fair on the bow, and to prevent the foremost top-timbers from being too short, it is necessary to lift or raise the sheer from the round of the bow to the stem. For this purpose the following method is usually employed: Produce the circular sheer before the stem in the plane of elevation at pleasure; then place a batton to the round of the bow in the half breadth plan, and mark on it the stations of the square timbers and the side of the stem; apply the batton to the sheer plan, and place it to the sheer of the ship, keeping the stations of the timbers on the batton well with those on the sheer plan for several timbers before dead-flat, where they will not alter; then mark the other timbers and the stem on the sheer line produced; through these points draw lines parallel to the keel, to intersect their corresponding timbers and the stem in the sheer plan: then a curve described these last points will be the sheer of the ship round the bow, lifted as required: and the heights of the timbers thus lengthened are to be transferred to the body plan as before.

Draw the line  $AB$  (fig. 32.) equal to 22 feet, the whole breadth; from the middle of which draw the perpendicular  $CD$ : make  $CE$  equal to half the thickness

Application of the foregoing Rules to the Construction of Ships.  
Plate CCCLXX.

Application of the fore going Rules to the Construction of Ships.

of the post, and CF equal to half that of the stem, and from the points A, E, F, B, draw lines parallel to CD. Make AG, DG each equal to 14 feet, the height at the main frame, and draw the line GG parallel to AB. Make GH, GH each equal to half a foot, the difference between the main and top timber half breadths. From A and B set up the heights of the lower and upper breadth lines to l and K, and draw the straight lines IK, IK. Let CL be the rising at the main frame, and  $\oplus$ ,  $\oplus$  the extremities of the floor timber. Hence, as there are now five points determined in each half of the main frame, it may be very easily described.

Make CM equal to L $\oplus$ , join M $\oplus$ , and draw the other ribbands NO, PQ. In order, however, to simplify this operation, the rectilinear distance  $\oplus$  was trisected, and through the points of division the lines NO, FQ were drawn parallel to the floor ribband M $\oplus$ .

Take the distance *bc* (fig. 30.), and lay it off from F to (fig. 32.); also make F*b* (fig. 32.) equal to F*u* (fig. 30.); through *b* draw *bc* parallel to AB, and equal to FR (fig. 31.). In like manner take the heights of each top-timber from fig. 30. and lay them off from C towards D (fig. 32); through these points draw lines parallel to AB, and make them equal each to each, to the corresponding half breadth lines taken from the floor plan: Then through the several points *a*, *c*, &c. thus found, draw a line *acH*, which will be the projection of the top-timber line of the fore body in the body plan. Proceed in the same manner to find the top-timber line in the after body.

Transfer the height of the main-breadth line on the stem *bl* (fig. 30.) from F to *d* (fig. 32.). Transfer also the heights of the lower and upper breadth lines at timber F (fig. 30.), namely; FW, FX, from F to *e* and *f* (fig. 32.); through which draw the parallels *eg*, *fb*; make them equal to FS (fig. 31.), and draw the straight line *gb*. In this manner proceed to lay down the portions of the extreme breadth at each frame, both in the fore and in the after body in the body plan, and draw the upper and lower breadth lines *dbK*, *dgI* in the fore body and *Ki*, *Ii* in the after body. Hence the portions of the several top-timbers contained between the top-timber and main breadth lines may be easily described. It was before remarked that their forms were partly arbitrary. The midship top-timber has generally a hollow, the form of which is left entirely to the artist, though in some ships, especially small ones, it has none. It is the common practice to make a mould for this hollow, either by a sweep or some other contrivance, which is produced considerably above the top-timber line, in a straight line or very near one; The midship top-timber is formed by this mould, which is so placed that it breaks in four with the back of the upper breadth sweep. The other top-timbers are formed by the same mould, observing to place it so that the straight part of it may be parallel to the straight part of the midship timber, and moved up or down, still keeping it in that direction till it just touches the back of the upper breadth sweep. Some constructors begin at the after timber, after the mould is made for the midship top-timber, because they think it easier to keep the straight part of the mould parallel to this than to the midship timber; and by this means the top side is kept from winding. Others, again, make a mark upon

the mould where the breadth line of the midship timber crosses it, and with the same mould they form the after timber: this will occasion the mark that was made on the mould when at the main frame to fall below the breadth line of the after timber, and therefore another mark is made at the height of the breadth line at the after timber; the straight part of the mould is then laid obliquely across the breadth lines of the top-timbers, in such a manner that it may intersect the breadth line of the midship timber at one of these marks and the breadth line of the after timber at the other mark; then the several intersections of the breadth lines of the timbers are marked upon the mould; which must now be so placed in forming each timber, that the proper mark may be applied to its proper breadth, and it must be turned about so as just to touch the upper breadth sweep. Any of these methods may make a fair side, and they may be easily proved by forming another intermediate half breadth line.

The remaining parts of the frames may be described by either of the methods laid down in Problems IX. and X. In order, however, to illustrate this still farther, it is thought proper to subjoin another method of forming the intermediate frames, the facility of which will recommend it.

Take FZ (fig. 30.), and lay it from F to *k* (fig. 32.); then describe the lower part of the foremost frame, making it more or less full according as proposed; and intersecting the ribbands in the points *l*, *m*, *n*. Describe also the aftermost frame *o*, *p*, *q*. Make  $\alpha\beta$  (fig. 30.) equal to Fr (fig. 32.), and produce it to *a* (fig. 31.); also draw  $\gamma\delta$ , and  $\epsilon\zeta$  (fig. 30.) equal to Er and Es (fig. 32.) respectively; and produce them to *b* and *c*: Make Fe, Ff, FR (fig. 31.) equal to M*l*, N*m*, P*n* (fig. 32.) each to each. Let also  $\oplus b$ ,  $\oplus i$ ,  $\oplus k$ , and *o**l*, *o**m*, *o**n* (fig. 31.) be made equal to M $\oplus$ , NO, PQ, and M*o*, N*q*, P*p* (fig. 32.); then through these points trace the curves *aenblb*, *rfimc*, and *rRknp*, and they will be the projections of the ribbands in the floor plane. Now transfer the several intervals of the frames contained between the middle line and the ribbands (fig. 31.) to the corresponding ribbands in the body plan (fig. 32.). Hence there will be five points given in each frame, namely, one at the lower breadth line, one at each ribband, and one at the keel; and consequently these frames may be easily described. In order to exemplify this, let it be required to lay down the frame E in the plane of projection. Take the interval E*n* (fig. 31.), and lay it from M to *u* (fig. 32.). Lay off also E*v*, E*e* (fig. 31.) from N to *v* and from P to *n* (fig. 32.); then through the points F, *u*, *v*, *n* and the lower breadth line describe a curve, and it will be the representation of the frame E in the body plan. In like manner the other frames may be described.

The ribbands may now be transferred from the body plan to the plane of elevation, by taking the several heights of the intersection of each ribband with the frames, and laying them off on the corresponding frames in the floor plan; and if the line drawn through these points make a fair curve, it is presumed that the curves of the frames are rightly laid down in the body plan. Only one of these ribbands, namely, the first, is laid down in fig. 30. These curves may also be farther proved, by drawing water lines in the plane of elevation,

*Fig. 27.*

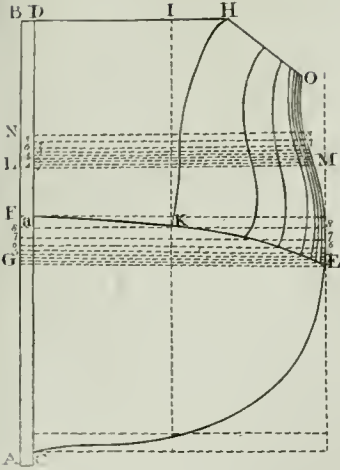

*Fig. 28.*

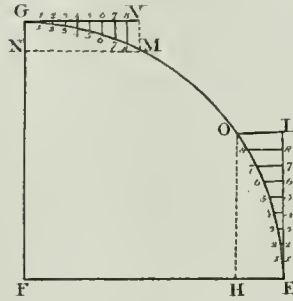

*Fig. 29.*

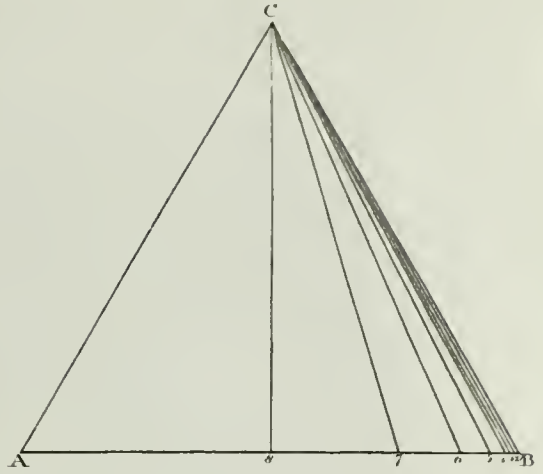

*Fig. 32.*

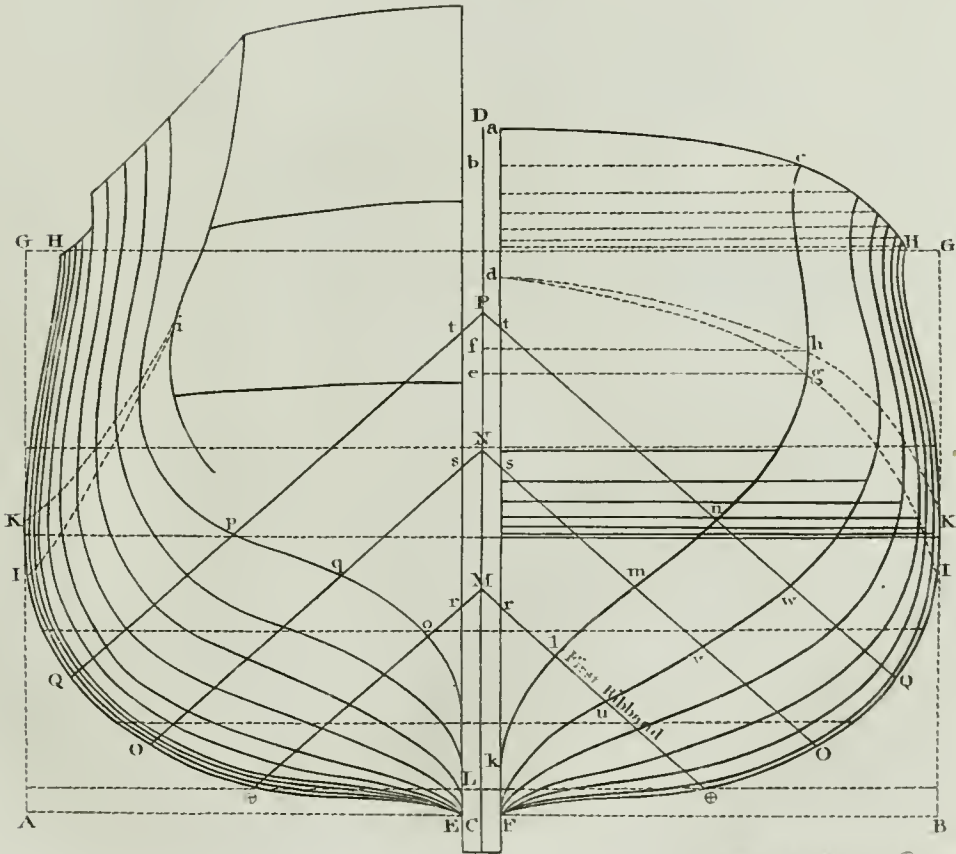



lication variation, and in the body plan, at equal distances from the upper edge of the keel. Then the distances between the middle line of the body plan, and the several points of intersection of these lines with the frames, are to be laid off from the middle line in the floor plan upon the corresponding frames; and if the line drawn through these points form a fair curve, the frames are truly drawn in the body plan.

In figs. 30. and 32. there are drawn four water lines at any equal distances from the keel, and from each other. These lines are then transferred from fig. 32. to fig. 31.; and the lines passing through these points make fair curves.

The transoms are described by Problem VIII. it is therefore unnecessary to repeat the process. A rising line of the floor timbers is commonly drawn in the plane of elevation.

As this is intended only as an introductory example, several particulars have therefore been omitted; which, however, will be exemplified in the following section.

SECT. IV. *To describe the several Plans of a Ship of War proposed to carry 80 Guns upon two Decks.*

As it is proposed in this place to show the method of describing the plans of a ship of a very considerable size, it therefore seems proper to give the dimensions of every particular part necessary in the delineation of these plans. The several plans of this ship are contained in Plate CCCCLXI. figs 33, and 34. But as it would very much confuse the figures to have a reference to every operation, and as the former example is deemed a sufficient illustration, the letters of reference are upon these accounts omitted in the figures.

PRINCIPAL DIMENSIONS.

	F.	In.
<i>Lengths.</i> —Length on the gun or lower deck from the aft part of the rabbet of the stem to the aft part of the rabbet of the post	182	0
Length from the foremost perpendicular to dead flat	63	11 $\frac{3}{4}$
Length from the foremost perpendicular to timber Y	4	0
Length from after perpendicular to timber 37	3	4
Room and space of the timbers	2	8 $\frac{1}{2}$
Length of the quarter-deck from the aft part of the stern	95	0
Length of the fore-castle from the fore part of the beak-head	49	0
Length of round-house deck from the aft part of the stern	51	8
<i>Heights.</i> —Height of the gun or lower deck from the upper edge of the keel to the under side of the plank at dead flat	24	0
Height of the gun or lower deck from the upper edge of the keel to the under side of the plank at foremost perpendicular	26	3
Height of the gun or lower deck from the upper edge of the keel to the under side of the plank at after perpendicular	26	3
Height from the upper side of the gun-deck plank to the under side of the upper deck plank, all fore and aft	7	0

Height from the upper side of the upper deck plank to the under side of the greater deck plank	} afore	6	10
		} abaft	6
Height to the under side of fore-castle plank, afore and abaft			6
Height from the upper side of the quarter-deck plank to the under side of the round-house plank	} afore	6	9
		} abaft	6
Height of the lower edge of the main wales at foremost perpendicular			24
Height of the lower edge of the main wales at dead flat		20	0
Height of the lower edge of the main wales at after perpendicular		26	6
Height of the lower edge of the channel wales at foremost perpendicular		32	6
Height of the lower edge of the channel wales at dead flat		29	0
Height of the lower edge of the channel wales at after perpendicular		34	0
Height of the upper side of the wing transom		28	4
Height of the touch of the lower counter at the middle line		33	5
Height of the touch of the upper counter at the middle line		36	2
Height of the top-timber line at the after part of the stern timber		44	7
<i>Breadths.</i> —Main wales in breadth from lower to upper edge		4	6
Channel wales in breadth from lower to upper edge		3	0
Waist rail in breadth		0	7
Distance between the upper edge of the channel wales and the under edge of the waist rail		2	9
Sheer rail in breadth		0	6
Distance between the sheer rail and the rail above from timber 13 to the stern		2	5
Distance between the sheer rail and the rail above from timber 7 to timber 11		1	4
Distance between the sheer rail and the rail above from timber C to the forepart of beak-head		1	2
And the said rail to be in breadth		0	6
Plank sheer to be in thickness		0	2 $\frac{1}{2}$
<i>Centres of the masts.</i> —From the foremost perpendicular to the centre of the mainmast on the gun-deck		103	2
From the foremost perpendicular to the centre of the foremast on the gun-deck		20	5
From the after perpendicular to the centre of the mizenmast on the gun-deck		28	6
<i>Stem.</i> —The centre of the sweep of the stem abaft timber P		0	4
Height of ditto from the upper edge of the keel		26	1
Stem moulded		1	3
Foremost part of the head afore the perpendicular		2	4
Height of ditto from the upper edge of the keel		38	3
<i>Stern-post.</i> —Aft part of the rabbet afore the			

F. In. Application of the foregoing Rules to the Construction of Ships.

Application of the foregoing Rules to the Construction of ships.

perpendicular on the upper edge of the keel	Ft. In.	3 4
Aft part of the port abaft the rabbet at the upper edge of the keel	2 6	
Aft part of the port abaft the rabbet at the wing transom	1 1	
Stern-port fore and aft on the keel	3 1	
Ditto square at the head	2 0½	
Counters.—The touch of the lower counter at the middle line, abaft the aft part of the wing transom	7 6	
Round aft of the lower counter	1 4	
Round up of the lower counter	0 9	
The touch of the upper counter at the middle line, abaft the aft part of the wing transom	9 9	
Round aft of the upper counter	1 3½	
Round up of the upper counter	0 10	
Aft part of the stern-timber at the middle line, at the height of the top timber line, abaft the aft part of the wing transom	12 6	
Round aft of the wing transom	0 6	
Round up of the wing transom	0 5½	

Draught of water.—Load draught of water from the upper edge of the keel	} afore	20 5
		20 5
Channels.—Foremost end of the fore channel afore timber R		1 0
The channel to be in length		37 0
And in thickness at the outer edge		0 4½
The dead eyes to be 12 in number and in diameter		1 6
Foremost end of the main channel afore timber 9		0 10
The channel to be in length		38 0
And in thickness at the outer edge		0 4½
The dead eyes to be 14 in number and in diameter		1 6
Foremost end of the mizen-channel abaft timber 27		2 4
The channel to be in length		20 0
And in thickness at the outer edge		0 4
The dead eyes to be 7 in number and in diameter		1 0

Application of the foregoing Rules to the Construction of ships.

*DIMENSIONS of the several Parts of the Bodies.*

Fore Body.	Timbers Names.								
	⊕	C	G	L	P	T	W	Y	
	Ft. In.	Ft. In.	Ft. In.	Ft. In.	Ft. In.	Ft. In.	Ft. In.	Ft. In.	Ft. In.
Lower height of breadth	22 6	22 6	22 7	23 0	23 11	25 7	26 10	28 8	
Upper height of breadth	24 10	24 10	24 10	24 10½	25 3½	26 4½	27 4½	29 0	
Height of the top-timber line	37 5	37 7	38 0	38 5	39 1	39 10	40 4	40 9	
Height of the rising line *	0 0	0 5½	3 10	9 10	18 6				
Height of the cutting down	2 3½	2 3½	2 8	3 10	6 4				
Main half breadth	24 5½	24 5½	24 4½	24 0½	23 2½	20 2	17 0	11 0½	
Top-timber half breadth	20 11	20 10	20 9	20 6	20 0	18 9½	17 10	16 6	
Half breadth of the rising	8 7	8 4	6 5½	2 9	5 7				
					Outside				
Length of the lower breadth sweeps	19 2	18 9	18 3	17 3	15 11	14 1	12 7	12 0	
First diagonal line	7 9	7 8½	7 7	7 1	6 3	3 8			
Second ditto	13 9	13 8½	13 4½	12 1	10 3	7 1½	4 6		
Third ditto	20 0	19 11	19 2	17 7	15 1	11 1	8 3½	3 4½	
Fourth ditto	23 4½	23 4½	23 0	21 8½	18 11	14 8½	11 5	6 0	
Fifth ditto	24 8	24 8	24 4½	23 5½	21 2½	17 1	13 8½	7 11	
Sixth ditto									
Seventh ditto	24 1½	24 1½	24 0	23 9	22 10	20 10½	18 6½	14 7	

\* Rising height 11 feet 10 inches at dead flat, from which all the other risings must be set off.

*Aster*



After Body	Timbers Names.																					
	1		5		9		13		17		21		25		29		33		35		37	
	Ft.	In.	Ft.	In.	Ft.	In.	Ft.	In.	Ft.	In.	Ft.	In.	Ft.	In.	Ft.	In.	Ft.	In.	Ft.	In.	Ft.	In.
Lower height of breadth	22	6	22	6	22	6	22	7 $\frac{1}{2}$	22	9	23	0 $\frac{1}{2}$	23	7 $\frac{1}{2}$	24	6	25	10 $\frac{3}{4}$	26	9 $\frac{1}{2}$	28	3
Upper ditto	24	10	24	10	24	10	24	11	25	1	25	4	25	8	26	3	27	1	27	9	28	8
Height of the top-timber line	37	5	37	5	37	6	37	10	38	3 $\frac{1}{2}$	38	11	39	8	40	6	41	5	42	0	42	6
Height of the cutting down	2	3 $\frac{1}{2}$	2	3 $\frac{1}{2}$	2	3 $\frac{1}{2}$	2	3 $\frac{1}{2}$	2	4	2	7 $\frac{1}{2}$	3	5	5	2 $\frac{1}{2}$	8	7				
Height of the rising	0	2 $\frac{1}{2}$	0	8 $\frac{1}{2}$	1	9 $\frac{1}{2}$	3	6 $\frac{1}{2}$	6	0	10	1	17	0								
Main half breadth	24	5 $\frac{1}{4}$	24	4 $\frac{1}{4}$	24	4 $\frac{1}{4}$	24	3 $\frac{1}{2}$	24	1	23	8 $\frac{1}{2}$	23	0 $\frac{1}{2}$	21	10						
Half breadth of the rising	8	6	8	3	7	9	6	10 $\frac{1}{2}$	5	3 $\frac{1}{2}$	2	8	2	6	Outside							
Top-timber half breadth	20	11	20	10	20	9 $\frac{1}{2}$	20	9	20	7	20	3	19	5	18	2	16	8	15	10 $\frac{1}{2}$	15	0 $\frac{1}{4}$
Opposides half breadth											19	7	18	4	17	0	15	10	14	11	14	3
Length of lower breadth sweeps	19	2	19	2	19	0	18	7	17	1	16	0	14	5	12	5	9	10 $\frac{1}{2}$	7	11	4	8
First diagonal	7	9	7	8 $\frac{1}{2}$	7	7	7	5	7	2 $\frac{1}{2}$	6	7	5	9	4	7	2	10	1	8 $\frac{1}{2}$	0	7
Second ditto	13	9	13	8 $\frac{1}{2}$	13	6	13	1	12	6	11	2	9	7	7	7	4	8 $\frac{1}{2}$	3	1	0	11
Third ditto	20	0	19	11 $\frac{1}{4}$	19	7 $\frac{1}{2}$	19	0	18	1 $\frac{1}{2}$	16	6	14	2	11	5 $\frac{1}{2}$	7	8 $\frac{1}{2}$	5	5	2	11 $\frac{1}{2}$
Fourth ditto	23	4 $\frac{1}{2}$	23	3	23	1 $\frac{1}{2}$	22	6 $\frac{1}{2}$	21	11	20	3	18	0 $\frac{1}{2}$	15	3 $\frac{1}{2}$	11	4	8	7	4	6 $\frac{1}{4}$
Fifth ditto	24	8	24	7	24	6	24	1 $\frac{1}{2}$	23	6 $\frac{1}{2}$	22	3 $\frac{1}{2}$	20	6 $\frac{1}{2}$	18	2	14	4	11	5	7	0
Sixth ditto															18	8 $\frac{1}{2}$	16	0	18	11	17	8 $\frac{1}{2}$
Seventh ditto										23	9 $\frac{1}{2}$	23	0	21	8 $\frac{1}{2}$	20	0	18	11	17	8 $\frac{1}{2}$	

DIAGONAL LINES for both the FORE and AFTER BODIES.

Fore and After Bodies.	Names of the Diagonal Lines.													
	1st		2d		3d		4th		5th		6th		7th	
	Ft.	In.	Ft.	In.	Ft.	In.	Ft.	In.	Ft.	In.	Ft.	In.	Ft.	In.
Height up the middle line	6	11	11	4	16	5 $\frac{1}{2}$	20	8	23	5 $\frac{1}{2}$	27	5	43	9
Distance from the middle line on the base line	4	8	9	1	15	6								
Height up the side line							0	9 $\frac{1}{2}$	6	7	12	7 $\frac{1}{2}$	32	8 $\frac{1}{2}$

I. Of the Sheer Draught or Plane of Elevation.

Draw a straight line (fig. 33.) to represent the upper edge of the keel, erect a perpendicular on that end to the right, and from thence set off 182 feet, the length on the gun-deck, and there erect another perpendicular; that to the right is called the *foremost* perpendicular, and the other the *after* one: upon these two perpendiculars all the foremost and aftermost heights must be set off, which are expressed in the dimensions.

Then set off the distance of the main frame or dead flat from the foremost perpendicular, and at that place erect a third perpendicular, which must be distinguished by the character ⊕. From dead flat the room and space of all the timbers must be set off; but it will only be necessary to erect a perpendicular at every frame timber; which in the fore body are called *dead flat*, A, C, E, &c. and in the after body (2', 1, 3, 5, &c.): hence the distance between the frame perpendiculars will be double the room and space expressed in the dimensions. Then set off the heights of the gun-deck afore at midship or dead flat, and abaft from the upper side of the keel; and a curve described through these three points will be the upper side of the gun-deck. Set off the thickness of the gun-deck plank below that; and another curve being drawn parallel to the former, the

gun-deck will then be described at the middle line of the sheer plan.

The centre of the stem is then to be laid down by means of the table of dimensions; from which centre, with an extent equal to the nearest distance of the upper edge of the keel, describe a circle upwards: describe also another circle as much without the former as the stem is moulded. Then set off the height of the head of the stem, with the distance afore the perpendicular, and there make a point; and within that set off the moulding of the stem, and there make another point: from this last mentioned point let a line pass downwards, intersecting the perpendicular at the height of the gun-deck, and breaking in fair with the inner circle, and the after part of the stem is drawn. Draw another line from the foremost point downwards, parallel to the former, and breaking in fair with the outer circle; then the whole stem will be formed, except the after or lower end, which cannot be determined till hereafter.

The stern-post must be next formed. Set off on the upper edge of the keel a spot for the aft part of the rabbet taken from the dimensions, and from that forward set off another point at the distance of the thickness of the plank of the bottom, which is 4 $\frac{1}{2}$  inches; and from this last mentioned point draw a line upwards intersecting the perpendiculars at the height of the lower deck;

Application  
of the fore-  
going Rules  
to the Con-  
struction of  
Ships.

deck; then set up the perpendicular the height of the wing transom, and draw a level line, and where that line intersects, the line first drawn will be the aft side of the wing transom; on the upper part of the middle line set off from that place the distance of the aft side of the stern-post; set off also the distance of the after part from the rabbet on the upper edge of the keel, and a line drawn through these two points will be the aft side of the post. A line drawn parallel to the first drawn line at the distance of  $4\frac{1}{2}$  inches, the thickness of the plank on the bottom, will be the aft side of the rabbet: and hence the stern-post is described, except the head, which will be determined afterwards.

From the dimensions take the several heights of the upper deck above the gun-deck, afore, at midship, and abaft, and set them off accordingly; through these points describe a curve, which will be the under side of the upper deck; describe also another curve parallel thereto, at the distance of the thickness of the plank, and the upper deck will be then represented at the middle line of the ship.

Set off the height of the lower counter, at the middle line, from the upper edge of the keel, and draw a horizontal line with a pencil; then on the pencil line set off the distance the touch of the lower counter is abaft the aft side of the wing transom: from this point to that where the fore part of the rabbet of the stern-post intersects the line drawn for the upper part of the wing transom, draw a curve at pleasure, which curve will represent the lower counter at the middle line. The height of the upper counter is then to be set off from the upper edge of the keel, and a horizontal line is to be drawn as before, setting off the distance the touch of the upper counter is abaft the aft side of the wing transom; and a curve described from thence to the touch of the lower counter will form the upper counter at the middle line.

Both counters being formed at the middle line, the upper part of the stern timber above the counters is to be described as follows: On the level line drawn for the upper side of the wing transom set off the distance of the aft side of the stern timber at the middle line from the aft side of the wing transom, at the height of the top-timber line, and erect a perpendicular: then upon this perpendicular, from the upper edge of the keel, set off the height at the middle line of the top-timber line at the after side of the stern timber; through this point draw a straight line to the touch of the upper counter, and the upper part of the stern timber will be described.

As the stern rounds two ways, both up and aft, the stern timber at the side will consequently alter from that at the middle line, and therefore remains to be represented. Take the round up of the upper counter from the dimensions, and set it below the touch at the middle, and with a pencil draw a level line; take also the round aft, and set it forward from the touch on the touch line, and square it down to the pencil line last drawn, and the point of intersection will be the touch of the upper counter at the side. In the same manner find the touch of the lower counter; and a curve, similar to that at the middle line, being described from the one touch to the other, will form the upper counter at the side.

Take the round up of the wing transom, and set it off below the line before drawn for the height of the

wing transom, and draw another horizontal line in pencil: then take the round aft of the wing transom, and set it forward on the upper line from the point representing the aft side of the wing transom; square it down to the lower line, and the intersection will be the touch of the wing transom: then a curve, similar to that at the middle line, being drawn from the touch of the wing transom to the touch of the lower counter at the side, will be the lower counter at the side. Draw a line from the upper counter upwards, and the whole stern timber at the side will be represented. But as the straight line drawn for the upper part of the side timber should not be parallel to that at the middle line, its rake is therefore to be determined as follows.

Draw a line at pleasure, on which set off the breadth of the stern at the upper counter; at the middle of this line set off the round aft of the upper counter, then through this point and the extremities of the stern describe a curve. Now take the breadth of the stern at the top-timber line, and through the point where that breadth will intersect the curve for the round aft of the stern draw a line parallel to that first drawn, and the distance from the line last drawn to the curve at the middle of the line is the distance that the side timber must be from the middle line at the height of the top-timber line.

The sheer is to be described, which is done by setting off the heights afore, at midships, and abaft, and a curve described through these three points will be the sheer. But in order that the sheer may correspond exactly with the dimensions laid down, it will be necessary to proceed as follows: The perpendicular representing timber dead flat being already drawn, set off from that the distances of the other frame timbers, which is double the room and space, as the frames are only every other one; and erect perpendiculars, writing the name under each: then on each of these perpendiculars set off the corresponding heights of the top-timber line taken from the table of dimensions for constructing the bodies; and through these points a curve being described, will represent the sheer of the ship or top timber line agreeable to the dimensions.

The quarter-deck and fore-castle are next to be described, which may be done by taking their respective heights and lengths from the dimensions, and describing their curves. In the same manner also, the round-house may be drawn. The decks being described representing their heights at the middle, it is then necessary to represent them also at the side. For this purpose take the round of the decks from the dimensions, and set them off below the lower line drawn for the middle, and a curve described both fore and aft, observing to let it be rather quicker than the former, will be the representation of the decks at the side.

The ports come next under consideration. In the placing of them due attention must be paid, so as to preserve strength; or that they shall be so disposed as not to weaken the ship in the least, which is often done by cutting off principal timbers, placing them in too large openings, having too short timbers by the side of them, &c. The frames represented by the lines already drawn must be first consulted. Then with a pencil draw two curves, for the lower and upper parts of the lower deck posts, parallel to the line representing the lower deck; the distances of these lines from

Application  
of the fore-  
going Rules  
to the Con-  
struction of  
Ships.

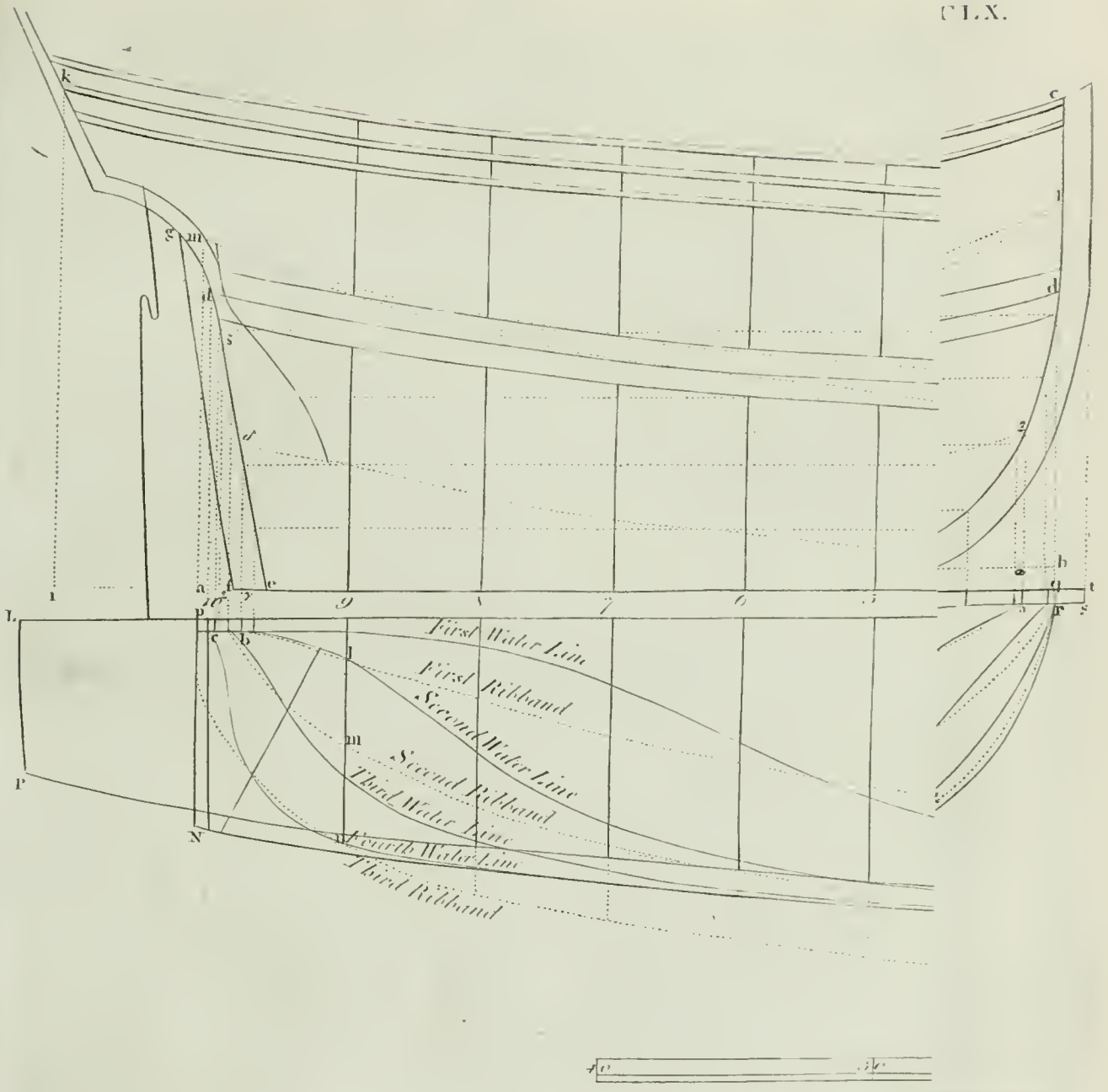

Fig. 30.

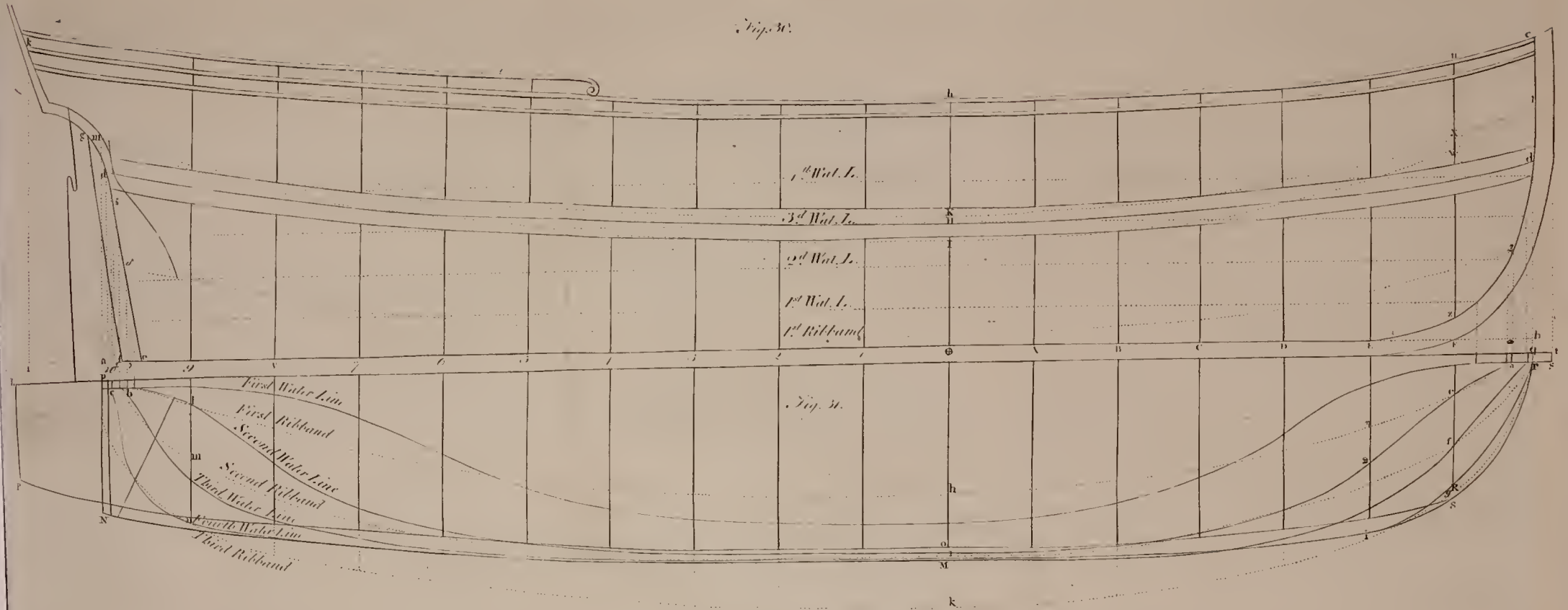
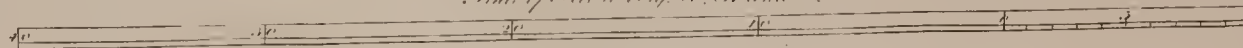

Fig. 30.

Scale of Feet to Fig. 30, 31 and 32



1111 1111 1111

Application of the foregoing Rules to the Construction of Ships.

the deck are to be taken from the dimensions, observing, however, to add to these heights the thickness of the deck, as the deck line at the side represents the under part of the deck.

The foremost port is then to be described, observing to place it as far aft as to give sufficient room for the manger: the most convenient place will therefore be to put it between the frames R and T, and equally distant from each. It will then be placed in the most conspicuous point of strength, as it will have a long top timber on the aft side and a long fourth futtock on the fore side of it. The second port may be placed in like manner between the next two frames, which will be equally well situated for strength as the former; and by proceeding in this manner, the ports on the gun-deck may also be placed, taking care to have two frames between every two ports, all fore and aft.

The upper deck ports are then to be described; and in order to dispose of them in the strongest situation possible, they must be placed over the middle between the gun-deck ports, so that every frame in the ship will run up to the top of the side, by their coming between a gun and upper deck port; and every port will be between the frames, which will in a great measure contribute towards the strength of the ship. With regard to the ports on the quarter deck, it is not of such material consequence if they cut the head of the frame, as in placing them the situation of the dead eyes must be considered, placing a port where there is a vacancy between the dead eyes large enough to admit of one; observing always to place them as nearly as possible at equal distances from each other; and where it happens that they do not fall in the wake of a frame, then that frame must by all means be carried up to the top of the side.

The necessary length of the round house being determined in the dimensions, it may be set off; observing, however, to let it be no longer than is just sufficient for the necessary accommodations, as the shorter the round-house the works abaft may be kept lower, and a low snug stern is always accounted the handsomest. Then set off the round of the deck at the foremost end, below the line drawn; the deck at the side may be described by another curve drawn quite aft. Now, from the point for the round of the deck to the stem timber, draw a curve parallel to the top-timber line, and that will be the extreme height of the top of the side abaft, which height continues to range fair along to the foremost end of the round house, and at that place may have a fall about 14 inches, which may be turned off with a drift scroll. At the fore part of the quarter-deck, the topside may have a rise of 14 inches, which may also be turned off with a scroll. But as the raising of the topside only 14 inches at that place will not be sufficient to unite with the heights abaft, it will therefore be necessary to raise 14 inches more upon that, and break it off with a scroll inverted on the first scroll, and continue these two lines, parallel to the top-timber line, to the distance of about seven feet aft. At the foremost end of the round-house there is a break of 14 inches already mentioned; and in order to make that part uniform with the breaks at the foremost end of the quarter-deck, there must be set down 14 inches more below the former; and at these two heights continue two

curves parallel to the top-timber line, from the aft part of the stern to the ends of the two curves already drawn at the foremost end of the quarter-deck. If they should happen not to break in fair with them, they must be turned off with a round; but to make them appear more handsome, the lower line may be turned off with a scroll. These lines being drawn will represent the upper edges of the rails.

The height of the top side at the fore part of the ship must next be considered; which, in order to give proper height for the fore-castle, must have a rise there of 14 inches, the break being at the after end of the fore-castle, and turned off as before. But as this part of the ship is still considerably lower than the after part, it will be necessary to give another of eight inches upon the former, and turn it off with a scroll inverted. Hence this part of the ship will appear more uniform to the after part.

The finishing parts, namely the wales, stern, head, rails, &c. remain to be described. The wales may be first drawn; and as the strength of the ship depends very much on the right placing of them, great care must therefore be taken that they may be as little as possible wounded by the lower deck ports, and so placed that the lower deck bolts shall bolt in them, and also that they come as near as possible on the broadest part of the ship. In the first place, therefore, the height of breadth lines must be chosen for our guide. These heights of breadth are to be taken from the dimensions, and set off on the respective frames, and curves drawn through these points will be the upper and lower heights of breadth lines. The height of the wales may now be determined; which in general is in such a manner that the upper height of breadth line comes about six inches below their upper edge, and the wales are then placed right upon the breadth lines. Take the heights and breadths of the wales afore, at midships, and abaft from the table of dimensions; draw curves through the points thus found, and the wales will be represented.

The channel wales are then to be described. They are principally intended to strengthen the top side, and must be placed between the lower and upper deck ports; and the lower edge of them at midships should be placed as low as possible, in order to prevent them from being cut by the upper deck ports afore and abaft. Take their heights and breadths from the dimensions; lay them off, and describe curves through the corresponding points, and the channel wales will be represented.

Lay off the dimensions of the waste rail found in the table; and through the points draw a line parallel to the top-timber line all fore and aft. This rail terminates the lower part of the paint work in the top side, as all the work above this rail is generally painted, and the work of the top side below it payed with a varnish, except the main wales, which are always payed with pitch.

Take the draught of water from the dimensions, and draw the load water-line, which is always done in green. Divide the distance between the load water-line and the upper edge of the keel into five equal parts, and through these points draw four more water-lines.

Set off the centres of the masts on the gun-deck; their rake may likewise be taken from the dimensions. Set off also the centre of the bowsprit, letting it be

Application of the foregoing Rules to the Construction of Ships

four feet from the deck at the after part of the stem, which will give sufficient height for a light and airy figure.

Draw the knight-heads so as to be sufficiently high above the bowsprit to admit of a chock between them for the better security of the bowsprit. The timber heads may also be drawn above the forecastle, observing to place the most convenient for the timbers of the frame, being those which come over the upper deck ports, as they may be allowed long enough to form handsome heads. There should be one placed abaft the car-head, to which the foremast block is to be bolted, and there may be two ports on the forecastle formed by them, and placed where it is most convenient to the dead eyes.

Describe the channels, taking their lengths and thicknesses from the dimensions, and place their upper edges well with the lower edge of the sheer rail. The dead eyes may then be drawn, observing to place them in such a manner that the chains may not interfere with the ports; and the preventer plates must all be placed on the channel wales, letting them be of such a length that the preventer bolt at each end may bolt on each edge of the channel wales. It must also be observed to give each of the chains and preventer plates a proper rake, that is, to let them lie in the direction of the shrouds, which may be done in the following manner: Produce the mast upwards, upon which set off the length of the mast to the lower part of the head; these straight lines drawn from that point through the centre of each dead eye will give the direction of the chains and preventer braces.

The fenders may be then drawn, observing to place them right abreast of the main hatchway, in order to prevent the ship's side from being hurt by whatever may be hoisted on board. The proper place for them will therefore be at timber 3; and the distance between them may be regulated by the distance between the ports. The chest-tree may also be drawn, which must be placed at a proper distance abaft the foremast, for the conveniency of hauling home the fore tack. It may therefore be drawn at the aft side of timber C, from the top of the side down to the upper edge of the channel wales; and the fenders may reach from the top of the side down to the upper edge of the main wales. As the fenders and chest-tree are on the outside of the planks, wales, &c. the lines representing the wales, &c. should not be drawn through them.

Draw the steps on the side, which must be at the fore part of the main drift or break, making them as long as the distance between the upper and lower deck ports will admit of. They may be about six inches asunder, and five inches deep, and continued from the top of the side down to the middle of the main wales.

In order to describe the head, the height of the beak-head must be first determined, which may be about two feet above the upper deck. At that place draw a horizontal line, upon which set off the length of the beak-head, which may be  $7\frac{1}{2}$  feet abaft the fore part of the stem, and from thence square a line up to the forecalle deck; which line will represent the aft part of the beak head, and will likewise terminate the foremost end of the forecalle. The length of the head may now be determined, which by the proportions will be found to be 15 feet six inches from the fore part of the stem. Set it off from

the fore part of the stem, and erect a perpendicular, which will be the utmost limits of the figure forward: then take the breadth of the figure from the proportions, which is four feet four inches, and set it off forward; and another perpendicular being drawn will show the utmost extent of the hair bracket forward, or aft part of the figure. Then draw the lower cheek, letting the upper edge be well with the upper edge of the main wales, and the after end ranging well with the beak-head line; set off the depth of it on the stem; which is about 11 inches, and let a curved line pass from the after end through the point on the stem, and to break in fair with the perpendicular first drawn for the length of the head, the fore part of the curve will then represent the position of the figure.

The upper cheek may be next drawn; but, in order to know the exact place of it on the stem, the place of the main rail must first be set off on the stem, the upper edge of which may be kept on a level with the beak-head; then setting off the depth of it below that, the place for the upper cheek may be determined, letting it be exactly in the middle between that and the lower cheek: then, by drawing curves for the upper and lower edges of the cheek from the after end parallel to the lower cheek, to break in fair with the perpendicular, drawn for the back of the figure: then the upper cheek will be formed. The upper part may run in a serpentine as high as where the shoulder of the figure is supposed to come, at which place it may be turned off with a scroll. The distance from the scroll to the heel of the figure is called the hair-bracket.

The head of the block may be formed by continuing the line at the breast round to the top of the hair-bracket, observing to keep the top of it about six inches clear of the under side of the bowsprit.

Having the distance set off on the stem for placing the main rail, it may next be described, keeping the bag of it as level as possible for the conveniency of the gratings, and letting the foremost end rise gradually according to the rise of the upper cheek and hair-bracket, and may turn off on the round of the scroll before drawn for the hair-bracket. To form the after end, set off the size of the head of the rail abaft the beak-head line, and erect a perpendicular; then describe the arch of a circle from that perpendicular to break in fair with the lower side of the rail in the middle, and also another from the beak-head perpendicular, to break in fair with the upper side of the rail at the middle, observing to continue the head of it sufficiently high to range with the timber heads above the forecalle.

The head timbers are next to be drawn, placing the stem timber its own thickness abaft the stem, and the foremost must be so placed that the fore side may be up and down with the heel of the block or figure, which has not yet been set off. Take therefore the distance from the breast to the heel on a square which is seven feet, and erect a perpendicular from the lower part of the lower cheek to the lower part of the upper cheek; which perpendicular will terminate the foremost end of the lower cheek and the heel of the figure, and will also terminate the lower end of the hair-bracket: then, by continuing the same perpendicular from the upper part of the lower deck to the under part of the main rail, the fore side of the foremost head timber will be described; and by setting off its thickness aft, the other side may be drawn. The middle head timber may be spaced between the two former ones; and there may also be one

tion of timber placed abaft the ſtem, at a diſtance from the ſtem, equal to that between the others, and the lower end of it may ſtep on the upper edge of the lower rail.

To deſcribe the middle and lower rails, divide the diſtance between the lower part of the main rail and the upper part of the upper cheek equally at every head timber; and curves being deſcribed through theſe points will form the middle and lower rails. The after end of the lower rail muſt terminate at the after edge of the after head timber.

The cat-head ought to be repreſented in ſuch a manner as to come againſt the aft ſide of the head of the main rail, to rake forward four inches in a foot, and to ſteeve up  $5\frac{1}{2}$  inches in a foot, and about one foot ſix inches ſquare. The lower part of it comes on the plank of the deck at the ſide, and the ſupporter under it muſt form a fair curve to break in with the after end of the middle rail.

The hawſe holes muſt come between the checks, which is the moſt convenient place for them; but their place fore and aft cannot be exactly determined until they are laid down in the half breadth plan.

The knee of the head is to project from the breaſt of the figure about two inches; and particular care muſt be taken that in forming it downwards it be not too full, as it is then liable to rub the cable very much: it may therefore have no more ſubſtance under the lower cheek at the heel of the figure than is juſt ſufficient to admit of the bobſlay holes, and may be  $3\frac{1}{2}$  feet diſtant from the ſtem at the load water-line, making it run in an agreeable ſerpentine line from the breaſt down to the third water line, where it may be  $1\frac{1}{2}$  feet from the ſtem. By continuing the ſame line downwards, keeping it more diſtant from the ſtem as it comes down, the *gripe* will be formed. The lower part of it muſt break in fair with the under part of the falſe keel; and the breadth of the gripe at the broadeſt place will be found by the proportions to be  $4\frac{1}{2}$  feet. As the aft part of the gripe is terminated by the fore foot, or foremoſt end of the keel, it will now be proper to finiſh that part as follows: From the line repreſenting the upper edge of the keel ſet down the depth of the keel, through which draw a line parallel to the former, and it will be the lower edge of the keel. From that point, where the aft ſide of the ſtem is diſtant from the upper edge of the keel by a quantity equal to the breadth of the keel at midſhips, erect a perpendicular, which will limit the foremoſt end of the keel; and the after or lower end of the ſtem may be repreſented by ſetting off the length of the ſcarf from the foremoſt end of the keel, which may be ſix feet. Set down from the line repreſenting the lower edge of the keel the thickneſs of the falſe keel, which is ſeven inches; and a line drawn through that point parallel to the lower edge of the keel will be the under edge of the falſe keel, the foremoſt end of which may be three inches afore the foremoſt end of the main keel.

The head being now finiſhed, proceed next to the ſtern, the ſide and middle timbers of which are already drawn. From the ſide timber ſet off forward 14 feet, the length of gallery, and draw a pencil line parallel to the ſide timber; draw alſo a line to interſect the touch of the upper counter at the ſide, producing it forwards parallel to the ſheer as far as the pencil line firſt drawn;

and this line will repreſent the upper edge of the gallery rim. From which ſet down eight inches, the breadth of the gallery rail, and draw the lower edge of the rail. At the diſtance of eight inches from the fore ſide of the ſide timber draw a line parallel thereto; and from the point of interſection of this line with the upper edge of the gallery rim, draw a curve to the middle timber parallel to the touches of the upper counter, which line will repreſent the upper edge of the upper counter rail as it appears on the ſheer draught. The lower edge of this rail may be formed by ſetting off its depth from the upper edge. In the ſame manner the lower counter rail may be deſcribed: then take the diſtance between that and the upper counter rail, and ſet it off below the rim rail; and hence the rail that comes to the lower ſtool may be drawn, keeping it parallel to the rim rail. Underneath that, the lower finiſhing may be formed, making it as light and agreeable as poſſible.

Set off from the middle timber on the end of the quarter-deck the projection of the balcony, which may be about 2 feet, and draw a line with a pencil parallel to the middle timber. On this line ſet off a point  $1\frac{1}{2}$  inches below the under ſide of the quarter-deck, from which draw a curve to the ſide timber parallel to the upper counter rail, which curve will repreſent the lower ſide of the foot ſpace rail of the balcony as it appears in the ſheer draught.

Take the diſtance between the point of interſection of the upper edge of the upper counter with the middle line, and the point of interſection of the under ſide of the foot ſpace rail with the middle line, which ſet up on a perpendicular from the upper edge of the rim rail at the foremoſt end. Through this point draw a line parallel to the rim rail to interſect the lower part of the foot ſpace rail, and this line will repreſent the lower edge of the rail that comes to the middle ſtool, and will answer to the foot ſpace rail. Then between this line and the rim rail three lights or ſaſhes may be drawn, having a muntin or pillar between each light of about 14 inches broad, and the lower gallery will be finiſhed. Set off the depth of the middle ſtool rail above the line already drawn for the lower edge, and the upper edge may be drawn. Then ſet off the ſame depth above the curve drawn for the lower edge of the foot ſpace rail, and the upper edge of that rail may then be drawn.

The quarter-piece muſt be next deſcribed, the heel of which muſt ſtep on the after end of the middle ſtool. Draw a line with a pencil parallel to the middle timber, and at a diſtance therefrom, equal to the projection of the balcony. Upon this line ſet up from the round houſe deck the height of the upper part of the ſtern or taſſ rail, which may be four feet above the deck. At that height draw with a pencil a horizontal line, and from its interſection with the line firſt drawn deſcribe a curve to the middle ſtool rail, obſerving to make the lower part of this curve run nearly parallel to the ſide timber, and the lower part about three inches abaft the ſide timber; and this curve will repreſent the aft ſide of the quarter-piece at the outside. There ſet off the thickneſs of the quarter-piece, which is one foot ſix inches, afore the curve already drawn; and another curve being deſcribed parallel to it from the lower part to the top of the ſheer, and the quarter-piece

Application of the foregoing Rules to the Construction of Ships.

Application  
of the fore-  
going Rules  
to the Con-  
struction of  
Ships.

at the outside will be represented. On the horizontal line drawn for the upper part of the taff-rail set off forward the thickness of the taff-rail, which is one foot; then draw a curve down to the head of the quarter-piece parallel to the first, and that part of the taff-rail will be described. Instead of a fair curve, it is customary to form the upper part of the taff-rail with one or two breaks, and their curves inverted. Either way may, however, be used according to fancy.

Set off the depth of the taff rail, which may be about  $3\frac{1}{2}$  feet, on the line drawn for the projection; from the upper part, and from this point, describe a curve as low as the heel of the quarter-piece, and about five inches abaft it at that place; observing to make it run nearly parallel to the after edge of the quarter-piece; and the after part of the quarter-piece, which comes nearest to the side, will be represented.

Set up on the line drawn for the projection of the balcony the height of the upper part of the balcony or breast rail, which is  $3\frac{1}{2}$  feet from the deck; set off the thickness of the rail below that, and describe the balcony, keeping it parallel to the foot space rail, and terminating it at the line drawn for the after part of the quarter-piece nearest the side; and the whole balcony will then be represented.

The upper gallery is then to be described. In order to this, its length must be determined, which may be 11 feet. Set off this distance from the side timber forward with the sheer; and at this point draw a line parallel to the side timber, which line will represent the fore part of the gallery. Then take the distance between the upper part of the foot space rail and the upper part of the breast rail on a perpendicular, and let it off on a perpendicular from the upper part of the middle stool rail on the line drawn for the fore part of the gallery, from which to the fore part of the quarter piece draw a straight line parallel to the rail below, which line will be the upper edge of the upper rim rail; and its thickness being set off, the lower edge may also be drawn. From the upper edge of that rail set up an extent equal to the distance between the lower rim rail and middle stool rail, and describe the upper stool rail, the after end of which will be determined by the quarter piece, and the fore end by the line for the length of the gallery. There may be three sashes drawn between these two rails as before; and hence the upper gallery will be formed.

The upper finishing should be next drawn, the length of which may be  $1\frac{1}{2}$  foot less than the upper gallery. Draw a line parallel to the rake of the stern for the fore end of it, and let the upper part of the top side be the upper part of the upper rail, from which set down three inches for the thickness of the rail, and describe it. Describe also another rail of the same length and thickness as the former, and eight inches below; from the end of which a serpentine line may be drawn down to the upper stool rail, and the upper finishing will be completed.

The stern being now finished, the rudder only remains to be drawn. The breadth of the rudder at the lower part is to be determined from the proportions, and set off from the line representing the aft part of the stern-post; which line also represents the fore part of the rudder. Then determine on the lower hance, letting it be no higher than is just sufficient, which may be about

one foot above the load water-line, and set off its breadth at that place taken from the proportions. Then a line drawn from thence to the breadth set off at the lower part will be the aft side of the rudder below the lower hance. There may also be another hance about the height of the lower deck. The use of these breaks or hances is to reduce the breadth as it rises toward the head. The aft part may be drawn above the lower hance, the break at the lower hance being about ten inches, and the break at the upper hance six inches.—The back may be then drawn. It is of elm, about four inches thick on the aft part. That thickness being set off, and a line drawn from the lower hance to the lower end, will represent the back. The head of the rudder should be as high as to receive a tiller above the upper deck. Therefore set off the size of the head above the upper deck, and draw a line from thence to the break at the upper hance, and the aft part of the rudder will be represented all the way up. The bearding should be drawn, by setting off the breadth of it at the keel from the fore side of the rudder, which may be nine inches. Set off also the breadth at the head of the wing transom, which may be a foot. Then a line being drawn through these two points; from the lower part of the rudder to about a foot above the wing transom, and the bearding will be represented. As the bearding is a very nice point, and the working of the rudder depending very much upon it, it should always be very particularly considered. It has been customary to beard the rudder to a sharp edge at the middle line, by which the main piece is reduced more than necessary. The rudder should, however, be bearded from the side of the pintles, and the fore side made to the form of the pintles.

The pintles and braces may next be drawn. In order to which determine the place of the upper one, which must be so disposed that the straps shall come round the head of the standard, which is against the head of the stern-post on the gun-deck, and meet at the middle line. By this means there is double security both to the brace and standard. To obtain those advantages, it must therefore be placed about four inches above the wing transom; the second must be placed just below the gun-deck so as to bolt in the middle of the deck transom, and the rest may be spaced equally between the lower one, which may be about six inches above the upper edge of the keel. The number of them are generally seven pair upon this class of ships; but the number may be regulated by the distance between the second and upper one, making the distance between the rest nearly the same. The length of all the braces will be found by setting off the length of the lower one, which may be eight feet afore the back of the stern-post, and also the length of the third, which is four feet and a half afore the back of the stern-post; and a line drawn from the one extremity to the other will limit the intermediate ones, as will appear on the sheer draught. The braces will seem to diminish in length very much as they go up; but when measured or viewed on the shape of the body, they will all be nearly of an equal length. The length of the straps of the pintles which come upon the rudder may all be within four inches of the aft side of the rudder; and the rudder being a flat surface, they will all appear of the proper lengths.

II. *Of the half-breadth and body plans.*—The half-



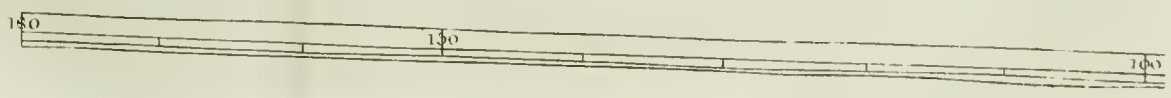
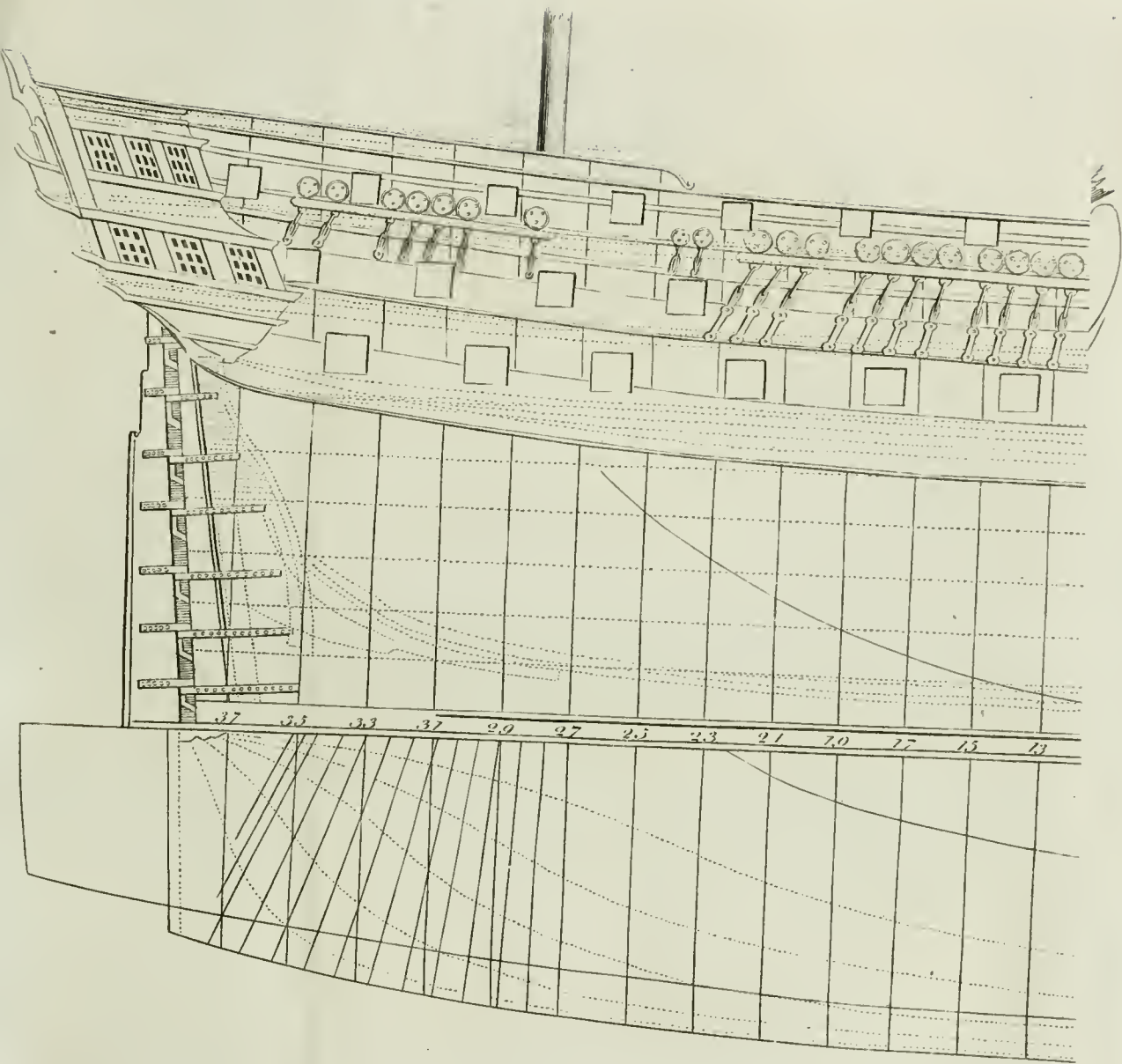

Fig. 33.

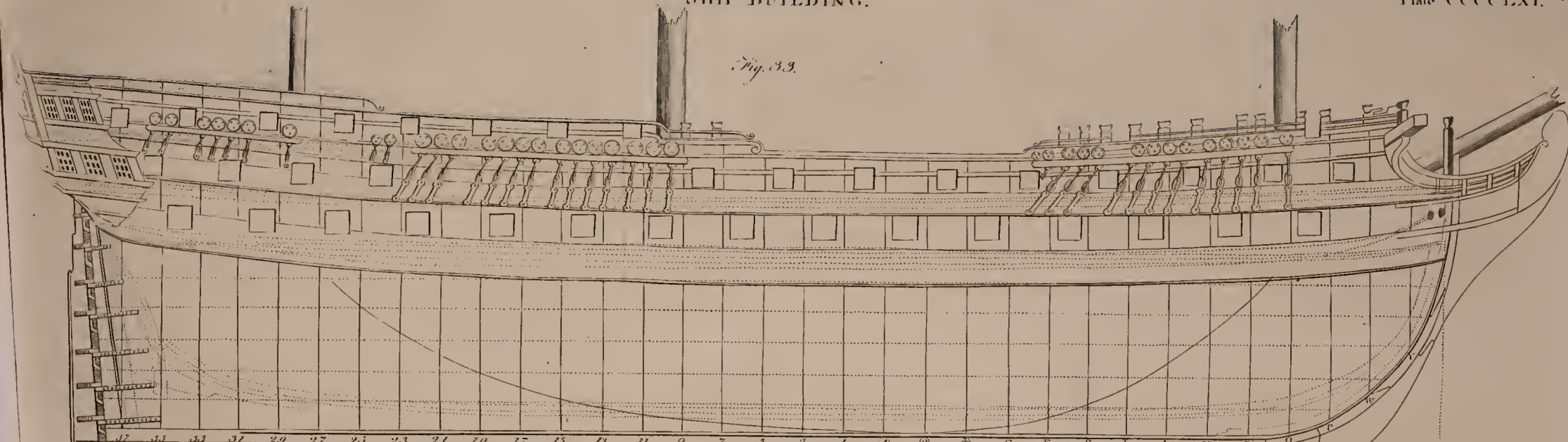
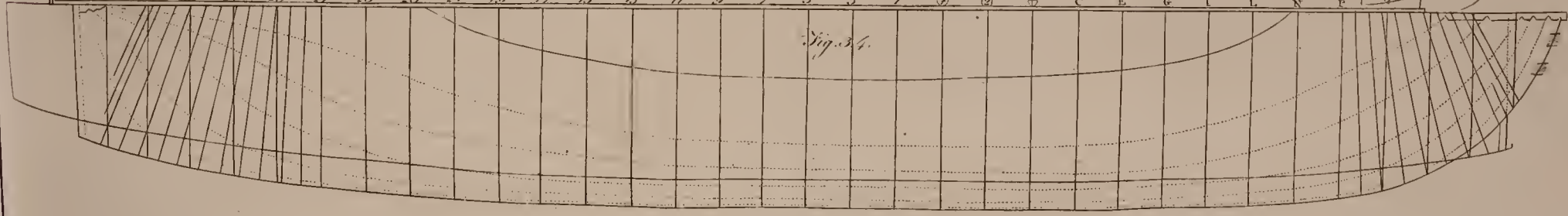

Fig. 34.



37 32 33 37 29 27 25 23 21 20 17 15 13 11 9 7 5 3 2 1 0 0 0 C E G I L N P O

Scale of Feet.



A. Bell, Penn. and S. G. P. 1841

breadth plan must be first drawn. Then produce the lower edge of the keel both ways, and let it also represent the middle line of the half-breadth plan. Produce all the frames downwards, and also the fore and after perpendiculars. Then from the place in the sheer plan, where the height of breadth-lines intersect the stem, square down to the middle line the fore and aft part of the rabbet and the fore part of the stem. Take from the dimensions what the stem is sided at that place, and set off half of it from the middle line in the half-breadth plan, through which draw a line parallel to the middle line through the three lines squared down, and the half-breadth of the stem will be represented in the half-breadth plan. Take the thickness of the plank of the bottom, which is  $4\frac{1}{2}$  inches, and describe the rabbet of the stem in the half-breadth plan.

From the points of intersection of the height of breadth lines with the counter timber at the side, and with the counter timber at the middle line, draw lines perpendicular to the middle line of the half-breadth plan, from which set off the half breadth of the counter on the line first drawn; and from this point to the intersection of the line last drawn, with the middle line draw a curve, and the half breadth of the counter will be represented at the height of breadth, which will be the broadest part of the stem.

Take the main half breadth of timber dead flat from the dimensions, and lay it off from the middle line on dead flat in the half-breadth plan. Take also from the dimensions the main half breadth of every timber, and set off each from the middle line on the corresponding timbers in the half-breadth plan. Then a curve drawn from the end of the line representing the half breadth of the counter through all the points, set off on the timbers, and terminating at the aft part of the stern, will be the main half breadth line. Take from the dimensions the top-timber half breadth, and describe the top-timber half-breadth line in the half-breadth plan, in the same manner as the main half-breadth line.

Take from the dimensions the half breadth of the rising, and set it off from the middle line on the corresponding timbers in the half-breadth plan, observing, where the word *outside* is expressed in the tables, the half breadth for that timber must be set off above or on the outside of the middle line. Then a curve drawn through these points will be the half breadth of rising in the half-breadth plan.

It will now be necessary to proceed to the body plan. Draw a horizontal line (fig. 35.), which is called the *base line*, from the right hand extremity of which erect a perpendicular. Then set off on the base line the main half breadth at dead flat, and erect another perpendicular, and from that set off the main half breadth again, and erect a third perpendicular. The first perpendicular, as already observed, is called the *side line* of the fore body; the second the *middle line*; and the third the *side line* of the after body.

Take from the dimensions the heights of the diagonals up the middle line, and set them from the base up the middle line in the body plan. Take also their distances from the middle line on the base, and set them off. Set off also their heights up the side lines, and draw the diagonals. Then take from the sheer plan the heights of the lower height of breadth line, and set them off upon the middle line in the body plan; through these

points lines are to be drawn parallel to the base, and terminating at the side lines. In like manner proceed with the upper height of breadth line.

The rising is next to be set off on the body plan; it must, however, be first described in the sheer plan: Take, therefore, the heights from the dimensions, and set them off on the corresponding timbers in the sheer plan, and a curve described through these points will be the rising line in the sheer plan. Then take from the dimensions the rising heights of dead flat. Set it off in the body plan, and draw a horizontal line. Now take all the rising heights from the sheer plan, and set them off in the body plan from the line drawn for the rising height of dead flat, and draw horizontal lines through these points. Take from the half-breadth plan the half breadths of the rising, and set them off from the middle line in the body plan, and the centres of the floor sweeps of the corresponding timbers will be obtained.

From the half-breadth plan take the main half-breadth lines, and set them off from the middle line in the body plan on the corresponding lines before drawn for the lower height of breadth; and from the extremities of these lines set off towards the middle line the lengths of the lower breadth sweeps respectively.

Take from the dimensions the distance of each frame from the middle line on the diagonals, and set them off from the middle line on their respective diagonal lines. Now these distances being set off, and the lower breadth and floor sweeps described, the shape of the frames below the breadth line may easily be drawn as follows: Place one point of a compass in the distance set off for the length of the lower breadth sweep, and extend the other to the point which terminates the breadth, and describe an arch of a circle downwards, which will intersect the points set off on the upper diagonal lines, letting it pass as low as convenient. Then fix one point of the compasses in the centre of the floor sweep, and extend the other to the point set off on the fourth diagonal, which is the floor head; and describe a circle to intersect as many of the points set off on the diagonals as it will. Then draw a curve from the back of the lower breadth sweep, through the points on the diagonals, to the back of the floor sweep. Describe also another curve from the back of the floor sweep through the points on the lower diagonals, and terminating at the upper part of the rabbet of the keel, and that part of the frame below the breadth will be formed. In like manner describe the other frames.

Through the extremities of the frames at the lower height of breadth draw lines parallel to the middle line, and terminating at the upper height of breadth line, and from thence set off the upper breadth sweeps; now fix one point of the compass in the centres of the upper breadth sweeps successively, and the other point to the extremities of the frames, and describe circles upwards. Then from the sheer plan take off the heights of the top-timber lines, and set them off in the body plan, drawing horizontal lines; upon which set off the top-timber half breadths taken from the corresponding timbers in the half-breadth plan; and by describing curves from the back of the upper breadth sweeps through the points set off on the seventh or upper diagonal; and intersecting the top-timber half-breadths, the timbers will then be formed from the keel

Application  
of the fore-  
going Rules  
to the Con-  
struction of  
Ships.

keel to the top of the side. The upper end of the timbers may be determined by taking the several heights of the upper part of the top side above the top-timber line, and setting them off above the top-timber line on the corresponding timbers in the body plan. The lower parts of the timbers are ended at the rabbet of the keel as follows: With an extent of  $4\frac{1}{2}$  inches, the thickness of the bottom, and one leg of the compasses at the place where the line for the thickness of the keel intersects the base line; with the other leg describe an arch to intersect the keel line and the base. Then fix one point at the intersection of the arch and keel, and from the point of intersection of the keel and base describe another arch to intersect the former. Then from the intersection of these arches draw one straight line to the intersection of the keel and base, and another to the intersection of the lower arch and the keel, and the rabbet of the keel will be described at the main frame. All the timbers in the middle part of the ship which have no rising terminate at the intersection of the upper edge of the rabbet with the base line; but the lower part of the timbers, having a rising, end in the centre of the rabbet, that is, where the two circles intersect. Those timbers which are near the after end of the keel must be ended by setting off the half-breadth of the keel at the port in the half-breadth plan, and describe the tapering of the keel. Then at the corresponding timbers take off the half-breadth of the keel; set it off in the body plan, and describe the rabbet as before, letting every timber end where the two circles for its respective rabbet intersect.

To describe the side counter or stern timber, take the height of the wing transom, the lower counter, upper counter, and top-timber line at the side; from the sheer plan transfer them to the body plan, and through these points draw horizontal lines. Divide the distance between the wing transom and lower counter into three equal parts, and through the two points of division draw two horizontal lines. Draw also a horizontal line equidistant from the upper counter and the top-timber line in the sheer plan, and transfer them to the body plan.

Now, from the point of intersection of the aft side of the stern timber at the side, with the wing transom at the side in the sheer plan, draw a line perpendicular to the middle line in the half-breadth plan. Draw also perpendicular lines from the points where the upper and lower transoms touch the stern-post; from the points of intersection of the stern timber with the two horizontal lines drawn between, and from the intersection of the stern timber with the horizontal line drawn between the upper counter and top-timber line. Then curves must be formed in the half-breadth plan for the shape of the body at each of these heights. In order to which, begin with the horizontal or level line representing the height of the wing transom in the body plan. Lay a slip of paper to that line, and mark on it the middle line and the timbers 37, 35, 33, and 29; transfer the slip to the half-breadth plan, placing the point marked on it for the middle line exactly on the middle in the half-breadth plan, and set off the half breadths on the corresponding timbers 37, 35, 33, and 29, and describe a curve through these points, and to intersect the perpendicular drawn from the sheer plan. In like manner proceed with the horizontal lines at the heights of the counters, between the lower counter and wing transom,

above the upper counter and top timber line; and from the intersections of the curve drawn in the half breadth of the sheer plan, with the perpendicular lines drawn from the sheer plan, take the distances to the middle line, and set them off on the corresponding lines in the body plan; then a curve described through the several points thus set off will be the representative of the stern timber.

The round-up of the wing transom, upper and lower counter, may be taken from the sheer draught, and set off at the middle line above their respective level lines in the body plan, by which the round-up of each may be drawn. The round aft of the wing transom may also be taken from the sheer plan, and set off at the middle line, abaft the perpendicular for the wing transom in the half-breadth plan, whence the round aft of the wing transom may be described.

The after body being now finished, it remains to form the fore body; but as the operation is nearly the same in both, a repetition is therefore unnecessary, except in those parts which require a different process.

The foremost timbers end on the stem, and consequently the method of describing the ending of them differs from that used for the timbers used in the after body. Draw a line in the body plan parallel to the middle line, at a distance equal to the half of what the stem is sided. In the sheer plan take the height of the point of intersection of the lower part of the rabbet of the stem with the timber which is required to be ended, and set it off on the line before drawn in the body plan. Then take the extent between the points of intersection of the timber with the lower and upper parts of the rabbet, and with one leg of the compasses at the extremity of the distance laid off in the body plan describe a circle, and the timbers may then pass over the back of this circle. Now, by applying a small square to the timber, and letting the back of it intersect the point set off for the lower part of the rabbet, the lower part of the rabbet and the ending of the timbers will be described.

The foremost timbers differ also very much at the head from those in the after body: For since the ship carries her breadth so far forward at the top-timber line, it therefore occasions the two foremost frames to fall out at the head beyond the breadth, whence they are called *knuckle* timbers. They are thus described: The height of the top-timber line being set off in the body plan, set off on it the top half breadth taken from the half-breadth plan, and at that place draw a perpendicular; then from the sheer plan take the height of the top of the side, and set it off on the perpendicular in the body plan: Take also the breadth of the rail at the top-timber line in the sheer plan, and set it off below the top-timber line at the perpendicular line in the body plan, and the straight part of the knuckle timber to be drawn will be determined. Then from the last mentioned point set off describe a curve through the points set off for the timber down to the upper breadth, and the whole knuckle timber will be formed. It will hence be seen that those timbers forward fall out beyond the main breadth with a hollow, contrary to the rest of the top side, which falls within the main breadth with a hollow.

The fore and after bodies being now formed, the water lines must next be described in the half-breadth plan, in order to prove the fairness of the bodies. In this draught the water lines are all represented parallel to the

Application  
of the fore-  
going Rules  
to the Co-  
struction  
Ships.

the keel; their heights may, therefore, be taken from the sheer plan, and transferred to the body plan, drawing horizontal lines, and the water lines will be represented in the body plan. In ships that draw more water abaft than afore, the water lines will not be parallel to the keel; in this case, the heights must be taken at every timber in the sheer plan, and set off on their corresponding timbers in the body plan; and curves being described through the several points, will represent the water lines in the body plan.

Take the distances from the middle line to the points where the water lines intersect the different timbers in the body plan, and set them off on their corresponding timbers in the half-breadth plan. From the points where the water lines in the sheer plan intersects the aft part of the rabbet of the sternpost draw perpendiculars to the middle line of the half-breadth plan, and upon these perpendiculars set off from the middle line the half thickness of the sternpost at its corresponding water line; which may be taken from the body plan, by setting off the size of the post at the head and the keel, and drawing a line for the tapering of it; and where the line so drawn intersects the water lines, that will be the half thickness required: then take an extent in the compasses equal to the thickness of the plank, and fix one point where the half thickness of the post intersects the perpendicular, and with the other describe a circle, from the back of which the water lines may pass through their respective points set off, and end at the fore part of the half breadth plan, proceeding in the same manner as with the after part. A line drawn from the water line to the point set off for the half thickness of the post will represent the aft part of the rabbet of the post; and in like manner the rabbet of the item may be represented. The water lines being all described, it will be seen if the body is fair; and if the timbers require any alteration, it should be complied with.

The cant timbers of the after body may next be described in the half-breadth plan; in order to which the cant of the fashion-piece must first be represented. Having therefore the round part of the wing transom represented in the half-breadth plan, and also the shape of a level line at the height of the wing transom; then set off the breadth of the wing transom at the end, which is one foot four inches, and that will be the place where the head of the fashion-piece will come: now to determine the cant of it, the shape of the body must be considered; as it must be canted in such a manner as to preserve as great a straightness as is possible for the shape of the timber, by which means the timber will be much stronger than if it were crooked; the cant must also be considered, in order to let the timber have as little bevelling as possible. Let, therefore, the heel of the timber be set off on the middle line, two feet afore timber 35; and then drawing a line from thence to the point set off on the level line for the wing transom, the cant of the fashion piece will be described, and will be found situated in the best manner possible to answer the before mentioned purposes.

The cant of the fashion-piece being represented, the cant of the other timbers may now be easily determined. Let timber 29 be the foremost cant timber in the after body and with a pencil draw timber 28; then observe how many frames there are between timber 28

and the fashionpiece, which will be found to be nine, namely, 29, 30, 31, 32, 33, 34, 35, 36. and 37. Now divide the distance between timber 28 and the fashion-piece on the middle line into 10 equal parts: Divide also the corresponding portion of the main half breadth lines into the same number of equal parts; and straight lines joining the corresponding points at the middle line with those in the half-breadth line will represent the cant timbers in the after body.

The line drawn for the cant of the fashion-piece represents the aft side of it, which comes to the end of the transoms; but in order to help the conversion with regard to the lower transoms, there may be two more fashion-pieces abaft the former; therefore the foremost fashion-piece, or that which is already described in the half-breadth plan, may only take the ends of the three upper transoms, which are, the wing, filling, and deck: the middle fashion-piece may take the four next, and the after fashion piece the lower ones: therefore set off in the half-breadth plan the siding of the middle and after fashion-piece, which may be 13 inches each; then by drawing lines parallel to the foremost fashion-piece, at the aforesaid distance from each other, the middle and after fashion-piece will be represented in the half-breadth plan.

The fashion-piece and transoms yet remain to be represented in the sheer plan; in order to which, let the number of transoms be determined, which, for so large a buttock, may be seven below the deck transom: draw them with a pencil, beginning with the wing, the upper side of which is represented by a level line at its height; set off its siding below that, and draw a level line for the lower edge. The filling transom follows: which is merely for the purpose of filling the vacancy between the under edge of the wing and the upper part of the deck plank: it may therefore be represented by drawing two level lines for the upper and lower edge, leaving about two inches between the upper edge and lower edge of the wing transom, and four inches between the lower edge of the gun-deck plank: then the deck transom must be governed by the gun-deck, letting the under side of the gun-deck plank represent the upper side of it, and setting off its siding below that; the under edge may also be drawn: the transoms below the deck may all be sided equally, which may be 11 inches; they must also have a sufficient distance between to admit the circulation of the air to preserve them, which may be about three inches.

The transoms being now drawn with a pencil, the fashion-piece must next be described in the sheer plan, by which the length of the transoms as they appear in that plan will be determined. As the foremost fashion-piece reaches above the upper transom, it may therefore be first described: in order to which, draw a sufficient number of level lines in the sheer plan; or, as the water lines are level, draw therefore one line between the upper water line and the wing transom, and one above the wing transom at the intended height of the head of the fashion-piece, which may be about five feet; then take the height of these two level lines, and transfer them to the body plan; and take off two or three timbers and run them in the half-breadth plan, in the same manner as the water lines were done; then from the point where the line drawn for the cant of the fashion-piece, in the half-breadth plan, intersects the level

Application of the foregoing Rules to the Construction of Ships.

Application  
of the fore-  
going Rules  
to the Con-  
struction of  
Ships.

A vertical line drawn for the head of the fashion-piece, draw up a perpendicular to the said line in the sheer plan, making a point. Again, from the intersection of the cant line, with the level line for the wing transom in the half breadth plan, draw a perpendicular to the wing transom in the sheer plan. Also draw perpendiculars from the points where the cant line in the half-breadth plan intersects the level line below the wing transom, and also the water lines to the corresponding lines in the sheer plan; then a curve described through these points will be the representation of the foremost fashion-piece in the sheer plan. In the same manner the middle and after fashion-pieces may be described; observing to let the middle one run up no higher than the under part of the deck transom, and the after to the under side of the fourth transom under the deck. The transoms may now be drawn with ink, as their lengths are limited by the fashion-pieces.

Neither the head nor the fore-side of the sternpost are yet described; take, therefore, from the dimensions, the breadth of the post on the keel, and set it off on the upper edge of the keel from the aft side of post. The head of the post must next be determined, which must just be high enough to admit of the helm-post transom and the tiller coming between it and the upper deck beam; the height therefore that is necessary will be one foot nine inches above the wing transom. Now draw a level line at that height, upon which set off the breadth of the sternpost at that place, taken from the dimensions, and a line drawn from thence to the point set off on the keel will be the fore-side of the sternpost; observing, however, not to draw the line through the transoms, as it will only appear between them. The inner post may be drawn, by setting off its thickness forward from the sternpost, and drawing a straight line as before, continuing it no higher than the under side of the wing transom.

The cant-timbers in the after body being described, together with the parts dependent on them, those in the fore body may be next formed; in order to which, the foremost and aftermost cant timbers must be first determined, and also the cant of the foremost ones. The foremost cant-timber will extend so far forward as to be named E; the cant on the middle line may be one foot four inches afore square timber W, and on the main half breadth line one foot nine inches afore timber Y; in which situation the line may be drawn for the cant; the aftermost may be timber Q. The cant timbers may now be described in the same manner as those in the after body, namely, by spacing them equally between the cant timber E and the square timber P, both on the main half breadth and middle lines, and drawing straight lines between the corresponding points, observing to let them run out to the top-timber half-breadth line, where it comes without the main half breadth line.

The hawse pieces must next be laid down in the half breadth plan; the sides of which must look fore and aft with the ship upon account of the round of the bow. Take the siding of the apron, which may be about four inches more than the stem, and set off half of it from the middle line, drawing a line from the main half breadth to the foremost cant timber, which will represent the foremost edge of the knight-head; then from that set off the siding of the knight-head, which may

be one foot four inches, and draw the aft side of it. The hawse pieces may then be drawn, which are four in number, by setting off their sidings, namely, one foot six inches parallel from the knight-head and from each other; and straight lines being drawn from the main half breadth line to the foremost cant timber will represent them.

The hawse holes should be described in such a manner as to wound the hawse pieces as little as possible; they may therefore be placed so that the joint of the hawse pieces shall be in the centre of the holes, whence they will only cut half the hawse pieces. Take the dimensions of the hawse holes, which is one foot six inches, and set off the foremost one, or that next the middle line, on the joint between the first and second hawse piece; then set off the other on the joint between the third and fourth hawse piece; and small lines being drawn across the main half breadth at their respective places will represent the hawse holes in the half-breadth plan.

The hawse holes should next be represented in the sheer plan. In this class of ships they are always placed in the middle between the cheeks; therefore set off their diameter, namely, one foot six inches, between the cheeks, and draw lines parallel to the cheeks for their upper and lower part. Then to determine their situation agreeable to the half-breadth plan, which is the fore and aft way, draw perpendiculars from their intersections with the main half-breadth line to the lines drawn between the cheeks, and their true situations, the fore and aft way, will be obtained; and, by describing them round or circular, according to the points set off, they will be represented as they appear in the sheer plan.

The apron may be drawn in the sheer plan, setting off its bigness from the stem, and letting it come so low that the scarf may be about two feet higher than the foremost end of the fore foot; by which it will give ship to the scarfs of the stem. It may run up to the head of the stem.

The cutting down should next be drawn. Take therefore from the tables of dimensions the different heights there expressed, and set them off from the upper edge of the keel on the corresponding timbers in the sheer plan: then a curve described through the points set off, from the inner post aft to the apron forward, will be the cutting down. Next set off from the cutting down the thickness of the timber strake, which is  $8\frac{1}{2}$  inches, and a curve described parallel to the former will represent the timber strake, from which the depth of the hold is always measured.

The keelson is drawn, by taking its depth from the dimensions, and setting it off above the cutting down line; and a curve described parallel to the cutting down will represent the keelson.

The cutting down line being described, the knee of the dead wood abaft timber 27, being the after floor timber, may then be represented. Set off the siding of the floor abaft it, and erect a perpendicular in the sheer plan, which will terminate the foremost end of the dead wood: then the fore and aft arm of the knee may be half the length of the whole dead wood, and the up and down arm may reach to the under part of the lower transom; and the whole knee may be placed in such a manner that the upper piece of the dead

wood shall bolt over it, and be of as much substance as the knee itself: therefore the knee must consequently be placed its whole thickness below the cutting down line representin; the upper part of the dead wood.

The sheer draught, the body, and half-breadth plans are now finished from whence the ship may be laid down in the mould loft, and also the whole frame erected. As, however the use of the diagonal lines in the body plan has not been sufficiently explained, it is therefore thought proper to subjoin the following illustration of them.

The diagonal lines in the body plan are mentioned in the tables of dimensions merely for the purpose of forming the body therefrom; but after the body is formed, they are of very principal use, as at their stations the ribbands and harpins which keep the body of the ship together while in her frames are all described, and the heads of the different timbers in the frame likewise determined.

The lowermost diagonal, or n<sup>o</sup> 1. which is named the *lower firmark*, at which place the bevellings are taken for the hollow of the floors; its situation is generally in the middle between the keel and the floor firmark.

Second diagonal is placed in the midships, about 18 inches below the floor head, and is the station where the floor ribband is placed in midships, and likewise the floor harpin forward; there is also a bevelling taken at this diagonal all the way fore and aft, from which it is termed the *floor firmark*.

Third diagonal, terminates the length of the floors, and is therefore called the *floor head*. There are likewise bevellings taken at this diagonal as far forward and aft as the floor extends. The placing of this diagonal is of the utmost consequence to the strength of the ship, it being so near to that part of the bulge which takes the ground, and of consequence is always liable to the greatest strain; it should therefore be placed as much above the bearing of the body in midships as could be conveniently allowed by conversion of the timber; but afore and abaft it is not of so much consequence.

Fourth diagonal is placed in the middle between the floor head and the fifth diagonal, at which place a ribband and harpin are stationed for the security of the first or lower futtock, from whence it is named the *first futtock firmark*. There are also bevellings taken at this diagonal all afore and aft, which being part of the body where the timbers most vary, occasions them to be the greatest bevellings in the whole body.

Fifth diagonal terminates the heads of the first futtocks, and is therefore called the *first futtock head*. It should be placed at a convenient distance above the floor head, in order to give a sufficient scarf to the lower part of the second futtocks. There are likewise bevellings for the timbers taken at this diagonal, all fore and aft.

Sixth diagonal should be placed in the middle between the first futtock head and the seventh diagonal; at which place the ribband and harpin are stationed for the support of the second futtocks. Bevellings are taken at this diagonal all fore and aft. It is named the *second futtock firmark*.

Seventh diagonal terminates the second futtock heads from the fore to the aftermost floors, and afore and abaft them it terminates the double futtock heads

in the fore and aft cant bodies. It should be placed in midships, as much above the first futtock head as the first futtock is above the floor head: by which it gives the same scarf to the lower part of the third futtock as the first futtock does to the second. There are bevellings taken all fore and aft at this diagonal. It is named the *second futtock firmark*.

Eighth diagonal is the station for the ribband and harpin which supports the third futtocks, and is therefore placed between the second futtock head and ninth diagonal. It is also a bevelling place, and is named the *third futtock firmark*.

Ninth and last diagonal is placed the same distance above the second futtock head as that is above the first, and terminates all the heads of the third futtocks which are in the frames, as they come between the ports; but such as are between the frames, and come under the lower deck ports, must run up to the under part of the ports, as no short timbers should by any means be admitted under the ports, which require the greatest possible strength. This diagonal is likewise a bevelling place for the heads of the third futtocks, and is therefore called the *third futtock head*.

The fourth futtock heads are terminated by the under part of the upper deck ports all fore and aft, and a ribband is placed fore and aft at the height of the upper breadth line, another between the lower and upper deck ports, and one at the top-timber line; which, with the ribbands and harpins before-mentioned, keep the whole body of the ship together, and likewise in its proper form and shape.

It must be observed, that the diagonal lines laid down in the dimensions will not correspond to what has been said above upon diagonals, as they were drawn discretionally upon the body for the purpose of giving the true dimensions of it. Therefore, when the body is drawn in fair, the first diagonals (which should only be in pencil) are to be rubbed out, and the proper diagonals drawn with red ink, strictly adhering to what has been said above.

SECT. III. *Of the Inboard Works of the Ship described in the preceding Section.*

DRAUGHTS of the outboard works being now constructed, in which every part is described that is necessary to enable the artist to put the ship in her frames, we must now proceed to form another draught of the cavity of the ship or inboard works, which must be so contrived that every thing within the ship may be arranged in the most commodious manner and to the best advantage.

It is usual to draw the inboard works in the sheer draught; but as this generally occasions much confusion, it is therefore the best and easiest method to appropriate a draught to this particular purpose.

Take from the sheer draught the stem, stern-post, counter timbers, and keel, and describe them on another paper; draw in also the cutting down, keelson, apron, transoms, fashion-pieces, and decks, and the upper line of the sheer all fore and aft, also the timbers and ports.

The beams come first under consideration, and should be so disposed as to come one under and one between each port, or as near as can be to answer other works of the ship; but where it happens that a beam cannot possibly be placed under the port, then a beam arm

Application of the foregoing Rules to the Construction of Ships.

Ship-Builders's Repository.

Application  
of the fore-  
going Rules  
to the Con-  
struction of  
Ships.

should be introduced to make good the deficiency. Every beam, and also the beam arms, should be knee'd at each end with one lodging and one hanging knee; and in those parts of the ship which require the knees to be very acute, such as the after beams of the gun-deck, and in some ships, whose bodies are very sharp, the foremost beams of the gun-deck, there should be knees of iron. Care should be taken always to let the upper side of the knees be below the surface of the beams in large ships one inch and a half, and in small ships an inch, by which means the air will have a free passage between the knees and under part of the deck.

In the conversion of the beams the side next the lodging knee should be left as broad at the end of the beam as can possibly be allowed by the timber, the beam retaining its proper scantling at the end of the lodging knee: by so doing the lodging knees will be more without a square, which consequently makes them the more easy to be provided.

In ships where the beams can be got in one piece, they should be so disposed as to have every other one with the butt end the same way; for this reason, that the butts will decay before the tops. In large ships the beams are made in two or three pieces, and are therefore allowed to be stronger than those that are in one piece. The beams in two pieces may have the scarf one-third of the length, and those in three pieces should have the middle piece half the length of the whole beam. The customary way of putting them together is to table them; and the length of the tablings should be one-half more than the depth of the beam. It is very common to divide the tablings in the middle of the beam, and that part which is taken out at the upper side to be left at the lower side, and then kersey or flannel is put into the scarf: but in this case the water is liable to lie in the scarf, and must be the means of rotting the beams. If, however, the beams were tabled together in dovetails, and taken through from side to side, putting tar only between them, which hardens the wood; then the water occasioned by the leaking of the decks would have a free passage, and the beam would dry again; and this method would not be found inferior in point of strength to the other. The length of the fore and aft arm of the lodging knee should extend to the side of the hanging knee next to it; but there is no necessity for that arm to be longer than the other. In fastening the knees, care should be taken to let one bolt pass exactly through the middle of the throat, one foot six inches from each end, and the rest divided equally between; observing always to have the holes bored square from the knee. The bolts for the thwartship arms of both hanging and lodging knees may go through the arms of each knee, and drive every one the other way.

In order to draw the beams in the draught, take the moulding of the lower deck beams, and set it off below the line representing the deck at the side, and draw a line in pencil parallel thereto, which will represent the under side of the beams. In like manner represent the under side of the beams for the upper deck, quarter deck, forecastle, and roundhouse. Then take the siding of the lower deck beams, and place one under and one between each port, all fore and aft, drawing them in pencil. Determine the dimensions of the well fore

and aft, which is ten feet, and set it off abaft the beam under the eighth port, placing the beam under the ninth port at that distance: those two beams may then be drawn in ink, and will terminate the extent of the well the fore and aft way; and as a beam cannot go across the ship at that place upon account of its being the well and mast room, there must therefore be a beam arm between these two beams.

The main hatchway should then be determined, letting the beam that forms the fore part of the well form the aft part of it, and the beam under the next part may form the fore side of it, which beam may also be now drawn in ink: there should also be another beam arm introduced in the wake of the main hatchway.

The fore hatchway may be next determined; the fore side of which should range well up and down with the after end of the forecastle, and it may be fore and aft about four-sevenths of the main hatchway. At the fore side of the fore hatchway there must be a ladder-way down to the orlop, which may be as much fore and aft as the beams will allow. The rest of the beams afore the fore hatchway may remain as first placed, there being nothing in the way to alter the ship. Then determine on the after hatchway, the fore side of which comes to the aft side of the mainmast room.

There should also be a hatchway, the fore side of which may be formed by the aft side of the beam under the twelfth port; which is for the conveniency of the spirit and fish rooms: and there should be a ladder-way abaft it to lead down to the cockpit. There may be also another hatchway, the fore side of it to be formed by the aft side of the beam under the eleventh port. The size of the ladder and hatchways must be governed by the beams, as when there is a good shift of beams they should not be altered for ladder and hatchways, unless it is the three principal hatchways, which must always be of a proper size, according to the size of the ship.

The after capstan must be placed between the two hatchways last described, and the beams abaft may stand as they are already shifted, observing only the mizenmast. There should be a small scuttle placed afore the second beam from aft, for the conveniency of the bread room: it must be on one of the middle lines, as there is a carling at the middle under the four or five after beams to receive the pillars for the support thereof.

The bits may be placed, letting the fore side of the after ones come against the aft side of the beam abaft the third port, and the fore side of the foremost ones against the next beam but one forward; then at the fore side of each bit there should be drawn a small scuttle for the conveniency of hauling up the powder from the magazine. The breast hook should also be drawn, which may be three feet the moulding away, and sided nine-tenths of the beams of the lower deck.

The gun-deck, beams, knees, &c. being described; in which, as well as all the decks having ports, the same precautions are to be used as in the gun-deck; and observing to keep the beams upon one deck as nearly as possible over the beams of the other, for the conveniency of pillaring, as they will then support each other.

The hatchways are to be placed exactly over those  
on

Applica-  
of the f-  
going R-  
to the C-  
struction  
Ships.



Application of the fore-going Rules to the Construction of Ships.

on the lower deck, each over each; and therefore, where there is a beam arm in the lower deck there must also be one above it in the upper deck, and the same in the middle deck in three-deck ships. It commonly happens in ships of the line that there cannot be a whole beam between the deck breast hook and the beam that supports the step of the bowsprit, because the bowsprit passes through that place: in this case, there must be a beam arm placed, letting the end come equally between the beam and the breast hook: but in ships that the bowsprit will allow of a whole beam, then the ports and the rest of the beams must be consulted in order to space it; and when it so happens that the foremast comes in the wake of a port, then a beam arm must be necessarily introduced.

Having placed the beams according to the disposition of the other beams below, the ladder-ways should be contrived: there should be one next abaft the fore hatchway, which is a single ladder-way; and one next afore the main hatch, which is a double ladder-way; the ladders standing the fore and aft way. There should also be another next abaft the after hatch, and one over the cockpit corresponding with that on the lower deck.

The capstans are next to be considered; the after one is already placed on the lower deck, the barrel of which must pass through the upper deck to receive the whelps and drumhead there, it being a double capstan. In ships having three decks, the upper part of each capstan is in the middle deck; but in ships with one deck there is only this one capstan, the upper part of which is placed on the quarter deck. The foremost capstan should be placed in the most convenient spot, to admit of its being lowered down to the orlop out of the way of the long boat: it may therefore be placed between the main and fore hatchways; the beam under the sixth port of the lower deck may form the aft side of its room, and the beams on each side of it should be placed exactly over or under the beams on the other decks, and they should be at a distance from each other sufficient to let the drumheads pass between them. The centre of the capstan should then be placed in the middle between the beams which compose its room; and the partners should be fitted in such a manner as to shift occasionally when wanted, which is by letting them be in two pieces fitted together. The partners on the lower deck, wherein the capstan steps, must be supported by a pillar on the orlop deck, the lower part of which may be fitted in an oak chock; so that when the pillar is taken away, and the capstan lowered down, that chock serves as a step for the capstan. Those two beams on the orlop, by having the pillar and chock upon them, have therefore the whole weight of the capstan pressing downwards: for the support of them, there should be a carling placed underneath the fore and aft way, with three pillars, one under each beam, and one between; all of them being fixed in the keelson, by which the orlop deck will be well supported in the wake of the capstan, and the other decks will feel no strain from it.

The fire hearth is next to be disposed; which is placed differently according to the size of the ship. In three-deckers it is found most convenient to place it on the middle deck; whence there is much more room under the fore-castle than there would have been had it

been placed there. In all two-deck ships it is placed under the fore-castle, because on the deck underneath the bits are in the way. It is also under the fore-castle in one-deck ships, though confined between the bits: in this case it should be kept as near as possible to the after bits, that there may be more room between it and the foremost bits to make a good galley.

The positions of the main-top-sail-sheet bits are next to be determined; the foremost of which must be so placed as to let its foreside come against the aft side of the beam abaft the main hatchway, and to pass down to the lower deck, and there step in the beams: admitting it to be a straight piece, it would come at the aft side of the lower deck beam the same as it does at the upper deck beam, in consequence of those two beams ranging well up and down with each other: it must therefore have a cast under the upper deck beam, by which the lower part may be brought forward sufficient to stop in the lower deck beam. The aftermost must be placed against the foreside of the beam abaft the mast, and step on the beam below; but there is no necessity to provide a crooked piece as before, for the beam of the upper deck may be moved a little farther aft, till it admit of the bit stopping on the lower deck beam, unless the beam comes under a port, as in that case it must not by any means be moved. The cross pieces to the bits should be on the foreside, and in height from the upper deck about one-third of the height between it and the quarter deck. With regard to the heads of the bits, the length of the ship's waste should be considered; and if there is length enough from the fore-castle to the foremost bits to admit of the spare gear being stowed thereon without reaching farther aft, the quarter deck may then run so far forward that the head of the foremost bits shall tenon in the foremost beam; this gives the mainmast another deck, and admits of the quarter deck being all that the longer: but if there is not the room before mentioned, then the quarter deck must run no further forward than the after bits, which will then tenon in the foremost beam; and the foremost bits must have a cross piece let on their heads, which is termed a *horse*, and will be for the purpose of receiving the ends of the spare gear.

The length of the quarter deck being now determined, the beams are then to be placed. For this purpose the several contrivances in the quarter deck must be previously consulted. It is necessary to observe, that there are neither earlings nor lodges, the carlings of the hatches excepted, in the quarter deck, round-house, and fore-castle; as they would weaken instead of strengthening the beams, which should be as small as the size of the ship will permit, in order that the upper works may be as light as possible. Hence, as there are to be neither earlings nor lodges, the deck will require a greater number of beams, and a good round up, as on the contrary the deck would be apt to bend with its own weight. The most approved rule is therefore to have double the number of beams in the quarter deck as there are in a space of the same length in the upper deck.

Then proceed to shift the beams to the best advantage, consulting the hatchways, ladder-ways, masts, bits, wheel, &c. With respect to the ladder-ways on the quarter decks of all ships, there should be one near the fore part of the great cabin for the officers, and another

Application  
of the fore-  
going Rules  
to the Con-  
struction of  
Ships.

other near the foremoſt end of the quarter deck, con-  
ſiſting of double ladders for the conveyance of the men  
up from the other decks in caſes of emergency; and  
likewiſe one on each ſide of the fore part of the quar-  
ter deck from the gangway; and in every ſhip of the  
line all the beams from the foremoſt ladder-way to the  
after one ſhould be open with gratings, both for the  
admiſſion of air, and for the greater expedition of con-  
veying different articles in the time of action.

Two ſcuttles are to be diſpoſed one on each ſide of  
the mainmaſt, if it happens to come through the quar-  
ter deck, for the top tackles to paſs through, to hook  
to the eye bolts drove in the upper deck for that pur-  
poſe.

The ſteering wheel ſhould be placed under the fore-  
part of the roundhouſe, and the two beams of the quar-  
ter deck, which come under it, ſhould be placed con-  
formable to the two uprights, ſo that they may tenon  
in them. The quarter deck beams ſhould be kneed at  
each end with one hanging and one lodging knee;  
which adds greatly to the ſtrength of the ſide. The  
hanging knees which come in the great cabin may be  
of iron; their vertical arms to be two-thirds of the  
length of that of wood, and to reach the ſpiketing.  
It ſhould be obſerved, that the beam abaft, which  
comes under the ſcreen bulkhead, ſhould round aft  
agreeable to the round of the bulkhead, for the ſupport  
of the ſame.

The forecaſtle beams ſhould be placed according as  
the works of the deck will admit. The hatchways are  
therefore to be conſidered firſt. There ſhould be one  
for the funnel of the fire hearth to paſs through, and  
one for the copper to admit of vent for the ſteam; and  
alſo one or two over the galley as the forecaſtle will  
admit of. The fore-topſail-ſheet bits ſhould be ſo diſ-  
poſed as to come one pair on the fore and one on the  
aft ſide of the maſt, to let into the ſide of the forecaſtle  
beams, and ſtep on the upper deck beams below: there  
ſhould alſo be a ladder-way at the fore part of the fore-  
caſtle for the conveniency of the fore part of the ſhip.

The beams may now be placed agreeable thereto,  
their number being four more than there are in a ſpace  
in the upper deck equal in length to the forecaſtle;  
and where there happens to be a wide opening between  
the beams, as in the caſe of a hatchway, maſt room,  
&c. then half a beam of fir may be introduced to make  
good the deficiency. The foremoſt beam ſhould be of  
a breadth ſufficient to take the aft ſide of the inboard  
arms of the catheads, as they are ſecured upon this  
beam by being bolted thereto. Every beam of the  
forecaſtle ſhould be kneed at each end with one hang-  
ing and one lodging knee: the vertical arms of the  
hanging knees ſhould reach the ſpiketing, and the  
knees well bolted and carefully clenched.

Proceed to the roundhouſe; the ſame things being  
obſerved with reſpect to the beams as in the quarter  
deck: for as the roundhouſe beams are ſided very ſmall,  
it hence follows that they muſt be near to each other.  
Let therefore the number of beams on the roundhouſe  
be four more than in the ſame length of the quarter  
deck; every other beam being of fir for lightneſs, and  
every oak beam may be kneed at each end with one  
hanging and one lodging knee; the hanging knees abaft  
may be of iron, their vertical arms to be in length two

thirds of thoſe of wood. The roundhouſe ſhould al-  
ways have a great round up, both for ſtrength and con-  
veniency. There muſt be on the roundhouſe a ſmall  
pair of knee-bits on each ſide of the mizenmaſt, turned  
round and ſecured over each other, and bolted through  
the maſt carlings. There muſt alſo be a companion on  
the roundhouſe placed over the middle of the coach,  
in order to give light thereto.

With regard to placing the roundhouſe beams, the  
uprights of the ſteering wheel and the mizenmaſt are  
to be obſerved; as when the beams which interfere  
with thoſe parts are properly ſpaced, the reſt may be  
diſpoſed of at diſcretion, or at an equal diſtance from  
each other, and letting the beam over the ſcreen bulk-  
head have a proper round aft, agreeable to the quarter  
deck beam underneath.

The upper parts of the inboard works being now de-  
ſcribed, proceed next to the lower parts, or to thoſe  
which come below the lower deck. Draw in the orlop,  
by taking the heights afore, at midſhips, and abaft,  
between that and the gun-deck, from the dimensions,  
and a curve deſcribed through theſe points will repre-  
ſent the upper part of the deck. Set off the thickneſs  
of the plank below, and the under ſide of the plank will  
be repreſented. As this deck does not run quite for-  
ward and aft as the other decks, the length of it muſt  
be therefore determined; for this purpoſe let the after  
beam be placed at a ſufficient diſtance from aft to ad-  
mit of the bread rooms being of a proper ſize for the  
ſhip, which will be under that beam of the gun-deck  
that comes at the ſecond part from aft. The after  
beam being drawn in, proceed to ſpace the other beams,  
placing them exactly under thoſe of the gun-deck; and  
that which comes under the foremoſt beam of the gun-  
deck may terminate the fore part of the orlop. Draw  
the limber ſtrake, by ſetting off its thickneſs above the  
cutting down line, and a line drawn parallel thereto will  
repreſent the limber ſtrake. That part of the orlop  
which is over the after magazine, ſpirit room, and fiſh  
room, and alſo that which is over the fore magazine, is  
laid with thicker planks than the reſt of the deck;  
which is for the better ſecurity of thoſe places, the  
planks being laid over the beams; but in the midſhips,  
from the fore part of the ſpirit room to the aft part of  
the fore magazine, the beams are laid level with the ſur-  
face of the deck, and the planks are rabbeted in from  
one beam to the other.

In order to repreſent the orlop as juſt deſcribed, the  
dimensions of the different apartments above mentioned  
muſt be determined: Let the aft ſide of the after beam  
be the aft ſide of the after magazine, and from thence  
draw the bulkhead down to the limber ſtrake; and the  
foreſide of the third beam may be the foreſide of the af-  
ter magazine, drawing that bulkhead likewiſe, which  
will alſo form the aft ſide of the fiſh room; the foreſide  
of the fiſh room may be drawn from the aft ſide of the  
fiſth beam, which will alſo repreſent the aft ſide of the  
ſpirit room; then the foreſide of the ſpirit room may  
be drawn from the foreſide of the ſixth beam. Hence  
from the foreſide of the ſixth beam quite aft the deck  
will be repreſented by the two lines already drawn, and  
the upper ſide of the beams will be repreſented by the  
lower line.

Proceed next to the forepart of the orlop, letting the fore-

Applica-  
tion of the  
going R-  
ules to the  
Conſtruction  
of Ships.

fore-side of the after bits be the aft part of the foremost magazine, drawing the bulk-head thereon, which will come to the aft side of the sixth beam; therefore, from the sixth beam to the foremost end of the orlop, the plank and beams will be represented just in the same manner as before mentioned for the after part of the orlop: then the midship part of the deck will be represented by letting the upper line be the upper side of the plank, and likewise the upper side of the beams; and the lower line will represent the lower edge of the plank, only drawing it from beam to beam, and observing not to let it pass through them.

The hatchways, &c. may now be represented on the orlop, letting the main, fore, and after hatchway, be exactly under those of the gun-deck: there must be one over the fish room, and one over the spirit room. There must be two senttles over the after magazine for the passage to the magazine and light room. There should also be one afore the fourth beam from forward for the passage to the fore magazine, and one abaft the second beam for the passage to the light room.

The bulkheads for the fore and after parts of the well may be drawn from the lower deck beams to the orlop, and from thence to the lumber strake in the hold. The shot lockers may also be represented, having one afore and one abaft the well: there should also be one abaft the foremost magazine, the ends of which may be formed by the after bits. The steps of the masts may be drawn in by continuing their centres down to the lumber strake; and likewise two crutches abaft the mizen step divided equally between that and the after part of the cutting down: the breast hooks may also be drawn letting them be five in number below the lower deck hook, and all equally divided between that and the fore step. Hence every part of the inboard is described as far as necessary.

CHAP. V. Of the Method of Whole-moulding.

HAVING now finished the methods of laying down the several plans of a ship, any farther addition on this subject might appear unnecessary. We cannot, however, with propriety, omit to describe the method called whole-moulding, used by the ancients, and which still continues in use among those unacquainted with the more proper methods already explained. This method will be illustrated by laying down the several plans of a long-boat; the length of the keel being 29 feet, and breadth moulded nine feet.

Draw the straight line PO (fig. 37.) equal to 29 feet, the extreme length of the boat, and also to represent the upper edge of the keel. Let  $\oplus$  be the station of the midship frame. From the points P,  $\oplus$ , and O, draw the lines PT,  $\oplus$ M, and OS, perpendicular to PO. Make  $\oplus$ M,  $\oplus$ N, equal to the upper and lower heights of breadth respectively at the main frame, PT the height of breadth at the transom, and OS the height at the stem. Describe the curve TMS to represent the sheer or extreme height of the side, which in a ship would be called the upper height of breadth line, or upper edge of the wale. Through the point N draw a curve parallel to TMS, to represent the breadth of the upper strake of a boat, or lower edge of the wale if in

a ship. The dotted line TNS may also be drawn to represent the lower height of breadth.

Set off the rake of the port from P to  $\rho$ , and draw the line  $\rho t$  to represent the aft side of the port; then Tt will represent the round up of the transom. Set off the breadth of the port from  $\rho$  to r, and from T to s, and draw the line rs to represent the fore-side of the port, which may either be a curve or a straight line at pleasure. Set up the height of the truck from  $\rho$  to k. Let kX be the thickness of the transom, and draw the line ZX to represent the fore-side of the transom.

There is given the point S, the height of the sheer on the fore-side of the stem; now that side of the stem is to be formed either by sweeps or some other contrivance. Set off the breadth of the stem, and form the aft side of it.

Set up the dead-rising from  $\oplus$  to d, and form the rising line r i s. Draw the line KL parallel to PO to represent the lower edge of the keel, and another to represent the thickness of the plank or the rabbet. The rabbet on the post and stem may also be represented; and the stations of the timbers assigned, as  $\oplus$ , (1), 1, 2, 3, 4, 5, 6, 7, 8, 9; and  $\oplus$ , (A), A, B, C, D, E, F, G, H; and the sheer plan will be completed.

The half-breadth plan is to be formed next; for this purpose the perpendiculars TP, 9, 8, &c. must be produced. Upon M  $\oplus$  produced set off the half breadth from the line KL to R (fig. 38.); set off also the half breadth at the transom from K to b, and describe the extreme half breadth line bRX, making the fore-part of the curve agreeable to the proposed round of the transom.

We may next proceed to form the timbers in the body plan. Let AB (fig. 39.) be the breadth moulded at  $\oplus$ . Erect the perpendicular CD in the middle of the line AB; draw the line mn distant therefrom the half thickness of the post, and xy the half thickness of the stem. Then take off the several portions of the perpendiculars  $\oplus$ , 1, 2, &c. intercepted between the upper edge of the keel and the rising line in the sheer plan, and set them up from C upon the line CD; through these points draw lines parallel to AC; take off also the several lower heights of breadth at  $\oplus$ , 1, 2, &c. from the sheer plan; and set them up from C upon the middle line in the body plan; and draw lines parallel to AC through these points: Then take off the several half breadths corresponding to each from the floor plan; and set them off on their proper half-breadth lines from the middle line in the body plan.

Construct the midship frame by Problem V. the form of which will in some measure determine the form of the rest. For if a mould be made on any side of the middle line to fit the curve part of it, and the rising line, or that marked *tend mould* (fig. 4.), and laid in such a manner that the lower part of it, which is straight, may be set upon the several rising lines, and the upper part just touch the point of the half breadth in the breadth line corresponding to that rising upon which the mould is placed, a curve may then be drawn by the mould to the rising line. In this manner we may proceed so far as the rising line is parallel to the lower height of the breadth line. Then a hollow mould must be made, the upper end of which is left straight, as that

Method of Whole-moulding

Meth d  
of Whole-  
moulding.

that marked *hollow mould* (fig. 40.). This is applied in such a manner, that some part of the hollow may touch the side of the keel, and the straight part touch the back of the curve before described by the bend mould; and, beginning abaft, the straight part will always come lower on every timber, till we come to the midship timber, when it comes to the side of the keel. Having thus formed the timbers, so far as the whole mouldings will serve, the timbers abaft them are next formed. Their half breadths are determined by the sheer and floor plans, which are the only fixed points through which the curves of these timbers must pass. Some form these after timbers before the whole is moulded, and then make the hollow mould, which will be straighter than the hollow of either of these timbers. It is indifferent which are first formed, or what methods are used; for after the timbers are all formed, though every timber may appear very fair when considered by itself, it is uncertain what the form of the side will be. In order to find which, we must form several ribband and water lines; and if these do not make fair curves, they must be rectified, and the timbers formed from these ribband and water lines. In using the hollow mould, when it is applied to the curve of each timber, if the straight part is produced to the middle line, we shall have as many points of intersection as there are timbers; and if the heights above the base be transferred to the corresponding timbers in the sheer plan, a curve passing through these points is what is called a *rising strait*. This may be formed by fixing a point for the aftermost timber that is whole moulded, and transferring that height to the sheer plan. The curve must pass through this point, and fall in with the rising line somewhere abaft dead flat; and if the several heights of this line be transferred from the sheer to the middle line in the body plan, these points will regulate what is called the *hauling down* of the hollow mould.

The timbers in the after body being all formed, those in the fore body are formed in the same manner, by transferring the several heights of the rising and breadth lines from the sheer to the body plan; the half breadths corresponding to each height must also be transferred from the floor to the body plan. The same hollow mould will serve both for the fore and after body; and the level lines, by which the water lines to prove the after body were formed, may be produced into the fore body, and by them, the water lines to prove the fore body, may be described.

Another method of proving the body is by ribband lines, which are formed by sections of planes inclined to the sheer plan, and intersecting the body plan diagonally, as before observed, of which there may be as many as may be judged necessary. As this has been already explained, we shall therefore lay down only one, represented in the body plan by the lines marked *d* & *a*. These are drawn in such a manner as to be perpendicular to as many timbers as conveniently may be. After they are drawn in the body plan, the several portions of the diagonal intercepted between the middle line and each timber must be transferred to the floor plan. Thus, fix one foot of the compasses in the point where the diagonal intersects the middle line in the body plan; extend the other foot to the point where the diagonal intersects the timber; for example, timber 9; Set off the same extent upon the perpendicular representing the plane

of timber 9 from the point where it intersects the line KL on the floor plan: in like manner proceed with all the other timbers both in the fore and after body; and these shall have the points thro' which the curve must pass. If this should not prove a fair curve, it must be altered, observing to conform to the points as nearly as the nature of the curve will admit: so it may be carried within one point, and without another, according as we find the timbers will allow. For after all the ribband lines are formed, the timbers must, if needful, be altered by the ribband lines: this is only the reverse of forming the ribband lines; for taking the portions of the several perpendiculars intercepted between the line KL and the curve of the ribband line in the floor plan, and setting them off upon the diagonal from the point where it intersects the middle line, we shall have the points in the diagonal through which the curves of the timbers must pass. Thus the distance between the line KL and the ribband at timber 3 on the floor plan, when transferred to the body plan, will extend on the diagonal from the middle line to the point where the curve of timber 3 intersects that diagonal. The like may be said of all the other timbers; and if several ribband lines be formed, they may be so contrived that their diagonals in the body plan shall be at such distances, that a point for every timber being given in each diagonal, will be sufficient to determine the form of all the timbers.

In stationing the timbers upon the keel for a boat, there must be room for two futtocks in the space before or abaft  $\otimes$ ; for which reason, the distance between these two timbers will be as much more than that between the other as the timber is broad. Here it is between  $\oplus$  and (A); which contains the distances between  $\oplus$  and (t), and the breadth of the timber besides.

The timbers being now formed, and proved by ribband and water lines, proceed then to form the transom, fashion-pieces, &c. by Problem VI.

This method of whole-moulding will not answer for the long timbers afore and abaft. They are generally canted in the same manner as those for a ship. In order to render this method more complete, we shall here describe the manner of moulding the timbers after they are laid down in the mould loft, by a rising square, bend, and hollow mould.

It was shown before how to form the timbers by the bend and hollow moulds on the draught. The same method must be used in the loft; but the moulds must be made to their proper scantlings in real feet and inches. Now when they are set, as before directed, for moulding each timber, let the middle line in the body plan be drawn across the bend mould, and draw a line across the hollow mould at the point where it touches the upper edge of the keel; and let them be marked with the proper name of the timber, as in fig. 40. The graduations of the bend mould will therefore be exactly the same as the narrowing of the breadth. Thus, the distance between  $\otimes$  and 7 on the bend mould is equal to the difference between the half breadth of timber 7 and that of  $\oplus$ . The height of the head of each timber is likewise marked on the bend mould, and also the floor and breadth firmarks. The floor firmark is in that point where a straight edged batten touches the back of the bend mould, the batten being so placed

as to touch the lower edge of the keel at the same time. The several risings of the floor and heights of the cutting down line are marked on the rising square, and the half breadth of the keel set off from the side of it.

The moulds being thus prepared, we shall apply them to mould timber 7. The timber being first properly sided to its breadth, lay the bend mould upon it, so as may best answer the round according to the grain of the wood; then lay the rising square to the bottom of the bend mould, so that the line drawn across the bend mould at timber 7 may coincide with the line representing the middle of the keel upon the rising square; and draw a line upon the timber by the side of the square, or let the line be scored or cut by a tool made for that purpose, called a *raising knife* (E); this line so rased will be the side of the keel. Then the square must be moved till the side of it comes to 7 on the bend mould, and another line must be rased in by the side of it to represent the middle of the keel. The other side of the keel must likewise be rased after the same manner, and the point 7 on the rising square be marked on each side of the keel, and a line rased across at these points to represent the upper edge of the keel. From this line the height of the cutting down line at 7 must be set up, and then the rising square may be taken away, and the timber may be rased by the bend mould, both inside and outside, from the head to the floor firmark; or it may be carried lower if necessary. After the firmarks and head of the timbers are marked, the bend mould may likewise be taken away, and then the hollow mould applied to the back of the sweep in such a manner that the point 7 upon it may intersect the upper side of the keel, before set off by the rising square; and when in this position the timber may be rased by it, which will complete the outside of the timbers. The inside of the timbers may likewise be formed by the hollow mould. The scantling at the keel is given by the cutting down before set off. The mould must be so placed as to touch the sweep of the inside of the timber formed before by the bend mould, and pass through the cutting down point.

The use of the firmarks is to find the true places of the futtocks; for as they are cut off three or four inches short of the keel, they must be so placed that the futtock and floor firmarks may be compared and coincide. Notwithstanding which, if the timbers are not very carefully trimmed, the head of the futtock may be either within or without its proper half breadth; to prevent which a half breadth staff is made use of.

The half breadth staff may be one inch square, and of any convenient length. Upon one side of it are set off from one end the several half breadths of all the timbers in the after body, and those of the fore body upon the opposite side. On the other two sides are set off the several heights of the sheer, the after body on one side, and the fore body on its opposite. Two sides of the staff are marked *half breadths*, and the other two sides *heights of the sheer*.

The staff being thus prepared, and the floor-timbers

fastened on the keel, and levelled across, the futtocks must next be fastened to the floor timbers; but they must be set first to their proper half breadth and height. The half breadth staff, with the assistance of the ram-line §, serves to set them to the half breadth: for as the keel of a boat is generally perpendicular to the horizon, therefore the line at which the plummet is suspended, and which is inmoveable on the ram line, will be perpendicular to the keel. Whence we may by it set the timbers perpendicular to the keel, and then set them to their proper half breadths by the staff: and when the two firmarks coincide, the futtock will be at its proper height, and may be nailed to the floor timbers, and also to the breadth ribband, which may be set to the height of the sheer by a level laid across, taking the height of the sheer by the staff from the upper side of the keel; by which means we shall discover if the ribband is exactly the height of the sheer; and if not, the true height may be set off by a pair of compasses from the level, and marked on the timbers.

#### CHAP. VI. Of the Practice of Ship-building.

THE elevation, projection, and half-breadth plans, of a proposed ship being laid down on paper, we must next proceed to lay down these several plans on the mould loft of the real dimensions of the ship proposed to be built, and from which moulds for each separate part are to be made. The method of laying down these plans, from what has been already said, will, it is presumed, be no very difficult task to accomplish, as it is no more than enlarging the dimensions of the original draughts; and with respect to the moulds, they are very easily formed agreeable to the figure of the several parts of the ship laid down in the mould loft.

Blocks of wood are now to be prepared upon which the keel is to be laid. These blocks are to be placed at nearly equal distances, as of five or six feet, and in such a manner that their upper surfaces may be exactly in the same plane, and their middle in the same straight line. This last is easily done by means of a line stretched a little more than the proposed length of the keel; and the upper planes of these blocks may be verified by a long and straight rule; and the utmost care and precaution must be taken to have these blocks properly bedded. Each block may be about six or eight inches longer than the keel is in thickness; their breadth from 12 to 14 inches, and their depth from a foot to a foot and half.

The dimensions of the keel are to be taken from the mould loft, and the keel is to be prepared accordingly. As, however, it is seldom possible to procure a piece of wood of sufficient length for a keel, especially if for a large ship, it is, therefore, for the most part necessary, to compose it of several pieces, and these pieces are to be scarfed together, and securely bolted, so as to make one entire piece. It must, however, be observed, that the pieces which compose the keel ought to be of such lengths, that a scarf may not be opposite to the step of any of the masts. Rabbits are to be formed on each side of the keel to receive the edge of the planks next

to

Practice  
of Ship-  
building.

§ See next  
Chapter.

(E) The term *raising* is used when any line is drawn by such an instrument instead of a pencil.

Practice  
of Ship-  
building.

to it, or garboard strake, and the keel is to be laid on the blocks (F).

The stem, and the post, and the several transoms belonging to it, are to be prepared from the moulds, and rabbeted in like manner as the keel, to receive the ends of the plank. The transoms are to be bolted to the post at their middle, each at its respective height, taken from the elevation in the mould loft, and the extremities of the transoms are to be firmly connected with the fashion-pieces. Both stem and post are then to be erected, each at its respective extremity of the keel. The tenons at the heel of each being let into mortises prepared to receive them, and being set to their proper rakes or angles with the keel, are to be supported by props or shores. Pieces of wood called *dead wood*, are to be laid upon and fixed to the upper side of the keel towards the fore and aft parts of it; the deepness of the dead wood increasing with its distance from the middle, agreeable to the proposed form of the cutting down line.

A line is to be stretched from the middle of the head of the stem to that of the post, called the *ran line*, upon which is a moveable line with a plummet affixed to it. The midship and other frames are to be erected upon the keel at their proper stations. The extremities of each frame are set at equal distances from the vertical longitudinal section of the ship, by moving the frame in its own plane until the plumb-line coincides with a mark at the middle between the arms of each frame; and although the keel is inclined to the horizon, yet the frames may also be set perpendicular to the keel by means of the plumb-line. The shores which are supporting the frames are now to be securely fixed, that the position of the frames may not be altered. The ribbands are now to be nailed to the frames at their proper places, the more effectually to secure them; and the intermediate vacancies between the frames filled up with filling timbers. For a perspective view of a ship framed, see Plate CCCCLIV. fig. 2.

The frames being now stationed, proceed next to fix on the planks, of which the wales are the principal, being much thicker and stronger than the rest, as is represented in the midship frame, Plate CCCXIV. The harpins, which may be considered as a continuation of the wales at their fore ends, are fixed across the hawse pieces, and surround the fore part of the ship. The planks that inclose the ship's sides are then brought about the timbers; and the clamps, which are of equal thickness with the wales, fixed opposite to the wales within the ship. These are used to support the ends of the beams, and accordingly stretch from one end of the ship to the other. The thick stuff or strong planks of the bottom within board are then placed opposite to the several scarfs of the timbers, to reinforce them throughout the ship's length. The planks employed to line the ship, called the *ceiling* or *foot-cauling*, is next fixed in the intervals between the thick stuff of the hold. The beams are afterwards laid across the ship to support the decks, and are connected to the side by lodging and

hanging knees: the former of which are exhibited at F, Plate CLVI. See also the article DECK; and the hanging-knees, together with the breadth, thickness, and position of the keel, floor timbers, futtocks, top-timbers, wales, clamps, thick stuff, planks within and without, beams, decks, &c. are seen in the midship frame, Plate CCCXIV. and in that article these several parts have already been explained.

The cable-bits being next erected, the *earlings* and *legs*, represented in Plate CLVI. are disposed between the beams to strengthen the deck. The *water-ways* are then laid on the ends of the beams throughout the ship's length, and the *spirketing* fixed close above them. The upper deck is then planked, and the *string* placed under the *gunnel*, or *plank-beer*, in the waist. The disposition of those latter pieces on the timbers, viz. the water-ways, *spirketing*, upper deck, *string*, and *gunnel*, are also represented in the midship frame, Plate CCCIV.

Then proceed next to plank the quarter-deck and fore-castle, and to fix the *posters* of the masts and capsterns with the *coumings* of the hatches. The *brass-books* are then bolted across the stem and bow within-board, the step of the foremast placed on the kelson, and the *riders*, exhibited in the MIDSHIP FRAME, layed to the inside of the timbers, to reinforce the sides in different parts of the ship's length. The *pointers*, if any, are afterwards fixed across the hold diagonally to support the beams; and the *croches* stationed in the after hold to unite the half timbers. The *steps* of the mainmast and capsterns are next placed; the planks of the lower decks and orlop laid; the *navel-hoods* layed to the hawse holes; and the *knees of the head*, or cut-water, connected to the stem. The figure of the head is then erected, and the *trail-board* and *cheeks* fixed on the side of the knee.

The *taffarel* and *quarter-pieces*, which terminate the ship abaft, the former above and the latter on each side, are then disposed, and the stern and quarter galleries framed and supported by their brackets. The *pumps*, with their well, are next fixed in the hold; the *limber boards* laid on each side of the kelson, and the *garboard strake* fixed on the ship's bottom next to the keel without.

The hull being thus fabricated, proceed to separate the apartments by bulkheads or partitions, to frame the port lids, to fix the catheads and ches-trees; to form the hatchways and scuttles, and fit them with proper covers or gratings. Next fix the ladders at the different hatchways, and build the manger on the lower deck, to carry off the water that runs in at the hawse-holes when the ship rides at anchor in a sea. The bread room and magazines are there lined; and the *gunnel*, rails, and *gun-ways* fixed on the upper part of the ship. The cleats, kevels, and ranges, by which the ropes are fastened, are afterwards bolted or nailed to the sides in different places.

The rudder, being fitted with its irons, is next hung to the stern post, and the *tiller* or bar, by which it is managed, let into a mortise at its upper end. The *scuppers*,

(F) In ships of war, which are a long while in building, it has been found that the keel is often apt to rot before they are finished. Upon this account, therefore, some builders have begun with the floor timbers, and added the keel afterwards.

scuppers, or leaden tubes, that carry the water off from the decks, are then placed in holes cut through the ship's sides; and the standards represented in the MIDSHIP FRAME, Plate CCCXIV. bolted to the beams and sides above the decks to which they belong. The poop lanterns are fast fixed upon their cranes over the stern, and the bilge-ways or cradles placed under the bottom to conduct the ship steadily into the water whilst launching.

As the various pieces which have been mentioned above are explained at large in their proper places, it is therefore superfluous to enter into a more particular description of them here.

CHAP. VII. *Of Improvements in the Masts and Rudder.*

SINCE the article MAST was printed, an account of a method for restoring masts of ships when wounded, or otherwise injured, in an easy, cheap, and expeditious manner, by Captain Edward Pakenham of the royal navy, has been published in the tenth volume of the Transactions of the Society for the Encouragement of Arts, &c. Captain Pakenham introduces his invention with the following observations:

"Among the various accidents which ships are liable to at sea, none call more for the attention and exertion of the officer than the speedy refitting of the masts; and having observed, in the course of last war, the very great destruction made among the lower masts of our ships from the enemy's mode of fighting, as well as the very great expence and delay in refitting a fleet after an action, particularly across the Atlantic—a very simple expedient has suggested itself to me as a resource in part; which appears so very speedy and secure, that the capacity of the meanest sailor will at once conceive it. I therefore think it my duty to state my ideas of the advantages likely to result from it; and I shall feel myself exceedingly happy should they in anywise contribute to remedy the evil.

"My plan, therefore, is, to have the heels of all lower masts so formed as to become the heads: but it is not the intention of the above plan to have the smallest alteration made in the heels of the present lower masts; for as all line-of-battle ships masts are nine inches in diameter larger at the heel than at the head, it will follow, that by letting in the tressel-trees to their proper depth, the mast will form its own cheeks or hounds; and I flatter myself the following advantages will result from the above alteration.

First, I must beg to observe, that all line-of-battle ships bury one-third of their lower masts, particularly three-deckers; it therefore follows, that if the wounds are in the upper third, by turning the mast so as to make the heel the head, it will be as good as new; for, in eight actions I was present in last war, I made the following observations:

"That in the said actions fifty-eight lower masts were wounded, and obliged to be shifted, thirty-two of which had their wounds in the upper third, and of course the ships detained until new masts were made. And when it is considered that a lower mast for a 90 or 74 stands government in a sum not less, I am informed, than 2000 l. to 2300 l. the advantages across the Atlantic resulting from the aforesaid plan will be particularly obvious; not to mention the probability of there being no fit spars in the country, which was the case in

the instances of the Isis and Princess Royal; and as I was one of the lieutenants of the Isis at that time, I am more particular in the circumstance of that ship. The Isis had both her lower masts wounded above the cathar pins in her action with the Cæsar, a French 74; and as there were no spars at New York, the Isis was detained five weeks at that place.—Now, if her masts had been fitted on the plan I have proposed, I am confident she would have been ready for sea in 48 hours; and as a further proof, I beg leave to add, that the whole fleet, on the glorious 12th of April, had not the least accident of any consequence except what befel their lower masts, which detained them between eight and ten weeks at Jamaica.

"The delay of a ship while a new mast is making, and probably the fleet being detained for want of that ship, which frequently occurred in the course of last war, the taking of shipwrights from other work, with a variety of inconveniences not necessary to mention here, must be obvious to every officer that has made the smallest observations on sea actions.

"You will further observe, that this substitute is formed on the most simple principle, fitted to the meanest capacity, and calculated to benefit all ships, from a first-rate down to the smallest merchantman, in cases of an accident by shot, a spring, a rottenness, particularly as these accidents generally happen in the upper third of the mast and above the cheeks.

"It might probably be objected, that a difficulty and some danger might arise from the wounded part of the mast being below; but this will at once be obviated, when it is remembered, that as the wounded part is below the wedges, it may with ease be both fished, cased, and secured, to any size or degree you please, with the addition of its being wedged on each deck."

Fig. 41. represents a mast of a first-rate in its proper state, the figures representing its thickness at the different divisions.

Fig. 42. the same mast inverted, the heel forming the head, and the tressel-trees let into their proper depth, the additional thickness of the mast forming its own cheeks.

Fig. 43. the proposed mast, the figures representing the thickness of the mast in the proposed alterations; a, the heel made square; b, the letting in of the tressel-trees; c, the third proportion of thickness continued up to where the fourth is in the present mast, or at least some little distance above the lower part of the cheeks, which is always looked upon as the weakest part of the mast; and by its being so proportioned, the mast, when turned, will be nearly as strong in the partners as before.

As the expence of a mast is much greater than is generally imagined, it is therefore thought proper to subjoin the following statement of the several articles used in making a 74 gun ship's mainmast.

	Value.	
Fishes for a spindle, 21 inches, 2 nails of		
two masts, - - -	L. 101 3 11	Papers on Naval Architecture, part 2.
'Two side fishes, 22 inches, 2 ditto,	133 10 9	
Fore and aft fishes, 22 inches, 2 nails of		
one mast, - - -	66 13 10	
Fish } 21½ inches, 1 nail of half a mast, 29	8 5	
Iron } On the fore part.		
3 qrs 19 lbs	1 5 9	
Aries load baulk, 2 loads 22 feet, -	12 2 5	

Improvements in the Masts and Rudder.

		Brought over	Value.			
Breadthning	} 2 loads 7 feet, Dantzic fir timber.	L.	344	5	1	
			11	1	7	
{	Cheeks } 4 loads 2 feet,		20	18	4	
		Iron, 5 cwt. 2 qrs 24 lb.		8	0	0
	Knees, elm timber, 13 feet,		0	15	2	
	Iron, 2 qrs. 14 lb.		0	17	6	
	Hoops and bolts on the body, 13 cwt. 1 qr. 16 lb.		18	15	0	
	Tressel trees, straight oak timber, second fort, 2 loads 10 feet,		10	2	4	
	Iron, 3 qrs. 10 lb.		1	3	6	
	Cross trees, straight oak timber, second fort 1 load 12 feet,		5	14	0	
	Iron, 2 qrs. 2 lb.		0	14	6	
	Cap, elm timber, 1 load 24 feet,		4	6	0	
	Iron, 2 cwt. 14 lb.		2	19	6	
	Fullings, bolsters, bollins, and Dantzic fir, 1 load 2 feet,		5	7	8	
	Workmanship,		78	6	0	
			<hr/>			
			L.	513	6	2
Main-topmast of a 74 gun ship,				50	16	3
Main top-gallant-mast,				8	11	0

the lines the beams or framing of wood, which are employed at proper places and at proper distances from each other, for connecting them together. Perhaps solid frames of wood, placed at proper distances from each other, and filling up the whole dotted space, would answer better; in which event, the mast could be strongly hooped with iron at those places, and the upright trees formed square, or of any other convenient form.

"It will be evident to those acquainted with this subject, that such masts would be greatly stronger than common ones containing the same quantity of materials. It is likewise evident that they would be less apt to spring, as being supported on a more extended base, and affording many conveniences for being better secured; and that they might be constructed of such wood as at present would be deemed altogether improper for masts: a circumstance of importance to Britain at all times, but more particularly now, when there is such difficulty in procuring wood proper for the kind of masts in common use."

An improvement in the rudder has lately taken place in several ships, particularly in some of those in the service of the East India company. It will, however, be necessary previously to describe the usual form of the rudder, in order to show the advantages it possesses when constructed agreeable to the improved method.

N<sup>o</sup> 1. (fig. 47) represents the rudder according to the common method of construction; in which AB is the axis of rotation. It is hence evident that a space considerably greater than the transverse section of the rudder at the counter must be left in the counter for the rudder to revolve in. Thus, let CAB (n<sup>o</sup> 2.) be the section of the rudder at the counter; then there must be a space similar to CDE in the counter, in order that the rudder may be moveable as required. Hence, to prevent the water from washing up the rudder case, a rudder coat, that is, a piece of tarred canvas, is nailed in such a manner to the rudder and counter as to cover the intermediate space: but the canvas being continually washed by the sea, soon becomes brittle, and unable to yield to the various turns of the rudder without breaking; in which case the ship is of course left pervious to the waves, even of three or four feet high; in fact, there are few men bred to the sea who have not been witnesses to the bad effects of such a space being left so ill guarded against the stroke of the waves; and many ships have, with great probability, been supposed to founder at sea from the quantity of water shipped between the rudder and counter.

It was to remedy this defect that the alteration above alluded to took place; which consists in making the upper part AFG (fig. 48, n<sup>o</sup> 1.) of the rudder ABI cylindrical, and giving that part at the same time a cast forward, so that the axis of rotation may by that means be the line AD, passing as usual from E to D, through the centres of the braces which attach the rudder to the stern-post, and from E to A through the axis

Principles of Naval Architecture, p. 50.

Mr Gordon's plan of building masts.

In order to lessen the enormous expence of masts, a proposal was made some years ago to construct them hollow; and the author having premised several experiments which he had made, proceeds as follows:

"Galileo taught us, that the resistance or strength of a hollow cylinder is to that of a full cylinder, containing the same quantity of matter, as the total diameter of the hollow one is to the diameter of the full one; and these experiments show us, that the strength or resistance of two or more pieces of wood, fastened together at each end, and connected by a pillar, pillars, or framing, increases, at least to a certain degree, *ceteris paribus*, as the distance between them and number of pillars, provided the force is applied in the line or direction of the pillars.

"It is surprising that this discovery of Galileo has not been made subservient to more useful purposes. It is particularly applicable to the construction of masts, as not requiring that the hollow cylinder should be made of one solid piece of wood (c).

"However, the foregoing experiments teach us, that the same advantages may be obtained by other forms besides that of a cylinder; and that perhaps not only in a superior degree, but likewise with greater facility of execution; as by adopting a square figure, but more particularly by constructing them of separate pieces of wood, placed at proper distances from each other, in the following or any other manner that may be found most convenient. Fig. 44, 45, and 46, exhibit each the transverse section of a mast, in which the small circles represent the trees or upright pieces of wood, and

(c) The strength of these cylinders would be still further augmented by having solid pieces of wood placed within them at proper distances, and securely fastened to them, in the same manner, and on the same principles, that nature has furnished reeds with joints; and for answering, in some respects, the same purpose as the pillars in the experiments alluded to.



axis the cylinder AFG, in order that the transverse section KH (n° 2.) at the counter may be a circle revolving upon its centre; in which case the space of half an inch is more than sufficient between the rudder and the counter, and consequently the necessity of a rudder coat entirely done away. But as it was foreseen, that if the rudder by any accident was unshipped, this alteration might endanger the tearing away of the counter, the hole is made much larger than the transverse section of the cylindrical part of the rudder, and the space between filled up with pieces of wood so fitted to the counter as to be capable of withstanding the shock of the sea, but to be easily carried away with the rudder, leaving the counter, under such circumstances, in as safe a state as it would be agreeable in the present form of making rudders in the navy.

CHAP. VIII. Upon the Position of the Load water Line, and the Capacity of a Ship.

THE weight of the quantity of water displaced by the bottom of a ship is equal to the weight of the ship with its rigging, provisions, and every thing on board. If therefore the exact weight of the ship when ready for sea be calculated, and also the number of cubic feet in the ship's bottom below the load-water line, and hence the weight of the water she displaces; it will be known if the load-water line is properly placed in the draught.

The position of the ship in the draught may be either on an even keel, or to draw most water abaft; but an even keel is judged to be the best position in point of velocity, when the ship is constructed suitable thereto, that is, when her natural position is such. For when a ship is constructed to swim by the stern, and when brought down to her load-water made to swim on an even keel (as is the case with most ships that are thus built), her velocity is by that means greatly retarded, and also her strength greatly diminished: for the forepart being brought down lower than it should be, and the middle of the ship maintaining its proper depth in the water, the after part is by that means lifted, and the ship is then upon an even keel: but in consequence of her being out of her natural position, the after part is always pressing downwards with a considerable strain, which will continue till the ship's sheer is entirely broke, and in time would fall into its natural position again: for which reason we see so many ships with broken backs, that is, with their sheers altered in such a manner that the sheer rounds up, and the highest part is in the midships.

Such are the disadvantages arising from not paying a due attention to those points in the construction of a draught; therefore, when the load-water line is found to be so situated at a proper height on the draught, according to the weight given for such a ship, and also drawn parallel to the keel, as supposing that to be the best sailing trim, the next thing is to examine whether the body is constructed suitable thereto, in order to avoid the above-mentioned ill consequences.

In the first place, therefore, we must divide the ship equally in two lengthwise between the fore and after perpendiculars; and the exact number of cubic feet in the whole bottom beneath the load-water line being

known, we must find whether the number of cubic feet in each part so divided are the same; and if they are found to be equal, the body of the ship may then be said to be constructed in all respects suitable to her swimming on an even keel, let the shape of the body be whatever it will; and which will be found to be her natural position at the load-water line. But if either of the parts should contain a greater number of cubic feet than the other, that part which contains the greatest will swim the most out of the water, and consequently the other will swim deepest, supposing the ship in her natural position for that construction. In order, therefore, to render the ship suitable constructed to the load-water line in the draught, which is parallel to the keel, the number of cubic feet in the less part must be subtracted from the number contained in the greater part, and that part of the body is to be filled out till it has increased half the difference of their quantities, and the other part is to be drawn in as much: hence the two parts will be equal, that is, each will contain the same number of cubic feet, and the ship's body will be constructed in a manner suitable to her swimming on an even keel.

If it is proposed that the ship laid down on the draught shall not swim on an even keel, but draw more water abaft than afore, then the fore and after parts of the ship's body below the load-water line are to be compared; and if these parts are unequal, that part which is least is to be filled out by half the difference, and the other part drawn in as much as before.

It will be necessary, in the first place, to calculate the weight of a ship ready equipped for sea, from the knowledge of the weight of every separate thing in her and belonging to her, as the exact weight of all the timber, iron, lead, masts, sails, rigging, and in short all the materials, men, provisions, and every thing else on board of her, from which we shall be able afterwards to judge of the truth of the calculation, and whether the load-water line in the draught be placed agreeable thereto. This is indeed a very laborious task, upon account of the several pieces of timber, &c. being of so many different figures, and the specific gravity of some of the timber entering the construction not being precisely determined.

In order to ascertain the weight of the hull, the timber is the first thing which comes under consideration: the number of cubic feet of timber contained in the whole fabric must be found; which we shall be able to do by help of the draught and the principal dimensions and scantlings; observing to distinguish the different kinds of timber from each other, as they differ considerably in weight; then the number of cubic feet contained in the different sorts of timber being reduced into pounds, and added, will be the weight of the timber. In like manner proceed to find the weight of the iron, lead, paint, &c. and the true weight of the whole will be found.

In reducing quantity to weight, it may be observed that a cubic foot of oak is equal to 66 pounds, and the specific gravity of the other materials are as follow:

Water being	1000	Oak is	891.89
Lead is	11345	Dry elm	702.70
Iron	7543	Dry fir	648.64

Load-water Line and Ship's Capacity.

Load-water Line and ship's Capacity.

# S H I P - B U I L D I N G .

Load-water Line and Ship's Capacity.

*An Estimate of the Weight of the Eighty Gun Ship in Plates CCCCLX. and CCCCLXI. as fitted for Sea, with six Months Provisions.*

*Weight of the Men, &c.*

*Weight of the Hull.*

	N <sup>o</sup> of Ft.	N <sup>o</sup> of lbs.	Tons.	Lbs.
Estimate of Oak timber at 66 lb. to the cubic foot	48497	3200802	1428	2082
Fir timber at 48 lb. to the cubic foot				
Elm timber at 52 lb. to the cubic foot	520	27040	12	160
Carve work and lead work		4651	2	171
Iron work, rudder irons, chain-plates, nails, &c.		88254	39	894
Pitch, tar, oakum, and paint		17920	8	
Cook-room fitted with fire hearth		16123	7	443
<b>Sum</b>		<b>3568726</b>	<b>1593</b>	<b>406</b>

*Weight of the Furniture.*

	N <sup>o</sup> of lbs.	Tons.	Lbs.
Complete set of masts and yards, with the spare gear	161000	71	1960
Anchors with their stocks, and masts's stores	39996	17	1916
Rigging	69128	30	1928
Sails, complete set, and spare	32008	14	648
Cables and hawsers	73332	32	1652
Blocks, pumps, and boats	62056	27	1576
<b>Sum</b>	<b>437520</b>	<b>195</b>	<b>720</b>

*Weight of the Guns and Ammunition.*

Guns with their carriages	377034	168	714
Powder and shot, powder barrels, &c.	116320	51	2080
Implements for the powder	6500	2	2020
Ditto for guns, crow's, handspikes, &c.	21573	9	1413
<b>Sum</b>	<b>521427</b>	<b>232</b>	<b>1747</b>

*Weight of the Officers Stores, &c.*

Carpenter's stores	20187	9	27
Boatswain's stores	21112	9	952
Gunner's stores	8964	4	4
Caulker's stores	5200	2	720
Surgeon and chaplain's effects	11096	4	2136
<b>Sum</b>	<b>66559</b>	<b>29</b>	<b>1599</b>

*Weight of the Provisions.*

Provisions for six months for 700 men, with all their equipage	858970	383	1050
Water, casks, and captain's table	933900	416	2060
<b>Sum</b>	<b>1792870</b>	<b>800</b>	<b>870</b>

Seven hundred men with their effects, including the officers and their effects	316961	141	1121
Ballast	1478400	660	
<b>Sum</b>	<b>1795361</b>	<b>801</b>	<b>1121</b>

*RECAPITULATION.*

The hull	3568726	1593	406
The furniture	437520	195	720
Guns and ammunition	521427	232	1747
Officers stores	66559	29	1599
Provisions	1792870	800	870
Weight of the men and ballast	1795361	801	1121
<b>Sum</b>	<b>8182463</b>	<b>3652</b>	<b>1983</b>

Agreeable to the above estimate, we find that the eighty gun ship, with every thing on board and fit for sea, when brought down to the load water line, weighs 8,182,463 pounds, or nearly 3653 tons. It may now be known if the load water line in the draught be properly placed, by reducing the immerfed part of the body into cubic feet. For if the eighty gun ship, when brought down to the load water line, weighs 3653 tons, the quantity of water displaced must also be 3653 tons: now a cubic foot of salt water being supposed to weigh 74 pounds, if therefore 8182463 be divided by 74, the quotient is 110573, the number of cubical feet which the must displace agreeable to her weight.

It is now necessary to find the number of cubic feet contained in the ship's bottom below the load water line by calculation. If the bottom was a regular solid, this might be very easily done; but as it is otherwise, we must be satisfied with the following method by approximation, first given by M. Bouguer.

Take the lengths of every other of the lines that represent the frames in the horizontal plane upon the upper water line; then find the sum of these together, with half the foremost and aftermost frames. Now multiply that sum by the distance between the frames, and the product is the area of the water line contained between the foremost and aftermost frames: then find the area of that part abaft the after frame, which forms a trapezium, and also the post and rudder; find also the area of that part afore the foremast frame, and also of the stem and gripe; then these areas being added to that first found, and the sum doubled, will be the area of the surface of the whole water line. The reason of this rule will be obvious to those acquainted with the first principles of mathematics.

The areas of the other water line may be found in the same manner: then the sum of all these areas, except that of the uppermost and lowermost, of which only one half of each must be taken, being multiplied by the distance between the water lines (these lines in the plane of elevation being equidistant from each other), and the product will be the solid content of the space contained between the lower and load water lines.

Add.

d wa-  
Line  
Ship's  
acity.

Add the area of the lower water line to the area of the upper side of the keel; multiply half that sum by the distance between them, the product will be the solid content of that part between the lower water line and upper edge of the keel, supposing them parallel to each other. But if the lower water line is not parallel to the keel, the above half sum is to be multiplied by the distance between them at the middle of the ship.

The solid contents of the keel must be next found, by multiplying its length by its depth, and that product by the breadth. Then the sum of these solid contents will be the number of cubic feet contained in the immerged part of the ship's bottom, or that part below the load water line.

Determination of the number of Cubic Feet contained in the Bottom of the Eighty Gun Ship. See Plates CCCCLX. and CCCCLXI.

54  
died to  
eighty  
ship.

THE fore body is divided into five, and the after body into ten, equal parts in the horizontal plane; besides the parts contained between the foremost timber and the stem, and the aftermost timber and the post. The plane of elevation is also divided into five equal parts by water lines drawn parallel to the keel. These water lines are also described upon the horizontal plane.

It is to be observed that there must be five inches added to each line that represents a frame in the horizontal plane for the thickness of the plank, that being nearly a mean between the thickness of the plank next the water and that on the lower part of the bottom.

Upper Water Line abaft Dead Flat.

	Ft.	In.
frame dead flat is 24 f. 10 in. one-half of which is	12	5
frame (4)	24	10
frame 3	24	10
frame 7	24	10
frame 11	24	10
frame 15	24	9 $\frac{1}{2}$
frame 19	24	5
frame 23	23	10
frame 27	22	9
frame 31	20	11
frame 35 is 16 feet 3 inches, the half of which is	8	1 $\frac{1}{2}$

Sum - - - - - 236 7  
Distance between the frames - - - - - 10 11

Product - - - - - 2582 8 $\frac{1}{2}$   
Area of that part abaft frame 35 - - - - - 78 0  
rudder and post - - - - - 5 6

Sum - - - - - 2666 2 $\frac{1}{2}$   
2

Area of the load water line from dead flat aft 5332 5

Second Water Line abaft Dead Flat.

	Ft.	In.
frame dead flat is 23 feet 10 $\frac{1}{2}$ inches, the half of which is	11	11 $\frac{1}{2}$
frame (4)	23	10 $\frac{1}{2}$
frame 3	23	10 $\frac{1}{2}$
frame 7	23	10 $\frac{1}{2}$
frame 11	23	10 $\frac{1}{2}$
frame 15	23	8 $\frac{1}{2}$
frame 19	23	3 $\frac{1}{2}$
frame 23	22	5
frame 27	20	10
frame 31	17	8
frame 35 is 8 feet 6 inches, the half of which is	4	3

Sum - - - - - 219 7 $\frac{1}{2}$   
Distance between the frames - - - - - 10 11

Product - - - - - 2397 4  
Area of that part abaft frame 35 - - - - - 31 7  
rudder and post - - - - - 5 5

Sum - - - - - 2434 4  
2

Area of the 2d water line from dead flat aft 4868 8

Third Water Line abaft Dead Flat.

	Ft.	In.
frame dead flat is 22 feet 1 $\frac{1}{2}$ inches—half	11	0 $\frac{1}{2}$
frame (4)	22	1 $\frac{1}{2}$
frame 3	22	1 $\frac{1}{2}$
frame 7	22	1 $\frac{1}{2}$
frame 11	22	1
frame 15	21	5
frame 19	20	8 $\frac{1}{2}$
frame 23	19	3 $\frac{1}{2}$
frame 27	16	5
frame 31	11	2 $\frac{1}{2}$
frame 35 is 4 feet 3 inches—half	2	1 $\frac{1}{2}$

Area of that part abaft frame 35 - - - - - 14 5 $\frac{1}{2}$   
rudder and post - - - - - 5 6

Sum - - - - - 2101 7 $\frac{1}{2}$   
2

Area of the 3d water line from dead flat aft 4203 3

Fourth Water Line abaft Dead Flat.

	Ft.	In.
frame dead flat is 20 feet 1 inch—half	10	0 $\frac{1}{2}$
frame (4)	20	1
frame 3	20	1
frame 7	19	11
frame 11	19	7 $\frac{1}{2}$
frame 15	19	0

Carry over - - - - - 108 9

Brought:

Load water Line and Ship's Capacity.

		Ft.	In.
Breadth at	Brought over	108	9
	frame 19	17	7 $\frac{1}{2}$
	frame 23	14	10
	frame 27	10	11
	frame 31	5	11
	frame 35 is 1 foot 11 $\frac{1}{2}$ inches—half	0	11 $\frac{1}{2}$
		159	0
		10	11

Area of that part abaft frame 35	1735	9
rudder and post	9	9
	5	0
	1750	6
		2

Area of the 4th water line from dead flat aft 3501 0

*Fifth or Lower Water Line abaft Dead Flat.*

		Ft.	In.
The breadth at	frame dead flat is 17 feet 2 inches—half	8	7
	frame (4)	17	2
	frame 3	17	2
	frame 7	17	1
	frame 11	16	4
	frame 15	15	4
	frame 19	13	1
	frame 23	8	9
	frame 27	4	10
	frame 31	2	11
frame 35 is 1 foot 2 $\frac{1}{2}$ inches—half	0	7 $\frac{1}{2}$	
		121	10 $\frac{1}{2}$
		10	11

Area of that part abaft frame 35	1330	2
rudder and post	4	8 $\frac{1}{2}$
	4	6 $\frac{1}{2}$
	1339	5
		2

Area of the 5th or lower water line from dead flat aft	2678	10
Half the area of the load water line	2666	2 $\frac{1}{2}$
Area of the second water line	4868	8
Area of the third water line	4203	3
Area of the fourth water line	3501	0
Half the area of the lower water line	1339	5
Sum	16578	6 $\frac{1}{2}$
Distance between the water lines	4	1

Content in cubic feet between the lower and load water lines	67695	8 $\frac{1}{2}$
Area of the lower water line	2678	10
Area of the upper side of the keel	206	4
Sum	2885	2
Half	1442	7
Distance between the lower water line and the keel	4	1

Cub. feet contained between lower water line and the keel	5890	6 $\frac{1}{2}$
Content of the keel, lower part of rudder, and false keel	464	3
Cubic feet abaft the midship frame under water when loaded	74050	6

*Upper or Load water Line afore Dead Flat.*

		Ft.	In.
The breadth at	frame dead flat is 24 feet 10 inches—half	12	5
	frame E	24	10
	frame I	24	8 $\frac{1}{2}$
	frame N	24	0
	frame Q	21	10 $\frac{1}{2}$
	frame W is 15 feet 1 inch—half	7	6 $\frac{1}{2}$

Sum	115	4 $\frac{1}{2}$
Distance between the frames	10	11
Product	1259	6
Area of the part afore frame W item and knee	80	3
	4	0

Sum	1343	9
Multiply by		2

Area of the load water line from dead flat forward	2687	6
--	------	---

*Second Water Line afore Dead Flat.*

		Ft.	In.
The breadth at	frame dead flat is 23 feet 10 $\frac{1}{2}$ inches—half	11	11 $\frac{1}{2}$
	frame E	23	10
	frame I	23	5
	frame N	22	5
	frame Q	19	11
	frame W is 11 feet 11 inches—half	5	11 $\frac{1}{2}$

Sum	107	5 $\frac{1}{2}$
Distance between the frames	10	11
Product	1173	9
Area of the part afore frame W, with the stem and knee	43	9

Sum	1217	6
		2

Area of the second water line from dead flat forward	2435	0
--	------	---

*Third Water Line afore Dead Flat.*

		Ft.	In.
The breadth at	frame dead flat is 22 feet 1 $\frac{1}{2}$ inch—half	11	0 $\frac{1}{2}$
	frame E	22	1
	frame I	21	8
	frame N	20	1
	frame Q	16	1 $\frac{1}{2}$
	frame W is 7 feet—half	3	6

Sum	94	6 $\frac{1}{2}$
Distance between the frames	10	11
Product	1031	10
Area of the part afore W, with the stem and gripe	25	10

Sum	1057	8
		2

Area of the third water line from dead flat forward	2115	4
---	------	---

Fourth Water Line afore Dead Flat.

The breadth at		Ft.	In.
}	frame dead flat is 20 feet 1 inch—half	10	0½
	frame E	20	0½
	frame I	19	3
	frame N	16	5
	frame Q	11	2
frame W is 2 feet 9 inches—half		1	4½
Sum		78	3½
Distance between the frames		10	11
Product		854	8
Area of part before W, with the stem and gripe		8	10¼
Sum		863	6¼
Area of fourth water line from dead flat forward		1727	1½

Fifth Water Line afore Dead Flat.

Breadth at		Ft.	In.
}	frame dead flat is 17 feet 2 inches—half	8	7
	frame E	16	9
	frame I	14	10
	frame N	10	9½
	frame Q is 5 feet—half	2	6
Sum		53	5½
Distance between the frames		10	11
Product		583	7
Area of part afore Q stem and knee		26	2½
		5	11½
Sum		615	9
Area of the fifth or lower water line from dead flat forward		1231	6
Area of the upper side of the keel		87	4
Sum		1318	10
Half Distance between the lower water line and keel		659	5
		4	1

Content of the part contained between the lower water line and the keel in cub. feet		2692	7½
Half the area of the load water line		1343	9
Area of the second water line		2435	0
third water line		2115	4
fourth water line		1727	1½
Half the area of the fifth or lower water line		615	9
Sum		8236	11¼
Distance between the water lines		4	1

Cubic feet contained between the lower and load water lines		33634	2½	Tonnage of a Ship.
Cubic feet contained between lower water line and keel		2692	7½	
Content of the keel and false keel		196	6	
Content afore midship frame under water when loaded		36523	4	
Content abaft midship frame		74050	6	
Content under water		110573	10	
Weight of a cubic foot of salt water		74	lbs.	
Weight of the whole ship with every thing on board		8182463.8	lbs.	

As the weight of the ship, with every thing on board, found by this calculation, is equal to that found by estimate; it hence appears that the water line is properly placed in the draught. It now only remains to find whether the body is constructed suitably thereto, that is, whether the ship will be in her natural position when brought down to that line. For this purpose a perpendicular must be erected 27 feet ¼ inch. abaft dead flat, which will be the middle between the two perpendiculars and the place where the centre of gravity should fall, that the ship may swim on an even keel. The solidity of that part of the bottom contained between the said perpendicular and dead flat is then to be calculated, which will be found to be 25846 feet 7 inches.

Solidity of the bottom afore dead flat		36523 f.	4 in.
between the middle and dead flat		25846	7
Solid content of the fore part of the bottom		62369	11
Solidity of the bottom abaft dead flat		74050	6
between the middle and dead flat		25846	7
Solid content of the aft part of the bottom		48203	11
fore part of the bottom		62369	11
Difference		14166	
Half		7083	

Hence the after part of the ship's bottom is too lean by 7083 cubic feet, and the fore part as much too full. The after part must therefore be filled out until it has received an addition of 7083 feet, and the fore part must be drawn in till it has lost the same quantity, and the bottom will then be constructed suitable to the ship's swimming on an even keel.

CHAP. IX. Of the Tonnage of a Ship.

THIS is a question of equal importance and difficulty. By the tonnage of a ship is meant the weight of every thing that can with safety and expediency be taken on board that ship for the purpose of conveyance; it is also called the *ship's burthen*; and it is totally different from the weight of the whole as she floats in the water. It is perhaps best expressed by calling it the *weight of the cargo*. It is of importance, because it is by this that the merchant or freighter judges of the fitness

Tonnage of a Ship.

of the ship for his purpose. By this government judge of the ships requisite for transport service, and by this are all revenue charges on the ship computed. It is no less difficult to answer this question by any general rule which shall be very exact, because it depends not only on the cubical dimensions of the ship's bottom, but also on the scantling of her whole frame, and in short on the weight of every thing which properly makes part of a ship ready to receive on board her cargo. The weight of timber is variable; the scantling of the frame is no less so. We must therefore be contented with an average value which is not very remote from the truth; and this average is to be obtained, not by any mathematical discussion, but by observation of the burthen or cargo actually received, in a great variety of cases. But some sort of rule of calculation must be made out. This is and must be done by persons not mathematicians. We may therefore expect to find it incapable of being reduced to any principle, and that every builder will have a different rule. Accordingly the rules given for this purpose are in general very whimsical, measures being used and combined in a way that seems quite unconnected with stercometry or the measurement of solids. The rules for calculation are even affected by the interests of the two parties oppositely concerned in the result. The calculation for the tonnage by which the customs are to be exacted by government are quite different from the rule by which the tonnage of a transport hired by government is computed; and the same ship hired as a transport will be computed near one half bigger than when paying importation duties.

Yet the whole of this might be made a very simple business and very exact. When the ship is launched, let her light-water line be marked, and this with the cubical contents of the immersed part be noted down, and be engrossed in the deed by which the property of the ship is conveyed from hand to hand. The weight of her masts, sails, rigging, and sea-stores, is most easily obtained; and every builder can compute the cubical contents of the body when immersed to the load-water line. The difference of these is unquestionably the burthen of the ship.

It is evident from what has been already said in the last chapter, that if the number of cubic feet of water which the ship displaces when light, or, which is the same, the number of cubic feet below the light water line, found by the preceding method of calculation, be subtracted from the number of cubic feet contained in the bottom below the load water line, and the remainder reduced to tons by multiplying by 74, the number of pounds in a cubic foot of sea water, and divided by 2240, the number of pounds in a ton, the quotient will be the tonnage.

But as this method is very troublesome, the following rule for this purpose is that which is used in the king's and merchant's service.

Let fall a perpendicular from the fore side of the stem at the height of the hawse holes (H), and another perpendicular from the back of the main post at the height

of the wing transom. From the length between these two perpendiculars deduct three-fifths of the extreme breadth (1), and also as many times  $2\frac{1}{2}$  inches as there are feet in the height of the wing transom above the upper edge of the keel; the remainder is the length of the keel for tonnage. Now multiply this length by the extreme breadth, and the product by half the extreme breadth, and this last product divided by 94 is the tonnage required.

Or, multiply the length of the keel for tonnage by the square of the extreme breadth, and the product divided by 188 will give the tonnage.

Calculation of the Tonnage of an Eighty Gun Ship.

I. According to the true method.

The weight of the ship at her launching draught of water	tons	lbs	Calculation of the tonnage of eighty gun ship.
The weight of the furniture	1593	406	
	195	720	
	<hr/>		
The weight of the ship at her light water mark	1788	1126	
The weight of the ship at the load water mark	3652	1983	
	<hr/>		
Real burthen	1864	857	

II. By the common rule.

Length from the fore side of the stem at the height of the hawse holes, to the aft side of the main post, at the height of the wing transom	Ft	inch.	
Three-fifths of the extreme breadth is	29 f.	$9\frac{1}{2}$ in.	
Height of the wing transom is 28 f. 4 in. which multiplied by $2\frac{1}{2}$ inches is	6	$8\frac{1}{2}$	
Sum	36	6	36 6
Length of the keel for tonnage	149	4	
Extreme breadth	49	8	
Product	7416	$10\frac{1}{2}$	
Half the extreme breadth	24	10	
	<hr/>		
	94)	184185	$8\frac{1}{2}$
Burthen according to the common rule	1959	929	
Real burthen	1864	857	
	<hr/>		
Difference	95	72	

Hence an eighty gun ship will not carry the tonnage she is rated at by about 95 tons. As the body of this ship is fuller than in ships of war in general, there is therefore a nearer agreement between the tonnages found by the two different methods. It may be observed that ships of war carry less tonnage than they are rated at by the common rule, and that most merchant ships carry more than they are rated at by the common rule. The tonnage of ships of war is greater, and the tonnage of merchant ships is less, than the true.

56 Common Rule.

(H) In the merchant service this perpendicular is let fall from the fore side of the stem at the height of the wing transom, by reason of the hawse-holes being generally so very high in merchant ships, and their stems also having a great rake forward.

(1) The breadth understood in this place is the breadth from outside to outside of the plank.

age of a great deal more. In confirmation of this, it is thought proper to subjoin the dimensions of several ships, with the tonnage calculated therefrom.

1. *Audacious of seventy four guns.*

Length on the gun deck	-	168 f. 0 in.
Length of the keel for tonnage	-	138 0
Extreme breadth	-	46 9
Depth of the hold	-	19 9
Launching draught of water	{	12 0
	{	17 4
Load draught of water	{	20 6
	{	21 6
The weight of the ship at her launching draught of water	-	1509 t. 678lbs.
The weight of the furniture	-	120 1500

Weight of the ship at her light water mark	-	1629 2178
Weight of the ship at her load water mark	-	2776 498

Real burthen	-	1146 560
By the common rule.		
Length of the keel for tonnage	-	138 f. 0 in.
Extreme breadth	-	46 9
Product	-	6451 6
Half the extreme breadth	-	23 4½

94)150803

Tonnage according to the common rule	-	1604 643
Real burthen	-	1146 560
Difference	-	458 83

2. *An East Indiaman.*

Length between the perpendiculars forward and aft	-	132 f. 8 in.
Length of the keel for tonnage	-	105 0
Extreme breadth	-	38 0
Depth in hold	-	16 0
Launching draught of water	{	7 10
	{	11 10
Load draught of water	{	19 8
	{	20 8

The weight of the ship at her launching draught of water	-	602 t. 2116lbs.
The weight of the furniture	-	50 124
Weight of the ship at her light water mark	-	653
Weight of the ship at her load water mark	-	1637 1670

Real burthen	-	984 1670
By the common rule.		
Keel for tonnage	-	105 f.
Extreme breadth	-	38

Product	-	3999
Half extreme breadth	-	19

94)75810

Tonnage	-	806 1096
---------	---	----------

Tonnage	-	806 1096	Tonnage of a Ship.
Real tonnage	-	984 1670	
Difference	-	178 574	

3. *A Cutter.*

Length of the keel for tonnage	-	58 f. 0 in.
Extreme breadth	-	29 0
Launching draught of water	{	5 10
	{	9 8
Load draught of water	{	9 0
	{	12 0

The weight of the cutter at her launching	-	147 t. 640lbs.
Weight of the furniture	-	9 199

Weight of the cutter at her light water mark	-	156 839
Weight of the cutter at her load water mark	-	266 1970

Real burthen	-	110 1131
--------------	---	----------

By the common rule.

Keel for tonnage	-	58 f.
Extreme breadth	-	29
Product	-	1682
Half extreme breadth	-	14½

94)24389

Tonnage by the common rule	-	259 1024
Real tonnage	-	110 1131
Difference	-	148 2133

The impropriety of the common rule is hence manifest, as there can be no dependence on it for ascertaining the tonnage of vessels.

We shall now subjoin the following experimental method of finding the tonnage of a ship.

Construct a model agreeable to the draught of the proposed ship, to a scale of about one-fourth of an inch to a foot, and let the light and load water lines be marked on it. Then put the model in water, and load it until the surface of the water is exactly at the light water line; and let it be suspended until the water drains off, and then weighed. Now since the weights of similar bodies are in the triplicate ratio of their homologous dimensions, the weight of the ship when light is, therefore, equal to the product of the cube of the number of times the ship exceeds the model by the weight of the model, which is to be reduced to tons. Hence, if the model is constructed to a quarter of an inch scale, and its weight expressed in ounces; then to the constant logarithm 0.4893556, add the logarithm of the weight of the model in ounces, and the sum will be the logarithm of the weight of the ship in tons.

Again, the model is to be loaded until the surface of the water coincides with the load water line. Now the model being weighed, the weight of the ship is to be found by the preceding rule: then the difference between the weights of the ship when light and loaded is the tonnage required.

Tonnage of a Ship. It will also be worth while to add the following exact rule of Mr Parkins, who was many years foreman of the shipwrights in Chatham dockyard.

1. For Men of War.

Take the length of the gun-deck from the rabbet of the stem to the rabbet of the stern-post.  $\frac{2}{3}$  of this is to be assumed as the length for tonnage, = L.

Take the extreme breadth from outside to outside of the plank; add this to the length, and take  $\frac{1}{3}$  of the sum; call this the depth for tonnage, = D.

Set up this height from the limber strake, and at that height take a breadth also from outside to outside of plank in the timber when the extreme breadth is found, and another breadth in the middle between that and the limber strake; add together the extreme breadth and these two breadths, and take  $\frac{1}{3}$  of the sum for the breadth for tonnage, = B.

Multiply L, D, and B together, and divide by 49. The quotient is the burthen in tons.

The following proof may be given of the accuracy of this rule. Column 1. is the tonnage or burthen by the king's measurement; col. 2. is the tonnage by this rule; and, col. 3. is the weight actually received on board these ships at Blackittakes:

Victory	100 guns.	2162	1839	1840
London	90	1845	1575	1677
Arrogant	74	1614	1308	1314
Diadem	64	1369	1141	965
Adamant	50	1044	870	886
Dolphin	44	879	737	758
Amphion	32	667	554	549
Daphne	20	429	329	374

2. For Ships of Burthen.

Take the length of the lower deck from the rabbet of the stem to the rabbet of the stern-post; then  $\frac{1}{4}$  of this is the length for tonnage, = L.

Add the length of the lower deck to the extreme breadth from outside to outside of plank; and take  $\frac{1}{3}$  of the sum for the depth for tonnage, = D.

Set up that depth from the limber strake, and at this height take a breadth from outside to outside. Take another at  $\frac{2}{3}$  of this height, and another at  $\frac{1}{3}$  of the height. Add the extreme breadth and these three breadths, and take the 4th of the sum for the breadth for tonnage, = B.

Multiply L, D, and B, and divide by  $36\frac{1}{2}$ . The quotient is the burthen in tons.

This rule rests on the authority of many such trials, as the following:

	King's Measrm.	Rule.	Actually recd. on b <sup>d</sup> .
Northington Indiaman	676	1053	1064
Granby Indiaman	786	1179	1179
Union coallier	103	266	289
Another coallier	182	254	277

CHAP. X. Of the Scale of Solidity.

By this scale the quantity of water displaced by the bottom of the ship, for which it is constructed, answering to a given draught of water is easily obtained; and

also the additional weight necessary to bring her down to the load water line.

In order to construct this scale for a given ship, it is necessary to calculate the quantity of water displaced by the keel, and by that part of the bottom below each water line in the draught. Since the areas of the several water lines are already computed for the eighty gun ship laid down in Plates CCCCLX. and CCCCLXI. the contents of these parts may hence be easily found for that ship, and are as follow.

Draught of water.		Water displaced in	
		Cubic feet.	tons. lbs.
Keel and false keel	2 f. 3 in.	660.9	21 1855
Dift. bet. keel and 5th w. line	4 1	8583.1 $\frac{1}{2}$	283 1233
Sum	6 4	9243.10 $\frac{1}{2}$	305 848
Dift. 5th and 4th w. line	4 1	18657.8 $\frac{1}{4}$	616 823
Sum	10 5	27901.7 $\frac{3}{4}$	921 1670
Dift. 4th and 3d w. line	4 1	23574.6 $\frac{1}{8}$	778 1795
Sum	14 6	51476.2 $\frac{1}{2}$	1700 1231
Dift. 3d and 2d w. line	4 1	27812.1 $\frac{1}{2}$	918 1775
Sum	18 7	79288.3 $\frac{1}{4}$	2619 766
Dift. 2d and 1st w. line	4 1	31285.7 $\frac{1}{4}$	1033 1218
Sum	22 8	110573.1 $\frac{1}{2}$	3652 1984

Construct any convenient scale of equal parts to represent tons, as scale n<sup>o</sup> 1. and another to represent feet, as n<sup>o</sup> 2.

Draw the line AB (fig. 36) limited at A, but produced indefinitely towards B. Make AC equal to the depth of the keel, 2 feet 3 inches from scale n<sup>o</sup> 2, and through C draw a line parallel to AB, which will represent the upper edge of the keel; upon which set off Cc equal to 21 tons 1855 lbs, taken from scale n<sup>o</sup> 1. Again, make AD equal to the distance between the lower edge of the keel and the fifth water line, namely, 6 feet 4 inches, and a line drawn through D parallel to AB will be the representation of the lower water line; and make Db equal to 305 tons 848 lbs, the corresponding tonnage. In like manner draw the other water lines, and lay off the corresponding tonnages accordingly: then through the points A, c, b, e, f, g, h, draw the curve Acbefgh. Through b draw bb perpendicular to AB, and it will be the greatest limit of the quantity of water expressed in tons displaced by the bottom of the ship, or that when she is brought down to the load water line. And since the ship displaces 1788 tons at her light water mark, take therefore that quantity from the scale n<sup>o</sup> 1, which being laid upon AB from A to K, and KL drawn perpendicular to AB, will be the representation of the light water line for tonnage. Hence the scale will be completed.



Let it now be required to find the number of cubic feet displaced when the draught of water is 17 feet, and the number of additional tons necessary to bring her down to the load water mark.

Take the given draught of water 17 feet from the scale n° 2, which laid from it will reach to I; through which draw the line IMN parallel to AB, and intersecting the curve in AC; then the distance IM applied to the scale n° 1. will measure about 2248 tons, the displacement answerable to that draught of water; and MN applied to the same scale will measure about 1405 tons, the additional weight necessary to bring her down to the load water mark. Also the nearest distance between M and the line KI. will measure about 460 tons, the weight already on board.

It will conduce very much to facilitate this operation to divide KB into a scale of tons taken from the scale n° 1, beginning at B, and also b L, beginning at b. Then when the draught of water is taken from the scale n° 2, and laid from it to I, as in the former example, and IMN drawn parallel to AB, and intersecting the curve in M. Now through M draw a line perpendicular to AB, and it will meet KB in a point representing the number of tons aboard, and also b L in a point denoting the additional weight necessary to load her.

Again, if the weight on board be given, the corresponding draught of water is obtained as follows.

Find the given number of tons in the scale KB, through which draw a line perpendicular to AB; then through the point of intersection of this line with the curve draw another line parallel to AB. Now the distance between A and the point where the parallel intersected AH being applied to the scale n° 2, will give the draught of water required.

Any other case to which this scale may be applied will be obvious.

BOOK II. *Containing the Properties of Ships, &c.*

CHAP. I. *Of the Equilibrium of Ships.*

SINCE the pressure of fluids is equal in every direction, the bottom of a ship is therefore acted upon by the fluid in which it is immersed; which pressure, for any given portion of surface, is equal to the product of that portion by the depth and density of the fluid: or it is equal to the weight of a column of the fluid whose base is the given surface, and the altitude equal to the distance between the surface of the fluid and the centre of gravity of the surface pressed. Hence a floating body is in equilibrio between two forces, namely, its gravity and the vertical pressure of the fluid; the horizontal pressure being destroyed.

Let ABC (fig. 49.) be any body immersed in a fluid whose line of floatation is GH: hence the pressure of the fluid is exerted on every portion of the surface of the immersed part AFCH. Let EF, CD be any two small portions contained between the lines ED, FC, parallel to each other, and to the line of floatation GH: then the pressure exerted upon EF is expressed by EF x IK, IK being the depth of EF

or CD; the density of the fluid being supposed equal to t. In like manner the pressure upon CD is equal to CD x IK. Now since the pressure is in a direction perpendicular to the surface, draw therefore the line EL perpendicular to EF, and DM perpendicular to DC, and make each equal to the depth IK, below the surface. Now the effort or pressure of the fluid upon EF will be expressed by EF x EL, and that upon CD by CD x DM. Complete the parallelograms ON, QS, and the pressure in the direction EL is resolved into EN, EO, the first in a horizontal, and the second in a vertical direction. In like manner, the pressure in the direction DM is resolved into the pressures DS, DQ. Hence the joint effect of the pressures in the horizontal and vertical directions, namely, EF x EN, and EF x EO, will be equal to EF x EL: For the same reason, CD x DP + CD x DQ = CD x DM. But the parts of the pressures in a horizontal direction EF x EN, and CD x DP, are equal. For, because of the similar triangles ENL, ERF, and DPM, DSC,

we have  $\frac{EL}{EN} = \frac{EF}{ER}$  and  $\frac{DM}{DP} = \frac{DC}{DS}$ : Hence  $DM \times CS = DP \times DC$ , and  $EL \times FR = EN \times EF$ . Now since  $EL = DM$ , and  $FR = CS$ , therefore  $EL \times FR = DM \times CS = DP \times DC = EN \times EF$ . Hence, since  $EF \times EN = DP \times CD$ , the effects of the pressures in a horizontal direction are therefore equal and contrary, and consequently destroy each other.

The pressure in a vertical direction is represented by  $EO \times EF$ ,  $DQ \times DC$ , &c. which, because of the similar triangles EOL, ERF, and DLM, DSC, become  $EL \times ER$ ,  $DM \times DS$ , &c. or  $IK \times ER$ ,  $IK \times DS$ , &c. By applying the same reasoning to every other portion of the surface of the immersed part of the body, it is hence evident that the sum of the vertical pressures is equal to the sum of the corresponding displaced columns of the fluid.

Hence a floating body is pressed upwards by a force equal to the weight of the quantity of water displaced; and since there is an equilibrium between this force and the weight of the body, therefore the weight of a floating body is equal to the weight of the displaced fluid. Hence also the centre of gravity of the body and the centre of gravity of the displaced fluid are in the same vertical, otherwise the body would not be at rest.

CHAP. II. *Upon the Efforts of the Water to bend a Vessel.*

WHEN it is said that the pressure of the water upon the immersed part of a vessel counterbalances its weight, it is supposed that the different parts of the vessel are so closely connected together, that the forces which act upon its surface are not capable of producing any change. For we may easily conceive, if the connection of the parts were not sufficiently strong, the vessel would run the risk either of being broken in pieces, or of suffering some alteration in its figure.

The vessel is in a situation similar to that of a rod AB (fig. 50.), which being acted upon by the forces A a, C c, D d, B b, may be maintained in equilibrio,

Equilibrium of Ships.

62  
The weight of a ship equal to that of the quantity of water displaced.  
63  
And the centre of gravity of both are in the same vertical.

Theorie complete, &c. par Euler, translated by Watson.

(κ) Upon this principle the weight and tonnage of the 80 gun ship laid down was calculated.

Efforts of  
th. Water  
to bend a  
Vessel

provided it has a sufficient degree of stiffness: but as soon as it begins to give way, it is evident it must bend in a convex manner, since its middle would obey the forces  $Cc$  and  $Dd$ , while its extremities would be actually drawn downwards by the forces  $Aa$  and  $Bb$ .

The vessel is generally found in such a situation; and since similar efforts continually act whilst the vessel is immersed in the water, it happens but too often that the keel experiences the bad effect of a strain. It is therefore very important to inquire into the true cause of this accident.

For this purpose, let us conceive the vessel to be divided into two parts by a transverse section through the vertical axis of the vessel, in which both the centre of gravity,  $G$  (fig. 51.) of the whole vessel and that of the immersed part are situated: so that one of them will represent the head part, and the other that of the stern, each of which will be considered separately. Let  $g$  be the centre of gravity of the entire weight of the first, and  $o$  that of the immersed part corresponding. In like manner, let  $\gamma$  be the centre of gravity of the whole after part, and  $w$  that of its immediate portion.

Now it is plain, that the head will be acted upon by the two forces  $gm$  and  $on$ , of which the first will press it down, and the latter push it up. In the same manner, the stern will be pressed down by the force  $\gamma\mu$ , and pushed up by the force  $\omega\nu$ . But these four forces will maintain themselves in equilibrium, as well as the total forces reunited in the points  $G$  and  $O$ , which are equivalent to them; but whilst neither the forces before nor those behind fall in the same direction, the vessel will evidently sustain efforts tending to bend the keel upwards, if the two points  $o\omega$  are nearer the middle than the two other forces  $gm$  and  $\gamma\mu$ . A contrary effect would happen if the points  $o$  and  $\omega$  were more distant from the middle than the points  $g$  and  $\gamma$ .

But the first of these two causes usually takes place almost in all vessels, since they have a greater breadth towards the middle, and become more and more narrow towards the extremities; whilst the weight of the vessel is in proportion much more considerable towards the extremities than at the middle. From whence we see, that the greater this difference becomes, the more also will the vessel be subject to the forces which tend to bend its keel upwards. It is therefore from thence that we must judge how much strength it is necessary to give to this part of the vessel, in order to avoid such a consequence.

If other circumstances would permit either to load the vessel more in the middle, or to give to the part immersed a greater capacity towards the head and stern, such an effect would no longer be apprehended. But the destination of most vessels is entirely opposite to such an arrangement: by which means we are obliged to strengthen the keel as much as may be necessary, in order to avoid such a disaster.

We shall conclude this chapter with the following practical observations on the hogging and sagging of ships by Mr Hutchinson of Liverpool:

“When ships with long floors happen to be laid dry upon mud or sand, which makes a solid resistance against the long straight floors amidships, in comparison with the two sharp ends, the entrance and run meet with little support, but are pressed down lower than the

flat of the floor, and in proportion hogs the ship amidships; which is too well known from experience to occasion many total losses, or do so much damage by hogging them, as to require a vast deal of trouble and expence to save and repair them, so as to get the hog taken out and brought to their proper sheer again: and to do this the more effectually, the owners have often been induced to go to the expence of lengthening them; and by the common method, in proportion as they add to the burden of these ships, by lengthening their too long straight floors in their main bodies amidships, so much do they add to their general weakness to bear hardships either on the ground or afloat: for the scantling of their old timber and plank is not proportionable to bear the additional burden that is added to them.

“But defects of this kind are best proved from real and incontestable facts in common practice. At the very time I was writing upon this subject, I was called upon for my advice by the commander of one of those strong, long, straight floored ships, who was in much trouble and distraction of mind for the damage his ship had taken by the pilot laying her on a hard, gentle sloping sand, at the outside of our docks at Liverpool, where it is common for ships that will take the ground to lie for a tide, when it proves too late to get into our wet docks. After recommending a proper ship carpenter, I went to the ship, which lay with only a small keel, yet was greatly hogged, and the butts of her upper works strained greatly on the lee-side; and the teams of her bottom, at the lower futtock heads, vastly opened on the weather side: all which strained parts were agreed upon not to be caulked, but filled with tallow, putty, or clay, &c. with raw bullocks hides, or canvas nailed with battons on her bottom, which prevented her sinking with the flow of the tide, without hindering the pressure of water from righting and closing the seams again as she floated, so as to enable them to keep her free with pumping. This vessel, like many other instances of ships of this construction that I have known, was saved and repaired at a very great expence in our dry repairing docks. And that their bottoms not only hog upwards, but sag (or curve) downwards, to dangerous and fatal degrees, according to the strain or pressure that prevails upon them, will be proved from the following facts:

“It has been long known from experience, that when ships load deep with very heavy cargoes or materials that are stowed too low, it makes them to very labour some at sea, when the waves run high, as to roll away their masts; and after that misfortune causes them to labour and roll the more, so as to endanger their working and straining themselves to pieces: to prevent which, it has been long a common practice to leave a great part of their fore and after holds empty, and to stow them as high as possible in the main body at midships, which causes the bottoms of these long straight floored ships to sag downwards, in proportion as the weight of the cargo stowed there exceeds the pressure of the water upwards, so much so as to make them dangerously and totally leaky.

“I have known many instances of those strong ships of 500 or 600 tons burdens built with long straight floors, on the east coast of England, for the coal and timber trade, come loaded with timber from the Baltic

Plate  
CCCLXV.

64  
The cause  
of a ship's  
hogging,

65  
And sag-  
ging.

Practical  
Sagging of  
P. 13.

ff  
ris of  
e Water  
bend a  
effl.

to Liverpool, where they commonly load deep with rock salt, which is too heavy to fill their holds, so that for the above reasons they stowed it high amidships, and left large empty spaces in their fore and after holds, which caused their long straight floors to sag downwards, so much as to make their hold staunchions amidships, at the main hatchway, settle from the beams three or four inches, and their mainmasts settle so much as to oblige them to set up the main rigging when rolling hard at sea, to prevent the masts being rolled away; and they were rendered so leaky as to be obliged to return to Liverpool to get their leaks stopped at great expence. And in order to save the time and expence in discharging them, endeavours were made to find out and stop their leaks, by laying them ashore dry on a level sand; but without effect: for though their bottoms were thus sagged down by their cargoes when afloat, yet when they came a-dry upon the sand, some of their bottoms hogged upwards so much as to raise their mainmasts and pumps so high as to tear their coats from their decks; so that they have been obliged to discharge their cargoes, and give them a repair in the repairing dock, and in some to double their bottoms, to enable them to carry their cargoes with safety, stowed in this manner. From this cause I have known one of these strong ships to founder.

“ Among the many instances of ships that have been distressed by carrying cargoes of lead, one sailed from hence bound to Marseilles, which was soon obliged to put back again in great distress, having had four feet water in the hold, by the commander’s account, owing to the ship’s bottom sagging down to such a degree as made the hold staunchions settle six inches from the lower deck beams amidships; yet it is common with these long straight floored ships, when these heavy cargoes are discharged that makes their bottom sag down, then to hog upwards: so that when they are put into a dry repairing dock, with empty holds, upon straight blocks, they commonly either split the blocks close fore and aft, or damage their keels there, by the whole weight of the ship lying upon them, when none lies upon the blocks under the flat of their floors amidships, that being hogged upwards; which was the case of this ship’s bottom; though sagged downwards six inches by her cargo, it was now found hogged so much that her keel did not touch the blocks amidships, which occasioned so much damage to the after part of the keel, as to oblige them to repair it; which is commonly the case with these ships, and therefore deserving particular notice.”

In order to prevent these defects in ships, “ they should all be built with their floors or bottoms lengthwise, to form an arch with the projecting part downwards, which will naturally not only contribute greatly to prevent their taking damage by their bottoms hogging and straining upwards, either aground or afloat, as has been mentioned, but will, among other advantages, be a help to their sailing, steering, staying, and waring.”

CHAP. III. *Of the Stability of Ships.*

WHEN a vessel receives an impulse or pressure in a horizontal direction, so as to be inclined in a small degree, the vessel will then either regain its former position as the pressure is taken off, and is in this case

said to be possessed of stability; or it will continue in its inclined state; or, lastly, the inclination will increase until the vessel is overturned. With regard to the first case, it is evident that a sufficient degree of stability is necessary in order to sustain the efforts of the wind; but neither of the other two cases must be permitted to have place in vessels.

Stability of  
ships.

Let CED (fig. 52.) be the section of a ship passing through its centre of gravity, and perpendicular to the sheer and floor plans; which let be in equilibrium in a fluid; AB being the water line, G the centre of gravity of the whole body, and  $g$  that of the immersed part AEB. Let the body receive now a very small inclination, so that  $aEb$  becomes the immersed part, and  $\gamma$  its centre of gravity. From  $\gamma$  draw  $\gamma M$  perpendicular to  $ab$ , and meeting  $gG$ , produced, if necessary, in M. If, then, the point M thus found is higher than G the centre of gravity of the whole body, the body will, in this case, return to its former position, the pressure being taken off. If the point M coincides with G, the vessel will remain in its inclined state; but if M be below G, the inclination of the vessel will continually increase until it is entirely over-  
set.

The point of intersection M is called the *metacenter*, and is the limit of the altitude of the centre of gravity of the whole vessel. Whence it is evident, from what has already been said, that the stability of the vessel increases with the altitude of the metacenter above the centre of gravity: But when the metacenter coincides with the centre of gravity, the vessel has no tendency whatever to move out of the situation into which it may be put. Thus, if the vessel be inclined either to the right or left side, it will remain in that position until a new force is impressed upon it: in this case, therefore, the vessel would not be able to carry sail, and is hence unfit for the purposes of navigation. If the metacenter is below the common centre of gravity, the vessel will instantly overset.

As the determination of the metacenter is of the utmost importance in the construction of ships, it is therefore thought necessary to illustrate this subject more particularly.

Let AEB (fig. 52.) be a section of a ship perpendicular to the keel, and also to the plane of elevation, and passing through the centre of gravity of the ship, and also through the centre of gravity of the immersed part, which let be  $g$ .

Now let the ship be supposed to receive a very small inclination, so that the line of floatation is  $a, b$ , and  $\gamma$  the centre of gravity of the immersed part  $aEb$ . From  $\gamma$  draw  $\gamma M$  perpendicular to  $ab$ , and intersecting  $gM$  in M, the metacenter, as before. Hence the pressure of the water will be in the direction  $\gamma M$ .

In order to determine the point M, the metacenter, the position of  $\gamma$  with respect to the lines AB and  $gG$ , must be previously ascertained. For this purpose, let the ship be supposed to be divided into a great number of sections by planes perpendicular to the keel, and parallel to each other, and to that formerly drawn, these planes being supposed equidistant. Let AEB. (fig. 53.) be one of these sections,  $g$  the centre of gravity of the immersed part before inclination, and  $\gamma$  the centre of gravity of the immersed part when the ship is in its inclined state; the distance  $g\gamma$  between the two centres

Stability of Ship.

of gravity in each section is to be found. Let  $AB$  be the line of floatation of the ship when in an upright state, and  $ab$  the water line when inclined. Then, because the weight of the ship remains the same, the quantity of water displaced will also be the same in both cases, and therefore  $AEB = aEb$ , each sustaining the same part of the whole weight of the ship. From each of these take the part  $AEl$ , which is common to both, and the remainders  $AOa$ ,  $BOb$  will be equal; and which, because the inclination is supposed very small, may be considered as rectilinear triangles, and the point  $O$  the middle of  $AB$ .

Now, let  $Hh$ ,  $Ii$ ,  $Kk$ , be the centres of gravity of the spaces  $AOa$ ,  $AEl$ , and  $BOb$ , respectively. From these points draw the lines  $Hh$ ,  $Ii$ , and  $Kk$ , perpendicular to  $AB$ , and let  $IL$  be drawn perpendicular to  $EO$ . Now to ascertain the distance  $\gamma q$  of the centre of gravity  $\gamma$  of the part  $aEb$  from the line  $AB$ , the momentum of  $aEb$  with respect to this line must be put equal to the difference of the momentums of the parts  $AEl$ ,  $AOa$ , which are upon different sides of  $AB$ . Hence  $aEb \times \gamma q$ , or  $AEB \times \gamma q = AEl \times Ii - AOa \times Hh$ . But since  $g$  is the common centre of gravity of the two parts  $AEl$ ,  $BOb$ , we have therefore  $AEB \times gO = AEl \times Ii + BOb \times Kk$ . Hence by expunging the term  $AEl \times Ii$  from each of these equations, and comparing them, we obtain  $AEB \times \gamma q = AEl \times gO - BOb \times Kk - AOa \times Hh$ .

\* Bezout's Mechanics, art. 263.

Now, since the triangles  $AOa$ ,  $BOb$ , are supposed infinitely small, their momentums or products, by the infinitely little lines  $Hh$ ,  $Kk$ , will also be infinitely small with respect to  $AEB \times gO$ ; which therefore being rejected, the former equation becomes  $AEB \times \gamma q = AEl \times gO$ , and hence  $\gamma q = gO$ . Whence the centres of gravity  $\gamma$ ,  $g$ , being at equal distances below  $AB$ , the infinitely little line  $\gamma g$  is therefore perpendicular to  $EO$ . For the same reason  $g\gamma$ , fig. 52. may be considered as an arch of a circle whose centre is  $M$ .

To determine the value of  $g\gamma$ , the momentum of  $aEb$  with respect to  $EO$  must be taken, for the same reason as before, and put equal to the momentums of the two parts  $AOa$ ,  $AEl$ ; and we shall then have  $aEb \times g\gamma$ , or  $AEB \times g\gamma = AEl \times IL + AOa \times Oh$ . But since  $g$  is the common centre of gravity of the two spaces  $AEl$ ,  $BOb$ , we shall have  $AEl \times IL - BOb \times Ok = 0$ , or  $AEl \times IL = BOb \times Ok$ . Hence  $AEB \times g\gamma = BOb \times Ok + AOa \times Oh = 2 BOb \times Ok$ ; because the two triangles  $AOa$ ,  $BOb$  are equal, and that the distances  $Ok$ ,  $Oh$ , are also evidently equal.

Let  $x$  be the thickness of the section represented by  $ABC$ . Then the momentum of this section will be  $2 BOb \times x \times Ok$ , which equation will also serve for each particular section.

Now let  $f$  represent the sum of the momentums of all the sections. Hence  $f, AEB \times x \times g\gamma = f, 2 BOb \times x \times Ok$ . Now the first member being the sum of the momentums of each section, in proportion to a plane passing through the keel, ought therefore to be equal to the sum of all the sections, or to the volume of the immersed part of the bottom multiplied by the distance  $g\gamma$ . Hence  $V$  representing the volume, we shall have  $V \times g\gamma = f, 2 BOb \times x \times Ok$ .

In order to determine the value of the second member of this equation, it may be remarked, that when the

ship is inclined, the original plane of floatation  $CBPQ$  (fig. 54.) becomes  $CbPQ$ . Now the triangles  $NI n$ ,  $BO b$ , being the same as those in figures 52. and 53.; and as each of these triangles have one angle equal, they may, upon account of their infinite smallness, be considered as similar; and hence  $BO b : NI n :: OB : IN$ ; whence  $BO b = \frac{OB}{IN} \times NI n$ . Moreover, we have (fig. 53.)  $Ok = \frac{1}{2} OB$ , for the points  $K$  and  $k$  may be considered as equidistant from the point  $O$ : whence  $BO b \times Ok = \frac{OB}{IN} \times NI n \times \frac{1}{2} OB$ .

Stability of Ship.

Hence  $V \times g\gamma = f, \frac{1}{2} \frac{OB^2}{IN^2} \times x \times NI n$ . From this equation the value of  $g\gamma$  is obtained.

To find the altitude  $gM$  (fig 55.) of the metacenter above the centre of gravity of the immersed part of the bottom, let the arc  $NS$  be described from the centre  $I$  with the radius  $IN$ ; then  $NI n = \frac{IN \times NS}{2}$ . Now since the two straight lines  $\gamma M$ ,  $gM$  are perpendicular to  $on$  and  $AN$  respectively, the angles  $M$  and  $NI n$  are therefore equal: and the infinitely little portion  $g\gamma$ , which is perpendicular to  $gM$ , may be considered as an arch described from the centre  $M$ . Hence the two sectors  $NIS$ ,  $gM\gamma$  are similar; and therefore  $gM : g\gamma :: IN : NS$ . Hence  $NS = \frac{IN \times g\gamma}{gM}$ ; and consequently

$NI n = \frac{IN^2 \times g\gamma}{2 gM}$ . Now this being substituted in the former equation, and reduced, we have  $V \times g\gamma = f \frac{1}{2} \frac{OB^2 \times x \times g\gamma}{gM}$ . But since  $gM$  and  $g\gamma$  are the

same, whatever section may be under consideration, the equation may therefore be expressed thus,  $V \times g\gamma = \frac{1}{2} \frac{g\gamma}{gM} \cdot f, OB^2 \times x$ . Hence  $gM = \frac{\frac{1}{2} f, OB^2 \times x}{V}$ . Let  $y = OB$ , and the equation becomes  $gM = \frac{\frac{1}{2} f, y^2 \times x}{V}$ . Whence to have the altitude of the meta-

center above the centre of gravity of the immersed part of the bottom, the length of the section at the water-line must be divided by lines perpendicular to the middle line of this section into a great number of equal parts, so that the portion of the curve contained between any two adjacent perpendiculars may be considered as a straight line. Then the sum of the cubes of the half perpendiculars or ordinates is to be multiplied by the distance between the perpendiculars, and two thirds of the product is to be divided by the volume of the immersed part of the bottom of the ship.

It is hence evident, that while the sector at the water line is the same, and the volume of the immersed part of the bottom remains also the same, the altitude of the metacenter will remain the same, whatever may be the figure of the bottom.

CHAP. IV. Of the Centre of Gravity of the immersed Part of the Bottom of a ship.

THE centre of gravity\* of a ship, supposed homogeneous, and in an upright position in the water, is in a

\* See Mechanics. ver.

Centre of Gravity.   
 distance from the stern, and altitude above the keel.

ber of ordinates minus four; then the second ordinate, twice the third, three times the fourth, &c. the sum will be a first term. Then to half the sum of the extreme ordinates add all the intermediate ones, and the sum will be a second term. Now the first term divided by the second, and the quotient multiplied by the interval between two adjacent perpendiculars, will be the distance sought.

Centre of Gravity.

In order to determine the centre of gravity of the immersed part of a ship's bottom, we must begin with determining the centre of gravity of a section of the ship parallel to the keel, as ANDFPB (fig. 55.), bounded by the parallel lines AB, DF, and by the equal and similar curves AND, BPF.

Thus, let there be seven perpendiculars, whose values are 18, 23, 28, 30, 30, 21, 0, feet respectively, and the common interval between these perpendiculars 20 feet. Now the sixth of the first term 18 is 3; and as the last term is 0, therefore to 3 add 23, twice 28 or 56, thrice 30 or 90, four times 30 or 120, five times 21 or 105; and the sum is 397. Then to the half of 18+0, or 9, add the intermediate ordinates, and the sum will be 141. Now  $\frac{397 \times 20}{141}$ , or  $\frac{7940}{141}$ , = 59 feet

66   
 distance from the centre of gravity from the stern or from the keel.

If the equation of this curve were known, its centre of gravity would be easily found: but as this is not the case, let therefore the line CE be drawn through the middle C, E, of the lines AB, DF, and let this line CE be divided into so great a number of equal parts by the perpendiculars TH, KM, &c. that the arches of the curves contained between the extremities of any two adjacent perpendiculars may be considered as straight lines. The momentums of the trapeziums DTHF, TKMH, &c. relative to the point E, are then to be found, and the sum of these momentums is to be divided by the sum of the surfaces, that is, by the surface ANDFPB.

4 inches nearly, the distance of the centre of gravity from the first ordinate.

Now, when the centre of gravity of any section is determined, it is easy from thence to find the centre of gravity of the solid, and consequently that of the bottom of a ship.

Bezout's   
 Mécanique,   
 p. 279.

The distance of the centre of gravity of the trapezium THFD from the point E is =  $\frac{\frac{1}{2}IE \times (DF + 2TH)}{DF + TH}$ .

69   
 Height of the centre of gravity above the keel.   
 The next step is to find the height of the centre of gravity of the bottom above the keel. For this purpose the bottom must be imagined to be divided into sections by planes parallel to the keel or water-line, (figs. 57, 58.) Then the solidity of each portion contained between two parallel planes will be equal to half the sum of the two opposed surfaces multiplied by the distance between them; and its centre of gravity will be at the same altitude as that of the trapezium *abcd*, (fig. 58.), which is in the vertical section passing through the keel. It is hence obvious, that the same rule as before is to be applied to find the altitude of the centre of gravity, with this difference only, that the word perpendicular or ordinate is to be changed into section. Hence the rule is, to the sixth part of the lowest section add the product of the sixth part of the uppermost section by three times the number of sections minus four; the second section in ascending twice the third, three times the fourth, &c. the sum will be a first term. To half the sum of upper and lower sections add the intermediate ones, the sum will be a second term. Divide the first term by the second, and the quotient multiplied by the distance between the sections will give the altitude of the centre of gravity above the keel.

For the same reason, and because of the equality of the lines IE, IL, the distance of the centre of gravity of the trapezium TKMH from the same point E will be  $\frac{\frac{1}{2}IE \times (TH + 2KM)}{TH + KM} + IE$ , or =  $\frac{\frac{1}{2}IE \times (4TH + 5KM)}{TH + KM}$ .

In like manner, the distance of the centre of gravity of the trapezium NKMP from the point E will be  $\frac{\frac{1}{2}IE \times (KM + 2NP)}{KM + NP} + 2IE$ , or  $\frac{\frac{1}{2}IE \times (7KM + 8NP)}{KM + NP}$ , &c.

Now, if each distance be multiplied by the surface of the corresponding trapezium, that is, by the product of half the sum of the two opposite sides of the trapezium into the common altitude IE, we shall have the momentums of these trapeziums, namely,  $\frac{1}{2}IE^2 \times (DF + 2TH)$ ,  $\frac{1}{2}IE^2 \times (4TH + 5KM)$ ,  $\frac{1}{2}IE^2 \times (7KM + 8NP)$ , &c. Hence the sum of these momentums will be  $\frac{1}{2}IE^2 \times (DF + 6TH + 12KM + 18NP + 24QS + 14AB)$ . Whence it may be remarked, that if the line CE be divided into a great number of equal parts, the factor or coefficient of the last term, which is here 14, will be =  $2 + 3(n - 2)$  or  $3n - 4$ , *n* being the number of perpendiculars. Thus the general expression of the sum of the momentums is reduced to  $\frac{1}{2}IE^2 \times (\frac{1}{6}DF + TH + 2KM + 3NP + 4QS + \dots + \frac{3n-4}{6}AB)$ .

With regard to the centre of gravity of a ship, whether it is considered as loaded or light, the operation becomes more difficult. The momentum of every different part of the ship and cargo must be found separately with respect to a horizontal and also a vertical plane. Now the sums of these two momentums being divided by the weight of the ship, will give the altitude of the centre of gravity, and its distance from the vertical plane; and as this centre is in a vertical plane passing through the axis of the keel, its place is therefore determined. In the calculation of the momentums, it must be observed to multiply the weight, and not the magnitude of each piece, by the distance of its centre of gravity.

The area of the figure ANDFPB is equal to  $IE \times (\frac{1}{2}DF + TH + KM + NP + \dots + \frac{1}{2}AB)$ ; hence the distance EG of the centre of gravity G from one of the extreme ordinates DF is equal to  $\frac{IE \times (\frac{1}{6}DF + TH + 2KM + 3NP + \dots + \frac{3n-4}{6}AB)}{\frac{1}{2}DF + TH + KM + NP + \dots + \frac{1}{2}AB}$ .

87   
 distance from the centre of gravity from the stern or from the keel.

Whence the following rule to find the distance of the centre of gravity G from one of the extreme ordinates DF. To the sixth of the first ordinate add the sixth of the last ordinate multiplied by three times the num-

A more easy method of finding the centre of gravity of a ship by a mechanical operation, as follows: Construct

Centre of Gravity.  
69  
A mechanical method for ascertaining the centre of gravity of a ship.

a block of as tight wood as possible, exactly similar to the parts of the proposed draught or ship, by a scale of about one-fourth of an inch to a foot. The block is then to be suspended by a silk-thread or very fine line, placed in different situations until it is found to be in a state of equilibrium, and the centre of gravity will be pointed out. The block may be proved by fastening the line which suspends it to any point in the line joining the middles of the item and post, and weights are to be suspended from the extremities of this middle line at the stem and post. If, then, the block be properly constructed, a plane passing through the line of suspension, and the other two lines, will also pass through the keel, stem, and post. Now, the block being suspended in this manner from any point in the middle line, a line is to be drawn on the block parallel to the line of suspension, so that the plane passing through these two lines may be perpendicular to the vertical plane of the ship in the direction of the keel. The line by which the block is suspended is then to be removed to some

other convenient point in the middle line; and another line is to be drawn on the block parallel to the line suspending it, as before. Then the point of intersection of this line with the former will give the position of the centre of gravity on the block, which may now be laid down in the draught.

Centre of Gravity

CHAP. V. Application of the preceding Rules to the Determination of the Centre of Gravity and the Height of the Metacenter above the Centre of Gravity of a Ship of 74 Guns.

In fig. 59. are laid down the several sections in a horizontal direction, by planes parallel to the keel, and at equal distances from each other, each distance being 10 feet 0 inches 4 parts.

I. Determination of the Centre of Gravity of the upper Horizontal Section.

To find the distance of the centre of gravity of the plane 8 g o G from the first ordinate 8 g.

Ordinates.	Double Ord.	1st Factors.	1st Products.	2d Factors.	2d Products.
Feet. In. P.	Feet. In. P.		Feet In. P.		Feet. In. P.
14 9 0	29 6 0	0 $\frac{1}{2}$	4 11 0	0 $\frac{1}{2}$	14 9 0
17 1 6	34 3 0	1	34 3 0	1	34 3 0
18 9 0	37 6 0	2	75 0 0	1	37 6 0
19 10 0	39 8 0	3	119 0 0	1	39 8 0
20 7 6	41 3 0	4	165 0 0	1	41 3 0
21 1 9	42 3 6	5	211 5 6	1	42 3 6
21 6 3	43 0 6	6	258 3 0	1	43 0 6
21 7 9	43 3 6	7	303 0 6	1	43 3 6
21 7 9	43 3 6	8	346 4 0	1	43 3 6
21 7 6	43 3 0	9	389 3 0	1	43 3 0
21 4 0	42 8 0	10	426 8 0	1	42 8 0
20 10 6	41 9 0	11	459 3 0	1	41 9 0
19 9 0	39 6 0	12	474 0 0	1	39 6 0
17 4 6	34 9 0	13	451 9 0	1	34 9 0
13 1 3	26 2 6	$((3 \times 15) - 4) \times \frac{1}{2}$	179 1 1	0 $\frac{1}{2}$	13 1 3
<u>29 1 1 3</u>	<u>582 2 6</u>		<u>3897 3 1</u>		<u>554 4 3</u>

Now  $\frac{3897 \frac{3}{4}}{554 \frac{4}{3}} \times 10 \text{ o } 4 = \frac{3897 \cdot 25}{554 \cdot 25} \times 10.03 = 70.5$ .

Hence the distance of the centre of gravity of double the plane 8 g o G from the first ordinate 8 g, is	Feet.
Distance of this ordinate from the aft side of stern-post,	70.5
Distance of the centre of gravity from the aft side of post,	13.5
Distance of the centre of gravity of double the trapezium AR g 8 from its ordinate AR,	8.42
Distance of this ordinate from the aft side of the stern-post,	0.58
Distance of the centre of gravity of this plane from the aft side of the stern-post,	9.0
Distance of the centre of gravity of double the trapezium G o y r from its ordinate G o,	5.44
Distance of this ordinate from the aft side of the post,	153.78
Distance of the centre of gravity of this trapezium from the aft side of the post,	159.22
Distance of the centre of gravity of the section of the stern-post from the aft part of the post,	0.29
Distance of the centre of gravity of the section of the stern from the aft side of the post,	169.76

Fig. 35.

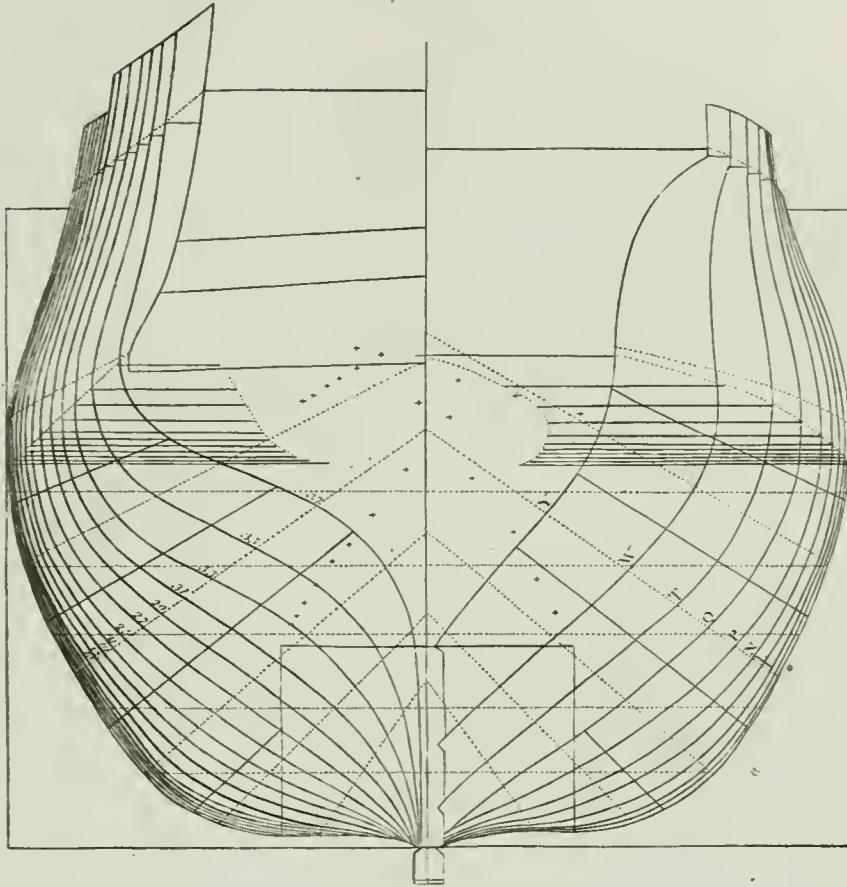
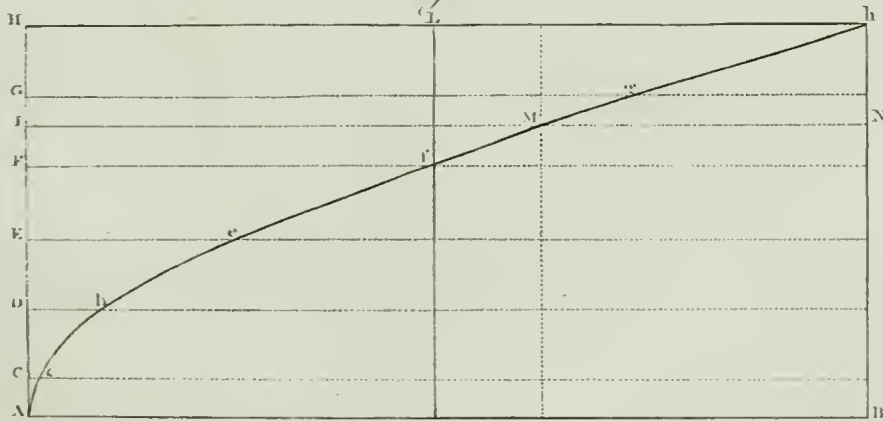
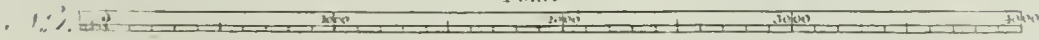

Fig. 36.



K  
Tons.



Fect.

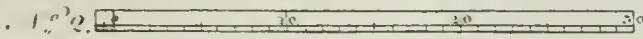

St. B. H. P. 20 L. S. Sulphur print.





Fig. 37.

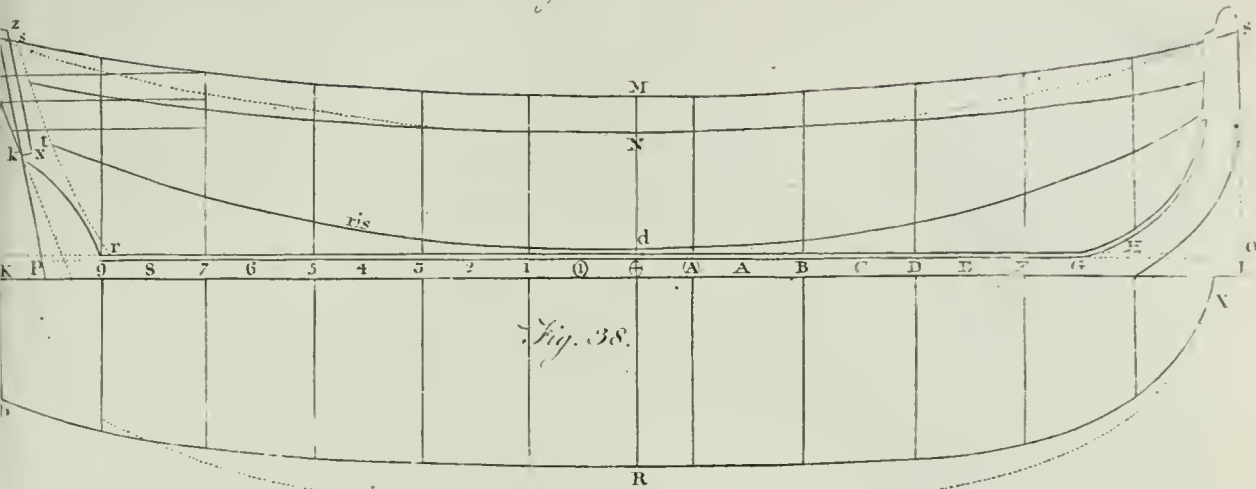

Fig. 38.

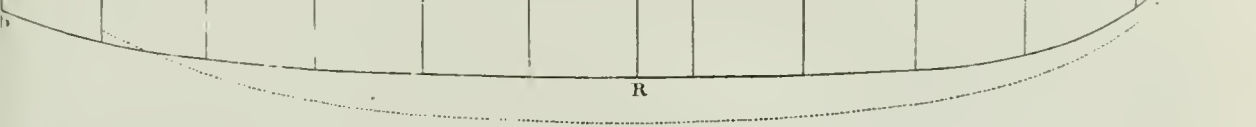

Fig. 39.

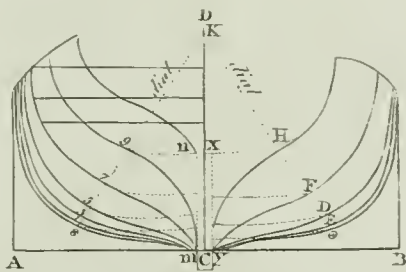

Fig. 40.

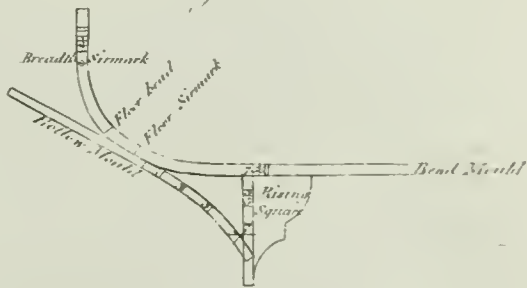

Fig. 41.

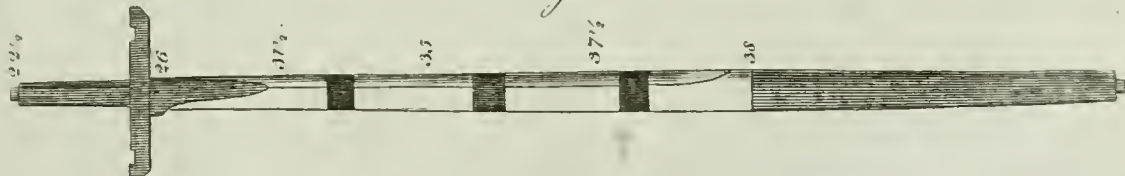

Fig. 42.

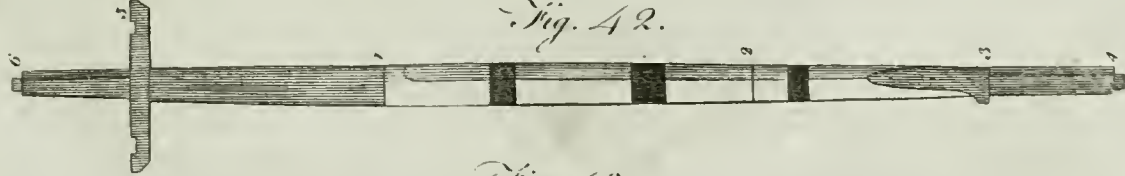
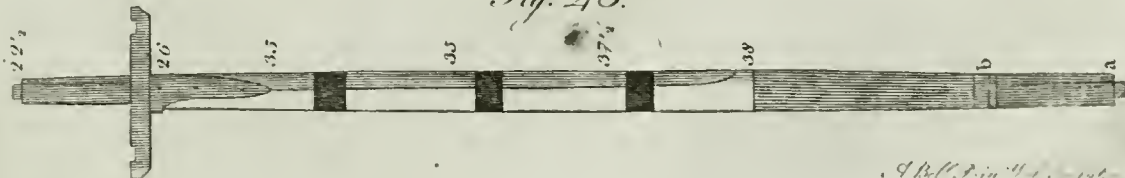

Fig. 43.



A Bell's Patent, 1840.



Fig. 44.

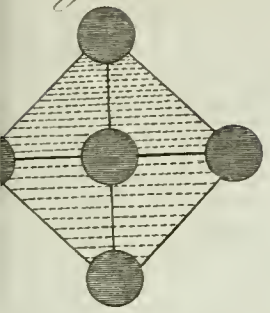

SHIP-BUILDING.

Fig. 45.

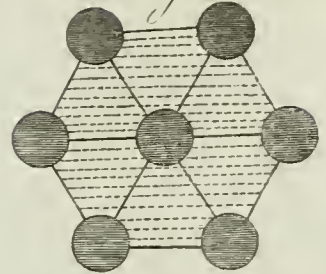

Plate CCCCLXIV.

Fig. 46.

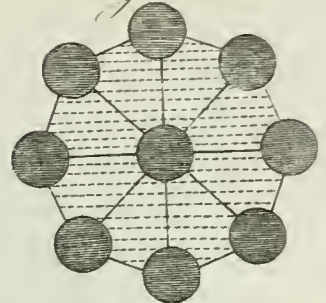

Fig. 49.

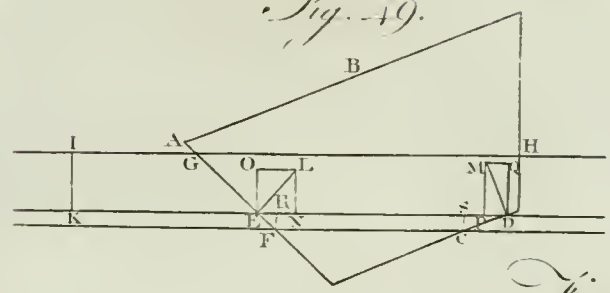
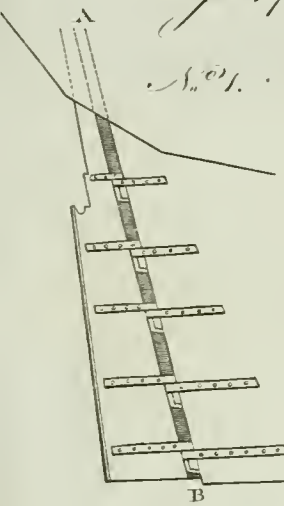

Fig. 47.

No. 1.



No. 2.



Fig. 50.

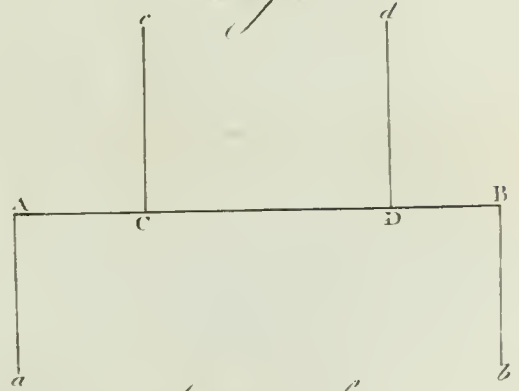
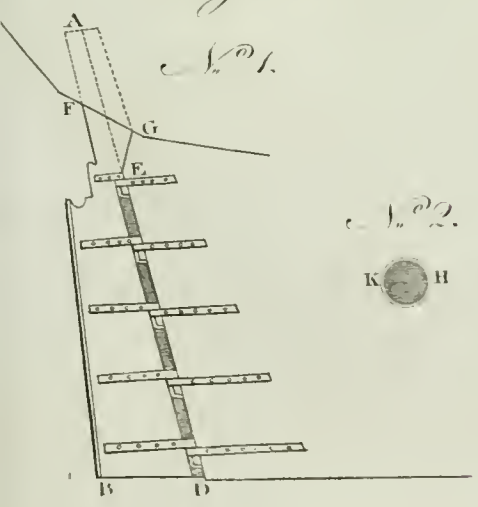

Fig. 48.

No. 1.



No. 2.



Apparatus for Seltzer water.

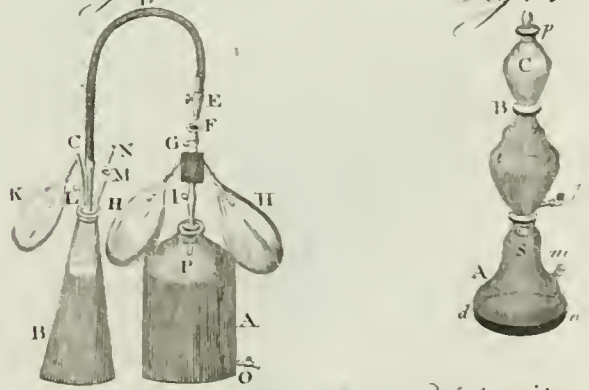

W. Hill & P. Hill, Mul. & Sculptor, Lond.



*Fig. 51.*

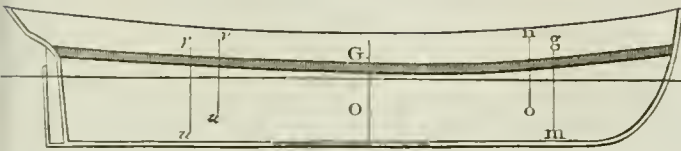

*Fig. 52.*

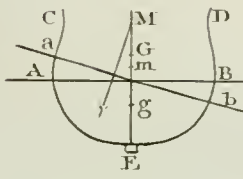

*Fig. 53.*

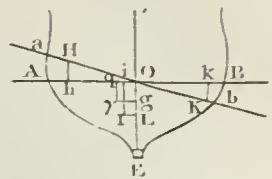

*Fig. 54.*

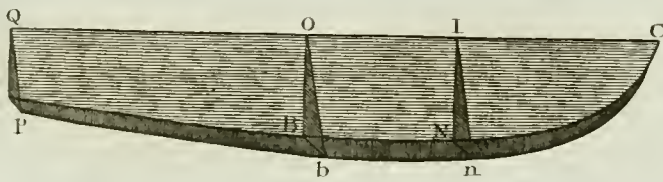

*Fig. 55.*

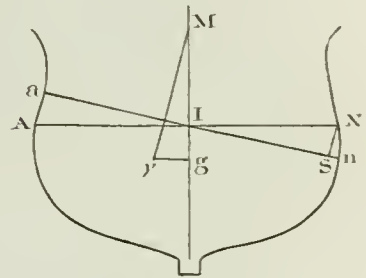

*Fig. 56.*

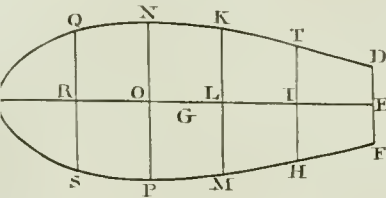

*Fig. 57.*

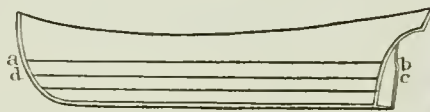

*Fig. 58.*

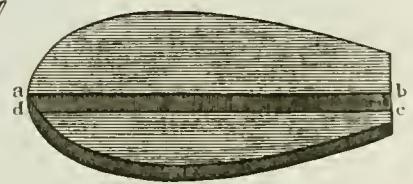

*Fig. 59.*

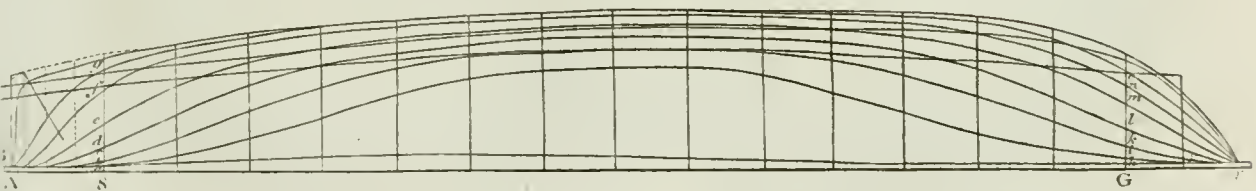

*W. Bell & P. de la Motte Sculptors fecit.*



Centre of Gravity.

Centre of Gravity.

The areas of these several planes, calculated by the common method, will be as follow :

5558.90	for that of the plane, and its momentum	$5558.9 \times 84 =$	466947.6000
199.13	for that of double the trapezium ARg 8, and its momentum	$199.13 \times 9 =$	1792.1700
214.59	for that of double the trapezium Goy, and its momentum	$214.59 \times 159.22 =$	34167.0236
0.77	for that of the section of the stern-post, and its momentum	$0.77 \times 0.29 =$	0.2233
0.77	for that of the section of the stem, and its momentum	$0.77 \times 169.76 =$	130.7152
<hr/>			
5974.16	Sum		503037.7321

Now  $\frac{503037.7321}{5974.16} = 84.2$ , the distance of the centre of gravity of the whole section from the aft side of the stern-post.

II. Determination of the Centre of Gravity of the second Horizontal Section.

To find the distance of the centre of gravity of double the plane 8fn G from its first ordinate 8f.

Ordinates.		Double Ord.		1. Factors.	1. Products.		2. Fact.	2. Products.	
Feet.	In. Pts.	Feet.	In. Pts.		Feet.	In. Pts.		Feet.	In. Pts.
11	2 3	22	4 6	$0\frac{1}{2}$	3	8 9	$0\frac{1}{2}$	11	2 3
15	3 0	30	6 0	1	30	6 0	1	30	6 0
17	5 0	34	10 0	2	69	8 0	1	34	10 0
18	10 3	37	8 6	3	113	1 6	1	37	8 6
19	10 6	39	9 0	4	159	0 0	1	39	9 0
20	7 0	41	2 0	5	205	10 0	1	41	2 0
21	0 3	42	0 6	6	252	3 0	1	42	0 6
21	2 0	42	4 0	7	296	4 0	1	42	4 0
21	0 6	42	1 0	8	336	8 0	1	42	1 0
20	10 9	41	9 6	9	376	1 6	1	41	9 6
20	6 6	41	1 0	10	410	10 0	1	41	1 0
19	10 0	39	8 0	11	436	4 0	1	39	8 0
18	6 0	37	0 0	12	444	0 0	1	37	0 0
15	9 6	31	7 0	13	410	7 0	1	31	7 0
11	2 9	22	5 6	$((3 \times 15) - 4) \times \frac{1}{8}$	153	5 6	$0\frac{1}{2}$	11	2 9
<hr/>					<hr/>			<hr/>	
273	2 3	546	4 6		3698	5 3		523	11 6

Hence the distance of the centre of gravity of double the plane 8fn G from its first ordinate 8n is  $\frac{3698 \ 5 \ 3}{523 \ 11 \ 6} \times 10.04 = \frac{3698.43}{523.95} \times 10.03 = 70.79$

Distance of this ordinate from the aft side of the stern-post - - - - - 13.5

Distance of the centre of gravity of the above plane from the aft side of post - - - - - 84.29

Distance of the centre of gravity of double the trapezium ARf 8 from its ordinate AR - - - - - 8.38

Distance of this ordinate from aft side of stern-post - - - - - 0.57

Distance of the centre of gravity of the trapezium from the aft side of the post - - - - - 8.95

Distance of the centre of gravity of the trapezium before the ordinate Gn from that ordinate - - - - - 5.74

Distance of that ordinate from the aft side of the post - - - - - 153.78

Distance of the centre of gravity of the trapezium from the aft side of the post - - - - - 159.52

Distance of the centre of gravity of the section of the stern-post from the aft side of the post - - - - - 0.29

Distance of the centre of gravity of the section of the stem from the aft side of the post - - - - - 169.76

The areas of these several plans being calculated, will be as follow :

5255.22	for that of the plan 8fn G, and its momentum	$5255.22 \times 84.29 =$	442962.4938
153.11	for that of double the trapezium ARf 8, and its momentum	$153.11 \times 8.95 =$	1370.3345
182.40	the area of the trapezium before, and its momentum	$182.40 \times 159.52 =$	29096.4480
0.77	the area of the section of the stern-post, and its momentum	$0.77 \times 0.29 =$	0.2233
0.77	the area of the section of the stem, and its momentum	$0.77 \times 169.76 =$	130.7152
<hr/>			
5592.27	Sum		473560.2148

Centre of Gravity.

Now  $\frac{473560.2148}{5952.27} = 84.68$ , the distance of the centre of gravity of the whole section from the aftside of the stern-post.

Centre of Gravity.

III. Determination of the Centre of Gravity of the third Horizontal Section.

Distance of the centre of gravity of double the plan  $8emG$  from its first ordinate  $8e$ .

Ordinates.			Double Ord.			1. Factors.			1. Products.			2. Fact.			2. Products.		
Feet.	In.	Pts.	Feet.	In.	Pts.		Feet.	In.	Pts.		Feet.	In.	Pts.	Feet.	In.	Pts.	
6	7	6	13	3	0	$0\frac{1}{2}$	2	2	6	$0\frac{1}{2}$	6	7	6	6	7	6	
11	7	6	23	3	0	1	23	3	0	1	23	3	0	23	3	0	
15	1	0	30	2	0	2	60	4	0	1	30	2	0	30	2	0	
17	1	3	34	2	6	3	102	7	6	1	34	2	6	34	2	6	
18	3	0	36	6	0	4	146	0	0	1	36	6	0	36	6	0	
19	3	0	38	6	0	5	192	6	0	1	38	6	0	38	6	0	
19	9	0	39	6	0	6	237	0	0	1	39	6	0	39	6	0	
20	0	0	40	0	0	7	280	0	0	1	40	0	0	40	0	0	
20	0	0	40	0	0	8	320	0	0	1	40	0	0	40	0	0	
19	8	3	39	4	6	9	354	4	6	1	39	4	6	39	4	6	
19	1	3	38	2	6	10	382	1	0	1	38	2	6	38	2	6	
18	1	0	36	2	0	11	397	10	0	1	36	2	0	36	2	0	
16	3	9	32	7	6	12	391	6	0	1	32	7	6	32	7	6	
13	2	3	26	4	6	13	342	10	6	1	26	4	6	26	4	6	
8	4	6	16	9	0	$((3 \times 15) - 4) \times \frac{1}{2} = 11\frac{1}{2}$	114	5	6	$0\frac{1}{2}$	8	4	6	8	4	6	
<hr/>			<hr/>				<hr/>				<hr/>			<hr/>			
242	5	3	484	10	6		3347	0	6		469	10	6				

Hence the distance of the centre of gravity of double the plane  $8emG$  from its first ordinate  $8e$  is

$$= \frac{3347 \text{ } 0 \text{ } 6}{469 \text{ } 10 \text{ } 6} \times 10 \text{ } 0 \text{ } 4 = \frac{3347.04}{469.87} \times 10.03 = 71.44$$

Distance of this ordinate from the aft side of the post - - - - - 13.5

Hence the distance of the centre of gravity of this plan from the aft side of the post is - - - - - 84.94

Distance of the centre of gravity of double the trapezium  $AReS$ , from its ordinate  $AR$  - - - - - 8.03

Distance of this ordinate from the aft side of the post - - - - - 0.58

Distance of the centre of gravity of this trapezium from the aft side of the post - - - - - 8.61

Distance of the centre of gravity of the foremost trapezium from its ordinate  $Gm$  - - - - - 5.19

Distance of this ordinate from the aft side of the post - - - - - 153.78

Distance of the centre of gravity of this trapezium from the aft side of the post - - - - - 158.97

Distance of the centre of gravity of the section of the post from the aft side of the post - - - - - 0.29

Distance of the centre of gravity of the section of the stem from the aft side of the post - - - - - 169.76

The areas of these several planes will be found to be as follow :

4712.7961	for that of double the plan $8emG$ , and its momentum $4712.7961 \times 84.94 =$	400304.9007
93.84	the area of double the trapezium $AR3e88$ , and its momentum $93.84 \times 8.61 =$	807.9624
131.1	for the area of foremost trapezium, and its momentum $131.1 \times 158.97 =$	20840.967
0.77	the area of the section of the post, and its momentum $0.77 \times 0.29 =$	0.2233
0.77	the area of the section of the stem, and its momentum $0.77 \times 169.76 =$	130.7152
<hr/>		<hr/>
4939.2761	Sum	422084.7706

Now  $\frac{422084.7706}{4939.2761} = 85.45$ , the distance of the centre of gravity of the whole section from the aft side of the post.

IV. Dr



IV. Determination of the Centre of Gravity of the Fourth Horizontal Section.

Distance of the centre of gravity of double the plan 8 d l G from its first ordinate 8 d.

Ordinates.	Double Ord.	1. Factors.	1. Products.	2. Fact.	2. Products.
Feet. In. Pts.	Feet. In. Pts.		Feet. In. Pts.		Feet. In. Pts.
3 3 6	6 7 0	$0\frac{1}{8}$	1 1 2	$0\frac{1}{8}$	3 3 6
7 9 0	15 6 0	1	15 6 0	1	15 6 0
11 11 0	23 10 0	2	47 8 0	1	23 10 0
14 8 9	29 5 6	3	88 4 6	1	29 5 6
16 3 0	32 6 0	4	130 0 0	1	32 6 0
17 4 9	34 9 6	5	173 11 5	1	34 9 6
18 1 9	36 3 6	6	217 9 0	1	36 3 6
18 5 0	36 10 0	7	257 10 0	1	36 10 0
18 3 0	36 6 0	8	292 0 0	1	36 6 0
17 10 9	35 9 6	9	322 1 6	1	35 9 6
17 2 6	34 5 0	10	340 10 0	1	34 5 0
15 10 3	31 8 6	11	348 9 6	1	31 8 6
13 6 0	27 0 0	12	324 0 0	1	27 0 0
9 7 6	19 3 0	13	250 3 0	1	19 3 0
5 4 9	10 9 6	$((3 \times 15) - 4) \times \frac{1}{8}$	73 8 11	$0\frac{1}{8}$	5 4 9
<hr/>	<hr/>		<hr/>		<hr/>
205 7 6	411 3 0		2883 11 0		402 6 9

Hence the distance of the centre of gravity of double the plane 8 d l G from its first ordinate 8 d, is

$$= \frac{2883 \frac{11}{9}}{402 \frac{6}{9}} \times 10 \text{ 0 } 4 = \frac{2883.916}{402.56} \times 10.03 = 71.85$$

Distance of this ordinate from the aft side of the post - - - 13.5

Distance of the centre of gravity of the plan from the aft side of the post - - - 85.35

Distance of the centre of gravity of double the trapezium AR d 8 from its ordinate AR - - - 7.89

Distance of this ordinate from the aft side of the post - - - 0.58

Distance of the centre of gravity of the trapezium from the aft side of the post - - - 8.47

Distance of the centre of gravity of the foremost trapezium from its ordinate G l - - - 4.83

Distance of this ordinate from aft side of the post - - - 153.78

Distance of the centre of gravity of the trapezium from the aft side of the post - - - 158.61

Distance of the centre of gravity of the section of the post from its aft side - - - 0.29

Distance of the centre of gravity of the section of the stem from the aft side of the post - - - 169.76

The areas of these several plans being calculated, will be as follow :

4037.6768	for that of double the plan 8 d l G, and its momentum $4037.6768 \times 85.35 =$	344615.7149
51.12	the area of double the trapezium AR d 8, and its momentum $51.12 \times 8.47 =$	432.9864
79.16	the area of the foremost trapezium, and its momentum $79.16 \times 158.61 =$	12555.5676
0.77	the area of the section of the post, and its momentum $0.77 \times 0.29 =$	0.2233
0.77	the area of the section of the stem, and its momentum $0.77 \times 169.76 =$	130.7152
<hr/>		<hr/>
4169.4968	Sum	357735.2074

Then  $\frac{357735.2074}{4169.4968} = 85.80$ , the distance of the fourth horizontal section from the aft side of the stern-post.

V. Determination of the Centre of Gravity of the fifth Horizontal Section.

Distance of the centre of gravity of double the plan 8 c k G from its first ordinate 8 c.

Ordinates.	Double Ord.	1. Factors.	1. Products.	2. Fact.	2. Products.
Feet. In. L.	Feet. In. L.		Feet. In. L.		Feet. In. L.
1 9 0	3 6 0	$0\frac{1}{8}$	0 7 0	$0\frac{1}{8}$	1 9 0
4 6 0	9 0 0	1	9 0 0	1	9 0 0
<hr/>	<hr/>		<hr/>		<hr/>
Over 6 3 0	12 6 0		9 7 0		10 9 0

3 H z



# S H I P - B U I L D I N G .

Feet. In. L.	Feet. In. L.	Feet. In. L.	Feet. In. L.
Broughtover 37 4 6	74 9 0	268 9 6	73 9 0
13 3 0	26 6 0	159 0 0	26 6 0
13 9 9	27 7 6	193 4 6	27 7 6
13 7 0	27 2 0	217 4 0	27 2 0
12 8 0	25 4 0	228 0 0	25 4 0
10 6 6	21 1 0	210 10 0	21 1 0
7 1 0	14 2 0	155 10 0	14 2 0
4 7 3	9 2 6	110 6 0	9 2 6
2 10 6	5 9 0	74 9 0	5 9 0
1 6 9	3 1 6	21 4 3	1 6 9
117 4 3		1639 9 3	
234 8 6		232 1 9	

Hence the distance of the centre of gravity of double the plane 8 b v G from its first ordinate 8 b is

$$\frac{1639 \cdot 9 \cdot 3}{232 \cdot 1 \cdot 9} \times 10 \cdot 0 \cdot 4 = \frac{1639 \cdot 77}{232 \cdot 14} \times 10 \cdot 03 = 70.84$$

Distance of this ordinate from aft side of post . . . . . 13.50

Hence the distance of the centre of gravity of the plan from the aft side of the post is . . . . . 84.34

Distance of the centre of gravity of the trapezium AR b 8 from its ordinate AR . . . . . 6.88

Distance of this ordinate from the aft side of the post . . . . . 0.58

Distance of the centre of gravity of the trapezium from the aft side of the post . . . . . 7.46

Distance of the centre of gravity of the foremost trapezium from the ordinate G i . . . . . 2.92

Distance of this ordinate from the aft side of post . . . . . 153.78

Distance of the centre of gravity of this trapezium from the aft side of the post . . . . . 156.70

Distance of the centre of gravity of the section of the post from its aft side . . . . . 0.29

Distance of the centre of gravity of the section of the item from the aft side of the post . . . . . 169.76

The areas of these plans will be found to be as follow:

2328.3642	for that of double the plan 8 b i G, and its momentum 2328.3642 × 84.34 =	196374.2366
21.52	for the area of double the trapezium AR b 8, and its momentum 21.52 × 7.46 =	160.5392
15.04	the area of the foremost trapezium, and its momentum 15.04 × 156.7 =	2356.7680
0.77	the area of the section of the post, and its momentum 0.77 × 0.29 =	0.2233
0.77	the area of the section of the item, and its momentum 0.77 × 169.76 =	130.7152
2366.4642 Sum		199022.4823

Now  $\frac{199022.4823}{2366.4642} = 84.1$ , the distance of the centre of gravity of the whole from the aft side of the post,

## VII. Determination of the Centre of Gravity of the seventh Horizontal Section.

Distance of the centre of gravity of double the plan 8 a b G from its first ordinate 8 a.

Ordinates.	Double Ord.	1. Factors.	1. Products.	2. Fact.	2. Products.
Feet In. L.	Feet In. L.		Feet In. L.		Feet In. L.
0 8 0	1 4 0	0 $\frac{1}{8}$	0 2 8	0 $\frac{1}{8}$	0 8 0
1 1 6	2 3 0	1	2 3 0	1	2 3 0
1 7 6	3 3 0	2	6 6 0	1	3 3 0
1 10 9	3 9 6	3	11 4 6	1	3 9 6
2 1 3	4 2 6	4	16 10 0	1	4 2 6
2 1 0	4 2 0	5	20 10 0	1	4 2 0
1 10 9	2 9 6	6	22 9 0	1	3 9 6
1 8 0	3 4 0	7	23 4 0	1	3 4 0
1 1 0	2 2 0	8	17 4 0	1	2 2 0
0 9 0	1 6 0	9	13 6 0	1	1 6 0
0 8 0	1 4 0	10	13 4 0	1	1 4 0
Over 15 6 9		30 1 6		30 5 6	
		148 3 2			

Centre of Gravity

	Fect.	In.	L.	Fect.	In.	L.	Fect.	In.	L.	Fect.	In.	L.	
Brought over	15	6	9	30	1	6	148	3	2	30	5	6	
	0	8	0	1	4	0	14	8	0	1	1	4	0
	0	8	0	1	4	0	16	0	0	1	1	4	0
	0	8	0	1	4	0	17	4	0	1	1	4	0
	0	8	0	1	4	0	$((3 \times 15) - 4) \times \frac{1}{8}$			9	1	4	0
	18	2	9	36	5	6	205	4	6	35	1	6	

Hence the distance of the centre of gravity of double this plane from its first ordinate is  $\frac{205 \ 4 \ 6}{35 \ 1 \ 6} \times 10 \ 0 \ 4$

$= \frac{205.77}{35.12} \times 10.83 = 58.65$

The distance of this ordinate from aft side of post = 13.50

Hence the distance of the centre of gravity of this plane from the aft-side of the post is 72.15

Distance of the centre of gravity of double the rectangle AR a 8 from its ordinate AR 6.45

Distance of this ordinate from the aft side of the post 0.58

Distance of the centre of gravity of this rectangle from the aft side of the post 7.03

Distance of the centre of gravity of the foremost rectangle from its ordinate 7' 7 e 7' 1.25

Distance of this ordinate from the aft side of the post 153.78

Distance of the centre of gravity of this rectangle from the aft side of the post 155.03

Distance of the centre of gravity of the section of the post from its aft side 0.29

Distance of the centre of gravity of the section of the stem from the aft side of the post 169.76

Now the areas of these several plans being calculated will be as follows.

352.2536, the area of double the plan *8 a b G*, and its momentum 25415.0972

17.1570, the area of double the rectangle *AR a 8*, and its momentum 17.1570 x 7.03 = 120.6137

3.3250, the area of the foremost rectangle, and its momentum 3.3250 x 1.55.03 = 515.4747

0.77, the area of the section of the post, and its momentum 0.77 x 0.29 = 0.2233

0.77, the area of the section of the stem and its momentum 0.77 x 169.76 = 130.7152

Sum 26182.1242

374.2756

Then  $\frac{26182.1242}{374.2756} = 69.95$ , the distance of the centre of gravity of the whole section from the aft side of the post.

VIII. Determination of the Centre of Gravity of the eighth Plane.

This plane is equal in length to the seventh horizontal plane, and its breadth is equal to that of the keel. The distance between the seventh and eighth planes is three feet, but which is here taken equal to 2 feet 11 1/2 inches.

Distance between the aft side of the post and the first ordinate 13.5

Fourteen intervals between the fifteen ordinates, each interval being 10.03 feet 140.42

Distance of the last ordinate from the fore foot 2.2

Hence the length of the eighth plane is 156.12

Which multiplied by the breadth 1.33

The product is the area of this plane 208

The distance of its centre of gravity from the aft side of the post, being equal to half its length, is 78.06

The centres of gravity of these eight planes being found, the distance of the centre of gravity of the bottom of the ship from the aft side of the post, and also its altitude, may from thence be easily determined.

From the principles already explained, the distance of the centre of gravity of the bottom from the aft side of the post, is equal to the sum of the momentums of an infinite number of horizontal planes, divided by the sum of these planes, or, which is the same, by the solidity of the bottom. As, however, we have no more than eight planes, we must therefore conceive their momentums as the ordinates of a curve, whose distances may be the same as that of the horizontal planes. Now the sum of these ordinates minus half the sum of the extreme ordinates being multiplied by their distance, gives the surface of the curve; of which any ordinate whatever represents the momentum of the horizontal plane at the same altitude as these ordinates; and the whole surface will represent the sum of the momentums of all the horizontal planes.

Hor. Planes.	Fact.	Product.	Momentums.	Fact.	Products.
5974.16	0 1/2	2987.08	503037.73	0 1/2	251518.86
5592.27	1	5592.27	473560.21	1	473560.21
4939.27	1	4939.27	422084.77	1	422084.77
4169.50	1	4169.50	357735.21	1	357735.21
3365.42	1	3365.42	288729.20	1	288729.20
2366.46	1	2366.46	199022.48	1	199022.48
374.27	1	374.27	21682.12	1	21682.12
208.00	0 1/2	104.00	16236.48	0 1/2	8118.24
		23898.27			2022451.09

Now  $\frac{2022451.09}{23898.27} = 84.63$ , the distance of the centre

of centre of gravity of the bottom of the ship from the aft side of the post.

The height of the centre of gravity of the bottom above the lower edge of the keel may be determined by the same principles. Thus,

To one sixth of the lowermost horizontal section add the product of one sixth of the uppermost section by three times the number of sections minus four the second section in ascending, twice the third, three times the fourth, &c. ; and to half the sum of the extreme planes add all the intermediate ones. Now the first of these sums, multiplied by the distance between the planes or sections, and divided by the second sum, gives the altitude of the centre of gravity of the bottom of the ship above the lower edge of the keel as required.

Hor. Planes.	1st Fact.	1st Products.	2d Fact.	2d Products.
208.00	0½	34.67	0½	104.00
374.27	1	374.27	1	374.27
2366.46	2	4732.92	1	2366.46
3365.42	3	10096.26	1	3365.42
4169.50	4	16678.00	1	4169.50
4939.27	5	24696.35	1	4939.27
5592.27	6	33553.62	1	5592.27
5974.16	$((3 \times 8) - 4) \times \frac{1}{8}$	19913.87	0½	2987.08
		110079.96		23898.27

Now  $\frac{110079.96}{23898.27} \times 2.95 = 13.588$ , the height of

the centre of gravity of the bottom of the ship above the lower edge of the keel.

We have now found the distance of the centre of gravity of the bottom of the ship from the aft side of the post, and its altitude above the lower edge of the keel. Hence the ship being supposed in an upright position, this centre of gravity will necessarily be in the vertical longitudinal section which divides the ship into two equal and similar parts; the position of this centre is therefore determined.

It now remains to find the height of the metacenter above the centre of gravity; the expression for this altitude, as found in Chap. III. is  $\frac{\frac{2}{3} \int y^3 x}{V}$ ; which we shall

now apply to determine the metacenter of the ship of 74 guns, whose centre of gravity we have already found.

Ord. of the Plane of Floatation.    Cub. of Ordinates.

Ft.	Inch.	Ft. & dec. of Foot.	Cub. of Ordinates.
14	9 0	14.7	3109.046
17	1 6	17.1	5000.211
18	9 0	18.7	6591.797
19	10 0	19.8	7762.392
20	7 6	20.6	8741.816
21	1 9	21.2	9595.703
21	6 3	21.5	9938.375
21	7 9	21.7	10289.109
21	7 9	21.7	10289.109
21	7 6	21.7	10289.109
21	4 0	21.3	9663.597
20	10 6	20.9	9129.329
19	9 0	19.7	7703.734
17	4 6	17.4	5268.024
13	1 3	13.1	2248.091
291	1 3	291.1	115719.442

Ordinate at 10.03 feet abaft the ordinate 8g, = 4, of which the cube is 64, and  $64 \times \frac{1}{2} = 32$ .  
Ordinate at 10.03 feet afore the ordinate Gσ = 6, cube of which is 216, and  $216 \times \frac{1}{2} = 108$ .

Sum	-	115859.442
Distance between the ordinates	-	10.03
Product	-	1162070.20326
Half the cube of the aftermost ordinate	-	32.
Half the cube of the thickness of the stem	-	0.14
Sum	-	32.14
Distance between the ordinates	-	3.0
Product	-	96.42
Half the cube of the foremost ordinate	-	108.
Half the cube of the thickness of the stem	-	0.14
Sum	-	108.14
Distance between the ordinates	-	5.5

Product - - - - - 594.77  
 $\int y^3 x$  - - - - - 1162761.39326  
 $2 \int y^3 x$  - - - - - 2325522.78652  
 $\frac{2}{3} \int y^3 x$  - - - - - 775174.26217  
 The solidity of the bottom is 2527½ tons = 70018.67 cubic feet: hence  $\frac{\frac{2}{3} \int y^3 x}{V} = \frac{77517.26}{70018.67} = 11.07$  feet, the altitude of the metacenter above the centre of gravity of the bottom of the ship.

APPENDIX.

WHEN a ship is built, she must be fitted with masts, yards, sails, ropes, and blocks, or, in other words, she must be rigged before she can go to sea. To complete this article, it may therefore be thought necessary to treat of the art of rigging vessels; but we have elsewhere (see *Mast-Rigging*, *ROPE-MAKING*, and *SAIL*) shown how the several parts of a ship's rigging are made; and the art of putting them properly together, so as to make the ship best answer the purpose for which she is intended, depends upon a just knowledge of the impulse and resistance of fluids, and of the theory and practice of seamanship. (See *RESISTANCE of Fluids* and *SEAMANSHIP*). Nothing, therefore, of the subject is left to us here, except we were to state in few words the progressive method of rigging ships; but there is no one undeviating mode which is pursued, as the nature of the operation is such that all the parts of it may be advancing at the same time. We shall therefore take our leave of ships and ship-building with a few general observations on sail-making, which were omitted under the article *SAIL*, referring our readers for farther information to the very elegant work lately published, in

two volumes 4to, on the *Elements and Practice of Rigging and Seamanship*.

Sails are made of canvas, of different textures, and are extended on or between the masts, to receive the wind that forces the vessel through the water. They are quadrilateral or triangular, as has been elsewhere described, and are cut out of the canvas cloth by cloth. The width is governed by the length of the yard, gaff, boom, or stay; the depth by the height of the mast. In the valuable work to which we have just referred, the following directions are given for cutting sails. "The width and depth being given, find the number of cloths the width requires, allowing for seams, tabling on the leeches, and slack cloth; and, in the depth, allow for tabling on the head and foot. For sails cut square on the head and foot, with gores only on the leeches, as some topsails, &c. the cloths on the head, between the leeches, are cut square to the depth; and the gores on the leeches are found by dividing the depth of the sail by the number of cloths gored, which gives the length of each gore. The gore is set down from a square with the opposite selvage; and the canvas being cut diagonally, the longest gored side of one cloth makes the shortest side of the next; consequently, the first gore being known, the rest are cut by it. In the leeches of topsails cut hollow, the upper gores are longer than the lower ones; and in sails cut with a roach leech, the lower gores are longer than the upper ones. This must be regulated by judgment, and care taken that the whole of the gores do not exceed the depth of the leech. Or, by drawing on paper the gored side of the sail, and delineating the breadth of every cloth by a convenient scale of equal parts of an inch to a foot, the length of every gore may be found with precision. Sails, gored with a sweep on the head or the foot, or on both, have the depth of their gores marked on the selvage, from the square of the given depth on each cloth, and are cut as above; the longest selvage of one serving to measure the shortest selvage of the next, beginning with the first gored cloth next the middle in some sails, and the first cloth next the mast leech in others. For those gores that are irregular no strict rule can be given; they can only be determined by the judgment of the sail-maker, or by a drawing.

*Elements and Practice of Rigging and Seamanship*, vol. 1. p. 91.

"In the royal navy, mizen topsails are cut with three quarters of a yard hollow in the foot; but, in the merchant service, top and topgallant sails are cut with more or less hollow in the foot. Flying jibs are cut with a roach-curve on the stay, and a three-inch gore in each cloth, shortening from the tack to the clue. Lower studding-sails are cut with square leeches, and topmast and topgallant-mast studding sails with goring leeches.

"The length of reef and middle bands is governed by the width of the sail at their respective places; the leech-linings, buntline-cloths, top-linings, mast-cloths, and corner-pieces, are cut agreeably to the depth of the sail; each cloth and every article should be properly marked with charcoal, to prevent confusion or mistake. Sails that have bonnets are cut out the whole depth of the sail and bonnet included, allowing enough for the tablings on the foot of the sail and head and foot of the

bonnet. The bonnet is cut off after the sail is sewed together. If a drabler is required, it is allowed for in the cutting out the same as the bonnet."

When the cloth is thus properly cut, the different pieces are to be joined together in the form of a sail; and for doing this properly we have the following directions in the work already quoted. "Sails have a double flat seam, and should be sewed with the best English-made twine of three threads, spun 360 fathoms to the pound, and have from one hundred and eight to one hundred and sixteen stitches in every yard in length. The twine for large sails, in the royal navy, is waxed by hand, with genuine bees-wax, mixed with one-sixth part of clear turpentine; and, for small sails, in a mixture made with bees wax, 4 lb; hogs lard 5 lb; and clear turpentine 1 lb. In the merchant service, the twine is dipped in tar (L), softened with a proper proportion of oil.

"It is the erroneous practice of some sailmakers not to sew the seams any farther than where the edge is creased down for the tabling; but all sails should be sewed quite home to the end, and, when finished, should be well rubbed down with a rubber. In the merchant service seams are sometimes made broader at the foot than at the head, being stronger. Broad seams are not allowed to be made on courses, in the royal navy, but goring leeches are adopted in lieu of them. Boom-mainsails and the sails of sloops generally have the seams broader at the foot than at the head. The seams of courses and topsails are stuck or stitched up, in the middle of the seams, along the whole length, with double seaming-twine; and have from 68 to 72 stitches in a yard. In the merchant service it is common to stick the seams with two rows of stitches, when the sail is half worn, as they will then last till the sail is worn out.

"The breadth of the seams of courses, topsails, and other sails, in the royal navy, to be as follow, viz. courses and topsails, for 50 gun ships and upwards, one inch and a half, and, for 44 gun ships and under, one inch and a quarter, at head and foot; all other sails, one inch at head and foot.

"The tablings of all sails are to be of a proportionable breadth to the size of the sail, and sewed at the edge, with 68 to 72 stitches in a yard. Those for the heads of main and fore courses to be four to six inches wide; for sprit courses and mizens, drivers, and other boom sails, 3 to 4 inches wide; for topsails, 3 inches to 4 inches and a half; topgallant and sprit topsails, 3 inches; royal sails, 2 inches and a half; jib and other staysails, 3 inches to 4 inches and a half, on the stay or hoist; and for studding sails, 3 inches to 4 inches on the head. Tablings on the foot and leeches of main and fore courses to be 3 inches to 5 inches broad; sprit course and topsails, 3 inches; topgallant and sprit topsails, 2 inches and a half; royals, 2 inches; fore leeches of mizen, driver, and other boom-sails, 3 inches and a half to 4 inches; after leech, 3 inches; and on the foot 2 or 3 inches. Tablings on the after leech of jibs and other staysails to be from 2 to 3 inches broad; and, on the foot, 2 to 2 inches and a half: on studding sail leeches one inch and a half to two inches and a half; and on the foot, from one to two inches.

"Main

(L) The dipping of the twine in tar, we are persuaded, is a very bad practice, for the reason assigned in ROPE-MAKING. See that article, n<sup>o</sup> 32.

pendix. "Main and fore courses are lined on the leeches, from clue to earing, with one cloth seamed on and stuck or stitched in the middle, and have a middle band half way between the lower reef band and the foot, also four buntline cloths, at equal distances between the leeches, the upper end of which are carried under the middle band, that the lower side of the band may be tabled upon or sewed over the end of the buntline pieces. They have likewise two reef bands; each in breadth one third of the breadth of the canvas; the upper one is one sixth of the depth of the sail from the head, and the lower band is at the same distance from the upper one; the ends go four inches under the leech linings, which are seamed over the reef bands. All linings are seamed on, and are stuck with 68 to 72 stitches in a yard.

"Main, fore, and mizen, topsails have leech linings, mast and top linings, buntline cloths, middle bands and reef bands. The leech linings are made of one breadth of cloth, so cut and sewed as to be half a cloth broad at the head, and a cloth and a half broad at the foot; the piece cut out being half the breadth of the cloth at one end, and tapering to a point at the other. The middle bands are put on half way between the lower reef and foot, the buntline cloths join the top-linings, and the buntline cloths and top-linings are carried up to the lower side of the middle band, which is tabled on them. The mast lining is of two cloths, and extends from the foot of the sail to the lower reef, to receive the beat or chafe of the mast. The middle band is made of one breadth of canvas, of the same number as the top-lining. It is first folded and rubbed down, to make a crease at one third of the breadth; then tabled on the selvage, and stuck along the crease; then turned down, and tabled and stuck through both the double and single parts, with 68 to 72 stitches in a yard. It is the opinion of many, that middle bands should not be put on until the sail is half worn.

"Main and fore topsails have three and sometimes four reef bands from leech to leech, over the leech linings; the upper one is one eighth of the depth of the sail from the head, and they are the same distance asunder in the royal navy, but more in the merchant service. The reef bands are each of half a breadth of canvas put on double; the first side is stuck twice, and the last turned over, so that the reef holes may be worked upon the double part of the band, which is also stuck with 68 to 72 stitches in a yard.

"The top-lining of topsails is of canvas n<sup>o</sup> 6 or 7. The other linings of this, and all the linings of other sails, should be of the same quality as the sails to which they belong.

"Top-linings and mast cloths are put on the aft side, and all other linings on the fore side, of sails. Mizens are lined with one breadth of cloth from the clue five yards up the leech, and have a reef band sewed on, in the same manner as on other sails, at one fifth the depth of the sail from the foot; they have also a nock-piece and a peek-piece, one cut out of the other, so that each contains one yard. Mizen topsails of 50 gun ships and upwards have three reefs, the upper one is one eighth of the depth of the sail from the head, and the reefs are at the same distance asunder. Mizen topsails of ships of 44 guns and under have two reefs one seventh part of the depth of the sail asunder, the upper one being at the same distance from the head. Main and main top

studding sails have each one reef, at one eighth of the depth of the sail from the head. Reef bands should not be put on until the sail is sewed up, a contrary practice being very erroneous. Lower stay-sails, fore top and main top stay-sails, and flying jibs, have clue-pieces two yards long. Square tack stay-sails have half a breadth of cloth at the fore part, with a clue-piece containing two yards, and a peek-piece, containing one yard.

"Sails have two holes in each cloth, at the heads and reefs of courses, topsails, and other square sails; one hole in every yard in the stay of flying jibs, and one in every three quarters of a yard in the stays of square tack and other stay-sails. These are made by an instrument called a *pegging awl*, or a *stabber*, and are fenced round by stitching the edge to a small grommet, made with log or other line; when finished, they should be well stretched or rounded up by a *pricker* or a *marline-spike*. Reef and head holes of large sails have grommets of twelve-thread line, worked round with 18 to 21 stitches; smaller sails have grommets of nine-thread line, with 16 to 18 stitches, or as many as shall cover the line, and smaller holes in proportion. The holes for marling the clues of sails and the top-brims of topsails have grommets of log-line, and should have from 9 to 11 stitches; twelve holes are worked in each cloth. Main courses have marling holes from the clue to the lower bow line cringle up the leech, and from the clue to the first buntline cringle on the foot. Fore courses have marling holes one eighth of the depth of the sail up the leech, and from the clue to the first buntline cringle at the foot. Main and fore topsails have marling holes three feet each way from the clue and at the top-brims. Sprit-sails, mizen topsails, lower stay-sails, main and fore top stay-sails, and jibs, have marling holes two feet each way from the clues. All other sails are sewed home to the clues. Marling holes of courses are at three fourths of the depth of the tablings at the clues from the rope, and those of topsails are at half the depth of the tablings at the clues and top-brim from the rope."

The rope, which is sewed on the edges of sails to prevent their rending, and which is called *bolt-rope*, should be well made of fine yarn, spun from the best Riga rhine hemp well topt, and sewed on with good English-made twine of three threads, spun 200 fathom to the pound; the twine in the royal navy is dipped in a composition made with bees-wax, 4 lbs; hogs lard 5 lbs; and clear turpentine one pound; and in the merchant service, in tar softened with oil. They should be stoved in a stove by the heat of a flue, and not in a baker's oven or a stove tub; and tarred in the best Stockholm tar. The flexibility of them should be always considered, in taking in the slack, which must rest on the judgment of the sailmaker.

"Bolt-ropes of courses, topsails, and all other sails, should be neatly sewed on through every buntline of the rope; and, to avoid stretching, the rope must be kept tightly twisted while sewing on, and care taken that neither too much nor too little slack is taken in; they are to be cross-stitched at the leeches every twelve inches in length; at every seam, and in the middle of every cloth at the foot, with three cross-stitches: four cross-stitches should be taken at all beginnings and fastenings off; the first stitch given twice, and the last three times. Small sails have two cross stitches at every seam, and three at every fastening off.

Appendix.

“ On main and fore courses two inches slack cloth should be allowed in the head and foot, and one inch and a half in the leeches, in every yard in length. Top sails are allowed 3 inches slack in every cloth in the foot, one inch and a half in every yard in the leech, and two inches in every cloth left open in the top-brim. Mizzen courses have two inches slack in every yard in the foremost leech, but none in the after leech or foot. Sprit-sail courses have no slack cloth. Jibs have four inches slack in every yard in the stay, one inch in every cloth in the foot, and none in the leech. Stay-sails have three inches slack in every yard in the stay, one inch in

every cloth in the foot, but none in the leech. Top-gallant sails have two inches slack in every cloth in the foot, and one inch in every yard in the leech. Studding sails have an inch and a half slack in every yard in going leeches, but no slack in square leeches, and one inch in every cloth in the head and foot.”

These directions for sailmaking, we trust may be useful. They are indeed very general, but the limits prescribed us will not permit of a more minute detail. The sailmaker will find every instruction that he can want in the *Elements of Rigging and Seaman'ship*, a work which we therefore recommend to his attention.

Ship.

**S H I**  
*SHIP's Form Gauge*, an instrument recommended by Mr Hutchinson as fit to ascertain any alteration in the bottom of a ship, by its hogging or sagging; and also to regulate the stowage of a ship.

“ All ships (says he) of any consequence are built with staunchions fixed on the keelson to the middle of all the lower-deck beams fore and aft, in order to support them in their exact, regular height, as well as the whole frame of the ship in the regular form in which she was built upon the stocks; yet notwithstanding these staunchions, it is proved from experience that our ships bottoms, hitherto, by the pressure of water, and improper stowage, have generally been hogged upwards, or sagged downwards, and most about the midship frame or main body of the ship, which is commonly about the fore part of the main hatchway; which naturally makes it the best place at which to fix the ship's form gauge, where either the hogging or sagging of her bottom may be observed and seen soonest and best, to regulate the stowage of heavy materials to the greatest advantage, so as to keep her bottom nearly in the same form in which she was built.

“ The gauge I recommend is nothing more than a narrow plate of iron divided into inches and quarters like the slide of a carpenter's rule. Let this be fixed to the after side of the staunchion now mentioned, with its upper end projecting two or three inches above the staunchion; a groove being cut out for it in the after side of the lower-deck beam, and a mark being made (when the ship is on the stocks) at the part of the beam which corresponds to the o on the gauge. When the ship alters in her shape, the gauge will slide up and down in this groove, and the quantity of hogging or sagging will be pointed out on the gauge by the mark on the beam. The stowage may then be so managed as to bring this mark to coincide again with the o, or to approach it as near as we see necessary.”

*SHIP-Money*, was an imposition charged upon the ports, towns, cities, boroughs, and counties of this realm, in the reign of king Charles I. by writs, commonly called *ship-writs*, under the great seal of England, in the years 1635 and 1636, for the providing and furnishing of certain ships for the king's service, &c. which was declared to be contrary to the laws and statutes of this realm, the *petition of right* and liberty of the subject, by stat. 17 Car. I. c. 14. See *Blackstone's Commentaries*, vol. iv. p. 30.

*SHIP-Shape*, according to the fashion of a ship, or in the manner of an expert sailer; as, The mast is not rigged ship-shape; Trim your sails ship-shape.

S H I

*Stowing and Trimming of SHIPS*, the method of disposing of the cargo in a proper and judicious manner in the hold of a ship.

A ship's sailing, steering, staying, and wearing, and being lively and comparatively easy at sea in a storm, depends greatly on the cargo, ballast, or other materials, being properly stowed, according to their weight and bulk, and the proportional dimensions of the hull of the ship, which may be made too crank or too stiff to pass on the ocean with safety. These things render this branch of knowledge of such consequence, that rules for it ought to be endeavoured after, if but to prevent, as much as possible, the danger of a ship over-setting at sea, or being so labour-some as to roll away her masts, &c. by being improperly stowed, which is often the case.

When a ship is new, it is prudent to consult the builder, who may be supposed best acquainted with a ship of his own planning, and most likely to judge what her properties will be, to advise how the cargo or materials, according to the nature of them, ought to be disposed of to advantage, so as to put her in the best sailing trim; and at every favourable opportunity afterwards it will be proper to endeavour to find out her best trim by experiment.

Ships must differ in their form and proportional dimensions; and to make them answer their different purposes, they will require different management in the stowage, which ought not to be left to mere chance, or done at random, as goods or materials happen to come to hand, which is too often the cause that such improper stowage makes ships unfit for sea: therefore the stowage should be considered, planned, and contrived, according to the built and properties of the ship, which if they are not known should be inquired after. If she is narrow and high-built in proportion, so that she will not shift herself without a great weight in the hold, it is a certain sign such a ship will require a great part of heavy goods, ballast, or materials, laid low in the hold, to make her stiff enough to bear sufficient sail without being in danger of over-setting. But if a ship be built broad and low in proportion, so that she is stiff and will support herself without any weight in the hold, such a ship will require heavy goods, ballast, or materials, stowed higher up, to prevent her from being too stiff and labour-some at sea, so as to endanger her masts being rolled away, and the hull worked loose and made leaky.

In order to help a ship's sailing, that she should be lively and easy in her pitching and ascending motions,

it



it should be contrived by the stowage, that the principal and weightiest part of the cargo or materials should lie as near the main body of the ship, and as far from the extreme ends, fore and aft, as things will admit of. For it should be considered, that the roomy part of our ships lengthwise forms a sweep or curve near four times as long as they are broad; therefore those roomy parts at and above the water's edge, which are made by a full harping and a broad transom to support the ship steady and keep her from plunging into the sea, and also by the entrance and run of the ship having little or no bearing body under for the pressure of the water to support them, of course should not be stowed with heavy goods or materials, but all the necessary vacancies, broken stowage, or light goods, should be at these extreme ends fore and aft; and in proportion as they are kept lighter by the stowage, the ship will be more lively to fall and rise easy in great seas; and this will contribute greatly to her working and sailing, and to prevent her from straining and hogging; for which reason it is a wrong practice to leave such a large vacancy in the main hatchway, as is usual, to coil and work the cables, which ought to be in the fore or after hatchway, that the principal weight may be more easily stowed in the main body of the ship, above the flattest and lowest floorings, where the pressure of the water acts the more to support it.

*Machine for measuring a Ship's Way.* We have already described a variety of machines or instruments which have been proposed for this purpose under the article LOG. In this place, therefore, we shall confine ourselves to the machine invented by Francis Hopkinson, Esq; Judge of the Admiralty in Pennsylvania.—After having shown the fallacies to which the common log, and also that particular kind of instrument invented by M. Saumarez, are liable, he proceeds to describe his own machine as follows:

This machine, in its most simple form, is represented by fig. 5. Plate CCCCLIII. wherein AB is a strong rod of iron moveable on the fulcrum C. D is a thin circular palate of brass rivetted to the lower extremity of the rod. E an horizontal arm connected at one end with the top of the rod AB by a moveable joint F, and at the other end with the bottom of the index H, by a like moveable joint G. H is the index turning on its centre I, and travelling over the graduated arch K; and L is a strong spring, bearing against the rod AB, and constantly counteracting the pressure upon the palate D. The rod AB should be applied close to the cut-water or stem, and should be of such a length that the palate D may be no higher above the keel than is necessary to secure it from injury when the vessel is aground, or sails in shoal water. As the bow of the ship curves inward towards the keel M, the palate D will be thrown to a distance from the bottom of the vessel, although the perpendicular rod to which it is annexed lies close to the bow above; and therefore the palate will be more fairly acted upon. The arm E should enter the bow somewhere near the hawse hole, and lead to any convenient place in the forecastle, where a smooth board or plate may be fixed, having the index H, and graduated arch K, upon it.

It is evident from the figure, that as the ship is urged forward by the wind, the palate D will be pressed upon by the resisting medium, with a greater or less

force, according to the progressive motion of the ship; and this will operate upon the levers so as to immediately affect the index, making the least increase or diminution of the ship's way visible on the graduated arch; the spring L always counteracting the pressure upon the palate, and bringing back the index, on any relaxation or the force impressed.

This machine is advantageously placed at the bow of the ship, where the current first begins, and acts fairly upon the palate, in preference to the stern, where the tumultuous closing of the waters causes a wake, visible to a great distance. The palate D is sunk nearly as low as the keel, that it may not be influenced by the heaping up of the water and the dashing of the waves at and near the water line. The arch K is to ascertain how many knots or miles she would run in one hour at her then rate of sailing. But the graduations on this arch must be unequal; because the resistance of the spring L will increase as it becomes more bent, so that the index will travel over a greater space from one to five miles than from five to twelve. Lastly, the palate, rod, spring, and all the metallic parts of the instrument, should be covered with a strong varnish, to prevent rust from the corrosive quality of the salt water and sea air.

This machine may be considerably improved as follows: Let the rod or spear AB (fig. 5.) be a round rod of iron or steel, and instead of moving on the fulcrum or joint, as at C, let it pass through and turn freely in a socket, to which socket the moveable joint must be annexed, as represented in fig. 6. The rod must have a shoulder to bear on the upper edge of the socket, to prevent its slipping quite down. The rod must also pass through a like socket at F, fig. 5. The joint of the lower socket must be fixed to the bow of the ship, and the upper joint or socket must be connected with the horizontal arm E. On the top of the uppermost socket let there be a small circular plate, bearing the 32 points of the mariner's compass; and let the top of the rod AB come through the centre of this plate, so as to carry a small index upon it, as is represented in fig. 7. This small index must be fixed to the top of the rod on a square, so that by turning the index round the plate, the rod may also turn in the sockets, and of course carry the palate D round with it; the little index always pointing in a direction with the face of the palate. The small compass plate should not be fastened to the top of the socket, but only fitted tightly on, that it may be moveable at pleasure. Suppose then the intended port to bear S. W. from the place of departure, the palate must be turned on the socket till the south-west point thereon looks directly to the ship's bow; so that the south-west and north-east line on the compass plate may be precisely parallel with the ship's keel, and in this position the plate must remain during the whole voyage. Suppose, then, the ship to be sailing in the direct course of her intended voyage, with her bowsprit pointing south-west. Let the little index be brought to the south-west point on the compass plate, and the palate D will necessarily present its broad face toward the port of destination; and this it must always be made to do, be the ship's course what it may. If, on account of unfavourable winds, the ship is obliged to deviate from her intended course, the little index must be moved so many points from the south-west

Ship.

Ship.

line of the compass plate as the compass in the binnacle shall show that she deviates from her true course; so that in whatever direction the ship shall sail, the palate D will always look full to the south-west point of the horizon, or towards the port of destination, and consequently will present only an oblique surface to the resisting medium, more or less oblique as the ship deviates more or less from the true course of her voyage. As, therefore, the resistance of the water will operate less upon the palate in an oblique than in a direct position, in exact proportion to its obliquity, the index H will not show how many knots the vessel runs in her then course, but will indicate how many she gains in the direct line of her intended voyage.—Thus, in fig. 9. if the ship's course lies in the direction of the line AB, but she can sail by the wind no nearer than AC; suppose, then, her progressive motion such as to perform AC equal to five knots or miles in an hour, yet the index H will only point to four knots on the graduated arch, because she gains no more than at that rate on the true line of her voyage, viz. from A to B. Thus will the difference between her real motion and that pointed out by the index be always in proportion to her deviation from her intended port, until she sails in a line at right angles therewith, as AD; in which case the palate would present only a thin sharp edge to the resisting medium, the pressure of which should not be sufficient to overcome the friction of the machine and the bearing of the spring L. So that at whatever rate the ship may sail on that line, yet the index will not be affected, showing that she gains nothing on her true course. In this case, and also when the vessel is not under way, the action of the spring L should cause the index to point at O, as represented by the dotted lines in fig. 5. and 8.

As the truth of this instrument must depend on the equal pressure of the resisting medium upon the palate D, according to the ship's velocity, and the proportionable action of the spring L, there should be a pin or screw at the joints C and F, so that the rod may be readily unshipped and taken in, in order to clean the palate from any foulness it may contract, which would greatly increase its operation on the index H, and thereby render the graduated arch false and uncertain.

Further, the spring L may be exposed too much to injury from the salt water, if fixed on the outside of the ship's bow. To remedy this, it may be brought under cover, by constructing the machine as represented by fig. 8. where AB is the rod, C the fulcrum or centre of its motion, D the palate, E the horizontal arm leading through a small hole into the fore-castle; M is a strong chain fastened at one end to the arm E, and at the other to a rim or barrel on the wheel G, which by means of its teeth gives motion to the semicircle I and index H. The spring L is spiral, and enclosed in a box or barrel, like the main spring of a watch. A small chain is fixed to, and passing round the barrel, is fastened by the other end to the fuzee W. This fuzee is connected by its teeth with the wheel G, and counteracts the motion of the palate D. N, N, are the two sockets through which the rod AB passes, and in which it is turned round by means of the little index R. S is the small compass plate, moveable on the top of the upper socket N. The plate S hath an upright rim round its edge, cut into teeth or notches, so that when the index R is a little raised up, in order to bring it

round to any intended point, it may fall into one of these notches, and be detained there; otherwise the pressure of the water will force the palate D from its oblique position, and turn the rod and index round to the direction in which the ship shall be then sailing.—Should it be apprehended that the palate D, being placed so far forward, may affect the ship's steering, or obstruct her rate of sailing, it should be considered that a very small plate will be sufficient to work the machine, as one of three or four inches in diameter would probably be sufficient, and yet not large enough to have any sensible effect on the helm or ship's way.

The greatest difficulty, perhaps, will be in graduating the arch K, (if the machine is constructed as in fig. 5.); the unequal divisions of which can only be ascertained by actual experiment on board of each ship respectively, inasmuch as the accuracy of these graduations will depend on three circumstances, viz. the position of the fulcrum C with respect to the length of the rod, the size of the palate D, and the strength or bearing of the spring L. When these graduations, however, are once ascertained for the machine on board of any one vessel, they will not want any future alterations, provided the palate D be kept clean, and the spring L retains its elasticity.

But the unequal divisions of the graduated arch will be unnecessary, if the machine is constructed as in fig. 8.; for as the chain goes round the barrel L, and then winds through the spiral channel of the fuzee W, the force of the main spring must operate equally, or nearly so, in all positions of the index, and consequently the divisions of the arch K may in such case be equal.

After all, it is not expected that a ship's longitude can be determined to a mathematical certainty by this instrument. The irregular motions and impulses to which a ship is continually exposed, make such an accuracy unattainable perhaps by any machinery: But if it should be found, as we flatter ourselves it will on fair experiment, that it answers the purpose much better than the common log, it may be considered as an acquisition to the art of navigation.

It should be observed, that in ascertaining a ship's longitude by a time-piece, this great inconvenience occurs, that a small and trifling mistake in the time makes a very great and dangerous error in the distance run: Whereas the errors of this machine will operate no farther than their real amount; which can never be great or dangerous, if corrected by the usual observations made by mariners for correcting the common log.

A like machine, made in its simple form (as at fig. 5.), so constructed as to ship and unship, might occasionally be applied alongside about midships, in order to ascertain the leeway; which, if rightly shown, will give the ship's precise longitude. As to sea currents, this and all other machines hitherto invented must be subject to their influence; and proper allowances must be made according to the skill and knowledge of the navigator.

Lastly, some discretion will be necessary in taking observations from the machine to be entered on the log-book: that is, the most favourable and equitable moment should be chosen for the observation; not whilst the ship is rapidly descending the declivity of a wave, or is suddenly checked by a stroke of the sea, or is in the very act of plunging. In all cases, periods may be found in which a ship proceeds with a true average velocity;

Ship.

velocity; to discover which, a little experience and attention will lead the skilful mariner (A).

SHIRAZU. See SCHIRAS.

SHIRE, is a Saxon word signifying a division; but a county, *comitatus*, of the same import, is plainly derived from *comes*, "the count of the Franks;" that is, the earl or alderman (as the Saxons called him) of the shire, to whom the government of it was entrusted. This he usually exercised by his deputy, still called in Latin *vice-comes*, and in English the *sheriff*, *shrieve*, or *shire reeve*, signifying the "officer of the shire;" upon whom, in process of time, the civil administration of it totally devolved. In some counties there is an intermediate division between the shire and the hundred; as lathes in Kent and rapes in Sussex, each of them containing about three or four hundreds apiece. These had formerly their *lathe-reeves* and *rape-reeves*, acting in subordination to the *shire-reeve*. Where a county is divided into three of these intermediate jurisdictions, they are called *trithings*, which were anciently governed by a *trithing reeve*. These trithings still subsist in the large county of York, where, by an early corruption, they are denominated *ridings*; the north, the east, and the west riding.

SHIRL, or COCKLE, in mineralogy. See COCKLE.

SHIRT, a loose garment, commonly of linen, worn next the body.—Some doubt the propriety of changing the linen when a person is sick. Clean linen promotes perspiration; and it may be renewed as often as the patient pleases, whether the disorder be of the acute or the chronic kind. Except during a crisis in fevers, whilst the patient is in a sweat, a change of linen, if well dried and warmed, may be daily used.

Shirts were not worn by Jews, Greeks, or Romans, but their place was supplied by thin *tunica* of wool. The want of linen among the ancients made frequent washings and ablutions necessary.

SHIVER. See SCHISTUS and SHALE.

SHIVERS, in the sea language, names given to the little rollers, or round wheels of pulleys.

SHOAD, among miners, denotes a train of metalline stones, serving to direct them in the discovery of mines.

SHOAD-STONES, a term used by the miners of Cornwall and other parts of this kingdom, to express such loose masses of stone as are usually found about the entrances into mines, sometimes running in a straight course from the load or vein of ore to the surface of the earth.

These are stones of the common kinds, appearing to have been pieces broken from the strata or larger masses; but they usually contain mundic, or marcasitic matter, and more or less of the ore to be found in the mine. They appear to have been at some time rolled about in water, their corners being broken off, and their surface smoothed and rounded.

The antimony mines in Cornwall are always easily discovered by the shoad-stones, these usually lying up to

the surface, or very nearly so; and the matter of the stone being a white spar, or debased crystal, in which the native colour of the ore, which is a shining bluish black, easily discovers itself in streaks and threads.

Shoad-stones are of so many kinds, and of such various appearances, that it is not easy to describe or know them: but the miners, to whom they are of greatest use in the tracing or searching after new mines, distinguish them from other stones by their weight; for if very ponderous, though they look ever so much like common stones, there is great reason to suspect that they contain some metal. Another mark of them is their being spongy and porous; this is a sign of especial use in the tin countries; for the tin shoad-stones are often so porous and spongy, that they resemble large bodies thoroughly calcined. There are many other appearances of tin shoads, the very hardest and firmest stones often containing this metal.

When the miners, in tracing a shoad up hill, meet with such odd stones and earths that they know not well what to make of them, they have recourse to vanishing, that is, they calcine and powder the stone, clay, or whatever else is supposed to contain the metal; and then washing it in an instrument, prepared for that purpose, and called a *vanning shovel*, they find the earthy matter washed away, and of the remainder, the stony or gravelly matter lies behind, and the metalline matter at the point of the shovel. If the person who performs this operation has any judgment, he easily discovers not only what the metal is that is contained in the shoad, but also will make a very probable guess at what quantity the mine is likely to yield of it in proportion to the ore.

SHOAL, in the sea-language, denotes a place where the water is shallow; and likewise a great quantity of fishes, such as a *shoal of herrings*.

SHOCK, in electricity. The effect of the explosion of a charged body, that is, the discharge of its electricity on any other body, is called the *electric shock*.

SHOE, a covering for the foot, usually of leather.

SHOES, among the Jews, were made of leather, linen, rush, or wood; those of soldiers were sometimes of brass or iron. They were tied with thongs which passed under the soles of the feet. To put off their shoes was an act of veneration; it was also a sign of mourning and humiliation: to bear one's shoes, or to untie the lachets of them, was considered as the meanest service.

Among the Greeks shoes of various kinds were used. Sandals were worn by women of distinction. The Lacedemonians wore red shoes. The Grecian shoes generally reached to the middle of the leg. The Romans used two kinds of shoes; the *calceus*, which covered the whole foot somewhat like our shoes, and was tied above with lachets or strings; and the *salea* or slipper, which covered only the sole of the foot, and was fastened with leathern thongs. The *calceus* was always worn  
along

Shoad  
||  
Shoes.

(A) An ingenious mechanic would probably construct this machine to better advantage in many respects. The author only meant to suggest the principle; experiment alone can point out the best method of applying it. He is sensible of at least of one deficiency, viz. that the little index R, fig. 4. will not be strong enough to retain the palate D in an oblique position when the ship is sailing by the wind; more especially as the compass plate S, in whose notched rim the index R is to fall, is not fixed to, but only fitted tight on the socket N. Many means, however, might be contrived to remedy this inconvenience.

along with the *toga* when a person went abroad: slippers were put on during a journey and at feasts, but it was reckoned effeminate to appear in public with them. Black shoes were worn by the citizens of ordinary rank, and white ones by the women. Red shoes were sometimes worn by the ladies, and purple ones by the coxcombs of the other sex. Red shoes were put on by the chief magistrates of Rome on days of ceremony and triumphs. The shoes of senators, patricians, and their children, had a crescent upon them which served for a buckle; these were called *calcei lunati*. Slaves wore no shoes; hence they were called *cretati* from their duty feet. Phocion also and Cato Uticensis went without shoes. The toes of the Roman shoes were turned up in the point; hence they were called *calcei rostrati*, *repandi*, &c.

In the 9th and 10th centuries the greatest princes of Europe wore wooden shoes, or the upper part of leather and the sole of wood. In the reign of William Rufus, a great beau, Robert, surnamed *the horned*, used shoes with long sharp points, stuffed with tow, and twisted like a ram's horn. It is said the clergy, being highly offended, declaimed against the long-pointed shoes with great vehemence. The points, however, continued to increase till, in the reign of Richard II. they were of so enormous a length that they were tied to the knees with chains sometimes of gold, sometimes of silver. The upper parts of these shoes in Chaucer's time were cut in imitation of a church window. The long-pointed shoes were called *crackowes*, and continued in fashion for three centuries in spite of the bulls of popes, the decrees of councils, and the declamations of the clergy. At length the parliament of England interposed by an act A. D. 1463, prohibiting the use of shoes or boots with pikes exceeding two inches in length, and prohibiting all shoemakers from making shoes or boots with longer pikes under severe penalties. But even this was not sufficient: it was necessary to denounce the dreadful sentence of excommunication against all who wore shoes or boots with points longer than two inches. The present fashion of shoes was introduced in 1633, but the buckle was not used till 1670.

In Norway they use shoes of a particular construction, consisting of two pieces, and without heels; in which the upper leather fits close to the foot, the sole being joined to it by many plaits or folds.

The shoes or slippers of the Japanese, as we are informed by Professor Thunberg, are made of rice-straw woven, but sometimes for people of distinction of fine slips of ratan. The shoe consists of a sole, without upper leather or hind-piece; forwards it is crossed by a strap, of the thickness of one's finger, which is lined with linen; from the tip of the shoe to the strap a cylindrical string is carried, which passes between the great and second toe, and keeps the shoe fast on the foot. As these shoes have no hind-piece, they make a noise, when people walk in them like slippers. When the Japanese travel, their shoes are furnished with three strings made of twisted straw, with which they are tied to the legs and feet, to prevent them from falling off. Some people carry one or more pairs of shoes with them on their journeys, in order to put on new, when the old ones are worn out. When it rains, or the roads are very dirty, these shoes are soon wetted through, and one

continually sees a great number of worn-out shoes lying on the roads, especially near the brooks, where travellers have changed their shoes after washing their feet. Instead of these, in rainy or dirty weather they wear high wooden clogs, which underneath are hollowed out in the middle, and at top have a band across like a stirrup, and a string for the great toe; so that they can walk without soiling their feet. Some of them have their straw shoes fastened to these wooden clogs. The Japanese never enter their houses with their shoes on; but leave them in the entry, or place them on the bench near the door, and thus are always barefooted in their houses, so as not to dirty their neat mats. During the time that the Dutch live at Japan, when they are sometimes under an obligation of paying visits at the houses of the Japanese, their own rooms at the factory being likewise covered with mats of this kind, they wear, instead of the usual shoes, red, green, or black slippers, which on entering the house they pull off: however, they have stockings on, and shoes made of cotton stuff with buckles in them, which shoes are made at Japan, and can be washed whenever they are dirty. Some have them of black fattin, in order to avoid washing them.

*SHOE of an Anchor*, a small block of wood, convex on the back, and having a small hole, sufficient to contain the point of the anchor fluke, on the fore-side. It is used to prevent the anchor from tearing or wounding the planks on the ship's bow, when ascending or descending; for which purpose the shoe slides up and down along the bow between the fluke of the anchor and the planks, as being pressed close to the latter by the weight of the former.

*To SHOE an Anchor*, is to cover the flukes with a broad triangular piece of plank, whose area or superficies is much larger than that of the flukes. It is intended to give the anchor a stronger and surer hold of the bottom in very soft and oozy ground.

*HORSE-SHOE*. See FARRIERY, Sect. 47.

SHOOTING, in the military art. See ARTILLERY, GUNNERY, and PROJECTILES.

SHOOTING, in sportsmanship, the killing of game by the gun, with or without the help of dogs.

Under this article we shall lay down all the rules which are necessary to be observed in order to render one accomplished and successful in the art of shooting.

The first thing which the sportsman ought to attend to is the choice of his fowling-piece. Convenience requires that the barrel be as light as possible, at the same time it ought to possess that degree of strength which will make it not liable to burst. Experience has proved, that a thin and light barrel, which is of equal thickness in every part of its circumference, is much less liable to burst than one which is considerably thicker and heavier, but which, from being badly filed or bored, is of unequal strength in different places.

It is also of importance to determine of what length the barrel ought to be, in order to acquire that range which the sportsman has occasion for. On this subject we have received the following information from an experienced sportsman. We have, at different times, compared barrels of all the intermediate lengths between 28 and 40 inches, and of nearly the same caliber, that is to say, from 22 to 26; and these trials were

ing. made both by firing the pieces from the shoulder, and from a firm block, at an equal distance, and with equal weights of the same powder and of the same shot.

To avoid every possibility of error, the quires of paper at which we fired were fixed against planks instead of being placed against the wall. From these trials frequently repeated, we found that the shot pierced an equal number of sheets, whether it was fired from a barrel of 28, 30, 32, 34, 36, 38, or 40, inches in length. Nay more, we have compared two barrels of the same caliber, but one of them 33, and the other 66 inches long, by repeatedly firing them in the same manner as the others, at different distances, from 45 to 100 paces, and the results have always been the same, *i. e.* the barrel of 33 inches drove its shot through as many sheets of paper as that of 66 did. The conclusion from all this is, that the difference of 10 inches in the length of the barrel, which seems to be more than is ever insisted upon among sportsmen, produces no sensible difference in the range of the piece; and therefore, that every one may please himself in the length of his barrel, without either detriment or advantage to the range.

It may appear as an objection to this, that a duck-gun which is five or six feet long kills at a greater distance than a fowling-piece; but this is not owing to its length, but to its greater weight and thickness, which give it such additional strength, that the shot may be increased, and the charge of powder doubled, trebled, and even quadrupled. But a barrel of five or six feet length would be very inconvenient for fowling. Those who consult the appearance of the piece, lightness, and the ease with which it is managed, will find that a barrel from 32 to 38 inches will answer best.

The next thing to be considered is, of what dimensions the caliber or bore of a fowling-piece ought to be. This matter has been subjected to experiment, and it has been found, that a barrel of 22 or 24, which is the largest caliber usually employed in fowling-pieces, throws its shot as closely as one of the smallest caliber, *viz.* of 30 or 32 (A).

As to the length and form of the stock, it may be laid down as a principle, that a long stock is preferable to a short one, and at the same time rather more bent than usual; for a long stock fits firmer to the shoulder than a short one, and particularly so when the shooter is accustomed to place his left hand, which principally supports the piece, near to the entrance of the ramrod into the stock.

It is certain, however, that the stock may be so formed as to be better suited to one man than another. For a tall, long-armed man, the stock of a gun should be longer than for one of a less stature and shorter arm. That a straight stock is proper for him who has high shoulders and a short neck; for, if it be much bent, it would be very difficult for him, especially in the quick motion required in shooting at a flying or running object, to place the butt of the gun-stock firmly to the shoulder, the upper part alone would in general be fixed; which would not only raise the muzzle, and consequently shoot high, but make the recoil much more sensibly felt, than if the whole end of the stock were

firmly placed on his shoulder. Besides, supposing the shooter to bring the butt home to his shoulder, he would scarcely be able to level his piece at the object. On the contrary, a man with low shoulders, and a long neck, requires a stock much bent; for if it is straight, he will, in the act of lowering his head to that place of the stock at which his cheek should rest in taking aim, feel a constraint which he never experiences, when by the effect of the proper degree of bent, the stock lends him some assistance, and, as it were, meets his aim half way.

Having now described the fowling-piece which has been found to answer best, it will next be proper to give some instructions for the choice of gunpowder, shot, and wadding.

The various kinds of gunpowder are well known; <sup>6</sup> but in the opinion of some experienced sportsmen, <sup>Best gun-</sup> Hervey's battle-powder is the best. Those who wish to examine the strength of powder, may determine it by drying some of it very well, and then trying how many sheets of paper it will drive the shot through, at the distance of 10 or 12 yards. In this trial we should be careful to employ the same sized shot in each experiment, the quantity both of the shot and the powder being regulated by exact weight; otherwise we cannot, even in this experiment, arrive to any certainty in comparing the strength of different powders, or of the same powder at different times.

Powder ought to be kept very dry, for every degree <sup>7</sup> of moisture injures it; and if considerable, the saltpetre dry. is dissolved, and the intimate combination of the several ingredients is entirely destroyed. It is observed, that after firing with damp powder the piece becomes very foul, which seems to arise from the diminution of the activity of the fire in the explosion. Flasks of copper or tin are much better for keeping powder in than those made of leather, or than small casks. Their necks ought to be small and well stopped with cork.

The *patent milled shot* is now very generally used, and <sup>8</sup> is reckoned superior to any other. The size of the shot. shot must vary according to the particular species of game which is the object of the sportsman's pursuit, as well as be adapted to the season. In the first month of partridge shooting, N<sup>o</sup> 1. is most proper; for since at this time the birds spring near at hand, and we seldom fire at more than the distance of 40 paces, if the shooter takes his aim but tolerably well, it is almost impossible for a bird at this distance to escape in the circle which the shot forms.

As hares sit closer, and are thinly covered with fur at this season, they may easily be killed with this shot at 30 or 35 paces. N<sup>o</sup> 1. is equally proper for shooting snipes or quails. About the beginning of October, when the partridges are stronger, N<sup>o</sup> 3. is the most proper shot to be used. Many sportsmen use no other during the whole season. The directions which have now been given refer only to the patent shot.

We shall now subjoin a table, which will show at one view the number of pellets composing an ounce weight of each sort of shot, the patent and the common, beginning with the smallest size.

PATENT.

(A) In speaking of the size of the caliber, we mean by 22 or 24, that so many balls exactly fitting it weigh just one pound; and every caliber is marked in the same way.

Shooting.

		PATENT SHOT.		
Shooting.	N <sup>o</sup> 8.	1 ounce	-	620
		7 id.	-	480
		X (B) id.	-	300
		1 id.	-	220
		2 id.	-	180
	3 id.	-	157	
	4 id.	-	105	
	5 id.	-	83	
		COMMON SHOT.		
	N <sup>o</sup> 7.	1 ounce	-	350
		6 id.	-	260
		5 id.	-	235
		4 id.	-	190
		3 id.	-	140
		2 id.	-	110
		1 id.	-	95

9 For a fowling-piece of a common caliber, which is from 24 to 30 balls to the pound weight, a dram and a quarter, or at most a dram and a half, of good powder; and an ounce, or an ounce and a quarter of shot, is sufficient. But when shot of a larger size is used, such as N<sup>o</sup> 5, the charge of shot may be increased one-fourth, for the purpose of counterbalancing in some degree what the size of the shot loses in the number of pellets, and also to enable it to garnish the more. For this purpose the sportsman will find a measure marked with the proper gauges very convenient to him. An instrument of this nature has been made by an ingenious artificer of London, Egg, of the Haymarket.

A consequence of overloading with shot, is the powder has not sufficient strength to throw it to its proper distance; for if the object fired at be distant, one-half of the pellets composing the charge, by their too great quantity and weight, will strike against each other, and fall by the way; and those which reach the mark will have small force, and will produce but little or no effect.

10 Wadding. The use of the *wadding* is to carry the shot in a body to a certain distance from the muzzle of the piece. It ought to be of soft and pliable materials. The best kind of wadding, in the opinion of an experienced fowler, is a piece of an old hat; but this cannot be obtained in sufficient quantity. Next to it nothing is better than soft brown paper, which combines suppleness with confidence, moulds itself to the barrel, and never falls to the ground within 12 or 15 paces from the muzzle of the piece. Two answers very well, and cork has been extolled for possessing the peculiar virtue of increasing the range and closeness of the shot.

The wadding ought to be quite close in the barrel, but not rammed too hard; for if it be rammed too close, or be of a rigid substance, the piece will recoil, and the shot will spread too much. On the other hand, if the wadding be very loose, or is composed of too soft materials, such as wool or cotton, the discharge will not possess proper force.

21 Powder and shot to be slightly rammed down. In loading a piece, the powder ought to be slightly rammed down by only pressing the ramrod two or three times on the wadding, and not by drawing up the ramrod and then returning it into the barrel with a jerk of

the arm several times. For when the powder is violently compressed, some of the grains must be bruised, which will prevent the explosion from being quick, and will spread the shot too wide. In pouring the powder into the barrel, the measure ought to be held so as that the powder may fall most readily to the bottom. That no grains may adhere to the sides of the barrel, the butt-end of the piece may be struck against the ground. The shot ought never to be rammed down with force: it is sufficient to strike the butt-end of the gun against the ground as before. Then the wadding is to be put down gently. A sportsman ought never to carry his gun under his arm with the muzzle inclined downwards, for this practice loosens the wadding and charge too much.

12 Immediately after the piece is fired it ought to be reloaded; for while the barrel is still warm, there is no danger of any moisture lodging in it to hinder the powder from falling to the bottom. As it is found that the coldness of the barrel, and perhaps the moisture condensed in it, diminishes the force of the powder in the first shot; it is proper to fire off a little powder before the piece is loaded. Some prime before loading, but this is not proper unless the touch-hole be very large. After every discharge the touch-hole ought to be pricked, or a small feather may be inserted to clear away any humidity or foulness that has been contracted.

The sportsman having loaded his piece, must next prepare to fire. For this purpose he ought to place his hand near the entrance of the ramrod, and at the same time grasp the barrel firmly. The muzzle should be a little elevated, for it is more usual to shoot low than high. This direction ought particularly to be attended to when the object is a little distant; because shot as well as ball only moves a certain distance point blank, when it begins to describe the curve of the parabola.

13 Practice soon teaches the sportsman the proper distance at which he should shoot. The distance at which he ought infallibly to kill any kind of game with patent shot, N<sup>o</sup> 3, provided the aim be well taken, is from 25 to 35 paces for the footed, and from 40 to 45 paces for the winged, game. Beyond this distance even to 50 or 55 paces, both partridges and hares are sometimes killed; but in general the hares are only slightly wounded, and carry away the shot; and the partridges at that distance present so small a surface, that they frequently escape untouched between the spaces of the circle. Yet it does not follow that a partridge may not be killed with N<sup>o</sup> 3 patent shot at 60 and even 70 paces distance, but then these shots are very rare.

14 In shooting at a bird flying, or a hare running across, it is necessary to take aim before the object in proportion to its distance at the time of firing. If a partridge flies across at the distance of 30 or 35 paces, it will be sufficient to aim at the head, or at most but a small space before it. If it be 50, 60, or 70 paces distant, it is then requisite to aim at least half a foot before the head. The same practice ought to be observed in shooting at a hare, rabbit, or fox, when running in a cross direction; at the same time making due allowance for

(B) The reader will observe, that the patent shot has no N<sup>o</sup> 6. the X being substituted in its place, and that the numbers do not follow each other in the order of progression: the reason of this we cannot assign.

ng for the distance and swiftness of the pace. Another thing to be attended to is, that the shooter ought not involuntarily to stop the motion of the arms at the moment of pulling the trigger; for the instant the hand stops in order to fire, however inconsiderable the time be, the bird gets beyond the line of aim, and the shot will miss it. A sportsman ought therefore to accustom his hand while he is taking aim to follow the object. When a hare runs in a straight line from the shooter, he should take his aim between the ears, otherwise he will run the hazard either of missing, or at least not of killing dead, or as it is sometimes called *clean*.

A fowling-piece should not be fired more than 20 or 25 times without being washed; a barrel when foul neither shoots so ready, nor carries the shot so far as when clean. The flint, pan, and hammer, should be well wiped after each shot; this contributes greatly to make the piece go off quick, but then it should be done with such expedition, that the barrel may be reloaded whilst warm, for the reasons we have before advanced. The flint should be frequently changed, without waiting until it misses fire, before a new one is put in. Fifteen or eighteen shots, therefore, should only be fired with the same flint; the expence is too trifling to be regarded, and by changing it thus often much vexation will be prevented.

A gun also should never be fired with the prime of the preceding day; it may happen that an old priming will sometimes go off well, but it will more frequently contract moisture and fuze in the firing; then the object will most probably be missed, and that because the piece was not fresh primed.

For the information of the young sportsman we shall add a few more general directions. In warm weather he ought to seek for game in plains and open grounds, and in cold weather he may search little hills exposed to the sun, along hedges among heath, in stubbles, and in pastures where there is much furze and fern. The morning is the best time of the day, before the dew is exhaled, and before the game has been disturbed. The colour of the shooters dress ought to be the same with that of the fields and trees; in summer it ought to be green, in winter a dark grey. He ought to hunt as much as possible with the wind, not only to prevent the game from perceiving the approach of him and his dog, but also to enable the dog to scent the game at a greater distance.

He should never be discouraged from hunting and ranging the same ground over and over again, especially in places covered with heath, brambles, high grass, or young coppice wood. A hare or rabbit will frequently suffer him to pass several times within a few yards of its form without getting up. He should be still more patient when he has marked partridges into such places, for it often happens, that after the birds have been sprung many times, they lie so dead that they will suffer him almost to tread upon them before they will rise. Pheasants, quails, and woodcocks do the same.

He ought to look carefully about him, never passing a bush or tuft of grass without examination; but he ought never to strike them with the muzzle of his gun for it will loosen his wadding. He who patiently beats and ranges his ground over again, without being disc-

couraged, will always kill the greatest quantity of Shooting game; and if he is shooting in company, he will find game where others have passed without discovering any.

When he has fired he should call in his dog, that he may not have the mortification to see game rise which he cannot shoot. When he has killed a bird, instead of being anxious about picking it up, he ought to follow the rest of the covey with his eye till he see them settle.

Three species of dogs are capable of receiving the proper instruction, and of being trained. These are the smooth pointer, the spaniel, and the rough pointer. The last is a dog with long curled hair, and seems to be a mixed breed of the water-dog and the spaniel. The smooth pointer is active and lively enough in his range, but in general is proper only for an open country.

The greatest part of these dogs are afraid of water, brambles, and thickets; but the spaniel and the rough pointer are easily taught to take the water, even in cold weather, and to range the woods and rough places as well as the plain. Greater dependence may therefore be had on these two last species of dogs than on the smooth pointer.

The education of a pointer may commence when he is only five or six months old. The only lessons which he can be taught at this time are to *fetch* and *carry* any thing when desired; to come in when he runs far off, and to go behind when he returns; using, in the one case, the words *here, come in*, and in the other *back* or *behind*. It is also necessary at this period to accustom him to be tied up in the kennel or stable; but he ought not at first to be tied too long. He should be let loose in the morning, and fastened again in the evening. When a dog is not early accustomed to be chained, he disturbs every person in the neighbourhood by howling. It is also of importance that the person who is to train him should give him his food.

When the dog has attained the age of 10 or 12 months, he may be carried into the field to be regularly trained. At first he may be allowed to follow his own inclination, and to run after every animal he sees. His indiscriminating eagerness will soon abate, and he will pursue only partridges and hares. He will soon become tired of following partridges in vain, and will content himself after having flushed them to follow them with his eyes. It will be more difficult to prevent him from following hares.

All young dogs are apt to *rake*; that is, to hunt with their noses close to the ground, to follow birds rather by the track than by the wind. But partridges lie much better to dogs that *wind* them, than to those that follow them by the track. The dog that winds the scent approaches the birds by degrees and without disturbing them; but they are immediately alarmed when they see a dog tracing their footsteps. When you perceive that your dog is committing this fault, call to him in an angry tone *hold up*: he will then grow uneasy and agitated, going first to the one side and then to the other, until the wind brings him the scent of the birds. After finding the *game* four or five times in this way, he will take the wind of himself, and hunt with his nose high. If it be difficult to correct this fault, it will be necessary to put the *puzzle peg* upon him. This is of very simple construction, consisting

**Shooting.** only of a piece of oak or deal inch board, one foot in length, and an inch and a half in breadth, tapering a little to one end; at the broader end are two holes running longitudinally, through which the collar of the dog is put, and the whole is buckled round his neck; the piece of wood being projected beyond his nose, is then fastened with a piece of leather thong to his under jaw. By this means the peg advancing seven or eight inches beyond his front, the dog is prevented from putting his nose to the ground and raking.

As soon as the young dog knows his game you must bring him under complete subjection. If he is tractable, this will be easy; but if he is stubborn, it will be necessary to use the *trough cord*, which is a rope or cord of 20 or 25 fathoms in length fastened to his collar. If he refuse to come back when called upon, you must check him smartly with the cord, which will often bring him upon his haunches. But be sure you never call to him except when you are within reach of the cord. After repeating this several times he will not fail to come back when called; he ought then to be caressed, and a bit of bread should be given him. He ought now constantly to be tied up, and never unchained, except when you give him his food, and even then only when he has done something to deserve it.

The next step will be to throw down a piece of bread on the ground, at the same moment taking hold of the dog by the collar, calling out to him, "take heed,—softly." After having held him in this manner for some space of time, say to him, "seize—lay hold." If he is impatient to lay hold of the piece of bread before the signal is given, correct him gently with a small whip. Repeat this lesson until he "takes heed" well, and no longer requires to be held fast to prevent him from laying hold of the bread. When he is well accustomed to this manège, turn the bread with a flick, holding it in the manner you do a fowling-piece, and having done so, cry *seize*. Never suffer the dog to eat either in the house or field without having first made him take heed in this manner.

Then, in order to apply this lesson to the game, fry small pieces of bread in hogs-lard, with the dung or partridge; take these in a linen bag into the fields, stubbles, ploughed grounds, and pastures, and there put the pieces in several different places, marking the spots with little cleft pickets of wood, which will be rendered more distinguishable by putting pieces of card in the nocks. This being done, cast off the dog and conduct him to these places, always hunting in the wind. After he has caught the scent of the bread, if he approaches too near, and seems eager to fall upon it, cry to him in a menacing tone, "take heed;" and if he does not stop immediately, correct him with the whip. He will soon comprehend what is required of him, and will stand.

At the next lesson, take your gun charged only with powder, walk gently round the piece of bread once or twice, and fire instead of crying *seize*. The next time of practising this lesson, walk round the bread four or five times, but in a greater circle than before, and continue to do this, until the dog is conquered of his impatience, and will stand without moving until the signal is given him. When he keeps his point well, and stands steady in this lesson, you may carry him to the birds; if he runs in upon them, or barks when they spring up, you must cor-

rect him; and if he continues to do so, you must return to the fried bread; but this is seldom necessary.

When the dog has learned by this use of the bread to take heed, he may be carried to the fields with the trash-cord dragging on the ground. When he springs birds for the first time, if he runs after them or barks, check him by calling out to him, *take heed*. If he point properly, caress him; but you ought never to hunt without the cord until he point staunch.

If the dog runs after sheep, and it be difficult to cure him, couple him with a ram, and then whip the dog as long as you can follow him. His cries will at first alarm the ram; he will run with all his speed, and drag the dog along with him; but he will at length take courage, turn upon the dog, and butt him severely with his horns. When you think the dog is sufficiently chastised, untie him: he will never run at sheep again.

Having now given a few general instructions concerning the best method of training pointers, we shall subjoin a few observations respecting the most common species of game, the partridge, pheasant, grouse, woodcock, snipe, and wild duck.

Partridges pair in the spring, and lay their eggs (generally from 15 to 20) during May and part of June. The young begin to fly about the end of June, and their plumage is complete in the beginning of October. The male has a conspicuous horseshoe upon his breast, an obtuse spur on the hinder part of the leg, which distinguishes him from the female. He is also rather larger.

When a sportsman is shooting in a country where the birds are thin, and he no longer chooses to range the field for the bare chance of meeting with them, the following method will show him where to find them on another day. In the evening, from sun-set to night-fall, he should post himself in a field, at the foot of a tree or a bush, and there wait until the partridge begin to call or juck, which they always do at that time; not only for the purpose of drawing together when separated, but also when the birds composing the covey are not dispersed. After calling in this manner for some little space of time, the partridges will take to flight; then, if he mark the place where they alight, he may be assured they will lie there the whole night, unless disturbed. Let him return to the same post the next morning by break of day, and there watch a while; being careful to keep his dog in a string, if he is not under perfect command.

As soon as the dawn begins to peep, the partridges will begin to call, and soon afterwards will perform the same manœuvre as on the preceding evening; that is, after having called a while, they will take their flight, and will most commonly settle at a little distance. There in a few minutes they will call again, and sometimes take a second flight, but that will be to no great distance. Then as soon as the sun is risen, and the sportsman can see to shoot, he may cast off his dog and pursue them.

The *pheasant* is of the size of a common dunhill Plover, and lays its eggs generally in the woods, the number of which is 10 or 12.

Pheasants are accounted stupid birds; for when they are surprised they will frequently squat down like a rabbit, supposing themselves to be in safety as soon as their heads



heads are concealed; and in this way they will sometimes suffer themselves to be killed with a stick. They love low and moist places, and haunt the edges of those pools which are found in woods, as well as the high grafs of marshes that are near at hand; and above all, places where there are clumps of alders.

*Grouse*, or muir-game, are found in Wales, in the northern counties of England, and in great abundance in Scotland. They chiefly inhabit those mountains and muirs which are covered with heath, and seldom descend to the low grounds. They fly in companies of four or five braces, and love to frequent mossy places, particularly in the middle of the day or when the weather is warm. In pursuing this game, when the pointer sets, and the sportsman perceives the birds running with their heads erect, he must run after them as fast as he can, in the hope that he may get near enough to shoot when they rise upon the wing; for he may be pretty certain they will not lie well that day. As these birds are apt to grow soon putrid, they ought to be drawn carefully the instant they are shot and stuffed with any heath, and if the feathers happen to be wetted they must be wiped dry.

The *woodcock* is a bird of passage; it commonly arrives about the end of October, and remains until the middle of March. Woodcocks are fattest in December and January, but from the end of February they are lean. At their arrival they drop anywhere, but afterwards take up their residence in coples of nine or ten years growth. They seldom, however, stay in one place longer than 12 or 15 days. During the day they remain in those parts of the woods where there are void spaces or glades, picking up earth-worms and grubs from the fallen leaves. In the evening they go to drink and wash their bills at pools and springs, after which they repair to the open fields and meadows for the night. It is remarkable, that when a woodcock springs from a wood to go into the open country, he always endeavours to find some glade or opening, which he follows to the boundaries of the wood. At his return he pursues the same path a good way, and then turns to the right or left opposite to some glade, in order to drop into a thick part of the wood, where he may be sheltered from the wind. He may therefore be watched with advantage in these narrow passes and little alleys on the edges of woods which lead to a pool or spring, or he may be watched in the dusk of the evening near the pools which he frequents.

The *snipe* is a bird of passage as well as the woodcock. This bird is scarcely worth shooting till the frost commences. In the month of November they begin to grow fat. Snipes, like woodcocks, frequent springs, bogs, and marshy places, and generally fly against the wind. The slant and cross shots are rather difficult, as the birds are small and fly very quickly. The sportsman ought to look for them in the direction of the wind; because then they will fly towards him, and present a fairer mark.

The *wild duck* is also a bird of passage, and arrives here in great flocks from the northern countries in the beginning of winter. Still, however, a great many remain in our marshes and fens during the whole year, and breed.

The wild duck differs little in plumage from the tame duck, but is easily distinguished by its size, which is less; by the neck, which is more slender; by the foot,

which is smaller; by the nails, which are more black; and above all, by the web of the foot, which is much finer and softer to the touch. Shooting  
||  
Shore.

In the summer season, when it is known that a team of young ducks are in a particular piece of water, and just beginning to fly, the sportsman is sure to find them early in the morning dabbling at the edges of the pool, and amongst the long grafs, and then he may get very near to them: it is usual also to find them in those places at noon.

In the beginning of autumn almost every pool is frequented by teams of wild ducks, which remain there during the day, concealed in the rushes. If these pools are of small extent, two shooters, by going one on each side, making a noise and throwing stones into the rushes, will make them fly up; and they will in this way frequently get shots, especially if the pool is not broad, and contracts at one end. But the surest and most successful way, is to launch a small boat or trow on the pool, and to traverse the rushes by the openings which are found; at the same time making as little noise as possible. In this manner the ducks will suffer the sportsmen to come sufficiently near them to shoot flying; and it often happens that the ducks, after having flown up, only make a circuit, return in a little time, and again alight upon the pool. Then the sportsmen endeavour a second time to come near them. If several shooters are in company, they should divide, two should go in the boat, whilst the others spread themselves about the edge of the pool, in order to shoot the ducks in their flight. In pools which will not admit a trow, water-spaniels are absolutely necessary for this sport.

In winter they may be found on the margins of little pools; and when pools and rivers are frozen up, they must be watched for in places where there are springs and waters which do not freeze. The sport is then much more certain, because the ducks are confined to these places in order to procure aquatic herbs, which are almost their only food at this period.

SHOP-LIFTERS, are those that steal goods privately out of shops; which, being to the value of 5s. though no person be in the shop, is felony without the benefit of clergy by the 10 and 11 W. III. c. 23.

SHORE, a place washed by the sea, or by some large river.

Count Marigli divides the sea-shore into three portions: the first of which is that track of land which the sea just reaches in storms and high tides, but which it never covers; the second part of the shore is that which is covered in high tides and storms, but is dry at other times; and the third is the descent from this, which is always covered with water.

The first part is only a continuation of the continent, and suffers no alteration from the neighbourhood of the sea, except that it is rendered fit for the growth of some plants, and wholly unfit for that of others, by the saline steams and impregnations: and it is scarce to be conceived by any, but those who have observed it, how far on land the effects of the sea reach, so as to make the earth proper for plants which will not grow without this influence; there being several plants frequently found on high hills and dry places, at three, four, and more miles from the sea, which yet would not grow unless in the neighbourhood of it, nor will ever be found elsewhere.

Shore  
||  
Short.

The second part or portion of the shore is much more affected by the sea than the former, being frequently washed and beaten by it. Its productions are rendered salt by the water, and it is covered with sand, or with the fragments of shells in form of sand, and in some places with a tartarous matter deposited from the water; the colour of this whole extent of ground is usually dusky and dull, especially where there are rocks and stones, and these covered with a slimy matter.

The third part of the shore is more affected by the sea than either of the others; and is covered with an uniform crust of the true nature of the bottom of the sea, except that plants and animals have their residence in it, and the decayed parts of these alter it a little.

SHORE (Jane), the celebrated concubine of the licentious king Edward IV. was the wife of Mr Matthew Shore, a goldsmith in Lombard street, London. Kings are seldom unsuccessful in their amorous pursuits; therefore there was nothing wonderful in Mrs Shore's removing from Lombard-street to shine at court as the royal favourite. Historians represent her as extremely beautiful, remarkably cheerful, and of most uncommon generosity. The king, it is said, was no less captivated with her temper than with her person: she never made use of her influence over him to the prejudice of any person; and if ever she importuned him, it was in favour of the unfortunate. After the death of Edward, she attached herself to the lord Hastings; and when Richard III. cut off that nobleman as an obstacle to his ambitious schemes, Jane Shore was arrested as an accomplice, on the ridiculous accusation of witchcraft. This, however, terminated only in a public penance; excepting that Richard rifled her of all her little property: but whatever severity might have been exercised towards her, it appears that she was alive, though sufficiently wretched, under the reign of Henry VIII. when Sir Thomas More saw her poor, old, and shrivelled, without the least trace of her former beauty. Mr Rowe, in his tragedy of Jane Shore, has adopted the popular story related in the old historical ballad, of her perishing by hunger in a ditch where Shoreditch now stands. But Stow assures us that street was so named before her time.

SHORL. See SCHORL.

SHORLING and MORLING, are words to distinguish fells of sheep; *shorling* being the fells after the fleeces are shorn off the sheep's back; and *morling*, the fells shed off after they die or are killed. In some parts of England they understand by a *shorling*, a sheep whose face is shorn off; and by a *morling*, a sheep that dies.

SHORT (James), an eminent optician, was born in Edinburgh on the 10th of June, O. S. in the year 1710. At ten years of age, having lost his father and mother, and being left in a state of indigence, he was received into Heriot's Hospital, (see *EDINBURGH Public Buildings*, n° 16.), where he soon displayed his mechanical genius in constructing, for himself, little chests, book-cases, and other conveniences, with such tools as fell in his way. At the age of twelve he was removed from the Hospital to the High School, where he showed a considerable taste for classical literature, and generally kept at the head of his forms. In the year 1726 he was entered into the university, where he passed through

the usual course of education, and took his master's degree with great applause.

By his friends he was intended for the church; but after attending a course of theological lectures, his mind revolted from a profession which he thought little suited to his talents; and he devoted his whole time to mathematical and mechanical pursuits. He had been fortunate enough to have the celebrated M<sup>r</sup> Laurin for his preceptor; who having soon discovered the bent of his genius, and made a proper estimate of the extent of his capacity, encouraged him to prosecute those studies in which nature had qualified him to make the greatest figure. Under the eye of that eminent master, he began in 1732 to construct Gregorian telescopes; and, as the professor observed in a letter to Dr Jurin, "by taking care of the figure of his specula, he was enabled to give them larger apertures, and to carry them to greater perfection, than had ever been done before him." See *OPTICS*, n° 97.)

In the year 1736 Mr Short was called to London, at the desire of Queen Caroline, to give instructions in mathematics to William duke of Cumberland; and immediately on his appointment to that very honourable office he was elected a fellow of the royal society, and patronised by the earls of Morton and Macclesfield. In the year 1739 he accompanied the former of those noble lords to the Orkney Isles, where he was employed in adjusting the geography of that part of Scotland: and happy it was for him that he was so employed, as he might otherwise have been involved in a scuffle which took place between the retainers of Sir James Stewart of Barra and the attendants of the earl, in which some of the latter were dangerously wounded.

Mr Short having returned to London, and finally established himself there in the line of his profession, was in 1743 employed by lord Thomas Spencer to make for him a reflector of twelve feet focus, for which he received 600 guineas. He made several other telescopes of the same focal distance with greater improvements and higher magnifiers; and in 1752 finished one for the king of Spain, for which, with its whole apparatus, he received 1200*l*. This was the noblest instrument of the kind that had then been constructed, and perhaps it has never yet been surpassed except by the astonishing reflectors of Herschel. See *TELESCOPE*.

Mr Short was wont to visit the place of his nativity once every two or three years during his residence in London, and in 1766 he visited it for the last time. On the 15th of June 1768 he died, after a very short illness, at Newington Butts, near London, of a mortification in his bowels, and was buried on the 22d of the same month, having completed, within a few days, his fifty-eighth year. He left a fortune of about 20,000*l*. of which 15,000*l*. was bequeathed to two nephews, and the rest in legacies to his friends. In gratitude for the steady patronage of the earl of Morton, he left to his daughter the Lady Mary Douglas, afterwards countess of Aboyne, 1000*l*. and the reversion of his fortune, should his nephews die without issue; but this reverfionary legacy the lady, at the desire of her father, generously relinquished by a deed in favour of Mr Short's brother Mr Thomas Short and his children. Mr Short's eminence as an artist is universally known, and we have often heard him spoken of by those who had known

Short.

known him from his youth, as a man of virtue and of very amiable manners.

*SHORT-Hand Writing.* See STENOGRAPHY.

*SHORT-jointed*, in the manege. A horse is said to be short-jointed that has a short pastern; when this joint, or the pastern is too short, the horse is subject to have his fore legs from the knee to the coronet all in a straight line. Commonly your short-jointed horses do not manege so well as the long-jointed; but out of the manege the short-jointed are the best for travel or fatigue.

*SHORT-Sightedness*, a certain defect in vision, by which objects cannot be distinctly seen unless they are very near the eye. See OPTICS, n<sup>o</sup> 155.

*SHORTFORD*, q. d. *fore-closed*, an ancient custom in the city of Exeter, when the lord of the fee cannot be answered rent due to him out of his tenement, and no dilferences can be levied for the same. The lord is then to come to the tenement, and there take a stone, or some other dead thing off the tenement, and bring it before the mayor and bailiff, and thus he must do seven quarter days successively; and if on the seventh quarter-day the lord is not satisfied of his rent and arrears, then the tenement shall be adjudged to the lord to hold the same a year and a day; and forthwith proclamation is to be made in the court, that if any man claims any title to the said tenement, he must appear within the year and day next following, and satisfy the lord of the said rent and arrears: but if no appearance be made, and the rent not paid, the lord comes again to the court, and prays that, according to the custom, the said tenement be adjudged to him in his demesne as of fee, which is done accordingly, so that the lord hath from thenceforth the said tenement, with the appurtenances to him and his heirs.

*SHOT*, a denomination given to all sorts of balls for fire-arms; those for cannon being of iron, and those for guns, pistols, &c. of lead. See SHOOTING.

*Case SHOT* formerly consisted of all kinds of old iron, nails, musket-balls, stones, &c. used as above.

*SHOT of a Cable*, on ship-board, is the splicing of two cables together, that a ship may ride safe in deep waters and in great roads; for a ship will ride easier by one shot of a cable, than by three short cables out ahead.

*Grape SHOT.* See GRAPE-SHOT.

*Patent milied SHOT* is thus made: Sheets of lead, whose thickness corresponds with the size of the shot required, are cut into small pieces, or cubes, of the form of a die. A great quantity of these little cubes are put into a large hollow iron cylinder, which is mounted horizontally and turned by a winch; when by their friction against one another and against the sides of the cylinder, they are rendered perfectly round and very smooth. The other patent shot is cast in moulds, in the same way as bullets are.

*SHOT-Flaggon*, a sort of flaggon somewhat bigger than ordinary, which in some counties, particularly Derbyshire, it is the custom for the host to serve his guests in, after they have drank above a shilling.

*Small SHOT*, or that used for fowling, should be well sized, and of a moderate bigness: for should it be too great, then it flies thin, and scatters too much; or if too small, then it hath not weight and strength to penetrate far, and the bird is apt to fly away with it. In order, therefore, to have it suitable to the occasion, it

not being always to be had in every place fit for the purpose, we shall set down the true method of making all sorts and sizes under the name of *mould-shot*. Its principal good properties are to be round and solid.

Take any quantity of lead you think fit, and melt it down in an iron vessel; and as it melts keep it stirring with an iron ladle, skimming off all impurities whatsoever that may arise at the top: when it begins to look of a greenish colour, strew on it as much auripigmentum or yellow orpiment, finely powdered, as will lie on a shilling, to every 12 or 14 pound of lead; then stirring them together, the orpiment will flame.

The ladle should have a notch on one side of the brim, for more easily pouring out the lead; the ladle must remain in the melted lead, that its heat may be the same with that of the lead, to prevent inconveniences which otherwise might happen by its being either too hot or too cold: then, to try your lead, drop a little of it into water, and if the drops prove round, then the lead is of a proper heat; if otherwise, and the shot have tails, then add more orpiment to increase the heat, till it be found sufficient.

Then take a plate of copper, about the bigness of a trencher, which must be made with a hollowness in the middle, about three inches compass, within which must be bored about 40 holes according to the size of the shot which you intend to cast: the hollow bottom should be thin; but the thicker the brim, the better it will retain the heat. Place this plate on a frame of iron, over a tub or vessel of water, about four inches from the water, and spread burning coals on the plate, to keep the lead melted upon it: then take some lead and pour it gently on the coals on the plate, and it will make its way through the holes into the water, and form itself into shot; do thus till all your lead be run through the holes of the plate, taking care, by keeping your coals alive, that the lead do not cool, and so stop up the holes.

While you are casting in this manner, another person with another ladle may catch some of the shot, placing the ladle four or five inches underneath the plate in the water, by which means you will see if they are defective, and rectify them.

Your chief care is to keep the lead in a just degree of heat, that it be not so cold as to stop up the holes in your plate, nor so hot as to cause the shot to crack: to remedy the heat, you must refrain working till it is of a proper coolness; and to remedy the coolness of your lead and plate, you must blow your fire; observing, that the cooler your lead is, the larger will be your shot; as the hotter it is, the smaller they will be.

After you have done casting, take them out of the water, and dry them over the fire with a gentle heat, stirring them continually that they do not melt; when dry, you are to separate the great shot from the small, by the help of a sieve made for that purpose, according to their several sizes. But those who would have very large shot, make the lead trickle with a stick out of the ladle into the water, without the plate.

If it stop on the plate, and yet the plate be not too cool, give but the plate a little knock, and it will run again; care must be had that none of your implements be greasy, oily, or the like; and when the shot, being separated, are found too large or too small for your purpose,

Shot.

pose, or otherwise imperfect, they will serve again at the next operation.

The sizes of common shot for fowling are from N<sup>o</sup> 1 to 6, and smaller, which is called muskard seed, or dust shot; but N<sup>o</sup> 5 is small enough for any shooting whatsoever. The N<sup>o</sup> 1 may be used for wild geese; the N<sup>o</sup> 2 for ducks, widgeons, and other water-fowl; the N<sup>o</sup> 3 for pheasants, partridges after the first month, and all the sen-fowl; the N<sup>o</sup> 4 for partridges, woodcocks, &c.; and the N<sup>o</sup> 5 for snipes and all the smaller birds.

*Tin-Case SHOT*, in artillery, is formed by putting a great quantity of small iron shot into a cylindrical tin-box called a cannister, that just fits the bore of the gun. Leaden bullets are sometimes used in the same manner; and it must be observed, that whatever number or sizes of the shots are used, they must weigh with their cases nearly as much as the shot of the piece.

SHOVEL (Sir Claudesly), was born about the year 1650 of parents rather in the lower rank of life. He was put apprenticed to a shoemaker; but disliking this profession, he abandoned it a few years after, and went to sea. He was at first a cabin boy with Sir Christopher Monms, but applying to the study of navigation with indefatigable industry, his skill as a seaman soon raised him above that station.

The corsairs of Tripoli having committed great outrages on the English in the Mediterranean, Sir John Narborough was sent in 1674 to reduce them to reason. As he had received orders to try the effects of negotiation before he proceeded to hostilities, he sent Mr Shovel, who was at that time a lieutenant in his fleet, to demand satisfaction. The Dey treated him with a great deal of disrespect, and sent him back without an answer. Sir John dispatched him a second time, with orders to remark particularly the situation of things on shore. The behaviour of the Dey was worse than ever. Upon Mr Shovel's return, he informed Sir John that it would be possible, notwithstanding their fortifications, to burn all the ships in the harbour. The boats were accordingly manned, and the command of them given to Lieut. Shovel, who seized the guardship, and burnt four others, without losing a man. This action so terrified the Tripolins, that they sued for peace.—Sir John Narborough gave so favourable an account of this exploit, that Mr Shovel was soon after made captain of the Saphire, a fifth rate ship.

In the battle of Bantry-Bay, after the revolution, he commanded the Edgar, and, for his gallant behaviour in that action, was soon after knighted by king William. Next year he was employed in transporting an army into Ireland; a service which he performed with so much diligence and dexterity, that the king raised him to the rank of rear-admiral of the blue, and delivered his commission with his own hands. Soon after he was made rear admiral of the red, and shared the glory of the victory at La Hogue. In 1694, he bombarded Dunkirk. In 1703, he commanded the grand fleet in the Mediterranean, and did every thing in his power to assist the Protestants who were in arms in the Cevennes.

Soon after the battle off Malaga, he was presented by prince George to Queen Anne, who received him graciously, and next year employed him as commander in chief.

In 1705 he commanded the fleet, together with the earls of Peterborough and Monmouth, which was sent

into the Mediterranean; and it was owing to him chiefly that Barcelona was taken. After an unsuccessful attempt upon Toulon, he sailed for Gibraltar, and from thence homeward with a part of the fleet. On the 22d of October, at night, his ship, with three others, was cast away on the rocks of Scilly. All on board perished. His body was found by some fishermen on the island of Scilly, who stripped it of a valuable ring, and afterwards buried it. Mr Paxton, the purser of the Arundel, hearing of this, found out the fellows, and obliged them to discover where they had buried the body. He carried it on board his own ship to Portsmouth, from whence it was conveyed to London, and interred with great solemnity in Westminster Abbey. A monument was afterwards erected to his memory by the direction of the Queen. He married the widow of his patron, Sir John Narborough, by whom he left two daughters, co-heiresses.

SHOVELER, in ornithology, a species of ANAS.

SHOULDER-BLADE, a bone of the shoulder, of a triangular figure, covering the hind part of the ribs, called by anatomists the *scapula* and *omoplata*. See ANATOMY.

SHOUT, CLAMOUR, in antiquity, was frequently used on ecclesiastical, civil, and military occasions, as a sign of approbation, and sometimes of indignation.—Thus as Cicero, in an assembly of the people, was exposing the arrogance of L. Antony, who had had the impudence to cause himself to be inscribed the patron of the Romans, the people on hearing this raised a shout to show their indignation. In the ancient military discipline, shouts were used, 1. Upon occasion of the general's making a speech or harangue to the army from his tribunal. This they did in token of their approving what had been proposed. 2. Before an engagement, in order to encourage and spirit their own men, and fill the enemy with dread. This is a practice of great antiquity; besides which, it wants not the authority of reason to support it; for as mankind are endowed with two senses, hearing and seeing, by which fear is raised in the mind, it may be proper to make use of the ear as well as the eye for that purpose. Shouts were also raised in the ancient theatre, when what was acted pleased the spectators. It was usual for those present at the burning of the dead to raise a great shout, and call the dead person by his name before they set fire to the pile.

SHOWER, in meteorology, a cloud condensed into RAIN.

SHREWSBURY. See SOREX.

SHREWSBURY, the capital of Shropshire in England. This town, the metropolis of the county, grew up out of the ruins of Uriconium, anciently a city, now a village called *Wroxeter*, about four miles from it. The Saxons called it *Scrobbs Berig*, from the shrubs that grew about it; and from thence the present name of *Shrewsbury* is supposed to have been formed. It is pleasantly situated upon a hill near the Severn, over which there are two handsome bridges. It was a place of note in the Saxon times; after which it was granted by William the Conqueror, together with the title of *earl* and most of the county, to Roger de Montgomery, who built a castle upon the north side of it, where the Severn, that encompasses it on all other sides, leaves an opening. His son Robert built also a wall across this neck of land, when he revolted

from Henry I. We learn from doomsday-book, that at that time, when a widow of this town married, she paid 20 shillings to the king, and a virgin 10. The above-mentioned Roger founded also, and endowed here, a Benedictine monastery and a collegiate church. When old age came upon him, he quitted the world, and spent the rest of his days as a monk in the abbey, and when he died was interred in its church. From the history of this church and monastery, it appears, that ecclesiastical benefices about that time were hereditary. The abbey became so rich afterwards, that the abbot was mitred, and sat in parliament. Besides this abbey, in after times there were three others, viz. a Franciscan, Dominican, and Augustin, and likewise two collegiate churches; one dedicated to St Chad and the other to St Mary. In the contest between the empress Maud and Stephen, this town, and its governor William Fitz-Allan, sided with the empress. In Henry III.'s time, a part of it was burnt down by the Welch; and in Richard II.'s reign a parliament was held in it. At a place called *Battlefield*, near this town, Henry Percy the younger, surnamed *Hotspur*, was killed in an engagement with Henry IV. against whom he had rebelled. The king afterwards built a chapel upon the spot, and endowed it for the support of two priests to pray for the souls of the slain. Two of Edw. IV.'s sons were born here; namely, Richard, duke of York, whom Perkin Warbeck afterwards personated, and who was murdered in the Tower; and George Plantagenet, who died before his brothers. Here scurvy broke out the sweating-sickness, which carried off great numbers so suddenly, that those who were seized with it either died or recovered in the space of 24 hours. In the beginning of the civil wars, king Charles I. came hither, and formed an army, with which he marched towards London; but was met by the parliament's forces at Edgehill. He continued here from the 20th of September, to the 12th of October, during which time he was joined by prince Rupert, and many of the gentry and nobility of these parts. This town anciently gave title of earl to the Montgomeries, and afterwards to the Talbots, by whom it is still retained. Here is a free grammar-school, with three masters, and several ushers, well endowed by Edward VI. and queen Elizabeth, and not inferior to many colleges in the universities. It has a good library and chapel, and there are several scholarships appropriated to it in the university of Cambridge. Here are also several hospitals, alms-houses, and charity-schools. This town is one of the most flourishing in England, having two great weekly markets for corn, cattle, and provisions; and another for Welch cottons and flannels, of which great quantities are sold. A great trade is carried on with the Welch, who bring their commodities hither, as to the common mart of both nations. The town is large and well-built, and the situation extremely pleasant. There is a very beautiful walk called the *quarry*, between the town walls and the Severn, delightfully shaded with rows of lime-trees, so that it is not inferior to the Mall in St James's Park. The town is also noted for its gallantry and politeness, being full of gentry, for whom there are always balls and assemblies once a-week all the year round.—Here is a fine house and gardens, which belonged to the earl of Bradford; and in the neighbourhood, at Wroxeter, the Roman highway, called Watling-street,

may be seen for several miles, where Roman coins are frequently found. In Shrewsbury are 12 incorporated trading companies; and the corporation has a power to try even capital causes of itself, except high treason. It is said that thigh-bones of dead men have been found here a yard long, and teeth three inches round and three long.

SHRIKE. See LANIUS.

SHRIMP, in ichthyology. See CANCER, n<sup>o</sup> 5. and 6.

SHRINE, in ecclesiastical history, a case or box to hold the relics of some saint.

SHROPSHIRE, a county of England, bounded on the south by Worcestershire, Herefordshire, and Radnorshire; on the north, by Cheshire; on the east, by Staffordshire; on the west, by Montgomeryshire and Denbighshire, in Wales. Its length is between 49 and 50 miles—its breadth about 38, and its circumference about 210. It is an inland county, containing 890,000 acres, 113,680 inhabitants, and 15 hundreds, in which are 170 parishes, and 15 market towns. It makes a part of three bishoprics, viz. Hereford, Coventry and Litchfield, and St Asaph. Some part of it lies on the north, and some on the south side of the Severn. Besides the Severn, it is also watered by the *Tend* or *Tesdianc*, as it is called in Welch, which flows from the mountains of Radnorshire; and by the *Tern*, which has its rise and name from one of those pools called *tearns*, in Staffordshire. All these abound with fish, especially trouts, pikes, lampreys, grayling, carp, and eels. The air, especially upon the hills, with which the county abounds, is very wholesome. There is as great a diversity of soil as in most other counties. On the hills, where it is poor, is very good pasture for sheep; and in the low grounds, where it is very rich, along the Severn in particular, there is plenty of grass for hay and black cattle, with all sorts of corn. No county is better provided with fuel than this, having in it many inexhaustible pits of coal, and also mines of lead and iron. Over most of the coal-pits in this county lies a stratum or layer of blackish porous rock, of which, by grinding and boiling, they make pitch and tar, which are rather better than the common sort for caulking ships, as they do not crack, but always continue close and smooth. Quarries of lime-stone and iron-stone are common enough in the county, and the soil in many places is a reddish clay. As it lies upon the borders of Wales, it was anciently full of castles and walled towns. On the side next that country there was an almost continued line of castles, to guard the county against the inroads and depredations of the Welch. The borders here, as those between England and Scotland, were called *marches*, and there were certain noblemen intitled *barones marchie*, *marchiones de marchia Wallia*, "lords of the marches, or marquesses of the marches of Wales," who were vested with a sort of palatine jurisdiction, held courts of justice to determine controversies, and enjoyed many privileges and immunities, the better to enable and encourage them to protect the county against the incursions of the Welch, and to maintain order amongst the borderers; but they often abused their power, and were the greatest of tyrants.

As to the ecclesiastical government of the county, the far greater part, namely, all that belongs to the bishoprics of Hereford, and of Litchfield and Coventry,

Shrike  
||  
Shropshire.

Shrove  
||  
Shrub.

is under the jurisdiction and visitation of the archdeacon of Shrewsbury or Salop, and is divided into several deaneries.

The Oxford circuit includes in it this county, which sends 12 members to parliament, viz. two for the shire, and two for each of the following towns, Shrewsbury, Ludlow, Wenlock, and Bishop's Castle.

SHROVE-TUESDAY, is the Tuesday after Quinquagesima Sunday, or the day immediately preceding the first of Lent; being so called from the Saxon word *shrine*, which signifies "to confess." Hence Shrove-Tuesday signifies Confession-Tuesday; on which day all the people in every parish throughout England (during the Romish times) were obliged to confess their sins, one by one, to their own parish-priests, in their own parish churches; and, that this might be done the more regularly, the great bell in every parish was rung at ten o'clock (or perhaps sooner), that it might be heard by all, and that they might attend, according to the custom then in use. And though the Romish religion has now given way to the Protestant religion, the custom of ringing the great bell in our ancient parish-churches, at least in some of them, still remains, and obtains in and about London the name of Pancake bell; perhaps, because after the confession it was customary for the several persons to dine on pancakes or fritters. Most churches, indeed, have rejected that custom of ringing the bell on Shrove-Tuesday; but the usage of dining on pancakes or fritters, and such like provision, still continues.

SHROUDS (*scrud* Sax.), a range of large ropes extending from the mast-heads to the right and left side of the ship, to support the masts, and enable them to carry sail, &c.

The shrouds as well as the sails are denominated from the masts to which they belong. Thus they are the main, fore, and mizen shrouds; the main-top-mast, fore-top-mast, or mizen-top-mast shrouds; and the main-top-gallant, fore-top-gallant, or mizen-top-gallant shrouds. The number of shrouds by which a mast is sustained, as well as the size of rope of which they are formed, is always in proportion to the size of the mast and the weight of the sail it is intended to carry.

Bow-sprit shrouds are those which support the bow-sprit. Bumkin shrouds are those which support the bumkins. Futtock shrouds are shrouds which connect the efforts of the topmast shrouds to the lower shrouds. Bentineck-shrouds are additional shrouds to support the masts in heavy gales. Preventer shrouds are similar to bentineck-shrouds, and are used in bad weather to ease the lower rigging. See MAST and SAIL.

SHRUB, *frutex*, a little, low, dwarf tree, or a woody vegetable, of a size less than a tree; and which, instead of one single stem, frequently from the same root puts forth several sets or stems. See PLANT and TREE. Such are privet, phillyrea, holly, box, honeysuckle, &c. Shrubs and trees put forth in autumn a kind of buttons, or gems, in the axis of the leaves; these buttons are as so many little ova, which, coming to expand by the warmth of the following spring, open into leaves and flowers. By this, together with the height, some distinguish shrubs from *suffrutices*, or under shrubs, which are low bushes, that do not put forth any of these buttons, as sage, thyme, &c.

The two hardiest shrubs we are possessed of are the ivy and box; these stand the severity of our sharpest winters unhurt, while other shrubs perish, and trees have their solid bodies split and torn to pieces. In the hard winter of the year 1683, these two shrubs suffered no injury any where; though the yews and hollies, which are generally supposed very hardy, were that winter in some places killed, and in others stripped of their leaves, and damaged in their bark. Furze-bushes were found to be somewhat hardier than these, but they sometimes perished, at least down to the root. The broom seemed to occupy the next step of hardiness beyond these. This lived where the others died, and where even this died, the juniper shrubs were sometimes found unhurt. This last is the only shrub that approaches to the hardiness of the box and ivy, but even it does not quite come up to them; for while they suffer nothing in whatever manner they are exposed, the juniper, though it bears cold well under the shelter of other trees, yet cannot bear the vicissitudes of heat and cold; inasmuch that some juniper shrubs were found half dead and half vigorous; that side which faced the mid-day sun having perished by the successive thawings and freezings of its sap; while that which was not exposed to the vicissitudes of heat had born the cold perfectly well. Such shrubs as are not hardy enough to defy the winter, but appear half dead in the spring, may often be recovered by Mr Evelyn's method of beating their branches with a slender hazel-wand, to strike off the withered leaves and buds, and give a free passage to the air to the internal parts. Where this fails, the method is to cut them down to the quick, and if no part of the trunk appears in a growing condition, they must be taken off down to the level of the ground. *Philosophical Transactions*, n<sup>o</sup> 165.

SHUCKFORD (Samuel), curate of Shelthorpe in Norfolk, prebendary of Canterbury, and chaplain in ordinary to the king, was a learned Englishman. His manners were those of a philosopher, uncorrupted by the manners of the world. He wrote a history of the world, sacred and profane, to serve as an introduction to Prideaux, in 3 vols 8vo. It is heavily written, but displays a great deal of erudition. His death, which happened in 1756, prevented him from carrying it down to the year 747 before Christ, where Prideaux begins. He wrote also a treatise on the Creation and Fall of Man, to serve as a supplement to the preface to his history.

SHUTTLE, in the manufactures, an instrument used by the weavers, which guides the thread it contains, either of woollen, silk, flax, or other matter, so as to make it form the woofs of stuffs, cloths, linens, ribbands, &c. by throwing the shuttle alternately from left to right, and from right to left, across between the threads of the warp, which are stretched out lengthwise on the loom.

In the middle of the shuttle is a kind of cavity, called the *eye* or *chamber* of the shuttle; wherein is inclosed the spool, which is a part of the thread destined for the woof; and this is wound on a little tube of paper, rush, or other matter.

The ribband-weaver's shuttle is very different from that of most other weavers, though it serves for the same purpose: it is of box, six or seven inches long, one broad, and as much deep; shod with iron at both ends,

Shrub  
||  
Shuttle.

ends, which terminate in points, and are a little crooked, the one towards the right, and the other towards the left, representing the figure of an  $\infty$  horizontally placed. See WEAVING.

**SIALOGOGUES**, medicines which promote the salivary discharge.

**SIAM PROPER**, by some called *Upper*, (to distinguish it from the *Lower Siam*, under which are often included Laos, Cambodia, and Malacca), is bounded on the north by the kingdoms of Pegu and Laos; on the east by Cambodia and Cochinchina; on the south by Malacca and the bay of Siam; and on the west by the ocean. But as the opinions of geographers are extremely various concerning the situation and extent of most of the inland countries of Asia and Africa, neither the extent nor boundaries of Siam are yet accurately known. By some it is supposed to extend 550 miles in length, and 250 miles in breadth; in some places it is not above 50 miles broad.

The winds blow here from the south upon the coast of Siam, in March, April, and May; in April the rains begin, in May and June they fall almost without ceasing. In July, August, and September, the winds blow from the west, and the rains continuing, the rivers overflow their banks nine or ten miles on each side, and for more than 150 miles up the stream. At this time, and more particularly in July, the tides are so strong as to come up the river Menan as far as the city of Siam, which is situated 60 miles from its mouth; and sometimes as far as Louvo, which is 50 miles higher. The winds blow from the west and north in October, when the rain ceases. In November and December the winds blow dry from the north, and the waters being in a few days reduced to their ancient channels, the tides become so insensible, that the water is fresh at the mouth of the river. At Siam there is never more than one flood and one ebb in the space of 24 hours. In January the wind blows from the east, and in February from the east and south. When the wind is at east, the current sets to the west; and, on the contrary, when the wind is at west, the currents run to the eastward.

As this country is situated near the tropic, it must necessarily be very hot; but yet, as in other places nearly of the same latitude, when the sun is vertical and shines with a most intense heat, the inhabitants are so screened by the clouds, and the air is so refreshed by a deluge of rain that overflows the plains which the people chiefly inhabit, that the heat is very supportable. The coolest wind blows in December and January.

The vegetable produce of this country is chiefly rice and wheat, besides tropical and a few European fruits. The Siamese prepare the land for tillage as soon as the earth is sufficiently moistened by the floods. They plant their rice before the waters rise to any considerable height, and, as they rise slowly, the rice keeps pace with them, and the ear is always above the water. They reap their corn when the water retires, and sometimes go in boats to cut it while the waters are upon the ground. They also sow rice in several parts of the kingdom that are not overflowed, and this is thought better tasted, and will keep longer, than the other; but they are forced to supply these fields constantly with water, while the rice is growing, from basins and ponds that lie about them.

VOL. XVII. Part II.

They have no European fruits except oranges, lemons, citrons, and pomegranates. They have bananas, Indian figs, jupes, durions, mangoes, mangostans, tamarinds, ananas, and cocoa-nuts; they have also abundance of pepper and sugar canes. The mountains are covered with trees which make good masts. The vegetable of greatest use in the country is the bamboo, which grows chiefly in marshy soils, and is often found of a prodigious size. Cotton trees are found in great numbers; and others that yield *capoc*, a very fine cotton wool, but so short as to be unfit for spinning, though it answers very well for stuffing mattresses and pillows.

There is no country where elephants abound more than in Siam, or where they are held in greater veneration. They have a few horses, sheep, and goats, besides oxen and buffaloes; but they have no good animal food except the flesh of hogs, their beef and mutton being of a very indifferent quality.

The Siamese are of small stature, but well proportioned; their complexions are swarthy: the faces of both the men and women are broad, and their foreheads, suddenly contracting, terminate in a point, as well as their chins. They have small black eyes, hollow jaws, large mouths, and thick pale lips. Their teeth are dyed black, their noses are short and round at the end, and they have large ears, which they think very beautiful. Their hair is thick and lank, and both sexes cut it so short that it reaches no lower than their ears; the women make it stand up on their foreheads; and the men shave their beards.

People of distinction wear a piece of calico tied about their loins, that reaches down to their knees.—The men bring up this cloth between their legs, and tuck it into their girdles, which gives it the appearance of a pair of breeches. They have also a muslin shirt without a collar, with wide sleeves, no wristbands, and the bosom open. In winter they wear a piece of stuff or painted linen over their shoulders, like a mantle, and wind it about their arms.

The king of Siam is distinguished by wearing a vest of brocaded satin, with straight sleeves that reach down to the wrist, under such a shirt as we have just described, and it is unlawful for any subject to wear this dress unless he receives it from the king. They wear slippers with piked toes turned up, but no stockings. The king sometimes presents a military vest to the generals; this is buttoned before, and reaches to the knees; but the sleeves are wide, and come no lower than the elbows. All the retinue of the king, either in war or in hunting, are clothed in red. The king wears a cap in the form of a sugar-loaf, encompassed by a coronet or circle of precious stones, and those of his officers have a circle of gold, silver, or of vermilion gilt, to distinguish their quality; and these caps are fastened with a stay under the chin; they are only worn when they are in the king's presence, or when they preside in courts of justice, and on other extraordinary occasions. They have also hats for travelling; but, in general, few people cover their heads notwithstanding the scorching heat of the sun.

The women also wrap a cloth about their middle, which hangs down to the calf of their legs. They cover their breasts with another cloth, the ends of which hang over their shoulders. But they have no garment

Siam

Animals.

Description of the inhabitants.

Dress.

**Siem.** corresponding to a shift, nor any covering for their heads but their hair. The common people are almost naked, and wear neither shoes nor slippers. The women wear as many rings on the three last fingers of each hand as they can keep on, and bracelets upon their wrists and ancles, with pendants in their ears shaped like a pear.

**7**  
Manners  
and cu-  
stoms.

For an inferior to stand before a superior is deemed insolent; and therefore slaves and people of inferior rank sit upon their heels, with their heads a little inclined, and their joined hands lifted up to their foreheads. In passing by a superior they bend their bodies, joining their hands, and lifting them toward their heads in proportion to the respect they would show. When an inferior pays a visit, he enters the room stooping, prostrates himself, and then remains upon his knees, sitting upon his heels without speaking a word till he is addressed by the person whom he visits; for he that is of the highest quality must always speak first. If a person of rank visits an inferior, he walks upright, and the master of the house receives him at the door, and waits on him so far when he goes away, but never farther.

The highest part of the house is esteemed the most honourable, and no person cares to lodge under another's feet. The Siamese indeed have but one story, but the rooms rise gradually, and the innermost, which are the highest, are always the most honourable. When the Siamese ambassador came to the French court, some of his retinue were lodged in a floor over the ambassador's head; but they no sooner knew it, than they were stricken with the greatest consternation, and ran down tearing their hair at the thoughts of being guilty of what they considered as so unpardonable a crime.

The Siamese never permit such familiarities as are practised by gentlemen in Europe. easiness of access, and affability to inferiors, is in that part of the world thought a sign of weakness, and yet they take no notice of some things which would be looked upon as ill breeding among us; such as belching in company, which no man endeavours to prevent, or so much as holds his hand before his mouth. They have an extraordinary respect for the head, and it is the greatest affront to stroke or touch that of another person; nay, their cap must not be used with too much familiarity; for when a servant carries it, it is put on a stick and held above his head; and when the master stands still the stick is set down, it having a foot to stand upon. They also show their respect by lifting their hands to the head; and therefore, when they receive a letter from any one for whom they have a great respect, they immediately hold it up to their heads, and sometimes lay it upon their heads.

**8**  
Genius and  
disposi-  
tions.

They are esteemed an ingenious people, and though rather indolent than active in disposition, they are not addicted to the voluptuous vices which often accompany a state of ease, being remarkably chaste and temperate, and even holding drunkenness in abhorrence.— They are, however, accounted insolent towards their inferiors, and equally obsequious to those above them; the latter of which qualities appears to be particularly inculcated from their earliest youth. In general, their behaviour is extremely modest, and they are averse to lequacity. Like the Chinese, they avoid speaking in

the first person; and when they address a lady, it is always with some respectful epithet, insinuating personal accomplishments.

No man in this country learns any particular trade, but has a general knowledge of all that are commonly practised, and every one works six months for the king by rotation; at which time, if he should be found perfectly ignorant of the business he is set about, he is doomed to suffer the bastinado. The consequence of this burdensome service is, that no man endeavours to excel in his business, lest he should be obliged to practise it as long as he lives for the benefit of the crown.

The government of this country is extremely oppressive, the king being not only sovereign but proprietor of all the lands, and chief merchant likewise; by which means he monopolizes almost the whole traffic, to the great prejudice of his subjects. The crown is said to be hereditary, but it is often transferred by revolutions, on account of the exorbitant abuse of power in those who exercise the royal office. In his palace, the king is attended by women, who not only prepare his food, and wait on him at table, but even perform the part of valets, and put on all his clothes, except his cap, which is considered as too sacred to be touched by any hand but his own. He shows himself to the people only twice a-year, when he distributes his alms to the talapins or priests; and on those occasions he always appears in an elevated situation, or mounted on the back of an elephant. When he takes the diversion of hunting, he is as usual attended by his women on foot, preceded by a guard of 200 men, who drive all the people from the roads through which they are to pass; and when the king stops, all his attendants fall upon their faces on the ground.

All their proceedings in law are committed to writing, and none is suffered to exhibit a charge against another, without giving security to prosecute it, and answer the damages if he does not prove the fact against the person accused. When a person intends to prosecute another, he draws up a petition, in which he sets forth his complaint, and presents it to the *nu*, or head of the band to which he belongs, who transmits it to the governor; and if the complaint appears frivolous, the prosecutor, according to the laws of the country, should be punished; but the magistrates generally encourage prosecutions on account of the perquisites they bring to their office.

Every thing being prepared for hearing, the parties are several days called into court, and persuaded to agree; but this appears to be only a matter of form. At length the governor appoints a day for all parties to attend; and being come into court, the clerk reads the process and opinion of his associates, and then the governor examines upon what reasons their opinions are founded; which being explained to him, he proceeds to pass judgment.

When sufficient proofs are wanting, they have recourse to an ordeal trial, like that of our Saxon ancestors: both the plaintiff and the defendant walk upon burning coals, and he that escapes unhurt is adjudged to be in the right: sometimes the proof is made by putting their hands in boiling oil; and in both these trials, by some peculiar management, one or the other is said to remain unhurt. They have also a proof by water,

in.



in which he who remains longest under it is esteemed innocent. They have another proof, by swallowing pills, which their priests administer with severe imprecations; and the party who keeps them in his stomach without vomiting is thought to be innocent.

All these trials are made in the presence of the magistrates and people; and the king himself frequently directs them to be performed, when crimes come before him by way of appeal. Sometimes he orders both the informer and prisoner to be thrown to the tigers: and the person that escapes by his not being seized upon by those beasts, is sufficiently justified.

They maintain the doctrine of transmigration, believing in a pre-existent state, and that they shall pass into other bodies till they are sufficiently purified to be received into paradise. They believe likewise that the soul is material, but not subject to the touch; that it retains the human figure after quitting a body of that species; and that when it appears to persons with whom it was acquainted, which they suppose it to do, the wounds of one that has been murdered will then be visible. They are of opinion that no man will be eternally punished; that the good, after several transmigrations, will enjoy perpetual happiness; but that those who are not reformed will be doomed to transmigration to all eternity. They believe in the existence of a Supreme Being; but the objects of their adoration are departed saints, whom they consider as mediators or intercessors for them; and to the honour of this numerous tribe both temples and images are erected.

The men of this country are allowed a plurality of women; but excepting one, who is a wife by contract, the others are only concubines, and their children deemed incapable of any legal inheritance. Previous to every nuptial contract, an astrologer must be consulted, who calculates the nativity of the parties, and determines whether their union is likely to prove fortunate or otherwise. When his prognostication is favourable, the lover is permitted to visit his mistress three times, at the last of which interviews the relations being present, the marriage portion is paid, when, without any religious ceremony performed, the nuptials are reckoned complete, and soon after consummated. A few days after the talapoin visits the married couple, sprinkles them with water, and repeats a prayer for their prosperity.

The practice in Siam respecting funerals, is both to burn and bury the dead. The corpse being laid upon the pile, it is suffered to burn till a considerable part is consumed, when the remainder is interred in a burying-place contiguous to some temple. The reason which they give for not burning it entirely to ashes, is that they suppose the deceased to be happy when part of his remains escapes the fire. Instead of a tombstone, they erect a pyramid over the grave. It formerly was the custom to bury treasure with the corpse; but longer experience evincing, that the sacrilegious light in which robbing the graves was considered did not prevent the crime, they now discontinue the ancient practice, and instead of treasure bury only painted papers and other trifles.

The two principal rivers are the Menan and the Mecon, which rise in the mountains of Tartary, and run to the south; the former passing by the city of Siam, falls into the bay of the same name, in the 13th de-

gree of north latitude; and the latter running through Laos and Cambodia, discharges itself into the Indian ocean in the 9th degree of north latitude.

The capital of the country is Siam, called by the natives *Siyothoya*, situated in the 101st degree of east longitude, and in the 14th degree of north latitude, being almost encompassed by the branches of the river Menan. It is about 10 miles in circumference within the walls, but not a sixth part of the ground is occupied by buildings. In the vacant spaces there are near 300 pagodas or temples, round which are scattered the convents of the priests and their burying-places. The streets of the city are spacious, and some have canals running through them, over which is a great number of bridges. The houses stand on pillars of the bamboo cane, and are built of the same materials; the communication between different families, during the winter season, being carried on as in other tropical countries by means of boats. The grounds belonging to the several tenements are separated by a pallisado, within which the cattle are housed in barns, erected likewise upon pillars, to preserve them from the annual inundation.

SIBBALDIA, in botany: A genus of plants belonging to the class of pentandria, and to the order of pentagynia; and in the natural system arranged under the 35th order, *Senticose*. The calyx is divided into ten segments. The petals are five, and are inserted into the calyx. The styles are attached to the side of the germens. The seeds are five. There are three species belonging to this genus, the *procumbens*, *erecta*, and *altaica*. The procumbens, or reclining sibaldia, is a native of North Britain, having never been discovered in the southern parts of the island. It grows on Ben-Lomond and Ben-Mor, within a mile of the summit. It is distinguished by a procumbent or trailing stem; by three leaves growing on the top of a small footstalk, which are trifid at the extremity, and somewhat hairy. The flowers are yellow, and blossom in July or August.

SIBENICO, or SEBENICO, the name of a city and province of Dalmatia. The province of Sibenico runs along the sea for more than 30 miles; reaches in some places above 20 miles within land, and comprehends above 70 islands. The city of Sibenico is situated near the mouth of the river Cherea, in the Gulf of Venice, 3 miles north of Spalatto, and 25 south-east of Zara. E. Long. 16° 46', N. Lat. 44° 17'. It belongs to the Venetians. It is defended on one side by a castle, which held out against repeated attacks of the Turks, and towards the sea by a fort.

SIBERIA, a large country, comprehending the most northerly parts of the Russian empire in Asia. It is bounded on the east by the eastern ocean; on the south by Great Tartary; on the west by Russia; and on the north by the Frozen Ocean. It is about 2000 miles in length from east to west, and 750 miles in breadth from north to south.

At what time this country was first inhabited, or by whom it was peopled, we are entirely ignorant; but writings have been found in it when it was discovered, which shows that it must have been early known to a civilized people. The Russians, from whom we have received our knowledge, knew nothing of it before the middle of the 16th century. In the reign of John Basilowitz I. indeed, an incursion had been made into Siberia,

Siberia. and some Tartar tribes subdued: but these conquests were not permanent; and we hear of no further communication between Russia and Siberia till the time of John Basflowitz II. It was opened again at that time by means of one Anika Strogonoff, a Russian merchant who had established some salt-works at a town in the government of Archangel. This man carried on a trade with the inhabitants of the north west parts of Siberia, who brought every year to the town above-mentioned large quantities of the finest furs. Thus he acquired a very considerable fortune in a short time; when at last the czar, perceiving the advantages which would accrue to his subjects from having a regular intercourse with Siberia, determined to enlarge the communication which was already opened. With this view he sent into Siberia a body of troops, which crossed the Yutorian mountains, that form part of the north-eastern boundary of Europe. They seem, however, not to have passed the Irtysh, or to have penetrated farther than the western branch of the river Oby. Some Tartar tribes were laid under contribution, and a chief named *Yediger* consented to pay an annual tribute of 1000 fables. But this produced no lasting advantage to Russia; for, soon after, *Yediger* was defeated and taken prisoner by *Kutchum Khan*, a descendant of the great *Jenghiz Khan*: and thus the allegiance of this country to Russia was dissolved.

For some time we hear of no further attempts made by the Russians on Siberia; but in 1577 the foundation of a permanent conquest was laid by one *Yermac Temoseeff*, a Cossack of the Don. This man was at first the head of a party of banditti who infested the Russians in the province of *Casan*; but being defeated by the troops of the czar, he retired with 600 of his followers into the interior parts of that province. Continuing his course still eastward, he came to *Orel*, the most easterly of all the Russian settlements. Here he took up his winter-quarters; but his restless genius did not suffer him to continue for any length of time in a state of inactivity; and from the intelligence he procured concerning the situation of the neighbouring Tartars of Siberia, he turned his arms towards that quarter.

<sup>3</sup>  
State of  
Siberia at  
the time  
of the Rus-  
sian con-  
quest.

Siberia was at that time partly divided among a number of separate princes, and partly inhabited by the various tribes of independent Tartars. Of the former *Kutchum Khan* was the most powerful sovereign. His dominions consisted of that tract of coun-

try which now forms the south-western part of the province of *Tobolsk*; and stretched from the banks of the *Irtysh* and *Oby* to those of the *Tobol* and *Tura*. His principal residence was at *Sibir*, a small fortress upon the river *Irtysh*, not far from the present town of *Tobolsk*, and of which some ruins are still to be seen. After a course of unrelaxed fatigue, and a series of victories which almost exceed belief, but of which we have not room to give the detail, our intrepid adventurer dispossessed this prince of his dominions, and seated himself on the throne of *Sibir*. The number of his followers, however, being greatly reduced, and perceiving he could not depend on the affection of his new subjects, he had recourse to the czar of *Muscovy*, and made a tender of his new acquisitions to that monarch, upon condition of receiving immediate and effectual support. This proposal was received with the greatest satisfaction by the czar, who granted him a pardon for all former offences, and sent him the required succours. *Yermac*, however, being soon after drowned in an unsuccessful excursion, the Russians began to lose their footing in the country. But fresh reinforcements being seasonably sent, they not only recovered their ground, but pushed their conquests far and wide; wherever they appeared, the Tartars were either reduced or exterminated. New towns were built, and colonies were planted on all sides. Before a century had well elapsed, all that vast tract of country now called *Siberia*, which stretches from the confines of Europe to the Eastern Ocean, and from the Frozen Sea to the present frontiers of China, was annexed to the Russian dominions.

The air of Siberia is, in general, extremely piercing, the cold there being more severe than in any other part of the Russian dominions. The Siberian rivers are frozen very early, and it is late in the spring before the ice is thawed (A). If the corn does not ripen in August, there is little hope of a harvest in this country; and in the province of *Jeniseisk* it is sometimes covered with snow before the peasants can reap it. To defend the inhabitants against this extreme severity of the climate, Providence seems more liberally to have dealt out to them wood for fuel and furs for clothing. As the winter's day in the north parts of Siberia lasts but a few hours, and the storms and flakes of snow darken the air so much, that the inhabitants, even at noon, cannot see to do any thing without artificial lights, they sleep away the greatest part of that season.

These

(A) *M. Gmelin*, *M. Muller*, and two other philosophers, set out in the year 1733 to explore the dreary regions of Siberia, by desire of the empress *Anne* of Russia. After spending nine years and a half in observing every thing that was remarkable, they returned to *Petersburgh*; and an account of this journey was published by *M. Gmelin*. In order to examine how far the frost had penetrated into the ground, *M. Gmelin*, on the 18th of June, at a place called *Jacutia*, ordered the earth to be dug in high ground; they found mould to the depth of 11 inches, under which they met with loose sand to two feet and a half further, after which it grew harder, and at half a foot deeper so hard as scarce to give way to the tools; so that the ground still remained unthawed as not less than the depth of four feet. He made the same experiment in a lower situation; the soil was 10 inches deep, after that a loose sand for two feet and ten inches, below which all was frozen and hard. At *Jacutia* the inhabitants preserve in cellars several sorts of berries, which they reckon among their dainties, perfectly good and fresh the whole year, though these cellars are scarce a fathom deep. At the fortress of *Argun*, in little more than 50 degrees of latitude, the inhabitants relate that the earth in many places is never thawed above a yard and half, and that the internal cold of the earth will scarce permit a well to be dug, of which they bring an instance that happened not long before the author's arrival at that place. They designed to sink a well near a house at  
some

ria. These severe winters are rapidly succeeded by summers, in which the heat is so intense that the Tungusians, who live in the province of Jakutsk, go almost naked. Here is scarcely any night during that season; and towards the Frozen Ocean the sun appears continually above the horizon. The vegetables and fruits of the earth are here extremely quick in their growth.

The whole track of land beyond the 60th degree of north latitude is a barren waste; for the north part of Siberia yields neither corn nor fruits; though barley is known frequently to come to perfection in Jakutik.— For this reason, the inhabitants of the northern parts are obliged to live on fish and flesh, but the Russians are supplied with corn from the southern parts of Siberia, where the soil is surprisingly fertile. The countries beyond the lake of Baikal, especially towards the east, as far as the river Argun, are remarkably fruitful and pleasant; but such is the indolence of the inhabitants, that several fine tracts of land, which would make ample returns to the peasant for cultivating them, lie neglected. The pastures are excellent in this country, which abounds in fine horned cattle, horses, goats, &c. on which the Tartars chiefly depend for subsistence. How-

ever, there are several steppes, or barren wastes, and unimprovable tracts in these parts; and not a single fruit tree is to be seen. There is great variety of vegetables, and in several places, particularly near Krasnaia Sloboda, the ground is in a manner overrun with asparagus of an extraordinary height and delicious flavour. The bulbs of the Turkish bandes, and other sorts of lilies, are much used by the Tartars instead of bread. This want of fruit and corn is richly compensated by the great quantities of wild and tame beads, and fowls, and the infinite variety of fine fish which the country affords (B.)

In that part of Siberia which lies near the Ice Sea, as well as in several other places, are woods of pine, larch, and other trees; besides which, a considerable quantity of wood is thrown ashore by the waves of the Ice Sea; but whence it comes is not yet ascertained.

Besides the wild owl with which Siberia abounds, <sup>6</sup>Will there is a prodigious number of quadrupeds, some of <sup>beasts,</sup> which are eatable, and others valuable for their skins or furs.

The animals most valued for their skins are the black fox,

some distance from the river Argun, for which purpose they thawed the earth by degrees, and dug some fathoms till they had penetrated a fathom and half below the level of the river, but found no spring. Hence perhaps we may venture to assert, that besides the great elevation of the earth in these countries, there is another cause, perhaps latent in the earth itself, of this extraordinary cold, naturally suggested to us by considering the cavity of an old silver mine at Argun, which being exhausted of its ore, now serves the inhabitants in summer time for a cellar to keep their provisions: this place is so extremely cold as to preserve flesh meats from putrefaction in the hottest summers, and to sink the mercury in de Lisle's thermometer to 146 and 147. The author travelling from Nerfchoi towards Argun, to visit the works of the silver mines in that place, August 1735, came to the river Orkija, near Soionifchaia, on July the 11th, from whence he arrived a little before dark at the village of Seventua, distant from the river 27 leagues. In this journey he and his fellow travellers for more than four leagues felt it vastly cold; soon after they came into a warm air, which continued some leagues; after which the cold returned; and thus are travellers subjected to perpetual vicissitudes of warmth and cold. But it is observed, in general, that the eastern parts are colder than the western, though situated in the same latitude; for as in those eastern regions some tracts of land are much colder than the rest, their effects must be felt by the neighbouring parts. And this conjecture is favoured by the thermometrical observations made with M. de L'Isle's instrument in all parts of Siberia, in which the mercury was depressed to the 226th degree, even in those parts that lie very much towards the south, as in the territory of Selinga, which said degree answers in Fahrenheit's thermometer to about 55.5 below 0, but the same thermometer sometimes indicated a much greater cold. At the fort of Kiringa, on Feb. 10. 1738, at 8 in the morning, the mercury stood at 240, which answers nearly to 72 below 0 in Fahrenheit's. On the 23d of the same month it was a degree lower. At the same place, December 11. at three in the afternoon, it stood at 254 in De Lisle's thermometer, and very near 90 in Fahrenheit's; on December 29. at four in the afternoon, at 263; on November 27. at noon, at 270; January 9. at 275, which several depressions answer in Fahrenheit's to 99.44, 107.73, and 113.65; on January 5. at 5 in the morning, at 262, an hour after at 281, but at eight o'clock it returned to 250, and there remained till 6 in the afternoon, and then rose by degrees till an hour before midnight, when it stood at 202. So that the greatest depression of the mercury answers in Fahrenheit's thermometer to 120.76 degrees below 0, which is indeed very surprising, and what no body ever imagined before. While this cold lasted at Jenisea, the sparrows and magpies fell to the ground, struck dead, as it were, with the frost, but revived if they were soon brought into a warm room. The author was told also that numbers of wild beasts were found in the woods dead and stiff with the frost, and several travellers had their blood and juices quite frozen in their vessels. The air itself at that time was so dismal, that you would think it changed to ice, as it was a thick fog, which was not dissipable by any exhalations, as in the spring and autumn, and the author could scarce stand three minutes in the porch of his house for the cold.

(B) The oak, though frequent in Russia, it is said, is not to be found through this vast region nearer than the banks of the Argun and Amur, in the dominions of China. The white poplar, the aspen, the black poplar, the common fallow, and several species of the willow, are very common. The Norway and silver fir form great forests; but the former does not grow beyond the 60th degree of north latitude, and the latter not beyond 58 degrees. To this dreary region of Siberia, Europe is indebted for that excellent species of oats called *Avena sibirica*, and our gardens are enlivened with the gay and brilliant flowers brought from the same country.

Siberia.

fox, the sable, the hyena, the ermine, the squirrel, the beaver, and the lynx. The skin of a real black fox is more esteemed than even that of a sable. In the country near the Frozen Ocean are also blue and white foxes. The finest sables come from Nerthinsk and Jakutsk, the inhabitants of which places catch them in the mountains of Stannowoi Kriebet. The tributary nations were formerly obliged to pay their taxes in the skins of foxes and sables only. But now the skins of squirrels, bears, rein-deer, &c. and sometimes money, are received by way of tribute; and this not only from those who live near the Lena, but also in the governments of Ilnsk, Irkutsk, Selenginsk, and Nerthinsk. When the Tartars first became tributary to Russia, they brought their furs indiscriminately as they caught them, and among them were often sables of extraordinary value; and formerly, if any trader brought with him an iron kettle, they gave him in exchange for it as many sables as it would hold. But they are now better acquainted with their value. They sell their sables to smugglers at a very high price, and pay only a rouble instead of a skin to the revenue officers, who now receive more ready money than sables, by way of tribute. The subjects plead the scarcity of furs, and indeed not without some appearance of truth.

7  
Minerals.

Siberia has still other and more valuable treasures than those we have yet mentioned. The silver mines of Argun are extremely rich; the silver they produce yield some gold, and both of these are found among the copper ore of Koliwan. This country is also particularly rich in copper and iron ore. The former lies even upon the surface of the earth; and considerable mines of it are found in the mountains of Pictow, Koliwan, Plofkau, Woskerensensk, Kuswi, Alepaik, and several others, and in the government of Krasnoiarisk (c). Iron is still more plentiful in all these places, and very good; but that of Kamenski is reckoned the best. Several hundred thousand puds of these metals are annually exported from the smelting houses, which belong partly to the crown, and partly to private persons. Most of them lie in the government of Catharienburg. The Tartars also extract a great quantity of iron from the ore.

3  
Precious  
Gones.

The topazes of Siberia have a fine lustre, and in open sandy places, near the river Argun, as well as on the banks of other rivers and lakes, are found single small pieces of agate. Here are also cornelians and green jasper with red veins. The latter is chiefly met with in the deserts of Gobilkoi.

9  
Marien-  
glas.

The famous marienglas, or lapis specularis, great quantities of which are dug up in Siberia, is by some called Muscovy or Russian glass; and by others, though with less propriety, isinglass. It is a particular species of transparent stone, lying in strata like so many sheets of paper. The matrix, or stone in which it is found, is partly a light yellow quartz, or marcaffia, and partly a brown indurated fluid; and this stone contains in it all the species of the marienglas. To render the marienglas fit for use, it is split with a thin two-edged

knife; but care is taken that the laminae be not too thin. It is used for windows and lanterns all over Siberia, and indeed in every part of the Russian empire, and looks very beautiful; its lustre and clearness surpassing that of the finest glass, to which it is particularly preferable for windows and lanterns of ships, as it will stand the explosion of cannon. It is found in the greatest plenty near the river Witim.

Siberia

10  
Magnets

Siberia affords magnets of an extraordinary size, and even whole mountains of loadstone. Pit-coal is also dug up in the northern parts of this country. The kamennoe masso, a yellowish kind of alum, unctuous and smooth to the touch, like topaz, is found in the mountains of Krasnoiarisk, Ural, Altaish, Jenisea, Baikal, Bargusik, Lena, and several others in Siberia.

11  
Salt lakes  
and fountains

In this country are not only a great number of fresh water lakes, but likewise several whose waters are salt; and these reciprocally change their nature, the salt sometimes becoming fresh, and the fresh changing into saline. Some lakes also dry up, and others appear where none were ever seen before. The salt lake of Yamuslia, in the province of Tobolsk, is the most remarkable of all, for it contains a salt as white as snow, consisting entirely of cubic crystals. One finds also in Siberia saline springs, salt water brooks, and a hill of salt.

12  
Curiosities

Siberia affords many other things which deserve notice. That useful root called rhubarb grows in vast quantities near the city of Seleginsk. The curious mammoth's bones and horns, as they are called, which are found along the banks of the Oby, Jenesei, Lena, and Irtysh, are unquestionably the teeth and bones of elephants. But whether these elephants teeth and bones were conveyed to these northern regions by the general deluge, or by any other inundation, and were by degrees covered with earth, is a point which might lead us into long and very fruitless disquisitions; we shall therefore only observe, that such bones have likewise been found in Russia, and even in several parts of Germany. A kind of bones of a still larger size than these have also been dug up in Siberia, and seem to have belonged to an animal of the ox kind. The horn of the whale called *narcobal* has been found in the earth near the rivers Indigirka and Anadir; and the teeth of another species of whales, called Wolrofs, about Anadirskoi. The latter are larger than the common sort, which are brought from Greenland, Archangel, and Kola.

13  
Mountains

The chain of Siberian mountains reaches from that of Werchoturic towards the south as far as the neighbourhood of the city of Orienburg, in a continued ridge, under the name of the Uralian mountains; but from thence it alters its direction westward. These mountains are a kind of boundary between Russia Proper and Siberia. Another chain of hills divides Siberia from the country of the Calmucks and Mongolians. — These mountains, between the rivers Irtysh and Oby, are called the Attaic or Golden Mountains, which name they afterwards lose, particularly between the river Jenesei and the Baikal lake, where they are called the Sayanian mountains.

The

(c) The copper mines of Koliwan, from which gold and silver are extracted, employ above 40,000 people. The silver mines of Nerthinsk, beyond lake Baikal, employ above 14,000. The whole revenue arising from these mines, according to Mr Coxe, is not less than L. 679,182, 13s.

*herpia*, The inhabitants of Siberia consist of the Aborigines or ancient inhabitants, the Tartars, and Russians.

*Sibyls*, Some of these nations have no other religion but that of nature; others are Pagans or Mahometans, and some of them have been converted to Christianity, or rather only baptised by the Russian missionaries.

*SIBTHORPIA*, in botany: A genus of plants belonging to the class of didynamia, and to the order of angiospermia; and in the natural system classed with those the order of which is doubtful. The calyx is spreading, and divided into five parts, almost to the base. The corolla is divided into five parts in the same manner, which are rounded, equal, spreading, and of the length of the calyx. The stamina grow in pairs at a distance from each other. The capsule is compressed, orbicular, bilocular, the partition being transverse.— There are two species, the *europæa* and *evolvulacea*. The *europæa*, or bastard money-wort, is a native of South Britain. The stems of it are slender, and creeping. The leaves are small, round, and notched. The flowers grow under the wings of the leaves, are small, and of a pale red colour. It blossoms from July to September, and is found in Cornwall on the banks of rivulets.

*SIBYLS*, in pagan antiquity, certain women said to have been endowed with a prophetic spirit, and to have delivered oracles, showing the fates and revolutions of kingdoms. Their number is unknown. Plato speaks of one, others of two, Pliny of three, Ælian of four, and Varro of ten; an opinion which is universally adopted by the learned. These ten Sibyls generally resided in the following places, Persia, Libya, Delphi, Cumæ in Italy, Erythræa, Samos, Cumæ in Æolia, Marpefia on the Hellespont, Ancyra in Phrygia, and Tiburtis. The most celebrated of the Sibyls is that of Cumæ in Italy, whom some have called by the different names of Amalthæa, Demiphile, Herophile, Daphne, Manto Plemnonoe, and Deiphobe. It is said, that Apollo became enamoured of her, and that to make her sensible of his passion he offered to give her whatever she should ask. The Sibyl demanded to live as many years as she had grains of sand in her hand. but unfortunately forgot to ask for the enjoyment of the health, vigour, and bloom, of which she was then in possession. The god granted her request, but she refused to gratify the passion of her lover though he offered her perpetual youth and beauty. Some time after she became old and decrepit. Her form decayed, melancholy paleness and haggard looks succeeded to bloom and cheerfulness. She had already lived about 700 years when Æneas came to Italy, and, as some have imagined, she had three centuries more to live before her years were as numerous as the grains of sand which she had in her hand. She gave Æneas instructions how to find his father in the infernal regions, and even conducted him to the entrance of hell. It was usual for the Sibyl to write her prophecies on leaves, which she placed at the entrance of her cave; and it required particular care in such as consulted her to take up these leaves before they were dispersed by the wind, as their meaning then became incomprehensible. According to the most authentic historians of the Roman republic, one of the Sibyls came to the palace of Tarquin the Second, with nine volumes, which she offered to sell for a very high price. The monarch disregarded her, and she immediately disappeared,

and soon after returned, when she had burned three of the volumes. She asked the same price for the remaining six books; and when Tarquin refused to buy them, she burned three more, and still persisted in demanding the same sum of money for the three that were left.— This extraordinary behaviour astonished Tarquin; he bought the books, and the Sibyl instantly vanished, and never after appeared to the world. These books were preserved with great care by the monarch, and called the Sibylline verses. A college of priests was appointed to have the care of them; and such reverence did the Romans entertain for these prophetic books, that they were consulted with the greatest solemnity, and only when the state seemed to be in danger. When the capitol was burnt in the troubles of Sylla, the Sibylline verses which were deposited there perished in the conflagration; and to repair the loss which the republic seemed to have sustained, commissioners were immediately sent to different parts of Greece to collect whatever verses could be found of the inspired writings of the Sibyls. The fate of these Sibylline verses which were collected after the conflagration of the capitol is unknown. There are now many Sibylline verses extant, but they are reckoned universally spurious; and it is evident that they were composed in the second century by some of the followers of Christianity, who wished to convince the heathens of their error, by assisting the cause of truth with the arms of pious artifice.

*SICERA*, a name given to any inebriating liquor by the Hellenistic Jews. St Chrysoptom, Theodoret, and Theophilus of Antioch, who were Syrians, and who therefore ought to know the signification and nature of "sicera," assure us, that it properly signifies palm-wine. Pliny acknowledges, that the wine of the palm tree was very well known through all the east and that it was made by taking a bushel of the dates of the palm-tree, and throwing them into three gallons of water; then squeezing out the juice, it would intoxicate like wine. The wine of the palm tree is white: when it is drunk new, it has the taste of the cocoa, and is sweet as honey. When it is kept longer, it grows strong, and intoxicates. After long keeping, it becomes vinegar.

*SICILIAN*, in music, denotes a kind of gay sprightly air, or dance, probably invented in Sicily, somewhat of the nature of an English jig; usually marked with the characters  $\frac{6}{8}$ , or  $\frac{12}{8}$ . It consists of two strains; the first of four, and the second of eight, bars or measures.

*SICILY*, is a large island in the Mediterranean Sea, Boundaries adjoining to the southern extremity of Italy, and ex- and extent. tends from latitude  $36^{\circ} 25'$  to latitude  $38^{\circ} 25'$ , and from longitude  $12^{\circ} 50'$  to longitude  $16^{\circ} 5'$  east from London. Its greatest length 210 miles, breadth 133, circumference 600; its form triangular, the three angles being the promontories of Pelorum, Pachynum, and Lilybæum, or as they are now called the Faro, Capo Passaro, and Capo Boco. It is divided from Italy by the Straits of Messina, reaching from the Tower of Faro, which is the most northerly part of the island, to the *Capo dell'Armi*, or the Cape of Arms, the most southern part of Calabria. These straits, by the Latins called *Fretum Siculum*, by the Italians *Il Faro di Messina*, and by us the *Fare of Messina*, are between 12 and 15 miles over in the broadest places, and in the narrowest about a mile and an half; insomuch that when

Sicera  
||  
Sicily.

Sicily.

Messina was taken by the Carthaginians, many of the inhabitants are said to have saved themselves by swimming to the opposite coasts of Italy. Hence has arisen an opinion that the island of Sicily was originally joined to the continent, but afterwards separated by an earthquake or some other natural cause. This separation, however, is reckoned by the most judicious among the ancients to be fabulous; and they content themselves with speaking of it as a thing said to have happened.

2  
History de-  
ring the fa-  
bulo is  
gce.

2  
Anciently this island was called *Sicania*, *Sicilia*, and *Trinacria* or *Triquetra*; the two former it had from the Sicani and Siculi, who peopled a considerable part of the country; the two latter from its triangular figure. Its first inhabitants, according to the most respectable ancient authors, were the Cyclopes and Iæstrigones, who are said to have settled in the countries adjoining to Mount Etna; but of their origin we know nothing, except what is related by the poets. After them came the Sicani, who called themselves the original inhabitants of the country; but several ancient historians inform us that they came from a country in Spain watered by the river Siconus. Diodorus, however, is of opinion that the Sicani were the most ancient inhabitants of this island. He tells us that they were in possession of the whole, and applied themselves to cultivate and improve the ground in the neighbourhood of Etna, which was the most fruitful part of the island: they built several small towns and villages on the hills to secure themselves against thieves and robbers; and were governed, not by one prince, but each city and district by its own king. Thus they lived till Etna began to throw out flames, and forced them to retire to the western parts of the island, which they continued to inhabit in the time of Thucydides. Some Trojans, after the destruction of their city, landed in the island, settled among the Sicani, and built the cities of Eryx and Egesta, uniting themselves with them, and taking the general name of Elymi or Elymæi. They were afterwards joined by some Phœnicians, who settled here on their return from the siege of Troy.

After the Sicani had for many ages enjoyed an undisturbed possession of the whole of Sicily, or such parts of it as they chose to inhabit, they were visited by the Siculi, who were the ancient inhabitants of Ausonia properly so called; but being driven out from thence by the Opici, they took refuge in the island of Sicily. Not being contented with the narrow bounds allowed them by the Sicani, they began to encroach upon their neighbours; upon which a war ensuing, the Sicani were utterly defeated, and confined to a corner of the island, the name of which was now changed from *Sicania* into that of *Sicilia*.

About 300 years after the arrival of the Siculi, the island first began to be known to the Greeks, who established various colonies, and built many cities in different parts of the island; and it is only from the time of their arrival that we have any history of the island. The first of the Greeks that came into Sicily were the Chalcidians of Eubœa, under the conduct of Thucles, who built Naxos, and a famous altar of Apollo, which, as Thucydides tells us, was still standing in his time without the city. The year after, which was, according to Dionysius Halicarnassensis, the third of the 17th Olympiad, Archias the Corinthian, one of the Hera-

Sicily

clidæ, laid the foundations of Syracuse. Seven years after, a new colony of Chalcidians founded Leontini and Catana, after having driven out the Siculi, who inhabited that tract. About the same time Lamis, with a colony from Megara, a city of Achaia, settled on the river Pantacius, at a place called *Trotulum*, where his adventurers lived some time in common with the Chalcidians of Leontini; but, being driven from thence by the Leontines, he built the city of Thapfus, where he died. Upon his death, the colony left Thapfus; and under the conduct of Hyblon king of the Siculi, founded Megara Hyblæa, where they resided 245 years, till they were driven out by Gelon tyrant of Syracuse. During their abode at Megara, they sent one Pamilus, who was come from Megara in Achaia, their original city, to build Selinus. This city was founded about 100 years after the foundation of Megara. Antiphemus and Entimus, the former a Rhodian, the other a Cretan, led each a colony of their countrymen, and jointly built the city of Gela on a river of the same name, establishing in their new settlement the Doric customs, about 45 years after the founding of Syracuse. The inhabitants of Gela founded Agrigentum 108 years after their arrival in Sicily, and introduced the same customs there. A few years after, Zancle was built by the pirates of Cumæ in Italy; but chiefly peopled by the Chalcidians, Samians, and Ionians, who chose rather to seek new settlements than live under the Persian yoke. Some time after, Anaxales, tyrant of Rhegium, drove out the ancient proprietors; and, dividing his lands amongst his followers, called the city *Messana* or *Messene*, which was the name of his native city in Peloponnesus. The city of Himera was founded by the Zancleans under the direction of Euclides, Simus, and Sacon; but peopled by the Chalcidians and some Syracusan exiles, who had been driven out by the contrary faction.

The Syracusians built Aeræ, Chasmenæ, and Camarina; the first 70 years, the second 90, and the third 135, after the foundation of their own city. This is the account which Thucydides, a most judicious and exact writer, gives us of the various nations, whether Greeks or Barbarians, who settled in Sicily. Strabo counts among the ancient inhabitants of Sicily the Morgetes, who being driven out of Italy by the Oenotrians, settled in that part of the island where the ancient city of Morgantium stood. The Campani, who assumed the name of *Mamertini*, that is, *invincible warriors*, and the Carthaginians, who settled very early in Sicily, ought likewise to be counted among the ancient inhabitants of the island.

Before this period the history of Sicily is blended with fables like the early history of almost every other country. After the settlement of the Greeks in the island, its various revolutions have been traced from their several sources by many writers; but by none with greater accuracy than Mr Swinburne. From his account of his Travels in the Two Sicilies, we have therefore taken the following concise history of this kingdom, which will at once gratify such of our readers as interest themselves in the fate of a generous people who long struggled in vain for freedom; and at the same time afford them a specimen of the entertainment they may receive from the very elegant work of the author.

"Aristocracy prevailed at first in the Greek settlements, but soon made way for tyranny; which in its turn was expelled by democracy. One of the earliest destroyers of common liberty was Phalaris of Agrigentum, who reigned 600 years before Christ: his example was contagious; a legion of tyrants sprang up, and not a commonwealth in the island escaped the lash of an usurper. Syracuse was most oppressed and torn to pieces by dissension; as its wealth and preponderance in the general scale held out a greater temptation than other cities to the ambition of wicked men. It requires the combined testimony of historians to enforce our belief of its wonderful prosperity, and the no less extraordinary tyranny of some of its sovereigns. These Grecian colonies attained to such excellence in arts and sciences as emboldened them frequently to vie with the learned and ingenious in the mother country; nay, often enabled them to bear away the palm of victory: there needs no stronger proof of their literary merits than a bare recital of the names of Archimedes, Theocritus, Gorgias, and Charondas.

"But the Sicilian Greeks were not destined to enjoy the sweets of their situation without molestation. Very soon after their arrival, the inhabitants of the neighbouring coast of Africa began to aspire to a share of Sicily. Carthage sent large bodies of forces at different times to establish their power in the island, and about 500 years before the Christian era had made themselves masters of all the western parts of it. The Siculi retained possession of the midland country, and the southern and eastern coasts were inhabited by the Greeks.

"About that time Gelo was chosen prince of Syracuse on account of his virtues, which grew still more conspicuous after his exaltation: had the example he set been followed by his successors, the advantages of freedom would never have been known or wished for by the Syracusans. The Carthaginians found in him a vigorous opponent to their project of enslaving Sicily, a project invariably pursued but never accomplished.

"Hiero succeeded his brother Gelo, and, contrary to the usual progression, began his reign by a display of bad qualities. Sensible of his error, and improved by experience, he afterwards adopted more equitable measures. At his death the Syracusans threw off the yoke, and for sixty years revelled in all the joys of freedom. Their peace was, however, disturbed by the Athenians and the Carthaginians. The latter plundered Agrigentum, and threatened ruin to the rest of the Grecian states; but a treaty of peace averted that storm. The Athenians, under pretence of supporting their allies the people of Segesta, but in reality from a thirst of dominion, invested Syracuse with a formidable land and naval armament under the command of Nicias; in consequence of a rash indigested plan, ill conducted attacks, and inadequate supplies, their whole host was cut to pieces or led away into captivity.

"Syracuse had scarce time to breathe after her victory ere intestine wars broke out, and raised Dionysius to supreme command. Avarice, despotism, and cruelty, marked every day of his reign; but his military enterprises were crowned with constant success. He died in peace, and bequeathed a powerful sovereignty to a son of his name tainted with the same and worse vices, but not endowed with equal capacity and martial abili-

ty; in such hands the rod of tyranny ceased to be formidable, and the tyrant was driven out of Sicily by the patriotic party; but matters were not sufficiently settled for popular government, and Dionysius resumed the sceptre for a while, till Timoleon forced him into perpetual exile."

Liberty seemed now to be established on a permanent basis; but in Syracuse such prospects always proved illusory. Agathocles, a tyrant more inhuman than any preceding usurper, seized the throne, and deluged the country with blood. He was involved in a perilous contest with the Carthaginians, who obtained many advantages over him, drove his troops from port to port, and at last blocked up his capital. In this desperate situation, when all foreign helps were precluded, and hardly a resource remained at home, the genius of Agathocles compassed his deliverance by a plan that was imitated among the ancients by Hannibal, and among the moderns by the famous Cortes. He embarked with the flower of his army; forced his way through innumerable obstacles; landed in Africa; and, having burnt his fleet, routed the Carthaginians in a pitched battle, and laid their territory waste. Carthage seemed to be on the brink of ruin, and that hour might have marked her downfall had the Sicilian host been composed of patriotic soldiers, and not of ungovernable assassins; discord pervaded the victorious camp, murder and riot ensued; and the tyrant, after beholding his children and friends butchered before his face, escaped to Sicily, to meet a death as tragical as his crimes deserved.

Anarchy now raged throughout the island, and every faction was reduced to the necessity of calling in the assistance of foreign powers; among whom Pyrrhus king of Epirus took the lead, and reduced all parties to some degree of order and obedience. But ambition soon prompted him to invade those rights which he came to defend; he cast off the mask, and made Sicily feel under his sway as heavy a hand as that of its former oppressors; but the Sicilians soon assumed courage and strength enough to drive him out of the island.

About this period the Mamertini, whom Mr Swinburne indignantly styles a crew of miscreants, surprised Messina, and, after a general massacre of the citizens, established a republican form of government. Their commonwealth became so troublesome a neighbour to the Greeks, that Hiero II. who had been raised to the chief command at Syracuse in consideration of his superior wisdom and warlike talents, found himself necessitated to form a league with Carthage, in order to destroy this nest of villains. In their distress the Mamertini implored the assistance of Rome, though the senate had recently punished with exemplary severity one of their own legions for a similar outrage committed at Rhegium. The virtue of the Romans gave way to the temptation, and the desire of extending their empire beyond the limits of Italy, cast a veil over every odious circumstance attending this alliance. A Roman army crossed the Faro, relieved Messina, defeated the Carthaginians, and humbled Hiero into an ally of the republic.

Thus began the first Punic war, which was carried on for many years in Sicily with various success. The genius of Hamilcar Barca supported the African cause under numberless disappointments, and the repeated overthrows of his colleagues; at last, finding his exer-

Sicily.  
12  
The second  
Punic war  
raised by  
Hannibal.

tions ineffectual, he advised the Carthaginian rulers to purchase peace at the price of Sicily. Such a treaty was not likely to be observed longer than want of strength should curb the animosity of the vanquished party: when their vigour was recruited, Hannibal son of Hamilcar easily persuaded them to resume the contest, and for 16 years waged war in the heart of the Roman territories. Meanwhile Hiero conducted himself with so much prudence, that he retained the friendship of both parties, and preserved his portion of Sicily in perfect tranquillity. He died in extreme old age, beloved and respected both at home and abroad.

His grandson Hieronymus, forsaking this happy line of politics, and contracting an alliance with Carthage, fell an early victim to the troubles which his own folly had excited. Once more, and for the last time, the Syracusans found themselves in possession of their independence: but the times were no longer suited to such a system; dissensions gained head, and distracted the public councils. Carthage could not support them, or prevent Marcellus from undertaking the siege of Syracuse, immortalized by the mechanical efforts of Archimedes, and the immensity of the plunder. See SYRACUSE.

13  
Sicily con-  
quered by  
the Sara-  
cens, and  
afterwards  
by the Nor-  
mans.

The Sicilians after this relinquished all martial ideas, and during a long series of generations turned their attention solely to the arts of peace and the labours of agriculture. Their position in the centre of the Roman empire preserved them both from civil and foreign foes, except in two instances of a servile war. The rapacity of their governors was a more constant and insupportable evil. In this state of apathy and opulence Sicily remained down to the 7th century of our era, when the Saracens began to disturb its tranquillity. The barbarous nations of the north had before invaded and ravaged its coasts, but had not long kept possession. The Saracens were more fortunate. In 827 they availed themselves of quarrels among the Sicilians to subdue the country. Palermo was chosen for their capital, and the standard of Mahomet triumphed about 200 years. In 1038 George Maniaces was sent by the Greek emperor with a great army to attack Sicily. He made good his landing, and pushed his conquests with vigour: his success arose from the valour of some Norman troops, which were at that time unemployed and ready to sell their services to the best bidder. Maniaces repaid them with ingratitude; and by his absurd conduct gave the Mussulmen time to breathe, and the Normans a pretext and opportunity of invading the Imperial dominions in Italy. Robert and Roger of Hauteville afterwards conquered Sicily on their own account, not as mercenaries; for having substantially settled their power on the continent, they turned their arms against this island in obedience to the dictates of zeal and ambition. After ten years struggle, the Saracens yielded up the rich prize, and Robert ceded it to his brother Roger, who assumed the title of Great Earl of Sicily, ruled the state with wisdom, and ranks deservedly among the greatest characters in history. He raised himself from the humble station of a poor younger son of a private gentleman, to the exalted dignity of a powerful monarch, by the sole force of his own genius and courage; he governed a nation of strangers with vigour and justice, and transmitted his possessions undisputed to his posterity. Such an assemblage of great qualities is well intitled to our admiration.

He was succeeded by his son Simon, whose reign was short, and made way for a second son called Roger. In 1127 this prince joined to his Sicilian possessions the whole inheritance of Robert Guiscard (see NAPLES, dominion n° 23.), and assumed the regal style. The greatest part of his reign was taken up in quelling revolts in Italy, but Sicily enjoyed profound peace. In 1154 his son William ascended the throne, and passed his life in war and confusion. William II. succeeded his father, and died without issue. Tancred, though basely born, was elected his successor, and after him his son William III. who was vanquished by Henry of Swabia. During the troubles that agitated the reign of his son the emperor Frederic, peace appears to have been the lot of Sicily. A short lived sedition, and a revolt of the Saracens, are the only commotions of which we read. For greater security, the Saracens were removed to Puglia 400 years after the conquest of Sicily by their ancestors. Under Conrad and Manfred Sicily remained quiet; and from that time the history of Sicily is related under the article NAPLES, n° 26, &c.

At the death of Charles II. of Spain, his spoils became an object of furious contention; and at the peace of Utrecht, Sicily was ceded to Victor duke of Savoy, who, not many years after, was forced by the emperor Charles VI. to relinquish that fine island, and take Sardinia as an equivalent. But as the Spaniards had no concern in these bargains, they made a sudden attempt to recover Sicily, in which they failed through the vigilance of the English admiral Byng. He destroyed their fleet in 1718, and compelled them to drop their scheme for a time. In 1734 the Spanish court resumed their design with success. The infant Don Carlos drove the Germans out, and was crowned king of the two Sicilies at Palermo. When he passed into Spain to take possession of that crown, he transferred the Sicilian diadem to his son Ferdinand III. of Sicily and IV. of Naples, and it has ever since remained in the possession of the same family.

Sicily is separated, as we have already observed, from Italy by a narrow strait called the *Faro of Messina*. This strait is still remarkable for the rapidity of its currents and the irregular ebbing and flowing of the sea, which sometimes rushes in with such violence as to endanger ships riding at anchor. Anciently it was much more remarkable for Scylla and Charybdis, the one a rock, and the other a whirlpool, between which it was very dangerous to steer, and concerning which so many fables have been related by the ancients. Scylla is a rock on the Italian side, opposite to Cape Pylores, which runs out into the sea on the Sicilian side. Mr Brydone informs us, that the navigation of the straits is not even yet performed without danger. He informs us, that the noise of the current which sets through the straits may be heard for several miles, like the roaring of some large impetuous river confined between narrow banks. In many places the water rose into whirlpools and eddies, which are dangerous to shipping. The current set exactly for the rock of Scylla, and would certainly have carried any thing thrown into it against that point. Our author, however, is by no means of opinion that the strait is so dangerous as the ancients have represented it; though he thinks that the strait is now probably much wider than formerly, which may have diminished the danger. See SCYLLA. There are many small rocks, which

Sicily.  
14  
Under t  
dominio  
of diffe-  
rent mo-  
narchs.

15  
Is at len  
conquer  
by the S  
iards.

16  
Accoun  
of the Str  
of Mel



which show their heads near the base of the large ones. These are probably the dogs described by the ancient poets as howling round Scylla. The rock is near 200 feet high, and has a kind of castle or fort built on its summit with a town called *Scylla* or *Sciglio*, containing 300 or 400 inhabitants on its south side, which gives the title of prince to a Calabrese family.

Charybdis is now so much diminished, that it seems almost reduced to nothing in comparison of what it was, though even yet it is not to be passed without danger. See CHARYBDIS.

In the straits, Mr Brydone informs us, a most surprising phenomenon is to be observed. In the heat of summer, after the sea and air have been much agitated, there appears in the heavens over the straits a great variety of singular forms, some at rest and others moving with great velocity. These forms, in proportion as the light increases, seem to become more aerial, till at last, some time before sun-rise, they totally disappear. The Sicilians represent this as the most beautiful sight in nature. Leonti, one of their best and latest writers, says, that the heavens appear crowded with a variety of objects, such as palaces, woods, gardens, &c. besides the figures of men and other animals that appear in motion among them. Some treatises have been written concerning this phenomenon; but nothing satisfactory has been delivered concerning its cause.

Though Sicily lies in a warm climate, the air is healthful, being refreshed with sea-breezes on every side. It has at all times been remarkably fertile; but the era of its greatest prosperity was from the siege of Syracuse by the Athenians to the Carthaginian conquests. Then and long after it supplied with grain in years of scarcity all the countries upon the Mediterranean except Egypt and the coasts of Asia, and Rome and Carthage continually. Even now, under all the impediments of superstition and bad government, its productions are, in quantity and quality, the best in Europe. Of the vegetable are grain, wines, oil, fruits, tobacco, mulberry trees for the silkworm, cotton, medicinal roots, and sugar canes. The last of these flourish near Avola and Merilli. They are of an inferior quality to those of the West Indies, but their sugar is sweeter than any other. The animal production is similar to that of Italy, but the horned cattle are a smaller breed. The coasts abound with fish, particularly with tunney and anchovies; the export of which forms a very lucrative branch of commerce. There are mines of silver, copper, and lead, but none are worked. Near Palma are beds of the best sulphur: at the mouth of the river Giaretta is found a yellow amber, preferable to that of the Baltic; and in every part of the island quarries of marbles, that have furnished materials for all the noble edifices of Sicily. The most beautiful are in the neighbourhood of Palermo, particularly the yellow, and those that resemble the verde antique, porphyry, and lapis lazuli. The population of the island amounts to 1,300,000 souls; not as much again as the single city of Syracuse formerly contained.

Here are several rivers and good springs; but few of the rivers are navigable, having but a short course, and descending precipitately from the mountains. The chief are the Cantera, the Jarretta, and the Salfo; of which, the two former run from west to east, and the third from north to south.

Of the mountains in this island the most noted is Mount Etna, now called *Monte Gibello*, or *Mongibello*, a volcano whose eruptions have often proved fatal to the neighbouring country. See ETNA.

Were the Sicilians a cultivated people, among whom those arts were encouraged which not only promote the wealth and comfort of a nation, but also exercise the nobler faculties and extend the views of mankind, the circumstances of their government are such, that it might gradually be improved into a free constitution: but to this, the ignorance, superstition, and poverty, of the people seem to be invincible obstacles. The monarchical power in Sicily is far from being absolute; and the parliament claims a share of public authority independently of the will of the king, deduced from a compact made between Roger and the Norman barons after the expulsion of the Saracens. This claim is denied by the king, who wishes the nobles to consider their privileges as derived solely from his favour. Hence the government is in a situation which greatly resembles that of our own and the other kingdoms of Europe in the feudal times; there are continual jealousies and oppositions between the king and the barons, of which an enlightened people might easily take advantage, and obtain that share in the constitution which might secure them from future oppression. In these disputes, the king has the advantage at least of power if not of right; and several works, in which the claims of the Sicilian barons have been asserted, were publicly burned a few years ago.

As the sovereign holds his court at Naples, Sicily is governed by a viceroy, who is appointed only for three years, though at the end of that term his commission is sometimes renewed. He lives in great state, and, as the representative of the king, his power is very considerable. He presides in all the courts and departments of government, and is commander in chief of all the forces: he calls or dissolves the parliament when he pleases; and by him all orders, laws, and sentences, must be signed: but his office is far from being desirable, as it generally renders him the object either of the jealousy of the court of Naples, or of the hatred of the Sicilians.

The parliament consists of the nobles, the bishops, and abbots, and the representatives of 43 cities, which are immediately subject to the crown. Those cities which are subject to any of the nobles send no members to the parliament; in these the king has not much authority, and derives little advantage from them. According to the laws, the parliament ought to be assembled at the end of every three years: but the government pays little attention to this rule. The common people are in general very much attached to the nobles, and are inclined to take their part in all their differences with the court: but the magistrates and principal inhabitants of the cities which belong to these feudal lords, wish to get rid of their authority, and imagine that they should be less oppressed, if immediately subject to the king: these inclinations are not disagreeable to the court, and are encouraged by most of the lawyers, who are of great service to government in contesting the privileges of the nobles. Many of these privileges are now abridged; and the power of the barons, with respect to the administration of justice in their domains, was very properly limited by the viceroy Caraccioli,

Sicily.

19  
Constitution and government.Muntz's  
Memoirs relative to  
Naples and  
Sicily.

Sicily.  
Inquisition

Caraccioli, in the year 1785. The government of this noblesman was very beneficial to Sicily, as he, in a great measure, cleared the island of the banditti that used to infest it, and made several excellent regulations for the establishment of social order and personal security. He deserves the thanks of every well-wisher to mankind for having abolished the court of inquisition, which had been established in this country by Ferdinand the Catholic, and made dependent on the authority of the grand inquisitor of Spain. Its last *auto da fe* was held in the year 1724, when two persons were burned. At length Charles III. rendered it independent of the Spanish inquisitor, and abridged its power, by forbidding it to make use of the torture, and to inflict public punishments. The Marchese Squillace, and his successor the Marchese Tanucci, were both enemies to the hierarchy; and, during their viceroalties, took care to appoint sensible and liberal men to the office of inquisitor: the last of whom was Ventimiglia, a man of a most humane and amiable character, who heartily wished for the abolition of this diabolical court, and readily contributed toward it. While he held the office of inquisitor, he always endeavoured to procure the acquittal of the accused; and when he could succeed no other way, would pretend some informality in the trial. The total annihilation of this instrument of the worst of tyranny was reserved for Caraccioli. A priest being accused to the inquisition, was dragged out of his house and thrown into the dungeon. He was condemned; but, on account of informality, and a violation of justice in the trial, he appealed to the viceroy, who appointed a committee of jurists to examine the process. The inquisitor refused to acknowledge the authority of this commission; pretending that to expose the secrets of the holy office, and to submit its decisions to the examination of lay judges, would be so inconsistent with his duty, that he would see the inquisition abolished rather than consent to it. Caraccioli took him at his word, and procured a royal mandate by which the holy office was at once annihilated. He assembled all the nobility, judges, and bishops, on the 27th of March 1782, in the palace of the inquisition, and commanded the king's order to be read; after which he took possession of the archives, and caused all the prisons to be set open: in these were at that time only two prisoners, who had been condemned to perpetual confinement for witchcraft. The papers relating to the finances were preserved; but all the rest were publicly burned. The possessions of the holy office were assigned to the use of churches and charitable institutions: but the officers then belonging to it retained their salaries during their lives. The palace itself is converted into a customhouse, and the place where heretics were formerly roasted alive for the honour of the Catholic faith, is now changed into a public garden. The cognizance of offences against orthodoxy is committed to the bishops: but they cannot cite any one to appear before them without permission from the viceroy; neither can they confine any person to a solitary prison, nor deny him the privilege of writing to his friends, and conversing freely with his advocate. The nobility are so numerous in this island, that Labat says it is paved with noblemen. The general assembly of parliament is composed of 66 archbishops, bishops, abbots, and priors, which form the *Braecchio ecclesiastico*.

21  
Abolished  
by Carac-  
cioli.

Fifty-eight princes, 27 dukes, 37 marquises, 27 counts, 1 viscount, and 79 barons, form the *militaire*; and the *demaniale* consists of 43 representatives of free towns. Out of each *bracchio* four deputies are chosen to conduct public business. But the viceroy, the prince of Butera, and the praetor of Palermo, are always the three first. *N. B.* There are many titled persons that have no seat in the assembly, viz. 62 princes, 55 dukes, 87 marquises, 1 count, and 282 other feudatories. There are three archbishoprics and seven bishoprics; and the island, ever since it was conquered by the Saracens, has been divided into three parts or valleys; namely, the *Val di Demone*, *Val di Noto*, and *Val di Mazzara*.

SICINNIUS (*Dentatus*), a tribune of the people, lived a little after the expulsion of the kings from Rome. He was in 120 battles and skirmishes, besides single combats, in all of which he came off conqueror. He served under nine generals, all of whom triumphed by his means. In these battles he received 45 wounds in the fore-part of his body, and not one in his back. The senate made him great presents, and he was honoured with the name of the Roman Achilles.

SICYOS, in botany: A genus of plants belonging to the class of monœcia, and to the order of *Syngenesia*; and in the natural system arranged under the 34th order, *Cucurbitaceæ*. The male flowers have their calyx quinqueparted, their corolla quinquepartite, and there are three filaments. The female flowers have their calyx and corolla similar; but their style is triid, and their drupa monospermous. There are three species, the *angulata*, *laciniata*, and *garcini*, which are all foreign plants.

SIDA, *Yellow or Indian Mallow*, in botany: A genus of plants belonging to the class of monadelphica, and to the order of polyandria; and in the natural system ranging under the 37th order, *Columniferae*. The calyx is simple and angulated; the style is divided into many parts; there are several capsules, each containing one seed. There are 27 species. 1. The *Spinosa*; 2. *Angustifolia*; 3. *Alba*; 4. *Rhombifolia*; 5. *Alnifolia*; 6. *Ciliaris*; 7. *Retusa*; 8. *Triquetra*; 9. *Jamaicensis*; 10. *Carpinifolia*; 11. *Viscosa*; 12. *Cordifolia*; 13. *Umbellata*; 14. *Paniculata*; 15. *Atrofanguinea*; 16. *Periplocifolia*; 17. *Urens*; 18. *Arborea*; 19. *Occidentalis*; 20. *Americana*; 21. *Abutilon*; 22. *Mauritiana*; 23. *Asiatica*; 24. *Indica*; 25. *Crispa*; 26. *Cristata*; 27. *Fernata*. The first 18 species have 15 capsules; the rest are multicapsular. They are all natives of warm climates; and most of them are found in the East or West Indies.

The Chinese make cords of the *sida abutilon*. This plant loves water, and may be advantageously planted in marshes and ditches, where nothing else will grow. From experiments made by the Abbé Cavanilles, a Spaniard, which are inserted in the *Mém. de l'Acad. Royale*, it appears that the plants succeed best when sown in May, and they arrive at perfection in three months and a half. The maceration of the smaller stalks is finished in about 15 days; of the larger in a month. The strength and goodness of the thread appeared to be in proportion to the perfection of the vegetation, and to the distance the plant was kept at from other plants. The fibres lie in strata, of which there are sometimes six: they are not quite straight, but preserve an undulating direction, so as to form a network in their nat-

Sicinnii  
||  
Sida.

ral positions. Their smell resembles that of hemp; the fibres are whiter, but more dry and harsh than those of hemp. The harshness is owing to a greenish gluten which connects the fibres; and the white colour must always be obtained at the expence of having this kind of thread less supple; when of its natural hue, it is very soft and flexible. This description belongs chiefly to the sida; but it will also apply to the malva crispa, Peruviana, and Mauritiana. The malva crispa gave, however, the greatest quantity of fibres, and its gluten was most copious. The fibres of the sida abutson, and the malva crispa, are the longest and the strongest; those of the Peruviana and Mauritiana are the shortest and weakest. The fibres of those plants which had lost their leaves are less strong, though of equal length with those which had preserved them.

SIDDEE, or SEDEE: an Arabic title, by which the Abyssinians or Habashys are always distinguished in the courts of Hindostan; where, being in great repute for firmness and fidelity, they are generally employed as commanders of forts or in posts of great trust.

SIDEREAL YEAR. See *ASTRONOMY-Index*.

SIDERIA, in natural history, the name of a genus of crystals, used to express those altered in their figure by particles of iron. These are of a rhomboidal figure, and composed only of six planes. Of this genus there are four known species. 1. A colourless, pearly, and thin one; found in considerable quantities among the iron ores of the forest of Dean in Gloucestershire, and in several other places. 2. A dull, thick, and brown one; not uncommon in the same places with the former. And, 3. A black and very glossy kind, a fossil of great beauty; found in the same place with the others, as also in Leicestershire and Suffex.

SIDERITE, a substance discovered by Mr Meyer, and by him supposed to be a new metal; but Messrs Bergman and Kirwan have discovered that it is nothing else than a natural combination of the phosphoric acid with iron. Mr Klaproth of Berlin also came to the same conclusion, without any communication with Mr Meyer. It is extremely difficult to separate this acid from the metal; however, he found the artificial compound of phosphoric acid and iron to agree in its properties with the calx sideri alba obtained by Bergman and Meyer from the cold-frost iron extracted from the swampy or marshy ores. The discovery of this substance, however, may be accounted an important affair in chemistry, as we are thus furnished with an immense quantity of phosphoric acid, which might be applied to useful purposes if it could be separated from the metal.

SIDERITIS, IRONWORT, in botany: A genus of plants belonging to the class of didynamia, and to the order of gymnospermia; and in the natural system ranging under the 47d order, *Verticillata*. The stamina are within the tube of the corolla. There are two stigmas, one of which is cylindrical and concave; the other, which is lower, is membranous, shorter, and sheathing the other. The species are 13. 1. The Canariensis, or Canary ironwort, which is a native of Madeira and the Canary islands; 2. The Candicans, which is also a native of Madeira; 3. The Syriaea, a native of the Levant; 4. The Perfoliata, a native of the Levant; 5. The Montana, a native of Italy and Austria; 6. The Elegans; 7. The Romana, a native of Italy; 8. The Incana, a

native of Spain; 9. The Hypsipifolia, a native of Italy and the Pyrenees; 10. The Scordioides, a native of the south of France; 11. The Hirsuta, which is indigenous in the south of Europe; 12. The Ciliata; 13. The Lanata.

SIDEROXYLON, IRON-WOOD, in botany: A genus of plants belonging to the class of pentandria, and to the order of monogynia; and in the natural system ranging under the 43d order, *Dumosa*. The corolla is cut into 10 parts, the lacinae or segments being incurvated alternately; the stigma is simple; the berry contains five seeds. There are ten species: 1. Mite; 2. Inerne, smooth iron-wood; 3. Melanophleum, laurel-leaved iron-wood; 4. Festidissimum; 5. Cymosum—both natives of the Cape of Good Hope; 6. Sericum, silky iron-wood, a native of New South Wales; 7. Tenax, silvery-leaved iron-wood, a native of Carolina; 8. Lycioides, willow-leaved iron-wood, a native of North America; 9. Spinosum, thorny iron-wood or argan, a native of Morocco; 10. Decandrum.

The wood of these trees being very close and solid, has given occasion for this name to be applied to them, it being so heavy as to sink in water. As they are natives of warm countries, they cannot be preserved in this country unless they are placed, the two former in a warm stove, the others in a green-house. They are propagated by seeds, when these can be procured from abroad.

SIDNEY (Sir Philip), was born, as is supposed, at Penshurst in Kent in the year 1554: His father was Sir Henry Sidney, an Irish gentleman, and his mother Mary the eldest daughter of John Dudley duke of Northumberland. He was sent when very young to Christchurch college at Oxford, but left the university at 17 to set out on his travels. After visiting France, Germany, Hungary, and Italy, he returned to England in 1575, and was next year sent by Queen Elizabeth as her ambassador to Randolph emperor of Germany. On his return he visited Don John of Austria, governor of the Netherlands, by whom he was received with great respect. In 1579, when Queen Elizabeth seemed on the point of concluding her long projected marriage with the duke of Anjou, Sir Philip wrote her a letter, in which he dissuaded her from the match with unusual elegance of expression, as well as force of reasoning. About this time a quarrel with the earl of Oxford occasioned his withdrawing from court; during which retirement he is supposed to have written his celebrated romance called *Arcadia*.

In 1585, after the queen's treaty with the United States, he was made governor of Flushing and master of the horse. Here he distinguished himself so much both by his courage and conduct, that his reputation rose to the highest pitch. He was named, it is pretended, by the republic of Poland as one of the competitors for that crown, and might even have been elected had it not been for the interference of the queen. But his illustrious career was soon terminated; for in 1586 he was wounded at the battle of Zutphen, and carried to Arnheim, where he soon after died. His body was brought to London, and buried in St Paul's cathedral. He is described by the writers of that age as the most perfect model of an accomplished gentleman that could be formed even by the wanton imagination of poetry or fiction. Virtuous conduct, polite conversation, heroic valour,

Sideroxylon,  
Sidney.

Sidney.

lour, and elegant erudition, all concurred to render him the ornament and delight of the English court: and as the credit which he enjoyed with the queen and the earl of Leicester was wholly employed in the encouragement of genius and literature, his praises have been transmitted with advantage to posterity. No person was so low as not to become an object of his humanity. After the battle of Zutphen, while he was lying on the field mangled with wounds, a bottle of water was brought him to relieve his thirst; but observing a soldier near him in a like miserable condition, he said, *This man's necessity is still greater than mine*; and resigned to him the bottle of water. Besides his *Arcadia*, he wrote several smaller pieces both in prose and verse, which have been published.

SIDNEY (Algernon), was the second son of Robert earl of Leicester, and of Dorothy eldest daughter of the earl of Northumberland. He was born about the year 1617. During the civil war he took part against the king, and distinguished himself as a colonel in the army of the parliament. He was afterwards appointed one of king Charles's judges, but declined appearing in that court. During the usurpation of Cromwel, Sidney, who was a violent republican, retired to the country, and spent his time in writing those discourses on government which have been so deservedly celebrated. After the death of the Protector, he again took part in the public transactions of his country, and was abroad on an embassy to Denmark when king Charles was restored. Upon this he retired to Hamburgh, and afterwards to Francfort, where he resided till 1677, when he returned to England and obtained from the king a pardon. It has been affirmed, but the story deserves no credit, that during his residence abroad king Charles hired ruffians to assassinate him. After his return he made repeated attempts to procure a seat in parliament, but all of them proved unsuccessful. After the intention of the commons to seclude the duke of York from the throne had been defeated by the sudden dissolution of parliament, Sidney joined with eagerness the councils of Russel, Essex, and Monmouth, who had resolved to oppose the duke's succession by force of arms. Frequent meetings were held at London; while, at the same time, a set of subordinate conspirators, who were not, however, admitted into their confidence, met and embraced the most desperate resolutions. Keiling, one of these men, discovered the whole conspiracy; and Algernon Sidney, together with his noble associates, was immediately thrown into prison, and no art was left unattempted in order to involve them in the guilt of the meaner conspirators.

Howard, an abandoned nobleman, without a single spark of virtue or honour, was the only witness against Sidney; but as the law required two, his discourses on government, found unpublished in his closet, were construed into treason, and declared equivalent to another witness. It was in vain for Sidney to plead that papers were no legal evidence; that it could not be proved they were written by him; and that if they were, they contained nothing treasonable. The defence was over-ruled; he was declared guilty, condemned, and executed! His attainder was reversed in the first year of king William.

He was a man of extraordinary courage; steady even to obstinacy; of a sincere but rough and boisterous

temper. Though he professed his belief in the Christian religion, he was an enemy to an established church, and even, according to Burnet, to every kind of public worship. In his principles he was a zealous republican: government was always his favourite study; and his essays on that subject are a proof of the progress which he made.

SIDON (anc. geog.), a city of Phœnicia in Asia, famous in Scripture for its riches, arising from the extensive commerce carried on by its inhabitants. Heavy judgments were denounced against the Sidonians on account of their wickedness, which were accomplished in the time of Ochus king of Persia: for that monarch having come against them with an army on account of their rebellion, the city was betrayed by its king; upon which the wretched inhabitants were seized with despair; they set fire to their houses, and 40,000, with their wives and children, perished in the flames.

This city is now called *Saïde*, and, according to Mr Bruce's account, not only its harbour is filled up with sand, but the pavement of the ancient city stood  $7\frac{1}{2}$  feet lower than the ground on which the present city stands. Volney describes it as an ill-built dirty city. Its length along the sea-shore is about 600 paces, and its breadth 150. At the north-west side of the town is the castle, which is built in the sea itself, 80 paces from the main land, to which it is joined by arches. To the west of this castle is a shoal 15 feet high above the sea, and about 200 paces long. The space between this shoal and the castle forms the road, but vessels are not safe there in bad weather. The shoal, which extends along the town, has a basin inclosed by a decayed pier. This was the ancient port; but it is so choaked up by sand, that boats alone can enter its mouth near the castle. Fakr-el-din, emir of the Druses, destroyed all these little ports from Bairout to Acre, by sinking boats and stones to prevent the Turkish ships from entering them. The basin of Saïde, if it were emptied, might contain 20 or 25 small vessels. On the side of the sea, the town is absolutely without any wall; and that which encloses it on the land side is no better than a prison-wall. The whole artillery does not exceed six cannons, and these are without carriages and gunners. The garrison scarcely amounts to 100 men. The water comes from the river Aoula, through open canals, from which it is fetched by the women. These canals serve also to water the orchards of mulberry and lemon trees.

Saïde is a considerable trading town, and is the chief emporium of Damascus and the interior country. The French, who are the only Europeans to be found there, have a consul, and five or six commercial houses. Their exports consist in silks, and particularly in raw and spun cottons. The manufacture of this cotton is the principal art of the inhabitants, the number of whom may be estimated at about 5000. It is 45 miles west from Damascus. E. Long. 36. 5. N. Lat. 37.

SIDUS GEORGIUM, in astronomy, a new primary planet, discovered by Dr Herschell in the year 1781. By most foreign, and even by some British philosophers, it is known by the name of *Herschell*, an honour which is due to the discoverer. As the other planets are distinguished by marks or characters, the planet Herschell is distinguished by an H, the initial letter of the discoverer's name, and a cross to show that it is a Christian planet. From many calculations of our best astron-

**Siege** || **Sierra.** mers and mathematicians, says Dr Herfchell, I have collected the following particulars, as most to be depended upon.

Place of the node	-	2° 11' 49" 30"
Inclination of the orbit	-	43' 35"
Place of the perihelion	-	172° 13' 17"
Time of the perihelion passage		Sep. 7. 1799
Eccentricity of the orbit		.82034
Half the greater axis		19,07904
Revolution	-	83,3364 sidereal years.

From my own observations on this planet's apparent diameter, which I have found cannot well be less than 4", nor indeed much greater, we infer, that its real diameter is to that of the earth as 4,454 to 1; and hence it appears to be of very considerable bulk, and, except Saturn and Jupiter, by far the largest of the remaining planets. Its light is of a bluish-white colour, and in brilliancy between that of the Moon and of Venus. With a telescope which magnifies about 300 times, it appears to have a very well defined visible disk; but with instruments of a small power, it can hardly be distinguished from a fixed-star of between the sixth and seventh magnitude. In a very fine clear night, when the moon is absent, it may also be seen by the naked eye.

**SIEGE**, in the art of war, is to surround a fortified place with an army, and approach it by passages made in the ground, so as to be covered against the fire of the place.

**SIEGEN**, a town of Germany in Wetteravia, with a castle and the title of a principality, which it gives to a branch of the house of Nassau. It is seated on a river of the same name, in E. Long. 8. 5. N. Lat. 50. 53.

**SIENNA**, a large, ancient, and celebrated city of Tuscany in Italy; capital of the Siennese, with an archbishop's see, a famous university, and a citadel. It is about four miles in circumference, and surrounded with an old wall. The metropolitan church is much esteemed by travellers; and though it is a Gothic structure, the architecture is admirable. It is built with black and white marble, and the pavement is of Mosaic work. The town is adorned with a great number of palaces, fountains, and superb churches, as also a magnificent hospital. The great area is round, and the houses about it are of the same height, supported by piazzas, under which people may walk in hot or rainy weather; in the middle is a basin, which can be filled with water at any time, to represent a sea fight with small vessels. The Italian language is taught here with such purity, that a great many foreigners frequent it on that account. It is seated on three eminences, in a fertile soil, in E. Long. 11. 11. N. Lat. 43. 10.

**SIENNESE**, a duchy in Italy; bounded on the north by the Florentino, on the south by the Mediterranean sea and the duchy of Castro, on the east by the Perugino and Orvietano, and on the west by the Florentino and the Tuscan sea; being about 55 miles in length, and as much in breadth. The soil is pretty fertile, especially in mulberry trees, which feed a great number of silk-worms; and there are several mineral springs. Sienna is the capital town.

**SIERRA LEONA**, a large country on the west coast of Africa, which some extend from the Grain Coast

on the south-east to Cape Verga or Vega on the north-west, *i. e.* between 7° and 10° N. Lat. Others, however, confine the country between Cape Verga and Cape Tagrin. There runs through it a great river of the same name, of which the source is unknown, but the mouth is in longitude 12. 30. west, lat. 8. 5. north, and is nine miles wide. The climate and soil of this tract of country appear to be, on both sides of the river, among the best in Africa, or at least the most favourable to European constitutions. The heat is much the same as that of the West Indies; but on the higher grounds there is a cool sea breeze, and in the mountainous parts the air is very temperate. According to Lieutenant Matthew, "Sierra Leona, if properly cleared and cultivated, would be equal in salubrity and superior in produce to any of the islands in the West Indies;" and others have affirmed, that "the air is better for a man's health than in many places of Europe." These advantages of climate induced the English to establish a factory at Sierra Leona; but they chose not the most healthful situation. For the benefit of a spring of good water they fixed their residence in a low valley, which is often overspread with mists and noisome vapours, while the air is clear and serene on the summits of the hills, to which water from the well might be easily carried.

The animal productions of this country are lions, from which it has its name; leopards, hyenas, musk cats, and many kinds of weasels; the japanzee or chimpanzee, a species of simia, which has a still more striking resemblance to the human figure than even the ouran outang; porcupines, wild hogs, squirrels, and antelopes. Besides these, which are natives of the country, oxen thrive in it, and even grow fat; asses too are employed in labour, and do not suffer by the climate; but sheep suffer much from the heat, change their wool into hair, grow lean and increase very little; while the hardy goat is here as prolific and large as in any other country. Of the birds which frequent the woods of Sierra Leona we can give no perfect account. A species of crane is mentioned as easily tamed; common poultry multiply fast; ducks thrive well, but geese and turkeys seem not to agree with the climate. Turtles of all kinds are very common, and sometimes of a large size. Crocodiles or alligators of a non-descript species have been found ten or twelve feet in length, and lizards of six different species. Snakes, which are almost innumerable, haunt the houses in the night in search of poultry; and one was observed which measured 18 feet, but was happily found not to be venomous. Fishes are in great variety both in the sea and in the rivers. Besides the whale, the shark, stinging ray, and porpoise, there are eels, horse-mackerel, tarpoons, cavillos, mullets, snappers, yellow-tails, old-maids, ten-pounders, and some other fishes; all of which, except the eels and ten-pounders, are esteemed fine eating. Oysters are found in great abundance, and another shell-fish, which the natives eat. Among the zoophytes, none is more worthy of notice than the common sponge, which covers all the sandy beaches of the river, particularly on the Bullom shore, and would fetch a high price in Great Britain.

Of the numerous vegetable productions of Sierra Leona, our limits will permit us only to mention the following. Rice, which is the plant chiefly cultivated, as the natives subsist almost entirely upon it, grows both

Sierra.

in the high and low grounds. It prospers indeed best in swamps, though the grain is better in a drier soil. Next to rice the cassava constitutes the chief food of the inhabitants, and is cultivated with great care. The country likewise produces yams, various kinds of potatoes, eddoes, or the *arum esculentum*. Oil-palm, plantains, and bananas; papaw, guava, oranges and limes; pompions, melons, and cucumbers; pine-apples, pigeon-peas, which dressed like English peas are a good pulse; maize or Indian corn; millet, cocoa-nut trees; ockra; the tallow-tree; a great variety of tamarinds; different kinds of fig-trees and plums; a kind of fruit resembling grapes, but more acid and acrid; cherries resembling a fine nectarine in taste; a species of the bread fruit-tree; the cream fruit, so called because when wounded it yields a fine white juice resembling sugar or the best milk, of which the natives are very fond; the malaguetta pepper, or grains of paradise; a new species of nutmeg, but whether so good as the common sort has not yet been ascertained; a new species of the Peruvian bark, which it is hoped will prove as useful as the other; and cola, a fruit highly esteemed by the natives for the same virtues with that bark; the vicinus, cassia, dyestuffs, and gums, of great value; cotton, tobacco, and sugar-canes, which, it is thought, would thrive exceedingly well under proper cultivation.

Considering the ardour of the maritime nations of Europe for settling colonies in distant regions of the globe, it is somewhat surprising that a climate so temperate and a soil so productive as that of Sierra Leona did not long ago attract their notice. But it was left to be colonized for a better purpose than that which first drew the natives of Europe to the West Indies and the American continent. Being thinly inhabited, Sierra Leona appeared to some benevolent gentlemen in England a place where, without incommoding the natives, a sufficient quantity of ground might be bought on which to settle a great number of free negroes, who in 1786 swarmed in London in idleness and want. About 400 of these wretches, together with 60 whites, mostly women of bad character and in ill health, were accordingly sent out, at the charge of government, to Sierra Leona. Necessity, it was hoped, would make them industrious and orderly; and Captain Thomson of the navy, who conducted them, obtained, for their use, a grant of land to his majesty from king Tom, the neighbouring chief, and afterwards from Naimbanna, the king of the country. The colony, however, soon went to ruin; but the land which they occupied being about 20 miles square, his majesty was enabled to grant by act of parliament to another colony founded on better principles and for a still nobler purpose.

The most intelligent members of that society, which has laboured so strenuously to procure an abolition of the slave-trade, justly concluding that the natives of Guinea would reap very little benefit from the attainment of their object, unless they should be taught the principles of religion and the arts of civil life, which alone can render them really free, conceived the plan of a colony at Sierra Leona to be settled for the truly generous purpose of civilizing the Africans by maintaining with them a friendly intercourse, and a commerce in every thing but men. This plan could not be carried into effect but at a very great expence. Subscriptions were therefore opened upon rational and equitable

terms, and a sum deemed sufficient was speedily raised. An act of parliament was passed in favour of the subscribers, by which they were incorporated by the denomination of the *Sierra Leona Company*; and in pursuance of that act they held their first meeting at London on the 19th of October 1791, when the following gentlemen were chosen directors for that year.

“Henry Thornton, Esq; M. P. chairman—Philip Sanfom, Esq; deputy chairman—Sir Charles Middleton, Bart.—Sir George Young, Knt.—William Wilberforce, Esq; M. P.—Rev. Thomas Clarkson, A. M.—Joseph Hardcastle, Esq;—John Kingdon, Esq;—Samuel Parker, Esq;—Granville Sharp, Esq;—William Sandford, Esq;—Vickeris Taylor, Esq;—George Wolf, Esq;”

The directors having stated the natural advantages of Sierra Leona, and its present miserable condition, observed, that they had not merely to establish a commercial factory, but that, to introduce civilization, cultivation, and a safe trade, the company must provide for the security of the persons and property of the colonists. The directors therefore resolved, that three or four vessels should sail at once, with such a number of people as would be able to protect and assist each other; with goods both for trade and for the supply of the colony. Accordingly several vessels sailed, having on board a council for the government of the colony and the management of the company's affairs; a number of artificers and other servants of the company; some soldiers, and a very few English settlers. The directors were laudably cautious in the choice of colonists. They admitted into the society no white man of bad character, or who was not a declared enemy to the slave-trade; and as the chief object of their enterprise was the civilization of the natives, it was with great propriety that they chose more than three-fourths of their settlers from the free negroes in Nova Scotia, who had borne arms for the British government during the American war. The superintendent and council were particularly instructed to secure to all blacks and people of colour, at Sierra Leona, equal rights and equal treatment, in all respects, with whites. They were to be tried by jury, as well as others; and the council was desired to allot to the blacks employments suited to their present abilities, and to afford them every opportunity of cultivating their talents. All practicable means of maintaining subordination were directed to be used; and the council was especially instructed to promote religion and morals, by supporting public worship and the due observance of the Sabbath, and by the instruction of the people, and the education of children. But no person was to be prevented from performing or attending religious worship in whatever place, time, or manner, he might think fit, or from peaceably inculcating his own religious opinions. Orders were given in choosing the site of a town, to consider health as the first object; and the first town was directed to be called *Free-Town*. Articles for building and cultivation were sent out, besides the cargoes for prosecuting the company's commerce; and schools for reading, writing, and accounts, were ordered to be set up for the purpose of instructing the children of such natives as should be willing to put them under the company's care.

The leading object of the company was to substitute, for that disgraceful traffic which has too long subsisted,

Sierra.

a fair commerce with Africa, and all the blessings which might be expected to attend it. Considerable advantages appeared hereby likely to result to Great Britain, not only from our obtaining several commodities cheaper, but also from opening a market for British manufactures, to the increasing demands of which it is difficult to assign a limit. From this connection, Africa was likely to derive the still more important benefits of religion, morality, and civilization. To accomplish these purposes, it was necessary for the company to possess a tract of land, as a repository for their goods, and which the Africans might cultivate in peace, secure from the ravages of the slave-trade. It had been ascertained, beyond a doubt, that the climate and soil of Africa were admirably suited to the growth of sugar, spices, coffee, cotton, indigo, rice, and every other species of tropical produce. The company proposed to instruct the natives to raise these articles, and to set them the example, by a spirited cultivation, on its own account. Directions were given to the company's commercial agent to push forward a trade, in a mode prescribed, in the present produce of Africa. Measures were taken for cultivating, on the company's account, the most profitable tropical produce; and in particular, a person of long experience in the West Indies was ordered to begin a sugar plantation. A mineralogist and botanist were likewise engaged to go out and explore the country for new articles of commerce.

Every thing being thus settled upon the most equitable and benevolent principles, the ships sailed with the British colonists, to whom, in March 1792, were added 1131 blacks from Nova Scotia. The native chiefs being reconciled to the plan, and made to understand its beneficent tendency towards their people, the colony proceeded to build *Free-Town*, on a dry and rather elevated spot on the south side of the river. It occupied between 70 and 80 acres, its length being about one-third of a mile, and its breadth nearly the same; and it contained near 400 houses, each having one-twelfth of an acre annexed, on which a few vegetables were raised. There were nine streets running from north-west to south-east, and three cross streets, all 80 feet wide, except one of 160 feet, in the middle of which were all the public buildings. These consisted of a governor's house and offices; a large store-house; a large hospital; six or eight other houses, offices, and shops, occupied by the company's servants; and a church capable of containing 800 people. The colonists at first suffered much from the rainy season, against which it was not in their power to provide sufficient protection; but at the end of it they recovered in a great measure their health and spirits, and proceeded with alacrity to execute the various purposes of their settlement. To excite emulation in culture, the government gave premiums to those colonists who raised the greatest quantities of rice, yams, eddoes, cabbages, Indian corn, and cotton, respectively. To limit the excesses of the slave-trade, and gain the favour of the neighbouring chiefs, the directors instructed the governor and council to redeem any native from the neighbourhood, who should be unjustly sold either to or by a British subject. The servants of the company conducted themselves with the utmost propriety, being sober, moral, and exemplary; and from the labours of the clergymen were derived services highly important in every point of view. Before the end of two years

from the institution of the colony, order and industry had begun to show their effects in an increasing prosperity. The woods had been cut down to the distance of about three English miles all round the town. By these means the climate had become healthier, and sickness had diminished. The fame of the colony had spread not only along the whole western coast of Africa, but also to parts far distant from the coast; embassies had been received of the most friendly nature from kings and princes several hundred miles distant; and the native chiefs had begun to send their children to the colony, with full confidence, to be taught reading, writing, and accounts, and to be brought up in the Christian religion. In a word, it was not without grounds that the directors looked forward to that joyful period when, by the influence of the company's measures, the continent of Africa should be rescued from her present state of darkness and misery, and exhibit a delightful scene of light and knowledge, of civilization and order, of peaceful industry and domestic comfort. On their beneficent exertions they hoped with confidence for the blessing of Providence; they were countenanced and supported by the British government; and upon the breaking out of the present war, the French Convention authorised one of their agents to write to the directors, requesting a full account of the design of the institution, and the names of the ships employed in their service, and assuring them of the good wishes of the French government to so noble an undertaking. How completely that government fulfilled its promise is very generally known. Having vindicated the rights of man in Europe by the violation of every principle of truth and justice, they determined by the same means to give light and liberty to the Africans; and that they have fully carried their determination into effect will be seen by the following extract of a letter from Mr Afzelius, the company's botanist, dated Sierra Leona, 15th November 1794. "The French have been here and have ruined us. They arrived on the 28th of September last, early in the morning, with a fleet consisting of one large ship, two frigates, two armed brigs, and one cutter, together with two large armed merchant ships, taken by them at the Isles de Lofs, an English slave factory to the north of our colony, and which they have also destroyed and burnt. So well had they concealed their nation, that we took them at first for English. They had English-built vessels, which were rigged in the English way. They showed the English flag, and had their sailors, at least those we saw on deck, dressed like English. In short, we did not perceive our mistake till we observed them pointing their guns. We had not strength sufficient to resist, and therefore our governor gave orders, that as soon as they should begin to fire, the British flag should be struck, and a flag of truce hoisted. Accordingly this was done, but still they continued firing, and did much damage, both within and without the town. They killed two people and wounded three or four. But, as we did not understand the meaning of this proceeding, we asked them for an explanation; and they answered us, that we should display the flag of liberty, as a proof of our submission. We assured them that it should already have been done, if we had had any, which terminated the hostilities from the ships. In the mean time, most of the inhabitants had fled from the town, having taken with them as much of their

Sierra.

property as they conveniently could in such a hurry. I was with the governor, together with a number of others; but as soon as I was certain they were enemies, I went towards my own house with a view to save as much as possible of my property and natural collections; but was received in such manner, that I could not venture to proceed. My house was situated near the shore, and unfortunately just opposite the frigate which fired. I saw the balls passing through the house, and heard them whizzing about my ears. I saw that I should lose all my property; but life was dearer to me, and I hastened to the woods.

"In the afternoon the enemy landed, finding the town almost destitute of people, but rich in provisions, clothing, and other stores. They began immediately to break open the houses and to plunder. What they did not want, they destroyed, burnt, or threw into the river. They killed all the cattle and animals they found in the fields or streets, yards, or elsewhere, not sparing even asses, dogs, and cats. These proceedings they continued the whole succeeding week, till they had entirely ruined our beautiful and prospering colony; and when they found nothing more worth plundering, they set fire to the public buildings and all the houses belonging to the Europeans; and burnt, as they said, by mistake nine or ten houses of the colonists. In the mean time, they were not less active on the water. They sent three of their vessels to Bance island, an English slave factory higher up the river, which they plundered and burnt, together with some slave ships lying there. They took besides about 10 or 12 prizes, including the company's vessels. Most of these they unloaded and burnt. They took along with them also two of our armed vessels, one of which was a large ship, laden with provisions, and which had been long expected; but she unfortunately arrived a few days too soon, and was taken with her whole cargo. We expected at least to receive our private letters, but even this was refused, and they were thrown overboard. At last, after inflicting on us every hardship we could suffer, only sparing our lives and the houses of the colonists, they sailed on the 13th of October last, at noon, proceeding downwards to the Gold Coast, and left us in the most dreadful situation, without provisions, medicines, clothes, houses, or furniture, &c. &c. and I fear much, that most of us should have perished, had not our friends in the neighbourhood, both natives and Europeans, who were so happy as to escape the enemy, been so kind as to send us what they could spare. In the mean time, most of us have either been, or still are, very sick, and many have died for want of proper food and medicine. The worst, however, is now past. At least we are not in any want of provision, although of the coarsest kind, but are destitute of the most necessary articles and utensils for the house, the table, and the kitchen."

It was thus that the Convention executed their purpose of spreading light and liberty through the world. The Sierra Leona colony was established for no other end than to abolish the slave-trade, to enlighten the Africans, and to render them virtuous, rational, free, and happy; and those powerful patrons of the rights of man destroyed that colony with many circumstances of the most wanton cruelty. Though Mr Afzelius is a Swede, and ought therefore to have been protected by the laws of neutrality, they burnt his house with the

rest; deprived him of his trunks, his clothes, and his bed; destroyed the natural curiosities which he had collected at the hazard of his life; and carried away the instruments by means of which only he could collect more. It is with pleasure, however, that we learn from the proceedings of the general court held on the 25th of February 1795, that the directors do not yet despair of the colony; and that they have adopted the most prudent measures to avert all such calamities in future. That their benevolent labours may be finally crowned with success is our earnest prayer, in which we shall, doubtless, be joined by every good Christian.

SIERRA MORENA, mountains of Andalusia in Spain.

SIEUR, a title of respect among the French, like that of *master* among us. It is much used by lawyers, as also by superiors in their letters to inferiors.

SIFANTO, or SIPHANTO, an island of the Archipelago, to the west of Paros, to the north-east of Milo, and to the south-west of Serphanto. The air is so good here, that many of the inhabitants live to the age of 120; and their water, fruits, wild fowl, and poultry, are excellent, but more especially the grapes. It abounds with marble and granite, and is one of the most fertile and best cultivated of these islands. The inhabitants employ themselves in cultivating olive-trees and capers; and they have very good silk. They trade in figs, onions, wax, honey, and straw-hats; and may be about 8000 in all. E. Long. 25. 15. N. Lat. 37. 9.

SI-FANS, or TŌU-FANS, a people inhabiting the country on the west of China. Their country is only a continued ridge of mountains, inclosed by the rivers Hoang-ho on the north, Ya-long on the west, and Yang-tse-kiang on the east, between the 30th and 35th degrees of north latitude.

*Græter's General Description of China, vol. i. p. 203.*

The Si-fans are divided into two kinds of people; the one are called by the Chinese *Black Si-fans*, the other *Yellow*; names which are given them from the different colours of their tents. The black are the most clownish and wretched; they live in small hodies, and are governed by petty chiefs, who all depend upon a greater.

The yellow Si-fans are subject to families, the oldest of which becomes a lama, and assumes the yellow dress. These lama princes, who command in their respective districts, have the power of trying causes, and punishing criminals; but their government is by no means burdensome; provided certain honours are paid them, and they receive punctually the dues of the god Fo, which amount to very little, they molest none of their subjects. The greater part of the Si-fans live in tents; but some of them have houses built of earth, and even brick. Their habitations are not contiguous; they form at most but some small hamlets, consisting of five or six families. They feed a great number of flocks, and are in no want of any of the necessaries of life. The principal article of their trade is rhubarb, which their country produces in great abundance. Their horses are small; but they are well shaped, lively, and robust.

These people are of a proud and independent spirit, and acknowledge with reluctance the superiority of the Chinese government, to which they have been subjected; when they are summoned by the mandarins, they rarely appear; but the government, for political reasons,

winks

Sierra  
Sifans



Winks at this contempt, and endeavours to keep these intractable subjects under by mildness and moderation: it would, besides, be difficult to employ rigorous means in order to reduce them to perfect obedience; their wild and frightful mountains (the tops of which are always covered with snow, even in the month of July) would afford them places of shelter, from which they could never be driven by force.

The customs of these mountaineers are totally different from those of the Chinese. It is, for example, an act of great politeness among them to present a white handkerchief of taffety or linen, when they accost any person whom they are desirous of honouring. All their religion consists in their adoration of the god Fo, to whom they have a singular attachment: their superstitious veneration extends even to his ministers, on whom they have considered it as their duty to confer supreme power and the government of the nation.

**SIGAULTIAN OPERATION**, a method of delivery in cases of difficult labour, first practised by M. Sigault. It consists in enlarging the dimensions of the pelvis, in order to procure a safe passage to the child without injuring the mother. See **MIDWIFERY**, chap. vii.

**SIGESBECKIA**, in botany: A genus of plants belonging to the class of syngenesia, and to the order of polygamia superflua; and in the natural system ranging under the 49th order, *Compositæ*. The receptacle is pappaceous; the pappus is wanting; the exterior calyx is pentaphyllous, proper, and spreading; the radius is halved. There are three species: 1. The *orientalis*, which is a native of India and China. 2. The *occidentalis*, which is a native of Virginia. 3. The *fuscifolia*, a native of Peru.

**SIGETH**, a town of Lower Hungary, and capital of a county of the same name. It is seated in a morass, and has a triple wall, with ditches full of water; and is defended by a citadel, being one of the strongest places in Hungary. It now belongs to the house of Austria, and was retaken from the Turks in 1669, after it had been blocked up two years. In some maps it is called *Zivat*. E. Long. 18. 58. N. Lat. 46. 17.

**SIGHING**, an effort of nature, by which the lungs are put into greater motion, and more dilated, so that the blood passes more freely, and in greater quantity, to the left auricle, and thence to the ventricle. Hence we learn, says Dr Hales, how sighing increases the force of the blood, and consequently proportionably cheers and relieves nature, when oppressed by its too slow motion, which is the case of those who are dejected and sad.

**SIGHT**, or **VISION**. See **ANATOMY**, n<sup>o</sup> 142. and *Index* subjoined to **OPTICS**.

*Imperfection of SIGHT with regard to Colours*. Under the article **COLOURS**, is given an instance of a strange deficiency of sight in some people who could not distinguish between the different colours. In the *Phil. Trans.* Vol. LXVIII. p. 611. we have an account of a gentleman who could not distinguish a claret colour from black. These imperfections are totally unaccountable from any thing we yet know concerning the nature of this sense.

*Second SIGHT*. See **SECOND SIGHT**.

**SIGN**, in general, the mark or character of something absent or invisible. See **CHARACTER**.

Among physicians, the term *sign* denotes some appearance in the human body which serves to indicate or

point out the condition of the patient with regard to health or disease.

**SIGN**, in algebra. See **ALGEBRA**, Part I.

**SIGN**, in astronomy, a constellation containing a 12th part of the zodiac. See **ASTRONOMY**, n<sup>o</sup> 318.

**NAVAL SIGNALS**. When we read at our fire-side the account of an engagement, or other interesting operation of an army, our attention is generally so much engaged by the results, that we give but little to the movements which led to them, and produced them, and we seldom form to ourselves any distinct notion of the conduct of the day. But a professional man, or one accustomed to reflection, and who is not satisfied with the mere indulgence of eager curiosity, follows every regiment in its movements, endeavours to see their connection, and the influence which they have had on the fate of the day, and even to form to himself a general notion of the whole scene of action at its different interesting periods. He looks with the eye of the general, and sees his orders succeed or fail.

But few trouble themselves farther about the narration. The movement is ordered; it is performed; and the fortune of the day is determined. Few think how all this is brought about; and when they are told that during the whole of the battle of Custrin, Frederic the Great was in the upper room of a country inn, from whence he could view the whole field, while his aids de camp, on horseback, waited his orders in the yard below, they are struck with wonder, and can hardly conceive how it can be done: but, on reflection, they see the possibility of the thing. Their imagination accompanies the messenger from the inn yard to the scene of action; they hear the General's orders delivered, and they expect its execution.

But when we think for a moment on the situation of the commander of a fleet, confined on board one ship, and this ship as much, or more closely, engaged, than any other of the fleet; and when we reflect that here are no messengers ready to carry his orders to ships of the squadron at the distance of miles from him, and to deliver them with precision and distinctness, and that even if this were possible by sending small ships or boats, the vicissitudes of wind and weather may render the communication so tedious that the favourable moment may be irretrievably lost before the order can be conveyed.—When we think of all these circumstances, our thoughts are bewildered, and we are ready to imagine that a sea-battle is nothing but the unconnected struggle of individual ships; and that when the admiral has once “cried havoc, and let slip the dogs of war,” he has done all that his situation empowers him to do, and he must leave the fate of the day to the bravery and skill of his captains and sailors.

Yet it is in this situation, apparently the most unfavourable, that the orders of the commander can be conveyed, with a dispatch that is not attainable in the operations of a land army. The scene of action is unincumbered, so that the eye of the General can behold the whole without interruption. The movements which it is possible to execute are few, and they are precise. A few words are sufficient to order them, and then the mere fighting the ships must always be left to their respective commanders. This simplicity in the duty to be performed has enabled us to frame a language fully adequate to the business in hand, by which a correspondence can be kept up as far as the eye can see. This is

Sign.  
Naval  
Signals.

Naval  
Signals.

the language of SIGNALS, a language by writing, addressed to the eye, and which he that runneth may read. As in common writing certain arbitrary marks are agreed on to express certain sounds used in speech, or rather, as in hieroglyphics certain arbitrary marks are agreed on to express certain thoughts, or the subjects of these thoughts; so here certain exhibitions are made, which are agreed on to express certain movements to be executed by the commander to whom they are addressed, and all are enjoined to keep their eyes fixed on the ship of the conductor of the fleet, that they may learn his will.

<sup>2</sup>  
Used in  
ancient  
times,

It is scarcely possible for any number of ships to act in concert, without some such mode of communication between the general and the commanders of private ships. We have no direct information of this circumstance in the naval tactics of the ancient nations, the Greeks and Romans; yet the necessity of the thing is so apparent, that we cannot suppose it to have been omitted by the most ingenious and the most cultivated people who have appeared on the great theatre of the world; and we are persuaded that Themistocles, Conon, and other renowned sea commanders of Athens, had signals by which they directed the movements of their fleets. We read, that when Ægeus sent his son Theseus to Crete, it was agreed on, that if the ship should bring the young prince back in safety, a white flag should be displayed. But those on board, in their joy for revisiting their country after their perilous voyage, forgot to hoist the concerted signal. The anxious father was every day expecting the ship which should bring back his darling son, and had gone to the shore to look out for her. He saw her, but without the signal agreed on. On which the old man threw himself into the sea. We find, too, in the history of the Punic wars by Polybius, frequent allusions to such a mode of communication; and Ammianus Marcellinus speaks of the *speculatores* and *vesillarii*, who were on board the ships in the Adriatic. The coins both of Greece and Rome exhibit both flags and streamers. In short, we cannot doubt of the ancients having practised this hieroglyphical language. It is somewhat surprising that Lord Dudley, in his *Arcano del Mare*, in which he makes an ostentatious display of his knowledge of every thing connected with the sea service, makes no express mention of this very essential piece of knowledge, although he must, by his long residence in Italy, have known the marine discipline of the Venetians and Genoese, the greatest maritime powers then in Europe.

<sup>3</sup>  
As well  
as in mo-  
dern;

In the naval occurrences of modern Europe, mention is frequently made of signals. Indeed, as we have already observed, it seems impossible for a number of ships to act in any kind of concert, without some method of communication. Numberless situations must occur, when it would be impossible to convey orders or information by messengers from one ship to another, and coast and alarm signals had long been practised by every nation. The idea was, therefore, familiar. We find, in particular, that Queen Elizabeth, on occasion of the expedition to Cadiz, ordered her secretaries to draw up instructions, which were to be communicated to the admiral, the general, and the five counsellors of war, and by them to be copied and transmitted to the several ships of the navy, not to be opened till they should arrive in a certain latitude. It was on this occasion, (says our historian Guthrie), "that we meet

with the first regular sets of signals and orders to the commanders of the English fleet. But, till the movements of a fleet have attained some sort of uniformity, regulated and connected by some principles of propriety, and agreed on by persons in the habit of directing a number of ships, we may with confidence affirm that signals would be nothing but a parcel of arbitrary marks, appropriated to particular pieces of naval service, such as attacking the enemy, landing the soldiers, &c.; and that they would be considered merely as referring to the final result, but by no means pointing out the mode of execution, or directing the movements which were necessary for performing it.

It was James II. when duke of York, who first considered this practice as capable of being reduced into a system, and who saw the importance of such a composition. He, as well as the king his brother, had always showed a great predilection for the sea service; and, when appointed admiral of England, he turned his whole attention to its improvement. He had studied the art of war under Turenne, not as a pastime, but as a science, and was a favourite pupil of that most accomplished general. Turenne one day pointed him out, saying, "Behold one who will be one of the first princes and greatest generals of Europe." When admiral of England, he endeavoured to introduce into the maritime service all those principles of concert and arrangement which made a number of individual regiments and squadrons compose a great army. When he commanded in the Dutch war, he found a fleet to be little better than a collection of ships, on board of each of which the commander and his ship's company did their best to annoy the enemy, but with very little dependence on each other, or on the orders of the General; and in the different actions which the English fleet had with the Dutch, every thing was confusion as soon as the battle began. It is remarkable that the famous pensionary De Witt, who from a statesman became a navigator and a great sea commander in a few weeks, made the same representation to the States General on his return from his first campaign.

In the memoirs of James II. written by himself, we have the following passage: "1665. On the 15th of March the duke of York went to Gunfleet, the general rendezvous of the fleet, and hastened their equipment. He ordered all the flag officers on board with him every morning, to agree on the order of battle and rank. In former battles, no order was kept, and this under the duke of York was the first in which fighting in a line and regular form of battle was observed."

This must be considered as full authority for giving the duke of York the honour of the invention. For whatever faults may be laid to the charge of this unfortunate prince, his word and honour stands unimpeached. And we are anxious to vindicate his claim to it, because our neighbours the French, as usual, would take the merit of this invention, and of the whole of naval tactics, to themselves. True it is, that Colbert, the great and justly celebrated minister of Louis XIV. created a navy for his ambitious and vain-glorious master, and gave it a constitution which may be a model for other nations to copy. By his encouragement, men of the greatest scientific eminence were engaged to contribute to its improvement: and they gave us the first treatises of naval evolutions. But it must ever be remembered, that our accomplished, though misguided sovereign, was then residing

Naval  
Signal

<sup>4</sup>  
But fir-  
formed  
to a syl-  
by Jam-  
when c-  
of Yor-

Naval Signals.

Naval Signals.

Pepps as secretary to the duke of York.

Wonderful simplicity in his system;

6 et as an improvement.

residing at the court of Louis; that he had formerly acted in concert with the French as a commander and flag officer, and was at this very time aiding them with his knowledge of sea affairs. In the memorable day at La Hogue, the gallant Ruffel, observing one of Tourville's movements, exclaimed, "There! they have got Pepps† among them." This anecdote we give on the authority of a friend, who heard an old and respectable officer (Admiral Clinton) say, that he had it from a gentleman who was in the action, and heard the words spoken; and we trust that our readers will not be displeased at having this matter of general opinion established on some good grounds.

It was on this occasion, then, that the duke of York made the movements and evolutions of a fleet the object of his particular study, reduced them to a system, and composed that "System of Sailing and Fighting Instructions," which has ever since been considered as the code of discipline for the British navy, and which has been adopted by our rivals and neighbours as the foundation of their naval tactics. It does great honour to its author, although its merit will not appear very eminent to a careless surveyor, on account of that very simplicity which constitutes its chief excellence. It is unquestionably the result of much sagacious reflection and painful combination of innumerable circumstances, all of which have their influence; and it is remarkable, that although succeeding commanders have improved the subject by several subordinate additions, no change has to this day been made in its general principles or maxims of evolution.

Till some such code be established, it is evident that signals can be nothing but arbitrary and unconnected hieroglyphics, to be learned by rote, and retained by memory, without any exercise of the judgment; and the acquisition of this branch of nautical skill must be a more irksome task than that of learning the Chinese writing. But such a code being once settled, the character in which it may be expressed becomes a matter of rational discussion.

Accordingly, the sailing and fighting instructions of the duke of York were accompanied by a set of signals for directing the chief or most frequent movements of the fleet. These also were contrived with so much judgment, and such attention to distinctness, simplicity, and propriety, that there has hardly been any change found necessary; and they are still retained in the British navy as the usual signals in all cases when we are not anxious to conceal our movements from an enemy.

Notwithstanding this acknowledged merit of the duke of York's signals, it must be admitted that great improvements have been made on this subject, considered as an art. The art military has, in the course of a century past, become almost an appropriate calling, and has therefore been made the peculiar study of its professors. Our rivals the French were sooner, and more formally, placed in this situation, and the ministers of Louis XIV. took infinite and most judicious pains to make their military men superior to all others by their academical education. A more scientific turn was given to their education, and the assistance of scientific men was liberally given them; and all the nations of Europe must acknowledge some obligations to them for information on every thing connected with the art of war. They have attended very much to this subject, have greatly improved it, and have even introduced a

new principle into the art; and by this means have reduced it to the most simple form of reference to the code of sailing and fighting instructions, by making the signals immediately expressive, not of orders, but of simple numbers. These numbers being prefixed to the various articles of the code of instructions, the officer who sees a signal thrown out by the admiral reads the number, and reports it to his captain, perhaps without knowing to what it relates. Thus simplicity and brevity, with an unlimited power of variation, are combined. We believe that M. de la Bourdonnais, a brave and intelligent officer, during the war 1758, was the author of this ingenious thought.

We do not propose to give a system of British signals. This would evidently be improper. But we shall show our readers the practicability of this curious language, the extent to which it may be carried, and the methods which may be practised in accomplishing this purpose. This may make it an object of attention to scientific men, who can improve it; and the young officer will not only be able to read the orders of the commander in chief, but will not be at a loss, should circumstances place him in a situation where he must issue orders to others.

Signals may be divided into,

I. DAY SIGNALS.

II. NIGHT SIGNALS; and,

III. SIGNALS in a FOG.

They must also be distinguished into, 1. Signals of EVOLUTION, addressed to the whole FLEET, or to SQUADRONS of the fleet, or to DIVISIONS of these squadrons. 2. Signals of MOVEMENTS to be made by particular ships; and, 3. Signals of SERVICE, which may be either general or particular,

The great extent of a large fleet, the smoke in time of battle, and the situation of the commander in chief, who is commonly in the midst of the greatest confusion and hottest fire, frequently makes it very difficult for the officers of distant ships to perceive his signals with distinctness. Frigates, therefore, are stationed out of the line, to windward or to leeward, whose sole office is to observe the admiral's signals, and instantly to repeat them. The eyes of all the signal officers in the private ships of war are directed to the repeating frigates, as well as to the admiral; and the officers of the repeating frigate, having no other duty, observe the admiral incessantly, and, being unembarrassed by the action, can display the signal with deliberation, so that it may be very distinctly seen. Being minutely acquainted with the substitutions which must be made on board the admiral when his masts and rigging are in disorder, his (perhaps imperfect) signal is exhibited by the repeating frigate in its proper form, so as to be easily understood. And to facilitate this communication, the commanders of the different squadrons repeat the signals of the commander in chief, and the commanders of division repeat the signals of the commanders of their squadron.

Every evolution signal is preceded by a signal of ADVERTISEMENT and PREPARATION, which is general, and frequently by a gun, to call attention; and when all the signals have been made which direct the different parts of that evolution, another signal is made, which marks the close of the complex signal, and divides it from others which may immediately follow it: and as the orders of the commander in chief may relate either to the movements of the whole fleet, those of a single division, or those

7 During an engagement the signals of the Admiral are repeated by frigates stationed out of the line.

8 Evolution signals are preceded by a signal of advertisement, and accompanied with a directive signal.

Naval  
Signals.

those of certain private ships, the EXECUTIVE SIGNAL, which dictates the particular movement, is accompanied by a DIRECTIVE SIGNAL, by which these ships are pointed out, to which the order is addressed.

9  
Answered  
by the com-  
mander to  
whom they  
are address-  
ed.

The commander of the ship to which any signal is addressed, is generally required to signify by a signal (which is general) that he has observed it. And if he does not thoroughly understand its meaning, he intimates this by another general signal. And here it is to be observed, that as soon as the signal is answered by the ships to which it is addressed, it is usual to haul it down, to avoid the confusion which might arise from others being hoisted in the same place. The order remains till executed, notwithstanding that the signal is hauled down.

10  
Annuling  
signal.

It may happen that the commander who throws out the signal for any piece of service, sees reasons for altering his plan. He intimates this by a general ANNULING signal, accompanying the signal already given. This will frequently be more simple than to make the signals for the movements which would be required for re-establishing the ships in their former situation.

All these things are of very easy comprehension, and require little thought for their contrivance. But when we come to the particular evolutions and movements, and to combine these with the circumstances of situation in which the fleet may be at the time, it is evident, that much reflection is necessary for framing a body of signals which may be easily exhibited, distinctly perceived, and well understood, with little risk of being mistaken one for another. We shall take notice of the circumstances which chiefly contribute to give them these qualities as we proceed in describing their different classes.

### I. Of DAY SIGNALS.

THESE are made by means of the ship's sails, or by colours of various kinds.

Those made with sails are but few in number, and are almost necessarily limited to the situation of a fleet at anchor. Thus,

The following Signals	usually signify,
Main top-gallant stayfail hoisted	Officers and men belonging to the ship to come on board.
Fore top-fail loose	To prepare for sailing.
Main top fail loose	To unmoor.
Main top-fail sheets hauled home	To weigh.
Main top-fail sheets clewed up, and the yard hoisted	Annul the former signal, and the ship to come to an anchor.
Top-gallant sails loose, and the sheets flying	Discovering strange sails.
Main top-gallant fail loose and hoisted. Top-fail-yard down	Recal ships in chase.
Mizen top-fail hoisted, and the sheets clewed up	Moore.

Before we proceed to the description of the signals by means of colours, such as FLAGS, BANNERS (or triangular flags), PENDANTS OR VANES, we must take notice of the ostensible distinctions of the various divisions and

subdivisions of a fleet, so that we may understand how the same signal may be addressed to a squadron, division, or single ship or ships. We suppose it known that a fleet of ships of war is distributed into three grand divisions (which we shall term *squadrons*), called the *van*, *centre*, and *rear*. These denominations have not always a relation to the one being more advanced than the other, either towards the enemy, or in the direction of their course.

In a land army, the position of every part is conceived from its reference to the enemy; and the reader, conceiving himself as facing the enemy, easily understands the terms *van*, *centre*, and *rear*, the *right* and *left wing*, &c. But the movements of a sea army having a necessary dependence on the wind, they cannot be com-

Naval  
Signals.

11  
Meaning  
of the term  
*van*, *centre*  
and *rear*, is  
the line of  
battle at

prehended unless expressed in a language which keeps this circumstance continually in view. The simplest and most easily conceived disposition of a fleet, is that in which it is almost indispensably obliged to form in order to engage an enemy. This is a straight line, each ship directly a-head of its neighbour, and close hauled. This is therefore called the *line of battle*. In this position, the two extremities of the fleet correspond to the right and left wings of an army. Suppose this line to be in the direction east and west, the wind blowing from the north-north-west, and therefore the fleet on the starboard tack; the ships heads are to the west, and the westernmost division is undoubtedly the van of the fleet, and the easternmost division is the rear. And it is in conformity to this arrangement and situation that the LIST OF THE FLEET is drawn up. But the ships may be on the same east and west line, close hauled, with their heads to the west, but the wind blowing from the south-south-west. They must therefore be on the larboard tack. The same ships, and the same division, are still, in fact, the van of the fleet. But suppose the ships heads to be to the eastward, and that they are close hauled, having the wind from the south-south-east or the north-north-east, the ships which were the real van on both tacks in the former situation are now, in fact, the rear on both tacks; yet they retain the denomination of the *van squadron* of this fleet, and are under the immediate direction of the officer of the second rank, while the other extremity is under the direction of the third officer. This subordination therefore is rather an arrangement of rank and precedence than of evolution. It is, however, considered as the NATURAL ORDER to which the general signals must be accommodated. For this reason, the division which is denominated *van* in the list of this fleet, is generally made to lead the fleet when in the line of battle on the starboard tack, and to form the *weathermost* column in the order of sailing in columns; and, in general, it occupies that station from which it can most easily pass into the place of the leading division on the starboard line of battle ahead. Although this is a technical nicety of language, and may frequently puzzle a landsman in reading an account of naval operations, the reflecting and intelligent reader will see the propriety of retaining this mode of conceiving the subordinate arrangement of a fleet, and will comprehend the employment of the signals which are necessary for re-establishing this arrangement, or directing the movements while another arrangement is retained.

This being understood, it is easy to contrive various methods

aval  
a s.  
12  
y sig  
are ad-  
ded to  
of  
divi-

methods of distinguishing every ship by the place which she occupies in the fleet, both with respect to the whole line, with respect to the particular squadron, the particular division of that squadron, and the particular place in that division. This may be done by a combination of the position and colour of the pendants and vanes of each ship. Thus the colour of the pendants may indicate the squadron, their position or mast on which they are hoisted may mark the division of that squadron, and a distinguishing vane may mark the place of the private ship in her own division. The advantages attending this method are many. In a large fleet it would hardly be possible for the commander in chief to find a sufficient variety of single signals to mark the ship to which an order is addressed, by hoisting it along with the signal appropriated to the intended movement. But by this contrivance one third part of these signals of address is sufficient. It also enables the commander in chief to order a general change of position by a single signal, which otherwise would require several. Thus, suppose that the fore, main, and mizen masts, are appropriated (with the proper modifications) for exhibiting the signals addressed to the van, the centre, and the rear squadrons of the fleet, and that a red, a white, and a blue flag, are chosen for the distinguishing flags of the officers commanding these squadrons; then, if the commander in chief shall hoist a red flag at his mizen top-gallant mast head, it must direct the van squadron to take the position then occupied by the rear squadron, the evolution necessary for accomplishing this end being supposed known by the commander of the squadron, who will immediately make the necessary signals to the squadron under his particular direction. In the same manner, the distinguishing signal for the leading ship of a squadron being hoisted along with the signal of address to the whole fleet, and the signal for any particular service, will cause the three or the nine leading ships to execute that order, &c. &c.

All that has been said hitherto may be considered as so many preparations for the real issuing of orders by the commander in chief. The most difficult part of the language remains, viz. to invent a number of signals which shall correspond to that almost infinite variety of movements and services which must be performed.

3  
erial  
tics  
gnals  
difficu-

Distinctness, simplicity, and propriety, are the three essential qualities of all signals. A signal must be some object easily seen, strongly marked, so that it may be readily understood, with little risk of its being mistaken for another. When made by flags, banners, or pendants, they must be of the fullest colours, and strongest contrasts. The ships are frequently at a very great distance, so that the intervening air occasions a great degradation of colour. They are seen between the eye and a very variable sky; and in this situation, especially in the morning or evening, or a dark day, it is not easy to distinguish one full colour from another, all of them approaching to the appearance of a black. At the distance of a very few miles hardly any full colours can be distinguished but a scarlet and a blue. Red, blue, yellow, and white, are the colours which can be distinguished at greater distances than any others, and are therefore the only colours admitted as signals. Even these are sometimes distinguished with difficulty. A yellow is often confounded with a dirty white, and a

blue with a red. All other dark colours are found totally unfit. But as these afford but a small variety, we must combine them in one flag, by making it striped, spotted, or chequered, taking care that the opposition of colour may be as great as possible, and that the pieces of which the flags are made up may not be too minute. Red must never be striped nor spotted with blue, and the stripes, spots, or chequers, should never be less than one-third of the breadth of the flag. Plate CCCCLXVI. is a selection by an officer of experience as a set very easily recognised, and little liable to be confounded. Their colours are represented by hatching, in the same manner as in heraldry (See HERALDRY).

Difference of shape, as flags, banners, or pendants, is another distinction by which the expression may be varied. And in doing this, we must recollect, that in light winds it may be difficult to distinguish a flag from a banner, as neither are fully displayed for want of wind to detach the fly from the staff.

And, lastly, signals may be varied by their position, <sup>14</sup>simplicity, which may be on any lofty and well detached part of the masts, yards, or rigging.

Simplicity is an eminent property in all signals. They are addressed to persons not much accustomed to combinations, and who are probably much occupied by other pressing duties. It were to be wished that every piece of service could be indicated by a single flag. This is peculiarly desirable with respect to the signals used in time of battle. The rapid succession of events on this occasion call for a multitude of orders from the commander in chief, and his ship is frequently clad over with flags and pendants, so that it is exceedingly difficult for the signal officer of a private ship to distinguish the different groups, each of which make a particular signal.

These considerations are the foundation of a certain <sup>15</sup>And pr- propriety in signals, which directs us to a choice among <sup>15</sup>15:15 marks which appear altogether arbitrary. Signals which run any risk of being confounded, on account of some resemblance, or because their position hinders us from immediately perceiving their difference, should be appropriated to pieces of service which are hardly possible to be executed, or can hardly be wanted, in the same situation. No bad consequence could easily result though the signal for *coming to close action* should resemble that for *unmooring*, because the present situation of the ships makes the last operation impossible or absurd. Such considerations direct us to select for battle signals, those which are of easiest exhibition, are the most simple, and have the least dependence on the circumstance of position; so that their signification may not be affected by the damages sustained in the masts or rigging of the flag ship. Such signals as are less easily seen at a distance, should be appropriated to orders which can occur only in the middle of the fleet, &c. &c. Signals which are made to the admiral by private ships may be the same with signals of command from the flag ship, which will considerably diminish the number of signals perfectly different from each other. <sup>16</sup>

With all these attentions and precautions a system of <sup>16</sup>By what signals is at last made up, fitted to the code of sailing <sup>16</sup>16:16 means sig- and fighting instructions. It is accompanied by ano- <sup>16</sup>16:16 nais are- ther small set for the duty of convoys. It must be en- <sup>16</sup>16:16 convy:3, gressed in two books; one for the officer of the flag ship, who is to make the signals, and the other is <sup>16</sup>16:16 deli.

Naval  
Signals.

delivered to every private ship. In the first, the evolutions, movements, and other operations of service, are set down in one column, and their corresponding signals in another. The first column is arranged, either alphabetically, by the distinguishing phrase, or systematically, according to the arrangement of the sailing and fighting instructions. The officer whose duty it is to make the signals, turns to this column for the order which he is to communicate, and in the other column he finds the appropriated signal.

17  
And understood.

In the other book, which is consulted for the interpretation of the signals, they are arranged in the leading column, either by the flags, or by the places of their exhibition. The first is the best method, because the derangement of the flag ship's masts and rigging in time of action may occasion a change in the place of the signal.

18  
The art of signals much improved since the publication of the *Tactique Navale*.

The *Tactique Navale* of the Chevalier de Morogues contains a very full and elaborate treatise on signals. We recommend this work to every sea-officer, as full of instruction. The art of signals has been greatly simplified since the publication of this work, but we cannot but ascribe much of the improvements to it. We believe that the author is the inventor of that systematic manner of addressing the order or *effective signal* to the different squadrons and divisions of the fleet, by which the art of signals is made more concise, the execution of orders is rendered more systematic, and the commanders of private ships are accustomed to consider themselves as parts of an army, with a mutual dependence and connection. We are ready enough to acknowledge the superiority of the French in manœuvring, but we affect to consider this as an imputation on their courage. Nothing can be more unjust: and dear-bought experience should long ere now have taught us the value of this superiority. What avails that courage which we would willingly arrogate to ourselves, if we cannot come to action with our enemy, or must do it in a situation in which it is almost impossible to succeed, and which needlessly throws away the lives of our gallant crews? Yet this must happen, if our admirals do not make evolutions their careful study, and our captains do not habituate themselves, from their first hoisting a pendant, to consider their own ship as connected with the most remote ship in the line. We cannot think that this view of their situation would in the least lessen the character which they have so justly acquired, of fighting their ship with a courage and firmness unequalled by those of any other nation. And we may add, that it is only by such a rational study of their profession, that the gentleman can be distinguished from the mercenary commander of a privateer.

## II. NIGHT SIGNALS.

It is evident, that the communication of orders by night must be more difficult and more imperfect than by day. We must, in general, content ourselves with such orders as are necessary for keeping the fleet together, by directing the more general movements and evolutions which any change of circumstances may render necessary. And here the division and subordinate arrangement of the fleet is of indispensable necessity, it being hardly possible to particularise every ship by a signal of address, or to see her situation. The orders are therefore addressed to the commanders of the diffe-

rent divisions, each of whom is distinguished by his poop and top-lights, and is in the middle of, and not very remote from, the ships under his more particular charge. Yet even in this unfavourable situation, it is frequently necessary to order the movements of particular ships. Actions during the night are not uncommon. Pursuits and rallyings are still oftener carried on at this time. The common dangers of the sea are as frequent and more disastrous. The system of signals therefore is very incomplete till this part be accomplished.

Night signals must be made by guns, or by lights, or by both combined.

*Gun-signals* are susceptible of variety both in number and in disposition. The only distinct variation which can be made in this disposition, is by means of the time elapsed between the discharges. This will easily admit of three varieties, slow, moderate, and quick.—Half-minute guns are as slow as can easily be listened to as appertaining to one signal. Quarter-minute guns are much better, and admit of two very distinct subdivisions. When the gunners, therefore, are well trained to this service (especially since the employment of firelocks for cannon), intervals of 15 or 12 seconds may be taken for slow firing, 8 or 10 seconds for moderate, and 4 or 5 seconds for quick firing. If these could be reduced one half, and made with certainty and precision, the expression would be incomparably more distinct. A very small number of firings varied in this way will give a considerable number of signals. Thus five guns, with the variety of only quick and moderate, will give 25 very distinguishable signals. The same principle must be attended to here as in the flag signals. The most simple must be appropriated to the most important orders, such as occur in the worst weather, or such as are most liable to be mistaken. Quick firing should not make part of a signal to a very distant ship, because the noise of a gun at a great distance is a lengthened sound, and two of them, with a very short interval, are apt to coalesce into one long continued sound. This mode of varying gun-signals by the time must therefore be employed with great caution, and we must be very certain of the steady performance of the gunners.

Note, that a preparatory signal or advertisement that an effective signal is to be made, is a very necessary circumstance. It is usual (at least in hard weather) to make this by a double discharge, with an interval of half a second, or at most a second.

Gun-signals are seldom made alone, except in ordinary situations and moderate weather; because accident may derange them, and inattention may cause them to escape notice, and, once made, they are over, and their repetition would change their meaning. They are also improper on an enemy's coast, or where an enemy's cruisers or fleets may be expected.

Signals by lights are either made with LIGHTS simply so called, *i. e.* lanterns shown in different parts of the ship, or by rockets. Lights may differ by number, and by position, and also by figure. For the flag ship always carrying poop or top-lights, or both, presents an object in the darkest night, so that we can tell whether the additional lights are exhibited about the mainmast, the foremast, the mizenmast, &c. And if the lights shown from any of these situations are arranged in certain distinguishable situations in respect to each other, the

number of signals may be greatly increased. Thus three lights may be in a vertical line, or in a horizontal line, or in a triangle, and the point of this triangle may be up, or down, or forward, or aft, and thus may have many significations.

Lights are also exhibited by false fires or rockets: These can be varied by number, and by such differences of appearance as to make them very distinguishable. Rockets may be with stars, with rain fire, or simple squibs.

By varying and combining these, a very great number of signals may be produced, fully sufficient to direct every general movement or evolution, or any ordinary and important service. The Chevalier de Morogues has given a specimen of such a system of night signals, into which he has even introduced signals of address or direction to every ship of a large fleet; and has also given signals of number, by which depths of soundings, points of the compass, and other things of this kind, may be expressed both easily and distinctly. He has made the signals by rockets perfectly similar in point of number to those by lanthorns, so that the commander can take either; a choice which may have its use, because the signals by rockets may cause the presence of a fleet to be more extensively known than may be convenient.

The commander in chief will inform the fleet by signal, that guns, or perhaps rockets, are not to be used that night. This signal, at the same time, directs the fleet to close the line or columns, that the light signals may be better observed.

It is indeed a general rule to show as few lights as possible; and the commander frequently puts out his own poop and top-lights, only showing them from time to time, that his ships may keep around him.

The signal lanthorns on board the flag ship, and a lanthorn kept in readiness on board of every private ship, to answer or acknowledge signals from the commander in chief, are all kept in bags, to conceal their lights till the moment they are fixed in their places, and the preparatory or advertising signal has been made.

The commander in chief sometimes orders by signal every ship to show a light for a minute or two, that he may judge of the position of the fleet; and the admiral's signal must always be acknowledged by those to whom it is addressed.

It is of particular importance that the fleet be kept together. Therefore the leading ships of the fleet, on either tack, are enjoined to acknowledge the signals of the commander in chief by a signal peculiar to their station. Thus the commander in chief learns the position of the extremities of his fleet.

In framing a set of night signals, great attention must be given to their position, that they be not obscured by the sails. The nature of the order to be given will frequently determine this. Thus, an order for the rear ships to make more sail, will naturally direct us to exhibit the signal at the mizen peak; and so of other pieces of service. Lanthorns exposed in groups, such as triangles, lozenges, &c. are commonly suspended at the corners of large frames of laths, at the distance of a fathom at least from each other. Attempts have been made to show lights of different colours, but the risk of mistake or failure in the composition at the laboratory,

makes this rather hazardous. Coloured lanthorns are more certain; but when the glasses are made of a colour sufficiently intense, the vivacity of the light (which at no time is very great) is too much diminished. Besides, the very distance changes the colour exceedingly and unaccountably.

### III. Of SIGNALS in a FOG.

THESE can be made only by noises, such as the firing of cannon and muskets, the beating of drums and ringing of bells, &c. Fog signals are the most difficult to contrive of any, and are susceptible of the least variety. The commander in chief is principally concerned to keep his fleet together; and unless something very urgent requires it, he will make no change in his course or rate of sailing. But a shift of wind or other causes may make this necessary. The changes which he will order, it will be prudent to regulate by some fixed rule, which is in general convenient. Thus, when a fleet is in the order of sailing upon a wind, and a fog comes on, the fleet will hold on the same course.

If the wind should come a little more on the beam, the fleet will still keep close to the wind. Certain general rules of this kind being agreed on, no signals are necessary for keeping the fleet together; and the ships can separate or run foul of each other only by difference in their rate of sailing, or by inaccurate steering. To prevent this, the commander in chief fires a gun from time to time, and the ships of the fleet judge of his situation and distance by the sound. The commanders of divisions fire guns, with some distinction from those of the commander in chief. This both informs the commander in chief of the position of his squadrons, and enables the private ships of each division to keep in the neighbourhood of their own flag ship. On board of every private ship the drum is beaten, or the bell is chimed, every quarter of an hour, according as the ship is on the starboard or larboard tack. By such contrivances, it is never difficult to keep a fleet in very good order when sailing on a wind. The wind is almost always moderate, and the ships keep under a very easy sail. It is much more difficult when going large, and separation can be prevented only by the most unwearied attention. The greatest risk is the falling in with strange ships steering another course.

But evolutions and other movements are frequently indispensable. The course must be changed by tacking or wearing, and other services must be performed. None, however, are admitted but the most probable, the most simple, and the most necessary.

The commander in chief first informs the fleet by the preparatory fog signal, that he is about to order an evolution, and that he is to direct it by fog signals. This precaution is indispensable to prevent mistakes. Along with this advertising signal he makes the signal of the movement intended. This not only calls the attention of the fleet, but makes the ships prepare for the precise execution of that movement. The commanders of divisions repeat the advertising signal, which informs their ships of their situation, and the private ships beat their drums or chime their bells. Thus the whole ships of the fleet close a little, and become a little better acquainted with their mutual position. It is now understood that a movement is to be made precisely a quarter of an hour after the advertisement. At

How they are given when necessary.

the

Naval Signals.

the expiration of this time, the effective signal for this movement is made by the commander in chief, and must be instantly repeated by the commanders of divisions, and then the movement must be made by each ship, according to the sailing and fighting instructions. This must be done with the utmost attention and precision, because it produces a prodigious change in the relative position of the ships; and even although the good sense of the commander in chief will select such movements for accomplishing his purpose as produce the smallest alterations, and the least risk of separation or running foul of each other; it is still extremely difficult to avoid these misfortunes. To prevent this as much as possible, each ship which has executed the movement, or which has come on a course thwarting that of the fleet, intimates this by a signal properly adapted, often adding the signal of the tack on which it is now standing, and even its particular signal of recognizance. This is particularly incumbent on the flag ships and the leading ships of each division.

After a reasonable interval, the commander in chief will make proper signals for bringing the fleet to a knowledge of their reunion in this new position.

21  
Improper  
to publish  
a particular  
account of  
signals.

This must serve for a general account of the circumstances which must be attended to in framing a code of signals. The arbitrary characters in which the language is written must be left to the sagacity of the gentlemen of the profession. It must be observed, that the strata gens of war make secrecy very necessary. It may be of immense hazard if the enemy should understand our signals. In time of battle it might frequently frustrate our attempts to destroy them, and at all times would enable them to escape, or to throw us into disorder. Every commander of a squadron, therefore, issues private signals, suited to his particular destination; and therefore it is necessary that our code of signals be susceptible of endless variations. This is exceedingly easy without any increase of their number. The commander needs only intimate that such and such a signal is so and so changed in its meaning during his command.

26  
Signa stary  
he ma te  
the inwe-  
diti: r ec-  
prections of  
signals.

We cannot leave this article without returning to an observation which we made almost in the beginning, viz. that the system of signals, or, to speak more properly, the manner of framing this system, has received much improvement from the gentlemen of the French navy, and particularly from the most ingenious thought of M. de la Bourdonnais, of making the signals the immediate expressions of numbers only, which numbers may be afterwards used to indicate any order whatever. We shall present our readers with a scheme or two of the manner in which this may be done for all signals, both day, night, and fog. This alone may be considered as a system of signals, and is equally applicable to every kind of information at a distance. Without detracting in the smallest degree from the praise due to M. de la Bourdonnais, we must observe, that this principle of notation is of much older date. Bishop Wilkins, in his *Secret and Swift Messenger*, expressly recommends it, and gives specimens of the manner of execution; so does Dr Hooke in some of his proposals to the Royal Society. Gaspar Schottus also mentions it in his *Technica Curiosa*; and Kircher, among others of his *Curious Projects*.

M. de la Bourdonnais's method is as follows:

He chooses pendants for his effective signals, because they are the most easily displayed in the proper order. Several pendants, making part of one signal, may be hoisted by one hallyard, being stopped on it at the distance of four or six feet from each other. If it be found proper to throw out another signal at the same time and place, they are separated by a red pendant without a point. His colours are chosen with judgment, being very distinctly recognised, and not liable to be confounded with the addressing signals appropriated to the different ships of the fleet. They are,

- |                            |  |
|----------------------------|--|
| For N <sup>o</sup> 1. Red. | For N <sup>o</sup> 6. Red, with blue tail. |
| 2. White.                  | 7. White, with blue tail.                  |
| 3. Blue.                   | 8. White, with red tail.                   |
| 4. Yellow.                 | 9. Blue, with yellow tail.                 |
| 5. Red, with white tail.   | c. Yellow, with blue tail.                 |

Three sets of such pendants will express every number under a thousand, by hoisting one above the other, and reckoning the uppermost hundreds, the next below it tens, and the lowest units. Thus the number 643 will be expressed by a pendant red with blue tail, a yellow pendant below it, and a blue one below the last.

This method has great advantages. The signals may be hoisted in any place where best seen, and therefore the signification is not affected by the derangement of the flag ship's masts and rigging. And by appropriating the smaller numbers to the battle signals, they are more simple, requiring fewer pendants.

As this method requires a particular set of colours, it has its inconveniences. An admiral is often obliged to shift his flag, even in time of action. He cannot easily take the colours along with him. It is therefore better to make use of such colours as every private ship is provided with. One set of 11 will do, with the addition of three, at most of four pendants, of singular make, to mark 100, 200, 300, 400. Two of these flags, one above the other, will express any number under 100, by using the 11th as a substitute for any flag that should be repeated. Thus the 11th flag, along with the flag for eight or for six, will express the number 88 or 66, &c. Thus we are able to express every number below 500, and this is sufficient for a very large code of signals.

And in order to diminish as much as possible the number of these compound signals, it will be proper that a number of single flag signals be preserved, and even varied by circumstances of position, for orders which are of very frequent occurrence, and which can hardly occur in situations where any obstructions are occasioned by loss of masts, &c. And farther, to avoid all chance of mistake, a particular signal can be added, intimating that the signals now exhibited are numerary signals; or, which is still better, all signals may be considered as numerary signals; and those which we have just now called *single flag signals* may be set down opposite to, or as expressing, the largest numbers of the code.

This method requires the signal of advertisement, the annulling signal, the signal of address to the particular ship or division, the signal of acknowledgment, the signal of indistinctness, of distress, of danger, and

Naval  
val  
27  
bourd  
nai's r  
had fo  
ding

2  
Migh  
rende  
much  
pier b  
using  
colou



one or two more which, in every method, must be employed.

Another method of expressing numbers with fewer colours is as follows: Let the flags be A, B, C, D, E, F, and arrange them as follows:

	A	B	C	D	E	F
	1	2	3	4	5	6
A	7	8	9	10	11	12
B	13	14	15	16	17	18
C	19	20	21	22	23	24
D	25	26	27	28	29	30
E	31	32	33	34	35	36
F	37	38	39	40	41	42

The number expressed by any pair of flags is found in the intersection of the horizontal and perpendicular columns. Thus the flag D, hoisted along with and above the flag F, expresses the number 40, &c. In order to express a greater number (but not exceeding 84) suppose 75, hoist the flags E, which expresses 33, or 75, wanting 42, and above them a flag or signal G, which alone expresses 42.

This method may be still farther improved by arranging the flags thus:

	A	B	C	D	E	F
	1	2	3	4	5	6
A	7	8	9	10	11	12
B	—	13	14	15	16	17
C	—	—	18	19	20	21
D	—	—	—	22	23	24
E	—	—	—	—	25	26
F	—	—	—	—	—	27

In this last method the signification of the signal is totally independent of the position of the flags. In whatever parts of the ship the flags D and E are seen, they express the number 23. This would suit battle signals.

Another method still may be taken. Flags hoisted anywhere on the foremast may be accounted units, those on the mainmast tens, and those on the mizenmast hundreds. Thus numeral signals may be made by a ship dismasted, or having only poles in their place.

Many other ways may be contrived for expressing numbers by colours, and there is great room for exercising the judgment of the contriver. For it must always be remembered, that these signals must be accompanied with a signal by which it is addressed to some particular ship or division of the fleet, and it may be difficult to connect the one with the other, which is perhaps shown in another place, and along with other executive signals.

One great advantage of these numeral signals is, that they may be changed in their signification at pleasure. Thus, in the first method, it can be settled, that on Sundays the colours A, B, C, D, &c. express the cyphers 1, 2, 3, 4, &c. but that on Mondays they express the cyphers 0, 1, 2, 3, &c. and on Tuesdays the cyphers 9, 0, 1, 2, &c.; and so on through all the days of the week. This mean of secrecy is mentioned by Dr Hooke for the coast and alarm signals, where, by the by, he shews a method for conveying intelligence over land very similar to what is now practised by the French with their telegraph.

It is equally easy to express numbers by night signals. Thus M. de la Bourdonnais proposes, that one discharge of a great gun shall express 7, and that 1, 2, 3, 4, 5, 6 shall be expressed by lights. Therefore, to express 24, we must fire three guns, and show three lights. This is the most perfect of all forms of night and fog signals. For both the manner of firing guns and of exhibiting lights may be varied to a sufficient extent with very few guns or lights, and with great distinctness.

Thus, for guns. Let F mark the firing of a single gun at moderate intervals, and ff a double gun, that is, two discharged at the interval of a second. We may express numbers thus:

1	F.
2	F, F.
3	F, F, F.
4	F, F, F, F.
5	F, ff.
6	F, F, ff.
7	F, ff, F.
8	F, ff, F, F.
9	F, ff, F, ff.
10	ff.
100, &c.	ff, ff, or fff.

It might be done with fewer guns if the ff were admitted as the first firing. But it seems better to begin always with the single gun, and thus the double gun beginning a signal distinguishes the tens, &c.

In like manner, a small number of lights will admit of a great variety of very distinct positions, which may serve for all signals to ships not very remote from the commander in chief. For orders to be understood at a very great distance, it will be proper to appropriate the numbers which are indicated by signals made with rockets. These can be varied in number and kind to a sufficient extent, so as to be very easily distinguished and understood. It is sufficient to have shown how the whole, or nearly the whole, notation of signals may be limited to the expression of numbers.

We have taken little notice of the signals made by private ships to the commander in chief. This is a very easy business, because there is little risk of confounding them with other signals. Nor have we spoken of signals from the flag ships whose ultimate interpretation is number, as when ships are directed to change their course for many points. These also are easily contrived in any of the methods already described: also when a private ship wishes to inform the commander in chief that soundings are found at so many fathoms. In like manner, by numbering the points of the compass, the admiral can direct to chase to any one of them, or may be informed of strange ships being seen in any quarter, and what is their number.

SIGNALS by the Drum, made use of, in the exercise of the army, instead of the word of command, viz.

SIGNALS.	Operations.
<i>A short roll,</i>	To caution.
<i>A drum,</i>	To perform any distinct thing.
<i>To arms,</i>	To form the line or battalion.
<i>The march,</i>	To advance, except when intended for a salute.
<i>The quick march,</i>	To advance quick.
<i>The point of war,</i>	To march and charge.

Signature, <i>The retreat,</i>	-	To retreat.
<i>Drum ceasing,</i>	-	To halt.
<i>Two short rolls,</i>	-	To perform the flank firing.
<i>The dragoon march,</i>	-	To open the battalion.
<i>The grenadier march,</i>	-	To form the column.
<i>The troop,</i>	-	To double divisions.
<i>The long roll,</i>	-	To form the square.
<i>The grenadier march,</i>	{	To reduce the square to the column.
<i>The preparative,</i>	-	To make ready and fire.
<i>The general,</i>	-	To cease firing.
<i>Two long rolls,</i>	-	To bring or lodge the colours.

**SIGNATURE**, a sign or mark impressed upon any thing, whether by nature or art. Such is the general signification of the word; but in the plural number it has been used, in a particular sense, to denote those external marks by which physiognomists and other dabblers in the occult sciences pretend to discover the nature and internal qualities of every thing on which they are found. According to Lavater, every corporeal object is characterized by signatures peculiar to itself.

The doctrine of signatures, like alchemy and astrology, was very prevalent during the 15th and 16th centuries; and was considered as one of the occult sciences which conferred no small degree of honour on their respective professors. Some of these philosophers, as they thought fit to style themselves, maintained that plants, minerals, and animals, but particularly plants, had signatures impressed on them by the hand of nature, indicating to the adept the *therapeutic* uses to which they might be applied. Others, such as the mystic theosophists and chemists of that day, proceeded much farther in absurdity, maintaining that every substance in nature had either *external* signatures immediately discernible, or *internal* signatures, which, when brought into view by fire or menstrua, denoted its connection with some sidereal or celestial archetype. Of the doctrine of signatures, as it relates merely to the therapeutic uses of plants and minerals, traces are to be found in the works of some of the greatest authors of antiquity; but the celestial signatures, we believe, were discovered only by the moonlight of the monkish ages. Pliny informs us\*, that the marble called *aphites*, from its being spotted like a serpent, was discovered by those spots to be a sovereign remedy for the bite of that animal; and that the colour of the *hematites* or blood-stone intimated that it was fit to be employed to stop an hemorrhagy; but we do not recollect his attributing the virtues of these minerals to a sidereal or celestial influence.

**SIGNATURE**, a signing of a person's name at the bottom of an act or deed written by his own hand.

**SIGNATURE**, in printing, is a letter put at the bottom of the first page at least, in each sheet, as a direction to the binder in folding, gathering, and collating, them. The signatures consist of the capital letters of the alphabet, which change in every sheet: if there be more sheets than letters in the alphabet, to the capital letter is added a small one of the same sort, as A a, B b; which are repeated as often as necessary. In large volumes it is easy to distinguish the number of alphabets, after the first three or four, by placing a figure before the signature, as 5 B, 6 B, &c.

**SIGNET**, one of the king's seals, made use of in sealing his private letters, and all grants that pass by

bill signed under his majesty's hand: it is always in the custody of the secretaries of state.

**SIGNET**, in Scots law. See LAW, Part III. § 17.

**SILENE**, *CATCHFLY*, or *Viscous Campion*, in botany: A genus of plants belonging to the class of *dianthia*, and order of *trigynia*; and in the natural system arranged under the 22d order, *caryophylleæ*. The calyx is ventricose; the petals are five in number, bifid and unguiculated, and crowned by a nectarium; the capsule is cylindrical, covered, and trilobular. There are 26 species, of which 7 are natives of Britain and Ireland. 1. *Anglica*, the small corn campion or catchfly. The stem is weak, hairy, and above a foot high; the leaves are oblong, and grow in pairs at the joints; the flowers are small, white, and entire; they stand on footstalks which issue from the axæ of the leaves; they are erect, alternate, single, and lateral. It grows in corn-fields, and flowers in June and July. 2. *Nutans*, Nottingham catchfly. The stem is about two feet high, and firm; the radical leaves are broad, obtuse, and grow in a tuft; those on the stem are narrow and acute: the flowers are white, and grow in lateral panicles; the petals are bifid and curled; the calyx is long, bellying a little, with ten longitudinal striæ. It grows in pastures, and flowers in June and July. 3. *Amana*, sea-campion. The stem is two or three feet long, slender, procumbent, and branched alternately: the leaves are long and narrow: the flowers are white, and grow on opposite footstalks, three on each, in unilateral bunches: the calyx is hairy and purplish, and has ten angles. It grows on the south coast, and flowers in June and July. 4. *Conoidea*, greater corn catchfly, or campion. The leaves are narrow and soft; the calyx is conical, with 30 striæ; the flowers proceed from the divarications of the stem; the petals are entire. It grows in corn fields, and flowers in June. 5. *Noctiflora*, night-flowering catchfly. The stem is about two feet high, and forked; the calyx has ten angles, is somewhat clammy, and oval, with longer teeth than the other species; the petals are of a reddish white. 6. *Armeria*, broad-leaved catchfly. The stem is about 18 inches high, and erect, with few branches; the leaves are smooth, sessile, and broad at the base; the flowers terminal, in fasciate bundles, small, and red. It may be seen on the banks of rivers, and is in flower in July and August. 7. *Acaulis*, moss campion. The radical leaves are spread on the ground like a tuft of moss; the stalks are about an inch long, and naked, bearing each a single purple flower. This last species grows on mountains, and has been found, in Wales and Scotland, within half a mile from their top. It is in flower in July.

**SILESIA**, a duchy of Germany, bounded on the east by Poland; on the west, by Bohemia and Lower Lusatia; on the south, by a chain of mountains, and a thicket of considerable extent which separates it from Hungary; and to the north, by the marquisate of Brandenburg and Poland. From north-west to south-east it is about 274 miles, and about 100 where broadest: but it is much contracted at both ends. Upon the frontiers of this country, to the west and south, are very high mountains, and some likewise in other parts of it. One of the ridges upon the frontiers is styled the *Rhipæan Mountains*, another the *Moravian*, another the *Bohemian*, and another the *Hungarian*, *Crapack*, or *Carpathian*.

\* *Hist. Nat.*  
lib. 34.

*Silesia*. *Spathian*. A branch of the Bohemian is called the *Giant Mountains*. The winter on these hilly tracks is more severe, sets in sooner, and lasts longer, than in the low lands. The inhabitants use a kind of skates when the snow is deep, as they do in Carniola. Little or no grain is raised in the mountains and some sandy tracks; but the rest of the country is abundantly fruitful, not only in grain, but fruits, roots, pasture, flax, hops, madder, tobacco, and hemp, yielding also some wine, with considerable quantities of silk and honey. In many places are great woods of pines, fir, beech, larch, and other trees, affording tar, pitch, rosin, turpentine, lamp-black, and timber for all uses. In this country also is found marble of several sorts, some precious stones, limestone, millstone, pitecoal, turf, vitriol, some silver ore, copper, lead, iron, and mineral springs. Great numbers of black cattle and horses are brought hither from Poland and Hungary for sale, those bred in the country not being sufficient; but of sheep, goats, game, and venison, they have great plenty. As for wild beasts, here are lynxes, foxes, weasels, otters, and beavers. The rivers, lakes, and ponds, yield fish of several sorts, particularly sturgeons several ells in length, and salmon. Besides a number of smaller streams to water this country, there is the Oder, which traverses it almost from one end to the other; and the Vistula, which after a pretty long course through it enters Poland. The number of the cities and market-towns is said to be about 200, the county of Glatz included, and that of the villages 5000. The inhabitants, who are computed to be about a million and an half, are a mixture of Germans, Poles, and Moravians. The language generally spoken is German; but in some places the vulgar tongue is a dialect of the Slavonic. The states consist of the princes and dukes, and those called *state-lords*, with the nobility, who are immediately subject to the sovereign, and the representatives of the chief cities; but since the country fell under the dominion of the king of Prussia, no diets have been held. The king, however, when he took possession of the country, confirmed all the other privileges of the inhabitants. With respect to religion, not only Protestants, but Papists, Jews, and Greeks, enjoy full liberty of conscience. The greatest part of Silesia lies in the diocese of Breslaw, but some part of it in the Polish dioceses of Posen and Cracow. The bishop of Breslaw stands immediately under the pope with regard to spirituals; but all ecclesiastical benefices, not excepting the see of Breslaw, is in the king's gift. Besides Latin schools, colleges, and seminaries, at Breslaw is an university, and at Lignitz an academy for martial exercises. The principal manufactures here are woolsens, linens, and cottons of several sorts, with hats, glassware, gunpowder, and iron manufactures. Of these there is a considerable exportation. Accounts are generally kept in rix-dollars, silver groschens, and ducats. With respect to its revolutions and present government, it was long a part of the kingdom of Poland; afterwards it had several dukes and petty princes for its sovereigns, who by degrees became subject to the kings of Bohemia, until at last king Charles IV. incorporated the whole duchy with Bohemia; and thus it continued in the possession of the house of Austria, until the king of Prussia in 1742, taking advantage of the troubles that ensued upon the death of the emperor Charles VI. and pretending a kind of claim, wrested a great part of it,

together with the county of Glatz, from his daughter and heiress Maria Theresa, the late empress-dowager; so that now only a small part of it is possessed by the house of Austria, and connected with the empire, the rest being governed by the king of Prussia, without acknowledging any sort of dependence on the crown of Bohemia or the empire. For the administration of justice in all civil, criminal, and feudal cases, and such as relate to the revenue, the king of Prussia has established three supreme judicatories, to which an appeal lies from all the inferior ones, and from which, when the sum exceeds 500 rix-dollars, causes may be moved to Berlin. The Lutheran churches and schools are under the inspection of the upper consistories, and those of the Papists under that of the bishop's court at Breslaw; but from both an appeal lies to the tribunal at Berlin. As to the revenue, the excise here is levied only in the walled towns, being on the same footing as in the marquisate of Brandenburg; but in the rest of the country the contributions are fixed, and the same both in peace and war. The several branches of the revenue are under the management of the war and domain offices of Breslaw and Glogau. The whole revenue arising to the king of Prussia from Silesia and the county of Glatz amounts to about four millions of rix-dollars *per annum*.

Silesia is divided into Upper and Lower, and each of these again into principalities and lordships; of some of which both the property and jurisdiction belong immediately to the sovereign, but of others to his subjects and vassals. In regard to the character of the people, the boors are accounted very dull and stupid; but of those of a higher rank, many have distinguished themselves by their wit and learning, as well as by their military and political talents. However, in general, like their neighbours the Germans and Bohemians, they have more of Mars than Mercury in their composition, and their parts are more solid than shining.

**SILESIA** EARTH, in the materia medica, a fine astringent bole. It is very heavy, of a firm compact texture, and in colour of a brownish yellow. It breaks easily between the fingers, and does not stain the hands; is naturally of a smooth surface, is readily diffusible in water, and melts freely into a butter-like substance in the mouth. It leaves no grittiness between the teeth, and does not ferment with acid menstrua. It is found in the perpendicular fissures of rocks near the gold-mines at Strigonium in Hungary, and is supposed to be impregnated with the sulphur of that metal. It is a good astringent, and better than most of the boles in use.

**SILICERNIUM**, among the Romans, was a feast of a private nature, provided for the dead some time after the funeral. It consisted of beans, lettuces, bread, eggs, &c. These were laid upon the tomb, and they foolishly believed that the dead would come out for the repast. What was left was generally burnt on the stone. The word *silicernium* is derived from *silex* and *cana*, i. e. "a supper upon a stone." Eating what had thus been provided for the dead, was esteemed a mark of the most miserable poverty. A similar entertainment was made by the Greeks at the tombs of the deceased; but it was usual among them to treat the ghouls with the fragments from the feast of the living. See **FUNERAL** and **INFURIE**.

Silesia  
||  
Silicernium.

Silex  
Silius.

SILEX. See FLINT.

SILICEOUS EARTHS. See MINERALOGY, Part II.

Order 4.

SILIUS (Italicus Caius), an ancient Roman poet, and author of an epic poem in 17 books, which contains an history of the second Punic war, so famous for having decided the empire of the world in favour of the Romans. He was born in the reign of Tiberius, and is supposed to have derived the name of *Italicus* from the place of his birth; but whether he was born at Italia in Spain, or at Corfinium in Italy, which, according to Strabo, had the name of *Italica* given it during the Social war, is a point which cannot be known: though, if his birth had happened at either of these places, the grammarians would tell us, that he should have been called *Italicus*, and not *Italicus*. When he came to Rome, he applied himself to the bar; and, by a close imitation of Cicero, succeeded so well, that he became a celebrated advocate and most accomplished orator. His merit and character recommended him to the highest offices in the republic, even to the consulship, of which he was possessed when Nero died. He is said to have been aiding and assisting in accusing persons of high rank and fortune, whom that wicked emperor had devoted to destruction: but he retrieved his character afterwards by a long and uniform course of virtuous behaviour. Vespasian sent him as proconsul into Asia, where he behaved with clean hands and unblemished reputation. After having thus spent the best part of his life in the service of his country, he bade adieu to public affairs, resolving to consecrate the remainder to polite retirement and the muses. He had several fine villas in the country: one at Tusculum, celebrated for having been Cicero's; and a farm near Naples said to have been Virgil's, at which was his tomb, which Silius often visited. Thus Martial compliments him on both these accounts:

*Silius hac magni celebrat monumenta Maronis,*

*Jugera facundi qui Ciceronis habet.*

*Harodem Dominumque sui tumulique larisque*

*Non alium mallet nec Maro nec Cicero.*

Epigr. 49. lib. xi.

Of Tully's seat my Silius is possess'd,

And his the tomb where Virgil's ashes rest.

Could those great shades return to choose their heir,

'The present owner they would both prefer.

In these retirements he applied himself to poetry: led not so much by any great force of genius, which would certainly not have suffered him to stay till life was in the wane and his imagination growing cold, as by his exceeding great love of Virgil, to whose memory he paid the highest veneration. He has imitated him in his poem; and though he falls infinitely short of him, yet he has discovered a great and universal genius, which would have enabled him to succeed in some degree in whatever he undertook.

Having been for some time afflicted with an imposthume, which was deemed incurable, he grew weary of life, to which, in the language of Pliny, he put an end with determined courage.

There have been many editions of Silius Italicus. A neat and correct one was published at Leipzig in 1696, in 8vo, with short and useful notes by Cellarius: but the

best is that *cum notis integris variorum et Arnoldi Drakenborch*. Traject. ad Rhen. 1717, in 4to.

SILK, a very soft, fine, bright thread, the work of an insect called *bombyx*, or the silk worm.

As the silk worm is a native of China, the culture of silk in ancient times was entirely confined to that country. We are told that the empresses, surrounded by their women, spent their leisure hours in hatching and rearing silk worms, and in weaving tissues and silk veils. That this example was soon imitated by persons of all ranks, we have reason to conclude; for we are informed that the Chinese, who were formerly clothed in skins, in a short time after were dressed in vestments of silk. Till the reign of Justinian, the silk worm was unknown beyond the territories of China, but silk was introduced into Persia long before that period. After the conquest of the Persian empire by Alexander the Great, this valuable commodity was brought into Greece, and thence conveyed to Rome. The first of the Roman writers extant by whom silk is mentioned, are Virgil and Horace; but it is probable that neither of them knew from what country it was obtained, nor how it was produced. By some of the ancients it was supposed to be a fine down adhering to the leaves of certain trees or flowers. Others imagined it to be a delicate species of wool or cotton; and even those who had learned that it was the work of an insect, show by their descriptions that they had no distinct idea of the manner in which it was formed. Among the Romans, silk was deemed a dress too expensive and too delicate for men, and was appropriated wholly to women of eminent rank and opulence. Elagabalus is said to have been the first man among the Romans who wore a garment of fine silk: Aurelian complained that a pound of silk was sold at Rome for 12 ounces of gold; and it is said he refused to give his wife permission to wear it on account of its exorbitant price.

For several centuries the Persians supplied the Roman empire with the silks of China. Caravans traversed the whole latitude of Asia, in 243 days, from the Chinese ocean to the sea-coast of Syria, carrying this commodity. Sometimes it was conveyed to the

ports of Guzerat and Malabar, and thence transported by sea to the Persian Gulph. The Persians, with the usual rapacity of monopolists, raised the price of silk to

such an exorbitant height, that Justinian, eager not only to obtain a full and certain supply of a commodity which

was become of indispensable use, but solicitous to deliver the commerce of his subjects from the exactions of his enemies, endeavoured, by means of his ally, the Christian monarch of Abyssinia, to wrest some portion of the silk trade from the Persians. In this attempt he failed; but when he least expected it, he, by an unforeseen event, attained, in some measure, the object which he had in view. Two Persian monks having been employed as missionaries in some of the Christian churches, which were established (as we are informed by Cosmas) in different parts of India, had penetrated into the country of the Seres, or China. There they observed the labours of the silk worm, and became acquainted with all the arts of man in working up its productions into such a variety of elegant fabrics. The prospect of gain, or perhaps an indignant zeal, excited by seeing this lucrative branch of commerce engrossed by unbelieving

nations,

*Silk.* nations, prompted them to repair to Constantinople. There they explained to the emperor the origin of silk, as well as the various modes of preparing and manufacturing it, mysteries hitherto unknown, or very imperfectly understood in Europe; and encouraged by his liberal promises, they undertook to bring to the capital a sufficient number of those wonderful insects, to whose labours man is so much indebted. This they accomplished, by conveying the eggs of the silk worm in a hollow cane. They were hatched by the heat of a dunghill, fed with the leaves of a wild mulberry tree, and they multiplied and worked in the same manner as in those climates where they first became objects of human attention and care. Vast numbers of these insects were soon reared in different parts of Greece, particularly in the Peloponnesus. Sicily afterwards undertook to breed silk worms with equal success, and was imitated, from time to time, in several towns of Italy. In all these places extensive manufactures were established and carried on with silk of domestic production. The demand for silk from the east diminished of course, the subjects of the Greek emperors were no longer obliged to have recourse to the Persians for a supply of it, and a considerable change took place in the nature of the commercial intercourse between Europe and India.

As silk is the production of a worm, it will be first necessary to give a description of its nature and mode of manufacturing. But before we give any account of the most approved methods of managing silk worms in Europe, it will be proper to present a short description of the methods practised in China, the original country of the silk worm. These are two: they either permit them to remain at liberty on mulberry trees, or keep them in rooms. As the finest silk is produced by worms confined in rooms, and as the first method is very simple, it will suffice to describe the second.

To begin with the eggs, which are laid on large sheets of paper, to which they firmly adhere. The sheets are hung up on a beam of the room, with the eggs inward, and the windows are opened in the front to admit the wind; but no hempen ropes must ever come near the worms or their eggs. After some days the sheets are taken down, rolled up loosely with the eggs inward, and then hung up again, during the summer and autumn. At the end of December, or the beginning of January, the eggs are put into cold water, with a little salt dissolved in it. Two days after they take them out, hang them up again, and when dry roll them a little tighter, and enclose each separately, standing on one end in an earthen vessel. Some put them into a lye made of mulberry tree ashes, and then lay them some moments in snow-water, or else hang them up three nights on a mulberry tree to receive the snow or rain, if not too violent. The time of hatching them is when the leaves of the mulberry trees begin to open, for they are hastened or impeded according to the different degrees of heat or cold to which they are exposed. When they are ready to come forth, the eggs swell, and become a little pointed.

The third day before they are hatched, the rolls of paper are taken out of the vessel, stretched out, and hung up with their backs toward the sun, till they receive a kindly warmth; and then being rolled up close, they are set upright in a vessel in a warm place. This is repeated the next day, and the eggs change to an ash-

grey. They then put two sheets together, and rolling them close tie the ends.

The third day, towards night, the sheets are unrolled and stretched on a fine mat, when the eggs appear blackish. They then roll three sheets together, and carry them into a pretty warm place, sheltered from the south wind. The next day the people taking out the rolls, and opening them, find them full of worms like small black ants.

The apartment chosen for silk worms is on a dry ground, in a pure air, and free from noise. The rooms are square, and very close, for the sake of warmth; the door faces the south, and is covered with a double mat, to keep out the cold; yet there should be a window on every side, that when it is thought necessary the air may have a free passage. In opening a window to let in a refreshing breeze, care must be taken to keep out the gnats and flies. The room must be furnished with nine or ten rows of frames, about nine inches one above the other. On these they place rush hurdles, upon which the worms are fed till they are ready to spin; and, to preserve a regular heat, stove fires are placed at the corners of the room, or else a warming pan is carried up and down it; but it must not have the least flame or smoke. Cow-dung dried in the sun is esteemed the most proper fuel.

The worms eat equally day and night. The Chinese give them on the first day forty-eight meals: that is, one every half hour; the next thirty; the third day they have still less. As cloudy and rainy weather takes away their stomach, just before their repast a wisp of very dry straw, the flame of which must be all alike, is held over the worms to free them from the cold and moisture that benumbs them, or else the blinds are taken from the windows to let in the full day-light.

Eating so often hastens their growth, on which the chief profit of the silk worm depends. If they come to maturity in 23 or 25 days, a large sheet of paper covered with worms, which at their first coming from the eggs weigh little more than a drachm, will produce 25 ounces of silk; but if not till 28 days, they then yield only 20 ounces; and if they are a month or 40 days in growing, they then produce but ten.

They are kept extremely clean, and are often removed; and when they are pretty well grown, the worms belonging to one hurdle are divided into three, afterwards they are placed on six, and so on to the number of 20 or more; for being full of humours, they must be kept at a due distance from each other. The critical moment for removing them is when they are of a bright yellow and ready to spin; they must be surrounded with mats at a small distance, which must cover the top of the place to keep off the outward air; and because they love to work in the dark. However, after the third day's labour, the mats are taken away from one o'clock till three, but the rays of the sun must not shine upon them. They are at this time covered with the sheets of paper that were used on the hurdles.

The cocoons are completed in seven days, after which the worm is metamorphosed into a chrysalis; the cocoons are then gathered, and laid in heaps, having first set apart those designed for propagation upon a hurdle, in a cool airy place. The next care is to kill the moths in those cones which are not to be bored. The best way of doing this is to fill large earthen vessels with

cones

<sup>Silk.</sup> cones in layers of ten pounds each, throwing in four ounces of salt with every layer, and covering it with large dry leaves like those of the water-lily, and closely stopping the mouth of the vessels. But in laying the cones into the vessels, they separate the long, white, and glittering ones, which yield a very fine silk, from those that are thick, dark, and of the colour of the skin of an onion, which produce a coarser silk.

<sup>5</sup> Description and history of the silk worm. The silk worm is a species of caterpillar, which, like all others of the same class, undergoes a variety of changes, that, to persons who are not acquainted with objects of this kind, will appear to be not a little surprising.

*The Bee,*  
n<sup>o</sup> 72.

It is produced from a yellowish coloured egg, about the size of a small pin head, which has been laid by a kind of greyish coloured moth, which the vulgar confound with the butterfly.

These eggs, in the temperature of this climate, if kept beyond the reach of the fire and sun shine, may be preserved during the whole of the winter and spring months without danger of hatching: and even in summer they may easily be prevented from hatching if they be kept in a cool place; but in warmer climates it is scarcely possible to preserve them from hatching, even for a few days, or from drying so much as to destroy them. Hence it is easy for a native of Britain to keep the eggs till the food on which the worm is to feed be ready for that purpose. When this food is in perfection, the eggs need only be exposed to the sun for a day or two, when they will be hatched with great facility.

When the animal is first protruded from the egg, it is a small black worm, which is active, and naturally ascends to the top of the heap in search of food. At this stage of his growth the silk worm requires to be fed with the youngest and most tender leaves. On these leaves, if good, he will feed very freely for about eight days, during which period he increases in size to about a quarter of an inch in length. He is then attacked with his first sickness, which consists in a kind of lethargic sleep for about three days continuance; during which time he refuses to eat, and changes his skin, preserving the same bulk. This sleep being over, he begins to eat again, during five days, at which term he is grown to the size of full half an inch in length; after which follows a second sickness in every respect like the former.

He then feeds for other five days; during which time he will have increased to about three quarters of an inch in length, when he is attacked with his third sickness. This being over, he begins to eat again, and continues to do so for five days more, when he is attacked by his fourth sickness, at which time he is arrived at his full growth. When he recovers this sickness, he feeds once more during five days with a most voracious appetite; after which he discards his food, becomes transparent, a little on the yellowish cast, and leaves his silky traces on the leaves where he passes. These signs denote that he is ready to begin his cocoon, and will eat no more.

Thus it appears that the whole duration of the life of the worm, in this state of its existence, in our climate, is usually about 36 days; 28 of which days he takes food, and remains in his sick or torpid state 8; but it is to be observed, that during warm weather the periods of sickness are shortened, and in cold weather lengthened, above the terms here specified. In very hot cli-

<sup>Silk.</sup> mates it may be said to live faster, and sooner to attain maturity, than in those that are colder. Dr Anderson informs us, that at Madras the worm undergoes its whole evolutions in the space of 22 days. It appears, however, that it feeds fully as many days in India as in Europe, the difference being entirely occasioned by shortening the period of sickness. The longest sickness he had seen them experience there did not exceed two days; and during summer it only lasts a few hours.

When the worm has attained its full growth, it searches about for a convenient place for forming its cocoon, and mounts upon any branches or twigs that are put in its way for that purpose. After about two days spent in this manner, it settles in its place, and forms the cocoon, by winding the silk which it draws from its bowels round itself into an oblong roundish ball.

During this operation it gradually loses the appearance of a worm; its length is much contracted, and its thickness augmented. By the time the web is finished, it is found to be transformed into an oblong roundish ball, covered with a smooth shelly skin, and appears to be perfectly dead. In this state of existence it is called an *aurelia*. Many animals in this state may be often seen sticking on the walls of out-houses, somewhat resembling a small bean.

In this state it remains for several days entirely motionless in the heart of the cocoon, after which it bursts like an egg hatching, and from that comes forth a heavy dull looking moth with wings; but these wings it never uses for flying; it only crawls slowly about in the place it has been hatched. This creature forces its way through the silk covering which the worm had woven, goes immediately in quest of its mate, after which the female lays her eggs; and both male and female, without tasting food in this stage of their existence, die in a very short time.

The silk worm, when at its full size, is from an inch and a quarter to an inch and a half in length, and about half an inch in circumference. He is either of a milk or pearl colour, or blackish; these last are esteemed the best. His body is divided into seven rings, to each of which are joined two very short feet. He has a small point like a thorn exactly above the anus. The substance which forms the silk is in his stomach, which is very long, wound up, as it were, upon two spindles, as some say, and surrounded with a gum, commonly yellowish, sometimes white, but seldom greenish. When the worm spins his cocoon, he winds off a thread from each of his spindles, and joins them afterwards by means of two hooks which are placed in his mouth, so that the cocoon is formed of a double thread. Having opened a silk worm, you may take out the spindles, which are folded up in three plaits, and, on stretching them out, and drawing each extremity, you may extend them to near two ells in length. If you then scrape the thread so stretched out with your nail, you scrape off the gum, which is very like bees wax, and performs the same office to the silk it covers as gold leaf does to the ingot of silver it surrounds, when drawn out by the wire drawer. This thread, which is extremely strong and even, is about the thickness of a middling pin.

Of silk worms, as of most other animals, there is a considerable variety of breeds, some of which are much more hardy, and possess qualities considerably different from others. This is a particular of much importance

6  
Particular attention should be paid to the rearing of silk worms

Silk.

Silk.

to be adverted to at the time of beginning to breed these creatures in any place; for it will make a great difference in the profit on the whole to the undertaker if he rears a good or a bad sort (A). This is a department in respect to the economy of animals that has been in every case much less adverted to than it deserves; and in particular with regard to the silk worm it has been almost entirely overlooked. A few eggs of the silk worm can be easily transported by post in a letter from any part of Europe to another, especially during the winter season. It would therefore be an easy matter for any patriotic society, such as the Society of Arts in London, to obtain a specimen of the eggs from every country in which silk is now reared, to put these under the care of a person who could be depended upon, and who understood the management of them, with orders to keep each kind distinct from another, and advert to every particular that occurred in their management, so as to make a fair estimate of their respective merits. By these means the best might be selected, and those of inferior value rejected. Forty or fifty of each sort might be enough for the experiment; but it ought to be repeated several times before conclusions could be drawn from it that might be altogether relied upon; for it is well known that a variation of circumstances will make a change in the result; and it is by no means certain that the same particular would affect those of one breed exactly in the same manner as it would do those of a different breed. One may be more hardy with regard to cold, another more delicate in respect to food, and so on. It is experience alone that can ascertain the circumstances here inquired for.

7  
ma-  
nient  
ilk  
ms  
ft be  
erent  
ifferent  
ates;

From the above-mentioned particulars, it is evident, that the management of silk worms must be very different in hot climates from what is required in those that are colder. At Madras, it appears from Dr Anderson's experiments that it is very difficult to prevent the eggs from hatching for a very few days, so that many generations of them must be propagated in one year. "In this hottest season," says he, in a letter to Sir Joseph Banks, dated July 6. 1791, "the shortest time I have been able to remark for the whole evolutions of the silk worm is 40 days; that is to say, six days an egg, 22 a worm, 11 a grub in the cocoon, and one a moth or butterfly." Fortunately, where the climate forces forward their production so rapidly, nature hath been equally provident of food for their subsistence; for in these regions the mulberry continues to grow and push out leaves throughout the whole year.

8  
t may be  
ly rear-  
in rem-  
ate  
nes.

Though the silk worm be a native of China, there is no doubt but it might easily be propagated perhaps in most parts of the temperate zones. The eggs

Vol. XVII. Part II.

of this insect, indeed, require a considerable degree of warmth to hatch them, but they can also endure a severe frost. No less than 5400 lbs of silk was raised in 1789 in the cold, sandy territories of Prussia. In the province of Pekin, in China, where great quantities of silk are fabricated, the winter is much colder than even in Scotland. From the information of some Russians who were sent thither to learn the Chinese language, we find that Reaumur's thermometer was observed from 10 to 15, and even 20 degrees below the freezing point. Nor is it difficult to rear the food of the silk worm in a temperate climate. The mulberry-tree is a hardy vegetable, which bears, without injury, the winters of Sweden, and even of Siberia. Of the seven species of the mulberry (see *MORUS*) enumerated by Linnæus, four of these (viz. the white, red, black, and Tartarian), there is every reason to believe could be reared both in Britain and Ireland. The *white* grows in Sweden; the *red* is abundant round Quebec; the *black* delights in bleak situations, exposed to wind on the sea shore; and the *Tartarian* mulberry is represented as growing in the chilly regions of Siberia.

Bee. N°  
156.

As to the superior qualities of the different species, probably there is very little to be pointed out amongst the four just mentioned with regard to nourishment, except what may be drawn from the following fact: that if the first three are laid down together, the silk worm will first eat the white, then the red, and next the black, in the order of the tenderness of the leaves. The Tartarian seems to hold as high a place in its esteem as either the red or black; but all must yield to the white, which seems to be its natural food.

9  
Whether  
probably there is very little to be pointed out amongst  
the four just mentioned with regard to nourishment, ex-  
cept what may be drawn from the following fact: that  
if the first three are laid down together, the silk worm  
will first eat the white, then the red, and next the black,  
in the order of the tenderness of the leaves. The Tar-  
tarian seems to hold as high a place in its esteem as ei-  
ther the red or black; but all must yield to the white,  
which seems to be its natural food.

In Calabria the red mulberry is used; in Valencia the white; and in Granada, where excellent silk is produced, the mulberries are all black. The white seems to prosper very well in a moist stiff soil: the black agrees well with a dry, sandy, or gravelly soil; and the white is most luxuriant in a moist rich loam.

It may justly be asserted, that Britain possesses some advantages in the raising of raw silk which are not enjoyed by warmer countries. Even in the south of France, Mr Arthur Young informs us, the mulberry leaves are often nipped by frost in the bud; but this is scarcely ever the case with us. It is well known that thunder and lightning are hurtful to the silk worm.

10  
Britain pos-  
sesses some  
advantages  
over warm-  
er countries  
for raising  
silk.

Now our climate can boast that it is almost wholly exempted from those dreadful storms of thunder and lightning which prevail so much in hot climates. Nature has then furnished us with every thing requisite for the silk manufacture; it remains only for us to improve the advantages which we possess. Let mulberry trees be planted by proprietors of lands, and let a few persons

3 P

of

(A) As the success of the silk manufacture must depend on the breed of worms, it is of great consequence to bring them from those countries where they are reckoned best.

Mr Andrew Wright, an ingenious silk manufacturer of Paisley, has given the following directions for conveying the eggs of the silk worm from distant countries by sea: As soon as the moth has laid her eggs, dry them immediately, and put them into glass vials; seal them so close that damp air or water will not penetrate into them. Put these vials that contain the eggs into earthen pots filled with cold water; and as often as the water becomes warm renew it. Place the earthen vessels in the coldest place of the ship, and let them remain until the end of the voyage. It must be observed, that the ship chosen for this purpose ought to be one that would arrive in Britain in the months of June or July.

*Silk.* of skill and attention devote their time to the raising of silk worms. This is an employment that will not interfere with any manufacture already established; on the contrary, it would afford a respectable, a lucrative, and agreeable employment to ladies, or to females in general, who have at present too few professions to which they can apply. The society instituted at London for the encouragement of arts, manufactures, and commerce, much to their honour, have offered premiums to those who shall plant a certain number of mulberry trees.

11  
Method of raising mulberry-trees in the south of France.

Letters on the Culture of Rare Silk on the Coast of Comman-dit.

The following method of raising mulberry trees from seed is practised in the south of France, and has been repeated with success in the East Indies by Dr Anderson of Madras. "Take the ripe berries of the mulberry when it is full of juice and of seeds. Next take a rough horse hair line or rope, such as we dry linen on, and with a good handful of ripe mulberries run your hand along the line bruising the berries and mashing them as much as possible as your hand runs along, so that the pulp and seeds of the berries may adhere in great abundance to the rope or hair line. Next dig a trench in the ground where you wish to plant them, much like what is practised in kitchen gardens in England for crops of various kinds. Next cut the rope or hair line into lengths according to the length of the trench you think fit to make, and plunge the line full of mashed berries into the trench, and then cover it over well with earth, always remembering afterwards to water it well, which is essential to the success. The seeds of the berries thus sown will grow, and soon shoot out young suckers, which will bear young leaves, which are the best food for the silk worm.

"The facility and rapidity with which young leaves may by this means be produced is evident, for as many rows of trenches may thus be filled as can be wished; and it can never be necessary to have mulberry trees higher than our raspberries, currants, or gooseberry bushes. Whenever they get beyond that, they lose their value; and if these trenches succeed, you may have a supply coming fresh up day after day, or any quantity you please." Thus abundance of these trees might be reared. But as mulberry trees are not yet found in abundance in this country, it were to be wished that some other food could be substituted in their place: attempts have accordingly been made by those who have reared silk worms, and it has been found possible to support the silk worm upon lettuce (B).

*Bee, N<sup>o</sup> 70.* Miss Henrietta Rhodes, a lady who has made some successful experiments on raising silk worms in England, had found that the silk worm could with safety be kept on lettuce for some time. This is pretty generally known by ladies who have turned their attention to this subject; but she found that in general they could not with safety be kept upon that food above three weeks. If longer fed upon that plant, the worms for the most part die without spinning a web at all. She found, however, that they did not always die, but that in some

12  
Miss Rhodes fed silk worms on lettuce for some time.

cases they produced very good cocoons, even when fed entirely on lettuce. She therefore with reason suspected that the death of the animal must be occasioned by some extraneous circumstance, and not from the poisonous quality of the food itself; the circumstance she suspected, from some incidental observations, was the coldness of that food; and therefore she thought it was not impossible, but if they were kept in a very warm place, while fed on lettuce, they might attain, in all cases, a due perfection.

General Mordaunt having been informed of this conjecture, resolved to try the experiment. He got some silk worms eggs, had them hatched in his hot-house, and caused them to be all fed upon lettuce and nothing else. They prospered as well as any worms could do, few or none of them died; and they afforded as fine cocoons as if they had been fed upon mulberry leaves. As far as one experiment can go, this affords a very exhilarating prospect in many points of view. If one kind of food has been noxious, merely on account of an improper temperature, others may be found which have been hurtful only from a similar cause; so that it is not impossible but we may at last find that this delicate creature may be supported by a variety of kinds of food. Few, however, could be more easily obtained than lettuce; and this plant, when cabbaged (the coles, or ice lettuce especially), would possess one quality that the mulberry leaf never can possess, from the want of which many millions of worms die in those countries where silk is now reared; for it is observed, that when the leaves are gathered wet, it is scarcely possible to preserve the worms alive for any length of time; so that during a continuance of rainy weather many of them are unavoidably cut off; but a lettuce, when cabbaged, resists moisture. If gathered, even during rain, the heart of it is dry; so that if the outer leaves be thrown aside at that time, the worms would be continued in perfect health. The expence, too, of cultivating and gathering lettuce, would be so much less than that of gathering mulberry leaves, as to occasion a saving that would be much more than sufficient to counterbalance the expence of heating the conservatory, as a little reflection will show.

But the great point to be now ascertained is, whether it is a fact that worms fed on lettuce, if kept in a due temperature, will continue in good health, in general, till they shall have perfected their cocoon? One experiment is too little to establish this fact with perfect certainty. It would therefore be necessary that more experiments should be made on this subject.

It is said that Dr Lodovico Bellardi, a learned and ingenious botanist of Turin, has, after a number of experiments, discovered a new method of feeding silk worms, when they are hatched before the mulberry trees have produced leaves, or when it happens that the frost destroys the tender branches. This new method consists in giving the worms dried leaves of the mulberry-tree. One would think that this dry nourishment

3

(B) It is not improbable, says Dr Anderson, to whose valuable work entitled the *Bee*, we have been much indebted in the drawing up of this article, that other kinds of food may be found which will answer the same purpose. The choricium intybus and common endive might be tried, as they have the same lactescent quality with the lettuce.

*Silk.*

13  
General Mordaunt had more successful.

14  
silk worm laid to lettuce on dried mulberry leaves.



Silk. ment would not be much relished by these insects; but repeated experiments made by our author, prove that they prefer it to any other, and eat it with the greatest avidity. The mulberry leaves must be gathered about the end of autumn, before the frosts commence, in dry weather, and at times when the heat is greatest. They must be dried afterwards in the sun, by spreading them upon large cloths, and laid up in a dry place after they have been reduced to powder. When it is necessary to give this powder to the worms, it should be gently moistened with a little water, and a thin coat of it must be placed around the young worms, which will immediately begin to feed upon it.

15 per ex  
ments  
ht to be  
le on  
ous ve-  
bles.

We have mentioned all the different kinds of food, which, as far as we have heard, have been tried with any success to nourish the silk worm; not, however, with great confidence, but as experiments which it might be worth while carefully to consider and perform. We must not omit to mention that one person, who has had much experience in the managing of silk worms, assures us, that the silk produced from any other food than mulberry leaves is of an inferior quality, and that the worms are sickly. We think, however, that there is reason to suspect that the experiment has not been skillfully performed; and therefore, before every other food except mulberry leaves is discarded, the experiment ought to be performed with more attention and care. We know that many animals in a domestic state can live upon food very different from that which supported them when running wild in the fields. Certain it is, however, that every animal, in its state of nature, partakes of a food peculiar to itself, which is rejected by other animals as if it were of a poisonous quality; and it may be mentioned as a curious fact, as well as an admirable instance of the care of that Being who feeds the fowls of heaven, that notwithstanding the numberless insects that prey upon animals and vegetables, the mulberry tree is left untouched by them all, as the exclusive property of the silk worm, the chief of the insect tribe, which toils and spins for the use of man.

16 at flu  
and  
ments  
er  
hefe  
ts.

Having now considered the food proper for the silk worm, we shall next consider what situation is most favourable to them. In the opinion of some persons in this country who have been in the practice of rearing silk worms, they ought always to be kept in a dry place, well sheltered, and possessing a considerable degree of warmth, and which is not exposed to sudden transitions from heat to cold. If the weather be too cold, a small fire must be made: this is of most importance when the worms are ready for spinning. A southern exposure is therefore preferable. Some think light is of great utility to silk worms, others think that they thrive better in the dark. As to what apartments are best accommodated for promoting the health of silk worms, and most convenient for those who have the care of them, they may be various according to the extent of the manufacture or the wealth of the proprietors. Silk worms may be kept in boxes or in shelves. When shelves are to be used, they may be constructed in the following manner: The shelves may be of wicker, ranged at the distance of a foot and a half, and fixed in the middle of the room: their breadth ought to be such, that any person can easily reach to the middle from either side. This is perhaps the simplest and cheapest apparatus for rearing silk worms; but there is another apparatus which

may be recommended to those who are anxious to unite some degree of elegance with convenience. This apparatus is the invention of the Rev. George Swayne of Puckle-church, a gentleman who, greatly to his honour, has studied this subject much, in order to find out the way for promoting the culture of silk among the poor. This apparatus, with the description of it, we have borrowed from that valuable and patriotic work, the Transactions of the Society for encouraging Arts, Manufactures, and Commerce, Vol. VII. p. 148. The apparatus consists of a wooden frame four feet two inches high, each side 16 inches and a half wide, divided into eight partitions by small pieces of wood which form grooves, into which the slides run, and are thus easily thrust into or drawn out of the frame. The upper slide (a) in the model sent to the society by Mr Swayne is of paper only, and designed to receive the worms as soon as hatched; the two next (b, b) are of catgut, the threads about one-tenth of an inch distant from each other: these are for the insects when a little advanced in size: the five lower ones, marked c, c, c, c, c, are of wicker work; but, as Mr Swayne afterwards found, netting may be substituted with advantage instead of wicker bottoms. Under each of these, as well as under those of catgut, are sliders made of paper, to prevent the dung of the worms from falling on those feeding below them.

17 Mr  
Swayne's  
appara us  
described.

18 Plate  
CCCLXVI.

The management of silk worms is next to be attended to. The proper time for hatching them is when the leaves of the mulberry are full grown, or nearly so; that as soon as these insects are capable of receiving food they may obtain it in abundance. To attempt to hatch them sooner would be hurtful, as the weather would not be sufficiently warm. Besides, as leaves are necessary to the life of a vegetable, if the young leaves of the mulberry-tree are cropped as soon as they are unfolded, the tree will be so much weakened as to be incapable of producing so many leaves as it would otherwise have done; and if this practice be frequently repeated, will inevitably be destroyed.

19 How they  
ought to be  
hatched  
and fed.

When the proper season is arrived, the eggs may be hatched either by the heat of the sun, when it happens to be strong enough, or by placing them in a small room moderately heated by a stove or fire; and after being exposed for six or seven days to a gentle heat, the silk worm issues from the egg in the form of a small black hairy caterpillar. When Mr Swayne's apparatus is used, the worms are to be kept on the drawers with paper bottoms till they are grown so large as not readily to creep through the gauze-bottomed drawers: they are then to be placed on those drawers, where they are to remain till their excrements are so large as not readily to fall through; when this is the case, they must be removed to the drawers with the wicker or netting bottoms, and fed thereon till they show symptoms of being about to spin. It is scarcely necessary to mention, that the paper slides beneath the gauze and wicker drawers are intended to receive the dung, which should be emptied as often as the worms are fed, at least once a-day; or to direct, that when the worms are fed, the slides are to be first drawn out a considerable way, and the drawers to rest upon them.

20 Wet or  
damp food  
produce  
contagious  
diseases.

It has been already mentioned, that wet or damp food is exceedingly prejudicial to these insects. It produces contagious and fatal diseases. To prevent the necessity of giving them wet or damp food, attention

Silk.

ought to be paid to the weather, so that when there is an immediate prospect of rain, a sufficient quantity of leaves may be gathered to serve the worms two or three days. In this country, the leaves of the black or red mulberry tree may be preserved good for food, although kept four or five days, by the following method: When new gathered, lay them loosely in glazed earthen vessels, place these in a cold place, well aired, not exposed to drought.

21  
Ought to  
be kept as  
clean as  
possible.

The utmost attention must be paid to preserve the place where silk worms are kept as clean as possible: the house or room must be well ventilated, that no noxious vapours be accumulated. By some experiments of M. Faujas de St Fond, which are recorded in his history of Languedoc, it appears that the silk worm is much injured by foul air. All decayed leaves must be removed from them, as it is now well known that they emit bad air in great abundance.

See, N<sup>o</sup> 91.

22  
How they  
may be  
cleaned  
without  
bruising  
them.

One of the most difficult branches of the management of silk worms has hitherto been the cleaning without bruising them. To avoid this inconvenience, the peasants in France and Italy frequently allow the whole litter to remain without ever cleaning them, which is the cause of that unwholesome stench that has been so often remarked by those who visit the places for rearing silk worms in these countries. This difficulty may be effectually removed by providing a net, or, what would be still better, a wire-bottomed frame, wrought into large meshes like a riddle. Have that made of a size exactly sufficient to cover the wooden box in which the worms are kept. When you mean to shift them, spread fresh leaves into the wire basket; and let it down gently over the worms till it comes within their reach. They no sooner perceive the fresh food than they abandon the rubbish below, and creep through the meshes, so as to fix themselves upon the leaves; then by gently raising the fresh basket, and drawing out the board below (which ought to be made to slip out like the slip bottom of a bird's cage), you get off all the excrements and decayed leaves, without incommoding the worms in the smallest degree; and along with the litter you will draw off an inch or two in depth of the foulest mephitic vapours. To get entirely rid of these, the board, when thus taken out, should be carried without doors, and there cleaned; and the slip board immediately replaced to receive all the excrements and offals. After it is replaced, the wire frame that had been elevated a little, may be allowed to descend to a convenient distance above the board without touching it. Thus will there

be left a vacant space for the mephitic air to fall below the worms, so as to allow them to inhabit a wholesome region of the atmosphere.

Silk.

When a fresh supply of food is to be given before cleaning, the wire frame ought to be let down as close to the board as can be safely done, and another wire-bottomed frame put over it, with fresh leaves, as before described. When the worms have abandoned that in their turn, let the slip-board, together with the lower wire frame, be drawn out and removed, and so on as often as necessary. To admit of this alternate change, every table, consisting of one slip-board, ought to have two sets of wire-bottomed frames of the same size; the slip board to be always put into its place immediately after it is cleaned, and the wire frames reserved to be afterwards placed over the other. By this mode of management, it is probable that the worms would be saved from the diseases engendered by the mephitic air, and the numerous deaths that are the consequence of it avoided.

Dr Anderson, to whom we have already acknowledged our obligations, and to whom this country has been much indebted for valuable works on agriculture, the fisheries, &c. advises those who have the management of silk worms to strew a thin stratum of fresh slaked quicklime upon the slip-board each time it is cleaned, immediately before it is put into its place. This would absorb the mephitic gas, for as soon as it is generated it would descend upon the surface of the quicklime. Thus would the worms be kept continually in an atmosphere of pure air (c). Were the walls of the apartments to be frequently washed with quicklime and water, it would tend much to promote cleanliness at a small expence, and augment the healthiness of the worms as well as that of the persons who attend them.

When the silk worm refuses its food, and leaves silky traces on the leaves over which it passes, it is a proof that it is ready to begin its cocoon. It is now necessary to form a new receptacle, which is commonly done by pinning together papers in the shape of inverted cones with broad bases. "This method (says Mr Swayne), where there are many worms, is exceedingly tedious, wastes much paper, and uses a large number of pins; besides, as the silk worm always weaves an outer covering or defensive web before it begins the cocoon or oval ball, I apprehended that it caused a needless waste of silk in forming the broad web at the top. The method I make use of is, to roll a small piece of paper (an uncut octavo leaf, such as that of an old magazine, is sufficient

(c) To put this question beyond a doubt, Mr Blancard made the following comparative experiments, which were several times repeated. "I procured (says he) four glass jars nine inches high and five in diameter, closing the mouth with cork stoppers. After which I placed in each of them, in their second life (so *mue* may be translated which means the stage between the different sicknesses), twelve silk worms, which were fed four times a-day; and which I confined in this kind of prison all their life, without taking away either their dead companions or their ordure or litter. I sprinkled with chalk the worms of only two of these jars, and kept the two others to compare with them.

"In those without lime, I never obtained neither more nor less than three small and imperfect cocoons (*chiques ou bouffard*), and in the two that were sprinkled with lime, I had very often twelve, and never less than nine fine full-sized firm cocoons."

This experiment affords the most satisfactory proof of the utility of this process. From a number of trials he found, that even when the worms were covered with a very large proportion of lime, they never were in any way incommoded by it.

<sup>25</sup> <sup>silks.</sup> sufficient for three), round my fore-finger, and to give it a twist at the bottom; which is done with the utmost expedition, and gives no occasion for the use of pins. These rolled paper-cases being likewise of a form more nearly resembling that of a cocoon, with a much narrower opening on the top than the others, takes away the necessity of wasting much silk in the outer web, and consequently leaves more to be employed in forming the ball. The silk is readily taken out of these cases by untwisting the bottom; and if this be done with moderate care, and the papers are preserved, they will serve several times for the like purpose."

<sup>26</sup> Others advise, that when the silk worms are preparing to spin, little bushes of heath, broom, or twigs, should be stuck upright near the shelf or box in which they are inclosed: the worms mount these, and attach their web to them.

<sup>27</sup> When the worms are ready to mount, in order to spin, if the weather be hot, attended with thunder, you will see them in a languishing condition; your care must then be to revive them, which is effected thus: Take a few eggs and onions, and fry them in a pan with some stale hog's lard, the ranker the better, and make pancake; which done, carry it smoaking hot into the room where they are kept, and go round the chamber with it. You will be surpris'd to see how the small revives them, excites those to eat who have not done feeding, and makes the others that are ready to spin climb up the twigs.

<sup>28</sup> In about ten or twelve days, according to the accounts which we have received from Mr Andrew Wright of Paisley, it may be safely concluded, that if the worms have finished their work, the cocoons may be collected.

We shall now distinguish the cocoons from one another according to their value or their use, and consider the method of managing each. They may be distinguished into the good and bad. The good cocoons may be known by these marks: they are little, strong, and firm; have a fine grain, both ends are round, and they are free from spots. Among the good cocoons also may be arranged those which are called *calcined* cocoons, in which the worm, in consequence of sickness, is petrified or reduced to a fine powder. These cocoons produce more silk than others, and are sold in Piedmont at half as much again. They may be distinguished by the noise which the worm makes when the cocoon is shaken. Of the bad cocoons there are six species: 1. The *pointed cocoons*, one extremity of which ends in a point; the silk which covers the point is weak, and soon breaks or tears. 2. The *coccolons*, which are bigger, but the contexture is weak. 3. The *dupions*, or double cocoons, which have been formed by the joint labour of two and sometimes of three worms. 4. The *joufflons*, which have a loose contexture, sometimes so loose that they are transparent. 5. The *perforated cocoons*, which have a hole at one end. 6. The *bad choquette*, which is composed of defective cocoons, spotted or rotten. Besides these there is the *good choquette*, which does not properly belong to either of these two classes: it is formed of those cocoons in which the worm dies before the silk is brought to perfection. The worms adhere to one side of the cocoon, and therefore when the cocoon is shaken will not rattle: the silk is as fine, but is not of so bright a colour, nor is so strong and nervous, as that which is obtained from good cocoons.

<sup>29</sup> The cocoons which are kept for breeding are called *royal cocoons*. For selecting and preserving these, we have been favoured with some valuable instructions by Mr Wright of Paisley, which we shall present to our readers.—The largest and best cocoons ought to be kept for breed, about an equal number of males and females; the cocoons that contain the former are sharp-pointed at the ends than those that contain the latter. Although it should happen that there are more females than males, little inconvenience or ill consequences can arise from it, as one male will serve two or three females, at the time of their coming out of the cocoons answer. About 12 or 15 days after they begin to spin, the cocoons for breed may be laid on sheets of white paper; about this time the moth opens for itself a passage through the end of its cocoon, and issues out. When the female has laid her eggs, which on an average may amount to 250, they are spread upon sheets of paper and hung up to dry in some place where they may not be exposed to the heat of the sun: after being dried they must be kept in a cool well-aired place, where neither vapours nor moisture can reach them. That they may be preserved from external accidents, as insects of different kinds will destroy them, and mice is their enemy in all the stages of their existence, they should be kept in stone pots or glass bottles with their mouths stopped, and there remain until brought out next season to be hatched.

<sup>30</sup> The cocoons from which the silk is to be immediately wound must be exposed to the heat of an oven, in order to kill the chrysalis or aurelia, which would otherwise eat its way through the cocoon, and render it useless. The following directions are given for managing this process by one of the first silk manufacturers in Italy.

Put your cocoons in long shallow baskets, and fill them up within an inch of the top. You then cover them with paper, and put a wrapper over that. These baskets are to be disposed in an oven, whose heat is as near as can be that of an oven from which the bread is just drawn after being baked. When your cocoons have remained therein near an hour, you must draw them out; and to see whether all the worms are dead, draw out a dupion from the middle of your basket and open it: if the worm be dead, you may conclude all the rest are so; because the contexture of the dupion being stronger than that of the other cocoons, it is consequently less easy to be penetrated by the heat. You must observe to take it from the middle of the basket, because in that part the heat is least perceptible. After you have drawn your baskets from the oven, you must first cover each of them with a woollen blanket or rug, leaving the wrapper besides, and then you pile them above one another. If your baking has succeeded, your woollen cover will be all over wet with a kind of dew, the thickens of your little finger. If there be less, it is a sign your cocoons have been too much or too little baked. If too much baked, the worm, being over-dried, cannot transpire a humour he no longer contains, and your cocoon is then burnt. If not enough baked, the worm has not been sufficiently penetrated by the heat to distil the liquor he contains, and in that case is not dead.

You must let your basket stand thus covered five or six hours if possible, in order to keep in the heat, as this makes an end of stifling those worms which might have avoided the first impression of the fire. You are like-

Silk.

wife to take great care to let your cocoons stand in the oven the time that is necessary; for if they do not stand long enough, your worms are only stunned for a time and will afterwards be revived. If, on the other hand, you leave them too long in the oven, you burn them: many instances of these two cases are frequently to be met with. It is a good sign when you see some of the butterflies spring out from the cocoons which have been baked, because you may be certain they are not burnt. For if you would kill them all to the last worm, you would burn many cocoons which might be more exposed to the heat than that particular worm.

30  
How the  
silk is to be  
wound  
from the  
cocoons.

The next operation is the winding of the silk. Before you begin to wind, you must prepare your cocoons as follows:

1. In stripping them of that waste silk that surrounds them, and which served to fasten them to the twigs. This burr is proper to stuff quilts, or other such uses; you may likewise spin it to make stockings, but they will be coarse and ordinary.

2. You must sort your cocoons, separating them into different classes in order to wind them apart. These classes are, the good white cocoons; the good cocoons of all the other colours; the dupions; the coccalons, among which are included the weak cocoons; the good choquette; and, lastly, the bad choquette. In sorting the cocoons, you will always find some perforated cocoons amongst them, whose worm is already born; those you must set apart for fleuret. You will likewise find some fousilons, but very few; for which reason you may put them among the bad choquette, and they run up into waste.

The good cocoons, as well white as yellow, are the easiest to wind; those which require the greatest care and pains are the coccalons; you must wind them in cooler water than the others, and if you take care to give them to a good windster, you will have as good silk from them as the rest. You must likewise have careful windsters for the dupions and choquettes. These two species require hotter water than the common cocoons.

The good cocoons are to be wound in the following manner: First, choose an open convenient place for your silature, the longer the better, if you intend to have many furnaces and coppers. The building should be high and open on one side, and walled on the other, as well to screen you from the cold winds and receive the sun, as to give a free passage to the steam of your basons or coppers.

These coppers or basons are to be disposed (when the building will admit of it) in a row on each side of the silature, as being the most convenient method of placing them, for by that means in walking up and down you see what every one is about. And these basons should be two and two together, with a chimney between every couple.

Having prepared your reels (which are turned by hands, and require a quick eye), and your fire being a light one under every bason, your windster must stay till the water is as hot as it can be without boiling. When every thing is ready, you throw into your basons two or three handfuls of cocoons, which you gently brush over with a wisk about six inches long, cut stumpy like a broom worn out: by these means the threads of the cocoons stick to the wisk. You must

Silk.

disengage these threads from the wisk, and purge them by drawing these ends with your fingers till they come off entirely clean. This operation is called *la Battue*.

When the threads are quite clear, you must pass four of them (if you will wind fine silk) through each of the holes in a thin iron bar that is placed horizontally at the edge of your bason; afterwards you twist the two ends (which consist of four cocoons each) twenty or twenty-five times, that the four ends in each thread may the better join together in crossing each other, and that your silk may be plump, which otherwise would be flat.

Your windster must always have a bowl of cold water by her, to dip her fingers in, and to sprinkle very often the said bar, that the heat may not burn the thread.

Your threads, when thus twilled, go upon two iron hooks called rampins, which are placed higher, and from thence they go upon the reel. At one end of the axis of the reel is a cog-wheel, which catching in the teeth of the post-rampin, moves it from the right to the left, and consequently the thread that is upon it; so that your silk is wound on the reel crossways, and your threads form two hanks of about four fingers broad.

As often as the cocoons you wind are done, or break or diminish only, you must join fresh ones to keep up the number requisite, or the proportion; because, as the cocoons wind off, the thread being finer, you must join two cocoons half wound to replace a new one: Thus you may wind three new ones and two half wound, and your silk is from four to five cocoons.

When you would join a fresh thread, you must lay one end on your finger, which you throw lightly on the other threads that are winding, and it joins them immediately, and continues to go up with the rest. You must not wind off your cocoons too bare or to the last, because when they are near at an end, the *bairré*, that is, the husk, joins in with the other threads, and makes the silk foul and gouty.

When you have finished your first parcel, you must clean your basons, taking out all the striped worms, as well as the cocoons, on which there is a little silk, which you first open and take out the worm, and then throw them into a basket by you, into which you likewise cast the loose silk that comes off in making the battue.

You then proceed as before with other two or three handfuls of cocoons; you make a new battue; you purge them, and continue to wind the same number of cocoons or their equivalent, and so to the end.

As was already mentioned, the windster must always have a bowl of cold water by her, to sprinkle the bar, to cool her fingers every time she dips them in the hot water, and to pour into her bason when necessary, that is, when her water begins to boil. You must be very careful to twist your threads a sufficient number of times, about 25, otherwise your silk remains flat, instead of being round and full; besides, when the silk is not well crossed, it never can be clean, because a gout or nub that comes from a cocoon will pass through a small number of these twills, though a greater will stop it. Your thread then breaks, and you pass what foulness there may be in the middle of your reel between

between the two hanks, which serves for a head-band to tie them.

You must observe that your water be just in a proper degree of heat. When it is too hot, the thread is dead, and has no body; when it is too cold, the ends which form the thread do not join well, and form a harsh ill-qualified silk.

You must change the water in your basin four times a-day for your dupions and choquette, and twice only for good cocoons when you wind fine silk; but if you wind coarse silk, it is necessary to change it three or four times. For if you were not to change the water, the silk would not be so bright and glossy, because the worm contained in the cocoons soul it very considerably. You must endeavour as much as possible to wind with clear water, for if there are too many worms in it, your silk is covered with a kind of dust which attracts the moth, and destroys your silk.

You may wind your silk of what size you please, from one cocoon to 1000; but it is difficult to wind more than 30 in a thread. The nicety, and that in which consists the greatest difficulty, is to wind even; because as the cocoon winds off, the end is finer, and you must then join other cocoons to keep up the same size. This difficulty of keeping the silk always even is so great, that (excepting a thread of two cocoons, which we call such) we do not say a silk of three, of four, or of six cocoons; but a silk of three to four, of four to five, of six to seven cocoons. If you proceed to a coarser silk, you cannot calculate so nicely as to one cocoon more or less. We say, for example, from 12 to 15, from 15 to 20, and so on.

What number of worms are necessary to produce a certain quantity of silk has not been ascertained. And as different persons who wished to determine this point have had different results, the truth seems to be, that from various circumstances the same number of worms may produce more silk at one time than at another. It is related in the second volume of the Transactions of the Society for encouraging Arts, &c. that Mrs Williams obtained nearly an ounce and a half of silk from 244 cocoons. Mr Swayne from 50 cocoons procured 100 grains. Miss Rhodes obtained from 250 or the largest cocoons, three quarters of an ounce and a dram. From a paper in the second volume of the American Transactions, which we have before referred to in the course of this article, we are informed that 150 ounces of good cocoons yield about 11 ounces of silk from five to six cocoons: if you wind coarser, something more. But what appears astonishing, Mr Salvatore Bertezzen, an Italian, to whom the Society for encouraging Arts, &c. adjudged their gold medal, raised five pounds of excellent silk from 12,000 worms.

The cocoons produce a thread of very unequal length; you may meet with some that yield 1200 ells, whilst others will scarcely afford 200 ells. In general, you may calculate the production of a cocoon from 500 to 600 ells in length.

As there is every reason to hope that the silk manufacture will soon be carried on with arduity in this country, and to a great extent, we are happy to learn that the silk-loom has been much improved lately by Mr Sholl of Bethnal-Green. It appears from the evidence of several gentlemen conversant in that branch of silk weaving to which this loom is particularly adapted, that

the advantages of this construction are, the gaining light, a power of shortening the porry occasionally, so as to suit any kind of work, being more portable, and having the gibbet firmly fixed, together with the diminution of price; which, compared with the old loom, is as five pounds, the price of a loom on the old construction, to three pounds ten shillings, the price of one of these contrived by Mr Sholl; and that, as the proportion of light work is to strong work as nine to one, this sort of loom promises to be of very considerable advantage, particularly in making modes, or other black work.

As a plate of this loom, with proper references, will render its advantages most intelligible, we shall subjoin these: Plate CCCCLXVI. A, A, The silks; B, B, The breast-roll posts; C, The cut tree; D, D, The uprights; E, The burdown; F, The batton; G, The reeds; H, The harness; I, The breast-roll; K, The chucle; L, The gibbet; M, The treadles; N, The tumblers; O, Short counter-meshes; P, Long counter-meshes; Q, The porry; R, R, Cane roll posts; S, The cane-roll; T, The weight bar and weight; U, U, Counter-weights; W, The breaking rod; X, X, Cross rods.

*Silk-Worm.* See SILK.

SILPHIA, CARRION-BEETLE, in natural history; a genus of animals belonging to the class of *insectæ*, and to the order of *coleoptera*. The antennæ are clavated; the clava are perfoliated; the elytra margined; the head is prominent; and the thorax margined. There are 94 species, of which seven only are natives of Britain and Ireland. 1. The *vespillo*. The margin of the thorax broad. The shells abbreviated, black, with two yellow belts. The thighs of the hind legs large, with a spine near their origin. Length near one inch. It infests dead bodies. 2. The *lipusulata*, is black; the antennæ are long and small, and there are two red spots on the middle of each shell. The length is one-third of an inch. 3. The *pustulata*, is black and oblong; there are four brown spots on the shells: the length is one-fifth of an inch. It lives on trees. 4. The *quadripunctata*. The head, antennæ, and legs black. Margin of the thorax and shells are of a pale yellow, with four black spots. The length half an inch. It is found in Cain-wood, near Hampstead. 5. The *fulvifera*, is black; the antennæ are short and globular; there are five striz on each shell. The shells and wings are short. There are five joints on the two first feet, four on the rest. It lives in sand. 6. The *aquatica*, is brown, with a green bronze tinge. There are four ribs on the thorax. On each shell there are 10 striz. The length is one-fifth of an inch. 7. The *pulicaria*, is black and oblong; the shells are abbreviated; the abdomen is rounded at the extremity; the thorax and shells are scarce margined; the length is one line. It is found frequently running on flowers.

SILPHIUM, in botany: A genus of plants belonging to the class of syngenesia, and to the order of polygama necessaria; and in the natural system arranged under the 49th order, *compositæ*. The receptacle is paleaceous; the pappus has a two-horned margin, and the calyx is squarrose. There are eight species; the laciniatum, terebinthinum, perfoliatum, connatum, aseriticum, trifoliatum, soldaginoïdes, and trilobatum. The first six of these are natives of North America.

SIL-

Silk  
||  
Silphium.  
Transactions  
of the So-  
ciety for en-  
couraging  
Arts, &c.  
vol. viii.

24  
Description  
it.

Berkenhout,  
vol. 1.

Silver.

SILVER, one of the perfect metals, and the whitest and most brilliant among them all, is of the specific gravity, according to Bergman, of 10.552; but according to Kirwan, of 10.095. Its ductility is not greatly inferior to that of gold, as a grain of silver leaf measures somewhat more than 51 square inches; and the silver wire used for astronomical purposes measures only the 750th part of an inch in diameter; which is no more than half the thickness of the hair of the human head. It is harder and more elastic than lead, tin, or gold; but less so than copper, platinum, or iron: like other metals it grows hard by hammering, but is easily reduced to its former state by annealing. It is more destructible than gold, and is particularly acted upon by sulphureous vapours; hence its surface tarnishes in the air, and assumes a dark brown colour.

Cronstedt's  
Mineralogy,  
vol. 1.  
p. 536.

"It has been long thought (says Mr Fourcroy) that silver is indestructible by the combined action of heat and air. It is certain, that this metal kept in fusion, without contact of air, does not appear to be sensibly altered; yet Junker had affirmed, that by treating it a long time in the reverberatory furnace, in the manner of Isaac Hollandus, silver was changed into a vitreous calx. This experiment has been confirmed by Macquer. That learned chemist exposed silver 20 times successively in a porcelain crucible to the fire of the furnace at Seves; and at the 20th fusion he obtained a vitriform matter of an olive green, which appeared to be a true glass of silver. This metal, when heated in the focus of a burning glass, has always exhibited a white pulverulent matter on its surface, and a greenish vitreous covering on the support it rested upon. These two facts remove all doubt respecting the alteration of silver: though it is much more difficult to calcine than other metallic matters, yet it is capable of being converted after a long time into a white calx, which, treated in a violent fire, affords an olive-coloured glass. It may be possible perhaps to obtain a calx of silver by heating this metal when reduced into very fine laminæ, or into leaves, for a very long time in a matrass, as is done with mercury."

Mazellan informs us, that by melting in a due proportion with gold or steel, silver becomes greenish or bluish; so that it is capable of producing the white, yellow, red, green, blue, and olive colours, more or less conspicuously according to the various circumstances of heat and proportions of the mixture. Though he makes mention of the vitrifications by Macquer already taken notice of, he denies that it can be calcined by heat alone. "Silver (says he) is so fixed by itself in the fire, that, after being kept a whole month in fusion, it had only lost one 60th part of its weight, which might be on account of some alloy. It is therefore incapable of being calcined by mere heat; and the calx of silver, which can only be made by means of its solution in acids, is reducible to its metallic form without the addition of any oxygenous substance. But when silver is exposed to the violent heat of the solar rays collected by a powerful lens, a kind of smoke is seen surrounding it, which proves at last to be the minute particles of the metal raised and dispersed by heat, as is evident if a thin plate of gold be exposed to it; for then the particles of silver are seen upon the gold in the same manner as those of gold are seen upon silver in a similar experiment."

By slow cooling after it has been melted, silver cry-

stallizes into quadrangular pyramids. M. Baumé observes, that, in cooling, it assumes a symmetrical form, observable on the surface by small fibres resembling the feathers of a pen. M. Fourcroy observes, that the fine button obtained by cupellation, often presents on its surface five or six sides arranged amongst each other like a pavement; but the crystallization in tetrahedral pyramids has not been observed particularly excepting by Messrs Tillet and Mongez. It has been supposed that silver melts with a smaller degree of heat than copper; but the late improved thermometer of Mr Wedgwood shows that this is a mistake; silver requiring 130° of Fahrenheit more than copper to bring it into fusion. It is found in the earth,

1. *Native*, generally of the fineness of 16 carats; and of this there are several varieties. 1. Thin plated or leaved. 2. Capillary silver, of fine or coarse fibres or arborescent, from Potosi in America and Kunsberg in Norway. 3. A kind is also met with resembling coarse linen in the surface, which in Saxony is called *knit cobalt*. Abundance of this kind is to be met with in Potosi, but more rarely in Saxony and Norway. 4. Sometimes native silver is met with in a crystalline or regularly figured state with shining surfaces. This is found at Kunsberg, but is very scarce. There appears likewise a kind of crystallization on the thin plates of native silver, their surfaces being full of minute pyramidal crystals. Most of the American silver is of the native kind; so is that at Kunsberg in Norway. It is not, however, met with native so commonly in other European mines. A very small quantity of it is found in the mines of Salberg in Westmanland, and of Lotafsen in Dalarne, and several other places in Sweden. It has been found in pretty large lumps in clay mixed with nickel, partly decayed or withered; in which situation it formed the compound called the *stercus asserinum*, or gorse dung ore. 5. A piece of native silver in coal is shown in the mineralogical academy at Freyberg; and Lalmán, quoted by Le Camus, speaks also of a similar silver ore found in a mine of pit-coal †.
- † Cronstedt's Mineralogy, p. 542.
- The capillary silver, according to the observations of Henckel and Rome de Lisse, seems to have been produced by a decomposition of red silver ore; and Wallerius affirms, that if sulphur is mixed in a gentle heat with silver, the latter takes a capillary form. 6. Native silver is likewise sometimes found in the form of spider's webs, and for that reason called by the Spaniards *arane*. 7. It is met with in branches formed by octaedrons inserted into one another. Some of these show the mark of a leaf of fern or of a tree; others are cubes or single octaedrons, whose angles are truncated, tho' these last are but rare. 8. It is often found dispersed through sand and ochre, as well as in grey limestone in Lower Austria, and in a greenish clay near Schemnitz, or mixed with ochre, clay, and calciform nickel. It is generally alloyed with copper, sometimes with gold, iron, or regulus of antimony; and sometimes it contains even five per cent. of arsenic. That found near Kunsberg contains so much gold, that the colour of it is yellow.

Wallerius distinguishes seven species of native silver; viz. 1. In irregular masses and lumps, at Kunsberg in Norway and other places, in a bed of clay. 2. In a granular and jagged form in America and Norway. 3. Arborescent, in the places already mentioned. 4. In thin

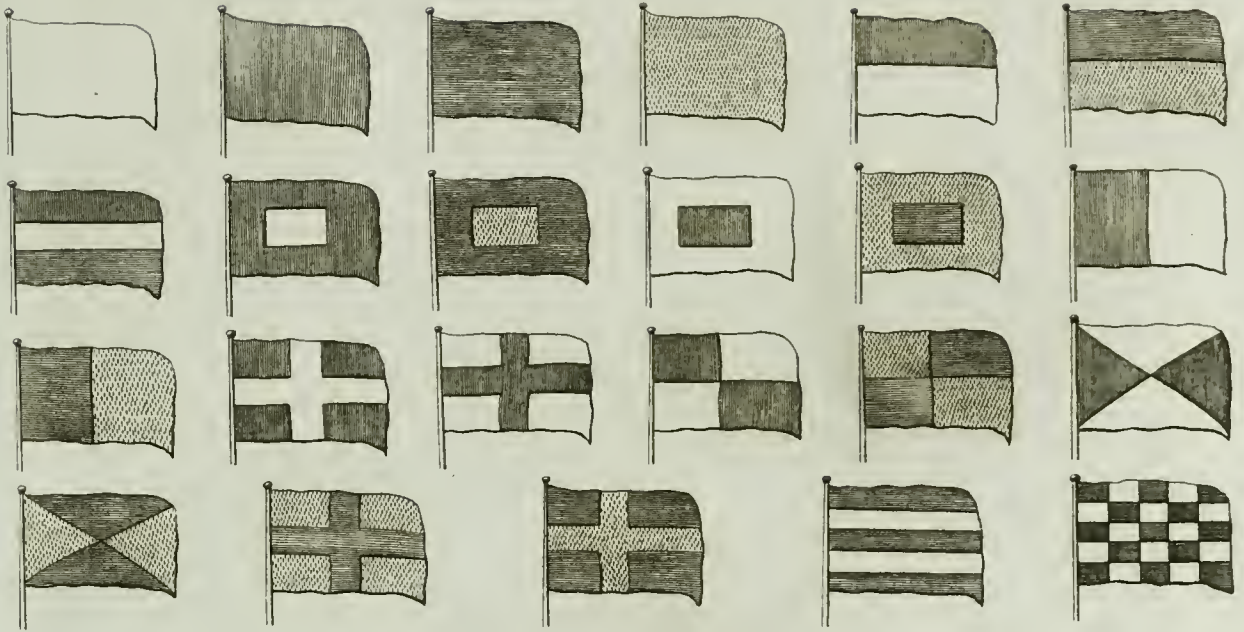

*A. Silk Loom  
improved by M<sup>r</sup>. Sam<sup>l</sup>. Shell.*

*The Rev<sup>d</sup>. M<sup>r</sup>. Swayne's apparatus  
for rearing Silk Worms.*

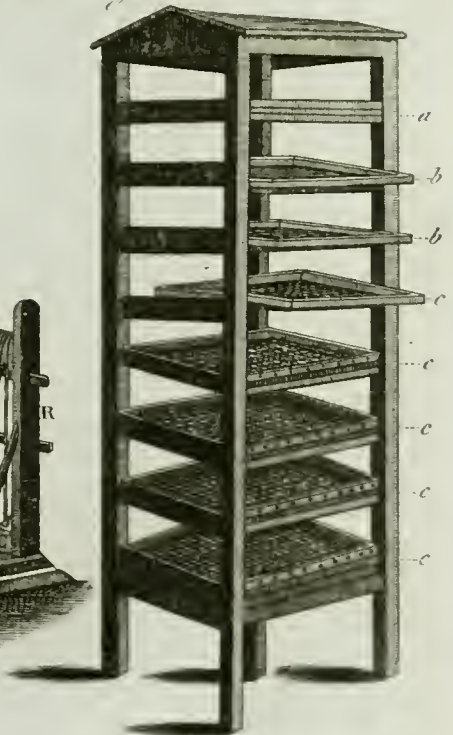
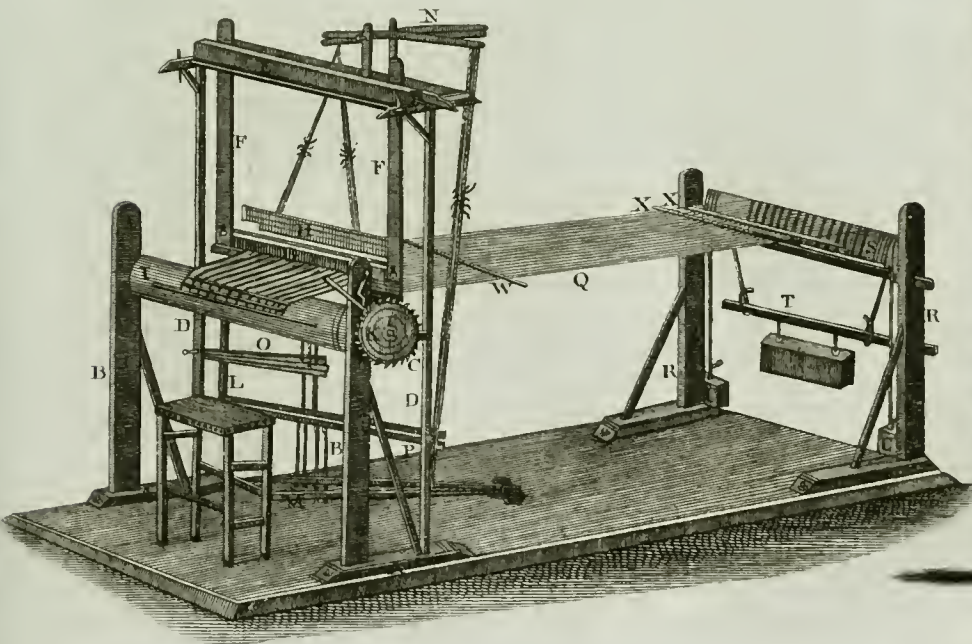

*A. Bell Prin. Mal. Sculptor fecit*





*Silver.* thin leaves, between the fissures of Rones, in Norway and Germany. In a capillary form, in the places already mentioned, including the cobweb silver of the Spaniards already mentioned. 6. Crystallized. 7. Superficial. Mr Daubenton enumerates eight varieties of native white silver, of different forms, most of which have been already enumerated. The materials in which this metal is most commonly found in its native state are, baro-felenite, limestone, selenite, quartz, chert, flint, serpentine, gneiss, agate, mica, calcareous spar, pyrites, schistus, clay, &c. Sometimes it is met with in large masses, of the weight of 60 pounds or more, in or near the veins of most metallic ores, particularly in Peru and in various parts of Europe, of a white, brown, or yellowish colour. In Norway and at Alface it is found in the form of solitary cubes and octahedral lumps, of 50 and 60 pounds weight.

2. *Native silver alloyed with other metals.* 1. With gold, as in Norway, where it contains so much as to appear of a yellow colour. 2. With copper. 3. With gold and copper. 4. Amalgamated with mercury, as in the mines of Salberg. M. Rome de Lisse mentions a native amalgam of silver and mercury found at Muschel Landberg in the duchy of Deux Ponts, in a ferruginous matrix, mixed with cinnabar, and crystallized in a hexagonal form, and of a large size. It was before the French revolution preserved in the king's cabinet at Paris. 5. With iron. According to Bergman, this ore contains two per cent. of iron; but Mongez informs us, that it often does not exceed one per cent. 6. With lead. "Silver (says Mr Magellan) is always contained in lead, though the quantity is generally insufficient to defray the expence of separating it. In the reign of Edward I. of England, however, near 1600 pounds weight of silver were obtained, in the course of three years, from a lead mine in Devonshire, which had been discovered about the year 900. The lead mines in Cardiganshire about at different periods afforded great quantities of silver; so that Sir Hugh Middleton is said to have cleared from them L. 2000 in a month. The same mines in the year 1745 yielded 80 ounces of silver out of every ton of lead. The lead in only one of the smelting houses at Holywell in Flintshire produced no less than 37521 ounces, or 3126½ pounds of silver from the year 1754 to 1756, and from 1774 to 1776. There are some lead ores in England, which, though very poor in that metal, contain between 300 and 400 ounces of silver in a ton of lead; and it is commonly observed, that the poorest lead ores are the richest in silver; so that a large quantity of silver is probably thrown away in England by not having the poorest sort of lead ores properly effayed." 7. Mr Monnet found silver united with arsenic among the ores which came from Guadanal canal in Spain, and an ore of the same kind is furnished by the Samson mine near Andreeberg in the Hartz: but Mr Mongez very properly remarks, that these ores must be distinguished from such as have the arsenic in the form of an acid; for in this case they are properly mineralized by it, whilst there can only be a mixture of native silver, or some of its calces with arsenic in its reguline form. 8. Bergman mentions silver in a state of union with antimony. The ore yields some smoke when roasted, but has not the garlic smell observable in the arsenical ores. 9. The white silver ore, found in the mines near Freyberg, has the metal united

Vol. XVII. Part II.

to the regulus of arsenic and iron, the three metallic ingredients being nearly in equal proportions. All the extraneous matters with which the silver is united are sometimes in exceedingly small proportion, but not to be neglected where they exceed the hundredth part of the whole mass. 10. A particular kind of stony silver ores is mentioned by Wallerius under the title of *lapis dea*, and which contain the following varieties, viz. the calcareous silver ore at Annaberg in Austria, when the metal is mixed with an alkaline limestone; the spatulose ore, either white, variegated, or yellowish, found at Schemnitz in Hungary; the quartzose white ore in a powdery form, mixed with ferruginous scoria, found at Potofi in America; the dark and variegated quartzose silver ores, with many other subdivisions distinguished from one another by little else than their colour.

Silver is found mineralized by various substances; as,

1. With sulphur in the glassy or vitreous silver ore; though this name seems rather to belong to the *minera argenti cornea* or horn silver ore, to be afterwards taken notice of more particularly. It is ductile, and of the same colour with lead, but quickly becomes very black by exposure to the air; though sometimes it is grey or black even when first broken. It is found either in large lumps, or inhering in quartz, gypsum, gneiss, pyrites, &c. Its specific gravity, according to Kirwan, is 7,200. An hundred parts of it contain from 72 to 77 of silver, and it is rarely contaminated with any other metal.

Professor Brunnich says that it contains 180 merks of silver in the hundred weight. The medium between the glass ore and the red gilder ore is called *rosch-gewachs* in Hungary, and *brittle glass ore* in Saxony. It is black, and affords a powder of the same colour when pounded. In the mines of Himmelfurst near Freyberg, it is said to have held 140 merks, but these pieces are very scarce at present; and indeed the Hungarian glass ores in general are now very scarce, as Professor Brunnich informs us, though they are now and then found in the windshafts, which are frequently covered with a thin membrane or rather crust, of the colour of pyrites. Mr Magellan says that this ore is nothing else but native silver penetrated by sulphur; for, on being exposed to a slow heat, the latter flies off, and the silver shoots into filaments. There are nine varieties of it. 1. *Like black lead*. or *plumbago*, the most common kind of any. 2. Bruckman mentions a kind *brown* on the outside and greenish within. 3. The *yellow ore* has its colour from some arsenic contained in it, which forms an orpiment with the sulphur. 4. It is also found of a *greenish*, and 5. *bluish* colour; the latter is friable, like the scoria of metals, and is called at Freyberg *Schlarckenetz*, or the ore of scoria. 6. It is found also in the *arborescent*. 7. *Lamellated*. 8. *Crystallized* into octaedral or hexaedral prisms, and into ten pyramids with ten sides. 9. Lastly, it is found *superficial*, or covering the stones or masses of other ores.

2. The pyrites argenteus of Henckel contains silver *Cronstedt's* and iron mineralized with arsenic. There are three va-  
p. 550.  
rieties of it. 1. Hard, white, and shining ore, of a compact, lamellar, or fibrous texture. The brightest kind has least silver, only giving 6 or 8 ounces per quintal, and the richest about ten per cent. It is found in Germany and Spain. It contains no sulphur. 2. Of a yellowish white colour, and striated texture resembling bismuth, but much harder. It is found in Spain, and yields about 60 per cent. of silver. 3. In another kind

Silver.

the quantity of arsenic is so great, that it would scarcely deserve the name of silver ore if the arsenic were not very easily dissipated. It is soft and easily cut; has a brilliant metallic appearance, and consists of conchoidal laminae. A quintal contains only from four to six ounces of silver, but it is easily reduced by evaporating the arsenic, after which the silver is left behind slightly contaminated with iron.

3. The red or ruby silver ore, the *rothgulden* of the Germans, has the metal combined with sulphur and arsenic. It is a heavy shining substance, sometimes transparent, and sometimes opaque; the colour generally crimson, though sometimes grey or blackish. It is found in shapeless masses, or crystallized in pyramids or polygons, sometimes dendritical or plated, or with radiated incrustations. It is found in quartz, flint, spar, pyrites, sparry iron ore, lead ore, cobalt ore, jasper, barro-felenite, gneiss, &c. When radiated or striated, it is called *rothgulden blub.* It cracks in the fire, and detonates with nitre. Its specific gravity is from 5,400 to 5,684. Bergman informs us, that this kind contains, in the hundred, 60, sometimes 70, pounds of silver, 27 of arsenic, and 13 of sulphur. The darkest coloured ores are the richest, the yellow kinds much poorer; but the most yellow do not belong to this species, being in fact an orpiment with 6 or 7 per cent. of silver. This last kind is brought chiefly from Potosi in America, and is called *rofi-cker* by the Spaniards.

4. The *schwarz gulden*, or *silber mu'm*, contains the metal mineralized by sulphur and a small quantity of arsenic and iron. It is of a black sooty colour, and was supposed by Cronstedt to contain a good quantity of copper, to which its colour was owing; but later experiments have evinced, that there is no copper at all in it. It is either of a solid or brittle consistence, and of a glassy appearance when broken, or of a looser texture, and sooty or deep black colour; or it is found like moss, or thin leaves, lying on the surface of other silver ores, or those of lead and cobalt, or in clays, ponderous spar, gneiss, &c. It contains from 25 to 60 per cent. of silver.

5. The *minera argenti alba*, the *Weissgulden* ore of the Germans, is a heavy, soft, opaque substance, fine grained or scaly, bright and shining in its fractures, of a whitish, steely, or lead colour; sometimes crystallized in pyramidal or cylindrical forms, but often in amorphous grains, or resembling moss, or in the form of thin laminae incrustating other bodies, found in quartz, spar, stein, pyrites, blend, lead-ore, cobalt-ore, sparry iron ore, fluors, &c. It is very fusible. Its specific gravity is from 5 to 5,300. Its proportion of silver from 10 to 30 per cent. It is found, though not commonly, in Saxony, Hungary, the Hartz, and St Marie aux Mines.

6. The *weissertz*, or white silver ore, is an arsenical pyrites, containing silver. It is met with in the Saxon mines so exactly resembling the common arsenical pyrites, that it cannot be distinguished from it by inspection. Cronstedt supposes that the silver it contains may exist in a capillary form; but Professor Brunnich thinks this is not altogether the case. It is very scarce, but met with near Freyberg. There is likewise a brown *mu'm* having the appearance of rags, met with in the crevices and upon the lumps of cubic lead ore in a mine

near Clausthal and other places, which contains a great quantity of silver. It is of a whitish shining colour; hard, granulated, and solid, sometimes striking fire with steel. It discovers a mixture of arsenic, by emitting a garlic smell when heated.

7. The *leberertz* of the Germans has the metal combined with sulphurated antimony. It is of a dark grey and somewhat brownish colour. A variety of a blackish blue colour is found in the form of capillary crystals, and called *federertz* or plumose silver ore. It is met with in Saxony, and contains sometimes a mark or half a pound, sometimes only two, three, or four ounces, and sometimes only a mere trifle of silver, per cent. There is another silver ore, also called *leberertz* by the Germans, which contains arsenic and regulus of antimony. This ore is sometimes also found of a dark grey colour; for the most part amorphous, but sometimes crystallized into pyramids. It appears red when scraped, and contains from one to five per cent. of silver. The greatest part of this ore is copper, and the next arsenic. According to Bergman, the copper amounts to 24 per cent. It is found in Transylvania; and a kind was lately discovered in Spain, of a hard solid consistence, and of a greyish blue colour.

8. The *goose dung* ores contain silver mineralized with sulphur in combination with iron, arsenic, and cobalt. It looks like the *weissgulden*, excepting that the cobalt, by its decomposition, gives it a rosy appearance. There are two varieties; one of a dull tarnished surface and ferruginous look; the other has a shining appearance like the *leberertz*. It contains from 10 to 40 or 50 per cent. of silver. The arsenic is in an acid state, and united to the cobalt.

9. The *dal fablertz* contains silver mineralized with sulphurated copper and antimony, and resembles the dark-coloured *weissgulden*, giving a red powder when rubbed. It is found either solid or crystallized, and is met with in the province of Dal, where it is melted by a very difficult process, calculated to preserve the different metals it contains. There is another kind which has arsenic united to the rest of the ingredients. It is only the grey copper ore impregnated with silver, of which it contains from one to twelve per cent. the quantity of copper being from 12 to 24 per cent. and the remainder consisting either of sulphur or arsenic, with a little iron. It is the most common of all silver ores; and M. Monnet remarks, that where copper is united to arsenic, silver is always to be found. A variety has been found at Schemnitz, containing a portion of gold also.

10. The *pecheblende* is an ore of zinc containing silver, and is met with in the Saxon and Hunarian mines among the rich gold and silver ores. It is either of a metallic changeable colour or black. Of these there were formerly two varieties, viz. either in the form of fine scales or in balls, but the latter is now entirely unknown. A black blend is found in Bohemia, which is very heavy, with the surface somewhat elevated like some kinds of hamatites, but no silver has yet been extracted from it.

11. The *bleyglanz*, potters ore, or galena, contains silver mineralized with sulphurated lead. It is also called *pyritous silver*, and is of a brown colour, yielding but a very small portion of metal. It is met with at Kuns-

Silver.

Kron's Mineralogy.

*Silver.* berg in Norway. When the silver is combined with sulphurated lead and antimony, the ore is called *striperz*.

12. The *marcasite* containing silver has the metal united with sulphurated iron. There are great varieties of this ore holding different proportions of the metal; some produce only half an ounce of silver per cent. A liver-coloured marcasite is found at Kunsberg in Norway, containing from three to three ounces and a half of silver per cent.

13. Silver is found mineralized with sulphurated and arfenical cobalt; the stone sometimes containing *dendrites*. These kinds keep well in water, but generally decay in the air, and lose the silver they contain. It is found at Morgentern near Freyberg and Annaberg.

14. The *butter-milk ore* contains silver mineralized by sulphur, with regulus of antimony and barytes. It is found in the form of thin particles or granular spar. Wallerius says that it is soft like mud, and feels like butter. He suspects it to be produced from other silver ores washed away by running waters. Bomare adds, that the miners look upon it as a certain sign of other ores in the neighbourhood, though some are persuaded that it is only an unripened silver ore, which would soon become perfect.

15. The *combustible silver ore* is a black brittle substance, leaving about six per cent. of silver in its ashes. It is in fact a perfect coal in which silver is found.

16. The *bornertz*, or horn silver ore, in which the silver is united with the muriatic acid, is the scarcest of all the silver ores. It is sometimes found in snowy cubical crystals, but is met with of many different colours. Its principal characteristic is to change to a violaceous brownish colour when exposed to the sunbeams, as happens also to the artificial luna cornea. It is frequently crystallized in a cubic form, though not always of a white colour. Sometimes it resembles an earth easily fusible without smoke. There is a black kind, friable, and easily reducible to powder; the other is in some degree malleable, may be cut with a knife, and takes a sort of polish when rubbed. The vitreous silver ore, which is sometimes mixed with the horn silver, is soluble in nitrous acid; and this affords a method of separating them, the horn silver ore being insoluble in that menstruum. When the horn silver is free from iron, it generally contains 70 per cent. of silver at least; but these ores mostly contain some portion of iron, a small part of which is even united to the marine acid. This kind of ore was first analysed by Mr Woulfe, who discovered the presence of the vitriolic acid in it.

*Phil. Trans.* for 1776.

17. Another kind of horn silver ore is mentioned by Mr Bergman, in which the metal is mineralized by the vitriolic and marine acids, along with some sulphur. He doubts, however, whether the mineralization be perfect in this case, as the salt and sulphur do not admit of any other than a mechanical union. But since iron is often found in these ores, a marcasite may thus be sometimes formed.

18. The *silver goose dung ore* is of a greenish colour, with a mixture of yellow and red. Some think it is a mixture of red silver ore and calx of nickel.

19. The *foliaceus silver ore*. The colour of this ore is *mordoré*. Some imagine it to be a native silver ore; others that it is a mixture of galena, ochre, and silver. It is sometimes found in the mountain cork, and is fo

light that it will swim upon water. It contains but one ounce of silver per quintal.

*Silver.*

These are all the varieties hitherto observed in which silver is met with in the earth, though it may perhaps occur in various other forms. It would be worth while to examine whether, in those countries where gold and silver are found in large quantities, the precious metals may not be contained in some proportion in the most common ores, more especially when the particles of gold and silver have not been able to extricate themselves in such a manner as to lie separate in fissures, veins, or hollow places of the mine. A mineralization of silver with alkali is said to have been lately met with at Annaberg in Austria; but the account of it as yet can scarcely be depended upon. Professor Brunnich says, that the silver contained in the limestone at that place appears to be native when the stone is polished.

The purest silver is that which is extracted from luna cornea, and is the only kind that ought to be trusted in the nice operations of chemistry. The process, however, is very tedious, and presents a very unexpected phenomenon, as this metal, though one of the most fixed, is nevertheless volatilized in the operation in such a manner that it exhales through the pores of the crucible; and small globules of silver are afterwards found in the cover, and even in the support of the crucible. According to Cramer, this loss may be prevented by smearing the crucible with black soap, and mixing with the luna cornea half its weight of oil or tallow, which last must also be added by little and little during the operation.

M. Magellan takes notice of a remarkable appearance observable in dissolving silver in the nitrous acid. He observes, that this acid is its specific menstruum, attacking it even when cold with considerable effervescence, growing hot, and emitting a considerable quantity of orange-coloured fumes, which diminish in proportion as the saturation advances. The metal appears of a pale brown colour in the conflict, and the solution becomes quite black. This last appearance, however, is owing to a thin, black, fuliginous substance, like smut, which is at once formed into a crust on the surface of the thin plates of silver in the first attack of the acid upon them. This is a very singular phenomenon, and hitherto unaccounted for, these black crusts being committed into smaller and smaller particles by the action of the acid; and, when the effervescence is over, they are seen distinctly to fall to the bottom of the vessel, and to form a black sediment, leaving the liquid solution quite transparent, but of a blue colour inclining to green.— This colour might be attributed to some small mixture of copper, though the silver used in the experiment was of the purer kind. The chemists of Dijon say, that the nitrous solution of silver looks of a fine blue colour, if the acid be pure and well concentrated; but if it has any mixture of vitriolic or marine, a precipitation of vitriolated silver or luna cornea takes place. Afterwards the solution becomes as colourless as water, but gives a lathing black tinge to animal substances. This solution is of great use in chemistry, serving to form the lunar caustic, to purify the common aquafortis from a mixture of the vitriolic and marine acids, and is a very nice test of the existence of these acids in mineral waters.

Silver does not combine with earths, even by the most violent heat, though Mr Fourcroy supposes that its calx

Silver,  
Silvering.

might give an olive green to glass. Mr Magellan informs us, that its calx, precipitated by volatile alkali, gives a yellow colour to glass, and that he has seen it stained in this manner so high as almost to appear of a red colour. It unites with most metals, even with iron. The nature of this alloy has been but little inquired into, though Fourcroy is of opinion that it may probably be of the greatest utility in the arts. It combines in all proportions with copper, by which it is not deprived of its ductility, but renders it harder and more sonorous; by which means it is often used in bells. It is otherwise highly useful, on account of its indestructibility by fire and air, and its extreme ductility. Its fine colour renders it extremely proper for ornamental purposes, and it is applied like gold on the surface of different bodies, and even on copper. It likewise enters the texture of rich silks; but its most considerable use is that of being employed as money of an inferior value to gold. In this case, it is alloyed with one-twelfth part of copper. It is likewise often employed in making household utensils of all kinds, though its great price renders it less common than it would otherwise be for this purpose. For plate, it is usually alloyed with one twenty-fourth of copper, which gives it a greater degree of hardness and coherence, without rendering it in the least noxious.

Silver has also been used in medicine; but its extreme causticity, when dissolved in the nitrous acid, and its inactivity otherwise, have brought it into disuse. The crystals of silver have been recommended in very small quantity in dropsical cases; but they are by no means superior, or even equal in efficacy, to much safer medicines. The solution of silver, under the name of *Greek water*, has been used for the purpose of dying hair of a dark colour; and the same solution evaporated to a consistence, and fused, forms the lunar caustic of the shops.

*Shell SILVER*, is prepared of the shreds of silver leaf, or of the leaves themselves, for the use of painters, after the same manner as shell gold. See *Shell-Gold*.

**SILVERING**, the covering of any thing with silver. It is usual to silver metals, wood, paper, &c. which is performed either with fire, oil, or size. Metal-gilders silver by the fire; painter-gilders all the other ways. See **GILDING**.

To silver copper or brass. 1. Cleanse the metal with aquafortis, by washing it lightly, and immediately throwing it into pure water; or by heating it red-hot, and scouring it with salt and tartar and pure water with a small wire brush. 2. Dissolve some silver in aquafortis, in a broad-bottomed glass vessel, or of glazed earth; then evaporate away the aquafortis over a chaffing dish of coals. 3. Put five or six times its quantity of water, or as much as will be necessary to dissolve it perfectly, on the remaining dry calx; evaporate this water with the like heat; then put more fresh water, and evaporate again; and, if need be, the third time, making the fire towards the latter end so strong as to leave the calx perfectly dry, which, if your silver is good, will be of a pure white. 4. Take of this calx, common salt, crystal of tartar, of each a like quantity or bulk, and mixing well the whole composition, put the metal into pure water, and take of the said powder with your wet fingers, and rub it well on, till you find every little cavity of the metal sufficiently silvered over. 5. If you would have it richly done, you

must rub on more of the powder; and in the last place wash the silvered metal in pure water, and rub it hard with a dry cloth.

*SILVERING of Glasses*. See *FOLIATING of Looking-glasses*.

**SILURIS**, in ichthyology, a genus belonging to the order of pisces abdominales. The head is naked; the mouth set round with hairy filaments; the branchiæ have from 4 to 14 rays; the ray of the pectoral fins, or the first dorsal one, is prickly, and dentated backwards.—There are 21 species, most of them natives of the Indian and American seas. Mr Hasselquist mentions one called the *clarias* by Linnæus, and *sebilan* by the Arabians. If it pricks one with the bone of the breast-fin, it is dangerous; and our author saw the cook of a Swedish merchant ship die of the poison communicated by the prick of one of these fish. See **ELECTRICITY**, n° 261.

**SIMEON of DURHAM**, the cotemporary of William of Malmesbury, took great pains in collecting the monuments of our history, especially in the north of England, after they had been scattered by the Danes. From these he composed a history of the kings of England, from A. D. 616 to 1130; with some smaller historical pieces. Simeon both studied and taught the sciences, and particularly the mathematics at Oxford; and became precentor of the church at Durham, where he died, probably soon after the conclusion of his history, which was continued by John, prior of Hexham, to A. D. 1156.

**SIMIA**, the MONKEY, a genus of quadrupeds belonging to the class of mammalia, and order of primates, in the Linnæan system, but by Mr Pennant arranged under the digitated quadrupeds. According to the Linnæan system, the characteristics of this genus are these: There are four close set fore-teeth on each jaw; single tusks on each side in both jaws, which are longer than the rest, and somewhat remote from them. The grinders are obtuse, and the feet are formed like hands. Mr Pennant gives the following generic description of the simia. There are four cutting teeth in each jaw, and two canine. Each of the feet are formed like hands, generally with flat nails, and, except in one instance, have four fingers and a thumb. There are eyebrows both above and below.

They are a numerous race; but almost all confined to the torrid zone. They fill the woods of Africa from Senegal to the Cape, and from thence to Æthiopia. They are found in all parts of India, and its islands; in Cochin-China, in the south of China, and in Japan; (and one is met with in Arabia); and they swarm in the forests of South America, from the isthmus of Darien as far as Paraguay. They are lively, agile, full of frolic, chatter, and grimace. From the structure of their members, they have many actions in common with the human kind. Most of them are fierce and untameable; some are of a milder nature, and will show a degree of attachment; but in general they are endowed with mischievous intellects; and are filthy, obscene, lascivious, and thieving. They inhabit the woods, and live on trees; feeding on fruits, leaves, and insects. In general, they are gregarious, going in vast companies; but the different species never mix with each other, always keeping apart and in different quarters. They leap with vast activity from tree to tree, even

Silvering  
||  
Simia.

whena

when loaded with their young, which cling to them. They are the prey of leopards and others of the feline race; and of serpents, which pursue them to the summits of the trees, and swallow them entire. They are not carnivorous, but for mischief's sake will rob the nests of birds of the eggs and young. In the countries where they most abound, the sagacity of the feathered tribe is more marvelously shown in their contrivances to fix the nest beyond the reach of these invaders.

The simiæ being more numerous in their species than any other animals, and differing greatly in their appearances, it seemed necessary to methodize and subdivide the genus. Accordingly Mr Ray first distributed them into three classes.

*Simiæ*, Apes, such as wanted tails.

*Cercopitheci*, Monkeys, such as had tails.

*Papioes*, Baboons, those with short tails; to distinguish them from the common monkeys, which have very long ones.

The principal marks by which the species of this genus are distinguishable from each other, are derived, 1st, from the tail, which is either long, short, or altogether wanting, or is straight, or prehensile; 2dly, from the buttocks, which are naked, and furnished with callosities, or are covered with hair; 3dly, from the nails, which are flat and rounded like those of man, or sharp pointed like the claws of beasts in general; 4thly, from the presence or absence of a beard on the chin; and, 5thly, from the cheeks being provided with, or wanting, pouches in their under parts. For greater convenience, the species of this genus, which are very numerous, are arranged under five subordinate divisions, considered as distinct genera by some authors, and not without reason. Three of these subdivisions were adopted by Linnæus; but Dr Gmelin, following Buffon, has added other two taken from the third division of his great precursor. These subdivisions are the *simiæ*, *papioes*, *cercopitheci*, *sapaji*, and *sagoini*.

I. The *SIMIÆ*, or APES. They have no tails. The visage is flat; the teeth, hands, fingers, feet, toes, and nails, resemble those of man, and they walk naturally erect. This division includes the simiæ, or apes properly so called, which are not found in America.

1. The chimpanzee, the simia troglodytes of Linnæus, common in the mountains of Sierra Leona, resembles man more than the orang-outang. This animal was first brought to Europe in 1738, when it was exhibited as a show in London. The following description of one that was kept some months at the colony of Sierra Leona is given by Wadstrom, in his Essay on Colonization †. He was nearly two feet high; but the full stature is nearly five feet. He was covered with black hair, long and thick on the back, but short and thin on the breast and belly. His face was bare; his hands and his head resembled those of an old black man, except that the hair on his head was straight. He ate, drank, slept, and sat at table, like a human being. At first he crept on all fours, on the outside of his hands; but, when grown larger, he endeavoured to go erect, supporting himself by a stick. He was melancholy, but always good natured.

2. The satyrus, orang-outang, or great ape, has a flat face, and a deformed resemblance of the human; ears like those of a man; the hair on the head longer than on the body. The body and limbs are

covered with reddish and shaggy hair; longest on the back, thinnest on the fore-parts. The face and paws are swarthy; the buttocks covered with hair. They inhabit the interior parts of Africa, the isles of Sumatra, Borneo, and Java. Are solitary, and live in the most desert places. They grow to the height of six feet; have prodigious strength, and will overpower the strongest man. The old ones are shot with arrows, the young alone can be taken alive. They live entirely on fruits and nuts. They will attack and kill the negroes who wander in the woods; will drive away the elephants, and beat them with their fists or pieces of wood; and will throw stones at people that offend them. They sleep in trees; and make a sort of shelter from the inclemency of the weather. They are of a grave appearance and melancholy disposition, and even when young not inclined to frolic. They go erect, and are vastly swift and agile. These accounts are chiefly taken from Andrew Battel, an English sailor, who was taken prisoner 1589, and lived many years in the inner parts of Congo; his narrative is plain, and seems very authentic. It is preserved in Purchas's collection.

Froger \* informs us, "that those along the banks of the river Ganges are larger and more mischievous than in any part of Africa: the negroes dread them, and cannot travel alone in the country without running the hazard of being attacked by these animals, who often present them with a stick, and force them to fight. I have heard the Portuguese say, that they have often seen them hoist up young girls, about seven or eight years old, into trees, and that they could not be wrested from them without a great deal of difficulty. The most part of the negroes imagine them to be a foreign nation come to inhabit their country, and that they do not speak for fear of being compelled to work." When taken young, they are capable of being tamed, and taught to perform many menial offices. Francis Pyrard † relates, "that in the province of Sierra Leona, there is a species so strong limbed, and so industrious, that, when properly trained and fed, they work like servants; that they generally walk on the two hind feet; that they pound any substances in a mortar; that they go to bring water from the river in small pitchers, which they carry full on their heads. But when they arrive at the door, if the pitchers are not soon taken off, they allow them to fall; and when they perceive the pitchers overturned and broken, they weep and lament." Father Jarric ‡, quoted by Nieremberg, says the same thing, nearly in the same terms. With regard to the education of these animals, the testimony of Shoutten † accords with that of Pyrard. "They are taken (he remarks) with snares, taught to walk on their hind feet, and to use their fore feet as hands in performing different operations, as rinsing glasses, carrying drink round the company, turning a spit, &c." "I saw at Java (says Guat †) a very extraordinary ape. It was a female. She was very tall, and often walked erect on her hind feet. On these occasions, she concealed with her hands the parts which distinguish the sex. Except the eye-brows, there was no hair on her face, which pretty much resembled the grotesque female faces I saw among the Hottentots at the Cape. She made her bed very neatly every day, lay upon her side, and covered herself with the bed cloaths. When her head ached, she bound it up with a handkerchief; and it was amusing to see

Si 1.

§ Descrip.  
Historique  
du Royaume  
de Macassar,  
p. 51.

† Voyage de  
François  
Pyrard,  
tom. ii.  
p. 331.

¶ Euf.  
Nieremberg,  
ac. Hist. Nat.  
Peregrin.,  
lib. ix.  
cap. 45.  
§ Voyages  
de Guat.  
aux Indes  
Orientales.  
† Voyage de  
Fr. le Guat,  
tom. ii.  
p. 96.

Simia.

her thus hooded in bed. I could relate many other little articles which appeared to me extremely singular. But I admired them not so much as the multitude; because, as I knew the design of bringing her to Europe to be exhibited as a show, I was inclined to think that she had been taught many of these monkey tricks, which the people considered as being natural to the animal — She died in our ship, about the latitude of the Cape of Good Hope. The figure of this ape had a very great resemblance to that of man, &c.” Gmelin Carreri tells us, that he saw one of these apes, which cried like an infant, walked upon its hind-feet, and carried a matt under its arm to lie down and sleep upon

Buffon's  
Nat. Hist  
by Smellie,  
vol. viii  
p. 86.

An orang-outang which Buffon saw, is described by him as mild, affectionate, and good-natured. His air was melancholy, his gait grave, his movements measured, his dispositions gentle, and very different from those of other apes. He had neither the impatience of the Barbary ape, the maliciousness of the baboon, nor the extravagance of the monkeys. “It may be alleged, (says our author), that he had the benefit of instruction; but the other apes which I shall compare with him, were educated in the same manner. Signs and words were alone sufficient to make our orang-outang act; but the baboon required a cudgel, and the other apes a whip; for none of them would obey without blows. I have seen this animal present his hand to conduct the people who came to visit him, and walk as gravely along with them as if he had formed a part of the company. I have seen him sit down at table, unfold his towel, wipe his lips, use a spoon or a fork to carry the victuals to his mouth, pour his liquor into a glass, and make it touch that of the person who drank along with him. When invited to take tea, he brought a cup and a saucer, placed them on the table, put in sugar, poured out the tea, and allowed it to cool before he drank it. All these actions he performed without any other instigation than the signs or verbal orders of his master, and often of his own accord. He did no injury to any person: he even approached company with circumspection, and presented himself as if he wanted to be caressed. He was very fond of dainties, which every body gave him: And as his breast was diseased, and he was afflicted with a teasing cough, this quantity of sweetmeats undoubtedly contributed to shorten his life. He lived one summer in Paris, and died in London the following winter. He eat almost every thing; but preferred ripe and dried fruits to all other kinds of food. He drank a little wine; but spontaneously left it for milk, tea, or other mild liquors.” This was only two feet four inches high, and was a young one. There is great possibility that these animals may vary in size and in colour, some being covered with black, others with reddish hairs.— They are not the satyrs of the ancients; which had tails (A), and were a species of monkey. Linnæus's

*homo nocturnus*, an animal of this kind, is unnecessarily separated from his *simia satyrus*.

To enable the reader to form a judgment of this animal, which has so great a resemblance to man, it may not be unacceptable to quote from Buffon the differences and conformities which make him approach or recede from the human species. “He differs from man externally by the flatness of his nose, by the shortness of his front, and by his chin, which is not elevated at the base. His ears are proportionally too large, his eyes too near each other, and the distance between his nose and mouth is too great. There are the only differences between the face of an orang-outang and that of a man. With regard to the body and members, the thighs are proportionally too short, the arms too long, the fingers too small, the palm of the hands too long and narrow, and the feet rather resemble hands than the human foot. The male organs of generation differ not from those of man, except that the prepuce has no frænum. The female organs are extremely similar to those of a woman.

“The orang-outang differs internally from the human species in the number of ribs: man has only 12, but the orang-outang has 13. The vertebræ of the neck are also shorter, the bones of the pelvis narrow, the buttocks flatter, and the orbits of the eyes sunk deeper. He has no spinal process on the first vertebra of the neck. The kidneys are rounder than those of man, and the ureters have a different figure, as well as the bladder and gall-bladder, which are narrower and longer than in the human species. All the other parts of the body, head, and members, both external and internal, so perfectly resemble those of man, that we cannot make the comparison without being astonished that such a similarity in structure and organization should not produce the same effects. The tongue, and all the organs of speech, for example, are the same as in man; and yet the orang-outang enjoys not the faculty of speaking; the brain has the same figure and proportions; and yet he possesses not the power of thinking. Can there be a more evident proof than is exhibited in the orang-outang, that matter alone, though perfectly organized, can produce neither language nor thought, unless it be animated by a superior principle? Man and the orang-outang are the only animals who have buttocks and the calf of the legs, and who, of course, are formed for walking erect; the only animals who have a broad chest, flat shoulders, and vertebræ of the same structure; and the only animals whose brain, heart, lungs, liver, spleen, stomach, and intestines, are perfectly similar, and who have an appendix vermiformis, or blind-gut. In fine, the orang-outang has a greater resemblance to man than even to the baboons or monkeys, not only in all the parts we have mentioned, but in the largeness of the face, the figure of the cranium, of the jaws, of the teeth, and of the other bones of the head and

(A) Ælian gives them tails, *lib. xvi. c. 21*. Pliny says they have teeth like dogs, *lib. vii. c. 2*. circumstances common to many monkeys. *Ptolemy, lib. 7. c. 2*. speaks of certain islands in the Indian ocean inhabited by people with tails like those with which satyrs are painted, whence called the *isles of satyrs*. Kœeping, a Swede, pretended to have discovered these *homines caudati*; that they would have trafficked with him, offering him live parrots; that afterwards they killed some of the crew that went on shore, and eat them, &c. &c. *Aman, Acad. vi. 71*.

and face; in the thickness of the fingers and thumb, the figure of the nails, and the number of vertebrae; and, lastly, in the conformity of the articulations, the magnitude and figure of the rotula, sternum, &c. Hence, as there is a greater similarity between this animal and man, than between those creatures which resemble him most, as the Barbary ape, the baboon, and monkey, who have all been designed by the general name of *apes*, the Indians are to be excused for associating him with the human species, under the denomination of *orang-outang*, or *wild man*. In fine, if there were a scale by which we could descend from human nature to that of the brutes, and if the essence of this nature consisted entirely in the form of the body, and depended on its organization, the orang-outang would approach nearer to man than any other animal. Placed in the second rank of beings, he would make the other animals feel his superiority, and oblige them to obey him. If the principle of imitation, by which he seems to mimic human actions, were a result of thought, this ape would be still farther removed from the brutes, and have a greater affinity to man. But the interval which separates them is immense. Mind, reflection, and language, depend not on figure or the organization of the body. These are endowments peculiar to man. The orang-outang, though, as we have seen, he has a body, members, senses, a brain, and a tongue, perfectly similar to those of man, neither speaks nor thinks. Though he counterfeits every human movement, he performs no action that is characteristic of man, no action that has the same principle or the same design. With regard to imitation, which appears to be the most striking character of the ape kind, and which the vulgar have attributed to him as a peculiar talent, before we decide, it is necessary to inquire whether this imitation be spontaneous or forced. Does the ape imitate us from inclination, or because, without any exertion of the will, he feels the capacity of doing it? I appeal to all those who have examined this animal without prejudice; and I am convinced that they will agree with me, that there is nothing voluntary in this imitation. The ape, having arms and hands, uses them as we do, but without thinking of us. The similarity of his members and organs necessarily produces movements, and sometimes successions of movements, which resemble ours. Being endowed with the human structure, the ape must move like man; but the same motions imply not that he acts from imitation. Two bodies which receive the same impulse, two similar pendulums or machines, will move in the same manner; but these bodies or machines can never be said to imitate each other in their motions. The ape and the human body are two machines similarly constructed, and necessarily move nearly in the same manner; but parity is not imitation. The one depends on matter, and the other on mind. Imitation presupposes the design of imitating. The ape is incapable of forming this design, which requires a train of thinking; consequently man, if he inclines, can imitate the ape; but the ape cannot even incline to imitate man."

Fig. 2. 3. Pongo, or Jocko, are considered as one species by Pennant and Gmelin. It inhabits the island of Java, and the interior parts of Guinea. Has no pouches within his cheeks, no tail, and no callosities on the buttocks; which last are plump and fleshy. All the teeth are similar to those of man. The face is flat, naked, and tawny; the ears, hands, feet, breast, and belly, are

likewise naked; the hair of the head descends on both temples in the form of tresses; the hair on the back and loins is in small quantities. It is five or six feet high, and walks always erect on the two hind feet. It has not been ascertained whether the females, of this species or variety, are subject to periodical discharges; but analogy renders this almost unquestionable. This animal is, by Dr Gmelin, considered only as a variety of the orang-outang.

4. The great gibbon, long-armed ape, or simia lar, Fig. 3. with a flat swarthy face surrounded with grey hairs; hair on the body black and rough; buttocks bare; nails on the hands flat; on the feet long; arms of a most disproportioned length, reaching quite to the ground when the animal is erect, its natural posture; of a hideous deformity.—Inhabits India, Malacca, and the Molucca isles; a mild and gentle animal; grows to the height of four feet. The great black ape of Mangsi, a province in China, seems to be of this kind.

5. The lesser gibbon, or simia lar minor, but is much less, being only about a foot and a half high; the body and face are of a brown colour, resembles the former. The simia lar argentea is probably a variety of this species.

6. The pigmy, or simia silvanus, has no tail; the buttocks are naked; the head roundish, and the arms shorter than the body. It inhabits Africa; and is not uncommon in our exhibitions of animals; is very tractable and good-natured, and was most probably the pigmy of the ancients. It abounds in Æthiopia, one seat of that imaginary nation; was believed to dwell near the fountains of the Nile, whence it descended annually to make war on the cranes, *i. e.* to steal their eggs, which the birds may be supposed naturally to defend; whence the fiction of their combats.

7. The magot, simia inuas, or Barbary ape, has a long face, not unlike that of a dog; canine teeth, long and strong; ears like the human; nails flat; buttocks bare; colour of the upper part of the body a dirty greenish brown; belly, of a dull pale yellow; grows to above the length of four feet.—They inhabit many parts of India, Arabia, and all parts of Africa except Egypt, where none of this genus are found. A few are found on the hill of Gibraltar, which breed there; probably from a pair that had escaped from the town; as they are not found in any other part of Spain.—They are very ill-natured, mischievous, and fierce; agreeing with the character of the ancient Cynocephali. They are a very common kind in exhibitions. By force of discipline they are made to play some tricks; otherwise they are more dull and sullen than the rest of this genus. They assemble in great troops in the open fields in India, and will attack women going to market, and take their provisions from them. The females carry the young in their arms, and will leap from tree to tree with them. Apes were worshipped in India, and had magnificent temples erected to them. When the Portuguese plundered one in Ceylon, they found in a little golden casket the tooth of an ape; a relic held by the natives in such veneration, that they offered 700,000 ducats to redeem it, but in vain; for it was burnt by the victor, to stop the progress of idolatry.

II. PAPIONS, or BABOONS. These have short tails, a long face; a broad high muzzle; longish dog-like tusks, or canine teeth; and naked callosities on the buttocks. They are only found in the old world, and are the papions and *Rudrapas* of the ancients.

8. The maimon, simia papio nemestrina, or pig-tailed baboon, Plate OCCIDENT. Fig. 8.

Simia.

baboon, with a pointed face, which is naked, of a swarthy redness; two sharp canine teeth; ears like the human; hair on the limbs and body brown inclining to ash-colour, palest on the belly; fingers black; nails long and flat; thumbs on the hind-feet very long, connected to the nearest toe by a broad membrane; tail four inches long, slender, exactly like a pig's, and almost naked; the bare spaces on the rump red, and but small: length, from head to tail, 22 inches. Inhabits the isles of Sumatra and Japan; is very docile. In Japan it is taught several tricks, and carried about the country by mountebanks. Kempfer was informed by one of these people, that the baboon he had was 102 years old.

Fig. 9.

9. The great baboon, or *simia papio sphinx*, with hazel irides; ears small and naked; face canine, and very thick; middle of the face and fore-head naked; and of a bright vermilion colour; tip of the nose of the same, and ending truncated like that of a hog; sides of the nose broadly ribbed, and of a fine violet hue; the opening of the mouth very small; cheeks, throat, and goat-like beard yellow; hair on the fore-head very long, turns back, is black, and forms a kind of pointed crest. Head, arms, and legs, covered with short hair, yellow and black intermixed; the breast with long whitish yellow hairs, the shoulders with long brown hair. Nails flat; feet and hands black; tail four inches long, and very hairy; buttocks bare, red, and filthy; but the space about them is of a most elegant purple colour, which reaches to the inside of the upper part of the thighs.

Pennant's  
Quadrupeds,  
vol. i.  
p. 172.

This was described by Mr Pennant from a stuffed specimen in Sir Ashton Lever's museum. In August 1779, a live animal of this species was shown at Edinburgh, and in October following at Chester, where being seen by Mr Pennant, that inquisitive naturalist has described it in his *History of Quadrupeds*. "It differed little (he observes) in colour from the above, being in general much darker. Eyes much sunk in the head, and small. On the internal side of each ear was a white line, pointing upwards. The hair on the fore-head turned up a like a toupee. Feet black; in other respects resembled the former. In this I had an opportunity of examining the teeth. The cutting teeth were like those of the rest of the genus; but, in the upper and lower jaw, were two canine, or rather tusks, near three inches long, and exceedingly sharp and pointed. This animal was five feet high, of a most tremendous strength in all its parts; was excessively fierce, libidinous, and strong."

Mr Schreber says, that this species lives on succulent fruits, and on nuts; is very fond of eggs, and will put eight at once into its pouches, and, taking them out one by one, break them at the end, and swallow the yolk and white; rejects all flesh-meat, unless it be dressed; would drink quantities of wine or brandy; was less agile than other baboons; very cleanly; for it would immediately sing its excrements out of its hut. That which was shown at Chester was particularly fond of cheese. Its voice was a kind of roar, not unlike that of a lion, but low and somewhat inward. It went upon all fours, and never stood on its hind legs, unless forced by the keeper; but would frequently sit on its rump in a crouching manner, and drop its arms before the belly. Inhabits the hotter parts of Africa.

Fig. 10.

10. The little baboon, or *simia papio apedia*, has a roundish head, with a projecting muzzle, and roundish

naked ears; the hair on the body is yellow, tipped with black; the face is brown, and almost naked, having only a few scattered hairs; the nails are all compressed and oblong, except on the thumbs and great toes, the nails of which resemble man; the tail is very short, being hardly an inch long; the body is about the size of a cat. It is uncertain, says Gmelin, if this animal should be considered as a distinct species, or only as a variety of the *simia sciurea*.

11. The mantegar, or *simia papio mermon*, common-ly called the *tuffed ape*, but it is improperly named an *ape*, as it has a tail. It is described in the abridgment of the *Philosophical Transactions*, n<sup>o</sup> 290. It had a nose and head 14 inches in length; the nose of a deep red, face blue, both naked; black eye-brows; ears like the human; on the top of the head a long upright tuft of hair; on the chin another; two long tusks in the upper jaw; fore feet exactly resembling hands, and the nails on the fingers flat; the fore-part of the body, and the inside of the legs and arms, naked; the outside covered with mottled brown and olive hair. Length, from the nose to the rump, three feet two inches. It was very fierce and falacious; went on all fours, but would sit up on its rump, and support itself with a stick; in this attitude, it would hold a cup in its hand, and drink out of it. Its food was fruits.

12. The mandril, *simia papio maimon*, or ribbed nose baboon, has a short tail, and a thin beard on the chin; the cheeks are blue and striped, and the buttocks are naked. This species of baboon is found on the Gold Coast, and in the other southern provinces of Africa, where he is called *boggo* by the negroes, and *mandril* by the Europeans. Next to the orang-outang, he is the largest of all the apes or baboons. Smith relates, that he had a present of a female mandril, which was only six months old, and that it was as large as an adult baboon. He adds, that these mandrils walk always on two feet; that they weep and groan like men; that they have a violent passion for women, which they never fail to gratify when they find a woman at a distance from relief. We have given figures both of the male and female, which may be easily distinguished by their size and appearance.

13. The wood-baboon, or *simia papio sylvatica*, with a long dog-like face, covered with a small glossy black skin; hands and feet naked, and black like the face; hair on all parts long, elegantly mottled with black and tawny; nails white; about three feet high when erect; tail not three inches, and very hairy on the upper top. Inhabits Guinea, where it is called by the English the *man of the wood*.

14. The brown baboon, or *simia papio platygygos*, with pointed ears; face of a dirty white; nose large and broad; hairs round the face short and straight; colour of the upper part of the body brown; of the under, ash-colour: tail about four inches long; taper, and almost bare of hair; beneath is quite naked. The animal which Mr Pennant called the *new baboon*, in the first edition, seems by the taperness of the tail, and general form, to be of this kind.

15. The hoggish baboon, or *simia papio porcaria*, has a short tail, and coloured buttocks; the head is like that of a hog, with a naked snout; the body is of an olive brown colour; the nails are sharp and compressed. Inhabits Africa, and is about three feet and a half high when



15. when standing erect. This, in all probability, is the same animal with the hog-faced ape, adopted from Pennant.

16. III. MONKEYS, CERCOPITHECI, have long tails, which are not prehensile; the under parts of their cheeks are furnished with pouches, in which they can keep their victuals; the partition between the nostrils is thin, and the apertures are, like those of man, placed in the under part of the nose; the buttocks are naked, and provided with callosities. These animals, which are never found native in America, are the cercopithecii, and *Kubora*, of the ancients.

16. The Tartarin, dog faced baboon of Pennant, and cercopithecus hamadryas of Gmelin, with a long, thick, and strong nose, covered with a smooth red skin; ears pointed, and hid in the hair; head great, and flat; hair on the head, and fore-part of the body as far as the waist, very long and shaggy; grey and olive-brinded; the sides of the head very full, the hair on the limbs and hind part of the body very short; limbs strong and thick; hands and feet dusky; the nails on the fore-feet flat; those on the hind like a dog's; buttocks very bare, and covered with a skin of a bloody colour; tail scarce the length of the body, and carried generally erect. They inhabit the hottest parts of Africa and Asia; where they keep in vast troops, and are very fierce and dangerous. They rob gardens. They will run up trees when passengers go by, shake the boughs at them with great fury, and chatter very loud. They are excessively impudent, indecent, lascivious; most detestable animals in their manners as well as appearance. They range the woods in hundreds; which obliges the owners of the coffee-plantations to be continually on their guard against their depredations. One of them was shown in London some years ago: it came from Mokha, in the province of Yeman, in Arabia Felix in the Persian gulph; and was above five feet high. It was very fierce and untameable; so strong as easily to master its keeper, a stout young man. Its inclinations to women appeared in the most violent manner. A footman, who brought a girl to see it, in order to tease the animal, kissed and hugged her: the beast, enraged at being so tantalized, caught hold of a quart pewter-pot, which he threw with such force and so sure an aim, that, had not the man's hat and wig softened the blow, his skull must have been fractured; but he fortunately escaped with a common broken head.

16. 17. The white-bearded black wandern, the simia filenus of Linnæus, the ouanderou of Buffon, and lion-tailed baboon of Pennant, the cercopithecus filenus albibarbatu of Gmelin, has a dog-like face, is naked, and of a dusky colour; a very large and full white or hoary beard; large canine teeth; body covered with black hair; belly of a light colour; tail terminated with a tuft of hair like that of a lion. Its bulk that of a middle-sized dog. It inhabits the East Indies and the hotter parts of Africa.

18. The purple-faced monkey, or cercopithecus filenus purpuratus, with a great triangular white beard, short and pointed at the bottom, and on each side of the ears, extending a winged fashion far beyond them; face and hands purple, body black. Inhabit Ceylon. They are very harmless; live in the woods, and feed on leaves and buds of trees; and when taken soon become tame.

VOL. XVII. Part II.

19. Malbrouk, or cercopithecus faunus, has a long tail, and is bearded: the tail is bushy at the extremity. It is a native of Bengal. This species has cheek-pouches, and callosities on the buttocks; the tail's nearly as long as the body and head; and it is a mistake of Clusius that it terminates in a tuft; the face is of a cinereous grey colour, with a large muzzle, and large eyes, which have flesh-coloured eyelids, and a grey band crosses the forehead in the place of eye-brows; the ears are large, thin, and flesh-coloured; the upper parts of the body are of a uniform yellowish brown colour, and the lower of a yellowish grey: It walks on all fours, and is about a foot and a half from the muzzle to the extremity of the tail. The females menstruate.

Simia.

20. Macaque, or cercopithecus cynomologus, the hare-lipped monkey of Pennant, has no beard; the nostrils are thick and divided; the tail is long and arched, and the buttocks are naked. He has cheek-pouches and callosities on the buttocks. His tail is from 18 to 20 inches long. His head is large, his muzzle very thick, and his face naked, livid, and wrinkled. His ears are covered with hair. His body is short and square, and his limbs thick and short. The hair on the superior parts of his body is of a greenish ash-colour, and of a yellowish grey on the breast and belly. He has a small crest of hair on the top of the head. He walks on four and sometimes on two feet. The length of his body, comprehending that of the head, is about 18 or 20 inches.

Fig. 17.

21. The dog-headed monkey, or cercopithecus cynocephalus, has no beard, and is of a yellow colour; the muzzle is long; the tail long and straight, and the buttocks naked. It is a native of Africa.

Fig. 18.

22. The spotted monkey, or cercopithecus Diana, with a long white beard: colour of the upper parts of the body reddish, as if they had been singed, marked with white specks; the belly and chin whitish; tail very long; is a species of a middle size. It inhabits Guinea and Congo, according to Maregrave; the Congese call it *exquima*. M. de Buffon denies it to be of that country; but from the circumstance of the curl in its tail, in Maregrave's figure, and the description of some voyagers, he supposes it to be a native of South America. Linnæus describes his *S. Diana* somewhat differently: he says it is of the size of a large cat; black, spotted with white; hind part of the back ferruginous; face black; from the top of the nose is a white line passing over each eye to the ears, in an arched form; beard pointed, black above, white beneath, placed on a fatty excrescence; breast and throat white; from the rump, cross the thighs, a white line; tail long, straight, and black; ears and feet of the same colour; canine teeth, large.

23. The green monkey, or cercopithecus sabæus, has a black and flattish face: the side of it bounded by long white hairs, falling backwards, and almost covering the ears, which are black, and like the human: head, limbs, and whole upper part of the body and tail covered with soft hair, of a yellowish green colour at their ends, cinereous at their roots: under side of the body and tail, and inner side of the limbs, of a silvery colour: tail very long and slender. Size of a small cat. Inhabit different parts of Africa: keep in great flocks, and live in the woods: are scarce discernible when among the leaves, except by their breaking the boughs with their

Fig. 19.

Simia.

gambols: in which they are very agile and silent: even when shot at, do not make the least noise: but will unite in company, knit their brows, and gnash their teeth, as if they meant to attack the enemy: are very common in the Cape de Verd islands.

24. The maulache, or cercopithecus cephus, has a beard on the cheeks; the crown of the head is yellowish: the feet are black, and the tip of the tail is of an ash colour. Its tail is much longer than the body and head, being 19 or 20 inches in length. The female incisorless.

Fig. 20.

25. The mangabey, cercopithecus aethiops, or white-eyed monkey, has a long, black, naked, and dog-like face: the upper eye-lids of a pure white: ears black, and like the human: no canine teeth: hairs on the sides of the face beneath the cheeks, longer than the rest: tail long: colour of the whole body tawny and black: flat nails on the thumbs and fore-fingers; blunt claws on the others: hands and feet black — Shown in London some years ago: place uncertain: that described by M. de Buffon came from Madagascar; was very good-natured; went on all-fours.

Fig. 21.

26. The egret, or cercopithecus aygula, has a long face, and an upright sharp-pointed tuft of hair on the top of the head. The hair on the forehead is black: the tuft, and the upper part of the body light-grey; the belly white: the eye-brows are large; the beard very small. Size of a small cat. They inhabit Java. They fawn on men, on their own species, and embrace each other. They play with dogs, if they have none of their own species with them. If they see a monkey of another kind, they greet him with a thousand grimaces. When a number of them sleep, they put their heads together. They make a continual noise during night.

27. The rillow, cercopithecus finicus, or Chinese bonnet, has a long smooth nose, of a whitish colour; hair on the crown of the head long, lying flat, and parted like that of a man; colour, a pale cinereous brown, Inhabit Ceylon. They keep in great troops; and rob gardens of their fruit, and fields of their corn; to prevent which, the natives are obliged to watch the whole day: yet these animals are so bold, that, when driven from one end of the field, they will immediately enter at the other and carry off with them as much as their mouth and arms can hold. Bosman, speaking of the thefts of the monkeys of Guinea, says, that they will take in each paw one or two stalks of millet, as many under their arms, and two or three in their mouth; and thus laden, hop away on their hind-legs: but, if pursued, they sling away all, except what is in their mouths, that it may not impede their flight. They are very nice in the choice of the millet; examine every stalk; and if they do not like it, sling it away: so that this delicacy does more harm to the fields than their thievery.

Ker's Translation of Gmelin's Linnaeus.

28. The tawny monkey, or cercopithecus fulvus, has long tusks in the lower jaw: the visage is long and flesh coloured, with flesh coloured ears, and a flattish nose. Inhabits India. This is a very ill natured animal,

about the size of a cat; it was lately in the possession of Mr Brook, an animal merchant and exhibitor in London: The upper parts of the body are covered with a pale tawny coloured fur, which is ash coloured at the roots; the hinder part of the back is orange coloured, the legs ash coloured, the belly white, and the tail shorter than the body.

29. King monkey, full-bottom monkey, or cercopithecus regalis, has no thumb on the hands; the head, cheeks, throat, and shoulders, are covered with long, flowing, coarse hairs. Inhabits the forests of Sierra Leona in Guinea, where it is called *bey*, or *king monkey*. It is above three feet high when erect: The head is small, with a short, black, naked face; and the head, cheeks, throat, neck, and shoulders, are covered with long, coarse, flowing hairs, of a dirty yellowish colour, mixed with black, and resembling a full-bottomed wig; the body, arms, and legs, are covered with short hairs of a fine glossy black colour; the hands are naked, and have no thumbs; the feet have five very long slender toes, which are armed with narrow pointed claws; the tail is very long, and is covered with snow white hairs, having a tuft at the end; the body and limbs are very slender: Its skin is held in high estimation by the negroes for making pouches and gun cases.

IV. SAPAJOUS, SAPAJI, have prehensile tails, and no cheek-pouches. These animals have long tails, which, at the extremity, is generally deprived of hair on the under side, and covered with a smooth skin; this part they can fold, extend, curl up, and unfold at pleasure; by which they are enabled to hang upon branches, or to lay hold of any thing which is beyond the reach of their hands, using the extremity of the tail like a finger or hand; the partition between the nostrils is very thick, and the apertures are situated on the sides of the nose; the buttocks are clothed with hair, and have no callosities; the females of this subgenus do not menstruate; and this race of animals is only to be found in America: This subdivision of the genus is made with great propriety by Dr Gmelin, in imitation of the Count de Buffon.

30. The guariba, sapajus Beelzebub, or the preacher monkey, has black shining eyes; short round ears; and a round beard under the chin and throat. The hairs on the body are of a shining black, long, yet lie so close on each other that the animal appears quite smooth: the feet and end of the tail are brown; the tail very long, and always twisted at the end. Size of a fox. Inhabit the woods of Brazil and Guiana in vast numbers, and make a most dreadful howling. Sometimes one mounts on a higher branch, the rest seat themselves beneath: the first begins as if it was to harangue, and sets up so loud and sharp a howl as may be heard a vast way, and a person at a distance would think that a hundred joined in the cry: after a certain space, he gives a signal with his hand, when the whole assembly joins in chorus; but on another signal is silent, and the orator finishes his address (B). Their clamour is the most disagreeable and tremendous that can be conceived; owing to a hollow and hard bone placed in the throat, which

(B) A singular account, yet related by Marcgrave and several other writers. Marcgrave is a writer of the first authority, and a most able naturalist, long resident in the Brasils, and speaks from his own knowledge.

which the English call the *throat-bone*. These monkeys are very fierce, untamable, and bite dreadfully. There is a variety of a ferruginous or reddish bay colour, which the Indians call the *king of the monkeys*: it is large, and as noisy as the former. The natives eat this species, as well as several other sorts of monkeys, but are particularly fond of this. Europeans will also eat it, especially in those parts of America where food is scarce: when it is scalded in order to get off the hair, it looks very white; and has a resemblance shocking to humanity, that of a child of two or three years old when crying (c).

31. The quato, *sapajus paniscus*, or four-fingered monkey, has a long flat face, of a swarthy flesh colour: the eyes are sunk in the head; ears like the human; limbs of a great length, and uncommonly slender: the hair is black, long, and rough. There are only four fingers on the hands, being quite destitute of a thumb; five toes on the feet. The tail is long; and naked below, near the end. The body is slender; about a foot and a half long; the tail near two feet, and so prehensile as to serve every purpose of a hand. They inhabit the neighbourhood of Carthagena, Guiana, Brasil, and Peru; associate in vast herds; and are scarce ever seen on the ground. Dampier describes their gambols in a lively manner: "There was (says he) a great company dancing from tree to tree over my head, chattering, and making a terrible noise and a great many grim faces and antic gestures; some broke down dry sticks and flung them at me, others scattered their urine and dung about my ears: at last one bigger than the rest came to a small limb just over my head, and leaping directly at me, made me leap back; but the monkey caught hold of the bough with the tip of its tail, and there continued swinging to and fro, making mouths at me. The females with their young ones are much troubled to leap after the males; for they have commonly two, one she carries under her arm, the other sits on her back, and claps its two fore-paws about her neck: are very fullen when taken; and very hard to be got when shot, for they will cling with their tail or feet to a bough as long as any life remains. When I have shot at one, and broke a leg or arm, I have pitied the poor creature to see it look and handle the broken limb, and turn it from side to side."—They are the most active of monkeys, and quite enliven the forests of America. In order to pass from top to top of lofty trees, whose branches are too distant for a leap, they will form a chain, by hanging down, linked to each other by their tails, and swinging in that manner till the lowest catches hold of a bough of the next tree, and draws up the rest; and sometimes they pass rivers by the same expedient. They are sometimes brought to Europe; but are very tender, and seldom live long in our climate.

32. The sai, *sapajus capucinus*, or weeper, with a round and flat face, of a reddish brown colour, very deformed: the hair on the head and upper part of the body black, tinged with brown; beneath and on the

limbs tinged with red: tail black, and much longer than the head and body: the young excessively deformed: their hair very long, and thinly dispersed.—In the Parisian Museum are specimens of old and young. M. de Buffon has a variety with a white throat. Inhabits Guiana and Brasil: appear as if it was always melancholy; of a melancholy disposition; but very turbulent: eating what it sees done. These probably the monkeys Dampier saw in the Bay of All Saints: they are very ugly, and smell strongly of musk. They keep in large companies; and make a great chattering, especially in stormy weather; reside much on a species of tree which bears a podded fruit, which they feed on.

33. *Sapajus fatuellas*, or horned sapajou, has two tufts of hair on the head, resembling little horns: Is beardless. Inhabits South America. The face, sides, belly, and fore-parts of the thighs are brown; the top of the head, middle of the back, tail, legs, and posterior parts of the thighs, are black; the nails are long and rather blunt; the tail is prehensile and twisted spirally. Perhaps of the same species with the *simia apella* or *capuchin* (Gm.). This, in all probability, is one of the factitious species, purposely deformed, by exhibitors of wild beasts, to impose on the public.

34. *Saimiri, sapajus sciureus*, or orange monkey, has no beard; the hinder part of the head is prominent; and the nails on the four toes of the hind paws are narrow and pointed. It inhabits South America, and is the most beautiful of all the sapajous; its movements are graceful; its size small; its colour a brilliant yellow; its visage round, with large vivacious eyes, surrounded by flesh-coloured rings; it has hardly any forehead; the nose is elevated at the base, and flattened at the point: the mouth is small, the face flat and naked, and the ears are garnished with hair, and a little pointed; the tail is only half prehensile: It stands with ease on two feet, but commonly walks on all four.

V. SAGOINS, SAGOINI. These have long tails, which are proportionally longer than those of the *sapajous*, straight, flaccid, entirely covered with hair, and not prehensile; that is, incapable of laying hold of any object: the cheeks have no pouches; and the buttocks, which are covered with hair, have no callosities: the partition between the nostrils is very thick, and the apertures are placed on the sides of the nose. The females do not menstruate. This race of animals is only found in America.

35. The faki, *sagoinus pithecia*, or fox-tailed monkey, with a swarthy face, covered with short white down: forehead and sides of the face with whitish, and pretty long hair: body with long dusky brown hairs; white or yellowish at their tips: hair on the tail very long and bushy; sometimes black, sometimes reddish: belly and lower part of the limbs a reddish white: length from nose to tail near a foot and a half: tail longer, and like that of a fox: hands and feet black, with claws instead of nails. Inhabits Guiana.

36. The sanglin, *sagoinus iacchus*, or striated monkey, Fig. 26.

3 R 2

(c) *Ulloa's Voy.* I. 113. *Des Marchais*, III. 311. says, they are excellent eating, and that a *soupe aux fruges* will be found as good as any other, as soon as you have conquered the aversion to the *bouilli* of their heads, which look very like those of little children.

*Simia.* key, with a very round head : about the ears two very long full tufts of white hairs standing out on each side : irides reddish : face a swarthy flesh colour : ears like the human : head black : body ash coloured, reddish, and dusky ; the last forms striated bars cross the body : tail full of hair, annulated with ash colour and black : body seven inches long ; tail near eleven : hands and feet covered with short hairs : fingers like those of a squirrel : nails, or rather claws, sharp. Inhabits Brasil : feeds on vegetables ; will also eat fish : makes a weak noise : very restless : often brought over to Europe.

Fig. 27. 37. Pinclie, *sagoinus œdipus*, or red-tailed monkey, is beardless ; has a flowing head of hair, which hangs down on each side ; a red tail and sharp claws. It has neither cheek-pouches nor callosities on the buttocks. His tail is not prehensile, and is more than twice the length of the head and body. The partition of the nostrils is thick, and the apertures are placed at a side. The face, throat, and ears are black ; on the head are long white hairs. The muzzle is broad, and the face round. The hair on the body is pretty long ; of a yellowish brown or reddish colour till near the tail, where it becomes orange ; on the breast, belly, hands, and feet, it is white, and shorter than on the body. The tail, from the origin to one-half of its length, is a vivid red, then brownish red, and toward the point it is black. He is about nine inches in length, and walks on four feet. The females are not subject to the menstrual evacuation.

Fig. 28. 38. The merikina, *sagoinus rosalius*, or silky monkey, is beardless ; has a very hairy head : the circumference of the face and the feet are red ; and the claws are sharp and narrow. It inhabits South America. A brisk animal, less impatient of cold than the rest of this race : the body is of a yellowish white colour ; the nails on the thumbs and great toes are rounded ; the ears are naked, but are hidden beneath the fur : It has a round head, and a brown face, which is surrounded with a kind of mane of a bright red colour ; the hair on the body and tail is long, silky, and of a pale but vivid yellow colour, almost white, with a considerable tuft at the extremity of the tail. It walks on four feet, and is eight or nine inches in length, from the muzzle to the rump ; and the tail is above 13 inches long. This species has the same manners and vivacity with the other *sagoinus*, but is more robust in constitution, as an individual lived five or six years in Paris, being kept in a warm room during winter.

39. The mico, *sagoinus argenteus*, or fair monkey, with a small round head : face and ears of the most lively vermilion colour : body covered with most beautiful long hairs of a bright and silvery whiteness, of matchless elegance : tail of a shining dark chestnut : head and body eight inches long ; tail 12. Inhabits the banks of the Amazons ; discovered by M. de Condamine.

Fig. 29. 40. The tamarin, *sagoinus Midas*, or great-eared monkey, with a round head, swarthy, flesh coloured, naked face : upper lip a little divided : ears very large, erect, naked, and almost square : hair on the forehead upright and long ; on the body soft, but shaggy : the head, whole body, and upper part of the limbs black, except the lower part of the back, which is tinged with yellow : hands and feet covered with orange-coloured hairs, very fine and smooth : nails long and

crooked : tail black, and twice the length of the body : teeth very white. It is of the size of a squirrel. It inhabits the hotter parts of South America, and the isle of Gorgona, south of Panama, in the South Sea. There are, says Dampier, a great many little black monkeys : at low-water they come to the sea-side to take muscles and periwinkles, which they dig out of the shells with their claws.

Besides these which we have described, there are a great many species which we have omitted. Those who wish to be better acquainted with the *simia*, may consult Buffon, Pennant, and Gmelin's edition of the *Zoology of Linnaeus* by Mr Ker.

SIMILE, or SIMILITUDE, in rhetoric, a comparison of two things, which though different in other respects, yet agree in some one. The difference between a simile and comparison is said to consist in this, that the simile properly belongs to whatever we call the quality of a thing, and the comparison to the quantity. See COMPARISON ; and ORATORY, n<sup>o</sup> 118.

SIMILOR, a name given to an alloy of red copper and zinc, made in the best proportions, to imitate silver and gold.

SIMON MACCABEUS, a celebrated leader and high-priest of the Jews, who, after rendering the most important services to his country, was at last treacherously slain by his son-in-law. See *the History of the Jews*, n<sup>o</sup> 15.

SIMON Magus, or the Sorcerer, was a native of Gitton, a village of Samaria. According to the usual practice of the Asiatics of that age, he visited Egypt, and there probably became acquainted with the sublime mysteries taught in the Alexandrian school, and learned those theurgic or magical operations by means of which it was believed that men might be delivered from the power of evil demons. Upon his return into his own country, the author of the Clementine Recognitions relates, that he imposed upon his countrymen by high pretensions to supernatural powers. And St Luke attests, that this artful fanatic, using sorcery, had bewitched the people of Samaria, giving out that he was *some great one* ; and that he obtained such general attention and reverence in Samaria, that the people all gave heed to him from the least to the greatest, saying, " This man is the great power of God."

By the preaching of Philip the Deacon, he was with other Samaritans converted to the Christian faith, and admitted into the infant church by the ordinance of baptism. His conversion, however, seems not to have been real ; for, upon seeing the miraculous effects of the laying on of the apostle's hands, he offered them money, saying, " Give me also this power, that on whomsoever I lay hands he may receive the Holy Ghost." He probably thought Peter and John magicians like himself, but better skilled in the art of deceiving the multitude.

Being sharply reprov'd for this impiety, he seems by his answer to have been made sensible of his sin ; but his repentance, if sincere, was of short duration. Returning to his former practices of imposture, he travelled through various provinces of the empire, opposing the progress of the gospel ; and arriving at Rome, he led astray vast numbers of people by his pretended miracles. How long he lived in that metropolis of the world, or in what manner he died, we have no accounts

*Simon.* that can be fully depended on. The Christian writers tell us, that being raised in the air by two dæmons, he was deprived of their support by the prayers of St Peter and St Paul, and falling, broke his legs. By some he is thought to have been the person mentioned by Suetonius, who, undertaking to fly in the presence of Nero, fell to the ground with such violence, that his blood spouted up to the gallery where the emperor was sitting.

The sum of this impostor's doctrine, divested of allegory, was, that from the Divine Being, as a fountain of light, flow various orders of æons, or eternal natures, subsisting within the plenitude of the divine essence; that beyond these, in the order of emanation, are different classes of intelligences, among the lowest of which are human souls; that matter is the most remote production of the emanative power, which, on account of its infinite distance from the Fountain of Light, possesses sluggish and malignant qualities, which oppose the divine operations, and are the cause of evil; that it is the great design of philosophy to deliver the soul from its imprisonment in matter, and restore it to that divine light from which it was derived; and that for this purpose God had sent him one of the first æons among men. To his wife Helena he also ascribed a similar kind of divine nature, pretending that a female æon inhabited the body of this woman, to whom he gave the name of *Enosis, Wisdom*; whence some Christian fathers have said, that he called her the *Holy Spirit*. He also taught the transmigration of souls, and denied the resurrection of the body.

SIMON (Richard), was born at Dieppe the 15th May 1628. He began his studies among the priests of the Oratory in that city, but quitted their society in a short time. From Dieppe he went to Paris, where he made great progress in the study of the oriental languages. Some time afterwards he joined the society of the Oratory again, and became a priest of it in 1660. In 1670 he published some pieces of a smaller kind. In 1678 his *Critical History of the Old Testament* appeared, but was immediately suppressed by the intrigues of Messieurs du Port Royal. It was reprinted the year after, and its excellence soon drew the attention of foreigners; an edition of it was accordingly published at Amsterdam in Latin, and at London in English.

He died at Dieppe in 1712, at the age of 74.

He certainly possessed a vast deal of learning; his criticism is exact, but not always moderate; and there reigns in his writings a spirit of novelty and singularity which raised him a great many adversaries. The most celebrated of these were Le Clerc, Vossius, Jurieu, Du Pin, and Bossuet. Simon wrote an answer to most of the books that were published against him, and displays a pride and obstinacy in his controversial writings which do him little honour.

He was the author of a great many books. The following are the principal: 1. *The Ceremonies of the Jews*, translated from the Italian of Leo of Modena, with a supplement concerning the sects of the Barraites and Samaritans. 2. *L'Histoire Critique du Vieux Testament*, "The Critical History of the Old Testament." This is a very important work, and deserves the attention of every clergyman. He sometimes, however, deviates from the road of integrity, to serve the cause of

the church of Rome, particularly in his endeavours to prove the uncertainty of the Hebrew language. These passages have been very justly exposed and confuted by Dr Campbell, in his ingenious Preliminary Dissertations to his new Translation of the Gospels. 3. *Critical History of the Text of the New Testament*. 4. *Critical History of the Versions of the New Testament*. 5. *Critical History of the principal Commentators on the New Testament*. 6. *Inspiration of the Sacred Books*. 7. *A translation of the New Testament*. This book was censured by Cardinal Noailles and Bossuet. 8. *The History of the rise and progress of Ecclesiastical Revenues*, which is commended by Voltaire, as is his *Critical History of the Old Testament*. It resulted from a quarrel with a community of Benedictines. 9. *A new select Library*, which points out the good books in various kinds of literature, and the use to be made of them. 10. *Critical History of the Belief and Customs of the Nations on the Levant*. 11. *Critical Letters*, &c.

SIMONICAL, is applied to any person guilty of simony. See SIMONY.

SIMONIDES, the name of several poets celebrated in antiquity; but by the Marbles it appears that the eldest and most illustrious of them was born in the 55th Olympiad, 538 years B. C. and that he died in his 90th year; which nearly agrees with the chronology of Eusebius. He was a native of Ceos, one of the Cyclades, in the neighbourhood of Attica, and the preceptor of Pindar. Both Plato and Cicero give him the character not only of a good poet and musician, but speak of him as a person of great virtue and wisdom. Such longevity gave him an opportunity of knowing a great number of the first characters in antiquity with whom he was in some measure connected. It appears in Fabricius, from ancient authority, that Simonides was cotemporary and in friendship with Pittacus of Mitylene, Hipparchus tyrant of Athens, Pausanias king of Sparta, Hiero tyrant of Syracuse, with Themistocles, and with Alevades king of Thessaly. He is mentioned by Herodotus; and Xenophon, in his Dialogue upon Tyranny, makes him one of the interlocutors with Hiero king of Syracuse. Cicero alleges, what has often been quoted in proof of the modesty and wisdom of Simonides, that when Hiero asked him for a definition of God, the poet required a whole day to meditate on so important a question: at the end of which, upon the prince putting the same question to him a second time, he asked two days respite; and in this manner always doubled the delay each time he was required to answer it; till at length, to avoid offending his patron by more disappointments, he frankly confessed that he found the question so difficult, that the more he meditated upon it, the less was his hope of being able to solve it.

In his old age, perhaps from seeing the respect which money procured to such as had lost the charms of youth and the power of attaching mankind by other means, he became somewhat mercenary and avaricious. He was frequently employed by the victors at the games to write panegyrics and odes in their praise, before his pupil Pindar had exercised his talents in their behalf: but Simonides would never gratify their vanity in this particular, till he had first tied them down to a stipulated sum for his trouble; and upon being upbraided for his

mean-

*Simonical,*  
*Simonides.*

Simonides,  
Simony.

meanings, he said, that he had two coffers, in one of which he had for many years put his pecuniary rewards; the other was for honours, verbal thanks, and promises; that the first was pretty well filled, but the last remained always empty. And he made no scruple to confess, in his old age, that of all the enjoyments of life, the love of money was the only one of which time had not deprived him.

He was frequently reproached for this vice; however, he always defended himself with good humour. Upon being asked by Hiero's queen, Whether it was most desirable to be learned or rich? he answered, that it was far better to be rich; for the learned were always dependent on the rich, and waiting at their doors; whereas, he never saw rich men at the doors of the learned. When he was accused of being so fond as to sell part of the provisions with which his table was furnished by Hiero, he said he had done it in order "to display to the world the magnificence of that prince and his own frugality." To others he said, that his reason for accumulating wealth was, that "he would rather leave money to his enemies after death, than be troublesome to his friends while living."

He obtained the prize in poetry at the public games when he was fourscore years of age. According to Suidas, he added four letters to the Greek alphabet; and Pliny assigns to him the eighth string of the lyre; but these claims are disputed by the learned.

His poetry was so tender and plaintive, that he acquired the cognomen of *Melicertes* "sweet as honey;" and the tearful eye of his muse was proverbial. Dionysius places him among those polished writers who excel in a smooth volubility, and flow on like plenteous and perennial rivers, in a course of even and uninterrupted harmony.

It is to Dionysius that we are indebted for the preservation of the following fragment of this poet. Danae being by her merciless father inclosed in a chest, and thrown into the sea with her child, when night comes on, and a storm arises which threatens to overturn the chest, she, weeping and embracing the young Perseus, cries out:

Sweet child! what anguish does thy mother know,  
Ere cruel grief has taught thy tears to flow!  
Amidst the roaring wind's tremendous sound,  
Which threats destruction as it howls around;  
In balmy sleep thou liest, as at the breast,  
Without one bitter thought to break thy rest.—  
The glimm'ring moon in pity hides her light,  
And shrinks with horror at the ghastly sight.  
Didst thou but know, sweet innocent! our woes,  
Not opiate's pow'r thy eyelids now could close.  
Sleep on, sweet babe! ye waves in silence roll;  
And lull, O lull, to rest my tortur'd soul!

There is a second great poet of the name of Simonides recorded on the Marbles, supposed to have been his grandson, and who gained, in 478 B. C. the prize in the games at Athens.

SIMONY, is the corrupt presentation of any one to an ecclesiastical benefice for money, gift, or reward. It is so called from the resemblance it is said to bear to the sin of Simon Magus, though the purchasing of holy orders seems to approach nearer to his offence. It was by the canon law a very grievous crime: and is so much

the more odious, because, as Sir Edward Coke observes, it is ever accompanied with perjury; for the presentee is sworn to have committed no simony. However, it was not an offence punishable in a criminal way at the common law: it being thought sufficient to leave the clerk to ecclesiastical censures. But as these did not affect the simoniacal patron, nor were efficacious enough to repel the notorious practice of the thing, divers acts of parliament have been made to restrain it by means of civil forfeitures; which the modern prevailing usage, with regard to spiritual preferments, calls aloud to be put in execution. The statute 31 Eliz. c. 6. enacts, that if any patron, for money or any other corrupt consideration or promise, directly or indirectly given, shall present, admit, institute, induct, install, or collate any person to an ecclesiastical benefice or dignity, both the giver and taker shall forfeit two years value of the benefice or dignity; one moiety to the king, and the other to any one who will sue for the same. If persons also corruptly resign or exchange their benefices, both the giver and taker shall in like manner forfeit double the value of the money or other corrupt consideration. And persons who shall corruptly ordain or license any minister, or procure him to be ordained or licensed (which is the true idea of simony), shall incur a like forfeiture of forty pounds; and the minister himself of ten pounds, besides an incapacity to hold any ecclesiastical preferment for seven years afterwards. Corrupt elections and resignations in colleges, hospitals, and other eleemosynary corporations, are also punished, by the same statute, with forfeiture of the double value, vacating the place or office, and a devolution of the right of election, for that turn, to the crown.

SIMOOM, a hot wind which blows occasionally in the deserts of Africa, and probably in other widely extended countries parched in the same manner by a vertical sun. Its effects on the human body are dreadful. If inhaled in any quantity, it produces instant suffocation, or at least leaves the unhappy sufferer oppressed with asthma and lowness of spirits. The approach of this awful scourge of God is indicated by a redness in the air, well understood by those who are accustomed to journey through the desert; and the only refuge which they have from it, is to fall down with their faces close to the ground, and to continue as long as possible without drawing in their breath.

Mr Bruce, who, in his journey through the desert, suffered from the simoom, gives of it the following graphical description: "At eleven o'clock, while we contemplated with great pleasure the rugged top of Chig-<sup>Bruce's</sup> <sup>Travels,</sup> gre, to which we were fast approaching, and where we were to solace ourselves with plenty of good water, P. 559. Idris our guide cried out, with a loud voice, fall upon you faces, for here is the simoom. I saw from the south-east a haze come, in colour like the purple part of the rainbow, but not so compressed or thick. It did not occupy twenty yards in breadth, and was about twelve feet high from the ground. It was a kind of blush upon the air, and it moved very rapidly; for I scarce could turn to fall upon the ground with my head to the northward, when I felt the heat of its current plainly upon my face. We all lay flat on the ground as if dead, till Idris told us it was blown over. The meteor or purple haze which I saw was indeed passed, but the light air that still blew was of heat to threaten

Simony,  
Simoom.

Simple,  
simplicity.

threaten suffocation. For my part, I found distinctly in my breast that I had imbibed a part of it, nor was I free of an asthmatic sensation till I had been some months in Italy, at the baths of Poretta, near two years afterwards." Though the severity of this blast seems to have passed over them almost instantaneously, it continued to blow so as to exhaust them till twenty minutes before five in the afternoon, lasting through all its stages very near six hours, and leaving them in a state of the utmost despondency.

SIMPLE, something not mixed or compounded; in which sense it stands opposed to *compound*.

SIMPLE, in the materia medica, a general name for all herbs or plants, as having each its particular virtue, whereby it becomes a simple remedy.

SIMPLICITY IN WRITING. If we examine the writers whose compositions have stood the test of ages, and obtained that highest honour, "the concurrent approbation of distant times and nations," we shall find that the character of simplicity is the unvarying circumstance which alone hath been able to gain this universal homage from mankind. Among the Greeks, whose writers in general are of the simple kind, the divinest poet, the most commanding orator, the finest historian, and deepest philosopher, are, above the rest, conspicuously eminent in this great quality. The Roman writers rise towards perfection according to that measure of simplicity which they mingle in their works; indeed they are all inferior to the Greek models. But who will deny that Lucretius, Horace, Virgil, Livy, Terence, Tully, are at once the simplest and best of Roman writers? unless we add the noble annalist who appeared in after-times; who, notwithstanding the political turn of his genius, which sometimes interferes, is admirable in this great quality, and by it far superior to his contemporaries. It is this one circumstance that hath raised the venerable Dante, the father of modern poetry, above the succeeding poets of his country, who could never long maintain the local and temporary honours bestowed upon them; but have fallen under that just neglect which time will ever decree to those who desert a just simplicity for the florid colourings of style, contrived phrases, affected conceits, the mere trappings of composition and Gothic minutiae. It is this hath given to Boileau the most lasting wreath in France, and to Shakespeare and Milton in England; especially to the former, whose writings contain specimens of perhaps the purest and simplest English that is anywhere to be found, except in the Bible or Book of Common Prayer. As it appears from these instances, that simplicity is the only universal characteristic of just writing, to the superior eminence of the sacred Scriptures in this quality hath been generally acknowledged. One of the greatest critics in antiquity, himself conspicuous in the sublime and simple manner, hath borne this testimony to the writings of Moses and St Paul; and by parity of reason we must conclude, that had he been conversant with the other sacred writers, his taste and candour would have allowed them the same encomium.

It hath been often observed even by writers of no mean rank, that the "Scriptures suffer in their credit by the disadvantage of a literal version, while other ancient writings enjoy the advantage of a free and embellished translation." But in reality these gentlemen's concern is ill-placed and groundless; for the truth is, "that

most other writings are impaired by a literal translation; whereas giving only a due regard to the idiom of different languages, the sacred writings, when literally translated, are then in their full perfection."

Simplicity  
||  
Simpson.

Now this is an internal proof, that in all other writings there is a mixture of local, relative, exterior ornament, which is often lost in the transfusion from one language to another. But the internal beauties, which depend not on the particular construction of tongues, no change of tongue can destroy. Hence the Bible preserves its native beauty and strength alike in every language, by the sole energy of unadorned phrase, natural images, weight of sentiment, and great simplicity.

It is in this respect like a rich vein of gold, which, under the severest trials of heat, cold, and moisture, retains its original weight and splendour, without either loss or alloy; while baser metals are corrupted by earth, air, water, fire, and assimilated to the various elements through which they pass.

This circumstance, then, may be justly regarded as sufficient to vindicate the composition of the sacred Scriptures, as it is at once their chief excellence and greatest security. It is their excellence, as it renders them intelligible and useful to all; it is their security, as it prevents their being disguised by the false and capricious ornaments of vain or weak translators. We may safely appeal to experience and fact for the confirmation of these remarks on the superior simplicity, utility, and excellence, of the style of the Holy Scripture. Is there any book in the world so perfectly adapted to all capacities? that contains such sublime and exalted precepts, conveyed in such artless and intelligible strain, that can be read with such pleasure and advantage by the lettered sage and the unlettered peasant?

SIMPLOCE. See ORATORY, n<sup>o</sup> 72.

SIMPSON (Thomas), professor of mathematics at the royal academy at Woolwich, fellow of the Royal Society, and member of the Royal Academy at Stockholm, was born at Market Bosworth in Leicestershire in 1710. His father, a stuff-weaver, taught him only to read English, and brought him up to his own business; but meeting with a scientific pedlar, who likewise practised fortune-telling, young Simpson by his assistance and advice left off weaving, and professed astrology. As he improved in knowledge, however, he grew disgusted with his pretended art; and renouncing it, was driven to such difficulties for the subsistence of his family, that he came up to London, where he worked as a weaver, and taught mathematics at his spare hours. As his scholars increased, his abilities became better known, and he published his Treatise on Fluxions, by subscription, in 1737: in 1740, he published his Treatise on the Nature and Laws of Chance; and Essays in Speculative and Mixed Mathematics. After these appeared his Doctrine of Annuities and Reversions; Mathematical Dissertations; Treatise on Algebra; Elements of Geometry; Trigonometry, Plane and Spherical; Select Exercises; and his Doctrine and Application of Fluxions, which he professes to be rather a new work, than a second edition of his former publication on fluxions. In 1743, he obtained the mathematical professorship at Woolwich academy; and soon after was chosen a member of the Royal Society, when the president and council, in consideration of his moderate circumstances, were pleased to excuse his admissions.

Simson,  
Simson.

feet, and his giving bonds for the settled future payments. At the academy he exerted all his abilities in instructing the pupils who were the immediate objects of his duty, as well as others whom the superior officers of the ordnance permitted to be boarded and lodged in his house. In his manner of teaching he had a peculiar and happy address, a certain dignity and perspicuity, tempered with such a degree of mildness, as engaged the attention, esteem, and friendship, of his scholars. He therefore acquired great applause from his superiors in the discharge of his duty. His application and close confinement, however, injured his health. Exercise and a proper regimen were prescribed to him, but to little purpose: for his spirits sunk gradually, till he became incapable of performing his duty, or even of reading the letters of his friends. The effects of this decay of nature were greatly increased by vexation of mind, owing to the haughty and insulting behaviour of his superior the first professor of mathematics. This person, greatly his inferior in mathematical accomplishments, did what he could to make his situation uneasy, and even to depreciate him in the public opinion: but it was a vain endeavour, and only served to depress himself. At length his physicians advised his native air for his recovery, and he set out in February 1761; but was so fatigued by his journey, that upon his arrival at Bosworth, he betook himself to his chamber, and grew continually worse till the day of his death, which happened on the 14th of May, in the 51st year of his age.

SIMSON (Dr Robert), professor of mathematics in the university of Glasgow, was born in the year 1687 of a respectable family, which had held a small estate in the county of Lanerk for some generations. He was, we think, the second son of the family. A younger brother was professor of medicine in the university of St Andrew's, and is known by some works of reputation, particularly a Dissertation on the Nervous System, occasioned by the Dissection of a Brain completely Ossified.

Dr Simson was educated in the university of Glasgow under the eye of some of his relations who were professors. Eager after knowledge, he made great progress in all his studies; and, as his mind did not, at the very first openings of science, strike into that path which afterwards so strongly attracted him, and in which he proceeded so far almost without a companion, he acquired in every walk of science a stock of information, which, though it had never been much augmented afterwards, would have done credit to a professional man in any of his studies. He became, at a very early period, an adept in the philosophy and theology of the schools, was able to supply the place of a sick relation in the class of oriental languages, was noted for historical knowledge, and one of the most knowing botanists of his time.

It was during his theological studies, as preparatory for his entering into orders, that mathematics took hold of his fancy. He used to tell in his convivial moments how he amused himself when preparing his exercises for the divinity hall. When tired with vague speculation, in which he did not meet with certainty to reward his labours, he turned up a book of oriental philology, in which he found something which he could discover to be true or to be false, without going out of the line of study which was to be of ultimate use to

him. Sometimes even this could not relieve his fatigue. He then had recourse to mathematics, which never failed to satisfy and refresh him. For a long while he restricted himself to a very moderate use of the cordial, fearing that he would soon exhaust the small stock which so limited and abstract a science could yield; till at last he found, that the more he learned, a wider field opened to his view, and scenes that were inexhaustible. Becoming acquainted with subjects far beyond the elements of the science, and with numbers of names celebrated during that period of ardent research all over Europe, he found it to be a manly and important study, by which he was as likely to acquire reputation as by any other. About this time, too, a prospect began to open of making mathematics his profession for life. He then gave himself up to it without reserve.

His original incitement to this study as a treat, as something to please and refresh his mind in the midst of severer tasks, gave a particular turn to his mathematical studies, from which he never could afterwards deviate. Perspicuity and elegance are more attainable, and more discernible, in pure geometry, than in any other parts of the science of measure. To this therefore he chiefly devoted himself. For the same reason he preferred the ancient method of studying pure geometry, and even felt a dislike to the Cartesian method of substituting symbols for operations of the mind, and still more was he disgusted with the substitution of symbols for the very objects of discussion, for lines, surfaces, solids, and their affections. He was rather disposed in the solution of an algebraic problem, where quantity alone was considered, to substitute figure and its affections for the algebraic symbols, and to convert the algebraic formula into an analogous geometrical theorem. And he came at last to consider algebraic analysis as little better than a kind of mechanical knack, in which we proceed without ideas of any kind, and obtain a result without meaning, and without being conscious of any process of reasoning, and therefore without any conviction of its truth. And there is no denying, that if genuine unsophisticated taste alone is to be consulted, Dr Simson was in the right: for though it must also be acknowledged, that the reasoning in algebra is as strict as in the purest geometry or Euclid or Apollonius, the expert analyst has little perception of it as he goes on, and his final equation is not felt by himself as the result of ratiocination, any more than if he had obtained it by Pascal's arithmetical mill. This does not in the least diminish our admiration of the algebraic analysis; for its almost boundless grasp, its rapid and certain procedure, and the delicate metaphysics and great address which may be displayed in conducting it. Such, however, was the ground of the strong bias of Dr Simson's mind to the analysis of the ancient geometers. It increased as he went forward; and his veneration (we may call it his *love* or *affection*) for the ancient geometry was carried to a degree of idolatry. His chief labours were exerted in efforts to restore the works of the ancient geometers; and he has nowhere bestowed much pains in advancing the modern discoveries in mathematics. The noble inventions, for example, of fluxions and of logarithms, by which our progress in mathematical knowledge, and in the useful application of this knowledge, is so much promoted, attracted the notice of Dr Simson; but he has contented himself with de-

Simson.





1. *Satyrus*, Curang Cutang. 2. *Pongy* or *Tocko*. 3. *Simia Lar* or *Great Gibbon*.  
 4. *Simia Lar Minor* or *Little Gibbon*. 5. *Silvanus* or *Pigmy*. 6 & 7. *Tarus* or *Magot*.

A. B. H. Pinx. W. L. Sculptor fecit.





1. *Vernicestrina* or Pig-tailed Baboon. 9. *Sphinx* or Great Baboon. 10. *Apediu* or Little Baboon. 11. *Mormon* or Mantegar. 12. The Male *Marmoset* or 2 *Mandril*. 13. The Female *Mandril*. 14. *Silvaticus* or Wood Baboon.



16.

22.

20.



21.



19.

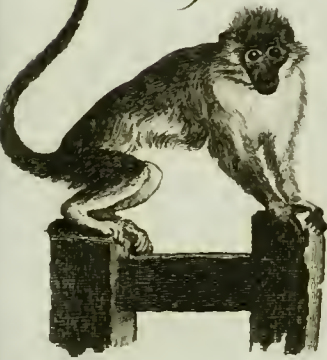

17.



15.

18.



15. *Simulias* or Dog-faced. Monkey. 16. *Silenus Albitarbatus* or Lion-tailed. Monkey. 17. *Cynomolgus* or Hare-tipped. Monkey. 18. *Cynocephalus* or Dog-headed. Monkey. 19. *Salvatus* or Green. Monkey. 20. *Ethiops* or Mangabey. 21. *Aegula* or Egret. 22. *Cercopithecus regalis* or King. Monkey.

S. Al. Bell. Pin. Mal. Sculp. f. 2.



23.

25.

24.



SIMLÆ, Sagoins.

29.

28.

27.

26.



Sapajous 23. Beelzelub or Prancher. Monkey. 24. Capucinus Sai or Wisp. 25. Fatuellans or Hemad. Sagoins 26. Fevechus or Striated. Monkey. 27. Cedipus or Red tailed. Monkey. 28. Rosalibus or Silky Monkey. 29. Uidans or Great eared. Monkey.

A. Bell Pin. M. de Sculptor fecit.





monstrating their truth on the genuine principles of the ancient geometry. Yet was he very thoroughly acquainted with all the modern discoveries; and there are to be seen among his papers discussions and investigations in the Cartesian method, which show him thoroughly acquainted with all the principles, and even expert in the *tours de main*, of the most refined symbolical analysis (A).

About the age of 25 Dr Simson was chosen regius professor of mathematics in the university of Glasgow. He went to London immediately after his appointment, and there formed an acquaintance with the most eminent men of that bright era of British science. Among these he always mentioned Captain Halley (the celebrated Dr Edmund Halley) with particular respect; saying, that he had the most acute penetration, and the most just taste in that science, of any man he had ever known. And, indeed, Dr Halley has strongly exemplified both of these in his divination of the work of *Apollonius de Sectione Spatii*, and the 8th book of his *Conics*, and in some of the most beautiful theorems in Sir Isaac Newton's *Principia*. Dr Simson also admired the wide and masterly steps which Newton was accustomed to take in his investigations, and his manner of substituting geometrical figures for the quantities which are observed in the phenomena of nature. It was from Dr Simson that the Writer of this article had the remarks which has been oftener than once repeated in the course of this Work, "That the 39th proposition of the first book of the *Principia* was the most important proposition that had ever been exhibited to the physico-mathematical philosopher;" and he used always to illustrate to his more advanced scholars the superiority of the geometrical over the algebraic analysis, by comparing the solution given by Newton of the inverse problem of centripetal forces, in the 42d proposition of that book, with the one given by John Bernoulli in the Memoirs of the Academy of Sciences at Paris for 1713. We have heard him say, that to his own knowledge Newton frequently investigated his propositions in the symbolical way, and that it was owing chiefly to Dr Halley that they did not finally appear in that dress. But if Dr Simson was well informed, we think it a great argument in favour of the symbolic analysis, when this most successful *practical artist* (for so we must call Newton when engaged in a task of discovery) found it conducive either to dispatch or perhaps to his very progress.

Returning to his academical chair, Dr Simson discharged the duties of a professor for more than 50 years with great honour to the university and to himself.

It is almost needless to say, that in his prelections he followed strictly the Euclidian method in elementary geometry. He made use of Theodotus as an introduction to spherical trigonometry. In the higher geometry he prelected from his own *Conics*; and he gave a small specimen of the *linear problems* of the ancients, by explaining the properties, sometimes of the conchoid,

Vol. XVII. Part II.

sometimes of the cissoid, with their application to the solution of such problems. In the more advanced class he was accustomed to give Napier's mode of conceiving logarithms, *i. e.* quantities as generated by motion; and Mr Cotes's view of them, as the sums of ratiunculæ; and to demonstrate Newton's lemmas concerning the limits of ratios; and then to give the elements of the fluxionary calculus; and to finish his course with a select set of propositions in optics, gnomonics, and central forces. His method of teaching was simple and perspicuous, his elocution clear, and his manner easy and impressive. He had the respect, and still more the affection, of his scholars.

With respect to his studies, we have already informed the reader that they got an early bias to pure geometry, and to the elegant but scrupulous methods of the ancients.

We have heard Dr Simson say, that it was in a great measure owing to Dr Halley that he so early directed his efforts to the restoration of the ancient geometers. He had recommended this to him, as the most certain way for him, then a very young man, both to acquire reputation, and to improve his own knowledge and taste, and he presented him with a copy of Pappus's *Mathematical Collections*, enriched with some of his own notes. The perspicuity of the ancient geometrical analysis, and a certain elegance in the nature of the solutions which it affords, especially by means of the local theorems, soon took firm hold of his fancy, and made him, with the sanguine expectation of a young man, direct his very first efforts to the recovery of this *in toto*: and the restoration of Euclid's *Porisms* was the first task which he set himself. The accomplished geometer knows what a desperate task this was, from the scanty and mutilated account which we have of this work in a single passage of Pappus. It was an ambition which nothing but success could justify in so young an adventurer. He succeeded; and so early as 1718 seemed to have been in complete possession of this method of investigation, which was considered by the eminent geometers of antiquity as their surest guide through the labyrinths of the higher geometry. Dr Simson gave a specimen of his discovery in 1723 in the *Philosophical Transactions*. And after this time he ceased not from his endeavours to recover that choice collection of *Porisms* which Euclid had collected, as of the most general use in the solution of difficult questions. What some of these must have been was pointed out to Dr Simson by the very nature of the general proposition of Pappus, which he has restored. Others were pointed out by the lemmas which Pappus has given as helps to the young mathematician towards their demonstration. And, being thus in possession of a considerable number, their mutual relations pointed out a sort of system, of which these made a part, and of which the blanks now remained to be filled up.

Dr Simson, having thus gained his favourite point,

3 S

had

(A) In 1752 the writer of this article being then his scholar, requested him to examine an account which he gave him of what he thought a new curve (a conchoid having a circle for its base). Dr Simson returned it next day with a regular list of its leading properties, and the investigation of such as he thought his scholar would not so easily trace. In this hasty trawl the lines related to the circle were familiarly considered as arithmetical fractions of the radius considered as unity. This was before Euler published his *Arithmetic of the Sines* and *Tangents*, now in universal use.

Simfon.

had leisure to turn his attention to the other works of the ancient geometers, and the porisms of Euclid now had only an occasional share. The *loci plani* of Apollonius was another task which he very early engaged in, and completed about the year 1738. But, after it was printed, he imagined that he had not given the *ipfiffime* propofitions of Apollonius, and in the precise spirit and order of that author. The impreffion lay by him for fome years; and it was with great reluctance that he yielded to the intreaties of his mathematical friends, and published the work, in 1746, with fome emendations, where he thought he had deviated fartheft from his author. He quickly repented of this feanty confeffion, and recalled what he could of the fmall number of copies which he had given to the bookfellers, and the impreffion again lay by him for years. He afterwards re-corrected the work, and ftill with fome reluctance allowed it to come abroad as the Reftitution of Apollonius. The public, however, had not been fo factitious as Dr Simfon, and the work had acquired great celebrity, and he was now confidered as one of the firft and the moft elegant geometers of the age: for, in the mean time, he had published his Conic Sections, a work of uncommon merit, whether we confider it as equivalent to a complete reftitution of the celebrated work of Apollonius Pergæus, or as an excellent fyftem of this important part of mathematics. It is marked with the fame features as the *loci plani*, the moft anxious folitude to exhibit the very text of Apollonius, even in the propofitions belonging to the books which had been completely loft. Thefe could be recovered in no other way but by a thorough knowledge of the precise plan propofed by the author, and by taking it for granted that the author had accurately accomplifhed this plan. In this manner did Viviani proceed in the firft attempt which was made to reftore the conics of Apollonius; and he has given us a detail of the procefs of his conjectures, by which we may form an opinion of its juftnefs, and of the probability how far he has attained the defired object. Dr Simfon's view in his performance was fomething different, deviating a little in this one cafe from his general track. He was not altogether pleafed with the work of Viviani, even as augmented by the eighth book added by Halley, and his wifh was to reftore the ancient original. But, in the mean time, an academical text book for conic fections was much wanted. He was much difatisfied with thofe in common ufe; and he was not infenfible of the advantage resulting from the confideration of thefe fections, independent of the cone firft introduced by Dr Wallis. He therefore compofed this excellent treatife as an elementary book, not to fuperfede, but to prepare for the ftudy of Apollonius; and accordingly accommodates it to this purpofe, and gives feveral important propofitions in their proper places, *exprefly as reftitutions of Apollonius*, whom he keeps constantly in view through the whole work.

Much about this time Dr Simfon ferioufly began to prepare a perfect edition of Euclid's Elements. The intimate acquaintance which he had by this time acquired with all the original works of the ancient geometers, and their ancient commentators and critics, encouraged him to hope that he could reftore to his original luftre this leader in mathematical fcience; and the errors which had crept into this celebrated work, and

which ftill remained in it, appeared of magnitude fufficient to merit the moft careful efforts for their removal. The DATA alfo, which were in like manner the introduction to the whole art of geometrical investigation, feemed to call more loudly for his amending hand. For it appears that the Saracens, who have preferred to us the writings of the ancients, have contented themfelves with admiring thefe celebrated works, and have availed themfelves of the knowledge which they contain; but they have fhown no inclination to add to the ftock, or to promote the fciences which they had received. They could not do any thing without the fynthetical books of the geometers; but, not meaning to go beyond the difcoveries which they had made, they neglected all the books which related to the analytic art alone, and the greateft part of them (about 25 out of 30) have irrecoverably perifhed. The data of Euclid have fortunately been preferred, but the book was neglected, and the only ancient copies, which are but three or four, are miferably erroneous and mutilated. Fortunately, it is no very arduous matter to reftitute this work in its original perfection. The plan is precise, both in its extent and its method. It had been reftored, therefore, with fuccefs by more than one author. But Dr Simfon's comprehensive view of the whole analytical fyftem pointed out to him many occafions for amendment. He therefore made its institution a joint task with that of the elements. All the lovers of true geometry will acknowledge their obligations to him for the edition of the Elements and data which he published about 1758. The text is corrected with the moft judicious and fcrupulous care, and the notes are inelimitable, both for their information, and for the tendency which they muft have to form the mind of the ftudent to a true judgment and tafte in mathematical fubjects. The more accomplifhed reader will perhaps be fometimes difpofed to fmile at the axiom which feems to pervade the notes, "that a work of Euclid muft be fuppofed without error or defect." If this was not the cafe, Euclid has been obliged to his editor in more inftances than one. Nor fhould his greateft admirers think it impoffible that in the progreff of human improvement, a geometrical truth fhould occur to one of thefe latter days, which efcaped the notice of even the Lincean Euclid. Such merit, however, Dr Simfon nowhere claims, but lays every blame of error, omiffion, or obfcurity, to the charge of Proclus, Theon, and other editors and commentators of the renowned Grecian.

There is another work of Apollonius on which Dr Simfon has beftowed great pains, and has reftored, as we imagine, *omnibus numeris perfectum*, viz. the *SECTIO DETERMINATA*; one of thofe performances which are of indifpenfable ufe in the application of the ancient analysis. This alfo feems to have been an early task, tho' we do not know the date of his labours on it. It did not appear till after his death, being then published along with the great work, the Porifms of Euclid, at the expence of the late Earl Stanhope, a nobleman intimately converfant with the ancient geometry, and zealous for its reception among the mathematicians of the prefent age. He had kept up a conflant correffpondence with Dr Simfon on mathematical fubjects; and at his death in 1768, engaged Mr Clow profeflor of logic in the univerfity of Glafgow, to whose care the Doctor had left all his valuable papers, to make a

felec-

Simfon.

Simfon. selection of such as would serve to support and increase his well earned reputation as THE RESTORER of ANCIENT GEOMETRY.

We have been thus particular in our account of Dr Simfon's labours in these works, because his manner of execution, while it does honour to his inventive powers, and shows his just taste in mathematical composition, also confirms our former assertion, that he carried his respect for the ancient geometers to a degree of superstitious idolatry, and that his fancy, unchecked, viewed them as incapable of error or imperfection. This is distinctly to be seen in the emendations which he has given of the texts, particularly in his editions of Euclid. Not only every imperfection of the reading is ascribed to the ignorance of copyists, and every indistinctness in the conception, inconclusiveness in the reasoning, and defect in the method, is ascribed to the ignorance or mistake of the commentators; but it is all along assumed that the work was perfect in its kind; and that by exhibiting a perfect work, we restore the genuine original. This is surely gratuitous; and it is very possible that it has, in some instances, made Dr Simfon fail of his anxious purpose, and give us even a better than the original. It has undoubtedly made him fail in what *should have been* his great purpose, viz. to give the world a connected system of the ancient geometrical analysis; such as would, in the first place, exhibit it in its most engaging form, elegant, perspicuous, and comprehensive; and, in the next place, such as should engage the mathematicians of the present age to adopt it as the most certain and successful conductor in those laborious and difficult researches in which the demands of modern science continually engage them. And this might have been expected, in the province of speculative geometry at least, from a person of such extensive knowledge of the properties of figure, and who had so eminently succeeded in the many trials which he had made of its powers. We might have expected that he would at least have exhibited in one systematic point of view, what the ancients had done in several detached branches of the science, and how far they had proceeded in the solution of the several successive classes of problems; and we might have hoped, that he would have instructed us in what manner we should apply that method to the solution of problems of a more elevated kind, daily presented to us in the questions of physico-mathematical science. By this he would have acquired distinguished honour, and science would have received the most valuable improvement. But Dr Simfon has done little of all this; and we cannot say that great helps have been derived from his labours by the eminent mathematicians of this age, who are successfully occupied in advancing our knowledge of nature, or in improving the arts of life. He has indeed contributed greatly to the entertainment of the speculative mathematician, who is more delighted with the conscious exercise of his own reasoning powers, than with the final result of his researches. Yet we are not even certain that Dr Simfon has done this to the extent he wished and hoped. He has not engaged the liking of mathematicians to this analysis, by presenting it in the most agreeable form. His own extreme anxiety to tread in the very footsteps of the original authors, has, in a thousand instances, precluded him from using his own extensive knowledge, that he might not

employ principles which were not of a class inferior to that of the question in hand. Thus, of necessity, did the method appear trammelled. We are deterred from employing a process which appears to restrain us in the application of the knowledge which we have already acquired; and, disgusted with the tedious, and perhaps indirect path, by which we must arrive at an object which we see clearly over the hedge, and which we could reach by a few steps, of the security of which we are otherwise perfectly assured. These prepossessions are indeed founded on mistake; but the mistake is such, that all fall into it, till experience has enlarged their views. This circumstance alone has hitherto prevented mathematicians from acquiring that knowledge of the ancient analysis which would enable them to proceed in their researches with certainty, dispatch, and delight. It is therefore deeply to be regretted, that this eminent genius has occupied, in this superstitious palæology, a long and busy life, which might have been employed in original works of infinite advantage to the world, and honour to himself.

Our readers will, it is hoped, consider these observations as of general scientific importance, and as intimately connected with the history of mathematics; and therefore as not improperly introduced in the biographical account of one of the most eminent writers on this science. Dr Simfon claimed our notice as a mathematician; and his affectionate admiration of the ancient analysis is the prominent feature of his literary character. By this he is known all over Europe; and his name is never mentioned by any foreign author without some very honourable allusion to his distinguished geometrical elegance and skill. Dr James Moor, professor of Greek in the university of Glasgow, no less eminent for his knowledge in ancient geometry than for his professional talents, put the following apposite inscription below a portrait of Dr Simfon:

GEOMETRIAM, SUB TYRANNO BARBARO SÆVA  
SERVITUTE DIU SQUALENTEM, IN LIBERTATEM  
ET DECUS ANTIQVVM VINDICAVIT  
UNUS.

Yet it must not be understood that Dr Simfon's predilection for the geometrical analysis of the ancients did so far mislead him as to make him neglect the symbolical analysis of the present times; on the contrary, he was completely master of it, as has been already observed, and frequently employed it. In his academical lectures to the students of his upper classes, he used to point out its proper province (which he by no means limited by a scanty boundary), and in what cases it might be applied with safety and advantage even to questions of pure geometry. He once honoured the writer of this article with the sight of a very short dissertation on this subject (perhaps the one referred to in the preface to his Conic Sections). In this piece he was perhaps more liberal than the most zealous partisans of the symbolical analysis could desire, admitting as a sufficient equation

of the Conic Sections  $L = \frac{p^2 c}{x^2}$ , where  $L$  is the *latus rectum*,  $x$  is the distance of any point of the curve from the focus,  $p$  is the perpendicular drawn from the focus to the tangent in the given point, and  $c$  is the chord of the equicurve circle drawn thro' the focus. Unfortunately this dissertation was not found among his papers.

Simfon.

pers. He spoke in high terms of the Analytical Works of Mr Cotes, and of the two Bernoullis. He was consulted by Mr M'Laurin during the progress of his inestimable Treatise of Fluxions, and contributed not a little to the reputation of that work. The spirit of that most ingenious algebraic demonstration of the fluxions of a rectangle, and the very process of the argument, is the same with Dr Simfon's in his dissertation on the limits of quantities. It was therefore from a thorough acquaintance with the subject, and by a just taste, that he was induced to prefer his favourite analysis, or, to speak more properly, to exhort mathematicians to employ it in its own sphere, and not to become ignorant of geometry, while they successfully employed the symbolical analysis in cases which did not require it, and which suffered by its admission. It must be acknowledged, however, that in his later years, the disgust which he felt at the artificial and slovenly employment on subjects of pure geometry, sometimes hindered him from even looking at the most refined and ingenious improvements of the algebraic analysis which occur in the writings of Euler, D'Alembert, and other eminent masters. But, when properly informed of them, he never failed to give them their due praise; and we remember him speaking, in terms of great satisfaction, of an improvement of the infinitesimal calculus, by D'Alembert and De la Grange, in their researches concerning the propagation of sound, and the vibrations of musical cords.

And that Dr Simfon not only was master of this calculus and the symbolical calculus in general, but held them in proper esteem, appears from two valuable dissertations to be found in his posthumous works; the one on logarithms, and the other on the limits of ratios. The last, in particular, shows how completely he was satisfied with respect to the solid foundation of the method of fluxions; and it contains an elegant and strict demonstration of all the applications which have been made of the method by its illustrious author to the objects of pure geometry.

We hoped to have given a much more complete and instructive account of this eminent geometer and his works, by the aid of a person fully acquainted with both, and able to appreciate their value; but an accident has deprived us of this assistance, when it was too late to procure an equivalent: and we must request our readers to accept of this very imperfect account, since we cannot do justice to Dr Simfon's merit, unless almost equally conversant in all the geometry of the ancient Greeks.

The life of a literary man rarely teems with anecdote; and a mathematician, devoted to his studies, is perhaps more abstracted than any other person from the ordinary occurrences of life, and even the ordinary topics of conversation. Dr Simfon was of this class; and, having never married, lived entirely a college life. Having no occasion for the commodious house to which his place in the university intitled him, he contented himself with chambers, good indeed, and spacious enough for his sober accommodation, and for receiving his choice collection of mathematical writers, but without any decoration or commodious furniture. His official servant sufficed for valet, footman, and chambermaid. As this retirement was entirely devoted to study, he entertained no company in his chambers, but in a neighbouring

house, where his apartment was sacred to him and his guests. Simfon.

Having in early life devoted himself to the restoration of the works of the ancient geometers, he studied them with unremitting attention; and, retiring from the promiscuous intercourse of the world, he contented himself with a small society of intimate friends, with whom he could lay aside every restraint of ceremony or reserve, and indulge in all the innocent frivolities of life. Every Friday evening was spent in a party at whist, in which he excelled, and took delight in instructing others, till increasing years made him less patient with the dulness of a scholar. The card-party was followed by an hour or two dedicated solely to playful conversation. In like manner, every Saturday he had a less select party to dinner at a house about a mile from town. The Doctor's long life gave him occasion to see the *dramatis persona* of this little theatre several times completely changed, while he continued to give it a personal identity: so that, without any design or wish of his own, it became, as it were, his own house and his own family, and went by his name. In this state did the present writer first see it, with Dr Simfon as its father and head, respected and beloved by every branch; for, as it was for relaxation, and not for the enjoyment of his acknowledged superiority, that he continued this habit of his early youth; and as his notions "of a fine talk" did not consist in the pleasure of having "tossed and gored a good many to-day," his companions were as much at their ease as he wished to be himself; and it was no small part of their entertainment (and of his too), to smile at those innocent deviations from common forms, and those mistakes with respect to life and manners, which an almost total retirement from the world, and incessant occupation in an abstract science, caused this venerable president frequently to exhibit. These are remembered with a more affecting regret, that they are now "with the days that are past," than the most pithy apophthegms, uttered in with an emphatical, "Why, Sir!" or "No, Sir!" which precludes all reply. Dr Simfon never exerted his presidial authority, unless it were to check some infringement of good breeding, or any thing that appeared unfriendly to religion or purity of manners; for these he had the highest reverence. We have twice heard him sing (he had a fine voice and most accurate ear) some lines of a Latin hymn to the divine geometer, and each time the rapturous tear stood in his eye.

But we ask the reader's pardon for this digression; it is not however useless, since it paints the man as much as any recital of his studies; and to his acquaintances we are certain that it will be an acceptable memorandum. To them it was often matter of regret, that a person of such eminent talents, which would have made him shine equally in any line of life, should have allowed himself to be so completely devoted to a study which abstracted him from the ordinary pursuits of men, unfitted him for the active enjoyment of life, and kept him out of those walks which they frequented, and where they would have rejoiced to meet him.

Dr Simfon was of an advantageous stature, with a fine countenance; and even in his old age had a graceful carriage and manner, and always, except when in mourning, dressed in white cloth. He was of a cheerful disposition; and though he did not make the first advances

advances to acquaintance, had the most affable manner, and strangers were at perfect ease in his company. He enjoyed a long course of uninterrupted health; but towards the close of life suffered from an acute disease, and was obliged to employ an assistant in his professional labours for a few years preceding his death, which happened in 1768, at the age of 81. He left to the university his valuable library, which is now arranged apart from the rest of the books, and the public use of it is limited by particular rules. It is considered as the most choice collection of mathematical books and manuscripts in the kingdom, and many of them are rendered doubly valuable by Dr Simson's notes.

SIN, a breach or transgression of some divine law or command.

SINAI, or SINA, a famous mountain of Arabia Petraea, upon which God gave the law to Moses. It stands in a kind of peninsula, formed by the two arms of the Red Sea, one of which stretches out towards the north, and is called the *Gulph of Kolsum*; the other extends towards the east, and is called the *Gulph of Elan*, or the *Elariff Sea*. At this day the Arabians call Mount Sinai by the name of *Tor*, that is, the "mountain," by way of excellence; or *Gibel* or *Jibel Moufa*, "the mountain of Moses." It is 260 miles from Cairo, and generally it requires a journey of ten days to travel thither. The wilderness of Sinai, where the Israelites continued incamped for almost a year, and where Moses erected the tabernacle of the covenant, is considerably elevated above the rest of the country; and the ascent to it is by a very craggy way, the greatest part of which is cut out of the rock; then one comes to a large space of ground, which is a plain surrounded on all sides by rocks and eminences, whose length is nearly 12 miles. Towards the extremity of this plain, on the north side, two high mountains show themselves, the highest of which is called *Sinai* and the other *Horeb*. The tops of Horeb and Sinai have a very steep ascent, and do not stand upon much ground, in comparison to their extraordinary height: that of Sinai is at least one-third part higher than the other, and its ascent is more upright and difficult.

Two German miles and a half up the mountain stands the convent of St Catharine. The body of this monastery is a building 120 feet in length and almost as many in breadth. Before it stands another small building, in which is the only gate of the convent, which remains always shut, except when the bishop is here. At other times, whatever is introduced within the convent, whether men or provisions, is drawn up by the roof in a basket, and with a cord and a pulley. The whole building is of hewn stone; which, in such a desert, must have cost prodigious expence and pains. Near this chapel issues a fountain of very good fresh water; it is looked upon as miraculous by some who cannot conceive how water can flow from the brow of so high and barren a mountain. Five or six paces from it they show a stone, the height of which is four or five feet, and breadth about three, which, they say, is the very stone whence Moses caused the water to gush out. Its colour is of a spotted grey, and it is as it were set in a kind of earth, where no other rock appears. This stone has 12 holes or channels, which are about a foot wide, whence it is thought the water came forth for the Israelites to drink.

Much has been said of the writings to be seen at Sinai and in the plain about it; and such were the hopes of discoveries respecting the wanderings of the Israelites from these writings, that Dr Clayton bishop of Clogher offered L. 500 Sterling to defray the expences of journey to any man of letters who would undertake to copy them. No man, we believe, undertook this task: and the accurate Danish traveller Niebuhr found no writings there but the names of persons who had visited the place from curiosity, and of Egyptians who had chosen to be buried in that region.

SINAPIS, MUSTARD, in botany: A genus of plants belonging to the class of *tetradynamia*, and to the order of *siliquosa*; and in the natural system ranged under the 39th order, *Siliquosa*. The calyx consists of four expanding strap-shaped deciduous leaves; the unguis or bases of the petals are straight; two glandules between the shorter stamina and pistillum, also between the longer and the calyx. There are 17 species; the *arvensis*, *orientalis*, *brassicata*, *alba*, *nigra*, *pyrenaica*, *pubescens*, *chinensis*, *juncea*, *erucoides*, *allioni*, *hispanica*, *milifolia*, *incana*, *laevigata*, *cernua*, and *japonica*. Three of these are natives of Britain; the *alba*, *nigra*, and *arvensis*.

1. The *alba*, or white mustard, which is generally cultivated as a salad herb for winter and spring use. This rises with a branched hairy stalk two feet high; the leaves are deeply jagged on their edges and rough. The flowers are disposed in loose spikes at the end of the branches, standing upon horizontal footstalks; they have four yellow petals in form of a cross, which are succeeded by hairy pods, that end with long, compressed, oblique beaks; the pods generally contain four white seeds.

2. The *nigra*, or common mustard, which is frequently found growing naturally in many parts of Britain, but is also cultivated in fields for the seed, of which the sauce called *mustard* is made. This rises with a branching stalk four or five feet high; the lower leaves are large, rough, and very like those of turnip; the upper leaves are smaller and less jagged. The flowers are small, yellow, and grow in spiked clusters at the end of the branches; they have four petals placed in form of a cross, and are succeeded by smooth four-cornered pods.

3. The *arvensis*, grows naturally on arable land in many parts of Britain. The seed of this is commonly sold under the title of *Durham mustard-seed*. Of this there are two varieties, if not distinct species; the one with cut, the other with entire leaves. The stalks rise two feet high; the leaves are rough; in the one they are jagged like turnip-leaves; in the other they are long and entire. The flowers are yellow; the pods are turgid, angular, and have long beaks.

Mustard, by its acrimony and pungency, stimulates the solids, and attenuates viscid juices; and hence stands deservedly recommended for exciting appetite, assisting digestion, promoting the fluid secretions, and for the other purposes of the acrid plants called *antiscorbutic*. It imparts its taste and smell in perfection to aqueous liquors, and by distillation with water yields an essential oil of great acrimony. To rectified spirit its seeds give out very little either of their smell or taste. Subjected to the press, they yield a considerable quantity of mild insipid oil, which is as free from acrimony as that

Sinapism  
||  
Sindy.

of almonds. They are applied as an external stimulant to benumbed or paralytic limbs; to parts affected with fixed rheumatic pains; and to the soles of the feet, in the low stage of acute diseases, for raising the pulse: in this intention, a mixture of equal parts of the powdered seeds and crumb of bread, with the addition sometimes of a little bruised garlic, are made into a cataplasm with a sufficient quantity of vinegar.

SINAPISM, in pharmacy, an external medicine, in form of a cataplasm, composed chiefly of mustard-seed pulverized, and other ingredients mentioned in the preceding article.

SINCERITY, honesty of intention, freedom from hypocrisy. See MORAL PHILOSOPHY, n<sup>o</sup> 157.

SINCIPUT, in anatomy, the forepart of the head, reaching from the forehead to the coronal suture.

SINDY, a province of Hindostan Proper, bounded on the west by Makran, a province of Persia; on the north by the territories of the king of Candahar; on the north-east by those of the Seiks; on the east by a sandy desert; and on the south-east by Cutch. It extends along the course of the river Sindy or Indus from its mouth to Behker or Bhakor, on the frontiers of Moultan. Reckoned that way, it is 300 miles long; and its breadth, in its widest part, is about 160. In many particulars of soil and climate, and in the general appearance of the surface, Sindy resembles Egypt; the lower part of it being composed of rich vegetable mould, and extended into a wide dell; while the upper part of it is a narrow slip of country, confined on one side by a ridge of mountains, and on the other by a sandy desert, the river Indus, equal at least to the Nile, winding through the midst of this level valley, and annually overflowing it. During great part of the south-west monsoon, or at least in the months of July, August, and part of September, which is the rainy season in most other parts of India, the atmosphere is here generally clouded; but no rain falls except very near the sea. Indeed, very few showers fall during the whole year; owing to which, and the neighbourhood of the sandy deserts, which bound it on the east and on the north-west, the heats are so violent, and the winds from those quarters so pernicious, that the houses are contrived so as to be occasionally ventilated by means of apertures on the tops of them, resembling the funnels of small chimneys. When the hot winds prevail, the windows are closely shut; and the lowest part of the current of air, which is always the hottest, being thus excluded, a cooler, because more elevated, part descends into the house through the funnels. By this contrivance also vast clouds of dust are excluded; the entrance of which would alone be sufficient to render the houses uninhabitable. The roofs are composed of thick layers of earth instead of terraces. Few countries are more unwholesome to European constitutions, particularly the lower part of the Delta. The prince of this province is a Mahometan, tributary to the king of Candahar. He resides at Hyderabad, although Tatta is the capital. The Hindoos, who were the original inhabitants of Sindy, are by their Mahometan governors treated with great rigour, and denied the public exercise of their religion; and this severity drives vast numbers of them into other countries. The inland parts of Sindy produce saltpetre, sal-ammoniac, borax, bezoar, lapis la-

zuli, and raw silk. They have also manufactories of cotton and silk of various kinds; and they make fine cabinets, inlaid with ivory, and finely lackered. They also export great quantities of butter, clarified and wrapt up in duppas, made of the hides of cattle. The ladies wear hoops of ivory on both their arms and legs, which when they die are burnt with them. They have large black cattle, excellent mutton, and small hardy horses. Their wild game are deer, hares, antelopes, and foxes, which they hunt with dogs, leopards, and a small fierce creature called a shialguth.

SINE, or *Right Sine of an Arch*, in trigonometry, is a right line drawn from one end of that arch, perpendicular to the radius drawn to the other end of the arch; being always equal to half the cord of twice the arch. See TRIGONOMETRY and GEOMETRY.

SINECURE, a nominal office, which has a revenue without any employment.

SINEW, a tendon, that which unites the muscles to the bones.

SINGING, the action of making divers inflections of the voice, agreeable to the ear, and correspondent to the notes of a song or piece of melody. See MELODY.

The first thing to be done in learning to sing, is to raise a scale of notes by tones and semitones to an octave, and descend by the same notes; and then to rise and fall by greater intervals, as a third, fourth, fifth, &c. and to do all this by notes of different pitch. Then these notes are represented by lines and spaces, to which the syllables *fa, sol, la, mi*, are applied, and the pupil taught to name each line and space thereby; whence this practice is called *sol-fa'ing*, the nature, reason, effects, &c. whereof, see under the article SOLFAING.

*SINGING of Birds.* It is worthy of observation, that the female of no species of birds ever sings: with birds it is the reverse of what occurs in human kind. Among the feathered tribe, all the cares of life fall to the lot of the tender sex; theirs is the fatigue of incubation; and the principal share in nursing the helpless brood: to alleviate these fatigues, and to support her under them, nature hath given to the male the song, with all the little blandishments and soothing arts; these he fondly exerts (even after courtship) on some spray contiguous to the nest, during the time his mate is performing her parental duties. But that she should be silent is also another wise provision of nature, for her song would discover her nest; as would a gaudiness of plumage, which, for the same reason, seems to have been denied her.

On the song of birds several curious experiments and observations have been made by the Hon. Daines Barrington. See *Phil. Transf.* vol. lxxiii.

SINGULAR NUMBER, in grammar, that number of nouns and verbs which stands opposed to plural. See GRAMMAR, n<sup>o</sup> 14.

SINISTER, something on or towards the left hand. Hence some derive the word *sinister*, à *sinendo*; because the gods, by such auguries, permit us to proceed in our designs.

SINISTER, is ordinarily used among us for unlucky; though, in the sacred rites of divination, the Romans used it in an opposite sense. Thus *avis sinistra*, or a bird on the left hand, was esteemed a happy omen: whence,

Sine  
||  
Sinister

in the law of the 12 tables, *Ave sinistra populi magister esto.*

**SINISTER**, in heraldry. The sinister side of an escutcheon is the left-hand side; the sinister chief, the left angle of the chief; the sinister base, the left-hand part of the base.

**SINISTER Aspect**, among astrologers, is an appearance of two planets happening according to the succession of the signs; as Saturn in Aries, and Mars in the same degree of Gemini.

**SINISTRARI**, a sect of ancient heretics, thus called because they held the left hand in abhorrence, and made it a point of religion not to receive any thing therewith.

**SINKING FUND**, a provision made by parliament, consisting of the surplusage of other funds, intended to be appropriated to the payment of the national debt; on the credit of which very large sums have been borrowed for public uses. See *NATIONAL Debt* and *REVENUE*.

**SINOPICA TERRA**, in natural history, the name of a red earth of the ochre kind, called also *rubrica sinopica*, and by some authors *sinopsis*. It is a very close, compact, and weighty earth, of a fine glowing purple colour. It is of a pure texture, but not very hard, and of an even but dusty surface. It adheres firmly to the tongue, is perfectly fine and smooth to the touch, does not crumble easily between the fingers, and stains the hands. It melts very slowly in the mouth, is perfectly pure and fine, of an austere astringent taste, and ferments violently with aquafortis. It was dug in Cappadocia, and carried for sale to a city in the neighbourhood called *Sinope*, whence it had its name. It is now found in plenty in the New Jerseys in America, and is called by the people there *bloodstone*. Its fine texture and body, with its high florid colour, must make it very valuable to painters; and from its astringency it will probably be a powerful medicine.

**SINOPLÉ**, in heraldry, denotes vert, or green colour in armories.—*Sinople* is used to signify love, youth, beauty, rejoicing, and liberty; whence it is that letters of grace, ambition, legitimation, &c. are always sealed with green wax.

**SINUOSITY**, a series of bends and turns in arches or other irregular figures, sometimes jutting out and sometimes falling in.

**SINUS**, in anatomy, denotes a cavity in certain bones and other parts, the entrance whereof is very narrow, and the bottom wider and more spacious.

**SINUS**, in surgery, a little cavity or sacculus, frequently formed by a wound or ulcer, wherein pus is collected.

**SIPHON**. See *HYDROSTATICS*, n° 25.

**SIPHONANTHUS**, in botany; a genus of plants belonging to the class of *tetrandria* and order of *monogynia*. The corolla is monopetalous, funnel-shaped; the tube is very narrow, and much longer than the calyx. There are four berries, each containing one seed. There is only one species, the *indica*.

**SIPONTUM**, **SEPUNTUM**, or **SIVUS** (anc. geog.), a town of Apulia, so denominated (according to Strabo) from the great quantity of *sepie* or cuttlefish that are thrown upon the coast. Diomed is supposed by the same author to have been the founder of this place;

which appears from Livy to have become a colony of Roman citizens. In the early ages of Christian hierarchy, a bishop was fixed in this church; but, under the Lombards, his see was united to that of Beneventum. Being again separated, Sipontum became an archiepiscopal diocese in 1094, about which time it was so ill treated by the Barbarians, that it never recovered its splendour, but sunk into such misery, that in 1260 it was a mere desert, from the want of inhabitants, the decay of commerce, and the insalubrity of the air. Manifestly having taken these circumstances into consideration, began in 1261 to build a new city on the sea-shore, to which he removed the few remaining Sipontines. (See the article *MANFREDONIA*). Sipontum was situated at the distance of a mile from the shore. Excepting a part of its Gothic cathedral, scarce one stone of the ancient city now remains upon another.

**SIPUNCULUS**, in natural history, a genus of the *intestina* class of worms in the Linnæan system. Its characters are these: the body is round and elongated; the mouth attenuated and cylindrical; and the lateral aperture of the body rugged. There are two species; one found under stones in the European, and the other in the Indian ocean.

**SIR**, the title of a knight or baronet, which, for distinction's sake, as it is now given indiscriminately to all men, is always prefixed to the knight's Christian name, either in speaking or writing to them.

**SIRCAR**, any office under the government in Hindoostan. It is sometimes used for the state of government itself. Likewise a province, or any number of Pergunnahs placed under one head in the government books, for conveniency in keeping accounts. In common usage in Bengal, the under banyans of European gentleman are called *sircars*.

**SIRE**, a title of honour formerly given to the king of France as a mark of sovereignty.

**SIRE**, was likewise anciently used in the same sense with *seur* and *seigneur*, and applied to barons, gentlemen, and citizens.

**SIRENS**, in fabulous history, certain celebrated songstresses who were ranked among the demigods of antiquity. Hyginus places their birth among the consequences of the rape of Proserpine. Others make them daughters of the river Achelotis and one of the muses\*. The number of the Sirens was three; and their names were *Parthenope*, *Lygea*, and *Leucosia*. Some make them half women and half fish; others, half women and half birds. There are antique representations of them still subsisting under both these forms. Pausanias tells us, that the Sirens, by the persuasion of Juno, challenged the Muses to a trial of skill in singing; and these having vanquished them, plucked the golden feathers from the wings of the Sirens, and formed them into crowns, with which they adorned their own heads. The Argonauts are said to have been diverted from the enchantment of their songs by the superior strains of Orpheus: Ulysses, however, had great difficulty in securing himself from seduction. See *Olyf.* lib. xii.

Pope, in his notes to the twelfth book of the *Odyssey*, observes, the critics have greatly laboured to explain what was the foundation of this fiction of the Sirens. We are told by some, that the Sirens were queens of certain small islands named *Sirenuse*, that lie near Ca-

Sipunculus  
||  
Sirens.

Sirens,  
Siren.

præa in Italy, and chiefly inhabited the promontory of Minerva, upon the top of which that goddess had a temple, as some affirm, built by Ulysses. Here there was a renowned academy, in the reign of the Sirens, famous for eloquence and the liberal sciences, which gave occasion to the invention of this fable of the sweetness of the voice and attracting songs of the Sirens. But why then are they fabled to be destroyers, and painted in such dreadful colours? We are told, that at last the students abused their knowledge, to the colouring of wrong, the corruption of manners, and the subversion of government: that is, in the language of poetry, they were feigned to be transformed into monsters, and with their music to have enticed passengers to their ruin, who there consumed their patrimonies, and poisoned their virtues with riot and effeminacy. The place is now called *Maffa*. Some writers tell us of a certain bay, contracted within winding straits and broken cliffs, which, by the singing of the winds and beating of the waters, returns a delightful harmony, that allures the passenger to approach, who is immediately thrown against the rocks, and swallowed up by the violent eddies. Thus Horace, moralising, calls idleness a *Siren*.

—*Vitanda est improba Siren  
Desidia.*—

But the fable may be applied to all pleasures in general, which, if too eagerly pursued, betray the incautious into ruin; while wise men, like Ulysses, making use of their reason, stop their ears against their insinuations.

The learned Mr Bryant says, that the Sirens were Cuthite and Canaanitish priests, who had founded temples in Sicily, which were rendered infamous on account of the women who officiated. They were much addicted to cruel rites, so that the shores upon which they resided are described as covered with the bones of men destroyed by their artifice. *Virgil. Æneid. lib. v. v. 864.*

All ancient authors agree in telling us, that Sirens inhabited the coast of Sicily. The name, according to Bochart, who derives it from the Phœnician language, implies a songstress. Hence it is probable, says Dr Burney, that in ancient times there may have been excellent singers, but of corrupt morals, on the coast of Sicily, who, by seducing voyagers, gave rise to this fable. And if this conjecture be well founded, he observes, the Muses are not the only pagan divinities who preserved their influence over mankind in modern times; for every age has its Sirens, and every Siren her votaries; when beauty and talents, both powerful in themselves, are united, they become still more attractive.

SIREN, in zoology, a genus of animals belonging to the class of *amphibia* and the order of *meantes*. It is a biped, naked, and furnished with a tail; the feet are brachiated with claws. This animal was discovered by Dr Garden in Carolina; it is found in swampy and muddy places, by the sides of pools, under the trunks of old trees that hang over the water. The natives call it by the name of *mud-ingwana*. Linnæus first apprehended, that it was the larva of a kind of lizard; but as its fingers are furnished with claws, and it makes a croaking noise, he concluded from these properties, as

well as from the situation of the anus, that it could not be the larva of the lizard, and therefore formed of it a new genus under the name of *siren*. He was also obliged to establish for this uncommon animal a new order called *meantes* or *gliders*: the animals of which are amphibious, breathing by means of gills and lungs, and furnished with arms and claws.

SIREX, in zoology, a genus of animals belonging to the class of *insecta*, and to the order of *hymenoptera*. The mouth has two strong jaws; there are two truncated palpi or feelers, filiform antennæ, an exerted, stiff, serrated tongue, a sessile, mucronated abdomen, and lanceolated wings. There are seven species.

SIRIUM, in botany; a genus of plants belonging to the class of *tetrاندria* and order of *monogynia*. The calyx is quadrifid; there is no corolla; the nectarium is quadripheylous and crowning the throat of the calyx; the germen is below the corolla; the stigma is triid, and the berry trilocular. There is only one species, the myrtifolium.

SIRIUS, in astronomy, a bright star in the constellation Canis. See ASTRONOMY, n<sup>o</sup> 403, &c.

SIRLET (Flavius), an eminent Roman engraver on precious stones: his Laocœon, and representations in miniature of antique statues at Rome, are very valuable and scarce. He died in 1737.

SIROCCO, a periodical wind which generally blows in Italy and Dalmatia every year about Easter. It blows from the south-east by south: it is attended with heat, but not rain; its ordinary period is twenty days, and it usually ceases at sunset. When the scirocco does not blow in this manner, the summer is almost free from westerly winds, whirlwinds, and storms. This wind is prejudicial to plants, drying and burning up the buds; though it hurts not men any otherwise than by causing an extraordinary weakness and lassitude; inconveniences that are fully compensated by a plentiful fishing, and a good crop of corn on the mountains. In the summer time, when the westerly wind ceases for a day, it is a sign that the scirocco will blow the day following, which usually begins with a sort of whirlwind.

SISKIN. See FRINGILLA.

SISON, BASTARD-STONE PARSLEY, in botany: A genus of plants belonging to the class of *pentandria*, and to the order of *digynia*; and in the natural system arranged under the 45th order, *umbellata*. The fruit is egg-shaped and streaked; the involuera are subtetraphyllous. There are seven species; the *amonum*, *inundatum*, *sergetum*, *verticillatum*, *salsum*, *canadense*, and *ammi*. The four first are natives of Great Britain.

1. The *amonum*, common bastard parsley, or field stonewort, is a biennial plant about three feet high, growing wild in many places of Britain. Its seeds are small, striated, of an oval figure and brown colour. Their taste is warm and aromatic. Their whole flavour is extracted by spirit of wine, which elevates very little of it in distillation; and hence the spirituous extract has the flavour in great perfection, while the watery extract has very little. A tincture drawn with pure spirit is of a green colour. The seeds have been esteemed aperient, diuretic, and carminative; but are little regarded in the present practice. 2. The *inundatum*, least water-parsnep. The stem is about eight or ten inches high, branched,

Sirex  
||  
SifonPhil. Tr. 1777  
vol. lvi.  
p. 489.



*Scrum*, and creeping: the leaves, below the water, are capillary; above it are pinnated: the umbels are bifid. It grows in ditches and ponds. 3. *Segetum*, corn parley, or honeywort. The stems are numerous, slender, striated, branched, and leaning; the leaves are pinnated; the pinnae are oval, pointed, and serrated, six or eight pair, and one at the end; the umbels small and drooping; the flowers minute and white. It grows in corn-fields and hedges. 4. *Verticillatum*, verticillate fison, has small leaves in whirls, and capillary; the stem is two feet, with few leaves; the common umbel is composed of 8 or 10 rays, the partial of 18 or 20; both involucre are composed of five or six oval acute foliola; the flowers are all hermaphrodite, and the petals white.

**SISTRUM**, or **CISTRUM**, a kind of ancient musical instrument used by the priests of Isis and Osiris. It is described by Spon as of an oval form, in manner of a racket, with three sticks traversing it breadthwise; which playing freely by the agitation of the whole instrument, yielded a kind of sound which to them seemed melodious. Mr Malcolm takes the sistrum to be no better than a kind of rattle. Oiselius observes, that the sistrum is found represented on several medals, and on talismans.

**SISYMBRIUM**, **WATER-CRESSES**, in botany: A genus of plants belonging to the class of *tetradynamia*, and to the order of *siliquosa*; and in the natural system ranged under the 39th order, *Siliquosa*. The siliqua, or pod, opens with valves somewhat straight. The calyx and corolla are expanded. There are 29 species, of which eight are natives of Britain; the nasturtium, or common water-cress; sylvestre, water-rocket; amphibium, water-radish; terrestre, annual water-radish; monense; sophia, slixweed; irio, broad-leaved hedge-mustard.

1. The nasturtium grows on the brinks of rivulets and water ditches. The leaves have from 6 to 8 pair of smooth succulent and sessile pinnae: the flowers are small and white, and grow in short spikes or tufts. The leaves of water-cresses have a moderately pungent taste, emit a quick penetrating smell, like that of mustard seed, but much weaker. Their pungent matter is taken up both by watery and spirituous menstrua, and accompanies the aqueous juice, which issues copiously upon expression. It is very volatile, so as to arise in great part in distillation with rectified spirit, as well as with water, and almost totally to exhale in drying the leaves, or inspissating by the gentlest heat to the consistence of an extract, either the expressed juice, or the watery or spirituous tinctures. Both the inspissated juice, and the watery extract, discover to the taste a saline impregnation, and in keeping throw up crystalline efflorescences to the surface. On distilling considerable quantities of the herb with water, a small proportion of a subtile volatile very pungent oil is obtained.

Water-cresses obtain a place in the *Materia Medica* for their antiscorbutic qualities, which have been long very generally acknowledged by physicians. They are also supposed to purify the blood and humours, and to open visceral obstructions. They are nearly allied to scurvy-grass, but are more mild and pleasant, and for this reason are frequently eaten as salad. In the pharmacopias the juice of this plant is directed with that of scurvy-grass and Seville oranges: and Dr Cullen has remarked, that the addition of acids renders the juices of

VOL. XVII. Part II.

the plants siliquose more certainly effectual, by determining them more powerfully to an acetent fermentation.

2. Sylvestre, or water-rocket. The stem is weak, branched, and above a foot high. The leaves are pinnated; the pinnae lance-shaped, and serrated; the flowers small, and yellow; and grow frequently in shallow water.

3. Amphibium, or water-radish. The stem is firm, erect, and two or three feet high; the leaves are pinnatifid, and serrated; the flowers are yellow, and in spikes; the pods are somewhat oval, and short. It grows in water.

4. Terrestre, or land-rocket. The leaves are pinnatifid; the pods are filled with seed; the root is annual, and white; the stem is angular, red-green, and smooth.

5. Murale, or wall-rocket. The stems are rough, and about eight inches high; the leaves grow on foot-stalks, lance-shaped, smooth, sinuated, and serrated; the flowers are yellow; the pods a little compressed, and slightly carinated. It grows on sandy ground in the North, Anglesea, &c.

6. Monense, or yellow rocket. The stem is smooth, and about 6 or 8 inches high; the leaves are pinnatifid; the pinnae remote, generally 7 pair; the flower is yellow; the petals entire; the calyx is closed. It grows in the Isle of Man.

7. Irio, broad leaved rocket, or hedge mustard; the stem is smooth, and about two feet high; the leaves are broad, naked, pinnated, and halberd shaped at the end; the flowers are yellow, and the pods erect. It grows on waste ground.

8. Sophia, slixweed. The stem is firm, branched, and two or three feet high; the leaves are multifid; the segments are narrow; the flowers are yellow; the petals much less than the calyx; the pods are long, stiff, curved, without style, and erect; the seeds are minute, and yellow. It grows on walls, waste ground, &c.

**SISYPHUS**, in fabulous history, one of the descendants of Eolus, married Merope, one of the Pleiades, who bore him Glaucus. He resided at Epyra in Peloponnesus, and was a very crafty man. Others say, that he was a Trojan secretary, who was punished for discovering secrets of state; and others again, that he was a notorious robber, killed by Theseus. However, all the poets agree that he was punished in Tartarus for his crimes, by rolling a great stone to the top of a hill, which constantly recoiled, and, rolling down incessantly, renewed his labour.

**SISYRINCHIUM**, in botany: A genus of plants belonging to the class of *gynandria*, and order of *trian-dria*; and in the natural system ranged under the 6th order, *Ensatæ*. The spathe is diphyllous; there are 6 plane petals. The capsule is trilocular and inferior.— There are two species, the bermudianæ and palmifolium.

**SITE**, denotes the situation of an house, &c. and sometimes the ground-plot or spot of earth it stands on.

**SITTA NUTHATCH**, in ornithology: A genus belonging to the class of *aves*, and order of *picæ*. It is thus characterized by Dr Latham. The bill is for the most part straight; on the lower mandible there is a small angle; nostrils small, covered with bristles reflected over them; tongue short, horny at the end, and jagged; toes placed three forward and one backward;

3 T

the

Sisymbrium  
||  
Sista.

Berkhout's  
Synopsis of  
Natural  
History.

Latham's  
Ornithology,  
vol. ii.  
P. 647, &c.

Siva  
||  
Siva.

the middle toe joined closely at the base to both the outmost; back toe as large as the middle one.— There are 11 species: the europæa, canadensis, carolinensis, jamaicensis, pusilla, major, nævia, furinamentis, castra, longirostris, and chloris. The europæa, or nut-hatch, is in length near five inches three-quarters, in breadth nine inches; the bill is strong and straight, about three-quarters of an inch long; the upper mandible black, the lower white: the irides are hazel; the crown of the head, back, and coverts of the wings, of a fine bluish grey; a black stroke passes over the eye from the mouth: the cheeks and chin are white; the breast and belly of a dull orange-colour; the quill-feathers dusky; the wings underneath are marked with two spots, one white at the root of the exterior quills, the other black at the joint of the ballard wing; the tail consists of twelve feathers; the two middle are grey, the two exterior feathers tipped with grey; then succeeds a transverse white spot; beneath that the rest is black: the legs are of a pale yellow; the back toe very strong, and the claws large. The female is like the male, but less in size, and weighs commonly 5 or at most 6 drams. The eggs are six or seven in number, of a dirty white, dotted with rufous; these are deposited in some hole of a tree, frequently one which has been deserted by a woodpecker, on the rotten wood mixed with a little moss, &c. If the entrance be too large, the bird nicely stops up part of it with clay, leaving only a small hole for itself to pass in and out by. While the hen is sitting, if any one puts a bit of stick into the hole, she hisses like a snake, and is so attached to her eggs, that she will sooner suffer any one to pluck off her feathers than fly away. During the time of incubation, the male supplies her with sustenance, with all the tenderness of an affectionate mate.

The bird runs up and down the bodies of trees, like the woodpecker tribe; and feeds not only on insects, but nuts, of which it lays up a considerable provision in the hollows of trees. “It is a pretty sight, says Mr Willoughby, to see her fetch a nut out of her hoard, place it fast in a chink, and then, standing above it with its head downwards, striking it with all its force, break the shell, and catch up the kernel. It is supposed not to sleep perched on a twig like other birds; for when confined in a cage, it prefers sleeping in a hole or corner. When at rest it keeps the head down. In autumn it begins to make a chattering noise, being silent for the greatest part of the year.” Dr Plott tells us, that this bird, by putting its bill into a crack in the bough of a tree, can make such a violent sound as if it was rending asunder, so that the noise may be heard at least twelve score yards.

**SITOPHYLAX**, Σιτοφυλαξ, formed from σιτος “corn,” and φυλαξ, “keeper,” in antiquity, an Athenian magistrate, who had the superintendance of the corn, and was to take care that nobody bought more than was necessary for the provision of his family. By the Attic laws, particular persons were prohibited from buying more than fifty measures of wheat a man; and that such persons might not purchase more, the sitophylax was appointed to see the laws properly executed. It was a capital crime to prevaricate in it. There were 15 of these *sitophylaces*, ten for the city, and five for the Piræus.

**SIVA**, a name given by the Hindoos to the Supreme

Being, when considered as the avenger or destroyer. Sir William Jones has shown that in several respects the character of Jupiter and Siva are the same. As Jupiter overthrew the Titans and giants, so did Siva overthrow the Daityas, or children of Diti, who frequently rebelled against Heaven; and as during the contest the god of Olympus was furnished with lightning and thunderbolts by an eagle, so Brahma, who is sometimes represented riding on the Garuda, or eagle, pretended the god of destruction with fiery shafts. Siva also corresponds with the Stygian Jove, or Pluto; for, if we can rely on a Persian translation of the Bhâgavat, the sovereign of Pâtâla, or the infernal regions, is the king of serpents, named *Seshumara*, who is exhibited in painting and sculpture, with a diadem and sceptre, in the same manner as Pluto. There is yet another attribute of Siva, or Mahâdêva, by which he is visibly distinguished in the drawings and temples of Bengal. To destroy, according to the Vedantis of India, the Sufis of Persia, and many philosophers of our European schools, is only to generate and reproduce in another form. Hence the god of destruction is holden in this country to preside over generation, as a symbol of which he rides on a white bull. Can we doubt that the loves and seats of Jupiter Genitor (not forgetting the white bull of Europa), and his extraordinary title of Lapis, for which no satisfactory reason is commonly given, have a connection with the Indian philosophy and mythology?

**SIUM**, WATER PARSNEP, in botany: A genus of plants belonging to the class of *pentandria*, and order of *digynia*, and in the natural system ranging under the 45th order, *Umbellata*. The fruit is a little ovated, and streaked. The involucrem is polyphyllous, and the petals are heart-shaped. There are 12 species; the latifolium, angustifolium, nodiflorum, sifarum, ninsî, rigidius, japonicum, salsarica, græcum, siculum, repens, and decumbens. The three first are natives of Britain. 1. The *latifolium*, or great water-parsnep, which grows spontaneously in many places both of England and Scotland on the sides of lakes, ponds, and rivulets. The stalk is erect and furrowed, a yard high or more. The leaves are pinnated with three or four pair of large elliptic pinnæ, with an odd one at the end, all serrated on the edges. The stalk and branches are terminated with erect umbels, which is the chief characteristic of the species. Cattle are said to have run mad by feeding upon this plant. 2. The *angustifolium*, or narrow-leaved water-parsnep, has pinnated leaves; the axillary umbels are pedunculated, and the general involucrem is pinnatifid. It grows in ditches and rivulets, but is not common. 3. The *nodiflorum*, reclining water-parsnep, has pinnated leaves, but the axillary umbels are sessile. It grows on the sides of rivulets.

The *sium sifarum*, or skirret, is a native of China, but has been for a long time cultivated in Europe, and particularly in Germany. The root is a bunch of fleshy fibres, each of which is about as thick as a finger, but very uneven, covered with a whitish rough bark, and has a hard core or pith running thro' the centre. From the crown of this bunch come several winged leaves, consisting of two or three pair of oblong dentated lobes each, and terminated by an odd one. The stalk rises to about two feet, is set with leaves at the joints, and breaks into branches towards the top, each terminating with an umbel of small white flowers, which are succeeded by striated seeds

Siva  
Sium  
Asiatic  
seeds.

feeds like those of parsley. Skirrets come nearest to parsneps of any of the ciculent roots, both for flavour and nutritive qualities. They are rather sweeter than the parsnep, and therefore to some few palates are not altogether so agreeable.

Mr Margraaf extracted from  $\frac{1}{2}$  lb. of skirret root 1 $\frac{1}{2}$  ounces of pure sugar.

SIX-CLERKS, officers in chancery of great account, next in degree below the twelve masters, whose business is to enrol commissions, pardons, patents, warrants, &c. which pass the great seal, and to transact and file all proceedings by bill, answer, &c. They were anciently *clerici*, and forfeited their places, if they married; but when the constitution of the court began to alter, a law was made to permit them to marry. Stat. 14. and 15. Hen. VIII. cap. 8. They are also solicitors for parties in suits depending in the court of chancery. Under them are 6 deputies and 60 clerks, who, with the under clerks, do the business of the office.

SIX NATIONS. See NIAGARA.

SIXTH, in music, one of the simple original concords, or harmonic intervals. See INTERVAL.

SIXTUS V. (Pope), was born the 13th December 1521, in La Marca, a village in the seignory of Montalto. His father, Francis Peretti, was a gardener, and his mother a servant maid. He was their eldest child, and was called Felix. At the age of nine he was hired out to an inhabitant of the village to keep sheep; but disobliging his master, he was soon after degraded to be keeper of the hogs. He was engaged in this employment when Father Michael Angelo Selli, a Franciscan friar, asked the road to Ascoli, where he was going to preach. Young Felix conducted him thither, and struck the father so much with his conversation and eagerness for knowledge, that he recommended him to the fraternity to which he had come. Accordingly he was received among them, invested with the habit of a lay brother, and placed under the sacristan, to assist in sweeping the church, lighting the candles, and other offices of that nature; for which he was to be taught the responses, and the rudiments of grammar. His progress in learning was so surprising, that at the age of 14 he was thought qualified to begin his novitiate, and was admitted the year following to make his profession.

He pursued his studies with such unwearyed assiduity, that he was soon reckoned equal to the best disputants. He was ordained priest in 1545, when he assumed the name of Father Montalto; soon after he took his doctor's degree, and was appointed professor of theology at Sienna. It was then that he so effectually recommended himself to Cardinal di Carpi, and his secretary Bossius, that they ever remained his steady friends. Meanwhile the severity and obstinacy of his temper incessantly engaged him in disputes with his monastic brethren. His reputation for eloquence, which was now spread over Italy, about this time gained him some new friends. Among these were the Colonna family, and Father Ghislieri, by whose recommendation he was appointed inquisitor-general at Venice; but he exercised that office with so much severity, that he was obliged to flee precipitately from that city. Upon this he went to Rome, where he was made procurator-general of his order, and soon after accompanied Cardinal Buon Compagnon into Spain, as a

chaplain and confessor to the inquisition. There he was treated with great respect, and liberal offers were made him to induce him to continue in Spain, which, however, he could not be prevailed on to accept.

In the mean time, news were brought to Madrid that Pius IV. was dead, and that Father Ghislieri, who had been made Cardinal Alexandrino by Paul IV. had succeeded him under the name of Pius V. These tidings filled Montalto with joy, and not without reason, for he was immediately invested by the pontiff with new dignities. He was made general of his order, bishop of St Agatha, was soon after raised to the dignity of cardinal, and received a pension. About this time he was employed by the Pope to draw up the bill of excommunication against Queen Elizabeth.

He began now to cast his eyes upon the papacy; and, in order to obtain it, formed and executed a plan of hypocrisy with unparalleled constancy and success. He became humble, patient, and affable. He changed his dress, his air, his words, and his actions, so completely, that his most intimate friends declared him a new man. Never was there such an absolute victory gained over the passions; never was a fictitious character so long maintained, nor the foibles of human nature so artfully concealed. He courted the ambassadors of every foreign power, but attached himself to the interests of none; nor did he accept a single favour that would have laid him under any peculiar obligation. He had formerly treated his relations with the greatest tenderness, but he now changed his behaviour altogether. When his brother Anthony came to visit him, he lodged him in an inn, and sent him home next day, charging him to inform his family that he was now dead to his relations and the world.

When Pius V. died in 1572, he entered the conclave with the other cardinals, but seemed altogether indifferent about the election, and never left his apartment except to his devotion. When solicited to join any party, he declined it, declaring that he was of no consequence, and that he would leave the choice of a Pope entirely to persons of greater knowledge and experience. When Cardinal Buon Compagnon, who assumed the name of Gregory XIII. was elected, Montalto assured him that he never wished for any thing so much in his life, and that he would always remember his goodness, and the favours he had conferred on him in Spain. But the new Pope treated him with the greatest contempt, and deprived him of his pension. The cardinals also, deceived by his artifices, paid him no greater respect, and used to call him, by way of ridicule, the Roman beast; the ass of La Marca.

He now assumed all the infirmities of old age; his head hung down upon his shoulders; he tottered as he walked, and supported himself on a staff. His voice became feeble, and was often interrupted by a cough so exceedingly severe, that it seemed every moment to threaten his dissolution. He interfered in no public transactions, but spent his whole time in acts of devotion and benevolence. Mean time he constantly employed the ablest spies, who brought him intelligence of every particular.

When Gregory XIII. died in 1585, he entered the conclave with the greatest reluctance, and immediately shut himself up in his chamber, and was no more thought of than if he had not existed. When he went

*Sixtus.* to mass, for which purpose alone he left his apartment, he appeared perfectly indifferent about the event of the election. He joined no party, yet flattered all.

He knew early that there would be great divisions in the conclave, and he was aware that when the leaders of the different parties were disappointed in their own views, they all frequently agreed in the election of some old and infirm cardinal, the length of whose life would merely enable them to prepare themselves sufficiently for the next vacancy. These views directed his conduct, nor was he mistaken in his hopes of success.

Three cardinals, the leaders of opposite factions, being unable to procure the election which each of them wished, unanimously agreed to make choice of Montalto. When they came to acquaint him with their intention, he fell into such a violent fit of coughing that every person thought he would expire on the spot. He told them that his reign would last but a few days; that, besides a continual difficulty of breathing, he wanted strength to support such a weight, and that his small experience rendered him very unfit for so important a charge. He conjured them all three not to abandon him, but to take the whole weight of affairs upon their own shoulders; and declared that he would never accept the mitre upon any other terms: "If you are resolved," added he, "to make me Pope, it will only be placing yourselves on the throne. For my part, I shall be satisfied with the bare title. Let the world call me Pope, and I make you heartily welcome to the power and authority. The cardinals swallowed the bait, and exerted themselves so effectually that Montalto was elected. He now pulled off the mask which he had worn for 14 years. No sooner was his election secured, than he started from his seat, slung down his staff in the middle of the hall, and appeared almost a foot taller than he had done for several years.

When he was asked, according to custom, if he would accept of the Papacy, he replied, "It is trifling to ask whether I will accept what I have already accepted.—However, to satisfy any scruple that may arise, I tell you that I accept it with great pleasure, and would accept another if I could get it; for I find myself able, by the Divine assistance, to manage two papacies." His former complaisance and humility disappeared, together with his infirmities, and he now treated all around him with reserve and haughtiness. The first care of Sixtus V. the name which Montalto assumed, was to correct the abuses, and put a stop to the enormities, which were daily committed in every part of the ecclesiastical state. The lenity of Gregory's government had introduced a general licentiousness of manners, which burst forth with great violence, after that Pontiff's death. It had been usual with former Popes to release delinquents on the day of their coronation, who were therefore accustomed to surrender themselves voluntary prisoners immediately after the election of the Pope. At present, however, they were fatally disappointed.—When the governor of Rome and the keeper of St Angelo waited on his Holiness, to know his intention in this particular, he replied, "What have you to do with pardons, and releasing of prisoners? Is it not sufficient that our predecessor has suffered the judges to remain unemployed these 13 years? Shall we also stain our pontificate with the same neglect of justice? We have too long seen, with inexpressible concern, the prodi-

gious degree of wickedness that reigns in the state to think of granting pardons. Let the prisoners be brought to a speedy trial, and punished as they deserve, to show the world that Divine Providence has called us to the chair of St Peter, to reward the good, and chastise the wicked; that we bear not the sword in vain, but are the ministers of God, and a revenger to execute wrath on them that do evil."

He appointed commissioners to inspect the conduct of the judges, displaced those who were inclined to lenity, and put others of severe dispositions in their room. He offered rewards to any person who could convict them of corruption or partiality. He ordered the syndics of all the towns and signiories to make out a complete list of the disorderly persons within their districts, and threatened the strapado for the smallest omission. In consequence of this edict, the syndic of Albino was scourged in the market-place, because he had left his nephew, an incorrigible libertine, out of his list.

He made very severe laws against robbers and assassins. Adulterers, when discovered, suffered death; and they who willingly submitted to the prostitution of their wives, a custom then common in Rome, received the same punishment. He was particularly careful of the purity of the female sex, and never forgave those who attempted to debauch them.

His execution of justice was as prompt as his edicts were rigorous. A Swiss happening to give a Spanish gentleman a blow with his halberd, was struck by him so rudely with a pilgrim's staff that he expired on the spot. Sixtus informed the governor of Rome that he was to dine early, and that justice must be executed on the criminal before he sat down to table. The Spanish ambassador and four cardinals intreated him not to disgrace the gentleman by suffering him to die on a gibbet, but to order him to be beheaded. "He shall be hanged (replied Sixtus), but I will alleviate his disgrace by doing him the honour to assist personally at his death." He ordered a gibbet to be erected before his own windows, where he continued sitting during the whole execution. He then called to his servants to bring in dinner, declaring that the act of justice which he had just seen had increased his appetite. When he rose from table, he exclaimed, "God be praised for the good appetite with which I have dined!"

When Sixtus ascended the throne, the whole ecclesiastical state was infested with bands of robbers, who, from their numbers and outrages, were exceedingly formidable; by his prudent and vigorous conduct, however, he in a short time extirpated the whole of these banditti.

Nor was the vigour of his conduct less conspicuous in his transactions with foreign nations. Before he had been pope two months he quarrelled with Philip II. of Spain, Henry III. of France, and Henry king of Navarre. His intrigues indeed in some measure influenced all the councils of Europe.

After his accession to the pontificate he sent for his family to Rome, with express orders that they should appear in a decent and modest manner. Accordingly, his sister Camilla came thither, accompanied by her daughter and two grandchildren. Some cardinals, in order to pay court to the pope, went out to meet her, and introduced her in a very magnificent dress. Sixtus pretended not to know her, and asked two or three times

**SIXTUS.** times who she was : Upon this one of the cardinals said, "It is your sister, holy father." "I have but one sister (replied Sixtus with a frown), and she is a poor woman at Le Grotte; if you have introduced her in this disguise, I declare I do not know her; yet I think I would know her again, if I saw her in the clothes she used to wear."

Her conductors at last found it necessary to carry her to an inn, and strip her of her suery. When Camilla was introduced a second time, Sixtus embraced her tenderly, and said, "Now we know indeed that it is our sister: nobody shall make a princess of you but ourselves." He stipulated with his sister, that she should neither ask any favour in matters of government, nor intercede for criminals, nor interfere in the administration of justice; declaring that every request of that kind would meet with a certain refusal. These terms being agreed to, and punctually observed, he made the most ample provision not only for Camilla but for his whole relations.

This great man was also an encourager of learning. He caused an Italian translation of the Bible to be published, which raised a good deal of discontent among the Catholics. When some cardinals reproached him for his conduct in this respect, he replied, "It was published for the benefit of you cardinals who cannot read Latin."

Sixtus died in 1590, after having reigned little more than five years. His death was ascribed to poison, said to have been administered by the Spaniards; but the story seems rather improbable.

It was to the indulgence of a disposition naturally formed for severity, that all the defects of this wonderful man are to be ascribed. Clemency was a stranger to his bosom; his punishments were often too cruel, and seemed sometimes to border on revenge. Pasquin was dressed one morning in a very nasty shirt, and being asked by Martorio why he wore such dirty linen? replied, that he could get no other, for the pope had made his washerwoman a princess, alluding to Camilla, who had formerly been a laundress. The pope ordered strict search to be made for the author of this lampoon, and offered him his life and a thousand piloles if he would discover himself. The author was simple enough to make his appearance and claim the reward. "It is true (said the pope) we made such a promise, and we shall keep it; your life shall be spared, and you shall receive the money presently: but we have reserved to ourselves the power of cutting off your hands and boring your tongue through, to prevent your being so witty for the future." It is needless to add, that the sentence was immediately executed. This, however, is the only instance of his relenting the many severe satires that were published against him.

But though the conduct of Sixtus seldom excites love, it generally commands our esteem, and sometimes our admiration. He strenuously defended the cause of the poor, the widow, and the orphan: he never refused audience to the injured, however wretched or forlorn their appearance was. He never forgave those magistrates who were capable of partiality or corruption; nor suffered crimes to pass unpunished, whether committed by the rich or the poor. He was frugal, temperate, sober, and never neglected to reward the smallest

favour which had been conferred on him before his exaltation. Sixa ghust.  
Sizor.

When he mounted the throne, the treasury was not only exhausted, but in debt; at his death it contained five millions of gold.

Rome was indebted to him for several of her greatest embellishments, particularly the Vatican library: it was by him, too, that trade was first introduced into the Ecclesiastical State.

**SIXA-GHUSH**, the caracal of Buffon, an animal of the cat kind. See **FELIS**, n° xviii.

**SIZAR**, or **SIZER**, in Latin *Sizator*, an appellation by which the lowest order of students in the universities of Cambridge and Dublin are distinguished, is derived from the word *siz*, which in Cambridge, and probably in Dublin likewise, has a peculiar meaning. To *siz*, in the language of the university, is to get any sort of victuals from the kitchens, which the students may want in their own rooms, or in addition to their commons in the hall, and for which they pay the cooks or buteliers at the end of each quarter. A *siz* of any thing is the smallest quantity of that thing which can be thus bought: two *sizes*, or a part of beef, being nearly equal to what a young person will eat of that dish to his dinner; and a *siz* of ale or beer being equal to half an English pint.

The *sizars* are divided into two classes, viz. *subsizatores* or *sizars*, and *sizatores* or proper *sizars*. The former of these are supplied with commons from the table of the fellows and fellow-commoners; and in former times, when these were more scanty than they are now, they were obliged to supply the deficiency by *sizing*, as is sometimes the case still. The proper *sizars* had formerly no commons at all, and were therefore obliged to *siz* the whole. In St John's college they have now some commons allowed them for dinner, from a benefaction, but they are still obliged to *siz* their suppers: in the other colleges they are allowed a part of the fellow-commons, but must *siz* the rest; and from being thus obliged to *siz* the whole or part of their victuals, the whole order derived the name of *sizars*.

In Oxford, the order similar to that of *sizar* is denominated *servitor*, a name evidently derived from the menial duties which they perform. In both universities these orders were formerly distinguished by round caps and gowns of different materials from those of the pensioners or commoners, the order immediately above them. But about 30 years ago the round cap was entirely abolished in both seminaries. There is still, however, in Oxford, we believe, a distinction in the gowns, and there is also a trifling difference in some of the small colleges in Cambridge; but in the large colleges the dress of the pensioners and *sizars* is entirely the same.

In Oxford, the *servitors* are still obliged to wait at table on the fellows and gentlemen-commoners; but much to the credit of the university of Cambridge, this most degrading and disgraceful custom was entirely abolished about 10 or 12 years ago, and of course the *sizars* of Cambridge are now on a much more respectable footing than the *servitors* of Oxford.

The *sizars* are not upon the foundation, and therefore while they continue *sizars* are not capable of being elected fellows; but they may at any time, if they

**Size.** choose, become pensioners: and they generally sit for scholarships immediately before they take their first degree. If successful, they are then on the foundation, and are entitled to become candidates for fellowships when they have got that degree. In the mean time, while they continue sizars, besides free commons they enjoy many benefactions, which have been made at different times, under the name of *sizar's prator, exhibitions*, &c. and the rate of tuition, the rent of rooms, and other things of that sort within their respective colleges, is less than to the other orders. But tho' their education is thus obtained at a less expence, they are not now considered as a menial order; for sizars, pensioner-scholars, and even sometimes fellow-commoners, mix together with the utmost cordiality. It is worthy of remark, that at every period this order has supplied the university with its most distinguished officers; and that many of the most illustrious members of the church, many of the most distinguished men in the other liberal professions, have, when under-graduates, been sizars, when that order was on a less respectable footing than it is now.

**SIZE**, the name of an instrument used for finding the bigness of fine round pearls. It consists of thin pieces or leaves, about two inches long, and half an inch broad, fastened together at one end by a rivet. In each of these are round holes drilled of different diameters. Those in the first leaf serve for measuring pearls from half a grain to seven grains; those of the second, for pearls from eight grains or two carats to five carats, &c.; and those of the third, for pearls from six carats and a half to eight carats and a half.

**Size**, is also a sort of paint, varnish, or glue, used by painters, &c.

The strands and parings of leather, parchment, or vellum, being boiled in water and strained, make size. This substance is much used in many trades.—The manner of using size is to melt some of it over a gentle fire; and scraping as much whiting into it as will just colour it, let them be well incorporated together; after which you may whiten frames, &c. with it. After it dries, melt the size again, and put more whiting, and whiten the frames, &c. seven or eight times, letting it dry between each time: but before it is quite dry, between each washing with size, you must smoothe and wet it over with a clean brush-pencil in fair water.

To make gold-size. Take gum-animi and asphaltum, of each one ounce; minium, litharge of gold, and amber, of each half an ounce: reduce all into a very fine powder, and add to them four ounces of linseed-oil, and eight ounces of drying oil: digest them over a gentle fire that does not flame, so that the mixture may only simmer, but not boil; lest it should run over and set the house on fire, stir it constantly with a stick till all the ingredients are dissolved and incorporated, and do not leave off stirring till it becomes thick and ropy; after being sufficiently boiled, let it stand till it is almost cold, and then strain it through a coarse linen cloth, and keep it for use.—To prepare it for working, put what quantity you please in a horse-muscle shell, adding as much oil of turpentine as will dissolve it; and making it as thin as the bottom of your feed-lac varnish, hold it over a candle, and then strain it through a lichen-rag into another shell; add to these as much vermilion as will make

it of a darkish red; if it is too thick for drawing, you may thin it with some oil of turpentine. The chief use of this size is for laying on metals.

The best gold size for burnishing is made as follows: Take fine bole, what quantity you please; grind it finely on a piece of marble, then scrape into it a little beef suet; grind all well together; after which mix in a small proportion of parchment-size with a double proportion of water, and it is done.

To make silver-size. Take tobacco-pipe clay in fine powder, into which scrape some black-lead and a little Genoa soap, and grind them all together with parchment size as already directed.

**SKATING**, an exercise on ice, both graceful and healthy. Although the ancients were remarkable for their dexterity in most of the athlétic sports, yet skating seems to have been unknown to them. It may therefore be considered as a modern invention; and probably it derived its origin in Holland, where it was practised, not only as a graceful and elegant amusement, but as an expeditious mode of travelling when the lakes and canals were frozen up during winter. In Holland long journeys are made upon skates with ease and expedition; but in general less attention is there paid to graceful and elegant movements, than to the expedition and celerity of what is called *journey skating*. It is only in those countries where it is considered as an amusement, that its graceful attitudes and movements can be studied; and there is no exercise whatever better calculated to set off the human figure to advantage. The acquirement of most exercises may be attained at an advanced period of life; but to become an expert skater, it is necessary to begin the practice of the art at a very early age. It is difficult to reduce the art of skating to a system. It is principally by the imitation of a good skater that a young practitioner can form his own practice. The English, though often remarkable for feats of agility upon skates, are very deficient in gracefulness; which is partly owing to the construction of the skates. They are too much curved in the surface which embraces the ice, consequently they involuntarily bring the users of them round on the outside upon a quick and small circle; whereas the skater, by using skates of a different construction, less curved, has the command of his stroke, and can enlarge or diminish the circle according to his own wish and desire. The metropolis of Scotland has produced more instances of elegant skaters than perhaps any other country whatever; and the institution of a Skating Club about 40 years ago, has contributed not a little to the improvement of this elegant amusement. We are indebted for this article to a gentleman of that Club, who has made the practice and improvement of skating his particular study; and as the nature of our work will not permit the insertion of a full treatise on skating, we shall present our readers with a few instructions.

Those who wish to be proficient should begin at an early period of life; and should first endeavour to throw off the fear which always attends the commencement of an apparently hazardous amusement. They will soon acquire a facility of moving on the inside; when they have done this, they must endeavour to acquire the movement on the outside of the skates; which is nothing more than throwing themselves upon the outer edge of the skate, and making the balance of their body tend towards that side,

ing, side, which will necessarily enable them to form a semicircle. In this, much assistance may be derived from placing a bag of lead-shot in the pocket next to the foot employed in making the outside stroke, which will produce an artificial poise of the body, which afterwards will become natural by practice. At the commencement of the outside stroke, the knee of the employed limb should be a little bended, and gradually brought to a rectilinear position when the stroke is completed. When the practitioner becomes expert in forming the semicircle with both feet, he is then to join them together, and proceed progressively and alternately with both feet, which will carry him forward with a graceful movement. Care should be taken to use very little muscular exertion, for the impelling motion should proceed from the mechanical impulse of the body thrown into such a position as to regulate the stroke. At taking the outside stroke, the body ought to be thrown forward easily, the unemployed limb kept in a direct line with the body, and the face and eyes directly looking forward: the unemployed foot ought to be stretched towards the ice, with the toes in a direct line with the leg. In the time of making the curve, the body must be gradually, and almost imperceptibly, raised, and the unemployed limb brought in the same manner forward; so that, at finishing the curve, the body will bend a small degree backward, and the unemployed foot will be about two inches before the other, ready to embrace the ice and form a correspondent curve. The muscular movement of the whole body must correspond with the movement of the skate, and should be regulated so as to be almost imperceptible to the spectators. Particular attention should be paid in carrying round the head and eyes with a regular and imperceptible motion; for nothing so much diminishes the grace and elegance of skating as sudden jerks and exertions, which are too frequently used by the generality of skaters. The management of the arms likewise deserves attention. There is no mode of disposing of them more gracefully in skating outside, than folding the hands into each other, or using a muff.

There are various feats of activity and manœuvres used upon skates; but they are so various that we cannot pretend to detail them. Moving on the outside is the primary object for a skater to attain; and when he becomes an adept in that, he will easily acquire a facility in executing other branches of the art. There are few exercises but will afford him hints of elegant and graceful attitudes. For example, nothing can be more beautiful than the attitude of drawing the bow and arrow whilst the skater is making a large circle on the outside: the manual exercise and military salutes have likewise a pretty effect when used by an expert skater.

**SKELETON**, in anatomy, the dried bones of any animal joined together by wires, or by the natural ligament dried, in such a manner as to show their position when the creature was alive.

We have, in the Philosophical Transactions, an account of a human skeleton, all the bones of which were so united, as to make but one articulation from the back to the os sacrum, and downwards a little way. On sawing some of them, where they were unnaturally joined, they were found not to cohere throughout their whole substance, but only about a sixth of an inch deep

all round. The figure of the trunk was crooked, the spine making the convex, and the inside of the vertebræ the concave part of the segment. The whole had been found in a charnel-house, and was of the size of a full grown person.

**SKIDS**, or **SKEDDS**, in sea-language, are long compassing pieces of timber, notched below so as to fit closely upon the wales, extending from the main-wale to the top of the side, and retained in this position by bolts or spike-nails. They are intended for preserving the planks of the side, when any heavy body is hoisted or lowered.

**SKIE** (Isle of). See **SKY**.

**SKIFF**, a small boat resembling a yawl, usually employed for passing rivers.

**SKIMMER**, **BLACK**. See **SHEARBILL**.

**SKIMMIA**, in botany: A genus of the *monogynia* order, belonging to the *tetrandria* class of plants; and in the natural method ranking under the 40th order, *Personate*. The calyx is quadripartite; the corolla consists of four concave petals; and the berry contains four seeds. There is only one species, viz. the *Japonica*.

**SKIN**, in anatomy, the general covering of the body of any animal. See **ANATOMY**, n<sup>o</sup> 74.

**SKIN**, in commerce, is particularly used for the membrane stripped off the animal to be prepared by the tanner, skinner, parchment-maker, &c. and converted into leather, &c. See **TANNING**.

**SKINNER** (Stephen), an English antiquarian, born in 1622. He travelled, and studied in several foreign universities during the civil wars; and in 1654, returned and settled at Lincoln, where he practised physic with success until the year 1667, when he died of a malignant fever. His works were collected in folio in 1671, by Mr Henshaw, under the title of *Etymologicon Linguae Anglicanae*, &c.

**SKIPPER**, or **SAURY**, a species of *ESOX*, which see.

**SKIRMISH**, in war, a slight engagement between small parties, without any regular order; and is therefore easily distinguished from a *battle*, which is a general engagement between two armies continued for some time.

**SKULL**, in anatomy, the bony case in which the brain is inclosed. See **ANATOMY**, n<sup>o</sup> 11. &c.

**SKULL-CAP**. See **SCUTELLARIA**.

**SKY**, the blue expanse of air or atmosphere. For the reason of its blue colour and concave figure, see **OPTICS**.

**SKY**, one of the greatest of the Western Islands of Scotland, so called from *Skianach*, which in the Erse dialect signifies *winged*, because the two promontories of Valerness and Troternish, by which it is bounded on the north-west and north-east, are supposed to resemble wings. The island lies between the shire of Ross and the western part of Lewis. According to the computation of Mr Pennant, Dr Johnson, and Dr Campbell, it is 60 miles in length, and nearly the same in width where broadest; according to others it is 50 miles in length, and in some places 30 broad. The island of Sky is divided between two proprietors; the southern part belongs to the laird of Macleod, said to be lineally descended from Leod son to the black prince of Man: the northern district, or barony of Troternish, is the property of Lord Macdonald, whose ancestor was Donald,

Skids

||

Sky.

Sky.

nald, king or lord of the Isles, and chief of the numerous clan of Maconalds, who are counted the most warlike of all the Highlanders. Sky is part of the shire of Inverness, and formerly belonged to the diocese of the Isles: on the south it is parted from the main land by a channel three leagues in breadth; tho', at the ferry of Glenelly, it is so narrow that a man may be heard calling for the boat from one side to the other. Sky is well provided with a variety of excellent bays and harbours.

The face of the country is roughened with mountains, some of which are so high as to be covered with snow on the top at midsummer; in general, their sides are clothed with heath and grass, which afford good pasturage for sheep and black cattle. Between the mountains there are some fertile valleys, and the greater part of the land towards the sea-coast is plain and arable. The island is well watered with a great number of rivers, above 30 of which afford salmon; and some of them produce black muscels in which pearls are bred, particularly the rivers Kilmartin and Ord: Martin was assured by the proprietor of the former, that a pearl hath been found in it valued at 20 l. Sterling. Here is also a considerable number of fresh-water lakes well stored with trout and eels. The largest of these lakes takes its denomination from St Columba, to whom is dedicated a chapel that stands upon a small isle in the middle of the lake. Sky likewise affords several cataracts, that roar down the rocks with great impetuosity. That the island has been formerly covered with woods, appears from the large trunks of fir and other trees daily dug out of the bogs and peat-marshes in every part of this country.

From the height of the hills, and proximity of the sea, the air seldom continues long of the same temperature; sometimes it is dry, oftener moist, and in the latter end of winter and beginning of spring cold and piercing; at an average, three days in twelve throughout the year scarcely free from rain, far less from clouds. These, attracted by the hills, sometimes break in useful and refreshing showers; at other times suddenly bursting, pour down their contents with tremendous noise, in impetuous torrents that deluge the plains below, and render the smallest rivulet impassable; which, together with the stormy winds so common in this country in the months of August and September, frequently blast the hopes, and disappoint the expectations, of the husbandman. Snow has been often known to lie on the ground from three to seven weeks; and on the highest hills, even in the middle of June, some spots of it are to be seen. To this various temperature of the air, and uncertainty of weather, the fevers and agues, headaches, rheumatisms, colds, and dysenteries, which are the prevailing distempers, may be ascribed. That it is far, however, from being unwholesome, is sufficiently evinced by experience; for the inhabitants are, in general, as strong and healthy, and arrive at as advanced an age, as those who live in milder climates, and under a serener sky. The gout is scarcely known in this island.

The soil is generally black, though it likewise affords clay of different colours; such as white, red, and blue, and in some places fuller's earth. It is, however, much less adapted for agriculture than for pasture, and seldom, unless in very good years, supplies itself with a suf-

iciency of provisions. Yet, though the soil is not very fertile or rich, it might with proper management be made to produce more plentiful crops. But the generality of the farmers are so prejudiced in favour of old customs, and indeed so little inclined to industry, that they will not easily be prevailed on to change them for better; especially if the alteration or amendment proposed be attended with expence. Therefore, with respect to improvements in agriculture, they are still much in the same state as they were 20 or 30 years ago. Ploughs, on a new and improved model, that in comparison to the advantages derived from them might be had at a moderate expence, have lately been introduced into several districts around, where their good effects are manifest, in improving the crops and diminishing the labour of man and beast; but the laird of Raafay and one other gentleman are the only persons in Portree that have used them. The *caferoim*, a crooked kind of spade, is almost the only instrument for labouring the ground used among the ordinary class of tenants. The average crops of corn are 8000 bolls.

When Mr Knox visited this island in 1786, the number of inhabitants amounted to 15,000: but some gentlemen who resided there affirmed there were 16,000. It is divided into eight parishes, in each of which there is a school, besides three charity-schools in different places.

The minerals found here are lead and iron ore, which, however, have never been wrought to any advantage. Near the village of Sartle, the natives find black and white marcasites, and variegated pebbles. The Appleglen, in the neighbourhood of Loch-fallart, produces beautiful agates of different sizes and colours: stones of a purple hue are, after great rains, found in the rivulets: crystal, of different colours and forms, abounds in several parts of the island, as well as black and white marble, free-stone, lime-stone, and tale: small red and white coral is found on the southern and western coasts in great abundance. The fuel consists chiefly of peat and turf, which are impregnated with iron ore and salt-petre; and coal has been discovered in several districts.

The wild birds of all sorts most common in the country are, solan geese, gulls, cormorants, cranes, wild geese, and wild ducks; eagles, crows, ravens, rooks, cuckoos, rails, woodcocks, moor-fowl, partridges, plover, wild pigeons, and blackbirds, owls, hawks, snipes, and a variety of small birds. In mild seasons, the cuckoo and rail appear in the latter end of April; the former disappears always before the end of June; the latter sometimes not till September. The woodcock comes in October, and frequently remains till March. The tame sorts of fowl are geese, ducks, turkeys, cocks, pullets, and tame pigeons.

The black cattle are here exposed to all the rigours of the severe winter, without any other provender than the tops of the heath and the alga marina; so that they appear like mere skeletons in the spring; though, as the grass grows up, they soon become plump and juicy, the beef being sweet, tender, and finely interlarded.—The amphibious animals are seals and otters. Among the reptiles they reckon vipers, asps, weasels, frogs, toads, and three different kinds of serpents; the first spotted black and white, and very poisonous; the second yellow,

low,



low, with brown spots; and the third of a brown colour, the smallest and least poisonous.

Whales and caibans, or sun-fish, come in sometimes to the sounds after their prey, but are rarely pursued with any success. The fishes commonly caught on the coast are herrings, ling, cod, scate, haddock, mackerel, lythe, syc, and dog-fish. The average price of ling at home is L. 13, 13 s. *per* ton; when sold, one by one, if fresh, the price is from 3 d. to 5 d.; if cured, from 5 d. to 7 d. The barrel of herrings seldom sells under 19 s. which is owing to the great difficulty of procuring salt, even sometimes at any price; and the same cause prevents many from taking more than are sufficient for their own use.

The kyle of Scalpe teems with oysters, in such a manner, that after some spring-tides, 20 horse-loads of them are left upon the sands. Near the village of Bern-still, the beach yields muscles sufficient to maintain 60 persons *per* day; this providential supply helps to support many poor families in times of scarcity.

The people are strong, robust, healthy, and prolific. They generally profess the Protestant religion; are honest, brave, innocent, and hospitable. They speak the language, wear the habit, and observe the customs that are common to all the Hebrides. The meconium in new-born infants is purged away with fresh butter: the children are bathed every morning and evening in water, and grow up so strong, that a child of 10 months is able to walk alone: they never wear shoes or stockings before the age of eight or ten, and night-caps are hardly known; they keep their feet always wet; they lie on beds of straw or heath, which last is an excellent restorative: they are quick of apprehension, ingenious, and very much addicted to music and poetry. They eat heartily of fish; but seldom regale themselves with flesh-meat: their ordinary food consists of butter, cheese, milk, potatoes, colewort, brochan, and a dish called *oon*, which indeed is no other than the froth of boiled milk or whey raised with a stick like that used in making chocolate.

A sort of coarse woollen cloth called *clea*, or *cad-does*, the manufacture of their wives, made into short jackets and trousers, is the common dress of the men. The philibeg is rarely worn, except in summer and on Sundays; on which days, and some other occasions, those in better circumstances appear in tartans, a bonnet, and short hose, and some in a hat, short coat, waistcoat, and breeches, of Scotch or English manufacture. The women are in general very cleanly, and so excessively fond of dress, that many maid-servants are often known to lay out their whole wages that way.

There are two fairs held annually at Portree, to which almost every part of Sky sends cattle. The first is held in the end of May, and the second in the end of July. The fair commonly continues from Wednesday till the Saturday following. The commodities which are sold in these are horses, cows, sheep, goats, hides, butter, cheese, fish, and wool. The cattle fold in these fairs swim over to the main land through a mile or half a mile of sea. Thousands of these are yearly exported, at from L. 2 to L. 3 each. Many of them are driven to England, where they are fatted for the market, and counted delicious eating.

In Sky appear many ruins of Danish forts, watch-

towers, beacons, temples, and sepulchral monuments. All the forts are known by the term *Dun*; such as Dun-Skudborg, Dun-Derig, Dun-Skerinesf, Dun-David, &c.

*Sky-Colour.* To give this colour to glass, set in the furnace a pot of pure metal of fritt from rochetta or berrilla, but the rochetta fritt does best; as soon as the metal is well purified, take for a pot of twenty pounds of metal six ounces of brass calcined by itself; put it by degrees at two or three times into the metal, stirring and mixing it well every time, and diligently skimming the metal with a ladle: at the end of two hours the whole will be well mixed, and a proof may be taken; if the colour be found right, let the whole stand 24 hours longer in the furnace, and it will then be fit to work, and will prove of a most beautiful sky colour.

SLAB, an outside sappy plank or board sawed off from the sides of a timber-tree. The word is also used for a flat piece of marble.

*SLAB-Line*, in sea-language, a small cord passing up behind a ship's main-sail or fore-sail, and being reeved through a block attached to the lower part of the yard, is thence transmitted in two branches to the foot of the sail, to which it is fastened. It is used to truss up the sail as occasion requires, and more particularly for the convenience of the pilot or steersman, that they may look forward beneath it as the ship advances.

SLACK-WATER, in sea-language, denotes the interval between the flux and reflux of the tide, or between the last of the ebb and the first of the flood, during which the current is interrupted, and the water apparently remains in a state of rest.

SLACKEN, in metallurgy, a term used by the miners to express a spongy and semivitrified substance, which they used to mix with the ores of metals, to prevent their fusion. It is the scoria or scum separated from the surface of the former fusions of metals. To this they frequently add limestone, and sometimes a kind of coarse iron-ore, in the running of the poorer gold ores.

SLATE (*Stegania*), a stone of a compact texture and laminated structure, splitting into fine plates.

Dr Hill distinguishes four species of stegania. 1. The whitish steganium, being a soft, friable, slaty stone, of a tolerably fine and close texture, considerably heavy, perfectly dull and destitute of brightness, variegated with a pale brown or brownish yellow. This species is common in many counties of England, lying near the surface of the ground. It is generally very full of perpendicular as well as horizontal cavities, many of which are filled up with a spar a little purer and more crystalline than the rest; and is commonly used for covering houses. 2. The red steganium is a very fine and elegant slate, of a smooth surface, firm and compact texture, considerably heavy, and of a very beautiful pale purple, glittering all over with small glossy spangles: it is composed of a multitude of very thin plates or flakes, laid closely and evenly over one another, and cohering pretty firmly: this is very common in the northern parts of England, and is much valued as a strong and beautiful covering for houses. 3. The common blue steganium is very well known as an useful and valuable stone, of a fine smooth texture and glossy surface, moderately heavy, and of a pale greyish blue; composed of a multi-

Sky  
||  
Slate.

Slate  
||  
Slavery.

tude of even plates, laid close upon one another, and easily splitting at the commissures of them: this is also very common in the north parts of England, and is used in most places for the covering of houses. There are other species of this slate, viz. the brownish blue friable steanium, usually called *coal-slate*; the greyish black friable steanium, commonly called *shiver*; and the greyish blue sparkling steanium. 4. The friable, aluminous, black steanium, being the Irish slate of the shops: this is composed of a multitude of thin flakes, laid very evenly and regularly over one another, and splits very regularly at the commissures of them. It is common in many parts of Ireland, and is found in some places in England always lying near the surface in very thick strata. In medicine it is used in hemorrhagies of all kinds with success, and is taken often as a good medicine in fevers.

The island of Emsdale, one of the Hebrides on the west coast of Scotland, is entirely composed of slate. The stratum is 36 feet thick. About two millions and a half, at the rate of twenty shillings per thousand, are sold annually to England, Canada, the West Indies, and Norway.

SLAVE. See SLAVERY.

Slavery de-  
fined.

SLAVERY is a word, of which though generally understood, it is not easy to give a proper definition. An excellent moral writer has defined it to be "an obligation to labour for the benefit of the master, without the contract or consent of the servant." But may not he be properly called a slave who has given up his freedom to discharge a debt which he could not otherwise pay, or who has thrown it away at a game of hazard? In many nations, debts have been legally discharged in this manner; and in some savage tribes, such is the universal ardour for gaming, that it is no uncommon thing for a man, after having lost at play all his other property, to stake, on a single throw of dice, himself, his wife, and his children (A). That persons who have thus lost their liberty are slaves, will hardly be denied; and surely the infatuated gamester is a slave by his own contract. The debtor, too, if he was aware of the law, and contracted debts larger than he could reasonably expect to be able to pay, may justly be considered as having come under an obligation to labour for the benefit of a master *with his own consent*; for every man is answerable for all the known consequences of his voluntary actions.

This definition of slavery seems to be defective as well as inaccurate. A man may be under an obligation to labour through life for the benefit of a master, and yet

that master have no right to dispose of him by sale, or in any other way to make him the property of a third person; but the word *slave*, as used among us, always denotes a person who may be bought and sold like a beast in the market (B). In its original sense, indeed, it was of the same import with *noble, illustrious*; but vast numbers of the people among whom it had that signification being, in the decline of the Roman empire, sold by their countrymen to the Venetians, and by them dispersed over all Europe, the word *slave* came to denote a person in the lowest state of servitude, who was considered as the absolute property of his master. See PHILOLOGY, n<sup>o</sup> 220.

As nothing can be more evident than that all men have, by the law of nature, an equal right to life, liberty, and the produce of their own labour (see RIGHT, n<sup>o</sup> 5.), it is not easy to conceive what can have first led one part of them to imagine that they had a right to enslave another. Inequalities of rank are indeed inevitable in civil society; and from them results that servitude which is founded in contract, and is of temporary duration. (See MORAL PHILOSOPHY, n<sup>o</sup> 141.) He who has much property has many things to attend to, and must be disposed to hire persons to assist and serve him; while those who have little or no property must be equally willing to be hired for that purpose. And if the master be kind, and the servant faithful, they will both be happier in this connection than they could have been out of it. But from a state of servitude, where the slave is at the absolute disposal of his master in all things, and may be transferred without his own consent from one proprietor to another, like an ox or an ass, happiness must be for ever banished. How then came a traffic so unnatural and unjust as that of slaves to be originally introduced into the world?

The common answer to this question is, that it took its rise among savages, who, in their frequent wars with each other, either massacred their captives in cold blood, or condemned them to perpetual slavery. In support of this opinion we have heard it observed, that the Latin word *servus*, which signifies not a hired servant, but a *slave*, is derived from *servare*, "to preserve;" and that such men were called *servi*, because they were captives, whose lives were preserved on the condition of their becoming the property of the victor.

That slavery had its origin from war, we think extremely probable (C), nor are we inclined to controvert this etymology of the word *servus*; but the traffic in men prevailed almost universally long before the Latin lan-

(A) Aleam (quod mirere) sobrii inter seria exercent, tanta lucrandi perdendive temeritate, ut cum omnia defecerunt, extremo ac novissimo jactu de libertate et corpore contendant. Victus voluntariam servitutem adit; quamvis junior, quamvis robustior, alligari se ac venire patitur.—*Tacitus de Mor. Germ.*

The savages of North America are equally addicted to gaming with the ancient Germans, and the negroes on the Slave Coast of Guinea perhaps still more.

(B) The Roman orator's definition of *slavery*, Parad. V. is as accurate as any that we have seen. "Servitus est obedientia fracti animi et abjecti et arbitrio carentis suo;" whether the unhappy person fell into that state with or without his own contract or consent.

(C) In the article SOCIETY, the reader will find another account of the origin of slavery, which we think likewise probable, though we have not transferred it to this place; as it would, in our opinion, be wrong to give to one writer what we know to belong to another. It may be proper, however, to observe here, that between the two articles there is no contradiction, as barbarous wars were certainly one source of slavery.

very. language or Roman name was heard of; and there is no good evidence that it began among savages. The word עֶבֶר, in the Old Testament, which in our version is rendered *servant*, signifies literally a *slave*, either born in the family or bought with money, in contradistinction to עֶבֶר, which denotes a hired servant: and as Noah makes use of the word עֶבֶר in the curse which he denounces upon Ham and Canaan immediately after the deluge, it would appear that slavery had its origin before that event. If so, there can be little doubt but that it began among those violent persons whom our translators have called *giants*\*, though the original word עֶבֶר literally signifies *assaulters of others*. Those wretches seem first to have seized upon women, whom they forcibly compelled to minister to their pleasures; and from this kind of violence the progress was natural to that by which they enslaved their weaker brethren among the men, obliging them to labour for their benefit, without allowing them fee or reward.

5  
rod en-  
d his  
ves.  
After the deluge the first dealer in slaves seems to have been Nimrod. "He began," we are told, "to be a mighty one in the earth, and was a mighty hunter before the Lord." He could not, however, be the first hunter of wild beasts; for that species of hunting must have been practised from the beginning; nor is it probable that his dexterity in the chase, which was then the universal employment, could have been so far superior to that of all his contemporaries, as to entitle him to the appellation of the "the mighty hunter before the Lord." Hence most commentators have concluded, that he was a hunter of men; an opinion which they think receives some countenance from the import of his name, the word *Nimrod* signifying a rebel. Whatever be in this, there can be little doubt but that he became a mighty one by violence; for being the sixth son of his father, and apparently much younger than the other five, it is not likely that his inheritance exceeded theirs either in extent or in population. He enlarged it, however, by conquest; for it appears from Scripture, that he invaded the territories of Ashur the son of Shem, who had settled in Shinar; and obliging him to remove into Assyria, he seized upon Babylon, and made it the capital of the first kingdom in the world. As he had great projects in view, it seems to be in a high degree probable that he made bond-servants of the captives whom he took in his wars, and employed them in building or repairing the metropolis of his kingdom; and hence we think is to be dated the origin of postdeluvian slavery.

6  
ry in  
lays of  
ham.  
That it began thus early can hardly be questioned; for we know that it prevailed universally in the age of Abraham, who was born within seventy years after the death of Nimrod. That patriarch had three hundred and eighteen servants or slaves, born in his own house, and trained to arms, with whom he pursued and conquered the four kings who had taken captive his brother's son †. And it appears from the conversation

which took place between him and the king of Sodom after the battle, that both believed the conqueror had a right to consider his prisoners as part of his spoil. "Give me (says the king) the *persons*, and take the *goods* to thyself." It is indeed evident from numberless passages of scripture, that the domestics whom our translators call *servants* were in those days universally considered as the most valuable part of their master's property, and classed with his flocks and herds. Thus when the sacred historian describes the wealth of Abraham, he says, that "he had sheep and oxen, and he-asses, and men-servants, and maid-servants, and she-asses, and camels." And when Abimelech wished to make some reparation to the patriarch for the unintended injury that he had done him, "he took sheep and oxen, and men-servants, and women-servants, and gave them unto Abraham, and restored to him Sarah his wife." The riches and power of Isaac and Jacob are estimated in the very same manner. Of the former it is said, that "the man waxed great, and went forward and grew, until he became very great: for he had possession of flocks, and possession of herds, and great store of servants, עֶבֶר of slaves; and the Philistines envied him." The latter, we are told, "increased exceedingly, and had much cattle, and maid-servants, and men-servants, and camels, and asses †."

That the practice of buying and selling servants thus early begun among the patriarchs descended to their posterity, is known to every attentive reader of the Bible. It was expressly authorised by the Jewish law, in which are many directions how such servants were to be treated. They were to be bought only of the heathen; for if an Israelite grew poor and sold himself either to discharge a debt, or to procure the means of subsistence, he was to be treated not as a slave עֶבֶר, but as a hired servant עֶבֶר, and restored to freedom at the year of Jubilee. "Both thy bond-men and thy bond-maids (says Moses) shall be of the heathen that are round about you: of them shall ye buy bond men and bond-maids. And ye shall take them as an inheritance for your children after you, to inherit them for a possession; they shall be your bond-men for ever †." Un-  
limited as the power thus given to the Hebrews over their bond-servants of heathen extraction appears to have been, they were strictly prohibited from acquiring such property by any other means than fair purchase: "he that *stealeth* a man and selleth him," said their great lawgiver, "shall surely be put to death †."

Whilst slavery, in a mild form, was permitted among the people of God, a much worse kind of it prevailed among the heathen nations of antiquity. With other the abominable customs, the traffic in men quickly spread from Chaldea into Egypt, Arabia, and over all the east, and by degrees found its way into every known region under heaven (D).

Of this hateful commerce we shall not attempt to trace the progress thro' every age and country, but shall con-

Slavery.

† Gen. xii.  
16. xx. 14.  
xxiv. 35.  
xxvi. 13, 14.  
xxx. 43.

7  
Authorised  
by the Mo-  
saic law.

8  
Lev. xxv.  
39, 40, 44,  
46.

9  
Lev. xxi.  
16.

10  
Spread over  
the whole  
world.

(D) If credit be due to a late account of China, the people of that vast empire have never made merchandize of men or women. The exception, however, is so singular, that we should be glad to see it better authenticated; for it is apparent from works of the most undoubted credit, that over all the other eastern countries with which we are acquainted slavery has prevailed from time immemorial, and that some of the Indian nations make long journeys into Africa for the sole purpose of buying slaves.

Slavery. tent ourselves with taking a transient view of it among the Greeks and Romans, and a few other nations, in whose customs and manners our readers must be interested.

9  
Slavery among the Greeks and

One can hardly read a book of the *Iliad* or *Odyssey*, without perceiving that, in the age of Homer, all prisoners of war were liable to be treated as slaves, and compelled, without regard to their rank, sex, or years, to labour for their masters in offices of the vilest drudgery. So universally was this cruel treatment of captives admitted to be the right of the victor, that the poet introduces Hector, in the very act of taking a tender and perhaps last farewell of his wife, when it was surely his business to afford her every consolation in his power, telling her, as a thing of course which could not be concealed, that, on the conquest of Troy, she would be compelled

To bear the victor's hard commands, or bring  
The weight of water from Hyperia's spring (E).

Pope.

At that early period, the Phœnicians, and probably the Greeks themselves, had such an established commerce in slaves, that, not satisfied with reducing to bondage their prisoners of war, they scrupled not to kidnap in cold blood persons who had never kindled their resentment, in order to supply their foreign markets. In the 14th book of the *Odyssey*, Ulysses represents himself as having narrowly escaped a snare of this kind laid for him by a false Phœnician, who had doomed the hero to Libyan slavery: and as the whole narrative, in which this circumstance is told, is an artful fiction, intended to have the appearance of truth to an Ithacan peasant, the practice of kidnapping slaves could not then have appeared incredible to any inhabitant of that island.

Such were the manners of the Greeks in the heroic age; nor were they much improved in this respect at periods of greater refinement. Philip of Macedon having conquered the Thebans, not only sold his captives, but even took money for permitting the dead to be buried\*; and Alexander, who had more generosity than Philip, afterwards razed the city of Thebes, and sold the inhabitants, men, women, and children, for slaves†. This cruel treatment of a brave people may indeed be supposed to have proceeded, in the first instance, from the avarice of the conqueror; and in the second, from the momentary repentment of a man who was savage and generous by turns, and who had no command of his passions. We shall not positively assign it to other causes; but from the manner in which the Spartans behaved to their slaves, there is little reason to imagine that had they received from the Thebans the same provocation with Alexander, they would have treated their captives with greater lenity. "At Sparta (says a humane and elegant writer) slaves were treated with a degree of rigour that is hardly conceivable; although to them, as their husbandmen and artificers, their proud and idle masters were indebted for all the necessaries of life. The Lacedæmonian youth, trained up in the practice of deceiving and butchering those poor men, were from time

to time let loose upon them, in order to show their proficiency in stratagem and massacre. And once, without any provocation, and merely for their own amusement, we are told that they murdered three thousand in one night, not only with the connivance of law, but by its avowed permission. Such, in promoting the happiness of one part of society and the virtue of another, are the effects of slavery."

It has been said, that in Athens and Rome slaves were better treated than in Sparta: but in the former city their treatment cannot have been good, nor their lives comfortable, where the Athenians relished that tragedy of Euripides in which Hecuba, the wife of Priam, is introduced as lamenting that she was chained like a dog at Agamemnon's gate! Of the estimation in which slaves were held in Rome, we may form a tolerable notion from the well known fact, that one of those unhappy beings was often chained at the gate of a great man's house, to give admittance to the guests invited to a feast\*. In the early periods of the commonwealth it was customary, in certain sacred shews exhibited on solemn occasions, to drag through the circus a slave, who had been scourged to death holding in his hand a fork in the form of a gibbet†. But we need not multiply proofs of the cruelty of the Romans to their slaves. If the inhuman combats of the gladiators (see GLADIATORS) admit of any apology on account of the martial spirit with which they were thought to inspire the spectators, the conduct of Vedius Pollio must have proceeded from the most wanton and brutal cruelty. This man, who flourished not in the earliest periods of the republic, when the Romans were little better than a savage banditti, but in the polished age of Augustus, frequently threw such slaves as gave him the slightest offence into his fish-ponds to fatten his lampreys; and yet he was suffered to die in peace! The emperor, indeed, upon coming to the knowledge of his cruelty, ordered his lampreys to be destroyed, and his ponds to be filled up; but we do not recollect that any other punishment was inflicted on the savage master. Till the reign of the same emperor the depositions of slaves were never admitted in the courts of judicature; and then they were received only when persons were accused of treasonable practices.

The origin of slavery in Rome was the same as in every other country. Prisoners of war were of course reduced to that state, as if they had been criminals. The dictator Camillus, one of the most accomplished generals of the republic, sold his Hetrurian captives to pay the Roman ladies for the jewels which they had presented to Apollo. Fabius, whose cautious conduct saved his country when Hannibal was victorious in Italy, having subdued Tarentum, reduced 30,000 of the citizens to slavery, and sold them to the highest bidder. Coriolanus, when driven from Rome, and fighting for the Volsci, scrupled not to make slaves of his own countrymen; and Julius Cæsar, among whose faults wanton cruelty

\* Justin. lib. iii. cap. 4.  
† Justin et Arrian.

Beattie's Moral Science, vol. ii.

Slavery

10  
Romans

\* Kamet's Sketches.

† Cicero a Dio. lib. cap. 26.

11  
Origin of Roman Slavery.

(E) In those early times drawing water was the office of the meanest slaves. This appears from Joshua's curse upon the Gibeonites who had deceived him.—"Now therefore ye are cursed, and there shall none of you be freed from being bond-men, and hewers of wood, and drawers of water, for the house of my God." To this state of bondage Homer makes Hector say, that Andromache would necessarily be brought upon the destruction of Troy; *κατασφραγήσεται ἀνδράων ἀνδράων*.—*Il. lib. vi.*

er. cruelty has never been reckoned, sold at one time fifty-three thousand captives for slaves. Nor did the slaves in Rome consist only of foreigners taken in war. By one of the laws of the twelve tables, creditors were empowered to seize their insolvent debtors, and keep them in their houses till, by their services or labour, they had discharged the sum they owed: and in the beginning of the commonwealth they were authorised to sell such debtors, and even to put them to death (F). The children of slaves were the property not of the commonwealth, or of their own parents, but of their masters; and thus was slavery perpetuated in the families of such unhappy men as fell into that state, whether through the chance of war or the cruelty of a fordid creditor (G). The consequence was, that the number of slaves belonging to the rich Patricians was almost incredible. Caius Cæcilius Isidorus, who died about seven years before the Christian era, left to his heirs 4116 slaves; and if any one of those wretched creatures made an unsuccessful attempt to regain his liberty, or was even suspected of such a design, he was marked on the forehead with a red hot iron (H). In Sicily, during the most flourishing periods of the commonwealth, it seems to have been customary for masters to mark their slaves in this manner; at least we know that such was the practice of Damophilus, who, not satisfied with this security, shut up his slaves every night in close prisons, and led them out like beasts in the morning to their daily labour in the field. Hence arose the servile war in Sicily.

Though many laws were enacted by Augustus and other patriotic emperors to diminish the power of creditors over their insolvent debtors; though the influence of the mild spirit of Christianity tended much to meliorate the condition of slaves, even under Pagan masters; and though the emperor Adrian made it capital to kill

a slave without a just reason; yet this infamous commerce prevailed universally in the empire for many ages after the conversion of Constantine to the religion of Christ. It was not indeed completely abolished even in the reign of Justinian; and in many countries which had once been provinces of the empire it continued long after the empire itself had fallen to pieces.

It has already been observed, that among the ancient Germans it was not uncommon for an ardent gamester to lose his personal liberty by a throw of the dice. This was indeed a strong proof of savage manners; but the general condition of slaves among those savages seems to have been much better than among the polished Greeks and Romans. In Germany the slaves were generally attached to the soil, and only employed in tending cattle, and carrying on the business of agriculture; for the menial offices of every great man's house were performed by his wife and children. Such slaves were seldom beaten, or chained, or imprisoned. Sometimes indeed they were killed by their masters in a fit of sudden passion; but none were considered as materials of commerce, except those who had originally been freemen, and lost their freedom by play. These, indeed, the successful gamester was very ready to sell, both because he felt them an useless burden, and because their presence continually put him in mind of that state to which a throw of the dice might one day reduce himself.

Such is the account which Tacitus gives † of slavery among the ancient Germans. The Anglo-Saxons, however, after they were settled in this island seem not to have carried on that traffic so honourably. By a statute of Alfred the Great ‡, the purchase of a man, a horse, or an ox, without a voucher to warrant the sale, was strictly forbidden. That law was, doubtless, enacted to prevent the stealing of men and cattle; but it shows

Slavery.

13  
Slavery among the ancient Germans.

† De Mor. Germ. 24. 25.

‡ Wilkins's Collection of Laws from Ethelbert to Henry III.

us

(F) After a certain number of citations, the law granted to the debtor thirty days of grace to raise the sum for which he was accountable. The words of the law are: "Æris confessi, rebusque jure judicatis, triginti dies justi sunt. Post dein manum endojacito.—Vincito aut nervo, aut compedibus." "When the debt is confessed, and the trial passed, let there be thirty days of forbearance: afterwards lay hands on him; bind him either with a cord or fetters." After the thirty days were expired, if the debtor had not discharged the debt, he was led to the prætor, who delivered him over to the mercy of his creditors; these bound him and kept him in chains for the space of sixty days. Afterwards, for three market-days successively, the debtor was brought to the tribunal of the prætor; then a public crier proclaimed in the forum the debt for which the prisoner was detained. It often happened, that rich persons redeemed the prisoner by paying his debts; but if nobody appeared in behalf of the debtor after the third market-day, the creditor had a right to inflict the punishments appointed by the law. "Tertius nundinis capite pœnas dato aut trans Tiberim peregre venumduito;" that is, "Let him on the third market-day be punished with death, or sold beyond the Tiber as a slave." If there were several creditors, they were allowed, in consequence of this severe law, to divide the body of the prisoner into several parts, and share it among them in proportion to the sum which they demanded.

(G) This is evident from the story of Appius and Virginia. See ROMÆ, n° 113.

(H) How capriciously and unjustly this infamous mark was impressed, we learn from the story of Restio. This man being procribed, and a reward offered for his head by the triumvirs Octavianus, Antony, and Lepidus, concealed himself from the fury of the tyrants in the best way that he could. A slave whom he had marked with the hot iron having found out the place of his retreat, conducted him to a cave, and there supported him for some time with what he earned by his daily labour. At length a company of soldiers coming that way, and approaching the cave, the faithful slave, alarmed at the danger his master was in, followed them close, and falling upon a poor peasant, killed him in their presence, and cut off his head, crying out, "I am now revenged on my master for the marks with which he has branded me." The soldiers, seeing the infamous marks on his forehead, and not doubting but he had killed Restio, snatched the head out of his hand, and returned with it in all haste to the triumvirs. They were no sooner gone, than the slave conveyed his master to the sea-side, where they had the good luck to find one of Sextius Pompeius's vessels, which transported them safe into Sicily.

-Slavery.  
in England  
and

us that so late as the ninth or tenth century a man, when fairly purchased, was, in England, as much the property of the buyer as the horse on which he rode, or the ox which dragged his plough. In the same country, now so nobly tenacious of freedom and the rights of man, a species of slavery similar to that which prevailed among the ancient Germans subsisted even to the end of the sixteenth century. This appears from a commission issued by Queen Elizabeth in 1574, for inquiring into the lands and goods of all her *bond-men* and *bond-women* in the counties of Cornwall, Devon, Somerset, and Gloucester, in order to compound with them for their manumission, that they might enjoy their lands and goods as freemen ||. In Scotland there certainly existed an order of slaves or bond-men, who tilled the ground, were attached to the soil, and with it were transferable from one proprietor to another, at a period so late as the thirteenth century; but when or how those villains, as they were called, obtained their freedom, seems to be unknown to every lawyer and antiquary of the present day. Coalliers and salters were, in the same country, slaves till little more than 20 years ago, that they were manumitted by an act of the British legislature, and restored to the rights of freemen and citizens. Before that period the sons of coalliers could follow no business but that of their fathers; nor were they at liberty to seek employment in any other mines than those to which they were attached by birth, without the consent of the lord of the manor, who, if he had no use for their services himself, transferred them by a written deed to some neighbouring proprietor.

|| Kames's  
Sketches,  
book i.  
Sketch 5.  
15  
Scotland.

16  
Slavery among the  
Carthaginians,

That the savage nations of Africa were at any period of history exempted from this opprobrium of our nature which spread over all the rest of the world, the enlightened reader will not suppose. It is indeed in that vast country that slavery has in every age appeared in its ugliest form. We have already observed, that about the era of the Trojan war, a commerce in slaves was carried on between Phœnicia and Lybia: and the Carthaginians, who were a colony of Phœnicians, and revered the customs, manners, and religion of their parent state, undoubtedly continued the Tyrian traffic in human flesh with the interior tribes of Africa. Of this we might rest assured, although we had no other evidence of the fact than what results from the practice of human sacrifices so prevalent in the republic of Carthage. The genuine instincts of nature are often subdued by dire superstition, but they cannot be wholly eradicated; and the rich Carthaginian, when a human victim was demanded from him to the gods, would be ready to supply the place of his own child by the son of a poor stranger, perfidiously purchased at whatever price. That this was, indeed, a very common practice among them, we learn from the testimony of various historians\*, who assure us, that when Agathocles the tyrant of Syracuse had overthrown their generals Hanno and Bomilear, and threatened Carthage itself with a siege, the people attributed their misfortunes to the just anger of Saturn for having been worshipped, for some years, by the sacrifices of children meanly born and secretly bought, instead of those of noble extraction. These substitutions of one offering for another were considered as a profane deviation from the religion of their forefathers; and therefore to expiate the guilt of so horrid an impiety, a sacrifice of two hundred children of the

first rank was on that occasion made to the bloody god. As the Carthaginians were a commercial people, we cannot suppose that they purchased slaves only for sacrifices. They undoubtedly condemned many of their prisoners of war to the state of servitude, and either sold them to foreigners, or distributed them among their senators and the leaders of their armies. Hanno, who endeavoured to usurp the supreme power in Carthage whilst that republic was engaged in war with Timoleon in Sicily †, armed twenty thousand of his slaves in order to carry his nefarious purpose into execution; and Hannibal, after his decisive victory at Cannæ, sold to the Greeks many of his prisoners whom the Roman senate refused to redeem ¶. That illustrious commander was indeed more humane, as well as more politic, than the generality of his countrymen. Before his days it was customary with the Carthaginians either to massacre their captives in cold blood, that they might never again bear arms against them, or to offer them in sacrifice as a grateful acknowledgment to the gods by whose assistance they believed that they were vanquished; but this was not always done even by their most superstitious or most unprincipled leaders. Among other rich spoils which Agathocles, after his victory already mentioned, found in the camp of Hanno and Bomilear, were twenty thousand pair of fetters and manacles, which those generals had provided for such of the Sicilian prisoners as they intended to preserve alive and reduce to a state of slavery.

Slavery  
† Juslin.  
lib. xxi.  
cap. 6. a  
Univers.  
History.  
Tit. I.  
Appian  
Zonaras

With the ancient state of the other African nations we are but very little acquainted. The Numidians, Mauritians, Getulians, and Garamantes, are indeed mentioned by the Roman historians, who give us ample details of the battles which they fought in attempting to preserve their national independence; but we have no particular account of their different manners and customs in that age when Rome was disputing with Carthage the sovereignty of the world. All the African states of which we know any thing, were in alliance with one or other of those rival republics; and as the people of those states appear to have been less enlightened than either the Romans or the Carthaginians, we cannot suppose that they had purer morals, or a greater regard for the sacred rights of man, than the powerful nations by whom they were either protected or oppressed. They would, indeed, insensibly adopt their customs; and the ready market which Marius found for the prisoners taken in the town Capsa, although Sallust acknowledges ‡ that the sale was contrary to the laws § of war, shows that slavery was then no strange thing to the Numidians. It seems indeed to have prevailed through all Africa from the very first peopling of that unexplored country; and we doubt if in any age of the world the unhappy negro was absolutely secure of his personal freedom, or even of not being sold to a foreign trader.

17  
And Numidians

It is the common opinion that the practice of making slaves of the negroes is of a very modern date; that it owes its origin to the incursions of the Portuguese on the western coast of Africa; and that but for the cunning or cruelty of Europeans, it would not now exist, and would never have existed. But all this is a compilation of mistakes. A learned writer has lately proved, with a force of evidence which admits of no reply\*, that from the Coast of Guinea a great trade in slaves was

† Bell. §  
cap. 91.

18  
Slave-tr  
with the  
cost of  
Guinea  
the Port  
gun not  
the Port  
guine.  
Whitak  
Reviews  
Gibbon's  
Roman  
was History.

\* Polyb.  
D. Curt.  
Diod. Sic.  
See also  
Ancient  
Universal  
History,  
vol. xv.

was carried on by the Arabs some hundreds of years before the Portuguese embarked in that traffic, or had even seen a woolly-headed negro. Even the wandering Arabs of the desert, who never had any friendly correspondence with the Christians of Europe, have from time immemorial been served by negro slaves. "The Arab must be poor indeed (says M. Saignier) not to have at least one negro slave. His sole occupation is the care of the herd. They are never employed in war, but they have it in their power to marry. Their wives, who are captive negroes, do all the domestic work, and are roughly treated by the Arabian women, and by the Arabs themselves. Their children are slaves like them, and put to all kinds of drudgery." Surely no man whose judgement is not completely warped by prejudice, will pretend that those roving tribes of savages, so remarkable for their independent spirit and attachment to ancient customs, learned to enslave the negroes from the Europeans. In all probability they have, without interruption, continued the practice of slavery from the days of their great ancestor Ishmael; and it seems evident, that none of the European nations had ever seen a woolly-headed negro till the year 1100, when the crusaders fell in with a small party of them near the town of Hebron in Judea, and were so struck with the novelty of their appearance, that the army burst into a general fit of laughter ||. Long before the crusades, however, we know with certainty that the natives of Guinea had been exposed to sale in foreign countries. In 651 the Mahometan Arabs of Egypt so harassed the king of Nubia or Ethiopia, who was a Christian, that he agreed to send them annually, by way of tribute, a vast number of Nubian or Ethiopian slaves into Egypt. Such a tribute as this at that time, we are told, was more agreeable to the khalif than any other, as the Arabs then made no small account of those slaves †.

The very proposal of such a tribute, and the estimation in which black slaves were held in Egypt, shows that a commerce in bond-servants could not then be a new branch of trade either to the Arabs or the Ethiopians; but the vast number which the Ethiopian monarch was now compelled to furnish every year, induced him to feed this great drain upon his subjects from the natives of the neighbouring countries. "He ranged accordingly into all that vast blank of geography upon the map of the world, the spreading bosom of the African continent; and even pushed through it to its farthest extremities in the west. He thus brought the blacks of Guinea, for the first time, into the service and families of the east; and the slaves which he paid in tribute to the Arabs, whether derived from the nearer neighbourhood of Ethiopia, fetched from the mediterranean regions of Africa, or brought from the distant shores of the Atlantic, were all denominated Ethiopians, from the country by which they were conveyed into Egypt †. "At this time, therefore, according to Mr Whitaker, began that kind of traffic in human flesh

"Which spoils unhappy Guinea of its sons."

There are not many authors from whom, in questions of antiquity, we differ with greater hesitation; but, as we meet with a female Ethiopian slave in the Eunuch of Terence, we cannot help suspecting that Guinea was occasionally "spoiled of its sons" at a much earlier period. At any rate, from the observations made by the European

travellers who first penetrated into that continent, it appears undeniable that slavery must have prevailed from time immemorial among such of the tribes as had never carried on any commerce with foreign nations. When Battel first visited the Giagas\*, those people had never before seen a white man; yet they welcomed him and the English, with whom he had come, to their country, invited them to bring their goods on shore, and without hesitation loaded the ship with slaves. The Giagas were indeed waging war with the kingdom of Benguela; and being cannibals, who prefer human flesh to all others, the slaves whom they had sold to the English were probably prisoners whom they would have killed and eaten if they had not found an opportunity of otherwise disposing of them to greater advantage. But as they had not been incited by the Europeans to eat their prisoners, there can be no reason to suppose that by the Europeans they had been first induced to sell them: for we have seen that this kind of commerce prevailed in Africa among people much more polished than the Giagas so early as in the reign of Jugurtha.

That it was not introduced among the negroes either by the Arabs or by the Portuguese, appears still more evident from the behaviour of the Dahomans at the conquest of Whidah, and from the manner in which the people of Angola at the earliest stage of their foreign trade procured a supply of slaves for the Portuguese market. The greater part of the slaves whom the Angolans exported from St Paulo de Loanda were brought from interior countries, some hundreds of leagues distant, where they could not have been regularly purchased had that commerce been till then unknown in those countries. The Dahomans, in the beginning of the year 1727, had never seen a white man; and when their victorious prince and his army, in their rout through Whidah, first met with some Europeans in the town of Sabi, they were so shocked at their complexion and their dress, that they were afraid to approach them, and could not be persuaded that they were men till they heard them speak, and were assured by the Whidancese that these were the merchants who purchased all the slaves that were sold in Guinea †. Slavery, therefore, if it prevailed among the Dahomans before that period, could not have been introduced among them by European or Arabian intrigues: but we are assured by Snelgrave, who was then in the army, that those people treated their captives with such horrid cruelty as was shocking to the natives of the sea-coast, and leaves no room for doubt but that slavery had been practised among them from the earliest ages. A great part of their prisoners were sacrificed to their gods or eaten by the soldiers; and when our author expressed to a colonel of the guard some surprise that a prince so enlightened as the sovereign of Dahomy should sacrifice so many men whom he might have sold to great advantage, he was gravely told, that it had been the custom of their nation, from time immemorial, to offer, after victory, a certain number of prisoners to the gods; and that they selected the old men for victims, because they were of less value at market, and more dangerous from their experience and cunning, than the young men. To those persons who fancy that the wars between the African princes are carried on for the sole purpose of supplying the European ships with slaves, it may be proper to remark, that one of the kings of Dahomy slaughtered at once not only all the captives tak-

Slavery.

20

The ne-

groes have

enslaved

one ano-

ther from

time im-

memorial.

\* Modern

Universi-

History,

v. l. xiii.

chap. 47-

sect. 2.

†

†

†

†

†

†

†

†

†

†

†

†

†

†

†

†

†

†

†

†

†

†

†

†

†

†

†

†

†

†

†

†

†

†

†

†

†

†

†

†

†

†

†

†

†

†

†

Slavery.

ken in war, but also 127 prisoners of different kinds, that he might have a sufficiency of skulls to adorn the walls of his palace; though at the very time of that massacre he *knew* that there were six slave-ships in the road of Whidah from which he could have got for every prime slave a price little short of thirty pounds Sterling †.

† Dalzel's  
History of  
the King-  
dom of Da-  
homy.

These facts, and numberless others which the reader will find detailed in the 13th volume of the Modern Universal History, by writers who were at the greatest pains to procure authentic information; who were neither biassed by interest nor blinded by enthusiasm; and who appear to have held the infamous traffic in utter abhorrence—prove beyond the possibility of doubt, that slavery of the worst kind must have prevailed among all the negro nations before they were visited either by the Portuguese or by the Arabs (1). These two nations may indeed have been the first who dragged the unhappy negro from his native continent, and made his slavery doubly severe, by compelling him to labour, without his own consent, for masters whom he hardly considered as human beings.

On the beginning of this commerce, or the dreadful cruelty with which it has been carried on to the present day, it is impossible to reflect without horror: but there is some consolation, however small, in knowing that its original authors were not Europeans. The purchase of Guinea blacks for slaves by foreign nations commenced ages before the Portuguese had laid that country open to the intercourse of Europe. Even after they had made many incursions into it, the inhabitants were as regularly purchased for slaves by some of the adjoining states as they are now by the maritime Europeans.

21  
The route  
by which  
the Arabs  
carried on  
the slave-  
trade,  
Whitaker's  
Review,  
p. 185.

“The Arabs of Egypt having reduced all the north of Africa, and carrying with them their love of black servants, would be sure to open a ready communication for themselves to their country. They certainly had one so early as 1512, and before the Europeans had any for that purpose (κ). They went from Barbary by a route that was so much practised, as to be denominated expressly ‘the way of the camels.’ Meeting together at the town of Cape Cantin, that of Valadie near it, the commercial caravan traversed the vast deserts,

those of Sarra, which run like the tropic of Cancer over them in a long line across the country; to a place of great population called Hoden, the *Waden* or *Hoden* of our maps, and a little to the south-west of Cape Blanco. From Hoden they turned to the left, and pushed directly into the interior of the continent, to reach Tegazza, the *Tagazel* or *Tagaza* of our maps, and lying nearly east of Hoden. Here assuredly they did, as the caravan does certainly at this day; and added to the other wares upon their camels a quantity of salt from those mines of rock-salt, which are extraordinary enough to be noticed as rocks in our maps. This they carried, as they still carry it, to Tanbut, the *Tombut* of the maps, and a town in the heart of the African continent. And from this town they turned on the right for the sea-coast again, and reached it in the great kingdom of Mele, the *Melli* of our maps, to the south of the Gambia, and just at the springing as it were of that grand arch of sea which curves so deeply into the body of the land, and constitutes the extensive gulph of Guinea. At Melli and at Tombut they received a measure of gold for a measure of salt. The caravan collects gold at Tombut to the present time; but at Melli they purchased gold, and also silver, in pieces as large as pebbles. And at Hoden they had a *great mart for slaves*; the blacks being brought thither from the countries adjoining, and bartered away to the traders. Such was the Slave Coast and the Gold Coast of former days. The staple commodity of Hoden is only transferred now to Whidah; and diverted from the Arabs of Barbary to the Christians of Europe,” by whom the negroes are carried to the continent of America or to the Sugar Islands in the West Indies. In these countries they are all sold like beasts in a market; but they experience very different degrees of servitude from the different masters who hold them as property. Such of them as are reconciled to the appearance of white men, or have been born in the European colonies, feel themselves as happy under a humane master as they could be in their native continent (λ); and we believe that few of them in such circumstances have expressed a desire to return.”

In the French West India islands, before the late revolution

(1) The same thing appears from the voyages of M. Saugnier, who had an opportunity of conversing with many tribes of negroes, and who always speaks of slavery as an established practice among them; adding, that such as are sold for crimes are put to death by their own countrymen if they fly from their master. It appears likewise in a still more striking light from Dalzel's History of Dahomy, where we are told that all the Dahomans, from the lowest to the highest, acknowledge the right of the sovereign to dispose of their persons and properties at pleasure; and where we learn, that the sovereign himself assured Mr Abfon the English governor at Whidah, that all his ancestors had from time immemorial put to death every prisoner of war whom they could not sell as a slave.

(κ) In the year 1442, Anthony Gonfalez, a Portuguese adventurer, restored to their native country some Moorish prisoners whom he had two years before forcibly carried off from the coast of Africa. He landed them at *Rio del-Oro*, and received from the Moors in exchange ten blacks and a quantity of gold dust. This transaction proves, that a commerce in black servants was then regularly carried on by the Moors and not by the Portuguese. So early as the year 1502, the Spaniards began to employ a few negroes in the mines of Hispaniola; but in the year following, Ovando, the governor of that island, forbade the further importation of them, alleging that they taught the Indians all manner of wickedness, and rendered them less tractable than formerly: and it was not till the year 1517 that the supply of negroes to the Spanish American plantations became an established and regular branch of commerce. *Edward's History of the West Indies*, Book IV. Chap. ii.

(λ) “I have observed many of my slaves go on board the vessel with joy, on my assurance that they would be well treated and happy on the plantation where I was going to send them. When the Banbarans find that they are trusted by the whites, they never think of making their escape, choosing to be the slaves of Europeans rather than



revolution in the mother country, which has produced in all its dependencies anarchy and massacre, the condition of the negro-slaves was better than that of the bondmen among the ancient Germans. "Those of them who cultivated the plantations were attached to the soil, and could not be drawn off to pay debts, or be sold separately from the estate on which they lived. This gave them a lasting property in their huts and little spots of ground, which they might safely cultivate without dread of being turned out of possession, or transferred contrary to their interest and feelings from one proprietor to another. They were under the protection of law as soon as they arrived in the colony. Proper missionaries were appointed for the purpose of training them up to a certain degree of religious knowledge, and ample funds were allotted for the maintenance of those ecclesiastics. On ill treatment received from his master, or on being deprived of his allowance of food and raiment, the slave was directed to apply to the king's attorney, who was obliged to prosecute the master forthwith. That officer was also bound to prosecute, if by any other means he heard of the abuse; the law adding as the reason, *This we will to be observed, to check the abuse of power in the master* †."

We wish it were in our power to say, that in the British West India colonies slaves are equally protected by law as they were in the French islands under the old government, and that the same care is taken of their moral and religious improvement. This, however, we are afraid, cannot be said with truth. In the island of Jamaica, before the passing of the *consolidated slave act*, not many years ago, a white man, whether proprietor or not, who had killed a negro, or by an act of severity been the cause of his death, was, for the first offence, intitled to benefit of clergy, and not liable to capital punishment till a repetition of the crime. By the present law, it is enacted, "That if any person, whether owner or superintendant of slaves, shall be convicted of having, by any act of passion or cruelty, occasioned the death of any negro, it shall be capital for the first offence: and for the greater security of the property, and as a check on those who may have the punishment of slaves in their power, it is particularly required, that every surgeon or doctor belonging to each estate shall swear to the cause of the death of each negro, to the best of his knowledge and belief; and if any negro dies, and is interred by the owner or overseer, without the doctor's having seen or been sent for to such negro, in this case, the owner or overseer causing the negro to be so interred is liable to a prosecution for such conduct."

This law must doubtless be productive of good effects; but being a colonial act, it cannot have the vigour of the *Code Noir*; nor do we know of any attorney in the island who is obliged to defend the rights of the negroes, or prosecute the master whose cruelty has by any means

come to his knowledge. The justices and vestry of each parish are indeed constituted a *council of protection*, for the express purpose of making full enquiry into the barbarities exercised on slaves, and bringing the authors to punishment at the public expence; and by a new slave-act of Grenada, the justices are required annually to nominate three freeholders to be *guardians of the slaves*, who are to take an oath to see the law duly executed †. These are benevolent regulations; but we doubt if protection can be so promptly afforded by a council of guardians as by an individual attorney who has no other employment. In some of the other British islands, we have been confidently told that the unfortunate sons of Africa have no protection whatever against the tyranny of a fardid owner, or the caprice of a boyish overseer (M); though it is added, that the humanity of many masters more than supplies the want of laws in every respect but that of improvement, and that the attachment of others has in them a like effect. In some cases good sense, a regard for their reputation, and a well-informed conviction of their interest, induce men to treat their slaves with discretion and humanity. The slaves of many a planter possess advantages beyond what the labourer even of Britain enjoys †; yet these advantages all depend upon the good will of his master; and in no part of the British colonies are the slaves attached to the soil. This single circumstance, together with the total neglect of their moral and religious culture, makes their situation much less eligible than was that of the French slaves under the old government; and affords a striking proof of what the humane author whom we have just quoted well observes, that "those men and nations whom liberty hath exalted, and who therefore ought to regard it tenderly in others, are constantly for restraining its blessings within their own little circle, and delight more in augmenting the train of their dependants than in adding to the rank of fellow-citizens, or in diffusing the benefits of freedom among their neighbours."

Having given this ample detail of the rise and progress of slavery in the world, and shown that it has prevailed in every age, and under all religions, we shall now proceed to enquire whether a practice so general be in any instance lawful; and if it be, how it must be modified, in order to be rendered consistent with the rights of man and the immutable laws of virtue.

That in a state of nature one man has a right to seize upon another, and to compel him by force to labour for his subsistence, is a position which we believe has never been seriously maintained. But independent communities stand to each other in the very same relation that individuals do in a state of nature; and therefore if in such a state the man of greater bodily strength or mental sagacity would have no right to convert his weaker neighbour into personal property, neither can

Slavery.

† Edwards's  
History of  
the West  
Indies,  
book iv.  
chap. 5.

† Ramsay's  
Essay,  
p. 66. and  
91.

25  
The law-  
fulness of  
slavery in-  
quired in-  
to.

than of a black man who would treat them with the greatest cruelty. *Voyages to the Coast of Africa by Messrs Savignier and Briffon*, p. 332. 335. English Translation.

(M) In Barbadoes there is said to be a law for the protection of slaves, which is the most insolent triffing with justice and humanity that the writer of this article has ever seen. It is enacted, forsooth, "That if any man shall, of wantonness, or only of bloody-mindedness, or cruel intention, wilfully kill a negro or other slave, of his own, he shall pay into the public treasury fifteen pounds Sterling!" See *Dickson's Letters on Slavery*, p. 4.

*Slavery.* the more powerful and enlightened nation have a right to carry off by force, or entice by fraud, the subjects of a weaker and more barbarous community for the purpose of reducing them to a state of servitude. This is a truth so obvious as to admit neither of proof nor of denial.

26  
The common apology for it is insufficient.

In thus stating the case between two independent nations, we have in our eye that traffic in slaves which is carried on between the civilized Europeans and the barbarous Africans: and the utmost length which we think an apology for that trade can go is to contend, that we may lawfully purchase slaves in those countries where from time immemorial they have been a common branch of commerce. But the European right to purchase cannot be better than the African right to sell; and we have never yet been informed what gives one African a right to sell another. Such a right cannot be natural, for the reason which we have elsewhere assigned (see RIGHT): neither can it be adventitious; for adventitious rights are immediately derived from the municipal law, which is the public will of the state. But the state has no authority to deprive an innocent man of his personal freedom, or of the produce of his own labour; for it is only to secure these, by protecting the weak from the violence of the strong, that states are formed, and individuals united under civil government.

27  
No man has a right to give himself up to the absolute disposal of another.

It may perhaps be said, that by patiently submitting to governments which authorise the traffic in human flesh, men virtually give up their personal liberty, and vest their governors with a right to sell them as slaves: but no man can vest another with a right which he possesses not himself; and we shall not hesitate to affirm, that in a state of nature, where all have equal rights, no individual can submit himself to the absolute disposal of another without being guilty of the greatest crime. The reason is obvious. From the relation in which men stand to one another as fellow-creatures, and to God as their common Creator, there are duties incumbent upon each peculiar to himself; in the performance of which he can be guided only by his own reason, which was given him for that very purpose. But he who renounces his personal freedom, and submits unconditionally to the caprice of a master, impiously attempts to set himself free from the obligation of that law which is interwoven with his very being, and chooses a director of his conduct different from that which God has assigned him. A man therefore cannot put himself in a state of unconditional servitude; and what he cannot do for himself, he surely cannot authorize others to do for him either by a tacit or by an open consent.

28  
What kind of slavery may be employed as a punishment.

These considerations have often made us regret that writers, for whose talents and integrity we have the highest respect, should, without accurately defining what they mean by slavery, have peremptorily affirmed, that, consistently with the law of nature men may be reduced to that state as a punishment for crimes, or to discharge debts which they cannot otherwise pay. That a criminal, who has forfeited his life to the laws of his country, may have his punishment commuted for hard labour, till death in the course of nature shall put a period to his terrestrial existence, is a truth which we apprehend cannot be controverted; but to make such a commutation of punishments consistent with the laws of nature and of nature's God, it appears to us that the

kind and degree of labour must be precisely ascertained, and the conduct of the criminal not left to the capricious direction of any individual.

Punishments can be justly inflicted only for one or other of two ends, or for both. They may be calculated either to reform the criminal or to be a warning to the innocent; and those which most effectually answer both these purposes are surely to be preferred to such as answer but one of them. For this reason we consider hard labour as a much fitter punishment for most crimes than death: but to intitle it to preference, the kind and degree of the labour must be ascertained by the law; for if these circumstances be omitted, and the offender delivered over as a slave to the absolute disposal and caprice of a private master, the labour to which he is condemned, instead of operating to his reformation, may be converted into the means of tempting him to the commission of new crimes. A young woman, in the state of servitude, would hardly be able to maintain her virtue against the solicitations of a master who should promise her liberty or a remission of toil upon her yielding to his desires; and the felon, who had long been accustomed to a life of vagrancy and idleness, would not strenuously object to the perpetration of any wickedness to obtain his freedom, or even a diminution of his daily task. Indeed such temptations might be thrown in his way, as human nature could not resist but by means of much better principles than felons can be supposed to possess. He might be scourged into compliance; or his labour might be so increased as to make him for a little respite eagerly embrace the most nefarious proposal which his master could make: for being absolute property, there is no earthly tribunal to which he could appeal for justice; and felons do not commonly support themselves under trials by pious meditation on a future state.

By reasoning in this way, we are far from meaning to insinuate that slave-holders in general torture their slaves into the commission of crimes. God forbid! Many of them we know to be religious, humane, and benevolent: but they are not infallible; and some of them may be intigated, some of them undoubtedly have been intigated, by avarice and other worse principles, to compel creatures, who are so absolutely their dependents, to execute deeds of darkness too hazardous for themselves. But the morality or immorality of any action, and the moral fitness of any state, are to be judged of by their natural tendency, if the one were universally practised and the other universally prevalent (see MORAL PHILOSOPHY, n<sup>o</sup> 156.): and as the natural tendency of absolute domestic slavery among such creatures as men is to throw the most powerful temptations to vice in the way both of master and of slave, it must be in every instance, even when employed as a punishment, inconsistent with the fundamental principles of moral virtue.

Some writers indeed have maintained, and the civil law seems to suppose, that children are the property of their parents, and may by them be sold as slaves in cases of urgent necessity: but if we duly consider how property is acquired (see PROPERTY), and attend to the natural consequences of slavery, we shall soon be convinced that this opinion is very ill founded. The rights of parents result from their duties; and it is certainly the duty of that man who has been the instrument of bringing into the world an intellectual and moral being,

to do every thing in his power to render the existence of that being happy both in the present life and in that which is to come. If this duty be conscientiously discharged, the parent has a manifest right to the gratitude, love, and reasonable obedience, of his child; but he cannot, in consequence of any duty performed, claim a right to transfer that child as property to the uncontrolled disposal of any private master; for this plain reason, that the man who is considered as the private property of another, cannot reasonably be supposed to enjoy happiness in this world, and is under many temptations to do what must necessarily render him miserable in the next. See MORAL PHILOSOPHY, n<sup>o</sup> 138.

If criminals cannot be lawfully reduced to a state of absolute private slavery, much less surely can it be lawful to reduce insolvent debtors and prisoners of war to that state. Many a virtuous man, who has contracted debts with the fairest prospect of paying them, has been suddenly rendered insolvent by fire, by shipwreck, or by the bankruptcy of others with whom he was necessarily engaged in the course of his trade. Such a man can be considered in no respect as criminal. He has been indeed unfortunate; but it would be grossly unjust, as well as shockingly cruel, to add to his misfortune by reducing him to a state to which we have just seen that the vilest felon cannot be reduced without a violation of the laws of morality. Fraudulent bankrupts indeed, of whom we daily see many, might with great propriety and the strictest justice be compelled to extenuate their debts by labouring for the benefit of those whom they have injured; and criminals of other descriptions might be made to work for the benefit of the public: but in both cases the task to be performed should be ascertained by the law, and the persons of the labourers be protected by the state. If such can be called slaves, their slavery is undoubtedly consistent with every principle of virtue and religion; for they suffer nothing but the due reward of their deeds. Prisoners of war, however, can upon no honest principle be reduced even to this state of mitigated bondage; for they are so far from incurring guilt by fighting for their country, that even to their enemies their courage and conduct in such a cause must appear worthy of reward. A victorious general has certainly a right to prevent the prisoners taken in battle from again drawing their swords against him during the continuance of the war; but there are many ways by which this may be done effectually without chaining the unfortunate captives to the oar, or selling them like cattle to private purchasers, by whom they may be treated with capricious cruelty, and driven to the perpetration of the greatest crimes.

To these conclusions, and the reasoning on which they are built, we are aware it may be objected, that if private slavery were in every instance unlawful and inconsistent with the fundamental principles of morality, it would not have prevailed among the ancient patriarchs, and far less have been authorized by the Jewish law.

In reply to this objection, it may be observed, that Abraham, Isaac, and Jacob, though excellent men, were not characters absolutely perfect; that as their practice does not authorize polygamy or incest among us, it will not authorize the reducing of our fellow-creatures to a state of hopeless servitude; and that from the circumstances of the age in which they lived, many things

were permitted to them, and were indeed harmless, which are forbidden to us, and would now be pernicious. The character of Abraham appears to have been much more perfect than that of his son or grandson; and was certainly equal, if not superior, to that of any other mere man of whom we read either in profane or even in sacred history. We are to remember, however, that he was born amidst idolaters, and was probably an idolater himself till enlightened by the inspiration of Jehovah, and called from his kindred and from his father's house. Before his conversion, he must have had much cattle and many slaves, which constituted the riches of that early period; and his case would indeed have been peculiarly hard, had he been commanded to divest himself of his servants, and to depart into a strange country very thinly inhabited, without people to protect his flocks and herds from beasts of prey. Nor would his loss have contributed in any degree to the benefit of his slaves, who, as the ranks of men were then adjusted, could not long have preserved their liberty. Had they not been forcibly reduced to their former state by their idolatrous countrymen, which in all probability they would have been, they must have soon submitted to it, or perished by hunger. Let it be remembered, too, that the bond-servants of Abraham, though constituting the most valuable part of his property, were not considered as a species of inferior beings, but were treated rather as children than as slaves. This is evident from his speaking of the steward of his house as his heir, when complaining to God of the want of seed. Indeed the manner in which this circumstance is mentioned, shows that it was then the general practice to consider domestic slaves as members of the family; for the patriarch does not say, "I will leave my substance to this Eliezer of Damascus;" but his words are, "Behold to me thou hast given no seed; and, lo! one born in my house is my heir." From this mode of expression; Gen. xv. we are strongly inclined to think that captives taken in war were in that age of simplicity incorporated into the family or tribe of the conqueror, as they are said to be at present among the North American Indians, to supply the place of those who had fallen in battle. If so, slavery was then a very mild thing, unattended with the evils which are now in its train, and must often have been highly beneficial to the captive.

The other part of the objection appears at first sight more formidable: but perhaps a little attention to the design of the Mosaic economy may enable us to remove it even more completely than this. We need not inform our theological readers, that one great purpose for which the posterity of Abraham were separated from the heathen nations around them, was to preserve the knowledge of the true God in a world run headlong into idolatry. As idolatry appears to have had something in its forms of worship extremely captivating to rude minds, and as the minds of the Israelites at the era of their departure from Egypt were exceedingly rude, every method was taken to keep their separation from their idolatrous neighbours as complete as possible. With this view they were commanded to sacrifice the animals which their Egyptian masters had worshipped as gods, and were taught to consider hoys and such other creatures as the heathen offered in sacrifice, when celebrating their mystical and magic rites, as too unclean to be eaten or even to be touched. Of this di-

Slavery.

distinction between clean and unclean beasts, God himself assigns the reason: "I am the Lord your God (says he), who have separated you from other people; ye shall therefore put difference between clean and unclean beasts, and between unclean fowls and clean †." For the same reason they were prohibited from intermarrying with the heathen, or having any transaction whatever with them as neighbours; and the seven idolatrous nations of Canaan they were strictly commanded to exterminate. "When the Lord thy God (says Moses) shall deliver them before thee, thou shalt smite them, and utterly destroy them; thou shalt make no covenant with them, nor show mercy unto them: neither shalt thou make marriages with them: thy daughter thou shalt not give unto his son, nor his daughter shalt thou take to thy son; for they will turn away thy son from following me, that they may serve other gods ‡."

† Lev. xv.  
24, 25, 26.

‡ Deut. vi.  
30, 31.

Under these laws, it is plain that no intercourse whatever could have place between an Israelite and a man of any other nation, unless the latter was reduced to such a state as that he could neither tempt the former nor practise himself the rites of his idolatrous worship. But the Israelites were not separated from the rest of the world for their own sakes only: They were intended to be the repositories of the lively oracles of God, and gradually to spread the light of divine truth thro' other nations, till the fulness of time should come, when in Christ all things were to be gathered together in one. To answer this end, it was necessary that there should be some intercourse between them and their Gentile neighbours; but we have seen that such an intercourse could only be that which subsists between masters and their slaves.

Should this apology for the slavery which was authorized by the Jewish law be deemed fanciful, we beg leave to submit to the consideration of our readers the following account of that matter, to which the same objection will hardly be made. It was morally impossible that between nations differing so widely in religion, customs, and manners, as the Jews and Gentiles, peace should for ever reign without interruption; but when wars broke out, battles would be fought, and prisoners would be taken. How were these prisoners to be disposed of? Cartels for exchange were not then known: it was the duty of the Israelites to prevent their captives from taking up arms a second time against them; they could not establish them among themselves either as artificers or as husbandmen; for their law enjoined them to have no communication with the heathen. There was therefore no other alternative but either to massacre them in cold blood, or to reduce them to the condition of slaves. It would appear, however, that those slaves were raised to the rank of citizens, or at least that their burdens were much lightened, as soon as they were convinced of the truth of the Mosaic revelation, and received into covenant with God by the rite of circumcision. They were then admitted to the celebration of the passover; concerning which one law was decreed to the stranger, and to him that was home-born. Indeed, when we consider who was the legislator of the Jews; when we reflect upon the number of laws enacted to mitigate slavery among them, and call to mind the means by which the due execution of all their laws was enforced, (see THEOLOGY), we

cannot help being of opinion that the heathen, who was reduced to slavery in Judea, might be happier, if he pleased, than when living as a freeman in his own country. But whether this be so or not, is a matter with which we have no concern. On account of the hardness of their hearts, and the peculiarity of their circumstances, many things, of which slavery may have been one, were permitted to the Jews, which, if practised by Christians, would render them highly guilty.

After treating thus largely of slavery in general, we need not occupy much of the reader's time with the

SLAVE-TRADE carried on at present by the merchants of Europe with the natives of Africa. It is well known that the Portuguese were the first Europeans who embarked in this trade, and that their example was soon followed by the Dutch and the English. Of the rise and progress of the English commerce in slaves, the reader will find a sufficient account in other articles of this work. That commerce, though long cherished by the government as a source of national and colonial wealth, was from its commencement considered by the thinking part of the nation as a traffic inconsistent with the rights of man, and suspected to be carried on by acts of violence. These suspicions have been gradually spread through the people at large, and confirmed, in many instances, by evidence incontrovertible. Laws have in consequence been enacted to make the negroes more comfortable on what is called the middle passage, and to protect them against the wanton cruelty of their masters in the West Indies: but the humanity of the nation was roused; and not many years ago a number of gentlemen, of the most respectable characters, finding that no adequate protection can be afforded to persons in a state of hopeless servitude, formed themselves into a society at London, for the purpose of procuring a total abolition of the slave-trade. That the motives which influence the leading men of this society are of the purest kind, cannot, we think, be questioned; for their object is to deliver those who had none to help them, and from whom they can expect no other reward for their labours of love than the blessings of them who are ready to perish. To a cause so truly Christian, who would not pray for success? or who but must feel the most pungent regret, if that success has been rendered doubtful, or even been delayed, by the imprudence of some of the agents employed by the society? This we apprehend to have been really the case. Language calculated only to exasperate the planters cannot serve the negroes; and the legislature of Great Britain will never suffer itself to be forced into any measure by the menaces of individuals.

In the year 1793, petitions were presented to parliament for the abolition of this inhuman traffic, which gave a pleasing picture of the philanthropy of the nation; but, unfortunately for the cause of freedom, it was discovered that many of the names subjoined to those petitions had been collected by means not the most honourable. This discovery, perhaps, would never have been made, had not the insulting epithets indiscriminately heaped upon the slave-holders provoked those men to watch with circumspection over the conduct of their opponents. The consequence was, that suspicions of unfair dealing on the part of the petitioners were excited

Slavery.

34

§ See  
P. 225.  
Guinea.

35  
Petition  
for the  
abolition  
it.

ave- cited in the breads of many who, though they ardently  
 te. wiled well to the cause, chose not to add their  
 names to those of school-boys under age, and of pea-  
 sants who knew not what they were subscribing. Let  
 the ri. hts of the Africans be maintained with ardour  
 and firmness; but never let their advocates suppose that  
 the cause of humanity requires the support of artifice.  
 Absolute slavery, in which the actions of one man are  
 regulated by the caprice of another, is a state demon-  
 strably inconsistent with the obvious plan of the moral  
 government of the world. It degrades the mental  
 faculties of the slave, and throws, both in his way and  
 in his master's, temptations to vice almost insurmount-  
 able. Let these truths be set in a proper light by  
 those who have doubtless seen them exemplified; and  
 they will surely have their full effect on the minds of a  
 generous, and, we trust, not yet an impious people (n).  
 The trade will be gradually abolished; pains will be ta-  
 ken to cultivate the minds of the West Indian negroes;  
 and the era may be at no great distance when slavery  
 shall cease through all the British dominions.

66 But what benefit, it will be asked, would the ne-  
 gation gres of Africa reap from an abolition of the slave  
 the abo- trade? Should any thing so wildly incredible happen,  
 as that all the nations of Christendom, in one common  
 paroxysm of philanthropy, should abandon this com-  
 merce in servants, which has been prosecuted in all  
 ages, and under all religions; they would only abandon  
 it to those who were originally possessed of it, who still  
 penetrate into the country, and who even push up to  
 Gago at the very head of the slave coast; and leave the  
 wool-headed natives of it to Mahometan masters, in  
 preference to Christian. Under such masters they were  
 in Judea at the time of the crusades. Under such,  
 as we learn from Messrs Saugnier, Briffon, and others,  
 they still are in the deserts of Africa, as well as in the  
 islands of Johanna† and Madagafcar: and it is univer-  
 sally known that they enslave one another as a punishment  
 for the most whimsical crimes. Among them, indeed,  
 slavery seems to be reduced to a system, and to descend,  
 as it has done in more polished nations, from father to  
 son; for both Saugnier and Wadstrom § speak of parti-  
 cular families of negroes who are exempted from that  
 degrading state by the laws of the country.

All this we admit to be true. Most certainly the  
 negroes would not be exempted from the miseries of  
 servitude, though Europe and the West Indies were

swallowed up in the ocean. The *customs* of the coun-  
 try, as the king of Dahomy assured Mr Abson §, will  
 be made as long as black men shall continue to possess  
 their own territories, in their present state of depravity  
 and ignorance; and these customs appear to involve  
 slavery of the cruellest kind. But if slavery be in itself  
 unlawful, is it a sufficient excuse for our continuing the  
 traffic that it is carried on by the rude negroes and the  
 savage Arabs? Are people, whom we sometimes affect  
 to consider as an inferior order of beings, to furnish ex-  
 amples of conduct to those who boast of their advance-  
 ments in science, in literature, and in refinement? Or  
 will the benevolent Lord of all things pardon us for  
 oppressing our helpless brethren, merely because they  
 are cruelly oppressed by others? It is indeed true that  
 the natives of Guinea cannot be made really free but  
 by introducing among them the blessings of religion and  
 the arts of civil life; but surely they would have fewer  
 temptations than at present to kidnap one another, or  
 to commence unprovoked wars for the purpose of making  
 captives, were the nations of Europe to abandon the  
 commerce in slaves (o). That commerce, we grant,  
 would be continued by the Arabs, and perhaps by  
 others of the eastern nations; but the same number of  
 people could not be carried off by them alone that is  
 now carried off both by them and by the Europeans.

Were it indeed possible to put the slave-trade under  
 proper regulations, so as to prevent all kidnapping and  
 unjust wars among the Africans, to supply the markets;  
 and were it likewise to ensure to the negroes in the West  
 Indies mild treatment and religious instruction; we are  
 far from being sure that while the natives of Guinea con-  
 tinue so rude, and their neighbours the Arabs so selfishly  
 savage, it would be proper to abandon at once to hordes of  
 barbarians the whole of this commerce in bond servants.  
 "The trade, which in its present form is a reproach to  
 Britain, might be made to take a new shape, and be-  
 come ultimately a blessing to thousands of wretches  
 who, left in their native country, would have dragged  
 out a life of miserable ignorance, unknowing the hand  
 that framed them, unconscious of the reason of which  
 they were made capable, and heedless of the happi-  
 ness laid up for them in store §.

Slavery is, indeed, in every form an evil; but it seems  
 to be one of those many evils which, having long pre-  
 vailed in the world, can be advantageously removed on-  
 ly by degrees, and as the moral cultivation of the slaves  
 may

(n) We have not insisted upon the impolicy of the slave-trade, or endeavoured to prove that its abolition would be *advantageous* to the sugar-planters; for the planters surely understand their own interest better than those can do, who, having never been in the West Indies, are obliged to content themselves with what information they can glean on the subject from a number of violent and contradictory publications. To countenance slavery under any form is undoubtedly immoral. This we know: and therefore upon this ground only have we opposed the slave-trade, which cannot be continued without preferring interest to virtue.

(o) In a speech which Mr Dalzel says the king of Dahomy made to Mr Abson, when he was informed of what had passed in England on the subject of the slave-trade, are these remarkable words: "In the name of my ancestors and myself, I aver that no Dahoman ever embarked in war merely for the sake of procuring wherewithal to purchase your commodities." With all due respect for his sable majesty, we must take the liberty to question the truth of this solemn avement. That the slave-trade is not the *sole* cause of the Dahoman wars every man will admit, who does not fancy that those people have neither passions nor appetites, but for the commodities of Europe: but the bare affirmation of this bloody despot, who boasted of having killed many thousands at the *customs*, will not convince those who have read either Wadstrom's Essay on Colonization, or the evidence respecting the slave-trade given at the bar of the House of Commons, "that no Dahoman ever embarked in war merely to procure slaves to barter for European commodities."

Slave-  
 trade.  
 Dalzel's  
 History.

37  
 Of no  
 strength.

§ Remond's  
 Essay,

p. 272, &c.

Slave-  
GaleSleep-  
walker.38  
The aboli-  
tion should  
be gradual.29  
Danger of  
a sudden  
manumif-  
sion of  
slaves.

may enable them to support the rank and discharge the duties of free men. 'Tis his doubtless the reason why it was not expressly prohibited by the divine Author of our religion, but suffered to vanish gradually before the mild influence of his Heavenly doctrines. It has vanished before these doctrines in most countries of Europe; and we trust that the time is at hand when our traffic in human flesh with the inhabitants of Africa shall cease; and that the period is not very distant when the slaves in the West Indies shall be so much improved in moral and religious knowledge, as that they may be safely trusted with their own freedom. To set them free in their present state of ignorance and depravity, is one of the wildest proposals that the ardour of innovation has ever made. Such freedom would be equally ruinous to themselves and to their masters; and we may say of it what Cicero said of some unseasonable indulgences proposed to be granted to the slaves in Sicily; *Qua cum accidunt, nemo est, quin intelligat ruere illam rempublicam; hæc ubi veniunt, nemo est, qui ullam spem salutis reliquam esse arbitretur.*

**SLAUGHTER.** See MAN-SLAUGHTER, HOMICIDE, MURDER, &c.

**SLEDGE**, a kind of carriage, without wheels, for the conveyance of very weighty things, as huge stones, bells, &c. The sledge for carrying criminals, condemned for high treason, to execution, is called **HURDLE**. The Dutch have a kind of sledge on which they can carry a vessel of any burden by land. It consists of a plank of the length of the keel of a moderate ship, raised a little behind, and hollow in the middle; so that the sides go a little aslope, and are furnished with holes to receive pins, &c. The rest is quite even.

**SLEDGE** is a large smith's hammer, to be used with both hands: of this there are two sorts, the up-hand sledge, which is used by under workmen, when the work is not of the largest sort; it is used with both the hands before, and they seldom raise it higher than their head. But the other, which is called the about-sledge, and which is used for battering or drawing out the largest work, is held by the handle with both hands, and swung round over their heads, at their arm's end, to strike as hard a blow as they can.

**SLEEP**, that state of the body in which, though the vital functions continue, the senses are not affected by the ordinary impressions of external objects. See **DREAMS**; and **PHYSIOLOGY**, n<sup>o</sup> 287.

*SLEEP-Walker*, one who walks in his sleep. Many instances might be related of persons who were addicted to this practice; but it will be sufficient to select one remarkable instance from a report made to the Physical Society of Lausanne, by a committee of gentlemen appointed to examine a young man who was accustomed to walk in his sleep.

"The disposition to sleep-walking seems, in the opinion of this committee, to depend on a particular affection of the nerves, which both seizes and quits the patient during sleep. Under the influence of this affection, the imagination represents to him the objects that struck him while awake, with as much force as if they really affected his senses; but does not make him perceive any of those that are actually presented to his senses, except in so far as they are connected with the dreams which engross him at the time. If, during this state, the imagination has no determined purpose, he receives the impression of objects as if he were awake;

only, however, when the imagination is excited to bend its attention towards them. The perceptions obtained in this state are very accurate, and, when once received, the imagination renews them occasionally with as much force as if they were again acquired by means of the senses. Lastly, these academicians suppose, that the impressions received during this state of the senses disappear entirely when the person awakes, and do not return till the return of the same disposition in the nervous system.

"Their remarks were made on the *Sieur Devaud*, a lad thirteen years and a half old, who lives in the town of *Vevey*, and who is subject to that singular affection or disease called *Somnambulism* or sleep-walking. This lad possesses a strong and robust constitution, but his nervous system appears to be organized with peculiar delicacy, and to discover marks of the greatest sensibility and irritability. His senses of smell, taste, and touch, are exquisite; he is subject to fits of immoderate and involuntary laughter, and he sometimes likewise weeps without any apparent cause.

"This young man does not walk in his sleep every night; several weeks sometimes pass without any appearance of a fit. He is subject to the disease generally two nights successively, one fit lasting for several hours. The longest are from three to four hours, and they commonly begin about three or four o'clock in the morning.

"The fit may be prolonged, by gently passing the finger or a feather over his upper lip, and this slight irritation likewise accelerates it. Having once fallen asleep upon a staircase, his upper lip was thus irritated with a feather, when he immediately ran down the steps with great precipitation, and resumed all his accustomed activity. This experiment was repeated several times.

"The young *Devaud* thinks he has observed, that, on the evenings previous to a fit, he is sensible of a certain heaviness in his head, but especially of a great weight in his eyelids.

"His sleep is at all times unquiet, but particularly when the fits are about to seize him. During his sleep, motions are observable in every part of his body, with starting and palpitations; he utters broken words, sometimes sits up in his bed, and afterwards lies down again. He then begins to pronounce words more distinctly, he rises abruptly, and acts as he is illigated by the dream that then possesses him. He is sometimes in sleep subject to continued and involuntary motions.

"The departure of the fit is always preceded by two or three minutes of calm sleep, during which he snores. He then awakes rubbing his eyes like a person who has slept quietly.

"It is dangerous to awaken him during the fit, especially if it is come suddenly; for then he sometimes falls into convulsions. Having risen one night with the intention of going to eat grapes, he left the house, passed through the town, and went to a vineyard where he expected good cheer. He was followed by several persons, who kept at some distance from him, one of whom fired a pistol, the noise of which instantly awakened him, and he fell down without sense. He was carried home and brought to himself, when he recollected very well the having been awakened in the vineyard; but nothing more, except the sight of being found there alone, which had made him swoon.

"After the fits he generally feels a degree of lassitude;

Sleep-  
walker.

tude : sometimes, though rarely, of indisposition. At the end of one of those fits, of which the gentlemen of the committee were witnesses, he was affected with vomitings ; but he is always soon restored.

“ When he is awaked, he never for the most part recollects any of the actions he has been doing during the fit.

“ The subject of his dreams is circumscribed in a small circle of objects, that relate to the few ideas with which at his age his mind is furnished ; such as his lessons, the church, the bells, and especially tales of ghosts. It is sufficient to strike his imagination the evening before a fit with some tale, to direct his somnambulism towards the object of it. There was read to him while in this situation the story of a robber ; he imagined the very next moment that he saw robbers in the room. However, as he is much disposed to dream that he is surrounded with them, it cannot be affirmed that this was an effect of the reading. It is observed, that when his supper has been more plentiful than usual, his dreams are more dismal.

“ In their report, the gentlemen of the committee dwell much on the state of this young man's senses, on the impression made upon them by strange objects, and on the use they are of to him.

“ A bit of strong smelling wood produced in him a degree of restlessnes; the fingers had the same effect, whether from their smell or their transpiration. He knew wine in which there was wormwood by the smell, and said that it was not wine for his table. Metals make no impression on him.

“ Having been presented with a little common wine while he was in a state of apathy, and all his motions were performed with languor, he drank of it willingly ; but the irritation which it occasioned produced a deal of vivacity in all his words, motions, and actions, and caused him to make involuntary grimaces.

“ Once he was observed dressing himself in perfect darkness. His clothes were on a large table, mixed with those of some other persons ; he immediately perceived this, and complained of it much ; at last a small light was brought, and then he dressed himself with sufficient precision. If he is teased or gently pinched, he is always sensible of it, except he is at the time strongly engrossed with some other thing, and wishes to strike the offender ; however, he never attacks the person who has done the ill, but an ideal being whom his imagination presents to him, and whom he pursues thro' the chamber without running against the furniture, nor can the persons whom he meets in his way divert him from his pursuit.

“ While his imagination was employed on various subjects, he heard a clock strike, which repeated at every stroke the note of the cuckoo. There are cuckoos here, said he ; and, upon being desired, he imitated the song of that bird immediately.

“ When he wishes to see an object, he makes an effort to lift his eyelids ; but they are so little under his command, that he can hardly raise them a line or two, while he draws up his eyebrows ; the iris at that time appears fixed, and his eye dim. When any thing is presented to him, and he is told of it, he always half opens his eyes with a degree of difficulty, and then shuts them after he has taken what was offered to him.

“ The report infers from these facts, and from many

others relative to the different senses, that their functions are not suspended as to what the sleep-walker wishes to see, that is, as to all those perceptions which accord with the objects about which his imagination is occupied ; that he may also be disposed to receive those impressions, when his imagination has no other object at the time ; that in order to see, he is obliged to open his eyes as much as he can, but when the impression is once made, it remains ; that objects may strike his sight without striking his imagination, if it is not interested in them ; and that he is sometimes informed of the presence of objects without either seeing or touching them.

“ Having engaged him to write a theme, say the committee, we saw him light a candle, take pen, ink, and paper, from the drawer of his table, and begin to write, while his master dictated. As he was writing, we put a thick paper before his eyes, notwithstanding which he continued to write and to form his letters very distinctly ; showing signs, however, that something was incommoding him, which apparently proceeded from the obstruction which the paper, being held too near his nose, gave to his respiration.

“ Upon another occasion, the young somnambulist arose at five o'clock in the morning, and took the necessary materials for writing, with his copy-book. He meant to have begun at the top of a page ; but finding it already written on, he came to the blank part of the leaf, and wrote some time from the following words, *Fiunt ignari pigritia-ils deviennent ignorans par la paresse* ; and, what is remarkable, after several lines he perceived he had forgot the *s* in the word *ignorans*, and had put erroneously a double *r* in *paresse* ; he then gave over writing, to add the *s* he had forgot, and to erase the superfluous *r*.

“ Another time he had made, of his own accord, a piece of writing, in order, as he said, to please his master. It consisted of three kinds of writing, text, half text, and small writ ; each of them performed with the proper pen. He drew, in the corner of the same paper, the figure of a hat ; he then asked for a penknife to take out a blot of ink which he had made between two letters, and he erased it without injuring them. Lastly, he made some arithmetical calculations with great accuracy.

“ In order to explain some of the facts observed by the academicians which we have here mentioned, they establish two general observations, which result from what they have said with respect to the senses and the dreams of this sleep-walker.

“ 1. That he is obliged to open his eyes, in order to recognise objects which he wishes to see ; but the impression once made, although rapidly, is vivid enough to supersede the necessity of his opening them again, to view the same objects anew ; that is, the same objects are afterwards presented to his imagination with as much force and precision as if he actually saw them.

“ 2. That his imagination, thus warmed, represents to him objects, and such as he figures to himself, with as much vivacity as if he really saw them ; and, lastly, that all his senses, being subordinate to his imagination, seem concentrated in the object with which it is occupied, and have at that time no perception of any thing, but what relates to that object.

“ These two causes united seem to them sufficient

Sleep-walker.

Sleep-walker.

for explaining one of the most singular facts that occurred to their observation, to wit, how the young Devaud can write, although he has his eyes shut, and an obstacle before them. His paper is imprinted on his imagination, and every letter which he means to write is also painted there, at the place in which it ought to stand on the paper, and without being confounded with the other letters; now it is clear that his hand, which is obedient to the will of his imagination, will trace them on the real paper, in the same order in which they are represented on that which is pictured in his head. It is thus that he is able to write several letters, several sentences, and entire pieces of writing; and what seems to confirm the idea, that the young Devaud writes according to the paper painted on his imagination is, that a certain sleep-walker, who is described in the French *Encyclopédie* (article *Somnambulism*), having written something on a paper, another piece of paper of the same size was substituted in its stead, which he took for his own, and made upon this blank paper the corrections he meant to have made on the other which had been taken away, precisely in the places where they would have been.

“ It appears from the recital of another fact, that Devaud, intending to write at the top of the first leaf of a white paper book. *Vevey*, le— stopped a moment as if to recollect the day of the month, left a blank space, and then proceeded to *Decembre* 1787; after which he asked for an almanac: a little book, such as is given to children for a new year's gift, was offered to him; he took it, opened it, brought it near his eyes, then threw it down on the table. An almanac which he knew was then presented to him; this was in German, and of a form similar to the almanac of *Vevey*: he took it, and then said, ‘What is this they have given me; here, there is your German almanac.’ At last they gave him the almanac of *Berne*; he took this likewise, and went to examine it at the bottom of an alcove that was perfectly dark. He was heard turning over the leaves, and saying 24, then a moment afterwards 34. Returning to his place, with the almanac open at the month of *December*, he laid it on the table and wrote in the space which he had left blank the 24th. This scene happened on the 23d; but as he imagined it to be the 24th, he did not mistake. The following is the explication given of this fact by the authors of the report.

“ The dates 23d, 24th, and 25th, of the month of *December*, had long occupied the mind of the young Devaud. The 23d and 25th were holidays, which he expected with the impatience natural to persons of his age, for the arrival of those moments when their little daily labours are to be suspended. The 25th especially was the object of his hopes; there was to be an illumination in the church, which had been described to him in a manner that quite transported him. The 24th was a day of labour, which came very disagreeably between the two happy days. It may easily be conceived, how an imagination so irritable as that of the young Devaud would be struck with those pleasing epochs. Accordingly, from the beginning of the month he had been perpetually turning over the almanac of *Vevey*. He calculated the days and the hours that were to elapse before the arrival of his wished-for ho-

liday; he showed to his friends and acquaintance the dates of those days which he expected with so much impatience; every time he took up the almanac, it was only to consult the month of *December*. We now see why that date presented itself to his mind. He was performing a task, because he imagined the day to be the *Monday* which had so long engrossed him. It is not surprising, that it should have occurred to his imagination, and that on opening the almanac in the dark he might have thought he saw this date which he was seeking, and that his imagination might have represented it to him in as lively a manner as if he had actually seen it. Neither is it surprising that he should have opened the almanac at the month of *December*; the custom of perusing this month must have made him find it in the dark by a mere mechanical operation. Man never seems to be a machine so much as in the state of somnambulism; it is then that habit comes to supply those of the senses that cannot be serviceable, and that it makes the person act with as much precision as if all his senses were in the utmost activity. These circumstances destroy the idea of there being any thing miraculous in the behaviour of young Devaud with respect to the date and the month that he was in quest of; and the reader, who has entered into our explanations, will not be surprised at his knowing the German almanac; the touch alone was sufficient to point it out to him; and the proof of this is the shortness of the time that it remained in his hands.

“ An experiment was made by changing the place of the ink-standish during the time that Devaud was writing. He had a light beside him, and had certified himself of the place where his ink-holder was standing by means of sight. From that time he continued to take ink with precision, without being obliged to open his eyes again: but the ink-standish being removed, he returned as usual to the place where he thought it was: It must be observed, that the motion of his hand was rapid till it reached the height of the standish, and then he moved it slowly, till the pen gently touched the table as he was seeking for the ink: he then perceived that a trick had been put on him, and complained of it; he went in search of his ink-standish and put it in its place. This experiment was several times repeated, and always attended with the same circumstances. Does not what we have here stated prove, that the standish, the paper, the table, &c. are painted on his imagination in as lively a manner as if he really saw them, as he sought the real standish in the place where his imagination told him it ought to have been? Does it not prove that the same lively imagination is the cause of the most singular actions of this sleep-walker? And lastly, does it not prove, that a mere glance of his eye is sufficient to make his impressions as lively as durable?

“ The committee, upon the whole, recommend to such as wish to repeat the same experiments, 1. To make their observations on different sleep-walkers. 2. To examine often whether they can read books that are unknown to them in perfect darkness. 3. To observe whether they can tell the hours on a watch in the dark. 4. To remove when they write the ink-standish from its place, to see whether they will return to the same place in order to take ink. 5. And, lastly, to take notice whether they walk with the same confidence in a dark



and unknown place, as in one with which they are acquainted.

“They likewise recommend to such as would confirm or invalidate the above observations, to make all their experiments in the dark; because it has been hitherto supposed that the eyes of sleep-walkers are of no use to them.”

**SLEEPERS**, in natural history, a name given to those animals which sleep all winter; such as bears, marmots, dormice, bats, hedgehogs, swallows, &c. These do not feed in winter, have no sensible evacuations, breathe little or none at all, and most of the viscera cease from their functions. Some of these creatures seem to be dead, and others return to a state like that of the fœtus before birth: in this state they continue, till by new heat the fluids are attenuated, the animal is restored to life, and the functions begin where they left off.

**SLEEPERS**, in a ship, timbers lying before and aft in the bottom of the ship, as the rungheds do: the lowermost of them is bolted to the rungheds, and the uppermost to the futtocks and rings.

**SLEIDAN** (John), an excellent German historian, born of obscure parents, in 1506, at Sleidan, a small town on the confines of the duchy of Juliers. After studying some time in his own county, together with his townsman the learned John Sturmus, he went to France, and in 1535 entered into the service of the cardinal and archbishop John du Bellay. He retired to Strasburg in 1542, where he acquired the esteem and friendship of the most considerable persons, particularly of James Sturmus; by whose advice and assistance he was enabled to write the history of his own time. He was employed in some public negotiations; but the death of his wife, in 1555, plunged him into so deep a melancholy, that he lost his memory entirely, and died the year following. In 1555 came out, in folio, *De statu Religionis et Reipublicæ sub Carolo Quinto*, &c. in 25 books; from the year 1517, when Luther began to preach, to the year of its publication; which history was presently translated into most of the languages of Europe. Besides this great work, he wrote, *De quatuor summis Imperiis, libri tres*; with some other historical and political pieces.

**SLEIGHT** of HAND. See **LEGERDEMAIN**.

**SLEUT-HOUNDE**, the ancient Scots name of the blood-hound. The word is from the Saxon *slot*, “the impression that a deer leaves of its foot in the mire,” and *bound* “a dog”; so they derive their name from following the track. See the article *Blood-Hound*.

**SLESWICK**, an ancient and considerable town of Denmark, and capital of a duchy of the same name in the province of Gottorp, with a bishop’s see, secularized in 1586. Close to it is the old palace of Gottorp, formerly the ducal residence, but at present inhabited by the stadtholder or governor. This town was once more considerable than it is at present, having suffered greatly by the wars of Germany. It is seated on the gulph of Sley, where there is a good harbour, 60 miles north-west of Lubeck, and 125 south-west of Copenhagen. E. Long. 10. 0. N. Lat. 54. 40.

**SLESWICK**, the duchy of, or *South Jutland*, is about 100 miles in length and 60 in breadth. It is bounded on the north by North Jutland, on the east by the Baltic Sea, on the south by Holstein, and on the west by

the ocean. It contains 14 cities, 17 towns, 13 castles, 278 parishes, 1480 villages, 162 farms, 116 water mills, and 106 gentlemens seats. It is a pleasant, fertile, populous country, and a sovereign duchy. Formerly the king of Denmark had half of it, and the other belonged to the house of Holstein-Gottorp; but the former having conquered this duchy, had the possession of it confirmed to him by the treaty of the north in 1720. In 1731, a prince of Bareith Culmbach was made governor of this duchy, who resides at Gottorp.

**SLICH**, in metallurgy, the ore of any metal, particularly of gold, when it has been pounded, and prepared for farther working.

The manner of preparing the slich at Chremnitz in Hungary is this; they lay a foundation of wood three yards deep, upon this they place the ore, and over this there are 24 beams, armed at their bottoms with iron; these, by a continual motion, beat and grind the ore, till it is reduced to powder: during this operation, the ore is covered with water. There are four wheels used to move these beams, each wheel moving six; and the water, as it runs off, carrying some of the metalline particles with it, is received into several basons, one placed behind another; and finally, after having passed through them all, and deposited some sediment in each, it is let off into a very large pit, almost half an acre in extent; in which it is suffered to stand so long, as to deposit all its sediment, of whatever kind, and after this it is let out. This work is carried on day and night, and the ore taken away and replaced by more as often as occasion requires. That ore which lies next the beams, by which it was pounded, is always the cleanest or richest.

When the slich is washed as much as they can, a hundred weight of it usually contains about an ounce, or perhaps but half an ounce of metal, which is not all gold; for there is always a mixture of gold and silver, but the gold is in the largest quantity, and usually is two-thirds of the mixture: they then put the slich into a furnace with some limestone, and slacken, or the scoria of former meltings, and run them together. The first melting produces a substance called *lech*; this lech they burn with charcoal, to make it lighter, to open its body, and render it porous, after which it is called *roff*; to this roff they add sand in such quantity as they find necessary, and then melt it over again.

At Chremnitz they have many other ways of reducing gold out of its ore, but particularly one, in which they employ no lead during the whole operation; whereas, in general, lead is always necessary, after the before mentioned processes. See **GOLD**.

**SLIDING RULE**, a mathematical instrument, serving to work questions in gauging, measuring, &c. without the use of compasses; merely by the sliding of the parts of the instrument one by another, the lines and divisions whereof give the answer by inspection.

This instrument is variously contrived, and applied by various authors, particularly Everard, Coggeshall, Gunter, Hunt, and Partridge; but the most common and useful are those of Everard and Coggeshall.

**SLIGO**, a county, in the province of Connaught, Ireland, 25 miles in length, and as much in breadth; bounded on the east by that of Leitrim, on the west by the county of Mayo, on the north and north west by the western ocean, and on the south and south-west

Slich  
!!  
Sligo.

Sling  
||  
Sloane.

by Roscommon and Mayo. It contains 5970 houses, 41 parishes, 6 baronies, 1 borough, and sends 4 members to parliament, two for the county, and two for the borough of the same name, which is the only market-town in the county, and is seated on a bay of the same name, 50 miles west of Killalla, and 110 north-east of Dublin. W. Long. 8. 26. N. Lat. 54. 13.

SLING, an instrument serving for casting stones with great violence. The inhabitants of the Balearic islands were famous in antiquity for the dexterous management of the sling: it is said they used three kinds of slings, some longer, others shorter, which they used according as their enemies were either nearer or more remote. It is added, that the first served them for a head-band, the second for a girdle, and that the third they constantly carried in their hand.

SLINGING is used variously at sea; but chiefly for hoisting up casks or other heavy things with slings, *i. e.* contrivances of ropes spliced into themselves at either end, with one eye big enough to receive the cask or whatever is to be slung. There are other slings, which are made longer, and with a small eye at each end; one of which is put over the breech of a piece of ordnance, and the other eye comes over the end of an iron crow, which is put into the mouth of the piece, to weigh and hoise the gun as they please. There are also slings by which the yards are bound fast to the cross-tree aloft, and to the head of the mast, with a strong rope or chain, that if the tie should happen to break, or to be shot to pieces in fight, the yard, nevertheless, may not fall upon the hatches.

SLINGING a Man overboard, in order to stop a leak in a ship, is done thus: the man is trussed up about the middle in a piece of canvas, and a rope to keep him from sinking, with his arms at liberty, a mallet in one hand, and a plug, wrapped in oakum and well tarred in a tarpawling clout, in the other, which he is to beat with all dispatch into the hole or leak.

SLOANE (Sir Hans), baronet, eminently distinguished as a physician and a naturalist, was of Scotch extraction, his father Alexander Sloane being at the head of that colony of Scots which King James I. settled in the north of Ireland, where our author was born, at Killieagh, on the 16th of April 1665. At a very early period, he displayed a strong inclination for natural history; and this propensity being encouraged by a suitable education, he employed those hours which young people generally lose by pursuing low and trifling amusements, in the study of nature, and contemplating her works. When about sixteen, he was attacked by a spitting of blood, which threatened to be attended with considerable danger, and which interrupted the regular course of his application for three years; he had, however, already learned enough of physick to know that a malady of this kind was not to be removed suddenly, and he prudently abstained from wine and other liquors that were likely to increase it.

By strictly observing this severe regimen, which in some measure he continued ever after, he was enabled to prolong his life beyond the ordinary bounds; being an example of the truth of his own favourite maxim, that sobriety, temperance, and moderation, are the best and most powerful preservatives that nature has granted to mankind.

As soon as he recovered from this infirmity, he re-

solved to perfect himself in the different branches of physick, which was the profession he had made choice of; and with this view he repaired to London, where he hoped to receive that assistance which he could not find in his own country.

On his arrival in the metropolis, he entered himself as a pupil to the great Stafforth, an excellent chemist, bred under the illustrious Stahl; and by his instructions he gained a perfect knowledge of the composition and preparation of the different kinds of medicines then in use. At the same time, he studied botany at the celebrated garden at Chelsea, assiduously attended the public lectures of anatomy and physick, and in short neglected nothing that he thought likely to prove serviceable to him in his future practice. His principal merit, however, was his knowledge of natural history; and it was this part of his character which introduced him early to the acquaintance of Mr Boyle and Mr Ray, two of the most eminent naturalists of that age. His intimacy with these distinguished characters continued as long as they lived; and as he was careful to communicate to them every object of curiosity that attracted his attention, the observations which he occasionally made often excited their admiration and obtained their applause.

After studying four years at London with unremitting severity, Mr Sloane determined to visit foreign countries for farther improvement. In this view he set out for France in the company of two other students, and having crossed to Dieppe, proceeded to Paris. In the way thither they were elegantly entertained by the famous M. Lemery the elder; and in return Mr Sloane presented that eminent chemist with a specimen of four different kinds of phosphorus, of which, upon the credit of other writers, M. Lemery had treated in his book of chemistry, though he had never seen any of them.

At Paris Mr Sloane lived as he had done in London. He attended the hospitals, heard the lectures of Tournefort, De Verney, and other eminent masters; visited all the literati, who received him with particular marks of esteem, and employed himself wholly in study.

From Paris Mr Sloane went to Montpellier; and, being furnished with letters of recommendation from M. Tournefort to M. Chirac, then chancellor of that university, he found easy access, through his means, to all the learned men of the province, particularly to M. Magnol, whom he always accompanied in his botanical excursions in the environs of that city, where he beheld with pleasure and admiration the spontaneous productions of nature, and learned under his instructions to class them in a proper manner.

Having here found an ample field for contemplation, which was entirely suited to his taste, he took leave of his two companions, whom a curiosity of a different kind led into Italy.

After spending a whole year in collecting plants, he travelled through Languedoc with the same design; and passing through Thoulouse and Bourdeaux, returned to Paris, where he made a short stay. About the end of the year 1684 he set out for England, with an intention of settling there as a physician. On his arrival in London, he made it his first business to visit his two illustrious friends Mr Ray and Mr Boyle, in order

Sloan

Sloane. to communicate to them the discoveries he had made in his travels. The latter he found at home, but the former had retired to Essex; to which place Mr Sloane transmitted a great variety of plants and seeds, which Mr Ray has described in his History of Plants, and for which he makes a proper acknowledgment.

About the year 1706 our author became acquainted with the celebrated Sydenham; who soon contracted so warm an affection for him that he took him into his house, and recommended him in the strongest manner to his patients. He had not been long in London before he was proposed by Dr Martin Lister as a candidate to be admitted a member of the Royal Society, on the 26th of November 1684; and being approved, he was elected on the 21st of January following.

In 1685 he communicated some curiosities to the Society; and in July the same year he was a candidate for the office of their assistant secretary, but without success, as he was obliged to give way to the superior interest of his competitor Dr Halley. On the 12th of April 1687, he was chosen a fellow of the college of physicians in London; and the same year his friend and fellow traveller Dr Tancred Robinson, having mentioned to the Society the plant called the *Star of the earth*, as a remedy newly discovered for the bite of a mad dog, Dr Sloane acquainted them that this virtue of the plant was to be found in a book called *De Grey's Farriery*; and that he knew a man who had cured with it twenty couple of dogs. This observation he made on the 13th of July, and on the 12th of September following he embarked at Portsmouth for Jamaica with the duke of Albemarle, who had been appointed governor of that island. The doctor attended his grace in quality of physician, and arrived at Jamaica on the 19th of December following.

Here a new field was opened for fresh discoveries in natural productions; but the world would have been deprived of the fruits of them, had not our author, by incredible application, converted, as we may say, his minutes into hours. The duke of Albemarle died soon after he landed, and the duchess determined to return to England whenever an answer should be received to the letter she had sent to court on that melancholy occasion. As Dr Sloane could not think of leaving her grace in her distress, whilst the rest of her retinue were preparing for their departure he improved it in making collections of natural curiosities; so that though his whole stay at Jamaica was not above fifteen months, he brought together such a prodigious number of plants, that on his return to England Mr Ray was astonished that one man could procure in one island, and in so short a space, so vast a variety.

On his arrival in London he applied himself to the practice of his profession; and soon became so eminent, that he was chosen physician to Chrill's Hospital on the 17th of October 1694: and this office he held till the year 1730, when, on account of his great age and infirmities, he found it necessary to resign. It is somewhat singular, and redounds much to the Doctor's honour, that though he received the emoluments of his office punctually, because he would not lay down a precedent which might hurt his successors, yet he constantly applied the money to the relief of those who were the greatest objects of compassion in the hospital, that it might never be said he enriched himself by giving

health to the poor. He had been elected secretary to the Royal Society on the 30th of November 1693; and upon this occasion he revived the publication of the Philosophical Transactions, which had been omitted for some time. He continued to be the editor of this work till the year 1712; and the volumes which appeared during that period are monuments of his industry and ingenuity, many of the pieces contained in them being written by himself.

In the mean time he published *Catalogus Plantarum quæ in Insula Jamaica sponte proveniunt, &c. Seu Prodromi Historiæ Naturalis pars prima*, which he dedicated to the Royal Society and College of Physicians. About the same time he formed the plan of a dispensary, where the poor might be furnished at prime cost with such medicines as their several maladies might require; which he afterwards carried into execution, with the assistance of the president and other members of the college of physicians.

Our author's thirst for natural knowledge seems to have been born with him, so that his cabinet of curiosities may be said to have commenced with his being. He was continually enriching and enlarging it; and the same which, in the course of a few years, it had acquired, brought every thing that was curious in art or nature to be first offered to him for purchase. These acquisitions, however, increased it but very slowly in comparison of the augmentation it received in 1701 by the death of William Courten, Esq; a gentleman who had employed all his time, and the greater part of his fortune, in collecting rarities, and who bequeathed the whole to Dr Sloane, on condition of his paying certain debts and legacies with which he had charged it. These terms our author accepted, and he executed the will of the donor with the most scrupulous exactness; on which account some people have said, that he purchased Mr Courten's curiosities at a dear rate.

In 1707 the first volume of Dr Sloane's Natural History of Jamaica appeared in folio, though the publication of the second was delayed till 1725. By this very useful as well as magnificent work the materia medica was enriched with a great number of excellent drugs not before known. In 1708 the Doctor was elected a foreign member of the Royal Academy of Sciences at Paris, in the room of Mr Tschirnaus; an honour so much the greater, as we were then at war with France, and the queen's express consent was necessary before he could accept it. In proportion as his credit rose among the learned, his practice increased among the people of rank: Queen Anne herself frequently consulted him, and in her last illness was bled by him.

On the advancement of George I. to the throne, that prince, on the 3d of April 1716, created the Doctor a baronet, an hereditary title of honour to which no English physician had before attained; and at the same time made him physician general to the army, in which station he continued till 1727, when he was appointed physician in ordinary to George II. He attended the royal family till his death; and was particularly favoured by Queen Caroline, who placed the greatest confidence in his prescriptions. In the meantime he had been unanimously chosen one of the elects of the college of physicians June 27. 1716, and he was elected president of the same body on September 30. 1719, an office which he held for sixteen years. Du-

Stoone.

ring that period he not only gave the highest proofs of his zeal and assiduity in the discharge of his duty, but in 1721 made a present to that society of L. 100; and so far remitted a very considerable debt, which the corporation owed him, as to accept it in such small sums as were least inconvenient to the state of their affairs. Sir Hans was no less liberal to other learned bodies. He had no sooner purchased the manor of Chelsea, than he gave the company of apothecaries the entire freehold of their botanical garden there, upon condition only that they should present yearly to the Royal Society fifty new plants, till the number should amount to 2000(A). He gave besides several other considerable donations for the improvement of this garden; the situation of which, on the banks of the Thames, and in the neighbourhood of the capital, was such as to render it useful in two respects: First, by producing the most rare medicinal plants; and, secondly, by serving as an excellent school for young botanists; an advantage which he himself had derived from it in the early part of his life.

The death of Sir Isaac Newton, which happened in 1727, made way for the advancement of Sir Hans to the presidency of the Royal Society. He had been vice-president, and frequently sat in the chair for that great man; and by his long connection with this learned body he had contracted to strong an affection for it, that he made them a present of an hundred guineas, caused a curious bust of King Charles II. its founder, to be erected in the great hall where it met, and, as is said, was very instrumental in procuring Sir Godfrey Copley's benefaction of a medal of the value of five guineas, to be annually given as an honorary mark of distinction to the person who communicates the best experiments to the Society.

On his being raised to the chair, Sir Hans laid aside all thoughts of further promotion, and applied himself wholly to the faithful discharge of the duties of the office which he enjoyed. In this laudable occupation he employed his time from 1727 to 1740, when, at the age of fourscore, he formed a resolution of quitting the service of the public, and of living for himself. With this view he resigned the presidency of the Royal Society much against the inclination of that respectable body, who chose Martin Folkes, Esq; to succeed him, and in a public assembly thanked him for the great and eminent services he had rendered them. In the month of January 1741, he began to remove his library, and his cabinet of rarities, from his house in Bloomsbury to that at Chelsea; and on the 12th of March following, having settled all his affairs, he retired thither himself, to enjoy in peaceful tranquillity the remains of a well-spent

life. He did not, however, bury himself in that solitude which excludes men from society. He received at Chelsea, as he had done in London, the visits of people of distinction, of all learned foreigners, and of the royal family, who sometimes did him the honour to wait on him; but, what was still more to his praise, he never refused admittance or advice to rich or poor who came to consult him concerning their health. Not contented with this contracted method of doing good, he now, during his retreat, presented to the public such useful remedies as success had warranted, during the course of a long continued practice. Among these is the efficacious receipt for distempers in the eyes, and his remedy for the bite of a mad dog.

During the whole course of his life, Sir Hans had lived with so much temperance, as had preserved him from feeling the infirmities of old age; but in his 90th year he began to complain of pains, and to be sensible of an universal decay. He was often heard to say, that the approach of death brought no terrors along with it; that he had long expected the stroke; and that he was prepared to receive it whenever the great Author of his being should think fit. After a short illness of three days, he died on the 11th of January 1752, and was interred on the 18th at Chelsea, in the same vault with his lady, the solemnity being attended with the greatest concourse of people, of all ranks and conditions, that had ever been seen before on the like occasion.

Sir Hans being extremely solicitous left his cabinet of curiosities, which he had taken so much pains to collect, should be again dissipated at his death, and being at the same time unwilling that so large a portion of his fortune should be lost to his children, he bequeathed it to the public, on condition that L. 20,000 should be made good by parliament to his family. This sum, though large in appearance, was scarcely more than the intrinsic value of the gold and silver medals, the ores and precious stones that were found in it; for in his last will he declares, that the first cost of the whole amounted at least to L. 50,000. Besides his library, consisting of more than 50,000 volumes, 347 of which were illustrated with cuts finely engraven and coloured from nature, there were 3560 manuscripts, and an infinite number of rare and curious works of every kind. The parliament accepted the legacy, and fulfilled the conditions.

SLOANEA, in botany: A genus of plants belonging to the class of *polyandria*, and order of *monogamia*; and in the natural system ranging under the 50th order, *Amentacea*. The corolla is pentapetalous; the calyx pentaphyllous and deciduous; the stigma is perforated;

(A) This garden was first established by the company in 1673; and having after that period been stocked by them with a great variety of plants, for the improvement of botany, Sir Hans, in order to encourage so serviceable an undertaking, granted to the company the inheritance of it, being part of his estate and manor of Chelsea, on condition that it should be for ever preserved as a physic garden. As a proof of its being so maintained, he obliged the company, in consideration of the said grant, to present yearly to the Royal Society, in one of their weekly meetings, fifty specimens of plants that had grown in the garden the preceding year, and which were all to be specifically distinct from each other, until the number of two thousand should be completed. This number was completed in the year 1761. In 1733 the company erected a marble statue of Sir Hans, executed by Ryfbrac, which is placed upon a pedestal in the centre of the garden, with a Latin inscription, expressing his donation, and the design and advantages of it.

perforated; the berry is corticose, echinated, polyspermous, and gaping. There are two species, the *dentata* and *emarginata*.

SLOË. See PRUNUS.

SLOOP, a small vessel furnished with one mast, the mainsail of which is attached to a gaff above, or to the mast on its foremoſt edge, and to a long boom below, by which it is occasionally ſhifted to either quarter. See SHIP.

Sloop of War, a name given to the ſmalleſt veſſels of war except cutters. They are either rigged as ſhips or ſnowſ.

SLOT, in the ſportsman's language, a term uſed to expreſs the mark of the foot of a ſtag or other animal proper for the chace in the clay or earth, by which they are able to gueſs when the animal paſſed, and which way he went. The ſlot, or treading of the ſtag, is very nicely ſtudied on this occaſion; if the ſlot be large, deep printed in the ground, and with an open cleft, and, added to theſe marks, there is a large ſpace between mark and mark, it is certain that the ſtag is an old one. If there be obſerved the ſlots or treadings of two, the one long and the other round, and both of one ſize, the long ſlot is always that of the larger animal. There is alſo another way of knowing the old ones from the young ones by the treading; which is, that the hinder feet of the old ones never reach to their fore feet, whereas thoſe of the young ones do.

SLOTH, in zoology. See BRADYPUS.

SLOUGH, a deep muddy place. The caſt ſkin of a ſnake, the damp of a coal pit, and the ſcar of a wound, are alſo called by the ſame appellation. The ſlough of a wild boar is the bed, ſoil, or mire, wherein he wallows, or in which he lies in the day-time.

SLUCZK, a large and populous town in Poland, in Lithuania, and capital of a duchy of the ſame name; famous for three battles gained here by Conſtantine duke of Oſtrogo over the Tartars, in the reign of Sigismund I. It is ſeated on the river Slucz, 72 miles ſouth-eaſt of Mińsk, and 70 ſouth of Novogrodeck. E. Long. 27. 44. N. Lat. 53. 2.

SLUG, in zoology. See LIMAX.

SLUICE, a frame of timber, ſtone, or other matter, ſerving to retain and raiſe the water of a river, &c. and on occaſion to let it paſs.

Such is the ſluice of a mill, which ſtops and collects the water of a rivulet, &c. to let it fall at length in the greater plenty upon the mill-wheel: ſuch alſo are thoſe uſed as vents or drains to diſcharge water off land. And ſuch are the ſluices of Flanders, &c. which ſerve to prevent the waters of the ſea from overflowing the lower lands.

Sometimes there is a kind of canal incloſed between two gates or ſluices, in artificial navigations, to ſave the water, and render the paſſage of boats equally eaſy and ſafe, upwards and downwards; as in the ſluices of Briare in France, which are a kind of maſſive walls built parallel to each other, at the diſtance of 20 or 24 feet, cloſed with ſtrong gates at each end, between which is a kind of canal or chamber, conſiderably longer than broad; wherein a veſſel being incloſed, the water is let out at the firſt gate, by which the veſſel is raiſed 15 or 16 feet, and paſſed out of this canal into another much higher. By ſuch means a boat is conveyed out of the

Loire into the Seine, though the ground between them riſe above 150 feet higher than either of thoſe rivers.

Sluices are made different ways, according to the uſe for which they are intended: when they ſerve for navigation, they are ſhut with two gates, preſenting an angle towards the ſtream; when they are made near the ſea, two pair of gates are made, the one to keep the water out and the other in, as occaſion requires: in this caſe, the gates towards the ſea preſent an angle that way, and the others the contrary way; and the ſpace incloſed by thoſe gates is called the chamber. When ſluices are made in the ditches of a fortrefs, to keep up the water in ſome parts, inſtead of gates, ſlutters are made ſo as to ſlide up and down in grooves; and when they are made to raiſe an inundation, they are then ſhut by means of ſquare timbers let down in cullies, ſo as to lie cloſe and firm,

The word *ſluice* is formed of the French *ecluſe*, which Menage derives from the Latin *excluſa*, found in the Salic law in the ſame ſenſe. But this is to be reſtrained to the ſluices of mills, &c. for as to thoſe ſerving to raiſe veſſels, they were wholly unknown to the ancients.

SLUR, in muſic, a mark like the arch of a circle, drawn from one note to another, comprehending two or more notes in the ſame or different degrees. If the notes are in different degrees, it ſignifies that they are all to be ſung to one ſyllable; for wind inſtruments, that they are to be made in one continued breath; and for ſtringed inſtruments that are ſtruck with a bow, as a violin, &c. that they are made with one ſtroke. If the notes are in the ſame degree, it ſignifies that it is all one note, to be made as long as the whole notes ſo connected; and this happens moſt frequently betwixt the laſt note of one line and the firſt of the next; which is particularly called *ſyncopation*.

SLUYS, a town of Dutch Flanders, oppoſite the iſland of Cadſand, with a good harbour, 10 miles north of Bruges. E. Long. 3. 25. N. Lat. 51. 19.

SMACK, a ſmall veſſel, commonly rigged as a ſloop or hoy, uſed in the coaſting or fiſhing trade, or as a tender in the king's ſervice.

SMALAND, or EAST GOTHLAND, a province of Sweden, which makes part of Gothland; and is bounded on the north by Oſtrogothia or Eaſt Gothland, on the eaſt by the Baltic Sea, on the ſouth by Schonen and Bleekingia, and on the weſt by Weſtrogothia or Weſt Gothland. It is about 112 miles in length, and 62 in breadth. Calmar is the capital town.

SMALKALD, a town of Germany, in Franconia, and in the county of Henneberg: famous for the confederacy entered into by the German Proteſtants againſt the emperor, commonly called the *league of Smalkald*. The deſign of it was to defend their religion and liberties. It is ſeated on the river Werra, 25 miles ſouth-weſt of Erford, and 50 north-weſt of Bamberg. E. Long. 10. 53. N. Lat. 50. 49. It is ſubject to the prince of Heſſe-Caſſel.

SMALLAGE, in botany. See APRUM.

SMALT, a kind of glaſs of a dark blue colour, which when levigated appears of a moſt beautiful colour; and if it could be made ſufficiently fine, would be an excellent ſuccedaneum for ultramarine, as not only reſiſting all kinds of weather, but even the moſt violent fires. It is prepared by melting one part of calcined cobalt with two of flint powder, and one of pot-alk.

Sluice

||

Smalt.

+ See Ca-

nals.

Smearagdus,  
Smeaton.

At the bottoms of the crucibles in which the smalt is manufactured we generally find a regulus of a whitish colour inclining to red, and extremely brittle. This is melted afresh, and when cold separates into two parts; that at the bottom is the cobaltic regulus, which is employed to make more of the smalt; the other is bismuth.

SMARAGDUS, in natural history. See EME-RALD.

SMEATON (John), an eminent civil engineer, was born the 28th of May 1724, O. S. at Aulthorpe, near Leeds, in a house built by his grandfather, and where his family have resided ever since.

The strength of his understanding and the originality of his genius appeared at an early age; his playthings were not the playthings of children, but the tools which men employ; and he appeared to have greater entertainment in seeing the men in the neighbourhood work, and asking them questions, than in any thing else. One day he was seen (to the distress of his family) on the top of his father's barn, fixing up something like a windmill; another time, he attended some men fixing a pump at a neighbouring village, and observing them cut off a piece of bored pipe, he was so lucky as to procure it, and he actually made with it a working pump that raised water. These anecdotes refer to circumstances that happened while he was in petticoats, and most likely before he attained his sixth year.

About his 14th and 15th year, he had made for himself an engine for turning, and made several presents to his friends of boxes in ivory or wood very neatly turned. He forged his iron and steel, and melted his metal; he had tools of every sort for working in wood, ivory, and metals. He had made a lathe, by which he had cut a perpetual screw in brass, a thing little known at that day, which was the invention of Mr Henry Hindley of York; with whom Mr Smeaton soon became acquainted, and they spent many a night at Mr Hindley's house till day-light, conversing on those subjects.

Thus had Mr Smeaton, by the strength of his genius and indefatigable industry, acquired, at the age of 18, an extensive set of tools, and the art of working in most of the mechanical trades, without the assistance of any master. A part of every day was generally occupied in forming some ingenious piece of mechanism.

Mr Smeaton's father was an attorney, and desirous of bringing him up to the same profession, Mr Smeaton therefore came up to London in 1742, and attended the courts in Westminster hall; but finding (as his common expression was) that the law did not suit the bent of his genius, he wrote a strong memorial to his father on that subject; whose good sense from that moment left Mr Smeaton to pursue the bent of his genius in his own way.

In 1751 he began a course of experiments to try a machine of his invention to measure a ship's way at sea, and also made two voyages in company with Dr Knight to try it, and a compass of his own invention and making, which was made magnetical by Dr Knight's artificial magnets: the second voyage was made in the Fortune sloop of war, commanded at that time by Captain Alexander Campbell.

In 1753 he was elected member of the Royal So-

ciety; the number of papers published in their Transactions will show the universality of his genius and knowledge. In 1759 he was honoured by an unanimous vote with their gold medal for his paper intitled "An Experimental Inquiry concerning the Natural Powers of Water and Wind to turn Mills, and other Machines depending on a Circular Motion."

This paper, he says, was the result of experiments made on working models in the years 1752 and 1753, but not communicated to the Society till 1759; before which time he had an opportunity of putting the effect of these experiments into real practice, in a variety of cases, and for various purposes, so as to assure the Society he had found them to answer.

In December 1755, the Eddystone lighthouse was burnt down: Mr Weston, the chief proprietor, and the others, being desirous of rebuilding it in the most substantial manner, inquired of the earl of Macclesfield (then president of the Royal Society) whom he thought the most proper to rebuild it; his Lordship recommended Mr Smeaton.

Mr Smeaton undertook the work, and completed it in the summer of 1759. Of this Mr Smeaton gives an ample description in the volume he published in 1791: that edition has been sold some time ago, and a second is now in the press, under the revival of his much esteemed friend Mr Aubert, F. R. S. and governor of the London assurance corporation.

Though Mr Smeaton completed the building of the Eddystone lighthouse in 1759 (a work that does him so much credit), yet it appears he did not soon get into full business as a civil engineer; for in 1764, while in Yorkshire, he offered himself a candidate for one of the receivers of the Derwentwater estate; and on the 31st of December in that year, he was appointed at a full board of Greenwich hospital, in a manner highly flattering to himself; when two other persons strongly recommended and powerfully supported were candidates for the employment. In this appointment he was very happy, by the assistance and abilities of his partner Mr Walton one of the receivers, who taking upon himself the management and accounts, left Mr Smeaton leisure and opportunity to exert his abilities on public works, as well as to make many improvements in the mills and in the estates of Greenwich hospital. By the year 1775 he had so much business as a civil engineer, that he wished to resign this appointment; and would have done it then, had not his friends the late Mr Stuart the hospital surveyor, and Mr Ibbetson their secretary, prevailed upon him to continue in the office about two years longer.

Mr Smeaton having now got into full business as a civil engineer, performed many works of general utility. He made the river Calder navigable; a work that required great skill and judgment, owing to the very impetuous floods in that river: He planned and attended the execution of the great canal in Scotland for conveying the trade of the country either to the Atlantic or German ocean; and having brought it to the place originally intended, he declined a handsome yearly salary, in order that he might attend to the multiplicity of his other business.

On the opening of the great arch at London bridge, the excavation around and under the sterings was so considerable, that the bridge was thought to be in great

n. great danger of falling. He was then in Yorkshire, and was sent for by express, and arrived with the utmost dispatch: "I think (says Mr Holmes, the author of his life) it was on a Saturday morning, when the apprehension of the bridge was so general that few would pass over or under it. He applied himself immediately to examine it, and to sound about the sterlings as minutely as he could; and the committee being called together, adopted his advice, which was to repurchase the stones that had been taken from the middle pier, then lying in Moorfields, and to throw them into the river to guard the sterlings." Nothing shows the apprehensions concerning the falling of the bridge more than the alacrity with which this advice was pursued; the stones were repurchased that day, horses, carts, and barges, were got ready, and they began the work on Sunday morning. Thus Mr Smeaton, in all human probability, saved London-bridge from falling, and secured it till more effectual methods could be taken.

The vast variety of mills which Mr Smeaton constructed, so greatly to the satisfaction and advantage of the owners, will show the great use which he made of his experiments in 1752 and 1753; for he never trusted to theory in any case where he could have an opportunity to investigate it by experiment. He built a steam engine at Aulthorpe, and made experiments thereon, purposely to ascertain the power of Newcomen's steam-engine, which he improved and brought to a far greater degree of perfection, both in its construction and powers, than it was before.

Mr Smeaton during many years of his life was a frequent attendant on parliament, his opinion being continually called for; and here his strength of judgment and perspicuity of expression had its full display: it was his constant custom, when applied to, to plan or support any measure, to make himself fully acquainted with it, to see its merits before he would engage in it: by this caution, added to the clearness of his description and the integrity of his heart, he seldom failed to obtain for the bill which he supported an act of parliament. No one was heard with more attention, nor had any one ever more confidence placed in his testimony. In the courts of law he had several compliments paid him from the bench by Lord Mansfield and others, for the new light which he threw on difficult subjects.

About the year 1785 Mr Smeaton's health began to decline; and he then took the resolution to endeavour to avoid all the business he could, so that he might have leisure to publish an account of his inventions and works, which was certainly the first wish of his heart; for he has often been heard to say, that "he thought he could not render so much service to his country as by doing that." He got only his account of the Edystone lighthouse completed, and some preparations to his intended Treatise on Mills: for he could not resist the solicitations of his friends in various works: and Mr Aubert, whom he greatly loved and respected, being chosen chairman of Ramsgate harbour, prevailed upon him to accept the place of engineer to that harbour; and to their joint efforts the public is chiefly indebted for the improvements that have been made there within these few years, which fully appears in a report that Mr Smeaton gave in to the board of trustees in 1791, which they immediately published.

Mr Smeaton being at Aulthorpe, walking in his

garden on the 16th of September 1792, was struck with the palsy, and died the 28th of October. "In his illness (says Mr Holmes) I had several letters from him, signed with his name, but written and signed by another's pen; the diction of them showed the strength of his mind had not left him. In one written the 26th of September, after minutely describing his health and feelings, he says, 'in consequence of the foregoing, I conclude myself nine-tenths dead; and the greatest favour the Almighty can do me (as I think), will be to complete the other part; but as it is likely to be a lingering illness, it is only in His power to say when that is likely to happen.'"

Mr Smeaton had a warmth of expression that might appear to those who did not know him well to border on harshness; but those more intimately acquainted with him, knew it arose from the intense application of his mind, which was always in the pursuit of truth, or engaged in investigating difficult subjects. He would sometimes break out hastily, when any thing was said that did not tally with his ideas; and he would not give up any thing he argued for, till his mind was convinced by sound reasoning.

In all the social duties of life he was exemplary; he was a most affectionate husband, a good father, a warm, zealous, and sincere friend, always ready to assist those he respected, and often before it was pointed out to him in what way he could serve them. He was a lover and encourager of merit wherever he found it; and many men are in a great measure indebted to his assistance and advice for their present situation. As a companion, he was always entertaining and instructive; and none could spend any time in his company without improvement.

SMELL, *ODOUR*, with regard to the organ, is an impression made on the nose by little particles continually exhaling from odorous bodies: With regard to the object, it is the figure and disposition of odorous effluvia, which, sticking on the organ, excite the sense of smelling: And with regard to the soul, it is the perception of the impression of the object on the organ, or the affection in the soul resulting therefrom. See ANATOMY, n<sup>o</sup> 140; and METAPHYSICS.

SMELLING, the act whereby we perceive smells, or whereby we become sensible of odorous bodies, by means of certain effluvia thereof; which, striking on the olfactory organ, briskly enough to have their impulse propagated to the brain, excite a sensation in the soul. The principal organs of smelling are the nostrils and the olfactory nerves; the minute ramifications of which latter are distributed throughout the whole concave of the former. For their descriptions, see ANATOMY.

Smelling is performed by drawing into the nostrils the odorous effluvia floating in the air in inspiration, which strike with such force against the fibrille of the olfactory nerves, which the figure of the nose, and the situation of the little bones, render opposite thereto, as to shake them, and give them a vibratory motion; which action, being communicated hence to the common sensory, occasions an idea of a sweet, or fetid, or sour, or an aromatic, or a putrescent object, &c. The matter in animals, vegetables, fossils, &c. which chiefly affects the sense of smelling, Boerhaave observes, to be that subtle substance, inherent in their oily parts,

Smelling  
 or  
 Smelling.

called *spirits*: because, when this is taken away from the most fragrant bodies, what remains has scarce any smell at all; but this, poured on the most inodorous bodies, gives them a fragraney.

Willis observes, that brutes have generally the sense of smelling in much greater perfection than man: by this alone they distinguish the qualities of bodies, which could not otherwise be known; hunt out their food at a great distance, as hounds and birds of prey; or hid among other substances, as ducks, &c. Man, having other means of judging of his food, &c. did not need so much sagacity in his nose; yet have we instances of a great deal even in man. In the *Histoire des Antilles*, we are assured there are negroes who, by the smell alone, can distinguish between the footsteps of a Frenchman and a negro. It is found, that the laminæ, wherewith the upper part of the nostrils is fenced, and which serve to receive the divarications of the olfactory nerves, are always longer, and folded up together in greater numbers, as the animal has this sense more acute: the various windings and turnings of these laminæ detaining the odoriferous particles.

The sense of smelling may be diminished or destroyed by diseases; as by the moisture, dryness, inflammation, or suppuration of the olfactory membrane, the compression of the nerves which supply it, or some fault in the brain itself at their origin. A defect, or too great a degree of solidity of the small spongy bones of the upper jaw, the caverns of the forehead, &c. may likewise impair this sense; and it may be also injured by a collection of fetid matter in these caverns, which is continually exhaling from them, and also by immoderate use of snuff. When the nose abounds with moisture, after gentle evacuations, such things as tend to take off irritation and coagulate the thin sharp serum may be applied; as the oil of anise mixed with fine flour, camphor dissolved in oil of almonds, &c. the vapours of amber, frankincense, gum-mastic, and benjamin, may likewise be received into the nose and mouth. For moistening the mucus when it is too dry, some recommend snuff made of the leaves of marjoram, mixed with oil of amber, marjoram, and aniseed; or a sternutatory of calcined white vitriol, twelve grains of which may be mixed with two ounces of marjoram water and filtrated. The steam of vinegar upon hot iron, and received up the nostrils, is also of use for softening the mucus, removing obstructions, &c. If there be an ulcer in the nose, it ought to be dressed with some emollient ointment, to which, if the pain be very great, a little laudanum may be added. If it be a venereal ulcer, 12 grains of corrosive sublimate may be dissolved in a pint and a half of brandy, a table spoonful of which may be taken twice a day. The ulcer ought likewise to be washed with it, and the fumes of cinabar may be received up the nostrils.

If there be reason to suspect that the nerves which supply the organs of smelling are inert, or want stimulating, volatile salts, or strong snuffs, and other things which occasion sneezing, may be applied to the nose; the forehead may likewise be anointed with balsam of Peru, to which may be added a little oil of amber.

SMELT, in ichthyology. See SALMO.

SMELTING, in metallurgy, the fusion or melting of the ores of metals, in order to separate the metalline

part from the earthy, stony, and other parts. See METALLURGY, Part III.

SMEW, in ornithology. See MERCUS.

SMILAX, ROUGH BINDWEED, in botany: A genus of plants belonging to the class of *dicia* and order of *hexandria*; and in the natural system ranging under the 11th order, *Sarmentaceæ*. The male calyx is hexaphyllous, and there is no corolla; the female calyx is also hexaphyllous, without any corolla: there are three styles, a trilobular berry, and two seeds. There are 18 species; the aspera, excelsa, zeilanica, sarfaparilla, eluina, rotundifolia, laurifolia, tamnoides, caduca, bona nox, herbacea, tetragona, lanceolata, and pseudo china. Of these, the smilax sarfaparilla, which affords the sarfaparilla root, is the most valuable. This is well described in the London Medical Journal by Dr Wright, who, during a long residence in Jamaica, made botany his peculiar study.

"This species (says he) has stems of the thickness of a man's finger: they are jointed, triangular, and beset with crooked spines. The leaves are alternate, smooth and shining on the upper side; on the other side are three nerves or costæ, with sundry small crooked spines. The flower is yellow, mixed with red. The fruit is a black berry, containing several brown seeds.

"Sarfaparilla delights in low moist grounds and near the banks of rivers. The roots run superficially under the surface of the ground. The gatherers have only to loosen the soil a little, and to draw out the long fibres with a wooden hook. In this manner they proceed till the whole root is got out. It is then cleared of the mud, dried, and made into bundles.

"The sensible qualities of sarfaparilla are mucilaginous and farinaceous, with a slight degree of acrimony. The latter, however, is so slight as not to be perceived by many; and I am apt to believe that its medicinal powers may fairly be ascribed to its demulcent and farinaceous qualities.

"Since the publication of Sir William Fordyce's paper on Sarfaparilla in the Medical Observations and Inquiries, Vol. I. sarfaparilla has been in more general use than formerly. The planters in Jamaica supply their estates with great quantities of it; and its exhibition has been attended with very happy consequences in the yawsaud in venereal affections; as nodes, tophi, and exostosis; pains of the bones, and carious or cancerous ulcers.

"Sir William Fordyce seems to think sarfaparilla a specific in all stages of lues; but from an attentive and careful observation of its effects in some thousands of cases, I must declare I could place no dependence on sarfaparilla alone. But if mercury had formerly been tried, or was used along with sarfaparilla, a cure was soon effected. Where the patients had been reduced by pain, disorder, and mercury, I prescribed a decoction of sarfaparilla, and a table-spoonful of the powder of the same, twice a day, with the greatest success, in the most deplorable cases of lues, ill-cured yaws, and carious or ill-disposed sores or cancers."

The china, or oriental species of china root, has roundish prickly stalks and red berries, and is a native of China and Japan. The pseudo-china, or occidental species, has rounder smooth stalks and black berries, grows wild in Jamaica and Virginia, and bears the colds of our own climate.

These



These roots have scarce any smell or particular taste: when fresh, they are said to be somewhat acrid, but as brought to us they discover, even when long chewed, no other than a slight unctuousness in the mouth. Boiled in water, they impart a reddish colour, and a kind of rapid softness: the decoction when inspissated yields an unctuous, farinaceous, almost insipid mass, amounting to upwards of half the weight of the root. They give a gold yellow tincture to rectified spirit, but make no sensible alteration in its taste: on drawing off the spirit from the filtered liquor, there remains an orange-coloured extract, nearly as insipid as that obtained by water, but scarcely in half its quantity.

China root is generally supposed to promote perspiration and urine, and by its soft unctuous quality to blunt acrimonious humours. It was first introduced into Europe about the year 1535, with the character of a specific against venereal disorders: the patient was kept warm, a weak decoction of china root was used for common drink, and a stronger decoction taken twice a day in bed to promote a sweat. Such a regimen is doubtless a good auxiliary to mercurial alteratives: but whatever may be its effects in the warmer climates, it is found in this to be of itself greatly insufficient. At present the china root is very rarely made use of, having for some time given place to sarsaparilla, which is supposed to be more effectual. Prosper Alpinus informs us, that this root is in great esteem among the Egyptian women for procuring fatness and plumpness.

SMITH (Sir Thomas), was born at Walden in Essex in 1512. At 14 he was sent to Queen's college Cambridge, where he distinguished himself so much, that he was made Henry VIII.'s scholar together with John Cheke. He was chosen a fellow of his college in 1531, and appointed two years after to read the public Greek lecture. The common mode of reading Greek at that time was very faulty; the same sound being given to the letters and diphthongs *υ, η, ι, ο, ω*. Mr Smith and Mr Cheke had been for some time sensible that this pronunciation was wrong: and after a good deal of consultation and research, they agreed to introduce that mode of reading which prevails at present. Mr Smith was lecturing on *Aristotle de Republica* in Greek. At first he dropped a word or two at intervals in the new pronunciation, and sometimes he would stop as if he had committed a mistake and correct himself. No notice was taken of this for two or three days; but as he repeated more frequently, his audience began to wonder at the unusual sounds, and at last some of his friends mentioned to him what they had remarked. He owned that something was in agitation, but that it was not yet sufficiently digested to be made public. They entreated him earnestly to discover his project: he did so; and in a short time great numbers resorted to him for information. The new pronunciation was adopted with enthusiasm, and soon became universal at Cambridge. It was afterwards opposed by bishop Gardiner the chancellor; but its superiority to the old mode was so visible, that in a few years it spread over all England.

In 1539 he travelled into foreign countries, and studied for some time in the universities of France and Italy. On his return he was made regius professor of civil law at Cambridge. About this time he published a

treatise on the mode of pronouncing English. He was useful likewise in promoting the reformation. Having gone into the family of the duke of Somerset, the protector during the minority of Edward VI. he was employed by that nobleman in public affairs; and in 1548 was made secretary of state, and received the honour of knighthood. While that nobleman continued in office, he was sent ambassador, first to Brussels and afterwards to France.

Upon Mary's accession he lost all his places, but was fortunate enough to preserve the friendship of Gardiner and Bonner. He was exempted from persecution, and was allowed, probably by their influence, a pension of L. 100. During Elizabeth's reign he was employed in public affairs, and was sent three times by that princess as her ambassador to France. He died in 1577. His abilities were excellent, and his attainments uncommonly great: He was a philosopher, a physician, a chemist, mathematician, linguist, historian, and architect. He wrote, 1. A treatise called the *English Commonwealth*. 2. A letter *De Retu et Emendata Lingua Græcæ Pronunciatione*. 3. *De Moribus Turcarum*. 4. *De Druidum Moribus*.

SMITH (Edmund), a distinguished English poet, the only son of Mr Neale an eminent merchant, by a daughter of baron Lechmere, was born in 1663. By his father's death he was left young to the care of Mr Smith, who had married his father's sister, and who treated him with so much tenderness, that at the death of his generous guardian he assumed his name. His writings are not many, and those are scattered about in miscellanies and collections: his celebrated tragedy of *Phædra* and *Hippolitus* was acted in 1707; and being introduced at a time when the Italian opera so much engrossed the polite world, gave Mr Addison, who wrote the prologue, an opportunity to rally the vitiated taste of the public. However, notwithstanding the esteem it has always been held in, it is perhaps rather to be considered as a fine poem than as a good play. This tragedy, with a Poem to the memory of Mr John Phillips, three or four Odes, with a Latin oration spoken at Oxford in laudem *Thomæ Bodleii*, were published as his works by his friend Mr Oldisworth. Mr Smith died in 1710, sunk into indolence and intemperance by poverty and disappointments; the hard fate of many a man of genius.

SMITH (John), an excellent mezzotinter, flourished about 1700; but neither the time of his birth nor death are accurately known. He united softness with strength, and finished with freedom. He served his time with one Tillet a painter in Moorfields; and as soon as he became his own master, learned from Becket the secret of mezzotinto, and being farther instructed by Van der Vaart, was taken to work in Sir Godfrey Kneller's house; and as he was to be the publisher of that master's works, doubtless received considerable hints from him, which he amply repaid. "To posterity perhaps his prints (says Mr Walpole) will carry an idea of something burlesque; perukes of an enormous length flowing over suits of armour, compose wonderful habits. It is equally strange that fashion could introduce the one, and establish the practice of representing the other, when it was out of fashion. Smith excelled in exhibiting both, as he found them in the portraits of Kneller,

Smith. ler, who was less happy in what he substituted to armour. In the Kit-cat club he has poured full bottoms chiefly over night-gowns. If those streams of hair were *incommode* in a battle, I know nothing (he adds) they were adapted to that can be done in a night-gown. Smith composed two large volumes, with proofs of his own plates, for which he asked L. 50. His finest works are duke Schomberg on horseback; that duke's son and successor Maynard; the earls of Pembroke, Dorset, and Albemarle; three plates with two figures in each, of young persons or children, in which he shone; William Cowper; Gibbons and his wife; Queen Anne; the duke of Gloucester, a whole length, with a flower-pot; a very curious one of Queen Mary, in a high head, fan, and gloves; the earl of Godolphin; the dukes of Ormond, a whole length, with a black; Sir George Rooke, &c. There is a print by him of James II. with an anchor, but no inscription; which not being finished when the king went away, is so scarce that it is sometimes sold for above a guinea. Smith also performed many historic pieces; as the loves of the gods, from Titian, at Blenheim, in ten plates; Venus standing in a shell, from a picture by Correggio, and many more, of which perhaps the most delicate is the holy family with angels, after Carlo Maratti."

*Philosophical Transactions of the Royal Society of Edinburgh, vol. iii.*

SMITH (Dr Adam), the celebrated author of the Inquiry into the Nature and Causes of the Wealth of Nations, was the only son of Adam Smith comptroller of the customs at Kirkaldy, and of Margaret Douglas daughter of Mr Douglas of Stratheny. He was born at Kirkaldy on the 5th June 1723, a few months after the death of his father. His constitution during his infancy was infirm and sickly, and required all the care of his surviving parent. When only three years old he was carried by his mother to Stratheny on a visit to his uncle Mr Douglas; and happening one day to be amusing himself alone at the door of the house, he was stolen by a party of those vagrants who in Scotland are called *tinkers*. Luckily he was missed immediately, and the vagrants pursued and overtaken in Lellie wood; and thus Dr Smith was preserved to extend the bounds of science, and reform the commercial policy of Europe.

He received the rudiments of his education in the school of Kirkaldy under David Miller, a teacher of considerable eminence, and whose name deserves to be recorded on account of the great number of eminent men which that seminary produced while under his direction. Dr Smith, even while at school, attracted notice by his passionate attachment to books, and by the extraordinary powers of his memory; while his friendly and generous disposition gained and secured the affection of his schoolfellows. Even then he was remarkable for those habits which remained with him through life, of speaking to himself when alone and of absence in company. He was sent in 1737 to the university of Glasgow, where he remained till 1740, when he went to Baliol college Oxford, as an exhibitioner on Snell's foundation. His favourite pursuits while at the university were mathematics and natural philosophy. After his removal to England he frequently employed himself in translating, particularly from the French, with a view to the improvement of his own style: a practice which he often recommended to all who wished to cul-

tivate the art of composition. It was probably then also that he applied himself with the greatest care to the study of languages, of which, both ancient and modern, his knowledge was uncommonly extensive and accurate.

After seven years residence at Oxford he returned to Kirkaldy, and lived two years with his mother without any fixed plan for his future life. He had been designed for the church of England; but disliking the ecclesiastical profession, he resolved to abandon it altogether, and to limit his ambition to the prospect of obtaining some of those preferments to which literary attainments lead in Scotland. In 1748 he fixed his residence in Edinburgh, and for three years read a course of lectures on rhetoric and belles lettres under the patronage of Lord Kames. In 1751 he was elected professor of logic in the university of Glasgow, and the year following was removed to the professorship of moral philosophy, vacant by the death of Mr Thomas Craigie the immediate successor of Dr Hutcheson. In this situation he remained 13 years, a period he used frequently to look back to as the most useful part of his life. His lectures on moral philosophy were divided into four parts: The first contained natural theology; in which he considered the proofs of the being and attributes of God, and those truths on which religion is founded; the second comprehended ethics, strictly so called, and consisted chiefly of those doctrines which he afterwards published in his theory of moral sentiments: in the third part he treated more at length of that part of morality called *justice*; and which, being susceptible of precise and accurate rules, is for that reason capable of a full and accurate explanation: in the last part of his lectures he examined those political regulations which are founded, not upon the principle of justice, but of expediency; and which are calculated to increase the riches, the power, and the prosperity of a state. Under this view he considered the political institutions relating to commerce, to finances, to ecclesiastical and military governments: this contained the substance of his *Wealth of Nations*. In delivering his lectures he trusted almost entirely to extemporary elocution: his manner was plain and unaffected, and he never failed to interest his hearers. His reputation soon rose very high, and many students resorted to the university merely upon his account.

When his acquaintance with Mr Hume first commenced is uncertain, but it had ripened into friendship before the year 1752.

In 1759 he published his Theory of Moral Sentiments; a work which deservedly extended his reputation: for, though several of its conclusions be ill-founded, it must be allowed by all to be a singular effort of invention, ingenuity, and subtilty. Besides, it contains a great mixture of important truth; and, tho' the author has sometimes been misled, he has had the merit of directing the attention of philosophers to a view of human nature, which had formerly in a great measure escaped their notice. It abounds everywhere with the purest and most elevated maxims concerning the practical conduct of life; and when the subject of his work leads him to address the imagination and the heart, the variety and felicity of his illustrations, the richness and fluency of his eloquence, and the skill with

which he wins the attention and commands the passions of his readers, leave him among our British moralists without a rival.

Towards the end of 1763 Dr Smith received an invitation from Mr Charles Townsend to accompany the Duke of Buccleugh on his travels; and the liberal terms in which this proposal was made induced him to resign his office at Glasgow. He joined the Duke of Buccleugh at London early in the year 1764, and set out with him for the continent in the month of March following. After a stay of about ten days at Paris, they proceeded to Thoulouse, where they fixed their residence for about 18 months; thence they went by a pretty extensive route through the south of France to Geneva, where they passed two months. About Christmas 1765 they returned to Paris, and remained there till October following. The society in which Dr Smith passed these ten months may be conceived in consequence of the recommendation of Mr Hume. Turgot, Quesnai, Necker, D'Alembert, Helvetius, Marmontel, Madame Riccoboni, were among the number of his acquaintances; and some of them he continued ever after to reckon among the number of his friends. In October 1766 the duke of Buccleugh returned to England.

Dr Smith spent the next ten years of his life with his mother at Kirkaldy, occupied habitually in intense study, but unbending his mind at times in the company of some of his old schoolfellows, who still continued to reside near the place of their birth. In 1776 he published his *Inquiry into the Nature and Causes of the Wealth of Nations*; a book so universally known, that any panegyric on it would be useless. The variety, importance, and (may we not add) novelty, of the information which it contains; the skill and comprehensiveness of mind displayed in the arrangement; the admirable illustrations with which it abounds; together with a plainness and perspicuity which makes it intelligible to all—render it unquestionably the most perfect work which has yet appeared on the general principles of any branch of legislation.

He spent the next two years of his life in London, where he enjoyed the society of some of the most eminent men of the age: but he removed to Edinburgh in 1778, in consequence of having been appointed, at the request of the duke of Buccleugh, one of the commissioners of the customs in Scotland. Here he spent the last twelve years of his life in an affluence which was more than equal to all his wants. But his studies seemed entirely suspended till the infirmities of old age reminded him, when it was too late, of what he yet owed to the public and to his own fame. The principal materials of the works which he had announced had long ago been collected, and little probably was wanting but a few years of health and retirement to complete them. The death of his mother, who had accompanied him to Edinburgh in 1784, together with that of his cousin Miss Douglas in 1788, contributed to frustrate these projects. They had been the objects of his affection for more than 60 years, and in their Society he had enjoyed from his infancy all that he ever knew of the endearments of a family. He was now alone and helpless; and though he bore his loss with equanimity, and regained apparently his former cheerfulness, yet his health and strength gradually declined till the period of

his death, which happened in July 1790. Some days before his death he ordered all his papers to be burnt except a few essays, which have since been published.

Of the originality and comprehensiveness of his views; the extent, the variety, and the correctness of his information; the inexhaustible fertility of his invention—he has left behind him lasting monuments. To his private worth, the most certain of all testimonies may be found in that confidence, respect, and attachment, which followed him through all the various relations of life. He was habitually absent in conversation, and was apt when he spoke to deliver his ideas in the form of a lecture. He was rarely known to start a new topic himself, or to appear unprepared upon those topics that were introduced by others. In his external form and appearance there was nothing uncommon. When perfectly at ease, and when warmed with conversation, his gestures were animated and not ungraceful; and in the society of those he loved, his features were often brightened by a smile of inexpressible benignity. In the company of strangers, his tendency to abstinence, and perhaps still more his consciousness of that tendency, rendered his manners somewhat embarrassed; an effect which was probably not a little heightened by those speculative ideas of propriety which his recluse habits tended at once to perfect in his conception, and to diminish his power of realizing.

SMITHIA, in botany: A genus of the *decandria* order, belonging to the *diadelphica* class of plants; and in the natural method ranking under the 32d order, *Papilionacea*. The calyx is monophyllous and belabiated; the corolla winged; the legumen inclosed in the calyx, with three or four joints, and contain as many seeds, which are smooth, compressed, and kidney-shaped. There is only one species, viz. the *thonna*.

SMITZ (Gaspar), who, from painting a great number of Magdalens, was called *Magdalen Smith*, was a Dutch painter, who came to England soon after the Restoration. For these portraits sat a woman that he kept, and called his wife. A lady, whom he had taught to draw, took him with her to Ireland, where he painted small portraits in oil, had great business, and high prices. His flowers and fruit were so much admired, that one bunch of grapes sold there for L. 40. In his Magdalens he generally introduced a thistle on the fore ground. He had several scholars, particularly Maubert, and one Gawdy of Exeter. Yet, notwithstanding his success, he died poor in Ireland in 1707.

SMITHERY, a smith's shop; also the art of a smith, by which iron is wrought into any shape by means of fire, hammering, filing, &c.

SMITING-LINE, in a ship, is a small rope fastened to the mizen-yard-arm, below at the deck, and is always furled up with the mizen-fail, even to the upper end of the yard, and thence it comes down to the poop. Its use is to loose the mizen-fail without striking down the yard, which is easily done, because the mizen-fail is furled up only with rope-yarns; and therefore when this rope is pulled hard, it breaks all the rope-yarns, and so the fail falls down of itself. The sailor's phrase is, *smite the mizen* (whence this rope takes its name), that is, hale by this rope that the fail may fall down.

SMOKE, a dense elastic vapour, arising from burning bodies. As this vapour is extremely disagreeable to the senses, and often prejudicial to the health, man-

Smith:  
||  
Smoke.

*Smoke.* kind have fallen upon several contrivances to enjoy the benefit of fire, without being annoyed by smoke. The most universal of these contrivances is a tube leading from the chamber in which the fire is kindled to the top of the building, through which the smoke ascends, and is dispersed into the atmosphere. These tubes are called *chimneys*; which, when constructed in a proper manner, carry off the smoke entirely; but, when improperly constructed, they carry off the smoke imperfectly, to the great annoyance of the inhabitants. As our masons at present seem to have a very imperfect knowledge of the manner in which chimneys ought to be built, we can hardly perform a more acceptable service to the public than to point out the manner in which they ought to be constructed, so as to carry off the smoke entirely; as well as to explain the causes from which the defects so often complained of generally proceed, and the method of removing them.

*Transactions of the American Philosophical Society.*

Those who would be acquainted with this subject, should begin by considering on what principle smoke ascends in any chimney. At first many are apt to think that smoke is in its nature, and of itself, specifically lighter than air, and rises in it for the same reason that cork rises in water. These see no cause why smoke should not rise in the chimney though the room be ever so close. Others think there is a power in chimneys to *draw up* the smoke, and that there are different forms of chimneys which afford more or less of this power. These amuse themselves with searching for the best form. The equal dimensions of a funnel in its whole length is not thought artificial enough, and it is made, for fancied reasons, sometimes tapering and narrowing from below upwards, and sometimes the contrary, &c. &c. A simple experiment or two may serve to give more correct ideas. Having lighted a pipe of tobacco, plunge the stem to the bottom of a decanter half filled with cold water; then putting a rag over the bowl, blow through it, and make the smoke descend in the stem of the pipe, from the end of which it will rise in hubbles through the water; and being thus cooled, will not afterwards rise to go out through the neck of the decanter, but remain spreading itself and resting on the surface of the water. This shows that smoke is really heavier than air, and that it is carried upwards only when attached to or acted upon by air that is heated, and thereby rarefied and rendered specifically lighter than the air in its neighbourhood.

Smoke being rarely seen but in company with heated air, and its upward motion being visible, though that of the rarefied air that drives it is not so, has naturally given rise to the error. It is now well known that air is a fluid which has weight as well as others, though about 800 times lighter than water; that heat makes the particles of air recede from each other, and take up more space, so that the same weight of air heated will have more bulk than equal weights of cold air which may surround it, and in that case must rise, being forced upwards by such colder and heavier air, which presses to get under it and take its place. That air is so rarefied or expanded by heat, may be proved to their comprehension by a lank blown bladder, which laid before a fire, will soon swell, grow tight, and burst.

Another experiment may be to take a glass tube about an inch in diameter, and 12 inches long, open at both ends, and fixed upright on legs so that it need not

be handled, for the hands might warm it. At the end of a quill fasten five or six inches of the finest light filament of silk, so that it may be held either above the upper end of the tube or under the lower end, your warm hand being at a distance by the length of the quill. If there were any motion of air through the tube, it would manifest itself by its effect on the silk; but if the tube and the air in it are of the same temperature with the surrounding air, there will be no such motion, whatever may be the form of the tube, whether crooked or straight, narrow below and widening upwards, or the contrary, the air in it will be quiescent. Warm the tube, and you will find as long as it continues warm, a constant current of air entering below and passing up through it till discharged at the top; because the warmth of the tube being communicated to the air it contains, rarefies that air, and makes it lighter than the air without; which therefore presses in below, forces it upwards, follows and takes its place, and is rarefied in its turn. And, without warming the tube, if you hold under it a knob of hot iron, the air thereby heated will rise and fill the tube, going out at its top; and this motion in the tube will continue as long as the knob remains hot, because the air entering the tube below, is heated and rarefied by passing near and over that knob.

That this motion is produced merely by the difference of specific gravity between the fluid within and that without the tube, and not by any fancied form of the tube itself, may appear by plunging it into water contained in a glass jar a foot deep, through which such motion might be seen. The water within and without the tube being of the same specific gravity, balance each other, and both remain at rest. But take out the tube, stop its bottom with a finger, and fill it with olive oil, which is lighter than water; then stopping the top, place it as before, its lower end under water, its top a very little above. As long as you keep the bottom stopped the fluids remain at rest; but the moment it is unstopped, the heavier enters below, forces up the lighter, and takes its place: and the motion then ceases, merely because the new fluid cannot be successively made lighter, as air may be by a warm tube.

In fact, no form of the funnel of a chimney has any share in its operation or effect respecting smoke except its height. The longer the funnel, if erect, the greater its force when filled with heated and rarefied air to draw in below and drive up the smoke, if one may, in compliance with custom, use the expression *draw*, when in fact it is the superior weight of the surrounding atmosphere that presses to enter the funnel below, and so drives up before it the smoke and warm air it meets with in its passage.

What is it then which makes a smoky chimney, that is, a chimney which, instead of conveying up all the smoke, discharges a part of it into the room, offending the eyes and damaging the furniture?

The causes of this effect may be reduced to *nine*, differing from each other, and therefore requiring different remedies.

1. *Smoky chimneys in a new house are such frequently from mere want of air.* The workmanship of the rooms being all good, and just out of the workman's hands, the joints of the boards of the flooring, and of the pannels of wainscotting, are all true and tight; the more so as the

Smoke.

the walls, perhaps not yet thoroughly dry, preserve a dampness in the air of the room which keeps the wood-work swelled and close. The doors and the sashes too, being worked with truth, shut with exactness, so that the room is as tight as a snuff-box, no passage being left open for air to enter except the key-hole, and even that is sometimes covered by a little dropping shutter. Now if smoke cannot rise but as connected with rarefied air, and a column of such air, suppose it filling the funnel, cannot rise unless other air be admitted to supply its place; and if therefore no current of air enter the opening of the chimney—there is nothing to prevent the smoke from coming out into the room. If the motion upwards of the air in a chimney that is freely supplied be observed by the rising of the smoke or a feather in it, and it be considered that in the time such feather takes in rising from the fire to the top of the chimney, a column of air equal to the content of the funnel must be discharged, and an equal quantity supplied from the room below, it will appear absolutely impossible that this operation should go on if the tight room is kept shut: for were there any force capable of drawing constantly so much air out of it, it must soon be exhausted like the receiver of an air-pump, and no animal could live in it. Those therefore who stop every crevice in a room to prevent the admission of fresh air, and yet would have their chimney carry up the smoke, require inconsistencies, and expect impossibilities. Yet under this situation it is not uncommon to see the owner of a new house in despair, and ready to sell it for much less than it cost; conceiving it uninhabitable because not a chimney in any one of its rooms will carry off the smoke unless a door or window be left open. Much expence has also been made to alter and amend new chimneys which had really no fault: in one house particularly which Dr Franklin knew that belonged to a nobleman in Westminster, that expence amounted to no less than L. 300, after his house had been, as he thought, finished and all charges paid. And after all, several of the alterations were ineffectual, for want of understanding the true principles.

*Remedies.* When you find on trial that opening the door or a window enables the chimney to carry up all the smoke, you may be sure that want of air from without was the cause of its smoking. “I say from *without* (adds Dr Franklin), to guard you against a common mistake of those who may tell you the room is large, contains abundance of air sufficient to supply any chimney, and therefore it cannot be that the chimney wants air. These reasoners are ignorant that the largeness of a room, if tight, is in this case of small importance, since it cannot part with a chimney full of its air without occasioning so much vacuum; which it requires a great force to effect, and could not be borne if effected.”

It appearing plainly then, that some of the outward air must be admitted, the question will be, how much is absolutely necessary? for you would avoid admitting more, as being contrary to one of your intentions in having a fire, viz. that of warming your room. To discover this quantity, shut the door gradually while a middling fire is burning, till you find that before it is quite shut the smoke begins to come out into the room; then open it a little till you perceive the smoke comes out no longer. There hold the door, and observe the

Smoke.

width of the open crevice between the edge of the door and the rabbet it should shut into. Suppose the distance to be half an inch, and the door eight feet high; you find thence that your room requires an entrance for air equal in area to 96 half inches, or 48 square inches, or a passage of 6 inches by 8. This, however, is a large supposition; there being few chimneys that, having a moderate opening and a tolerable height of funnel, will not be satisfied with such a crevice of a quarter of an inch: Dr Franklin found a square of 6 by 6, or 36 square inches, to be a pretty good medium that will serve for most chimneys. High funnels with small and low openings may indeed be supplied through a less space; because, for reasons that will appear hereafter, the force of levity, if one may so speak, being greater in such funnels, the cool air enters the room with greater velocity, and consequently more enters in the same time. This, however, has its limits; for experience shows, that no increased velocity so occasioned has made the admission of air through the key-hole equal in quantity to that through an open door, though through the door the current moves slowly, and through the key-hole with great rapidity.

It remains then to be considered, how and where this necessary quantity of air from without is to be admitted so as to be least inconvenient: for if at the door, left so much open, the air thence proceeds directly to the chimney, and in its way comes cold to your back and heels as you sit before your fire. If you keep the door shut, and raise a little the sash of your window, you feel the same inconvenience. Various have been the contrivances to avoid this; such as bringing in fresh air through pipes in the jams of the chimney, which pointing upwards should blow the smoke up the funnel; opening passages into the funnel above, to let in air for the same purpose. But these produce an effect contrary to that intended: for as it is the constant current of air passing from the room through the opening of the chimney into the funnel which prevents the smoke from coming out into the room, if you supply the funnel by other means or in other ways with the air which it wants, and especially if that air be cold, you diminish the force of that current, and the smoke in its efforts to enter the room finds less resistance.

The wanted air must then indispensably be admitted into the room, to supply what goes off through the opening of the chimney. M. Gauger, a very ingenious and intelligent French writer on the subject, proposes with judgment to admit it above the opening of the chimney; and to prevent inconvenience from its coldness, he directs that it may be so made, that it shall pass in its entrance through winding cavities made behind the iron back and sides of the fire-place, and under the iron hearth-plate; in which cavities it will be warmed, and even heated, so as to contribute much, instead of cooling, to the warming of the room. This invention is excellent in itself, and may be used with advantage in building new houses; because the chimneys may then be so disposed as to admit conveniently the cold air to enter such passages: but in houses built without such views, the chimneys are often so situated as not to afford that convenience without great and expensive alterations. Easy and cheap methods, though not quite so perfect in themselves, are of more general utility; and such are the following.

Smoke.

Smoke.

In all rooms where there is a fire, the body of air warmed and rarefied before the chimney is continually changing place, and making room for other air that is to be warmed in its turn. Part of it enters and goes up the chimney, and the rest rises and takes place near the ceiling. If the room be lofty, that warm air remains above our heads as long as it continues warm, and we are little benefited by it, because it does not descend till it is cooler. Few can imagine the difference of climate between the upper and lower parts of such a room, who have not tried it by the thermometer, or by going up a ladder till their heads are near the ceiling. It is then among this warm air that the wanted quantity of outward air is best admitted, with which being mixed, its coldness is abated, and its inconvenience diminished so as to become scarce observable. This may be easily done by drawing down about an inch the upper sash of a window; or, if not moveable, by cutting such a crevice through its frame; in both which cases it will be well to place a thin shelf of the length to conceal the opening, and sloping upwards, to direct the entering air horizontally along and under the ceiling. In some houses the air may be admitted by such a crevice made in the wainscot, cornice, or plastering, near the ceiling and over the opening of the chimney. This, if practicable, is to be chosen, because the entering cold air will there meet with the warmest rising air from before the fire, and be soonest tempered by the mixture. The same kind of shelf should also be placed here. Another way, and not a very difficult one, is to take out an upper pane of glass in one of your sashes, set it in a tin frame, giving it two springing angular sides, and then replacing it, with hinges below on which it may be turned to open more or less above. It will then have the appearance of an internal sky-light. By drawing this pane in, more or less, you may admit what air you find necessary. Its position will naturally throw that air up and along the ceiling. This is what is called in France a *Was ist das?* As this is a German question, the invention is probably of that nation, and takes its name from the frequent asking of that question when it first appeared. In England some have of late years cut a round hole about five inches diameter in a pane of the sash and placed against it a circular plate of tin hung on an axis, and cut into vanes; which, being separately bent a little obliquely, are acted upon by the entering air, so as to force the plate continually round like the vanes of a windmill. This admits the outward air, and by the continual whirling of the vanes, does in some degree disperse it. The noise only is a little inconvenient.

2. A second cause of the smoking of chimneys is, *their openings in the room being too large*; that is, too wide, too high, or both. Architects in general have no other ideas of proportion in the opening of a chimney than what relate to symmetry and beauty respecting the dimensions of the room; while its true proportion respecting its function and utility depends on quite other principles; and they might as properly proportion the step in a staircase to the height of the story, instead of the natural elevation of mens legs in mounting. The proportion then to be regarded, is what relates to the height of the funnel. For as the funnels in the different stories of a house are necessarily of different heights or lengths, that from the lowest floor be-

ing the highest or longest, and those of the other floors shorter and shorter, till we come to those in the garrets, which are of course the shortest; and the force of draft being, as already said, in proportion to the height of funnel filled with rarefied air, and a current of air from the room into the chimney, sufficient to fill the opening, being necessary to oppose and prevent the smoke from coming out into the room; it follows, that the openings of the longest funnels may be larger, and that those of the shorter funnels should be smaller. For if there be a large opening to a chimney that does not draw strongly, the funnel may happen to be furnished with the air which it demands by a partial current entering on one side of the opening, and leaving the other side free of any opposing current, may permit the smoke to issue there into the room. Much too of the force of draft in a funnel depends on the degree of rarefaction in the air it contains, and that depends on the nearness to the fire of its passage in entering the funnel. If it can enter far from the fire on each side, or far above the fire, in a wide or high opening, it receives little heat in passing by the fire, and the contents of the funnel are by those means less different in levity from the surrounding atmosphere, and its force in drawing consequently weaker. Hence if too large an opening be given to chimneys in upper rooms, those rooms will be smoky: On the other hand, if too small openings be given to chimneys in the lower rooms, the entering air operating too directly and violently on the fire, and afterwards strengthening the draft as it ascends the funnel, will consume the fuel too rapidly.

*Remedy.* As different circumstances frequently mix themselves in these matters, it is difficult to give precise dimensions for the openings of all chimneys. Our fathers made them generally much too large: we have lessened them; but they are often still of greater dimensions than they should be, the human eye not being easily reconciled to sudden and great changes. If you suspect that your chimney smokes from the too great dimension of its opening, contract it by placing moveable boards so as to lower and narrow it gradually till you find the smoke no longer issues into the room. The proportion so found will be that which is proper for that chimney, and you may employ the bricklayer or mason to reduce it accordingly. However, as in building new houses something must be sometimes hazarded, Dr Franklin proposes to make the openings in the lower rooms about 30 inches square and 18 deep, and those in the upper only 18 inches square and not quite so deep; the intermediate ones diminishing in proportion as the height of the funnel is diminished. In the larger openings, billets of two feet long, or half the common length of cordwood, may be burnt conveniently; and for the smaller, such wood may be sawed into thirds. Where coals are the fuel, the grates will be proportioned to the openings. The same depth is nearly necessary to all, the funnels being all made of a size proper to admit a chimney-sweeper. If in large and elegant rooms custom or fancy should require the appearance of a larger chimney, it may be formed of expensive marginal decorations, in marble, &c. But in time perhaps, that which is fittest in the nature of things may come to be thought handomest.

3. Another cause of smoky chimneys is *too short a funnel*. This happens necessarily in some cases, as where

Fig. 2.

Smoke.

a chimney is required in a low building; for, if the funnel be raised high above the roof, in order to strengthen its draft, it is then in danger of being blown down, and crushing the roof in its fall.

*Remedies.* Contract the opening of the chimney, so as to oblige all the entering air to pass through or very near the fire; whereby it will be more heated and rarified, the funnel itself be more warmed, and its contents have more of what may be called the force of levity, so as to rise strongly and maintain a good draft at the opening.

Or you may in some cases, to advantage, build additional stories over the low building, which will support a high funnel.

If the low building be used as a kitchen, and a contraction of the opening therefore inconvenient, a large one being necessary, at least when there are great dinners, for the free management of so many cooking utensils; in such case the best expedient perhaps would be to build two more funnels joining to the first, and having three moderate openings, one to each funnel, instead of one large one. When there is occasion to use but one, the other two may be kept shut by sliding plates, hereafter to be described; and two or all of them may be used together when wanted. This will indeed be an expence, but not an useless one, since your cooks will work with more comfort, see better than in a smoky kitchen what they are about, your victuals will be cleaner dressed and not taste of smoke, as is often the case; and to render the effect more certain, a stack of three funnels may be safely built higher above the roof than a single funnel.

The case of too short a funnel is more general than would be imagined, and often found where one would not expect it. For it is not uncommon, in ill-contrived buildings, instead of having a funnel for each room or fire-place, to bend and turn the funnel of an upper room so as to make it enter the side of another funnel that comes from below. By these means the upper room funnel is made short of course, since its length can only be reckoned from the place where it enters the lower room funnel; and that funnel is also shortened by all the distance between the entrance of the second funnel and the top of the stack: for all that part being readily supplied with air through the second funnel, adds no strength to the draft, especially as that air is cold when there is no fire in the second chimney. The only easy remedy here is, to keep the opening of that funnel shut in which there is no fire.

4. Another very common cause of the smoking of chimneys is, *their overpowering one another.* For instance, if there be two chimneys in one large room, and you make fires in both of them, the doors and windows close shut, you will find that the greater and stronger fire shall overpower the weaker, from the funnel of which it will draw air down to supply its own demand; which air descending in the weaker funnel, will drive down its smoke, and force it into the room. If, instead of being in one room, the two chimneys are in two different rooms, communicating by a door, the case is the same whenever that door is open. In a very tight house, a kitchen chimney on the lowest floor, when it had a great fire in it, has been known to overpower any other chimney in the house, and draw air and smoke

into its room as often as the door communicating with the stair case was opened.

*Remedy.* Take care that every room have the means of supplying itself from without with the air which its chimney may require, so that no one of them may be obliged to borrow from another, nor under the necessity of lending. A variety of these means have been already described.

5. Another cause of smoking is, *when the tops of chimneys are commanded by higher buildings, or by a hill,* so that the wind blowing over such eminences falls like water over a dam, sometimes almost perpendicularly on the tops of the chimneys that lie in its way, and beats down the smoke contained in them.

To illustrate this, let A (fig. 3.) represent a small building at the side of a great rock B, and the wind coming in the direction CD; when the current of air comes to the point D, being hurried forward with great velocity, it goes a little forward, but soon descends downward, and gradually is reflected more and more inward, as represented by the dotted lines EE, &c. so that, descending downwards upon the top of the chimney A, the smoke is beat back again into the apartments.

It is evident that houses situated near high hills or thick woods will be in some measure exposed to the same inconvenience; but it is likewise plain, that if a house be situated upon the slope of a hill (as at F, fig. 3.), it will not be in any danger of smoke when the wind blows towards that side of the hill upon which it is situated; for the current of air coming over the house-top in the direction GH, is immediately changed by the slope of the hill to the direction HC, which powerfully draws the smoke upward from the top of the chimney. But it is also evident, that a house in this situation will be liable to smoke when the wind blows from the hill; for the current of air coming downward in the direction CH, will beat downward on the chimney F, and prevent the smoke from ascending with freedom. The effect will be much heightened if the doors and windows are chiefly in the lowermost side of the house.

*Remedy.* That commonly applied to this case is a turncap made of tin or plate iron, covering the chimney above and on three sides, open on one side, turning on a spindle; and which being guided or governed by a vane always presents its back to the current. This may be generally effectual, though not certain, as there may be cases in which it will not succeed. Raising your funnels if practicable, so as their tops may be higher, or at least equal, with the commanding eminence, is more to be depended on. But the turning cap, being easier and cheaper, should first be tried. "If obliged to build in such a situation, I would choose (says Dr Franklin) to place my doors on the side next the hill, and the backs of my chimneys on the farthest side; for then the column of air falling over the eminence, and of course pressing on that below, and forcing it to enter the doors or *was-ill-dises* on that side, would tend to balance the pressure down the chimneys, and leave the funnels more free in the exercise of their functions."

6. There is another case which is the reverse of that last mentioned. It is where the commanding eminence

Smoke.

Smoke.

F. 4.

is farther from the wind than the chimney commanded. To explain this a figure may be necessary. Suppose then a building whose side AB happens to be exposed to the wind, and forms a kind of dam against its progress. Suppose the wind blowing in the direction FE. The air obstructed by this dam or building AB will like water press and search for passages through it; but finding none, it is beat back with violence, and spreads itself on every side, as is represented by the curved lines e, e, e, e, e, e. It will therefore force itself down the small chimney C. in order to get through by some door or window open on the other side of the building. And if there be a fire in such chimney, its smoke is of course beat down, and fills the room.

*Remedy.* There is but one remedy, which is to raise such a funnel higher than the roof, supporting it if necessary by iron bars. For a turncap in this case has no effect, the dammed up air pressing down through it in whatever position the wind may have placed its opening.

Dr Franklin mentions a city in which many houses are rendered smoky by this operation. For their kitchens being built behind, and connected by a passage with the houses, and the tops of the kitchen chimneys lower than the tops of the houses, the whole side of a street when the wind blows against its back forms such a dam as above described; and the wind so obstructed forces down those kitchen chimneys (especially when they have but weak fires in them) to pass through the passage and house into the street. Kitchen chimneys so formed and situated have another inconvenience. In summer, if you open your upper room windows for air, a light breeze blowing over your kitchen chimney towards the house, though not strong enough to force down its smoke as aforesaid, is sufficient to waft it into your windows, and fill the rooms with it; which, besides the disagreeableness, damages your furniture.

7. Chimneys, otherwise drawing well, are sometimes made to smoke by the *improper and inconvenient situation of a door*. When the door and chimney are on the same side of the room, if the door being in the corner is made to open against the wall, which is common, as being there, when open, more out of the way, it follows, that when the door is only opened in part, a current of air rushing in passes along the wall into and across the opening of the chimney, and stirs some of the smoke out into the room. This happens more certainly when the door is shutting, for then the force of the current is augmented, and becomes very inconvenient to those who, warming themselves by the fire, happen to sit in its way.

The remedies are obvious and easy. Either put an intervening screen from the wall round great part of the fireplace; or, which is perhaps preferable, shift the hinges of your door, so as it may open the other way, and when open throw the air along the other wall.

8. A room that has no fire in its chimney is sometimes filled with smoke which is received at the top of its funnel, and descends into the room. Funnel without fires have an effect according to their degree of coldness or warmth on the air that happens to be contained in them. The surrounding atmosphere is frequently changing its temperature; but stacks of funnels covered from winds and sun by the house that contains them, retain a more equal temperature. If, after a warm season, the out-

ward air suddenly grows cold, the empty warm funnels begin to draw strongly upward; that is, they rarefy the air contained in them, which of course rises, cooler air enters below to supply its place, is rarefied in its turn, and rises; and this operation continues till the funnel grows cooler, or the outward air warmer, or both, when the motion ceases. On the other hand, if after a cold season the outward air suddenly grows warm and of course lighter, the air contained in the cool funnels being heavier descends into the room; and the warmer air which enters their tops being cooled in its turn, and made heavier, continues to descend; and this operation goes on till the funnels are warmed by the passing of warm air thro' them, or the air itself grows cooler. When the temperature of the air and of the funnels is nearly equal, the difference of warmth in the air between day and night is sufficient to produce these currents: the air will begin to ascend the funnels as the cool of the evening comes on, and this current will continue till perhaps nine or ten o'clock the next morning, when it begins to hesitate; and as the heat of the day approaches, it sets downwards, and continues so till towards evening, when it again hesitates for some time, and then goes upwards constantly during the night, as before mentioned. Now when smoke issuing from the tops of neighbouring funnels passes over the tops of funnels which are at the time drawing downwards, as they often are in the middle part of the day, such smoke is of necessity drawn into these funnels, and descends with the air into the chamber.

The remedy is to have a sliding plate that will shut perfectly the offending funnel. Dr Franklin has thus described it: "The opening of the chimney is contracted by brick-work faced with marble slabs to about two feet between the jams, and the breast brought down to within about three feet of the hearth. An iron frame is placed just under the breast, and extending quite to the back of the chimney, so that a plate of the same metal may slide horizontally backwards and forwards in the grooves on each side of the frame. This plate is just so large as to fill the whole space, and shut the chimney entirely when thrust quite in, which is convenient when there is no fire. Draw it out, so as to leave between its further edge and the back a space of about two inches; this space is sufficient for the smoke to pass; and so large a part of the funnel being kept by the rest of the plate, the passage of warm air out of the room, up the chimney, is obstructed and retarded; and by those means much cold air is prevented from coming in through crevices, to supply its place. This effect is made manifest three ways. 1. When the fire burns briskly in cold weather, the howling or whistling noise made by the wind, as it enters the room through the crevices, when the chimney is open as usual, ceases as soon as the plate is slid in to its proper distance. 2. Opening the door of the room about half an inch, and holding your hand against the opening, near the top of the door, you feel the cold air coming in against your hand, but weakly, if the plate be in. Let another person suddenly draw it out, so as to let the air of the room go up the chimney, with its usual freedom where chimneys are open, and you immediately feel the cold air rushing in strongly. 3. If something be set against the door, just sufficient, when the plate is in, to keep the door nearly shut, by resisting the pressure of the

Smoke.



**Smoke.** air that would force it open: then, when the plate is drawn out, the door will be forced open by the increased pressure of the outward cold air endeavouring to get in to supply the place of the warm air that now passes out of the room to go up the chimney. In our common open chimneys, half the fuel is wasted, and its effect lost; the air it has warmed being immediately drawn off."

enough to admit my arm; a breach very dangerous with regard to fire, and occasioned probably by an apparent irregular settling of one side of the house. The air entering this breach freely, destroyed the drawing force of the funnel. The remedy would have been, filling up the breach, or rather rebuilding the funnel: but the landlord rather chose to stop up the chimney.

**Smoke-Jack.**

"Another puzzling case I met with at a friend's country house near London. His best room had a chimney in which, he told me, he never could have a fire, for all the smoke came out into the room. I flattered myself I could easily find the cause and prescribe the cure. I had a fire made there, and found it as he said. I opened the door, and perceived it was not want of air. I made a temporary contraction of the opening of the chimney, and found that it was not its being too large that caused the smoke to issue. I went out and looked up at the top of the chimney: Its funnel was joined in the same stack with others; some of them shorter, that drew very well, and I saw nothing to prevent its doing the same. In fine, after every other examination I could think of, I was obliged to own the insufficiency of my skill. But my friend, who made no pretension to such kind of knowledge, afterwards discovered the cause himself. He got to the top of the funnel by a ladder, and looking down found it filled with twigs and straw cemented by earth and lined with feathers. It seems the house, after being built, had stood empty some years before he occupied it; and he concluded that some large birds had taken the advantage of its retired situation to make their nest there. The rubbish, considerable in quantity, being removed, and the funnel cleared, the chimney drew well, and gave satisfaction."

Chimneys whose funnels go up in the north wall of a house, and are exposed to the north winds, are not so apt to draw well as those in a south wall; because when rendered cold by those winds, they draw downwards.

Chimneys inclosed in the body of a house are better than those whose funnels are exposed in cold walls.

Chimneys in stacks are apt to draw better than separate funnels, because the funnels that have constant fires in them warm the others in some degree that have none.

**SMOKE-JACK.** This ingenious machine is of German extraction; and Messinger, in his *Collection of Mechanical Performances*, says it is very ancient, being represented in a painting at Nurenbergh, which is known to be older than the year 1350.

Its construction is abundantly simple. An upright iron spindle GA (fig. 5.), placed in the narrow part of the kitchen chimney, turns round on two pivots H and I. The upper one H passes through an iron bar, which is built in across the chimney; and the lower pivot I is of tempered steel, and is conical or pointed, resting in a conical bell-metal socket fixed on another cross bar. On the upper end of the spindle is a circular fly G, consisting of 4, 6, 8, or more thin iron plates, set obliquely on the spindle like the sails of a windmill, as we shall describe more particularly by and by. Near the lower end of the spindle is a pinion A, which works in the teeth of a contrate or face wheel B, turning on a horizontal axis BC. One pivot of this axis turns in a cock fixed on the cross bar, which supports the lower end of the upright spindle HI, and the other pivot

Plate  
ccccxxx.

9. Chimneys which generally draw well, do nevertheless sometimes give smoke into the rooms, *it being driven down by strong winds passing over the tops of their funnels*, though not descending from any commanding eminence. This case is most frequent where the funnel is short and the opening turned from the wind. It is the more grievous, when it happens to be a cold wind that produces the effect, because when you most want your fire you are sometimes obliged to extinguish it. To understand this, it may be considered that the rising light air, to obtain a free issue from the funnel, must push out of its way or oblige the air that is over it to rise. In a time of calm or of little wind this is done visibly; for we see the smoke that is brought up by that air rise in a column above the chimney: but when a violent current of air, that is, a strong wind, passes over the top of a chimney, its particles have received so much force, which keeps them in a horizontal direction and follow each other so rapidly, that the rising light air has not strength sufficient to oblige them to quit that direction and move upwards to permit its issue.

**Remedies.** In Venice, the custom is to open or widen the top of the flue rounding it in the true form of a funnel. In other places the contrary is practised; the tops of the flues being narrowed inwards, so as to form a slit for the issue of the smoke, long as the breadth of the funnel, and only four inches wide. This seems to have been contrived on a supposition that the entry of the wind would thereby be obstructed, and perhaps it might have been imagined, that the whole force of the rising warm air being condensed, as it were, in the narrow opening, would thereby be strengthened, so as to overcome the resistance of the wind. This, however, did not always succeed; for when the wind was at north-east and blew fresh, the smoke was forced down by fits into the room where Dr Franklin commonly sat, so as to oblige him to shift the fire into another. The position of the slit of this funnel was indeed north-east and south-west. Perhaps if it had lain across the wind, the effect might have been different. But on this we can give no certainty. It seems a matter proper to be referred to experiment. Possibly a turncap might have been serviceable, but it was not tried.

With all the science, however, that a man shall suppose himself possessed of in this article, he may sometimes meet with cases that shall puzzle him. "I once lodged (says Dr Franklin) in a house at London, which in a little room had a single chimney and funnel. The opening was very small, yet it did not keep in the smoke, and all attempts to have a fire in this room were fruitless. I could not imagine the reason, till at length observing that the chamber over it, which had no fireplace in it, was always filled with smoke when a fire was kindled below, and that the smoke came through the cracks and crevices of the wainscot; I had the wainscot taken down, and discovered that the funnel which went up behind it had a crack many feet in length, and wide

Smoke-  
Jack.

turns in a cock fixed on the side wall of the chimney; so that this axle is parallel to the front of the chimney. On the remote end of this horizontal axle there is a small pulley C, having a deep angular groove. Over this pulley there passes a chain CDE, in the lower bight of which hangs the large pulley E of the spit. This end of the spit turns loosely between the branches of the fork of the rack or raxe F, but without resting on it. This is on the top of a moveable stand, which can be shifted nearer to or farther from the fire. The other end turns in one of the notches of another rack. The number of teeth in the pinion A and wheel B, and the diameters of the pulleys C and E, are so proportioned that the fly G makes from 12 to 20 turns for one turn of the spit.

The manner of operation of this useful machine is easily understood. The air which contributes to the burning of the fuel, and passes through the midst of it, is greatly heated, and expanding prodigiously in bulk, becomes lighter than the neighbouring air, and is therefore pushed by it up the chimney. In like manner, all the air which comes near the fire is heated, expanded, becomes lighter, and is driven up the chimney. This is called the *draught* or *suction*, but would with greater propriety be termed the *drift* of the chimney. As the chimney gradually contracts in its dimensions, and as the same quantity of heated air passes through every section of it, it is plain that the rapidity of its ascent must be greatest in the narrowest place. There the fly G should be placed, because it will there be exposed to the strongest current. This air, striking the fly vanes obliquely, pushes them aside, and thus turns them round with a considerable force. If the joint of meat is exactly balanced on the spit, it is plain that the only resistance to the motion of the fly is what arises from the friction of the pivots of the upright spindle, the friction of the pinion and wheel, the friction of the pivots of the horizontal axis, the friction of the small end of the spit, and the friction of the chain in the two pulleys. The whole of this is but a mere trifle. But there is frequently a considerable inequality in the weight of the meat on different sides of the spit: there must therefore be a sufficient overplus of force in the impulse of the ascending air on the vanes of the fly, to overcome this want of equilibrium occasioned by the unskillfulness or negligence of the cook. There is, however, commonly enough of power when the machine is properly constructed. The utility of this machine will, we hope, procure us the indulgence of some of our readers, while we point out the circumstances on which its performance depends, and the maxims which should be followed in its construction.

The upward current of air is the moving power, and should be increased as much as possible, and applied in the most advantageous manner. Every thing will increase the current which improves the draught of the chimney, and secures it from smoking. A smoky chimney must always have a weak current. For this particular, therefore, we refer to what has been delivered in the article PNEUMATICS, n<sup>o</sup> 359; and in the article SMOKE.

With respect to the manner of applying this force, it is evident that the best construction of a windmill sails will be nearly the best construction for the fly. According to the usual theory of the impulse of fluids,

the greatest effective impulse (that is, in the direction of the fly's motion) will be produced if the plane of the vane be inclined to the axis in an angle of 54 degrees 46 minutes. But, since we have pronounced this theory to be so very defective, we had better take a determination founded on the experiments on the impulse of fluids made by the academy of Paris. These authorize us to say, that 49 $\frac{1}{2}$  or 50 degrees will be the best angle to give the vane: but this must be understood only of that part of it which is close adjoining to the axis. The vane itself must be twisted, or *waith-red* as the millwrights term it, and must be much more oblique at its outer extremity. The exact position cannot be determined with any precision; because this depends on the proportion of the velocity of the vane to that of the current of heated air. This is subject to no rule, being changed according to the load on the jack. We imagine that an obliquity of 65 degrees for the outer ends of the vanes will be a good position for the generality of cases. Messinger describes an ingenious contrivance for changing this angle at pleasure, in order to vary the velocity of the motion. Each vane is made to turn round a midrib, which stands out like a radius from the spindle, and the vane is moved by a stiff wire attached to one of the corners adjoining to the axle. These wires are attached to a ring which slides on the spindle like the spreader of an umbrella; and it is stopped on any part of the spindle by a pin thrust through a hole in the spindle and ring. We mention this briefly, it being easily understood by any mechanic, and but of little consequence, because the machine is not susceptible of much precision.

It is easy to see that an increase of the surface of the vanes will increase the power: therefore they should occupy the whole space of the circle, and not consist of four narrow arms like the sails of a windmill. It is better to make many narrow vanes than a few broad ones; as will appear plain to one well acquainted with the mode of impulse of fluids acting obliquely. We recommend 8 or 12 at least; and each vane should be so broad, that when the whole is held perpendicular between the eye and the light, no light shall come through the fly, the vanes overlapping each other a *very small matter*. We also recommend the making them of stiff plate. Their weight contributes to the steady motion, and enables the fly, which has acquired a considerable velocity during a favourable position of things, to retain a momentum sufficient to pull round the spit while the heavy side of the meat is rising from its lowest position. In such a situation a light fly soon loses its momentum, and the jack staggers under its load.

It is plain, from what has been said, that the fly should occupy the whole of that section of the vent where it is placed. The vent must therefore be brought to a round form in that place, that none of the current may pass uselessly by it.

It is an important question where the fly should be placed. If in a wide part of the vent, it will have a great surface, and act by a long lever; but the current in that place is slow, and its impulse weak. This is a fit subject of calculation. Suppose that we have it in our choice to place it either as it is drawn in the figure, or farther up at g, where its diameter must be one half of what it is at G. Since the same quantity of heated air passes through both sections, and the section g has only one-fourth

Smoke-  
Jack.

fourth of the area of the section  $G$ , it is plain that the air must be moving four times faster, and that its impulse is 16 times greater. But the surface on which it is acting is the fourth part of that of the fly  $G$ ; the actual impulse therefore is only four times greater, supposing both flies to be moving with the same relative velocity in respect of the current; that is, the rim of each moving with the same portion of the velocity of the current. This will be the case when the small fly turns eight times as often in a minute as the large fly: for the air is moving four times as quick at  $g$ , and the diameter of  $g$  is one-half of that of  $G$ . Therefore, when the small fly is turning eight times as quick as the great one, there is a quadruple impulse acting at half the distance from the axis. The momentum or energy therefore of the current is double. Therefore, supposing the pinion, wheel, and pulleys of both jacks to be the same, the jack with the small fly, placed in the narrow part of the vent, will be 16 times more powerful.

By this example, more easily understood than a general process, it appears that it is of particular importance to place the fly in an elevated part of the vent, where the area may be much contracted. In order still farther to increase the power of the machine, it would be very proper to lengthen the spindle still more, and to put another fly on it at a considerable distance above the first, and a third above this, &c.

As the velocity of the current changes by every change of the fire, the motion of this jack must be very unsteady. To render it as adjustable as may be to the particular purpose of the cook, the pulley  $E$  has several grooves of different diameters, and the spit turns more or less slowly, by the same motion of the fly, according as it hangs in the chain by a larger or smaller pulley or groove.

Such is the construction of the smoke-jack in its most simple form. Some are more artificial and complicated, having, in place of the pulleys and connecting chain, a spindle coming down from the horizontal axis  $BC$ . On the upper end of this spindle is a horizontal contrate wheel, driven by a pinion in place of the pulley  $C$ . On the lower end is a pinion, driving a contrate wheel in place of the pulley  $E$ . This construction is represented in fig. 6. Others are constructed more simply, in the manner represented in fig. 7. But our first construction has great advantage in point of simplicity, and allows a more easy adjustment of the spit, which may be brought nearer to the fire or removed farther from it without any trouble; whereas, in the others, with a train of wheels and pinions, this cannot be done without several changes of pins and screws. The only imperfection of the pulley is, that by long use the grooves become slippery, and an ill balanced joint is apt to hold back the spit, while the chain slides in the grooves. This may be completely prevented by making the grooves flat instead of angular (which greatly diminishes the friction), and furnishing them with short studs or pins which take into every third or fourth link of the chain. If the chain be made of the simplest form, with flat links, and each link be made of an exact length (making them all on a mould), the motion will be as easy as with any wheelwork, and without the least chance of slipping.

It is always of importance to avoid this slipping of the chain by balancing the loaded spit. For this purpose it will be extremely convenient to have what is called a *balance-skewer*. Let a part of the spit, immediately adjoining to the pulley, be made round, and let an arm be made to turn on it stiffly, so that it may be made fast in any position by a screw. Let a leaden ball be made to slide along this arm, with a screw to fasten it at any distance from the spit. When the meat is spitted, lay it on the racks, and the heaviest side will immediately place itself undermost. Now turn round the balance-skewer, so that it may point straight upwards, and make it fast in that position by the screw. Put the leaden ball on it, and slide it inwards or outwards till it exactly balances the heavy side, which will appear by the spit's remaining in any position in which it is put.

The greatest difficulty is to keep the machine in repair. The most consequential part of it, the first mover, the fly, and the pinion and wheel, by which its motion is transmitted to the rest of the machine, are situated in a place of difficult access, and where they are exposed to violent heat and to the smoke and soot. The whole weight of the fly, resting on the lower pivot  $I$ , must exert a great pressure there, and occasion great friction, even when this pinion is reduced to the smallest size that is compatible with the necessary strength. The pivot must be of hardened steel, tapered like an obtuse cone, and must turn in a conical socket, also of hardened steel or of bell-metal; and this seat of pressure and friction must be continually supplied with oil, which it consumes very quickly. It is not sufficient that it be from time to time smeared with an oiled feather; there must be an iron cup formed round the socket, and kept filled with oil. It is surprising how quickly it disappears: it soon becomes clammy by evaporation, and by the soot which gathers about it. The continued rubbing of the pivot and socket wears them both very fast; and this is increased by hard powders, such as sandy dust, that are hurried up by the rapid current every time that the cook stirs the fire. These, getting between the rubbing parts, cause them to grind and wear each other prodigiously. It is a great improvement to invert these rubbing parts. Let the lower end of the spindle be of a considerable thickness, and have a conical hollow nicely drilled in its extremity. Let a blunt pointed conical pin rise up in the middle of the oil-cup, on which the conical hollow of the spindle may rest. Here will be the same steady support, and the same friction as in the other way; but no grinding dust can now lodge between the pivot and its socket: and if this upright pin be screwed up through the bottom of the cup, it may be screwed farther up in proportion as it wears; and thus the upper pivot  $g$  will never desert its hole, a thing which soon happens in the common way. We can say from experience, that a jack constructed in this way will not require the fifth part of the repairs of one done in the other way.

It is of importance that the whole be so put together as to be easily taken down, in order to sweep the vent, or to be repaired, &c. For this purpose, let the cross bar which carries the lower end of the upright spindle be placed a little on one side of the perpendicular line from the upper pivot hole. Let the cock which

Smoke-  
Jack  
||  
Smollet.

carries the oil-cup and the pivot of the horizontal axis BC be screwed to one side of this cross bar, so that the centre of the cup may be exactly under the upper pivot hole. By this construction we have only to unscrew this cock, and then both axles come out of their places at once, and may be replaced without any trouble. We have sketched in fig. 8. the manner in which this may be done, where M represents a section of the lower cross bar. BCDE is the cock, fixed to the bar by the pins which go through both, with finger nuts *a* and *b* on the opposite side. *F i* is the hard steel pin with the conical top *i*, on which the lower end I of the upright spindle AG rests, in the manner recommended as the best and the most durable. The pivot of the horizontal axis turns in a hole at E the top of the cock.

After all, we must acknowledge that the smoke jack is inferior to the common jack that is moved by a weight. It is more expensive at first, and requires more frequent repairs; its motion is not so much under command; it occasions soot to be thrown about the fire, to the great annoyance of the cook; and it is a great encumbrance when we would clean the vent.

*SMOKE-Farthings.* The pentecostals or customary oblations offered by the dispersed inhabitants within a diocese when they made their procession to the mother or cathedral church, came by degrees into a standing annual rent called *smoke-farthings*.

*SMOKE-Silver.* Lands were holden in some places by the payment of the sum of 6 d. yearly to the sheriff, called *smoke-silver* (Par. 4. Edw. VI.) Smoke-silver and smoke-penny are to be paid to the ministers of divers parishes as a *modus* in lieu of tithe-wood: and in some manors formerly belonging to religious houses, there is still paid, as appendant to the said manors, the ancient Peter-pence, by the name of *smoke-money* (*Twifd. Hist. Vindict.* 77.)—The bishop of London *anno* 1444 issued out his commission, *Ad levandum le smoke-farthings*, &c.

SMOLENSKO, a large and strong city of Russia, and capital of a palatinate of the same name, with a castle seated on a mountain, and a bishop's see. It is strong by its situation, being in the middle of a wood, and surrounded by almost inaccessible mountains. It has been taken and retaken several times by the Poles and Russians; but these last have had possession of it ever since the year 1687. It is seated on the river Nieper, near the frontiers of Lithuania, 188 miles south-west of Moscow. E. Long. 31. 22. N. Lat. 54. 50.

SMOLENSKO, a duchy and palatinate of Russia, bounded on the north by Biela, on the east by the duchy of Moscow, on the south by that of Severia and the palatinate of Meislaw, and on the west by the same palatinate and by that of Witepsk. It is full of forests and mountains; and the capital is of the same name.

SMOLLET (Dr Tobias), an author whose writings will transmit his name with honour to posterity, was born in the year 1720 at a small village within two miles of Cameron, on the banks of the river Leven. He appears to have received a classical education, and was bred to the practice of physic and surgery; and in the early part of his life served as a surgeon's mate in the navy.

The incidents that befel him during his continuance in this capacity served as a foundation for Roderic Ran-

dom, one of the most entertaining novels in the English tongue. He was present at the siege of Carthage; and in the before-mentioned novel he has given a faithful, though not very pleasing, account of the management of that ill-conducted expedition, which he censures in the warmest terms, and from circumstances which fell under his own particular observation.

His connection with the sea seems not to have been of long continuance; and it is probable that he wrote several pieces before he became known to the public by his capital productions. The first piece we know of with certainty is a Satire in two parts, printed first in the years 1746 and 1747, and reprinted in a Collection of his Plays and Poems in 1777. About this period, or some time before, he wrote for Mr Rich an opera intitled *Alceste*, which has never been performed nor printed.

At the age of 18 he wrote a tragedy intitled *The Regicide*, founded on the story of the assassination of James I. of Scotland. In the preface to this piece, published by subscription in the year 1749, he bitterly exclaimed against false patrons, and the duplicity of theatrical managers. The warmth and impetuosity of his temper hurried him, on this occasion, into unjust reflections against the late George Lord Lyttleton and Mr Garrick: the character of the former he characterized in the novel of *Peregrine Pickle*, and he added a burlesque of the *Monody* written by that nobleman on the death of his lady. Against Mr Garrick he made illiberal ill founded criticisms; and in his novel of *Roderic Random* gave a very unfair representation of his treatment of him respecting this tragedy. Of this conduct he afterwards repented, and acknowledged his errors; though in the subsequent editions of the novel the passages which were the hasty effusions of disappointment are not omitted.

However, in giving a sketch of the liberal arts in his *History of England*, he afterwards remarked, "the exhibitions of the stage were improved to the most exquisite entertainment by the talents and management of Garrick, who greatly surpassed all his predecessors of this and perhaps every other nation, in his genius for acting, in the sweetness and variety of his tones, the irresistible magic of his eye, the fire and vivacity of his action, the eloquence of attitude, and the whole pathos of expression."

"Candidates for literary fame appeared even in the higher sphere of life, embellished by the nervous sense and extensive erudition of a Corke; by the delicate taste, the polished muse, and the tender feelings, of a Lyttleton."

Not satisfied with this public declaration, he wrote an apology to Mr Garrick in still stronger terms. With these ample concessions, Mr Garrick was completely satisfied; so that in 1757, when Dr Smollet's comedy of the *Reprisals*, an afterpiece of two acts, was performed at Drury-Lane theatre, the latter acknowledged himself highly obliged for the friendly care of Mr Garrick exerted in preparing it for the stage; and still more for his acting the part of *Lusignan* in *Zara* for his benefit, on the sixth instead of the ninth night, to which he was only intitled by the custom of the theatre.

The *Adventures of Roderic Random*, published in 1748, 2 vols 12mo, a book which still continues to have a most extensive

Smollet.

Smollet. extensive sale, first established the Doctor's reputation. All the first volume and the beginning of the second appears to consist of real incident and character, tho' certainly a good deal heightened and disguised. The Judge his grandfather, Crab and Potion the two apothecaries, and Squire Gawky, were characters well known in that part of the kingdom where the scene was laid. Captains Oakham and Whistle, Doctors Mackshane and Morgan, were also said to be real personages; but their names we have either never learned or have now forgotten. A bookbinder and barber long eagerly contended for being shadowed under the name of *Strap*. The Doctor seems to have enjoyed a peculiar felicity in describing sea-characters, particularly the officers and sailors of the navy. His Truncheon, Hatchway, and Pipes, are highly finished originals; but what exceeds them all, and perhaps equals any character that has yet been painted by the happiest genius of ancient or modern times, is his Lieutenant Bowling. This is indeed nature itself; original, *unique*, and *sui generis*.

By the publication of this work the Doctor had acquired so great a reputation, that henceforth a certain degree of success was insured to every thing known or suspected to proceed from his hand. In the course of a few years, the *Adventures of Peregrine Pickle* appeared; a work of great ingenuity and contrivance in the composition, and in which an uncommon degree of erudition is displayed, particularly in the description of the entertainment given by the Republican Doctor, after the manner of the ancients. Under this personage the late Dr Akenfide, author of *The Pleasures of Imagination*, is supposed to be typified; and it would be difficult to determine whether profound learning or genuine humour predominate most in this episode. Another episode of *The Adventures of a Lady of Quality*, likewise inserted in this work, contributed greatly to its success, and is indeed admirably executed; the materials, it is said, the lady herself (the celebrated lady *Vane*) furnished.

These were not the only original compositions of this stamp with which the Doctor has favoured the public. *Ferdinand Count Fathom*, and *Sir Launcelot Greaves*, are still in the list of what may be called *reading novels*, and have gone through several editions; but there is no injustice in placing them in a rank far below the former. No doubt invention, character, composition, and contrivance, are to be found in both; but then situations are described which are hardly possible, and characters are painted which, if not altogether unexampled, are at least incompatible with modern manners; and which ought not to be, as the scenes are laid in modern times.

The last work which we believe the Doctor published was of much the same species, but cast into a different form—*The Expedition of Humphrey Clinker*. It consists of a series of letters, written by different persons to their respective correspondents. He has here carefully avoided the faults which may be justly charged to his two former productions. Here are no extravagant characters nor unnatural situations. On the contrary, an admirable knowledge of life and manners is displayed; and most useful lessons are given applicable to interesting but to very common situations.

We know not whether the remark has been made,

but there is certainly a very obvious similitude between the characters of the three heroes of the Doctor's chief productions. Roderic Random, Peregrine Pickle, and Matthew Bramble, are all brothers of the same family. The same satirical, cynical, disposition, the same generosity and benevolence, are the distinguishing and characteristic features of all three; but they are far from being servile copies or imitations of each other. They differ as much as the Ajax, Diomed, and Achilles of Homer. This was undoubtedly a great effort of genius; and the Doctor seems to have described his own character at the different stages and situations of his life.

Before he took a house at Chelsea, he attempted to settle as practitioner of physic at Bath; and with that view wrote a treatise on the waters; but was unsuccessful, chiefly because he could not render himself agreeable to the women, whose favour is certainly of great consequence to all candidates for eminence, whether in medicine or divinity. This, however, was a little extraordinary; for those who remembered Dr Smollet at that time, cannot but acknowledge that he was as graceful and handsome a man as any of the age he lived in; besides, there was a certain dignity in his air and manner which could not but inspire respect wherever he appeared. Perhaps he was too soon discouraged; in all probability, had he persevered, a man of his great learning, profound sagacity, and intense application, besides being endowed with every other external as well as internal accomplishment, must have at last succeeded, and had he attained to common old age, been at the head of his profession.

Abandoning physic altogether as a profession, he fixed his residence at Chelsea, and turned his thoughts entirely to writing. Yet, as an author, he was not near so successful as his happy genius and acknowledged merit certainly deserved. He never acquired a patron among the great, who by his favour or beneficence relieved him from the necessity of writing for a subsistence. The truth is, Dr Smollet possessed a loftiness and elevation of sentiment and character which appears to have disqualified him for paying court to those who were capable of conferring favours. It would be wrong to call this disposition pride or haughtiness; for to his equals and inferiors he was ever polite, friendly, and generous. Booksellers may therefore be said to have been his only patrons; and from them he had constant employment in translating, compiling, and reviewing. He translated *Gil Blas* and *Don Quixote*, both so happily, that all the former translations of these excellent productions of genius have been almost superseded by his. His name likewise appears to a translation of *Voltaire's Prose Works*: but little of it was done by his own hand; he only revised it, and added a few notes. He was concerned in a great variety of compilations. His *History of England* was the principal work of that kind. It had a most extensive sale; and the Doctor is said to have received L. 2000 for writing it and the continuation.

In 1755 he set on foot the *Critical Review*, and continued the principal manager of it till he went abroad for the first time in the year 1763. He was perhaps too acrimonious sometimes in the conduct of that work; and at the same time displayed too much sensibility when

Smollet.

when any of the unfortunate authors attempted to retaliate whose works he had perhaps justly censured.

Among other controversies in which his engagements in this publication involved him, the most material in its consequences was that occasioned by his remarks on a pamphlet published by Admiral Knowles. That gentleman, in defence of his conduct on the expedition to Rochfort, published a vindication of himself; which falling under the Doctor's examination, produced some very severe strictures both on the performance and on the character of the writer. The admiral immediately commenced a prosecution against the printer; declaring at the same time that he desired only to be informed who the writer was, that if he proved to be a gentleman he might obtain the satisfaction of one from him. In this affair the Doctor behaved both with prudence and with spirit. Desirous of compromising the dispute with the admiral in an amicable manner, he applied to his friend Mr Wilkes to interpose his good offices with his opponent. The admiral, however, was inflexible; and just as sentence was going to be pronounced against the printer, the Doctor came into court, avowed himself the author of the strictures, and declared himself ready to give Mr Knowles any satisfaction he chose. The admiral immediately commenced a fresh action against the Doctor, who was found guilty, fined L. 100, and condemned to three months imprisonment in the King's Bench. It is there he is said to have written *The Adventures of Sir Launcelot Greaves*, in which he has described some remarkable characters, then his fellow-prisoners.

When Lord Bute was called to the chief administration of affairs, he was prevailed upon to write in defence of that nobleman's measures; which he did in a weekly paper called the *Briton*. This gave rise to the famous *North Briton*; wherein, according to the opinion of the public, he was rather baffled. The truth is, the Doctor did not seem to possess the talents necessary for political altercation. He wanted temper and coolness; and his friends accused his patron of having denied him the necessary information, and even neglected the fulfilling of some of his other engagements with him. Be that as it will, the Doctor is said not to have forgotten him in his subsequent performances.

Besides the *Briton*, Dr Smollet is supposed to have written other pieces in support of the cause he espoused. *The Adventures of an Atom*, in two volumes, are known to be his production.

His constitution being at last greatly impaired by a sedentary life and assiduous application to study, he went abroad for his health in June 1763, and continued in France and Italy two years. He wrote an account of his travels in a series of letters to some friends, which were afterwards published in two volumes octavo, 1766. During all that time he appears to have laboured under a constant fit of chagrin. A very slight perusal of these letters will sufficiently evince that this observation is founded in fact, and is indeed a melancholy instance of the influence of bodily disorder over the best disposition.

His relation of his travels is actually cynical; for which Sterne, in his *Sentimental Journey*, has animated on him under the character of Smelfungus. The Doctor lived to return to his native country: but his

health continuing to decline, and meeting with fresh mortifications and disappointments, he went back to Italy, where he died in October 21. 1771. He was employed, during the last years of his life, in abridging the *Modern Universal History*, great part of which he had originally written himself, particularly the histories of France, Italy, and Germany.

He certainly met with many mortifications and disappointments; which, in a letter to Mr Garrick, he thus feelingly expresses: "I am old enough to have seen and observed, that we are all playthings of Fortune; and that it depends upon something as insignificant and precarious as the tossing up of a halfpenny, whether a man rises to affluence and honours, or continues to his dying day struggling with the difficulties and disgraces of life."

It would be needless to expatiate on the character of a man so well known as Dr Smollet, who has, besides, given so many strictures of his own character and manner of living in his writings, particularly in *Humphrey Clinker*; where he appears under the appellation of *Mr Serle*, and has an interview with Mr Bramble; and his manner of living is described in another letter, where young Melford is supposed to dine with him at his house in Chelsea. No doubt he made money by his connections with the bookfellers; and had he been a rigid economist, or endued with the gift of retention (an expression of his own), he might have lived and died very independent. However, to do justice to his memory, his difficulties, whatever they were, proceeded not from extravagance or want of economy. He was hospitable, but not ostentatiously so; and his table was plentiful, but not extravagant. No doubt he had his failings; but still it would be difficult to name a man who was so respectable for the qualities of his head, or more amiable for the virtues of his heart.

Since his death a monument has been erected to his memory near Leghorn, on which is inscribed an epitaph written in Latin by his friend Dr Armstrong, author of *The Art of Preserving Health*, and many other excellent pieces. An inscription written in Latin was likewise inscribed on a pillar erected to his memory on the banks of the Leven, by one of his relations.

To these memoirs we are extremely sorry to add, that so late as 1785 the widow of Dr Smollet was residing in indigent circumstances at Leghorn. On this account the tragedy of *Venice Preserved* was acted for her benefit at Edinburgh on the 5th of March, and an excellent prologue spoken on that occasion.

The pieces inserted in the posthumous collection of Dr Smollet's plays and poems are, *The Regicide*, a tragedy; *The Reprisal*, a comedy; *Advice and Reproof*, two satires; *The Tears of Scotland*; *Verses on a Young Lady*; a *Love Elegy*, in imitation of Tibullus; two *Songs*; a *Burlesque Ode*; *Odes to Mirth, to Sleep, to Leven Water, to Blue-ey'd Ann, and to Independence*.

**SMUGGLERS**, persons who import or export prohibited goods without paying the duties appointed by the law.

The duties of customs, it is said, were originally instituted, in order to enable the king to afford protection to trade against pirates: they have since been continued as a branch of the public revenue. As duties

im-

Smollet,  
Smugglers

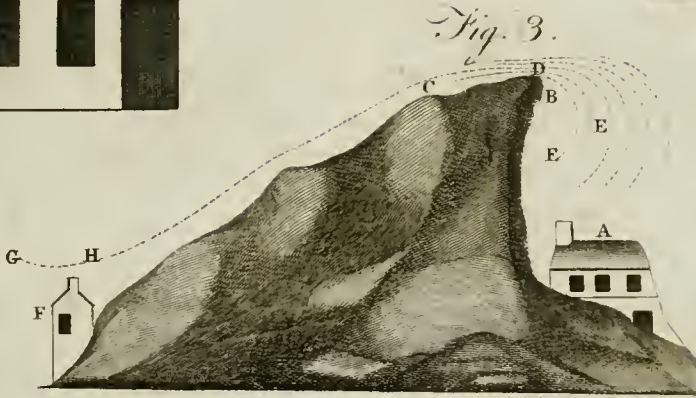
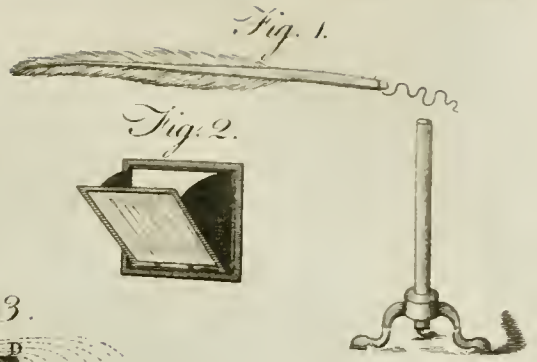
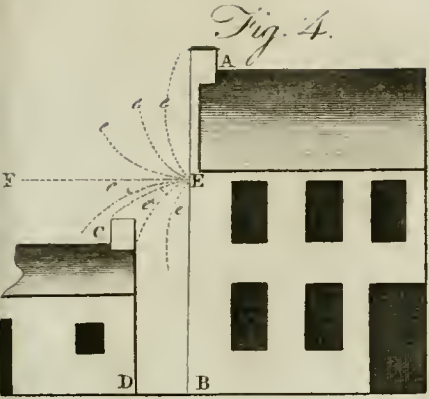

SMOKE JACK.

*Fig. 8.*

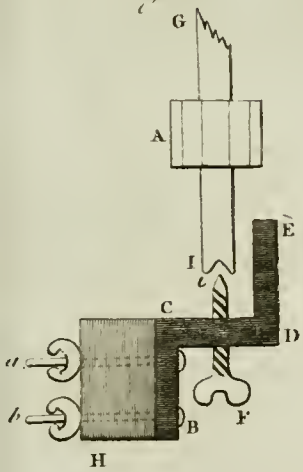

*Fig. 7.*

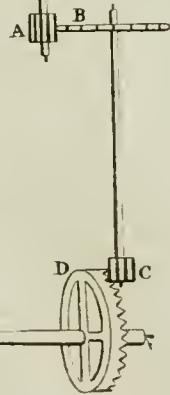

*Fig. 5.*

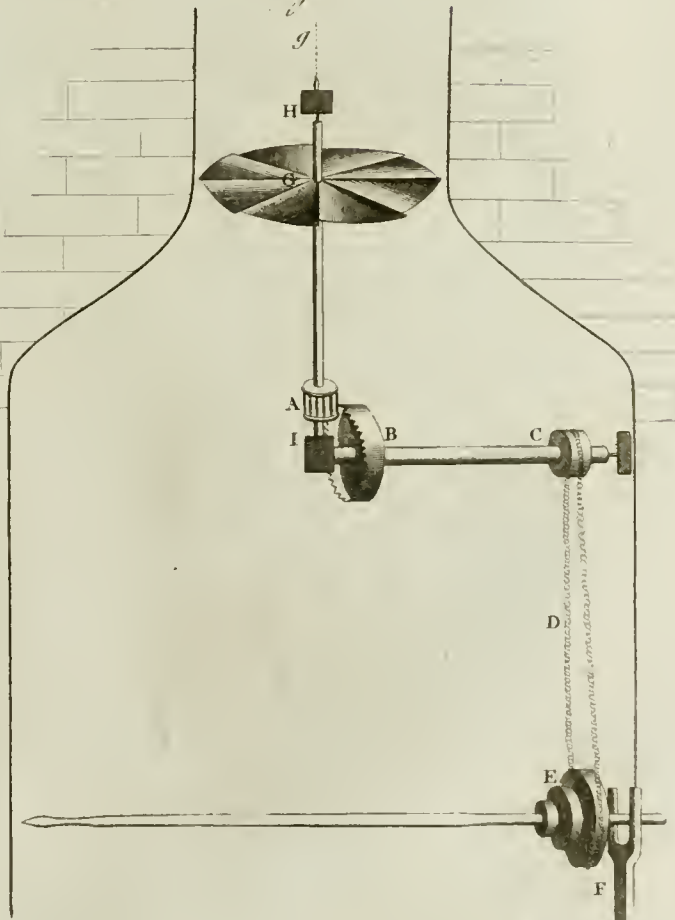

*Fig. 6.*

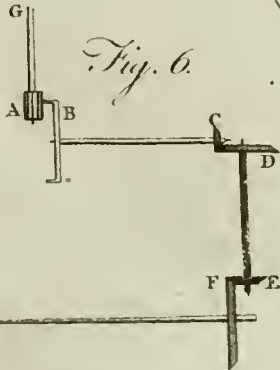





**Smugglers.** imposed upon the importation of goods necessarily raises their price above what they might otherwise have been sold for, a temptation is presented to import the commodity clandestinely and to evade the duty. Many persons, prompted by the hopes of gain, and considering the violation of a positive law of this nature as in no respect criminal (an idea in which they have been encouraged by a great part of the community, who make no scruple to purchase smuggled goods), have engaged in this illicit trade. It was impossible that government could permit this practice, which is highly injurious to the fair trader, as the smuggler is enabled to undersell him, while at the same time he impairs the national revenue, and thus wholly destroys the end for which these duties were appointed. Such penalties are therefore inflicted as it was thought would prevent smuggling.

**Law Statutory.** Many laws have been made with this view. If any goods be shipped or landed without warrant and presence of an officer, the vessel shall be forfeited, and the wharfinger shall forfeit L. 100, and the master or mariner of any ship inward bound shall forfeit the value of the goods: and any carman, porter, or other assisting, shall be committed to gaol, till he find surety of the good behaviour, or until he shall be discharged by the court of exchequer (13 & 14 C. II. c. 11.) If goods be relanded after drawback, the vessel and goods shall be forfeited; and every person concerned therein shall forfeit double the value of the drawback (8 An. c. 13.) Goods taken in at sea shall be forfeited, and also the vessel into which they are taken; and every person concerned therein shall forfeit treble value (9 G. II. c. 35.) A vessel hovering near the coast shall be forfeited, if under 50 tons burden; and the goods shall also be forfeited, or the value thereof (5 G. III. c. 43.) Persons receiving or buying run goods shall forfeit L. 20 (8 G. c. 18.) A concealer of run goods shall forfeit treble value (8 G. c. 18.) Offering run goods to sale, the same shall be forfeited, and the person to whom they are offered may seize them; and the person offering them to sale shall forfeit treble value (11 G. c. 30.) A porter or other person carrying run goods shall forfeit treble value (9 G. II. c. 35.) Persons armed or disguised carrying run goods shall be guilty of felony, and transported for seven years (8 G. c. 18. 9 G. II. c. 35.)

But the last statute, 19 G. II. c. 34. is for this purpose *inlar omnium*; for it makes all forcible acts of smuggling, carried on in defiance of the laws, or even in disguise to evade them, felony without benefit of clergy: enacting, that if three or more persons shall assemble, with fire-arms or other offensive weapons, to assist in the illegal exportation or importation of goods, or in rescuing the same after seizure, or in rescuing offenders in custody for such offences; or shall pass with such goods in disguise; or shall wound, shoot at, or assault, any officers of the revenue when in the execution of their duty; such persons shall be felons, without the benefit of clergy.

When we consider the nature, and still more the history, of mankind, we must allow that the enacting of severe penal laws is not the way to prevent crimes. It were indeed much to be wished that there were no such thing as a political crime; for the generality of men, but especially the lower orders, not discerning the pro-

riety or utility of such laws, consider them as oppressive and tyrannical, and never hesitate to violate them when they can do it with impunity. Instead therefore of punishing smugglers, it would be much better to remove the temptation. But the high duties which have been imposed upon the importation of many different sorts of foreign goods, in order to discourage their consumption in Great Britain, have in many cases served only to encourage smuggling; and in all cases have reduced the revenue of the customs below what more moderate duties would have afforded. The saying of Dr Swift, that in the arithmetic of the customs two and two, instead of making four, make sometimes only one, holds perfectly true with regard to such heavy duties, which never could have been imposed, had not the mercantile system taught us, in many cases, to employ taxation as an instrument, not of revenue, but of monopoly.

The bounties which are sometimes given upon the exportation of home produce and manufactures, and the drawbacks which are paid upon the re-exportation of the greater part of foreign goods, have given occasion to many frauds, and to a species of smuggling more destructive of the public revenue than any other. In order to obtain the bounty or drawback, the goods, it is well known, are sometimes shipped and sent to sea, but soon afterwards clandestinely relanded in some other part of the country.

Heavy duties being imposed upon almost all goods imported, our merchant importers smuggle as much, and make entry of as little as they can. Our merchant-exporters, on the contrary, make entry of more than they export; sometimes out of vanity, and to pass for great dealers in goods which pay no duty; and sometimes to gain a bounty or drawback. Our exports, in consequence of these different frauds, appear upon the customhouse books greatly to overbalance our imports; to the unspeakable comfort of those politicians who measure the national prosperity by what they call the balance of trade.

**SMUT**, in husbandry, a disease in corn, when the grains, instead of being filled with flour, are full of a stinking black powder. See **WHEAT**.

**SMYRNA**, or **ISMIR**, at present the largest and richest city of Asia Minor, is situated in north latitude 38° 28', and in E. Long. 27° 25' from Greenwich, and about 183 miles west by south of Constantinople. The town extends along the shore about half a mile on a gentle declivity. The houses of the English, French, and Dutch consuls are handsome structures; these, with most of those occupied by the Christian merchants, are washed on one side by the sea, forming a street named *Frank-street*, from its being solely inhabited by European Christians. In the year 1763 the whole of this quarter was consumed by fire: the loss sustained by this calamity in merchandize was estimated at a million and a half of Turkish dollars, or near L. 200,000 Sterling. The port is one of the finest of the Levant, it being able to contain the largest fleet; and indeed there are seldom in it fewer than 100 ships of different nations.

A castle stands at its entrance, and commands all the shipping which sail in or out. There is likewise an old ruinous castle, near a mile in circumference, which stands in the upper part of the city, and, according to tradition,

**Smyrna.** tion, was built by the empress Helena: and near it is an ancient structure, said to be the remains of a palace where the Greek council was held when Smyrna was the metropolis of Asia Minor. They also show the ruins of an amphitheatre, where it is said St Polycarp, the first bishop, fought with lions.

This city is about four miles in circumference, and nearly of a triangular form; but the side next the mountain is much longer than the other sides. The houses are low, and mostly built with clay-walls, on account of the earthquakes to which the country is subject; but the caravanseras and some other of the public buildings have an air of magnificence. The streets are wide, and almost a continued bazar, in which a great part of the merchandize of Europe and Asia is exposed to sale, with plenty of provisions; though these are not so cheap as in many other parts of Turkey, on account of the populousness of the place, and the great resort of foreigners. It is said to contain 15,000 Turks, 10,000 Greeks, 1800 Jews, 200 Armenians, and 200 Franks. The Turks have 19 mosques; two churches belong to the Greeks; one to the Armenians; and the Jews have eight synagogues. The Romanists have three convents. There is also one of the fathers Della Terra Santa. Here resides an archbishop of the Greek church; a Latin bishop who has a salary from Rome, with the title of bishop of Smyrna *in partibus infidelium*; and the English and Dutch factories have each their chaplain.

The walks about the town are extremely pleasant, particularly on the west side of Frank-street, where there are several little groves of orange and lemon trees, which being always clothed with leaves, blossoms, and fruit, regale several of the senses at the same time. The vines which cover the little hills about Smyrna afford both a delightful prospect and plenty of grapes, of which good wine is made. These hills are agreeably interspersed with fertile plains, little forests of olives and other fruit-trees, and many pleasure-houses, to which the Franks usually retire during the summer. In the neighbourhood of Smyrna is great plenty of game and wild-fowl, and particularly deer and wild-hogs. The sea also abounds with a variety of good fish. The European Christians are here allowed all imaginable liberties, and usually clothe themselves after the European manner.

The chief commerce of this city consists in raw silk, silk-stuffs, programs, and cotton yarn.

However, the unhealthfulness of the situation, and more especially the frequent earthquakes, from which, it is said, they are scarcely ever free for two years together, and which have been felt 40 days successively, are an abatement of the pleasure that might otherwise be enjoyed here. A very dreadful one happened in June 1688, which overthrew a great number of the houses; and the rock opening where the cattle stood, swallowed it up, and no less than 5000 persons perished on this occasion.

In the year 1758, so desolating a plague raged here, that scarcely a sufficient number of the inhabitants survived to gather in the fruits of the earth. In the year 1772, three-fourth parts of the city were consumed by fire; and six years after it was visited by the most dreadful earthquakes, which continued from the 25th of June

to the 5th of July; by which successive calamities the city has been so much reduced, that its former consequence is never likely to be restored.

The ladies here wear the oriental dress, consisting of large trowsers or breeches, which reach to the ankle; long vests of rich silk or velvet, lined in winter with costly furs; and round their waist an embroidered zone with clasps of silver or gold. Their hair is plaited, and descends down the back often in great profusion. The girls have sometimes above twenty thick tresses, besides two or three encircling the head as a coronet, and set off with flowers and plumes of feathers, pearls, or other jewels. They commonly stain it of a chieftest colour, which is the most desired. Their apparel and carriage are alike antique. It is remarkable that the trowsers are mentioned in a fragment of Sappho as part of the female dress.

**SMYRNIUM, ALEXANDERS:** A genus of plants belonging to the class of *pentandria*, and to the order of *digynia*; and in the natural system ranging under the 45th order, *Umbellatae*. The fruit is oblong and striated; the petals have a sharp point, and are keel-shaped. There are five species: 1. The *perfoliatum*, or petiolate alexanders, which is a native of Candia and Italy; 2. The *Aegyptiacum*; 3. The *aureum*, or golden alexanders, which is a native of North America; 4. The *integerrimum*; 5. The *olusatrum*, common alexanders, a native of Britain; the leaves of which are cauline, ternate, petiolated, and ferrated. It grows on the sea-coast at Dunglas on the borders of Berwickshire North Britain. Since the introduction of celery into the garden, the alexanders is almost forgotten. It was formerly cultivated for salading, and the young shoots or stalks blanched were eaten either raw or stewed. The leaves too were boiled in broths and soups. It is a warm comfortable plant to a cold weak stomach, and was in much esteem among the monks, as may be inferred by its still being found in great plenty by old abbey walls.

**SNAPPLE**, in the manege, is a very slender bit-mouth without any branches, much used in England; the true bridles being reserved for war.

**SNAIL**, in zoology. See *HELIX* and *LIMAX*.

**SNAKE**, in zoology. See *ANGUIS* and *SERPENS*.

*Method of Preserving SNAKES.* When the snake is killed, it must first be washed clean, and freed from all filth and nastiness; then it is to be put into a glass of a proper size, the tail first, and afterwards the rest of the body, winding it in spiral ascending circles, and disposing the back, which is always the most beautiful, outwardly. A thread, connected with a small glass bead, is, by the help of a needle, to be passed through the upper jaw from within outwardly, and then through the cork of the bottle, where it must be fastened; by this means the head will be drawn into a natural posture, and the mouth kept open by the bead, whereby the teeth, &c. will be discovered: the glass is then to be filled with rum, and the cork sealed down to prevent its exhalation. A label, containing the name and properties of the snake, is then to be affixed to the wax over the cork; and in this manner the snake will make a beautiful appearance, and may be preserved a great number of years; nor will the spirits impair or change the luitre of its colours.

*Specific Gravity.*

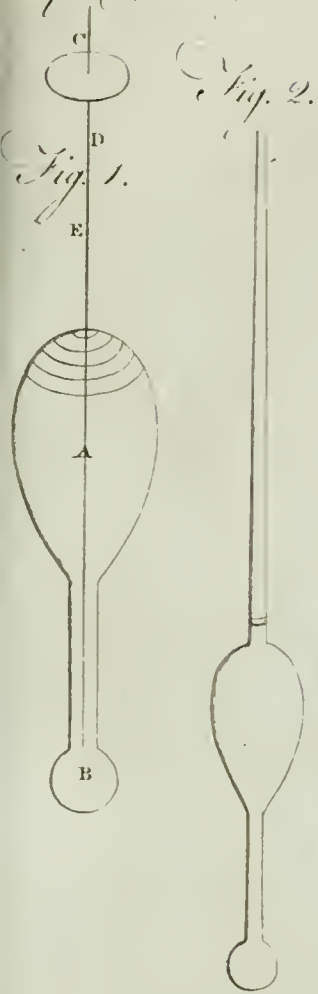

*Spirituous Liquors.* Plate CCCCLXXII.

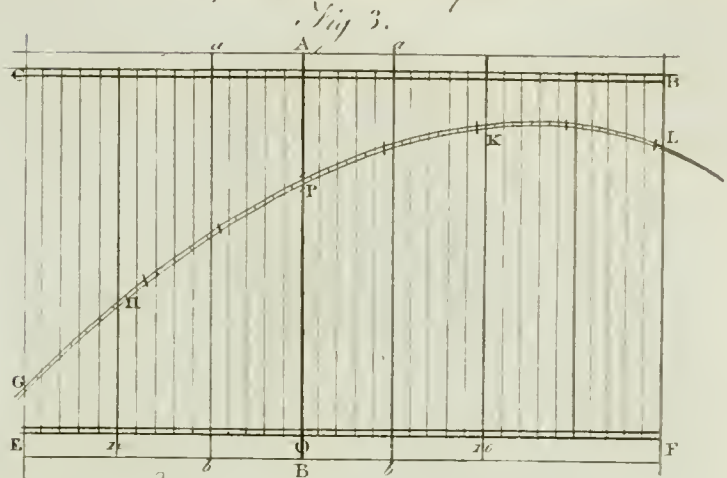

*Rocking Stone.*



*Fig. 4.*

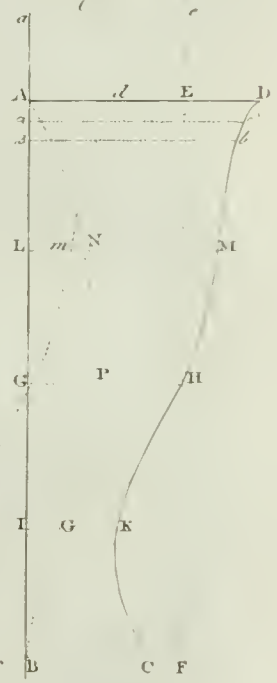

*Steam Kitchen.*

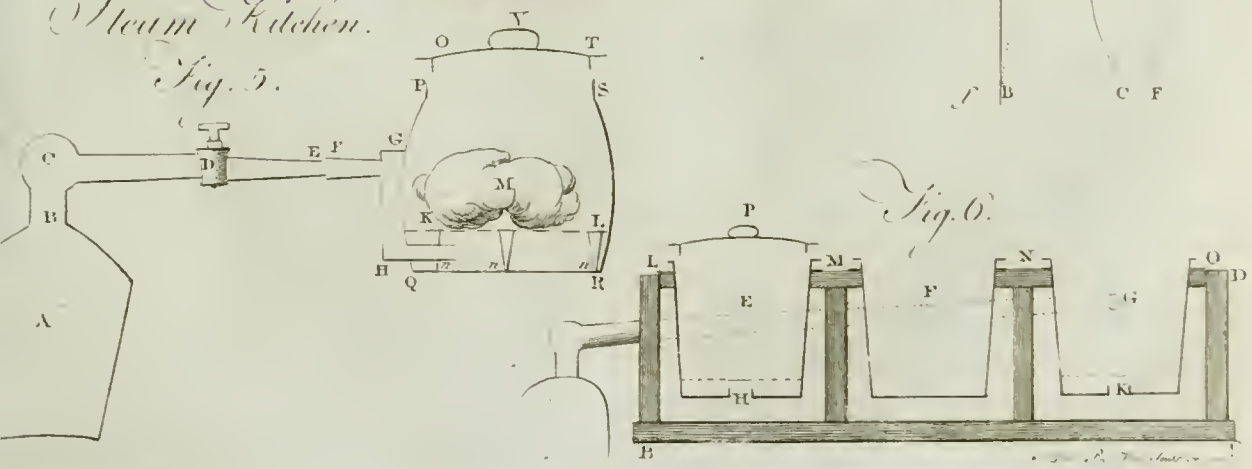



*Snake-Stones, Ammonite*, in natural history, the name of a large genus of fossil shells, very few of any of which are yet known in their recent state, or living either on our own or any other shores; so that it seems wonderful whence so vast a number and variety of them should be brought into our subterranean regions. They seem indeed dispersed in great plenty throughout the world, but nowhere are found in greater numbers, beauty, and variety, than in our island.

Mr Harenberg found prodigious numbers of them on the banks of a river in Germany. He traced this river through its several windings for many miles, and among a great variety of belemnites, cornua ammonis, and cochlites, of various kinds; he found also great quantities of wood of recent petrification, which still preserved plain marks of the axe by which it had been cut from the trees then growing on the shore. The water of this river he found in dry seasons, when its natural springs were not diluted with rains, to be considerably heavier than common water; and many experiments showed him that it contained ferruginous, as well as stony particles, in great quantity, whence the petrifications in it appeared the less wonderful, though many of them of recent date.

Of the cornua ammonis, or serpent stones, he there observed more than 30 different species. They lie immersed in a bluish fossil stone, of a soft texture and fatty appearance, in prodigious numbers, and of a great variety of sizes, from the larger known sorts down to such as could not be seen without very accurate inspection or the assistance of a microscope. Such as lie in the softest of these stones are soft like their matrix, and easily crumble to pieces; others are harder. In a piece of this stone, of the bigness of a finger, it is common to find 30 or more of these fossils; and often they are seen only in form of white specks, so minute that their figure cannot be distinguished till examined by the microscope.

They all consist of several voluta, which are different in number in the different species, and their striae also are extremely various; some very deep with very high ridges between them, others very slight; some straight, others crooked; others undulated, and some terminating in dots, tubercles, or cavities, towards the back, and others having tubercles in two or three places. They are all composed of a great number of chambers or cells, in the manner of the *nautilus Græcorum*, each having a communication with the others, by means of a pipe or siphunculus. There is a small white shell fish of Barbadoes, which seems truly a recent animal of this genus; and in the East Indies there is another also, small and greyish; but the large and beautifully marked ones are found only fossil.

They are composed of various fossil bodies, often of quarry stone, sometimes of the matter of the common pyrites, and of a great variety of other substances; and though they appear usually mere stones, yet in some the pearly part of the original shell is preserved in all its beauty. Sometimes also, while the outer substance is of the matter of the pyrites, or other coarse, stony, or mineral matter, the inner cavity is filled with a pure white spar of the common plated texture. This gives a great beauty to the specimen. The cornua ammonis, or snake-stones, are found in many parts of England, particularly in Yorkshire, where they are very plentiful in the alum rocks of several sizes.

Vol. XVII. Part II.

*Snake-Root*, in botany. See *POLYGALA*.

*Snake-Weed*, in botany. See *POLYGONUM*.

*SNAPEDRAGON*, in botany. See *ANTIRRHINUM*.

*SNEEZING*, a convulsive motion of the muscles of the breast, whereby the air is expelled from the nose with much vehemence and noise. It is caused by the irritation of the upper membrane of the nose, occasioned by acrid substances floating in the air, or by medicines called *sternutatory*.

This irritation is performed either externally, by strong smells, as marjoram, roses, &c. or by dust floating in the air, and taken in by inspiration; or by sharp pungent medicines, as creffes and other sternutatories, which vellicate the membrane of the nose; or internally, by the acrimony of the lymph or mucus, which naturally moistens that membrane. The matters cast forth in sneezing come primarily from the nose and throat; the pituitary membrane continually exuding a mucus thither; and, secondarily, from the breast, the trachea, and the bronchia of the lungs.

The practice of saluting the person who sneezed existed in Africa, among nations unknown to the Greeks and Romans. The accounts we have of Monomotapa inform us\*, that when the prince sneezes, all his subjects in the capital are advertised of it, that they may offer up prayers for his safety. The author of the conquest of Peru assures us, that the cacique of Guachoia having sneezed in presence of the Spaniards, the Indians of his train fell prostrate before him, stretched forth their hands, and displayed to him the accustomed marks of respect, while they invoked the sun to enlighten him, to defend him, and to be his constant guard.

Every body knows that the Romans saluted each other on these occasions: and Pliny relates†, that Libertus exacted these signs of homage when drawn in his chariot. Superstition, whose influence can debase every thing, had degraded this custom for several ages, by attaching favourable or unfavourable omens to sneezing according to the hour of the day or night, according to the signs of the zodiac, according as a work was more or less advanced, or according as one had sneezed to the right or to the left‡. If a man sneezed at rising from table or from his bed, it was necessary for him to sit or lie down again. You are struck with astonishment, said Timotheus to the Athenians, who wished to return into the harbour with their fleet§, because he had sneezed; you are struck with astonishment, because among 10,000 there is one man whose brain is moist.

Polydore Virgil pretends, that in the time of Gregory the Great, there reigned in Italy an epidemic distemper, which carried off by sneezing all those who were seized by it; and that this pontiff ordered prayers to be made against it, accompanied by certain signs of the cross. But besides that, there are very few cases in which sneezing can be considered as dangerous, and that it is frequently a favourable symptom ||: it is evident, that we ought not to date from the sixth century the origin of a custom which loses itself in the obscurity of antiquity. Avicenna and Cardan say, it is a sort of convulsion, which gives occasion to dread an epilepsy, and that this disease is endeavoured to be warded off by prayers. Clement of Alexandria considers it as a mark of intemperance and effeminacy, which ought to be proscribed. And he inveighs bitterly against those

*Snake-Root*  
||  
*Sneezing.*

\* *Strabo.*  
† *Prod. Adv.*

† *Plin. Hist. Nat. lib. ii. cap. 2.*

‡ *Sponf. Homers Comment.*

§ *Frontin. lib. i. cap. 11.*

|| *Hippocrat. Halleri Phys.*

*sneeze* *op.* who endeavour to procure sneezing by external aid. Montaigne, on the contrary, explains this fact in a tone rather cynical. It is singular enough, that so many ridiculous, contradictory, and superstitious opinions, have not abolished those customary civilities which are still preserved equally among high and low; and which only the Anabaptists and Quakers have rejected, because they have renounced salutations in every case.

\* *Piutarch*  
*de i. Socr.*  
*erat.*  
† *Aristonnet.*

Among the Greeks sneezing was almost always a good omen. It excited marks of tenderness, of respect, and attachment. The genius of Socrates informed him by sneezing, when it was necessary to perform any action\*. The young Parthenis, hurried on by her passion, resolved to write to Sarpedon an avowal of her love†: The sneezes in the most tender and impassioned part of her letter: This is sufficient for her; this incident supplies the place of an answer, and persuades her that Sarpedon is her lover. Penelope, harassed by the vexatious courtship of her suitors, begins to curse them all, and to pour forth vows for the return of Ulysses‡. Her son Telemachus interrupts her by a loud sneeze. She instantly exults with joy, and regards this sign as an assurance of the approaching return of her husband. Xenophon was haranguing his troops; a soldier sneezed in the moment when he was exhorting them to embrace a dangerous but necessary resolution. The whole army, moved by this preface, determine to pursue the project of their general; and Xenophon orders sacrifices to Jupiter the preserver§.

‡ *Hemeri*  
*Odyss.*  
*lib. xvii.*

§ *Xenoph.*  
*Anab.*

This religious reverence for sneezing, so ancient and so universal even in the times of Homer, always excited the curiosity of the Greek philosophers and of the rabbins. These last have spread a tradition, that, after the creation of the world, God made a general law to this purport, that every living man should sneeze but once in his life, and that at the same instant he should render up his soul into the hand of his Creator||, without any preceding indisposition. Jacob obtained an exemption from the common law, and the favour of being informed of his last hour: He sneezed and did not die; and this sign of death was changed into a sign of life. Notice of this was sent to all the princes of the earth; and they ordained, that in future sneezing should be accompanied with forms of blessing, and vows for the persons who sneezed.

|| *Acad. des*  
*Inscrip.*  
*vcl. iv.*

Aristotle remounts likewise to the sources of natural religion. He observes, that the brain is the origin of the nerves, of our sentiments, our sensations, the seat of the soul, the image of the Divinity¶; that upon all these accounts, the substance of the brain has ever been held in honour; that the first men swore by their head; that they durst not touch nor eat the brains of any animal; that it was even a sacred word which they dared not to pronounce. Filled with these ideas, it is not wonderful that they extended their reverence even to sneezing. Such is the opinion of the most ancient and sagacious philosophers of Greece.

¶ *Aristot.*  
*in Prob.*

According to mythology, the first sign of life Prometheus's artificial man gave was by sternutation. This supposed creator is said to have stolen a portion of the solar rays; and filling with them a phial, which he had made on purpose, sealed it up hermetically. He instantly flies back to his favourite automaton, and opening the phial holds it close to the statue; the rays still retaining all their activity, insinuate themselves through

the pores, and set the fastidious man a sneezing. Prometheus, transported with the success of his machine, offers up a fervent prayer, with wishes for the preservation of so singular a being. His automaton observed him, remembering his ejaculations, was very careful, on the like occasions, to offer these wishes in behalf of his descendants, who perpetuated it from father to son in all their colonies.

*Sneyt*  
*ll*  
*Scorin*

SNIGGLING, a method of fishing for eels, chiefly used in the day-time, when they are found to hide themselves near weirs, mills, or flood-gates. It is performed thus: Take a strong line and hook, baited with a garden-worm, and observing the holes where the eels lie hid, thrust your bait into them by the help of a stick; and if there be any, you shall be sure to have a bite; and may, if your tackling hold, get the largest eels.

SNIP'E, in ornithology. See SCOLOPAX and SHOOTING.

SNORING, in medicine, otherwise called *stertor*, is a sound like that of the cochon, but greater and more manifest.

Many confound those affections, and make them to differ only in place and magnitude, calling by the name of *stertor* that sound or noise which is heard or supposed to be made in the passage between the palate and the nostrils as in those who sleep; that boiling or bubbling noise, which in respiration proceeds from the larynx, or or head, or orifice of the aspera arteria, they call *ce chon*; but if the sound comes from the aspera arteria itself, they will have it called *cerchnos*, that is, as some understand it, a rattling, or as others a stridulous or wheezing roughness of the aspera arteria. In dying persons this affection is called by the Greeks *πυχρος ρηενχος*, which is a snoring or rattling kind of noise, proceeding as it were from a conflict between the breath and the humours in the aspera arteria.

This and such like affections are owing to a weakness of nature, as when the lungs are full of pus or humours: to which purpose we read in the Prognostics of Hippocrates, "it is a bad sign when there is no expectoration, and no discharge from the lungs, but a noise as from an ebullition is heard in the aspera arteria from a plenitude of humour." Expectoration is suppressed either by the viscidness of the humour, which requires to be discharged, and which adhering to the aspera arteria, and being there agitated by the breath, excites that bubbling noise or *stertor*; or by an obstruction of the bronchia; or, lastly, by a compression of the aspera arteria and throat, whence the passage is straitened, in which the humours being agitated, excite such a kind of noise as before described. Hence Galen calls those who are strait-breasted *stertorosis*. That author assigns but two causes of this symptom, which are either the straitness of the passage of respiration or redundancy of humours, or both together; but it is necessary to add a third, to wit, the weakness of the faculty, which is the cause of the rhenchos in dying persons, where nature is too weak to make discharges.

From what has been said we conclude, that this symptom, or this sort of fervour or ebullition in the throat, is not always mortal, but only when nature is oppressed with the redundancy of humour, in such a manner, that the lungs cannot discharge themselves by spitting; or the passage appointed for the breath (being the aspera arteria) is very much obstructed, upon which

account

Snow. account many dying persons labour under a stertor with their mouths gaping.

SNOW, a well-known meteor, formed by the freezing of the vapours in the atmosphere. It differs from hail and hoar-frost, in being as it were crystallized, which they are not. This appears on examining a flake of snow by a magnifying glass; when the whole of it will appear to be composed of fine shining spicula diverging like rays from a centre. As the flakes fall down through the atmosphere, they are continually joined by more of these radiated spicula, and thus increase in bulk like the drops of rain or hailstones. Dr Grew, in a discourse of the nature of snow, observes, that many parts thereof are of a regular figure, for the most part stars of six points, and are as perfect and transparent ice as any we see on a pond, &c. Upon each of these points are other collateral points, set at the same angles as the main points themselves: among which there are divers other irregular, which are chiefly broken points, and fragments of the regular ones. Others also, by various winds, seem to have been thawed and frozen again into irregular clusters; so that it seems as if the whole body of snow were an infinite mass of icicles irregularly figured. That is, a cloud of vapours being gathered into drops, the said drops forthwith descend; upon which descent, meeting with a freezing air as they pass through a colder region, each drop is immediately frozen into an icicle, shooting itself forth into several points; but these still continuing their descent, and meeting with some intermitting gales of warmer air, or in their continual wastage to and fro touching upon each other, some of them are a little thawed, blunted, and again frozen into clusters, or intangled so as to fall down in what we call *flakes*.

The lightness of snow, although it is firm ice, is owing to the excess of its surface, in comparison to the matter contained under it; as gold itself may be extended in surface till it will ride upon the least breath of air.

The whiteness of snow is owing to the small particles into which it is divided; for ice, when pounded, will become equally white. An artificial snow has been made by the following experiment. A tall phial of aquafortis being placed by the fire till it is warm, and filings of pure silver, a few at a time, being put into it; after a brisk ebullition, the silver will dissolve slowly. The phial being then placed in a cold window, as it cools the silver particles will shoot into crystals, several of which running together will form a flake of snow, which will descend to the bottom of the phial. While they are descending, they represent perfectly a shower of silver snow, and the flakes will lie upon one another at the bottom like real snow upon the ground.

According to Signior Beccaria, clouds of snow differ in nothing from clouds of rain, but in the circumstance of cold that freezes them. Both the regular diffusion

of the snow, and the regularity of the structure of its parts (particularly some figures of snow or hail which fall about Turin, and which he calls *rosette*), show that clouds of snow are acted upon by some uniform cause like electricity; and he endeavours to show how electricity is capable of forming these figures. He was confirmed in his conjectures by observing, that his apparatus for observing the electricity of the atmosphere never failed to be electrified by snow as well as rain. Professor Winthrop sometimes found his apparatus electrified by snow when driven about by the wind, though it had not been affected by it when the snow itself was falling. A more intense electricity, according to Beccaria, unites the particles of hail more closely than the more moderate electricity does those of snow, in the same manner as we see that the drops of rain which fall from thunder-clouds are larger than those which fall from others, though the former descend through a less space.

But we are not to consider snow merely as a curious and beautiful phenomenon. The Great Dispenser of universal bounty has so ordered it, that it is eminently subservient, as well as all the works of creation, to his benevolent designs. Were we to judge from appearances only, we might imagine, that so far from being useful to the earth, the cold humidity of snow would be detrimental to vegetation. But the experience of all ages asserts the contrary. Snow, particularly in those northern regions where the ground is covered with it for several months, fructifies the earth, by guarding the corn or other vegetables from the intense cold of the air, and especially from the cold piercing winds. It has been a vulgar opinion, very generally received, that snow fertilizes the lands on which it falls more than rain, in consequence of the nitrous salts which it is supposed to acquire by freezing. But it appears from the experiments of Margraaf (A) in the year 1751, that the chemical difference between rain and snow-water is exceedingly small; that the latter is somewhat less nitrous, and contains a somewhat less proportion of earth than the former; but neither of them contain either earth or any kind of salt in any quantity which can be sensibly efficacious in promoting vegetation. Allowing, therefore, that nitre is a fertilizer of lands, which many are upon good grounds disposed utterly to deny, yet so very small is the quantity of it contained in snow, that it cannot be supposed to promote the vegetation of plants upon which the snow has fallen. The peculiar agency of snow, as a fertilizer in preference to rain, may admit of a very rational explanation, without recurring to nitrous salts supposed to be contained in it. It may be rationally ascribed to its furnishing a covering to the roots of vegetables, by which they are guarded from the influence of the atmospherical cold, and the internal heat of the earth is prevented from escaping.

The internal parts of the earth, by some principle

3 B 2

which

(A) Margraaf collected of the purest snow he could find as much as when melted afforded 100 measures of water, each measure containing 36 ounces. By distilling this quantity he obtained 60 grains, not of nitre, but of *calcareous earth*, with some grains of the acid of sea-salt, impregnated with a nitrous vapour. The same quantity of rain-water collected in the winter months with equal attention, when distilled yielded 100 grains of calcareous earth with some grains of the acid of nitre and sea-salt. The chemical difference therefore between rain and snow is very small.

Snow.

which we do not understand, is heated uniformly to the 48th degree of Fahrenheit's thermometer. This degree of heat is greater than that in which the watery juices of vegetables freeze, and it is propagated from the inward parts of the earth to the surface, on which the vegetables grow. The atmosphere being variably heated by the action of the sun in different climates, and in the same climate at different seasons, communicates to the surface of the earth and to some distance below it the degree of heat or cold which prevails in itself. Different vegetables are able to preserve life under different degrees of cold, but all of them perish when the cold which reaches their roots is extreme. Providence has therefore, in the coldest climates, provided a covering of snow for the roots of vegetables, by which they are protected from the influence of the atmospherical cold. The snow keeps in the internal heat of the earth, which surrounds the roots of vegetables, and defends them from the cold of the atmosphere.

Snow or ice water is always deprived of its fixed air, which escapes during the process of congelation. Accordingly, as some of the inhabitants of the Alps who use it for their constant drink have enormous wens upon their throats, it has been ascribed to this circumstance. If this were the cause of these wens, it would be easy to remove it by exposing the snow-water to the air for some time. But several eminent physicians have rejected the notion that snow-water is the cause of these wens; for in Greenland, where snow-water is commonly used, the inhabitants are not affected with such swellings: on the other hand, they are common in Sumatra where snow is never seen.

Snow, in sea-affairs, is generally the largest of all two-masted vessels employed by Europeans, and the most convenient for navigation.

The sails and rigging on the mainmast and foremast of a snow are exactly similar to those on the same masts in a ship; only that there is a small mast behind the mainmast of the former, which carries a sail nearly resembling the mizen of a ship. The foot of this mast is fixed on a block of wood on the quarter-deck abaft the mainmast; and the head of it is attached to the after-top of the maintop. The sail which is called the *try-sail* is extended from its mast towards the stern of the vessel.

When the sloops of war are rigged as snows, they are furnished with a horse, which answers the purpose of the try-sail-mast, the fore-part of the sail being attached by rings to the said horse, in different places of its height.

*Snow-Grotto*, an excavation made by the waters on the side of Mount Etna, by making their way under the layers of lava, and by carrying away the bed of pozzolana below them. It occurred to the proprietor, that this place was very suitable for a magazine of snow: for in Sicily, at Naples, and particularly at Malta, they are obliged for want of ice to make use of snow for cooling their wine, sheibet, and other liquors, and for making sweetmeats.

This grotto was hired or bought by the knights of Malta, who having neither ice nor snow on the burning rock which they inhabit, have hired several caverns on Etna, into which people whom they employ collect and preserve quantities of snow to be sent to Malta when needed. This grotto has therefore been repaired with-

in at the expense of that order; flights of steps are cut into it, as well as two openings from above, by which they throw in the snow, and through which the grotto is enlightened. Above the grotto they have also levelled a piece of ground of considerable extent: this they have inclosed with thick and lofty walls, so that when the winds, which at this elevation blow with great violence, carry the snow from the higher parts of the mountain, and deposit it in this inclosure, it is retained and amassed by the walls. The people then remove it into the grotto through the two openings; and it is there laid up, and preserved in such a manner as to resist the force of the summer heats; as the layers of lava with which the grotto is arched above prevent them from making any impression.

When the season for exporting the snow comes on, it is put into large bags, into which it is pressed as closely as possible; it is then carried by men out of the grotto, and laid upon mules, which convey it to the shore, where small vessels are waiting to carry it away.

But before those lumps of snow are put into bags, they are wrapped in fresh leaves; so that while they are conveyed from the grotto to the shore, the leaves may prevent the rays of the sun from making any impression upon them.

The Sicilians carry on a considerable trade in snow, which affords employment to some thousands of mules, horses, and men. They have magazines of it on the summits of their loftiest mountains, from which they distribute it through all their cities, towns, and houses; for every person in the island makes use of snow. They consider the practice of cooling their liquors as absolutely necessary for the preservation of health; and in a climate the heat of which is constantly relaxing the fibres, cooling liquors, by communicating a proper tone to the fibres of the stomach, must greatly strengthen them for the performance of their functions.

In this climate a scarcity of snow is no less dreaded than a scarcity of corn, wine, or oil. We are informed by a gentleman who was at Syracuse in the year 1777, when there was a scarcity of snow, the people of the town learned that a small vessel loaded with that article was passing the coast: without a moment's deliberation they ran in a body to the shore and demanded her cargo; which when the crew refused to deliver up, the Syracusans attacked and took, though with the loss of several men.

*Snow-Drop*, in botany. See *CHIONANTHUS*.

*SNOWDON-HILL*, the name of a mountain in Caernarvonshire in Wales, generally thought to be the highest in Britain; though some have been of opinion that its height is equalled, or even exceeded, by mountains in the Highlands of Scotland. The mountain is surrounded by many others, called in the Welsh language *Crib Coch*, *Crib y Ddysill*, *Lhweddy yr Arran*, &c.

According to Mr Pennant\*, this mountainous tract yields scarcely any corn. Its produce is cattle and sheep; which, during summer, keep very high in the mountains, followed by their owners with their families, who reside during that season in *harvodys*, or "summer dairy-houses," as the farmers in the Swiss Alps do in their *fennes*. These houses consist of a long low room, with a hole at one end to let out the smoke from the fire which is made beneath. Their furniture is very simple; stones are substituted for stools, and their beds are of  
lay,

Snow,  
Snowdon-  
Hill.\* *Journey*  
to *Snowdon*.



*Snowdon-Hill.* hay, ranged along the sides. They manufacture their own clothes, and dye them with the *lichen amphaloides* and *lichen parietinus*, mosses collected from the rocks. During summer the men pass their time in tending their herds or in making hay, &c. and the women in milking or in making butter and cheese. For their own use they milk both ewes and goats, and make cheese of the milk. Their diet consists of milk, cheese, and butter: and their ordinary drink is whey; though they have, by way of reserve, a few bottles of very strong beer, which they use as a cordial when sick. They are people of good understanding, wary, and circumspect; tall, thin, and of strong constitutions. In the winter-time they descend into the *ben-dref*, or "old dwelling," where they pass their time in inactivity.

The view from the highest peak of Snowdon is very extensive. From it Mr Pennant saw the county of Chester, the high hills of Yorkshire, part of the north of England, Scotland, and Ireland; a plain view of the isle of Man; and that of Anglesea appeared like a map extended under his feet, with every rivulet visible. Our author took much pains to have this view to advantage; sat up at a farm on the west till about 12, and walked up the whole way. The night was remarkably fine and starry; towards morning the stars faded away, leaving an interval of darkness, which, however, was soon dispelled by the dawn of day. The body of the sun appeared most distinct, with the roundness of the moon, before it appeared too brilliant to be looked at. The sea, which bounded the western part of the prospect, appeared gilt with the sun-beams, first in slender streaks, and at length glowed with redness. The prospect was disclosed like the gradual drawing up of a curtain in a theatre; till at last the heat became sufficiently strong to raise mists from the various lakes, which in a slight degree obscured the prospect. The shadow of the mountain extended many miles, and showed its truncated form; the Wyddfa making one head, and Crib y Distill the other. At this time he counted between 20 and 30 lakes either in Caernarvon or in Merionethshire. In making another visit, the sky was obscured very soon after he got up. A vast mist involved the whole circuit of the mountain, and the prospect down was horrible. It gave an idea of numbers of abysses, concealed by a thick smoke furiously circulating around them. Very often a gust of wind made an opening in the clouds, which gave a fine and distinct vista of lake and valley. Sometimes they opened in one place, at others in many at once; exhibiting a most strange and perplexing figure of water, fields, rocks, and chafms. They then closed again, and every thing was involved in darkness; in a few minutes they would separate again, and repeat the above-mentioned scene with infinite variety. From this prospect our traveller descended with great reluctance; but before he had reached the place where his horses were left, he was overtaken by a thunder storm. The rolling of the thunder-claps, being reiterated by the mountains, was inexpressibly awful; and after he had mounted, he was in great danger of being swept away by the torrents which poured down in consequence of a very heavy rain.

It is very rare (Mr Pennant observes) that the traveller gets a proper day to ascend this hill: it indeed often appears clear; but by the evident attraction of the

clouds by this lofty mountain, it becomes suddenly and unexpectedly enveloped in mist, when the clouds have just before appeared very high and very remote. At times he observed them lower to half their height; and notwithstanding they have been dispersed to the right and left, yet they have met from both sides, and united to involve the summit in one great obscurity.

The height of Snowdon was measured, in 1682, by Mr Caswell, with instruments made by Flamsteed: according to his mensuration, the height is 3720 feet; but more modern computations make it only 3568, reckoning from the quay at Caernarvon to the highest peak. The stone that composes this mountain is excessively hard. Large coarse crystals, and frequently cubic pyrites, are found in the fissures. An immense quantity of water rushes down the sides of Snowdon and the neighbouring mountains, inasmuch that Mr Pennant supposes, if collected into one stream, they would exceed the waters of the Thames.

SNUFF, a powder chiefly made of tobacco, the use of which is too well known to need any description here.

Tobacco is usually the basis of snuff; other matters being only added to give it a more agreeable scent, &c. The kinds of snuff, and their several names, are infinite, and new ones are daily invented; so that it would be difficult, not to say impossible, to give a detail of them. We shall only say, that there are three principal sorts: the first granulated; the second an impalpable powder; and the third the bran, or coarse part remaining after sifting the second sort.

"Every professed, inveterate, and incurable snuff-taker (says Lord Stanhope), at a moderate computation, takes one pinch in ten minutes. Every pinch, with the agreeable ceremony of blowing and wiping the nose and other incidental circumstances, consumes a minute and a half. One minute and a half out of every ten, allowing 16 hours to a snuff-taking day, amounts to two hours and 24 minutes out of every natural day, or one day out of every ten. One day out of every 10 amounts to 36 days and a half in a year. Hence if we suppose the practice to be persisted in 40 years, two entire years of the snuff-taker's life will be dedicated to tickling his nose, and two more to blowing it. The expence of snuff, snuff-boxes, and handkerchiefs, will be the subject of a second essay; in which it will appear, that this luxury encroaches as much on the income of the snuff-taker as it does on his time; and that by a proper application of the time and money thus lost to the public, a fund might be constituted for the discharge of the national debt." See NICOTIANA.

SNYDERS (Francis), a Flemish painter, born at Antwerp in 1579, and bred under his countryman Henry Van Balen. His genius first displayed itself in painting fruit: he afterwards attempted animals, huntings, &c. in which he exceeded all his predecessors. He also painted kitchens, &c. and gave dignity to subjects that seemed incapable of it. He was made painter to Ferdinand and Isabella, archduke and duchess, and became attached to the house of the cardinal infant of Spain. The king of Spain and the elector Palatine adorned their palaces with huntings by this artist. Rubens, Jordaens, and Snyders, used to co-operate in the enriching of each other's pictures according to their several

*Snuff, Snyders.*

Soal. flit. several talents; and thus they became more valuable than if finished by either of them singly. Snyder died in 1657.

SOAL-FISH, in ichthyology. See PLEURONECTES.

SOAP, a composition of caustic, fixed alkaline salt, and oil, sometimes hard and dry, sometimes soft and liquid; much used in washing, whitening linens, and by dyers and fullers.—Soap may be made by several methods, which, however, all depend upon the same principle. The soap which is used in medicine is made without heat. See CHEMISTRY, n° 1026.

In manufactures where large quantities of it are prepared, soap is made with heat. A lixivium of quicklime and soda is made, but is less concentrated than that above referred to, and only so much that it can sustain a fresh egg. A part of this lixivium is to be even diluted and mixed with an equal weight of oil of olives. The mixture is to be put on a gentle fire, and agitated, that the union may be accelerated. When the mixture begins to unite well, the rest of the lixivium is to be added to it; and the whole is to be digested with a very gentle heat, till the soap be completely made. A trial is to be made of it, to examine whether the just proportion of oil and alkali has been observed. Good soap of this kind ought to be firm, and very white when cold; not subject to become moist by exposure to air, and entirely miscible with pure water, to which it communicates a milky appearance, but without any drops of oil floating on the surface. When the soap has not these qualities, the combination has not been well made, or the quantity of salt or of oil is too great, which faults must be corrected.

In soft or liquid soaps, green or black soaps, cheaper oils are employed, as oil of nuts, of hemp, of fish, &c. These soaps, excepting in consistence, are not essentially different from white soap.

Fixed alkalis are much disposed to unite with oils that are not volatile, both vegetable and animal, since this union can be made even without heat. The compound resulting from this union partakes at the same time of the properties of oil and of alkali; but these properties are modified and tempered by each other, according to the general rule of combinations. Alkali formed into soap has not nearly the same acrimony as when it is pure; it is even deprived of almost all its causticity, and its other saline alkaline properties are almost entirely abolished. The same oil contained in soap is less combustible than when pure, from its union with the alkali, which is an unflammable body. It is miscible, or even soluble, in water, to a certain degree, by means of the alkali. Soap is entirely soluble in spirit of wine; and still better in aquavitæ sharpened by a little alkaline salt, according to an observation of Mr Geoffroy.

The manufacture of soap in London first began in the year 1524; before which time this city was served with white soap from foreign countries, and with grey soap speckled with white from Bristol, which was sold for a penny a pound; and also with black soap, which sold for a halfpenny the pound.

The principal soaps of our own manufacture are the soft, the hard, and the ball soap. The soft soap is either white or green. The process of making each of these shall now be described.

*Green soft soap.* The chief ingredients used in making this are lees drawn from pot-ash and lime, boiled up with tallow and oil. First, the ley of a proper degree of strength (which must be estimated by the weight of the liquor), and tallow, are put into the copper together, and as soon as they boil up the oil is added; the fire is then damped or stopped up, while the ingredients remain in the copper to unite; when they are united, the copper is again made to boil, being fed or filled with lees as it boils, till there be a sufficient quantity put into it; then it is boiled off and put into casks. When this soap is first made it appears uniform; but in about a week's time the tallow separates from the oil into those white grains which we see in common soap. Soap thus made would appear yellow, but by a mixture of indigo added at the end of the boiling, it is rendered green, that being the colour which results from the mixture of yellow and blue.

*White soap.* Of this one sort is made after the same manner as green soft soap, oil alone excepted, which is not used in white. The other sort of white soft soap is made from the lees of ashes of lime boiled up two different times with tallow. First, a quantity of lees and tallow are put into the copper together, and kept boiling, being fed with lees as they boil, until the whole is boiled sufficiently; then the lees are separated or discharged from the tallow part, which part is removed into a tub, and the lees are thrown away; this is called the *first half-boil*: then the copper is filled again with fresh tallow and lees, and the first half-boil is put out of the tub into the copper a second time, where it is kept boiling with fresh lees and tallow till the soap is produced. It is then put out of the copper into the same sort of casks as are used for green soft soap. The common soft soap used about London, generally of a greenish hue, with some white lumps, is prepared chiefly with tallow: a blackish sort, more common in some other places, is said to be made with whale oil.

*Hard soap* is made with lees from ashes and tallow, and is most commonly boiled twice: the first, called the *half-boil*, hath the same operation as the first half-boil of soft white soap. Then the copper is charged with fresh lees again, and the first half boil put into it, where it is kept boiling, and fed with lees as it boils, till it grains or is boiled enough; then the ley is discharged from it, and the soap put into a frame to cool and harden. Common salt is made use of for the purpose of graining the soap; for when the oil or tallow has been united with the ley, after a little boiling, a quantity of salt is thrown into the mass, which dissolving readily in water, but not in the oil or tallow, draws out the water in a considerable degree, so that the oil or tallow united with the salt of the ley swims on the top. When the ley is of a proper strength, less salt is necessary to raise the curd than when it is too weak. It must be observed, that there is no certain time for bringing off a boiling of any of these sorts of soap: it frequently takes up part of two days.

*Ball soap*, commonly used in the north, is made with lees from ashes and tallow. The lees are put into the copper, and boiled till the watery part is quite gone, and there remains nothing in the copper but a sort of saline matter (the very strength or essence of the ley); to this the tallow is put, and the copper is kept boiling and stirring for above half an hour, in which time

the

Soap. the soap is made; and then it is put out of the copper into tubs or baskets with sheets in them, and immediately (whilst soft) made into balls. It requires near 24 hours in this process to boil away the watery part of the ley.

When oil unites with alkali in the formation of soap, it is little altered in the connection of its principles; for it may be separated from the alkali by decomposing soap with any acid, and may be obtained nearly in its original state.

Concerning the decomposition of soap by means of acids, we must observe, first, that all acids, even the weakest vegetable acids, may occasion this decomposition, because every one of them has a greater affinity than oil with fixed alkali. Secondly, these acids, even when united with any basis, excepting fixed alkali, are capable of occasioning the same decomposition; whence all ammoniacal salts, all salts with basis of earth, and all those with metallic bases, are capable of decomposing soap, in the same manner as disengaged acids are; with this difference, that the oil separated from the fixed alkali, by the acid of these salts, may unite more or less intimately with the substance which was the basis of the neutral salt employed for the decomposition.

Soap may also be decomposed by distillation, as Lermery has done. When first exposed to fire, it yields a phlegm called by him a *spiritu*; which nevertheless is neither acid nor alkaline, but some water which enters into the composition of soap. It becomes more and more coloured and empyreumatic as the fire is increased, which shows that it contains the most subtle part of the oil. It seems even to raise along with it, by help of the oil and action of the fire, a small part of the alkali of the soap: for, as the same chemist observes, it occasions a precipitate in a solution of corrosive sublimate. After this phlegm the oil rises altered, precisely as if it had been distilled from quicklime, that is, empyreumatic, soluble in spirit of wine, at first sufficiently subtle and afterwards thicker. An alkaline residuous coal remains in the retort, consisting chiefly of the mineral alkali contained in the soap, and which may be disengaged from the coal by calcination in an open fire, and obtained in its pure state.

Alkaline soaps are very useful in many arts and trades, and also in chemistry and medicine. Their principal utility consists in a detergent quality that they receive from their alkali, which, although it is in some measure saturated with oil, is yet capable of acting upon oily matters, and of rendering them saponaceous and miscible with water. Hence soap is very useful to cleanse any substances from all fat matters with which they happen to be soiled. Soap is therefore daily used for the washing and whitening of linen, for the cleansing of woollen cloths from oil, and for whitening silk and freeing it from the resinous varnish with which it is naturally covered. Pure alkaline lixiviums being capable of dissolving oils more effectually than soap, might be employed for the same purposes; but when this activity is not mitigated by oil, as it is in soap, they are capable of altering, and even of destroying entirely by their causticity, most substances, especially animal matters, as silk, wool, and others: whereas soap cleanses from oil almost as effectually as pure alkali, without danger of altering or destroying; which renders it very useful.

Soap was imperfectly known to the ancients. It is

mentioned by Pliny as made of fat and ashes, and as an invention of the Gauls. Aretæus and others inform us, that the Greeks obtained their knowledge of its medicinal use from the Romans. Its virtues, according to Bergius, are detergent, resolvent, and aperient, and its use recommended in jaundice, calculous complaints, and in obstructions of the viscera. The efficacy of soap in the first of these diseases was experienced by Syllius, and since recommended very generally by various authors who have written on this complaint; and it has also been thought of use in supplying the place of bile in the primæ viæ. The utility of this medicine in icterical cases was inferred chiefly from its supposed power of dissolving biliary concretions; but this medicine has lost much of its reputation in jaundice, since it is now known that gall stones have been found in many after death who had been daily taking soap for several months and even years. Of its good effects in urinary calculous affections, we have the testimony of several, especially when dissolved in lime-water, by which its efficacy is considerably increased; for it thus becomes a powerful solvent of mucus, which an ingenious modern author supposes to be the chief agent in the formation of calculi: it is, however, only in the incipient state of the disease that these remedies promise effectual benefit; though they generally abate the more violent symptoms where they cannot remove the cause. With Boerhaave soap was a general medicine: for as he attributed most complaints to viscosity of the fluids, he, and most of the Boerhaavian school, prescribed it in conjunction with different resinous and other substances, in gout, rheumatism, and various visceral complaints. Soap is also externally employed as a resolvent, and gives name to several officinal preparations.

From the properties of soap we may know that it must be a very effectual and convenient anti-acid. It absorbs acids as powerfully as pure alkalis and absorbent earths, without having the causticity of the former, and without oppressing the stomach by its weight like the latter.

Lastly, we may perceive that soap must be one of the best of all antidotes to stop quickly, and with the least inconvenience, the bad effects of acid corrosive poisons, as aquafortis, corrosive sublimate, &c.

Soap imported is subject by 10 Ann. cap. 19. to a duty of 2d. a pound (over and above former duties); and by 12 Ann. stat. 2. cap. 9. to the farther sum of 1d. a pound. And by the same acts, the duty on soap made in the kingdom is 1½d. a pound. By 17 G. III. cap. 52. no person within the limits of the head office of excise in London shall be permitted to make any soap unless he occupy a tenement of 10l. a year, be assessed, and pay the parish rates; or elsewhere, unless he be assessed, and pay to church and poor. Places of making are to be entered on pain of 50l. and covers and locks to be provided under a forfeiture of 100l.; the furnace-door of every utensil used in the manufacture of soap shall be locked by the excise officer, as soon as the fire is damped or drawn out, and fastenings provided, under the penalty of 50l.; and opening or damaging such fastening incurs a penalty of 100l. Officers are required to enter and survey at all times, by day or night, and the penalty of obstructing is 20l. and they may unlock and examine every copper, &c. between the hours of five in the morning and ele-

Soap  
||  
Socage.

ven in the evening, and the penalty of obstructing is 100l. Every maker of soap before he begins any making, it within the bills of mortality, shall give 12 hours, if elsewhere 24 hours, notice in writing to the officer, of the time when he intends to begin, on pain of 50l. No maker shall remove any soap unsurveyed on pain of 20l. without giving proper notice of his intention. And if any maker shall conceal any soap or materials, he shall forfeit the same, and also 500l. Every barrel of soap shall contain 256 lb. avoirdupois, half barrel 128 lb. firkin 64lb. half-firkin 32lb. besides the weight or tare of each cask: and all soap, excepting hard cake soap and ball soap, shall be put into such casks and no other, on pain of forfeiture, and 5l. The maker shall weekly enter in writing at the next office the soap made by him in each week, with the weight and quantity at each boiling, on pain of 50l; and within one week after entry clear off the duties, on pain of double duty. See, besides the statutes above cited, 5 Geo. III. cap. 43. 12 Geo. III. cap. 46. 11 Geo. cap. 30. 1 Geo. stat. 2. cap. 36.

*Starkey's Soap.* See CHEMISTRY, n<sup>o</sup> 1027.

*Acid Soap.* This is formed by the addition of concentrated acids to the expressed oils. Thus the oil is rendered partially soluble in water; but the union is not sufficiently complete to answer any valuable purpose.

*Soap-Berry Tree.* See SAPINDUS.

*Soap-Earth.* See STEATITES.

SOAPWORT. See SAPONARIA.

SOC (Sax.), signifies power or liberty to minister justice or execute laws; also the circuit or territory wherein such power is exercised. Whence our law-Latin word *focca* is used for a feignory or lordship enfranchised by the king, with the liberty of holding or keeping a court of his *sockmen*: And this kind of liberty continues in divers parts of England to this day, and is known by the names of *sole* and *sofen*.

SOCAGE, in its most general and extensive signification, seems to denote a tenure by any certain and determinate service. And in this sense it is by our ancient writers constantly put in opposition to chivalry or knight-service, where the render was precarious and uncertain. The service must therefore be certain, in order to denominate it socage; as to hold by fealty and 20s. rent; or, by homage, fealty, and 20s. rent; or, by homage and fealty without rent; or, by fealty and certain corporal service, as ploughing the lord's land for three days; or, by fealty only without any other service: for all these are tenures in socage.

Socage is of two sorts: *free-socage*, where the services are not only certain but honourable; and *villain-socage*, where the services, though certain, are of a baser nature (see *VILLENAGE*). Such as hold by the former tenure are called, in Glanvil and other subsequent authors, by the name of *liberi sokemanni*, or tenants in free-socage. The word is derived from the Saxon appellation *soe*, which signifies liberty or privilege; and, being joined to an usual termination, is called *socage*, in Latin *sociagium*; signifying thereby a free or privileged tenure.

It seems probable that the socage-tenures were the relics of Saxon liberty; retained by such persons as had neither forfeited them to the king, nor been obliged to exchange their tenure for the more honourable, as it was called, but at the same time more burthensome, ten-

nure of knight-service. This is peculiarly remarkable in the tenure which prevails in Kent, called *gavelkind*, which is generally acknowledged to be a species of socage-tenure; the preservation whereof inviolate from the innovations of the Norman conqueror is a fact universally known. And those who thus preserved their liberties were said to hold in free and common socage.

As therefore the grand criterion and distinguishing mark of this species of tenure are the having its renders or services ascertained, it will include under it all other methods of holding free lands by certain and invariable rents and duties; and in particular, *Peiu SERVITANTU*, *Tenure in Burgage*, and *GAVELKIND*. See these articles.

SOCIETY, a number of rational and moral beings, united for their common preservation and happiness.

There are shoals of fishes, herds of quadrupeds, and flocks of birds. But till observation enable us to determine with greater certainty, how far the inferior animals are able to look through a series of means to the end which these are calculated to produce, how far their conduct may be influenced by the hope of reward and the fear of punishment, and whether they are at all capable of moral distinctions—we cannot with propriety apply to them the term *Society*. We call crows, and heavers, and several other species of animals, *gregarious*; but it is hardly good English to say that they are *social*.

It is only human society, then, that can become the subject of our present investigation. The phenomena which it presents are highly worthy of our notice.

Such are the advantages which each individual evidently derives from living in a social state; and so helpless does any human being appear in a solitary state, that we are naturally led to conclude, that if there ever was a period at which mankind were solitary beings, that period could not be of long duration; for their aversion to solitude and love of society would soon induce them to enter into social union. Such is the opinion which we are led to conceive, when we compare our own condition as members of civilized and enlightened society with that of the brutes around us, or with that of savages in the earlier and ruder periods of social life. When we hear of Indians wandering naked through the woods, destitute of arts, unskilled in agriculture, scarce capable of moral distinctions, void of all religious sentiments, or possessed with the most absurd notions concerning superior powers, and procuring means of subsistence in a manner equally precarious with that of the beasts of prey—we look down with pity on their condition, or turn from it with horror. When we view the order of cultivated society, and consider our institutions, arts, and manners—we rejoice over our superior wisdom and happiness.

Man in a civilized state appears a being of a superior order to man in a savage state; yet some philosophers tell us, that it is only he who, having been educated in society, has been taught to depend upon others, that can be helpless or miserable when placed in a solitary state. They view the savage who exerts himself with intrepidity to supply his wants, or bears them with fortitude, as the greatest hero, and possessing the greatest happiness. And therefore if we agree with them, that the propensities of nature may have prompted men to

Society.

Definition

How far  
brutes are  
capable of  
a social  
state.

Mankind  
the only  
social be-  
ings sub-  
ject to ob-  
servatio

A social  
and a sa-  
vage state

Blackst.  
Comment.  
vol. ii.

enter into social union, though they may have hoped to enjoy superior security and happiness by engaging to protect and support each other, we must conclude that the Author of the universe has destined man to attain greater dignity and happiness in a savage and solitary than in a social state; and therefore that those dispositions and views which lead us to society are fallacious and inimical to our real interest.

Whatever be the supposed advantages of a solitary state, certain it is that mankind, at the earliest periods, were united in society. Various theories have been formed concerning the circumstances and principles which gave rise to this union: but we have elsewhere shown, that the greater part of them are founded in error; that they suppose the original state of man to have been that of savages; and that such a supposition is contradicted by the most authentic records of antiquity. For though the records of the earlier ages are generally obscure, fabulous, and imperfect; yet happily there is *one* free from the imperfections of the rest, and of undoubted authenticity, to which we may safely have

recourse†. This record is the Pentateuch of Moses, which presents us with a genuine account of the origin of man and of society, perfectly consonant to what we have laid down in the article referred to (see SAVAGE). According to Moses, the first society was that of a husband and wife united in the bonds of marriage: the first government that of a father and husband, the master of his family. Men lived together under the patriarchal form of government while they employed themselves chiefly in tending flocks and herds. Children in such circumstances cannot soon rise to an equality with their parents, where a man's importance depends on his property, not on his abilities. When flocks and herds are the chief articles of property, the son can only obtain these from his father; in general therefore the son must be entirely dependent on the father for the means of subsistence. If the parent during his life bestow on his children any part of his property, he may do it on such conditions as shall make their dependence upon him continue till the period of his death. When the community are by this event deprived of their head, instead of continuing in a state of union, and selecting some one from among themselves whom they may invest with the authority of a parent, they separate into so many distinct tribes, each subjected to the authority of a different lord, the master of the family, and the proprietor of all the flocks and herds belonging to it. Such was the state of the first societies which the narrative of Moses exhibits to our attention.

Those philosophers who have made society, in its various stages between rudeness and refinement, the subject of their speculations, have generally considered mankind, in whatever region of the globe, and under whatever climate, as proceeding uniformly through certain regular gradations from one extreme to the other. They regard them, first, as gaining a precarious subsistence by gathering the spontaneous fruits of the earth, preying on the inhabitants of the waters, if placed on the seashore, or along the banks of large rivers; or hunting wild beasts, if in a situation where there are to be found in abundance, without foresight or industry to provide for future wants when the present call of appetite is gratified. Next, they say, man rises to the shepherd state, and next to that of husbandmen, when they turn their

attention from the management of flocks to the cultivation of the ground. Next, these husbandmen improve their powers, and better their condition, by becoming artificers and merchants; and the beginning of this period is the boundary between barbarity and civilization.

These are the stages through which they who have employed themselves on the natural history of society have generally conducted mankind in their progress from rudeness to refinement: but they seem to have overlooked the manner in which mankind were at first established on this earth; for the circumstances in which the parents of the human race were originally placed; for the degree of knowledge communicated to them; and for the instruction which they must have been capable of communicating to their posterity. They rather appear to consider the inhabitants of every different region of the globe as aborigines, springing at first from the ground, or dropped on the spot which they inhabit; no less ignorant than infants of the nature and relations of the objects around them, and of the purposes which they may accomplish by the exercise of their organs and faculties.

The absurdity of this theory has been fully demonstrated in another place: and if we agree to receive the Mosaic account of the original establishment of mankind, we shall be led to view the phenomena of social life in a light very different. We must first allow, that though many of the rudest tribes are found in the state of *hunters or fishers*; yet the hunting or fishing state cannot have been invariably the primary form of society. Notwithstanding the powers with which we are endowed, we are in a great measure the creatures of circumstances. Physical causes exert, though indirectly, a mighty influence in forming the character and directing the exertions of the human race. From the information of Moses we gather, that the first societies of men lived under the patriarchal form of government, and employed themselves in the cultivation of the ground and the management of flocks. And as we know that mankind, being subjected to the influence both of physical and moral causes, are no less liable to degeneracy than capable of improvement; we may easily conceive, that though descending all from the same original pair, and though enlightened with much traditional knowledge relative to the arts of life, the order of society, moral distinctions, and religious obligations; yet as they were gradually, and by various accidents, dispersed over the earth, being removed to situations in which the arts with which they were acquainted could but little avail them, where industry was overpowered, or indolence encouraged by the severity or the profusion of nature, they might degenerate and fall into a condition almost as humble and precarious as that of the brutal tribes. Other moral causes might also concur to debase or elevate the human character in that early period. The particular character of the original settlers in any region, the manner in which they were connected with one another, and the arts which they were best qualified to exercise, with various other causes of a similar nature, would have considerable influence in determining the character of the society.

When laying aside the spirit of theory and system, we set ourselves, with due humility, to trace facts, and to listen to evidence, though our discoveries may be

Scripture  
7—  
5  
State  
ociety  
ordin  
u: l en  
atory.

6  
ories of  
loso-  
re con  
ing the  
gn of  
ety

7  
Are facci-  
ful.

Society.

fewer than we should otherwise fancy them; yet the knowledge which we thus acquire will be more useful and solid, and our speculations more consistent with the spirit of true philosophy. Here, though we learn from the information of the sacred writings, that the first family of mankind was not cruelly exposed in this world, as children whom the inhumanity of their parents induces them to desert; yet we are not, in consequence of admitting this fact, laid under any necessity of denying or explaining away any of the other phenomena which occur to our observation when tracing the natural history of society. Tradition may be corrupted; arts and sciences may be lost; the sublimest religious doctrines may be debased into absurdity.

If then we are desirous of surveying society in its rudest form, we must look, not to the earliest period of its existence, but to those districts of the globe where external circumstances concur to drive them into a state of stupidity and wretchedness. Thus in many places of the happy clime of Asia, which a variety of ancient records concur with the sacred writings in representing as the first peopled quarter of the globe, we cannot trace the form of society backwards beyond the shepherd state. In that state indeed the bonds which connect society extend not to a wide range of individuals, and men remain for a long period in distinct families; but yet that state is highly favourable to knowledge, to happiness, and to virtue. Again, the torrid and the frozen regions of the earth, though probably peopled at a later period, and by tribes sprung from the same stock with the shepherds of Asia, have yet exhibited mankind in a much lower state. It is in the parched deserts of Africa and the wilds of America that human beings have been found in a condition approaching the nearest to that of the brutes.

We may therefore with some propriety desert the order of time, and take a view of the different stages through which philosophers have considered mankind as advancing, beginning with that of rudeness, though we have shown that it cannot have been the first in the progress.

Where the human species are found in the lowest and rudest state, their rational and moral powers are very faintly displayed; but their external senses are acute, and their bodily organs active and vigorous. Hunting and fishing are then their chief employments on which they depend for support. During that portion of their time which is not spent in these pursuits, they are sunk in listless indolence. Destitute of foresight, they are roused to active exertion only by the pressure of immediate necessity or the urgent calls of appetite. Accustomed to endure the severity of the elements, and but scantily provided with the means of subsistence, they acquire habits of resignation and fortitude, which are beheld with astonishment by those who enjoy the plenty and indulgence of cultivated life. But in this state of want and depression, when the powers and possessions of every individual are scarce sufficient for his own support, when even the calls of appetite are repressed because they cannot always be gratified, and the more refined passions, which either originate from such as are merely animal, or are intimately connected with them, have not yet been felt—in this state all the milder affections are unknown; or if the breast is at all sensible to their impulse, it is extremely feeble. Husband and

wife, parent and child, brother and brother, are united by the weakest ties. Want and misfortune are not pitied. Why indeed should they, where they cannot be relieved? It is impossible to determine how far beings in this condition can be capable of moral distinctions. One thing certain is, that in no state are the human race entirely incapable of these. If we listen, however, to the relations of respectable travellers, we must admit that human beings have sometimes been found in that abject state where no proper ideas of subordination, government, or distinction of ranks, could be formed. No distinct notions of Deity can be here entertained. Beings in so humble a condition cannot look through the order of the universe and the harmony of nature to that Eternal Wisdom and Goodness which contrived, and that Almighty Power which brought into existence, the system of things. Of arts they must be almost totally destitute. They may use some instruments for fishing or the chase; but these must be extremely rude and simple. If they be acquainted with any means to shelter them from the inclemency of the elements, both their houses and clothing will be awkward and inconvenient.

But human beings have not been often found in so rude a state as this. Even those tribes which we denominate savage, are for the most part farther removed from mere animal life. They generally appear united under some species of government, exercising the powers of reason, capable of morality, though that morality be not always very refined; displaying some degree of social virtues, and acting under the influence of religious sentiments. Those who may be considered as but one degree higher in the scale than the stupid and wretched beings whose condition we have surveyed, are to be found still in the hunting and fishing state; but they are farther advanced towards social life, and are become more sensible to the impulse of social affection. By unavoidable intercourse in their employments, a few individual hunters or fishers contract a certain degree of fondness for each other's company, and are led to take some part in each other's joys and sorrows; and when the social affections thus generated (see *PASSION*) begin to exert themselves, all the other powers of the mind are at the same time called forth, and the circumstances of the little society are immediately improved. We behold its members in a more comfortable condition, and find reason to view the human character with more complacency and respect. Huts are now built, more commodious clothes are fashioned, instruments for the annoyance of wild beasts and even of enemies are contrived; in short, arts, and science, and social order, and religious sentiments, and ceremonies, now make their appearance in the rising society, and serve to characterize it by the particular form which distinguishes each of them. But though social order is no longer unknown nor unobserved, yet the form of government is still extremely simple, and its ties are but loose and feeble. It will perhaps bear some resemblance to the patriarchal; only all its members are on a more equal footing, and at the same time less closely connected than in the shepherd state, to which that form of government seems almost peculiar. The old men are treated with veneration; but the young are not entirely subject to them. They may listen respectfully to their advice; but they do not submit to their arbitrary commands.

8  
Yet in some particular instances realized.

9  
Rudest state or first stage of society.

Society

Second stage in the progress of society

Society. commands. Where mankind are in the state of hunters and fishers, where the means of subsistence are precariously acquired, and prudent foresight does not prompt to accumulate much provision for the future, no individual can acquire comparative wealth. As soon as the son is grown up, he ceases to be dependent on his father, as well as on the society in general. Difference of experience therefore constitutes the only distinction between the young and the old; and if the old have experience, the young have strength and activity. Here, then, neither age nor property can give rise to any striking distinction of ranks. All who have attained to manhood, and are not disabled by unusual deficiency of strength or agility, or by the infirmities of old age, are on an equal footing; or if any one possess a pre-eminence over the rest, he owes it to superior address or fortitude. The whole tribe deliberate; the old give their advice; each individual of the assembly receives or rejects it at his pleasure (for the whole body think not of exercising any compulsory power over the will of individuals); and the warrior who is most distinguished for strength, address, and valour, leads out the youth of the tribe to the chase or against the enemy. War, which in the former stage did not prevail, as they who were strangers to social sentiments were, at the same time, scarce capable of being enemies, now first begins to depopulate the thinly inhabited regions where those hunters and fishers pursue their prey. They are scattered, possibly in scanty and separate tribes, over an immense tract of country; but they know no medium between the affection which brethren of the same tribe bear to each other and the hatred of enemies. Though thinly scattered over the earth, yet the hunting parties of different tribes will sometimes meet as they range the forests; and when they meet, they will naturally view each other with a jealous eye; for the success of the one party in the chase may cause the other to be unsuccessful; and while the one snatches the prey, the other must return home to all the pangs of famine. Inveterate hostility will therefore long prevail among neighbouring tribes in the hunting state.

If we find them not incapable of social order, we may naturally expect that their conduct will be influenced by some sentiments of religion. They have at this period ideas of superior beings. They also practise certain ceremonies to recommend them to those beings; but both their sentiments and ceremonies are superstitious and absurd.

We have elsewhere shown (see POLYTHEISM) how savage tribes have probably degenerated from the pure worship of the one true God to the adoration of a multitude of imaginary divinities in heaven, earth, and hell. We have traced this idolatrous worship from that of the heavenly bodies, through all the gradations of demon-worship, hero-worship, and statue-worship, to that wonderful instance of absurd superstition which induced the inhabitants of some countries to fall prostrate in adoration before the vilest reptiles. But though we are convinced that the heavenly bodies have by all idolaters been considered as their first and greatest gods, we pretend not that the progress through the other stages of polytheism has been everywhere in the very same order. It is indeed impossible to exhibit under one general view an account of arts, manners, and religious sentiments, which may apply to some certain pe-

riod in the history of every nation. The characters and circumstances of nations are scarce less various and anomalous than those of individuals. Among many of the American tribes among the ancient inhabitants of the forests of Germany, whose manners have been so accurately delineated by the masterly pen of Tacitus, and in some of the islands scattered over the southern ocean, religion, arts, and government, have been found in that state which we have described as characterizing the second stage of social life. But neither can we pretend that all those simple and rude societies have been described by historians and travellers as agreeing precisely in their arts, manners, and religious sentiments; or that the difference of circumstances always enables us to account in a satisfactory manner for the distinction of their characters. There is a variety of facts in the history of the early periods of society, which no ingenuity, no industry however painful, can reduce under general heads. Here, as well as when we attempt to philosophize on the phenomena of the material world, we find reason to confess that our powers are weak, and our observation confined within a narrow sphere.

But we may now carry our views a little forward, <sup>II</sup> and survey human life as approaching somewhat nearer <sup>Third stage</sup> to a civilized and enlightened state. As property is ac- <sup>the pro-</sup>quired, inequality and subordination of ranks necessarily <sup>cess of so-</sup>follow: and when men are no longer equal, the many <sup>ciety, in</sup> are soon subjected to the will of the few. But what <sup>which ideas</sup> gives rise to these new phenomena is, that after having <sup>of property</sup> often suffered from the precariousness of the hunting <sup>and in-equa-</sup> and fishing state, men begin to extend their cares <sup>lity of</sup> beyond the present moment, and to think of providing <sup>ranks ap-</sup> some supply for future wants. When they are enabled <sup>pear.</sup> to provide such a supply, either by pursuing the chase with new eagerness and perseverance, by gathering the spontaneous fruits of the earth, or by breeding tame animals—these acquisitions are at first the property of the whole society, and distributed from a common store to each individual according to his wants: But as various reasons will soon concur to convince the community, that by this mode of distribution, industry and activity are treated with injustice, while negligence and indolence receive more than their due, each individual will in a short time become his own steward, and a community of goods will be abolished. As soon as distinct ideas of property are formed, it must be unequally distributed; and as soon as property is unequally distributed, there arises an inequality of ranks. Here we have the origin of the depression of the female sex in rude ages, of the tyrannical authority exercised by parents over their children, and perhaps of slavery. The women cannot display the same perseverance, or activity, or address, as the men in pursuing the chase. They are therefore left at home; and from that moment are no longer equals, but slaves and dependants, who must subsist by the bounty of the males, and must therefore submit with implicit obedience to all their capricious commands. Even before the era of property, the female sex were viewed as inferiors; but till that period they were not reduced to a state of abject slavery.

In this period of society new notions are formed of the relative duties. Men now become citizens, masters, and servants; husbands, parents, &c. It is impossible to enumerate all the various modes of government which take place among the tribes who have advanced

Society.

to this stage; but one thing certain is, that the authority of the few over the many is now first established, and that the rise of property first introduces inequality of ranks. In one place, we shall perhaps find the community subjected during this period to the will of a single person; in another, power may be lodged in the hands of a number of chiefs; and in a third, every individual may have a voice in creating public officers, and in enacting laws for the support of public order. But as no code of laws is formed during this period, justice is not very impartially administered, nor are the rights of individuals very faithfully guarded. Many actions, which will afterwards be considered as heinously immoral, are now considered as praise-worthy or indifferent. This is the age of hero-worship, and of household and tutelary gods; for it is in this stage of society that the invention of arts, which gave rite to that worship, contributes most conspicuously to the public good. War, too, which we considered as beginning first to ravage the earth during the former period, and which is another cause of the deification of dead men, will still prevail in this age, and be carried on with no less ferocity than before, though in a more systematic form.

The prevalence of war, and the means by which subsistence is procured, cannot but have considerable influence on the character and sentiments of societies and individuals. The hunter and the warrior are characters in many respects different from the shepherd and the husbandman. Such, in point of government, arts, and manners, religious and moral sentiments, were several of the German tribes described by Tacitus; and the Britons whose character has been sketched by the pen of Cæsar: such, too, were the Romans in the early period of their history; such too the inhabitants of Asia Minor about the time of the siege of Troy, as well as the Greeks whom Homer celebrates as the destroyers of the Trojan state: the northern tribes also, who poured thro' Asia, Africa, and Europe, and overthrew the Roman empire, appear to have been of a nearly similar character. It seems to be a general opinion among those who have directed their attention to the history of society, that, in the scale ascending from the lowest condition of human beings to the most civilized and enlightened state of society, the shepherd state is the next in order above the hunting; and that as mankind improve in knowledge and in moral sentiments, and as the forests are gradually depopulated of their inhabitants, instead of destroying the inferior animals, men become their guardians and protectors. But we cannot unreservedly subscribe to this opinion: we believe, that in the shepherd state societies have been sometimes found superior to the most polished tribes of hunters; but upon viewing the annals of mankind in early ages, we observe that there is often no inconsiderable resemblance even between hunters and shepherds in point of the improvement of the rational faculties and the moral sense; and we are therefore led to think, that these two states are sometimes parallel: for instance, several of the American tribes, who still procure their subsistence by hunting, appear to be nearly in the state which we have described as the third stage in the progress of society; and the ancient shepherds of Asia do not appear to have been much more cultivated and refined. We even believe that men have sometimes turned their attention from hunting to agriculture without passing through

any intermediate state. Let us remember, that much depends upon local circumstances, and somewhat undoubtedly on original inspiration and traditionary instruction. In this period of society the state of the arts well deserves our attention. We shall find, that the shepherds and the hunters are in that respect on a pretty equal footing. Whether we examine the records of ancient history, or view the islands scattered through the South Sea, or range the wilds of America, or survey the snowy wastes of Lapland and the frozen coast of Greenland—still we find the useful arts in this period, though known and cultivated, in a very rude state; and the fine arts, or such as are cultivated merely to please the fancy or to gratify caprice, displaying an odd and fantastic, not a true or natural, taste; yet this is the period in which eloquence shines with the truest lustre: all is metaphor or glowing sentiment. Languages are not yet copious; and therefore speech is figurative, expressive, and forcible. The tones and gestures of nature, not being yet laid aside, as they generally are, from regard to decorum, in more polished ages, give a degree of force and expression to the languages of the rustic or savage orator, which the most laborious study of the rules of rhetoric and elocution could not enable even a more polished orator to display.

But let us advance a little farther, and contemplate our species in a new light, where they will appear with greater dignity and amiableness of character. Let us view them as husbandmen, artizans, and legislators. Whatever circumstances might turn the attention of any people from hunting to agriculture, or cause the herdsman to yoke his oxen for the cultivation of the ground, certain it is that this change in the occupation would produce an happy change on the character and circumstances of men; it would oblige them to exert a more regular and persevering industry. The hunter is like one of those birds that are described as passing the winter in a torpid state. The shepherd's life is extremely indolent. Neither of these is very favourable to refinement. But different is the condition of the husbandman. His labours succeed each other in regular rotation through the year. Each season with him has its proper employments: he therefore must exert active persevering industry; and in this state we often find the virtues of rude and polished ages united. This is the period where barbarism ends and civilization begins. Nations have existed for ages in the hunting or the shepherd state, fixed as by a kind of stagnation, without advancing farther. But scarce any instances occur in the history of mankind of those who once reached the state of husbandmen, remaining long in that condition without rising to a more civilized and polished state. Where a people turn their attention in any considerable degree to the objects of agriculture, a distinction of occupations naturally arises among them. The husbandman is so closely employed thro' the several seasons of the year in the labours of the field, that he has no longer leisure to exercise all the rude arts known among his countrymen. He has not time to fashion the instruments of husbandry, to prepare his clothes, to build his house, to manufacture household utensils, or to tend those tame animals which he continues to rear. Those different departments therefore now begin to employ different persons; each of whom

Society.

12

Fourth stage; in which agriculture flourishes, the arts are subdivided, commerce and regular government are introduced.



**Society.** dedicates his whole time and attention to his own occupation. The manufacture of cloth is for a considerable time managed exclusively by the women; but smiths and joiners arise from among the men. Metals begin now to be considered as valuable materials. The intercourse of mankind is now placed on a new footing. Before, every individual practised all the arts that were known, as far as was necessary for supplying himself with the conveniences of life. Now he confines himself to one or to a few of them; and, in order to obtain a necessary supply of the productions of those arts which he does not cultivate himself, he gives in exchange a part of the productions of his own labours. Here we have the origin of commerce.

After continuing perhaps for some time in this state, as arts and distinctions multiply in society, the exchange of one commodity for another is found troublesome and inconvenient. It is ingeniously contrived to adopt a medium of commerce, which being estimated not by its intrinsic value, but by a certain nominal value which it receives from the agreement of the society among whom it is used, serves to render the exchange of property, which is so necessary for the purposes of social life, easy and expeditious. Wherever metals have been known, they appear to have been adopted as the medium of commerce almost as soon as such a medium began to be used: and this is one important purpose for which they serve; but they have still more important uses. Almost all the necessary arts depend on them. Where the metals are known, agriculture practised, and the necessary arts distributed among different orders of artificers—civilization and refinement, if not obstructed by some accidental circumstances, advance with a rapid progress. With regard to the first applying of the precious metals as the medium of commerce, we may observe, that this was probably not accomplished by means of a formal contract. They might be first used as ornaments; and the love of ornament, which prevails among rude as much as among civilized nations, would render every one willing to receive them in exchange for such articles as he could spare. Such might be the change produced on society with regard to the necessary arts by the origin of agriculture. As soon as ornament and amusement are thought of, the fine arts begin to be cultivated. In their origin therefore they are not long posterior to the necessary and useful arts. They appear long before men reach the comfortable and respectable condition of husbandmen; but so rude is their character at their first origin, that our *Dilettanti* would probably view their productions of that period with unspeakable contempt and disgust. But in the period of society which we now consider, they have aspired to an higher character; yet poetry is now perhaps less generally cultivated than during the shepherd state. Agriculture, considered by itself, is not directly favourable either to refinement of manners or to the fine arts. The conversation of shepherds is generally supposed to be far more elegant than that of husbandmen; but though the direct and immediate effects of this condition of life be not favourable to the fine arts, yet indirectly it has a strong tendency to promote their improvement. Its immediate influence is extremely favourable to the necessary and useful arts; and these are no less favourable to the fine arts.

**Society,** One of the noblest changes which the introduction of the arts by agriculture produces on the form and circumstances of society, is the introduction of regular government and laws. In tracing the history of ancient nations, we scarce ever find laws introduced at an earlier period. Minos, Solon, and Lycurgus, do not appear to have formed codes of wisdom and justice for regulating the manners of their countrymen, till after the Cretans, the Athenians, and even the Lacedemonians, had made some progress in agriculture and the useful arts.

Religion, under all its various forms, has in every stage of society a mighty influence on the sentiments and conduct of men (see RELIGION); and the arts cultivated in society have on the other hand some influence on the system of religious belief. One happy effect which will result from the invention of arts, though perhaps not immediately, will be, to render the character of the deities more benevolent and amiable, and the rites of their worship more mild and humane.

The female sex in this period generally find the yoke of their slavery somewhat lightened. Men now become easier in their circumstances; the social affections assume stronger influence over the mind; plenty, and security, and ease, at once communicate both delicacy and keenness to the sensual desires. All these circumstances concur to make men relax in some degree that tyrannical sway by which they before depressed the softer sex. The foundation of that empire, where beauty triumphs over both wisdom and strength, now begins to be laid. Such are the effects which history warrants us to attribute to agriculture and the arts; and such the outlines of the character of that which we reckon the fourth stage in the progress of society from rudeness to refinement.

Let us advance one step farther. We have not yet <sup>13</sup> surveyed mankind in their most polished and cultivated state. Society is rude at the period when the arts first <sup>in the progress of</sup> begin to show themselves, in comparison of that state <sup>society; in</sup> to which it is raised by the industrious cultivation of <sup>which literature,</sup> them. The neighbouring commonwealths of Athens <sup>and</sup> and Lacedemon afford us a happy opportunity of comparing this with the former stage in the progress of <sup>are much</sup> society. The chief effect produced by the institutions of a <sup>and</sup> Lycurgus seems to have been, to fix the manners of his <sup>and</sup> countrymen for a considerable period in that state to which they had attained in his days. Spartan virtue <sup>spect</sup> has been admired and extolled in the language of enthusiasm; but in the same manner has the character and the condition of the savage inhabitants of the wilds of America, been preferred by some philosophers, to the virtues and the enjoyments of social life in the most polished and enlightened state. The Spartans in the days of Lycurgus had begun to cultivate the ground, and were not unacquainted with the useful arts. They must soon have advanced farther had not Lycurgus arisen, and by effecting the establishment of a code of laws, the tendency of which appears to have been in many particulars directly opposite to the designs of nature, retarded their progress towards complete civilization and refinement. The history of the Lacedemonians, therefore, while the laws of Lycurgus continued in force, exhibits the manners and character of a people in that which we have denominated the fourth stage in the progress of society. But if we turn our eyes to their

Society. neighbours the Athenians, we behold in their history the natural progress of opinions, arts, and manners. The useful arts are first cultivated with such steady industry, as to raise the community to opulence, and to furnish them with articles for commerce with foreign nations. The useful arts cannot be raised to this height of improvement without leading men to the pursuit of science. Commerce with foreign nations, skill in the useful arts, and a taste for science, mutually aid each other, and conspire to promote the improvement of the fine arts. Hence magnificent buildings, noble statues, paintings expressive of life, action, and passion; and poems in which imagination adds new grace and sublimity to nature, and gives the appearances of social life more irresistible power over the affections of the heart. Hence are moral distinctions more carefully studied, and the rights of every individual and every order in society better understood and more accurately defined. Moral science is generally the first scientific pursuit which strongly attracts the attention of men. Lawgivers appear before geometers and astronomers. Some particular circumstances may cause these sciences to be cultivated at a very early period. In Egypt the overflowing of the Nile caused geometry to be early cultivated. Causes no less favourable to the study of astronomy, concurred to recommend that science to the attention of the Chaldeans long before they had attained the height of refinement. But, in general, we find, that the laws of morality are understood, and the principles of morals inquired into, before men make any considerable progress in physical science, or even prosecute it with any degree of keenness. Accordingly, when we view the state of literature in this period (for it is now become an object of so much importance as to force itself on our attention), we perceive that poetry, history, and morals, are the branches chiefly cultivated. Arts are generally casual inventions, and long practised before rules and principles on which they are founded assume the form of science. But morality, if considered as an art, is that art which men have soonest and most constantly occasion to practise. Besides, we are so constituted by the wisdom of nature, that human actions, and the events which befall human beings, have more powerful influence than any other object to engage and fix our attention. Hence we are enabled to explain why morality, and those branches of literature more immediately connected with it, are almost always cultivated in preference to physical science. Though poetry, history, and morals, be pursued with no small eagerness and success in that period of society which we now consider, we need not therefore be greatly surprised that natural philosophy is neither very generally nor very successfully cultivated. Were we to consider each particular in that happy change which is now produced on the circumstances of mankind, we should be led into a too minute and perhaps unimportant detail. This is the period when human virtue and human abilities shine with most splendour. Rudeness, ferocity, and barbarism, are now banished. Luxury has made her appearance; but as yet she is the friend and the benefactress of society. Commerce has stimulated and rewarded industry, but has not yet contracted the heart and debased the character. Wealth is not yet become the sole object of pursuit. The charms of social intercourse are known and relished; but domestic duties are not yet deserted

for public amusements. The female sex acquire new influence, and contribute much to refine and polish the manners of their lords. Religion now assumes a milder and more pleasing form; splendid rites, magnificent temples, pompous sacrifices, and gay festivals, give even superstition an influence favourable to the happiness of mankind. The gloomy notions and barbarous rites of former periods fall into disuse. The system of theology produced in former ages still remains: but only the mild and amiable qualities of the deities are celebrated; and none but the gay, humane, and laughing divinities, are worshipped. Philosophy also teaches men to discard such parts of their religion as are unfriendly to good morals, and have any tendency to call forth or cherish unsocial sentiments in the heart. War (for in this period of society enough of causes will arise to arm one nation against another)—war, however, no longer retains its former ferocity; nations no longer strive to extirpate one another; to procure redress for real or imaginary injuries; to humble, not to destroy, is now its object. Prisoners are no longer murdered in cold blood, subjected to horrid and excruciating tortures, or condemned to hopeless slavery. They are ransomed or exchanged; they return to their country, and again fight under its banners. In this period the arts of government are likewise better understood, and practised so as to contribute most to the interests of society. Whether monarchy, or democracy, or aristocracy, be the established form, the rights of individuals and of society are in general respected. The interests of society are so well understood, that the few, in order to preserve their influence over the many, find it necessary to act rather as the faithful servants than the imperious lords of the public. Though the liberties of a nation in this state be not accurately defined by law, nor their property guaranteed to them by any legal institutions, yet their governors dare not violate their liberties, nor deprive them wantonly of their properties. This is truly the golden age of society: every trace of barbarism is entirely effaced; and vicious luxury has not yet begun to sap the virtue and the happiness of the community. Men live not in listless indolence; but the industry in which they are engaged is not of such a nature as to overpower their strength or exhaust their spirits. The social affections have now the strongest influence on mens sentiments and conduct.

But human affairs are scarce ever stationary. The circumstances of mankind are almost always changing, either growing better or worse. Their manners are ever in the same fluctuating state. They either advance towards perfection or degenerate. Scarce have they attained that happy period in which we have just contemplated them, when they begin to decline till they perhaps fall back into a state nearly as low as that from which we suppose them to have emerged. Instances of this unhappy degeneracy occur more than once in the history of mankind; and we may finish this short sketch of the history of society by mentioning in what manner this degeneracy takes place. Perhaps, strictly speaking, every thing but the simple necessities of life may be denominated luxury: for a long time, however, the welfare of society is best promoted, while its members aspire after something more than the mere necessities of life. As long as these superfluities are to be obtained only by active and honest exertion; as long

14  
Degeneracy  
and decline  
of society.

**Society.** as they only engage the leisure hours, without becoming the chief objects of pursuit—the employment which they give to the faculties is favourable both to the virtue and the happiness of the human race.

The period arrives, however, when luxury is no longer serviceable to the interests of nations; when she is no longer a graceful, elegant, active form, but a languid, overgrown, and bloated carcass. It is the love of luxury, which contributed so much to the civilization of society, that now brings on its decline. Arts are cultivated and improved, and commerce extended, till enormous opulence be acquired: the effect of opulence is to awake the fancy, to conceive ideas of new and capricious wants, and to inflame the breast with new desires. Here we have the origin of that selfishness which, operating in conjunction with caprice and the violence of unbridled passions, contributes so much to the corruption of virtuous manners. Selfishness, caprice, indolence, effeminacy, all join to loosen the bonds of society, to bring on the degeneracy both of the useful and the fine arts, to banish at once the mild and the austere virtues, to destroy civil order and subordination, and to introduce in their room anarchy or despotism.

Scarcely could we have found an example of the beautiful form of society which we last attempted to describe. Never, at least, has any nation continued long to enjoy such happy circumstances, or to display so amiable and respectable a character. But when we speak of the declining state of society, we have no difficulty in finding instances to which we may refer. History tells of the Assyrians, the Egyptians, and the Persians, all of them once flourishing nations, but brought low by luxury and an unhappy corruption of manners. The Greeks, the Romans, and the Arabians, owed their fall to the same causes; and we know not if a similar fate does not now threaten many of those nations who have long made a distinguished figure in the system of Europe. The Portuguese, the Venetians, and the Spaniards, have already fallen; and what is the present state of our neighbours the French? They have long been a people destitute of religion, corrupted in morals, unsteady in conduct, and slaves to pleasure and public amusements. Among them luxury had arrived at its highest pitch; and the consequence has been, that after capriciously shaking off the yoke of despotism, they have established, or rather set up (for established it cannot be), a motley kind of government, which, in the course of a few years, has exhibited scenes of tyranny and oppression, to which we doubt if the annals of the world can furnish any parallel. Yet this is the people whose manners the other nations of Europe were ambitious to imitate. May these nations take warning in time, and avoid the rocks upon which they have split.

**75**  
**Concluding**  
**remarks.** **THUS** have we viewed the several stages in which society appears in its progress from rudeness to refinement and decay. The intelligent reader will perceive, that the various and anomalous phenomena which occur in the natural history of society, cannot easily be solved; because the necessary information cannot be obtained. Others have been well accounted for by the researches of curious philosophical inquirers. Local circumstances, the influence of climate, the intercourse of nations in different states of civilization, have been taken notice of, as causes serving to accelerate or retard

the progress of arts and manners. But our proper business here was merely to mark the gradations between barbarism and refinement: and as the painter who is to exhibit a series of portraits representing the human form in infancy, puerility, youth, and manhood, will not think of delineating all that variety of figures and faces which each of those periods of life affords, and will find himself unable to represent in any single figure all diversities of form and features; so we have not once thought of describing particularly under this article, all the various national characters reducible to any one of those divisions under which we have viewed the progress of society, nor have found it possible to comprehend under one consistent view, all the particulars which may be gathered from the remains of antiquity, from the relations of later travellers, and the general records of history concerning the progressive character of mankind in various regions, and under the influence of various accidents and circumstances. This indeed would have even been improper, as all that information appears under other articles in this Work.

**SOCIETIES**, associations voluntarily formed by a number of individuals for promoting knowledge, industry, or virtue. They may therefore be divided into three classes; societies for promoting science and literature, societies for encouraging and promoting arts and manufactures, and societies for diffusing religion and morality and relieving distress. Societies belonging to the first class extend their attention to all the sciences and literature in general, or devote it to one particular science. The same observation may be applied to those which are instituted for improving arts and manufactures. Those of the third class are established, either with a view to prevent crimes, as the Philanthropic Society; for the diffusion of the Christian religion among unenlightened nations, as the Society for the Propagation of the Gospel in Foreign Parts; or for introducing arts and civilization, along with a knowledge of the Christian religion, as the Sierra Leona company.

The honour of planning and instituting societies for those valuable purposes is due to modern times. A literary association is said to have been formed in the reign of Charlemagne (see **ACADEMY**); but the plan seems to have been rude and defective. Several others were instituted in Italy in the 16th century; but from the accounts which we have seen of them, they seem to have been far inferior to those which are most flourishing at present. The most enlarged idea of literary societies seems to have originated with the great Lord Bacon, the father of modern philosophy, who recommended to the reigning prince to institute societies of learned men, who should give to the world from time to time a regular account of their researches and discoveries. It was the idea of this great philosopher, that the learned world should be united, as it were, into one immense republic; which, though consisting of many detached states, should hold a strict union and preserve a mutual intelligence with each other, in every thing that regards the common interest. The want of this union and intelligence he laments as one of the chief obstacles to the advancement of science; and, justly considering the institution of public societies, in the different countries of Europe, under the auspices of the sovereign, to be the best remedy for that defect, he has given, in his fanciful work, the *New Atlantis*, the delineation of a philosophical

**Societies.** society on the most extended plan, for the improvement of all arts and sciences; a work which, though written in the language, and tinged with the colouring of romance, is full of the noblest philosophic views. The plan of Lord Bacon, which met with little attention from the age in which he lived, was destined to produce its effect in a period not very distant. The scheme of a philosophical college by Cowley is acknowledged to have had a powerful influence in procuring the establishment of the Royal Society of London by charter from Charles II. §; and Cowley's plan is manifestly copied in almost all its parts from that in the New Atlantis. The institution of the Royal Society of London was soon followed by the establishment of the Royal Academy of Sciences at Paris; and these two have served as models to the philosophical academies of highest reputation in the other kingdoms of Europe.

§ *Spratt's History of the Royal Society*, 2d edit. p. 59.

The experience of ages has shown, that improvements of a public nature are best carried on by societies of liberal and ingenious men, uniting their labours without regard to nation, sect, or party, in one grand pursuit alike interesting to all, whereby mutual prejudices are worn off, and a humane philosophical spirit is cherished. Men united together, and frequently meeting for the purpose of advancing the sciences, the arts, agriculture, manufactures, and commerce, may oftentimes suggest such hints to one another as may be improved to important ends: and such societies, by being the repositories of the observations and discoveries of the learned and ingenious, may from time to time furnish the world with useful publications which might otherwise be lost: for men of ingenuity and modesty may not choose to risk their reputation, by sending abroad unpatronized what a learned society might judge richly worthy the public eye; or perhaps their circumstances being straitened, they may not be able to defray the expence of publication. Societies instituted for promoting knowledge may also be of eminent service, by exciting a spirit of emulation, and by enkindling those sparks of genius which otherwise might for ever have been concealed; and if, when possessed of funds sufficient for the purpose, they reward the exertions of the industrious and enterprising with pecuniary premiums or honorary medals, many important experiments and useful discoveries will be made, from which the public may reap the highest advantages.

Eminent instances of the beneficial effects of such institutions we have in the Royal Academy of Sciences at Paris, the Royal Society, and the Society instituted for the Encouragement of Arts, Manufactures, and Commerce, in London, and many others of a similar kind. Hereby a spirit of discovery and improvement has been excited among the ingenious in almost every nation; knowledge of various kinds, and greatly useful to mankind, has taken place of the dry and uninteresting speculations of schoolmen; and bold and erroneous hypothesis has been obliged to give way to demonstrative experiment. In short, since the establishment of these societies, solid learning and philosophy have more increased than they had done for many centuries before.

As to those societies established for promoting industry, religion and morality, and relieving distress, the design is laudable and excellent, and presents a beautiful picture of the philanthropy of modern times. We are happy to find, from the minutes of some of these so-

cieties, that their beneficial effects are already conspicuous.

**Religious and Humane Societies.**

We will now give some account of the most eminent societies; arranging them under the three classes into which we have divided them: I. *Religious and Humane Societies.* II. *Societies for Promoting Science and Literature.* III. *Societies for Encouraging Arts, Manufactures, &c.*

#### I. RELIGIOUS AND HUMANE SOCIETIES.

I. *Society for the Propagation of the Gospel in Foreign Parts*, was instituted by King William III. in 1701, in order to secure a maintenance for an orthodox clergy, and to make other provisions for propagating the gospel in the plantations, colonies, and factories beyond the seas. To that end he incorporated the archbishops, several of the bishops, and others of the nobility, gentry, and clergy, to the number of 90, into one body, which, by the name of *The Society for the Propagation of the Gospel in Foreign Parts*, was to plead and be impleaded; to have perpetual succession, with privilege to purchase L. 2000 a-year inheritance, and estates for lives or years, with other goods and chattels to any value. By its charter the society is authorized to use a common seal; and to meet annually on the third Friday in February for the purpose of choosing a president, vice-president, and officers for the year ensuing; and on the third Friday in every month, or oftener if there should be occasion, to transact business, and to depute persons to take subscriptions, and collect money contributed for the purposes aforesaid; and of all moneys received and laid out, it is obliged to give account yearly to the lord-chancellor or keeper, the lord chief-justice of the King's-bench, the lord-chief-justice of the Common-pleas, or to any two of these magistrates. Of this society there is a standing committee at St Paul's chapter-house, to prepare matters for the monthly meeting, which is held at St Martin's library.

Before the incorporation of the society for the propagation of the gospel in foreign parts, there had been formed, for the promoting of Christian knowledge both at home and in the colonies, a voluntary association of persons of rank and respectability, who in March 1699 began to hold stated meetings in London for that purpose, regulating themselves by the laws of the land and the canons of the church; and when the new society was formed, they had already transmitted to America and the West Indies L. 800 worth of Bibles, Books of Common Prayer, and treatises of practical religion, besides securing a tolerable maintenance to several clergyman on that continent. This association still subsists under the denomination of *The Society for Promoting Christian Knowledge*, and has been productive of much good in the cities of London and Westminster; but upon the formation of the new society, into which all its original members were incorporated by name, the care which the voluntary association had taken of the colonies devolved of course upon the incorporated society; of which incorporation we believe the object has been sometimes mistaken, and the labours of its missionaries grossly misrepresented. It has by many been supposed that the society was incorporated for the sole purpose of converting the savage Americans; and it has been much blamed for sending missionaries into provinces where, in the despicable cant of the complainers, a *gospel-ministry* was already established. But an impartial view of the rise

rife and progress of the American provinces, now become independent states, will show the folly and injustice of those complaints.

The English colonies in North America were in the last century formed and first peopled by religious men; who, made uneasy at home by their intolerant brethren, left the *old world* to enjoy in peace that first and chief prerogative of man, *the free worship of God according to his own conscience*. At one time PURITANS were driven across the Atlantic by the episcopal church; at another, CHURCHMEN were forced away by the presbyterians just as the revolutions of state threw the civil power into the hands of the one or the other party; and not a few members of the CHURCH OF ROME were chased to the wilds of America by the united exertions of both. It has been often observed, that people persecuted for their religion become for the most part enthusiastically attached to it; and the conduct of those colonists was in perfect harmony with this observation. Their zeal, inflamed by their violent removal to the other hemisphere, kept religion alive and active among themselves; but their poverty disabled them from supplying fuel to the flame, by making provision for a ministry to instruct their offspring. The consequence was, that the new Christian commonwealth, without the kindly assistance of its mother-country, would have been, in the words of the Roman historian, *Res unius atatis*. Against this danger a timely aid was to be provided by the society; which, as it consisted not of fanatical members, would not intrude the important business of the mission to fanatical preachers, who, though always ready for such spiritual enterprises, are never qualified to carry them on with success.

It was therefore thought fit to assign a decent maintenance for clergymen of the church of England, who might preach the gospel to their brethren in America: and though those missionaries in general carefully avoided the conduct of those of Rome, whose principal aim is to reduce all churches under submission to the papal tyranny; yet so lately as 1765, did some of the colonies, in which the puritanic spirit of the last century characterised the church established by law, raise a hideous outcry against the society for sending a mission into their quarters, though only for the service of the dispersed members of the Episcopal church residing among them, and for the conversion of those men whom their rigid fanaticism had prejudiced against Christianity itself.

Indeed the commodity called FREETHINKING, as Bishop Warburton expresses it, was at an early period imported by the opulent and fashionable colonists. The celebrated Berkeley; who had resided some years in Rhode Island, and at his return was called upon to preach the anniversary sermon before the society, informs us, that the island where he lived was inhabited by an English colony, consisting chiefly of sectaries of many different denominations; that several of the better sort of the inhabitants of towns were accustomed to assemble themselves regularly on the Lord's day for the performance of divine worship; but that most of those who were dispersed through the colony rivalled some well bred people of other countries, in a thorough indifference for all that is sacred, being equally careless of outward worship and of inward principles. He adds, that the missionaries had done, and were continuing to

do, good service in bringing those planters to a serious sense of religion. "I speak it knowingly (says he), that the ministers of the gospel, in those provinces which go by the name of New England, sent and supported at the expence of the society, have, by their sobriety of manners, discreet behaviour, and a competent degree of useful knowledge, shown themselves worthy of the choice of those who sent them" We have the honour to be acquainted with some of the missionaries sent at a later period, and have reason to believe that, down to the era of the American revolution, they had the same virtues, and were doing the same good services, which procured to their predecessors this honourable testimony from one of the greatest and the best of men. Surely such a mission deserved not to be evil spoken of by sectarists of any denomination who believe in Christ; especially as the very charter of incorporation assigns as a reason for missionaries being sent to the colonies, "that by reason of their poverty those colonies were destitute and unprovided of a MAINTENANCE for ministers and the public worship of God."

The society, however, was incorporated for other purposes than this. It was obliged by its charter to attempt the conversion of the native Americans and the negro slaves; and we have reason to believe, that, as soon as the spiritual wants of the colonists were decently supplied, it was not inattentive to these glorious objects. Its success indeed in either pursuit has not been so great as could be wished; but it would be rash and unfair to attribute this failure to the president, vice-president, or other officers of the corporation at home. An erroneous notion, that the being baptized is inconsistent with a state of slavery, rendered the selfish colonists for a long time averse from the conversion of their negroes, and made them throw every obstacle in the way of all who made the attempt; while the difficulties of the Indian mission are such as hardly any clergyman educated in a Protestant country can be supposed able to surmount.

He who hopes successfully to preach the gospel among a tribe of savage wanderers, must have an ardent zeal and unwearied diligence; appetites subdued to all the distresses of want; and a mind superior to all the terrors of mortality. These qualities and habits may be acquired in the church of Rome by him who from infancy has been trained up in the severities of some of the monastic orders, and afterwards sent to the college *de propaganda fide* to be instructed in the languages, and inured to the manners and customs of the barbarous nations whose conversion he is destined to attempt. But in the reformed churches of Britain there are no monastic orders, nor any college *de propaganda fide*; and yet without the regular preparation, which is to be looked for in such institutions alone, it is not in nature, whatever grace may effect, for any man cheerfully, and at the same time soberly, to undergo all the accumulated distresses ever ready to overtake a faithful missionary among savage idolaters. A fanatic zealot will indeed undertake it, though he is totally unqualified for every sober and important work; and a man of ruined fortunes may be pressed into the service, though the impotency of his mind has shown him unable to bear either poverty or riches. The failure of the society therefore in its attempts to convert the American Indians may be attributed, we think, in the first in-

Religious  
and Ha-  
man So-  
cieties.

stance, to the want of a college *de propaganda* for training up young men for the American mission.

Perhaps another cause of this failure may be found in the conduct of the missionaries, who, it is to be presumed, have not always employed in a proper manner even the scanty qualifications which they actually possessed. The gospel, plain and simple as it is, and fitted in its nature for what it was ordained to effect, cannot be apprehended but by an intellect somewhat raised above that of a savage. Such of the missionaries therefore as began their work with *preaching to savage and brutal men*, certainly set out at the wrong end; for to make the gospel understood, and much more to propagate and establish it, those savages should have been first taught the necessary arts of civil life, which, while they improve every bodily accommodation, tend at the same time to enlarge and enlighten the understanding. For want of this previous culture, we doubt not, it hath happened that such of the savages as have been baptized into the faith have so seldom persevered themselves, or been able in any degree to propagate among their tribes the Christianity which they had been taught, and that successive missions have always found it necessary to begin anew the work of conversion.

To one or other of these causes, or to both, may justly be attributed the little progress which reformed Christianity has made among the Indians of North America; and not to any want of zeal, attention, or liberality, in the directors of the society at home. During the dependence of the United States on the mother-country, great part of the society's funds was properly expended in keeping alive a just sense of religion among the Christian colonists from Europe, who had surely the first claims upon this best of charities; but now that America has separated herself from Great Britain, and shown that she is able to maintain her independence, and to make ample provision for a regular clergy of her own, the members of the corporation must feel themselves at liberty to bestow greater attention, and to expend more money than they could formerly do, on the conversion of such Indians as have any intercourse with the settlements which we still possess. To a body so respectable, we presume not to offer advice; but we cannot help thinking, with Bishop Berkeley, that the most successful missionaries would be children of Indians, educated in a considerable number together from the age of ten or twelve in a college *de propaganda fide*, where they should be in no danger of losing their mother-tongue while they were acquiring a competent knowledge of religion, morality, history, practical mathematics, and agriculture. "If there were a yearly supply (says he) of a dozen such missionaries sent abroad into their respective countries, after they had received the degree of master of arts, and been admitted into holy orders, it is hardly to be doubted but that in a little time the world would see good and great effects of their mission."

2. Society in Scotland for Propagating Christian Know-

ledge, was instituted in the beginning of the present century. At that period the condition of the Scotch Highlanders was truly deplorable. Shut up in desolate islands by tempestuous seas, or dispersed over a wide extent of country, intersected by high mountains, rapid rivers, and arms of the sea, without bridges or highways, by which any communication could be kept open either with remote or neighbouring districts, they lived in small detached companies in hamlets or solitary huts. Being thus secluded from intercourse with the more civilized part of the island, they could not enjoy the advantages of trade and manufactures. As their soil was barren and their climate severe, in agriculture no progress was to be expected: and as they were acquainted with no language but Gaelic, in which no books were then written, to possess knowledge was impossible. Their parishes being of great extent, often 30 or 40 miles long and of a proportionable breadth, and sometimes consisting of several islands separated by seas, which are often impassable, a considerable number of the inhabitants was entirely deprived of religious instruction or fell a prey to Popish emissaries. A single school in such extensive parishes could be of little benefit; yet many parishes were entirely destitute even of this resource; and where schools were established, the want of books prevented them from producing the useful effects otherwise to have been expected from them (A). To all this we must add, that they lived in a state of the greatest oppression: For though the Highlands formed a part of the British empire, the blessings of the British constitution had not reached them. The feudal system reigned in its utmost rigour; the chieftains exercising the most despotic sway over the inferior Highlanders, whom at their pleasure they deprived of their lives or property (B).

Thus the Highlanders were ignorant, oppressed, and uncivilized; slaves rather than subjects; and either entirely destitute of the advantages of the Christian religion, or unqualified to improve them. Hitherto they had been unhappy and useless to themselves and dangerous to the state; for they were ready at the call of their chieftains to issue from their mountains, and to turn their arms against their lawful king and his loyal subjects. This character, however, arose from their situation. It was therefore impossible for benevolent minds to contemplate this unhappy situation of their countrymen without feeling a desire to raise them to the dignity of rational beings, and to render them useful as citizens.

Accordingly, in the year 1701, some private gentlemen of the city of Edinburgh, who had formed themselves into a society for the reformation of manners, directed their attention to the Highlands of Scotland, and endeavoured to devise some plan for alleviating the distresses of the inhabitants. The remedy which promised to be most efficacious was, to establish charity schools in different places. But as the exigency was great, it was no easy matter to raise a sufficient fund for this

Religious  
and Ha-  
man So-  
cieties.

Proposal for  
the better  
supplying of  
Churches in  
our Foreign  
Plantations,  
&c.

(A) Even so late as the year 1758, no fewer than 175 parishes, within the bounds of 39 presbyteries, had no parochial school. We are sorry to add, that even in the present enlightened and benevolent age the complaint is not entirely removed.

(B) The feudal system was at length abolished in the year 1748 by the jurisdiction act.

Highland  
and  
Humble  
Societies.

this purpose. They began therefore with what voluntary subscriptions they could procure, hoping afterwards to increase their capital by vacant stipends and public contributions. A memorial with this view was presented to the General Assembly in 1704, which received their approbation; and they accordingly passed an act, recommending a general contribution. In 1706 the General Assembly appointed some of their number to inquire more carefully into the state of the Highlands, and the year following appointed a select committee to confer with the gentlemen who had suggested the plan. The result of these conferences was the publication of proposals "for propagating Christian knowledge in the Highlands and islands of Scotland, and in foreign parts of the world." Copies of these proposals, with subscription papers, were distributed through the kingdom; and the contributions having soon amounted to L. 1000, her majesty Queen Anne encouraged this infant society by her royal proclamation, and at the same time issued letters patent under the great seal of Scotland for erecting certain of the subscribers into a corporation; the first nomination of whom was lodged with the lords of council and session.

This corporation held its first meeting on Thursday 3d November 1709. It was attended by several of the nobility, fourteen of the lords of session, many gentlemen of rank, together with most of the ministers of the city of Edinburgh and neighbourhood. A president, secretary, and treasurer, with a committee of fifteen directors, were appointed for the dispatch of business. At their second meeting in January 1710, a scheme of management was formed and approved; in which it was proposed, 1. To erect and maintain schools in such places of Scotland, particularly in the Highlands and Islands, as should be found to need them most; in which schools all persons whatsoever should be taught by fit and well qualified schoolmasters, appointed by the society, to read the Holy Scriptures and other pious books; as also to write, and to understand the common rules of arithmetic, with such other things as should be thought suitable to their circumstances. 2. That the schoolmasters should be particularly careful to instruct their scholars in the principles of the Christian reformed religion; and for that end should be obliged to catechise them at least twice a-week, and to pray publicly with them twice a-day. 3. That not only such as were unable to pay should be taught gratis, but that those whose circumstances required it, should have such farther encouragement as the society should think fit in a consistency with their patent. 4. To name some prudent persons, ministers and others, to be overseers of those schools, who should take care that the schoolmasters do their duty, and that the instructions to be given from time to time by the society or their committee be punctually observed; which overseers should make their report to the society quarterly or half-yearly at farthest. 5. To give suitable encouragement to such ministers or catechists as should be willing to contribute their assistance towards the farther instruction of the scholars remote from church, by not only catechising, but preaching to them; which ministers or catechists should take the same care of the other inhabitants as of the scholars. 6. To extend their endeavours for the advancement of the Christian religion to heathen na-

tions; and for that end to give encouragement to ministers to preach the gospel among them.

Having thus formed a plan, they immediately proceeded to establish schools in the most useful and economical manner; and as the capital continued to accumulate, the interest was faithfully applied, and the utility of the institution was more extensively diffused.

Until the year 1738 the attention of the society had been wholly directed to the establishment of schools; but their capital being then considerably augmented, they began to extend their views of utility much farther. The grand object of all public associations ought certainly to be the promoting of religion and morality. It must, however, be evident to every man of reflection, that these can neither be propagated nor preserved among a people without agriculture, unaccustomed to commerce and manufactures, and consequently without labour or exertion. Languor and debility of mind must always be the companions of idleness. While the Highlanders roved about with arms in their hands, the latent vigour of their minds must often have been called forth into action; but when their arms were taken away, and themselves confined to a domestic life, where there was nothing to rouse their minds, they must have sunk into indolence and inactivity. All attempts therefore to instruct them in religion and morality, without introducing among them some of the necessary arts of life, would probably have been unavailing. The society accordingly resolved to adopt what appeared to them the most effectual methods of introducing industry among the Highlanders. But as their patent did not extend far enough, they applied to his majesty George II. for an enlargement of their powers; and accordingly obtained a second patent, by which they are empowered, "besides fulfilling the purposes of their original patent, to cause such of the children as they shall think fit to be bred to husbandry and housewifery, to trades and manufactures, or in such manual occupations as the society shall think proper."

The objects of this second patent the society have not failed to pursue; and though many obstacles and discouragements to their efforts occurred among a rude and barbarous people, yet their perseverance, and the obvious utility of their plans, at length so far overcame the reluctance of the inhabitants, that no less than 94 schools of industry in various parts of the Highlands and islands are now upon their establishment, at which are educated 2360 scholars.

The society, while anxiously endeavouring to diffuse a spirit of industry through the Highlands, were still equally solicitous to promote the knowledge of the Christian religion. As the English language had been the only channel by which knowledge was conveyed to them (a language which, being not used in conversation, was in all respects foreign to them), it was judged requisite that they should have the Scriptures in their vernacular tongue. The society therefore first appointed a translation of the New Testament to be made into Gaelic: A translation was accordingly undertaken by the Rev. Mr Stewart minister of Killin in Perthshire, and printed in 1767, which is said to be executed with much fidelity. Of this work many thousand copies have been distributed in the Highlands. The greater part of the Old Testament has also been translated

Religious  
and  
Humble  
Societies.

Religious  
and Hu-  
mane So-  
cieties.

by the Rev. Dr Smith of Campbelton and others, but chiefly by the Rev. Dr Stewart of Lufs, by the appointment and at the expence of the society: and as soon as the remaining part can be got ready, the whole will be sold at so low a price as the poor may without difficulty afford. This plan the society have judiciously chosen, in order to prevent discontent and murmuring; effects which the diffusion of the Scriptures ought never to produce; but which could not possibly have been prevented, had the ditribution been gratuitous, and of course partial.

For some years past the funds of the society have rapidly accumulated, from the very liberal donations of several individuals.

Lady Glenorchy	-	L. 5,000
By a person unknown	-	10,000
Lord Van Vryhouven of Holland		20,000
Miss Gray of Teafles	-	3,500

In consequence of these great additions to their stock, insinuations have been thrown out that the society have become so wealthy as to be at a loss for proper objects on which to bestow their increased revenue. If such an opinion be *seriously* entertained by any one, we must beg him to remember, that the society have erected and ended no less than 323 schools for religion, the first principles of literature and industry, at the annual expence of L. 3214, 10 s. Sterling; and that at these seminaries are educated from 14,000 to 15,000 children; who, but for the means of instruction thus obtained, would in all probability be bred up in ignorance and idleness: That they employ 12 missionary ministers and catechists in remote parts of the Highlands and islands, or among the ignorant Highlanders settled in the great towns of Scotland, at the annual expence of L. 296: That they bestow a burfary or pension of L. 15 *per annum* on each of six students of divinity having the Gaelic language: That they employ two missionary ministers and one schoolmaster among the Oneida and Stockbridge Indians of North America (being the destination of certain legacies bequeathed to them for that purpose), at the annual expence of L. 140. Such is their fixed scheme of annual expenditure, amounting in all to L. 3740, 10 s. Sterling—a sum it will be acknowledged of very considerable magnitude. The whole of their incidental expences arising from the Gaelic translation of the Scriptures of the Old Testament; from annuities which they have to pay, in consequence of sums left them as residuary legatees; from land and house-taxes; from enabling candidates for the office of schoolmaster to come to Edinburgh for examination; from furnishing books to poor scholars in their various schools; and from removing schoolmasters from one station to another, is generally about L. 875, which added to the former sum makes the whole annual expence amount to L. 4615, 10 s.

If it be inquired at what expence, in the *management* of it, this extensive and complicated charity is annually conducted, we are authorised to say, that the treasurer,

bookholder, and clerk, are allowed each L. 25 *per annum*, the same salaries which were annexed to these offices from the commencement of the society. The beadle or officer is allowed L. 12 *per annum*. No salary whatever is enjoyed by any of the other officers of the society. The secretary, comptroller, accountant, and librarian, although subjected, some of them especially, to no small expence of time and labour, have no pecuniary recompense or emolument. Theirs are labours of love, for which they seek and expect no other reward than the consciousness of endeavouring to promote the best interests of mankind. The whole amount of the expence of managing the business of the society, including the above salaries, and coats, candle, stationery ware, postages, and other incidents, exceeds not at an average L. 115 *per annum*. From this statement it appears, that hitherto at least the directors have been at no loss for important objects within the proper sphere of their institution on which to bestow their increased funds. They have, it is true, the disposal of very considerable sums for promoting the objects of the institution; but they are so far from accumulating wealth, that every year their expenditure, notwithstanding the late increase of their capital, exceeds rather than falls short of their income. They have depended upon a kind Providence and a generous public to refund these anticipations of their revenue, and hitherto they have never been disappointed.

Thus has the Society for Propagating Christian Knowledge proceeded for almost a century. It was founded by the pious exertions of a few private individuals, whose names are unknown to the world; and its funds, by faithful and judicious management, as well as by generous contributions, have now become of such magnitude, as to excite the hope that they will be productive of the most valuable effects. The benefits arising from public societies, it is well known, depend entirely upon the management of their directors. If so, the advantages which have accrued from this society intitle it to the praise and gratitude of the nation. While eager to increase the number of schools, the society have not been inattentive to their prosperity. In the year 1771 Mr Lewis Drummond, a gentleman in whom they placed great confidence, was commissioned by them to visit their schools, and to make an exact report of their state and circumstances. Again, in the year 1790, a commission was granted to the Rev. Dr Kemp, one of the ministers of Edinburgh and secretary to the society, to visit all the schools on their establishment. This laborious and gratuitous task he accomplished in the course of four summers with much ability and care, and highly to the satisfaction of the society. At his return he communicated a variety of important information respecting the state of the Highlands and islands, and the means necessary for their improvement in religion, literature, and industry; an abstract of which was published by the society in appendixes to the anniversary sermons preached before them in the years 1789, 90, 91, and 92 (c).

The

(c) It is well known, that the number of Roman Catholics in the Highlands is considerable; but it must give much pleasure to the Protestant reader to be informed, that the ancient malignant spirit of Popery has in that district given place to mildness and liberality. This is chiefly owing to the gentleman who superintends the priests in that quarter, whose mind is enlightened by science and learning. So far from being hostile to the

views

Religious  
and Hu-  
mane So-  
cieties.



The following table will exhibit at a glance the funds, establishment, and expenditure, of the society, from a few years after its commencement to the present time. Where the number of scholars is not mentioned, the defect may be supplied by taking an average from those years where a computation has been made. Where the capital is not mentioned, it may easily be made out by considering the salaries as the interest.

A. D.	Capital.	Schools.	Scholars.
1713		12	
1715	L. 6,177	25	
1719	8,168	48	
1727	9,151	78	2757
1732	13,318	109	
1742	19,287	128	
1753	24,308	152	
1758	28,413	176	6409
1781	34,000	180	7000
	Salaries		
1793	3,080	307	12,913
1794	3,214	323	14,370

Hitherto we have taken no notice of the corresponding board which was established at London so early as the year 1729, to receive subscriptions and lay out funds. That board indeed remained long inactive; but in 1773 its members began to co-operate more cordially with their brethren in Scotland. Since that period an annual sermon has been preached in recommendation of the charity; and the preacher is now selected without any regard to the religious denomination to which he belongs; sometimes from the church of England, sometimes from the church of Scotland, and sometimes from sectaries of different persuasions. The meetings of the correspondent board have been attended by many of the nobility and gentry, who have made great exertions to promote the views of the society. From its present flourishing state therefore, from the indefatigable exertion and laudable zeal of the managers, and from the countenance and support which they have received from persons of the first rank and respectability in the nation, the benevolent mind may look forward with much confidence and satisfaction to a period not very distant, when its beneficial effects shall be felt not only in the Highlands, but shall be communicated to the rest of the nation. We have been thus particular in our account of the Society for Propagating Christian Knowledge, because we have had access to the most authentic sources of information, and because we know it to be an institution calculated to enlighten and improve a considerable part of the British nation.

3. *Society of the Sons of the Clergy*, was incorporated by King Charles II. in 1678, by the name of *The Governors of the Charity for Relief of the Poor Widows and Children of Clergymen*. This society is under the direction and management of a president and vice-president, three treasurers, and a court of assistants composed of forty members. Several hundreds of widows and chil-

dren of the clergy have annually received considerable relief from this useful charity.

4. *Society for the Sons of the Clergy of the Established Church of Scotland*, was instituted at Edinburgh in February 1790, and was constituted a body corporate by his majesty's royal charter in 1792. The society, after several meetings, are of opinion, that the period in which the families of clergymen feel most urgently the need both of friends and of pecuniary aid, is that which commences with the introduction of the sons either to an university or to business, and terminates with their establishment in their respective professions; that many of the ministers of this church, living at great distances from the seats either of universities or of business, possess incomes which, in the present state of the country, are inadequate to the purposes of procuring for their sons either the literary or professional education which might enable them to come forward with credit and success in the world; that the sons of clergymen, from domestic tuition and example, have in general very advantageous means of receiving in their early years the impressions of virtue and honour, together with the rudiments of liberal knowledge; and that of course the public interest may be promoted, by enabling this class of young men to obtain their share in the respectable situations of life. The views of the society have been limited to the sons only of clergymen; as they are of opinion, that within the limits which they have fixed, the field of beneficence will be still very extensive, and the claims for aid as many and as great as their funds can be supposed able to answer, at least for many years to come. If the society shall ever be in a situation to undertake more than the aids which will be necessary in bringing forward the sons of the clergy, it may then be considered in what manner the daughters also may become sharers in its bounty.

5. *Royal Humane Society*, was instituted in London in 1774, for the recovery of persons drowned or otherwise suffocated. We have already given some account of societies instituted in other counties with the same views, and have also copied the directions of this society for the recovery of life, for which see the article DROWNING. We have therefore only to state, that the plan of this society is so adverse to any private interested views, that it acquires its founders of all sordid motives. For the medical practitioners accept no pecuniary recompense for the time which they devote to a difficult and tedious process; for the anxiety which they feel while the event is doubtful; for the mortification which they too often undergo, when death, in spite of all their efforts, at last carries off his prey; nor for the insults to which they willingly expose themselves from vulgar incredulity. Their sole reward is in the holy joy of doing good. Of an institution thus free in its origin from the suspicion of ambitious views, and in its plan renouncing self-interest in every shape, philanthropy must be the only basis. The good intention therefore of the society is proved by its constitution; the

views of the society, he recommended to his clergy to promote them. They accordingly received the secretary with much politeness; exhorted the people to send their children to the Protestant schools to be instructed in literature, to be taught to read the Scriptures in their own language, and to be made acquainted with those great principles of religion in which all Christians are agreed. What a blessed reformation!

Religious  
and Hu-  
mane So-  
cieties.

the wisdom and utility of the undertaking are proved by its success: not less than 3000 fellow-creatures having since its commencement been (1791) restored to the community by its timely and indefatigable exertions. For it is to be observed, that the benefit of this society is by no means confined to the two cases of drowning and suspension. Its timely succours have roused the lethargy of opium taken in immoderate and repeated doses; they have rescued the wretched victims of intoxication; rekindled the life extinguished by the sudden stroke of lightning; recovered the apoplectic; restored life to the infant that had lost it in the birth; they have proved efficacious in cases of accidental smothering and of suffocation by noxious damps; in instances in which the tenderness of the infant body or the debility of old age greatly lessened the previous probability of success; inasmuch that no species of death seems to be placed beyond the reach of this society's assistance, where the mischief had gone no farther than an obstruction of the movements of the animal machine without any damage of the organs themselves. In consequence of every necessary assistance afforded by this society, similar institutions have been established at Algiers, Lisbon, Philadelphia, Boston, Jamaica, Dublin, Leith, Glasgow, Aberdeen, Birmingham, Gloucester, Shropshire, Northamptonshire, Lancaster, Bristol, Whitehaven, Norwich, Exeter, Kent, and Newcastle. The society has published an 8vo volume with plates, consisting of cases, correspondence, and a variety of interesting matter relating to the object of this benevolent institution.

6. *The Philanthropic Society*, was instituted in September 1788. It aims at the prevention of crimes, by removing out of the way of evil counsel, and evil company, those children who are, in the present state of things, destined to ruin. It proposes to educate and instruct in some useful trade or occupation the children of convicts or other infant poor who are engaged in vagrant or criminal courses; thus to break the chain of those pernicious confederacies, deprive the wicked of successors, the goals of inhabitants, justice of its victims, and by all these means add citizens to society. This institution is not only calculated to decrease vice and infamy, but to increase useful industry; so that those children who would otherwise succeed to their parents hereditary crimes, and become the next race of beggars and thieves, will now be taught to supply by honest means their own wants and the wants of others.

To carry into effect these desirable purposes, it is the first business of the society to select from prisons, and from the haunts of vice, profligacy, and beggary, such objects as appear most likely to become obnoxious to the laws, or prejudicial to the community; and, in the execution of this duty, the assistance of the magistrates, the clergy, and all who are interested in the promotion of good morals and good government, is most earnestly requested. For the employment of the children, several houses are supported, at Cambridge Heath, near Hackney, in each of which a master-workman is placed for the purpose of teaching the children some useful trade. The trades already established are those of a printer, carpenter, shoemaker, and taylor. The girls are at present educated as menial servants.

In the year 1791 no less than 70 children were un-

der the protection of this society, among whom were many who have been guilty of various felonies, burglaries, and other crimes. Yet, singular as it may appear, in less than two years those very children became no less remarkable for industry, activity, decency, and obedience, than they formerly were for the contrary vices. Such are the grounds on which the Philanthropic Society now claims the attention and solicits the patronage of the public. If we regard humanity and religion, this institution opens an asylum to the most forlorn and abject of the human race; it befriends the most friendless; it saves from the certain and fatal consequences of infamy and vicious courses orphans and deserted children. If we regard national prosperity and the public welfare, it is calculated to increase industry; and it directs that industry into the most useful and necessary channels. If we regard self-interest, its immediate object is to protect our persons from assault and murder, our property from depredation, and our peaceful habitations from the desperate fury of midnight incendiaries.

One guinea *per annum* constitutes a member of the society; and L. 10 at one payment a member for life. A life-subscription, or an annual payment of at least two guineas, is a necessary qualification for being elected into the committee.

## II. SOCIETIES FOR PROMOTING SCIENCE AND LITERATURE.

1. *The Royal Society of London* is an academy or body of persons of eminent learning, instituted by Charles II. for the promoting of natural knowledge. The origin of this society is traced by Dr Sprat, its earliest historian, no farther back than to "some space after the end of the civil wars" in the last century. The scene of the first meetings of the learned men who laid the foundation of it, is by him fixed in the university of Oxford at the lodgings of Dr Wilkins warden of Wadham college. But Dr Birch, on the authority of Dr Wallis, one of its earliest and most considerable members, assigns it an earlier origin. According to him, certain worthy persons, residing in London about the year 1645, being "inquisitive into natural and the new and experimental philosophy, agreed to meet weekly on a certain day, to discourse upon such subjects, and were known by the title of *The Invisible or Philosophical College*." In the years 1648 and 1649, the company who formed these meetings were divided, part retiring to Oxford and part remaining in London; but they continued the same pursuits as when united, corresponding with each other, and giving a mutual account of their respective discoveries. About the year 1659 the greater part of the Oxford society returned to London, and again uniting with their fellow-labourers, met once, and not twice, a-week at Gresham college, during term time, till they were scattered by the public distractions of that year, and the place of their meeting made a quarter for soldiers. On the restoration 1660 their meetings were revived, and attended by a greater concourse of men eminent for their rank and learning. They were at last taken notice of by the king, who having himself a considerable taste for physical science, was pleased to grant them an ample charter, dated the 15th of July 1662, and afterwards a second dated 15th April 1763, by which they were erected into a corporation,

Societies for  
Promoting  
Science and  
Literature.

eries for  
omoting  
ence and  
erature.

ration, consisting of a president, council, and fellows, for promoting natural knowledge; and to give their investigations, against which strange prejudices were entertained, every possible support, he sometimes honoured their meetings with his presence.

Their manner of electing fellows is by balloting. Their council are in number 21, including the president, vice-president, treasurer, and two secretaries; 11 of which are continued for the next year, and 10 more added to them; all chosen on St Andrew's day. Each member at his admission subscribes an engagement that he will endeavour to promote the good of the society; from which he may be freed at any time, by signifying to the president that he desires to withdraw. The charges have been different at different times, and were at first irregularly paid; but they are now five guineas paid to the treasurer at admission; and 13 s. per quarter so long as the person continues a member: or, in lieu of the annual subscription, a composition of 25 guineas in one payment.

Their design is, to "make faithful records of all the works of nature or art which come within their reach; so that the present as well as future ages may be enabled to put a mark on errors which have been strengthened by long prescription; to restore truths that have been neglected; to push those already known to more various uses; to make the way more passable to what remains unrevealed," &c. To this purpose they have made a great number of experiments and observations on most of the works of nature; and also numbers of short histories of nature, arts, manufactures, useful engines, contrivances, &c. The services which they have rendered to the public are very great. They have improved naval, civil, and military architecture; advanced the security and perfection of navigation; improved agriculture; and put not only this kingdom, but also Ireland, the plantations, &c. upon planting. They have registered experiments, histories, relations, observations, &c. and reduced them into one common flock; and have, from time to time, published those which they reckoned most useful, under the title of *Philosophical Transactions*, &c. and laid the rest up in public registers, to be nakedly transmitted to posterity, as a solid groundwork for future systems.

They have a library adapted to their institution; towards which Mr Henry Howard, afterwards duke of Norfolk, contributed the Norfolkian library, and which is, at this time, greatly increased by a continual series of benefactions. The museum or repository of natural and artificial rarities, given them by Daniel Colwal, Esq; and since enriched by many others, is now removed to the British museum, and makes a part of that great repository. Their motto is *Nullius in verba*; and their place of assembling is Somerset-house in the Strand. Sir Godfrey Copley, baronet, left five guineas to be given annually to the person who should write the best paper in the year, under the head of experimental philosophy. This reward, which is now changed to a gold medal, is the highest honour the society can bestow. It is conferred on St Andrew's day.

2. *The Royal Society of Edinburgh*, was incorporated by royal charter on the 29th of March 1783, and has for its object the cultivation of every branch of science, erudition, and taste. Its rise and progress towards its present state was as follows: In the year 1718 a literary

society was established in Edinburgh by the learned Ruddiman and others, which in 1731 was succeeded by a society instituted for the improvement of medical knowledge. In the year 1739 the celebrated Mac-laurin conceived the idea of enlarging the plan of this society, by extending it to subjects of philosophy and literature. The institution was accordingly new-modelled by a printed set of laws and regulations, the number of members was increased, and they were distinguished from that time by the title of *The Society for Improving Arts and Sciences*, or more generally by the title of *The Philosophical Society of Edinburgh*. Its meetings, however, were soon interrupted by the disorders of the country during the rebellion in 1745; and they were not renewed till the year 1752. Soon after this period the first volume of the *Transactions of the Philosophical Society of Edinburgh* was published, under the title of *Essays and Observations, Physical and Literary*, and was followed by other volumes of acknowledged merit. About the end of the year 1781, in a meeting of the professors of the university of Edinburgh, many of whom were likewise members of the Philosophical Society, and warmly attached to its interests, a scheme was proposed by the Rev. Dr Robertson, principal of the university, for the establishment of a new society on a more extended plan, and after the model of some of the foreign academies. It appeared an expedient measure to solicit the royal patronage to an institution of this nature, which promised to be of national importance, and to request an establishment by charter from the crown. The plan was approved and adopted; and the Philosophical Society, joining its influence as a body in seconding the application from the university, his majesty, as we have already observed, was most graciously pleased to incorporate The Royal Society of Edinburgh by charter.

This society consists of ordinary and honorary members; and the honorary places are restricted to persons residing out of Great Britain and Ireland. The election of new members is appointed to be made at two stated general meetings, which are to be held on the fourth Monday of January and the fourth Monday of June. A candidate for the place of an ordinary member must signify by a letter, addressed to one of the members, his wish to be received into the society. He must then be publicly proposed at least a month before the day of election. If the proposal be seconded by two of the members present, his name is to be inserted in the list of candidates, and hung up in the ordinary place of meeting. The election is made by ballot, and is determined in favour of a candidate, if he shall have the votes of two thirds of those present, in a meeting consisting of at least 21 members. The general business of the society is managed by a president, two vice-presidents, with a council of 12, a general secretary, and a treasurer. These officers are chosen by ballot annually on the last Monday of November. All public deeds, whether of a civil or of a literary nature, are transacted by this board, and proceed in the name of the president or vice president.

As it was thought that the members would have a greater inducement to punctual attendance on the meetings of the society, if they had some general intimation of the nature of the subjects which were to be considered, and made the topics of conversation, it was there-

Society for  
Promoting  
Science and  
Literature.

Societies for  
Promoting  
Science and  
Literature.

fore resolved to divide the society into two classes, which should meet and deliberate separately. One of these classes is denominated the *Physical Class*, and has for its department the sciences of mathematics, natural philosophy, chemistry, medicine, natural history, and whatever relates to the improvement of arts and manufactures. The other is denominated the *Literary Class*, and has for its department literature, philology, history, antiquities, and speculative philosophy. Every member is desired at his admission to intimate which of those classes he wishes to be more particularly associated with; but he is at the same time intitled to attend the meetings of the other class, and to take part in all its proceedings. Each of the classes has four presidents and two secretaries, who officiate by turns. The meetings of the physical class are held on the first Mondays of January, February, March, April, July, August, November, and December; and the meetings of the Literary class are held on the third Mondays of January, February, March, April, June, July, November, and December, at 7 o'clock afternoon.

At these meetings the written essays and observations of the members of the society, or their correspondents, are read publicly, and become the subjects of conversation. The subjects of these essays and observations are announced at a previous meeting, in order to engage the attendance of those members who may be particularly interested in them. The author of each dissertation is likewise desired to furnish the society with an abstract of it, to be read at the next ensuing meeting, when the conversation is renewed with increased advantage, from the knowledge previously acquired of the subject. At the same meetings are exhibited such specimens of natural or artificial curiosities, such remains of antiquity, and such experiments, as are thought worthy of the attention of the society. All objects of natural history presented to the society, are ordered by the charter of the institution to be deposited, on receipt, in the museum of the university of Edinburgh; and all remains of antiquity, public records, or ancient manuscripts, in the library belonging to the faculty of advocates at Edinburgh.

The ordinary members, whose usual residence is in the city of Edinburgh or its immediate neighbourhood, are expected to attend regularly the monthly meetings; and are required to defray, by an annual contribution, the current expences of the institution. The members who reside at such a distance from Edinburgh, that they cannot enjoy the advantages arising from a regular attendance on the meetings of the society, are not subjected to any contribution for defraying its expences, but have a right to attend those meetings when occasionally in Edinburgh, and to take part in all their proceedings.

Three volumes of the Transactions of the society have been published, which bear ample testimony to the learning and acuteness of their various authors.

3. *Medical Society* of London, instituted in the year 1752, on the plan recommended by Lord Bacon (*De Augm. Scient.* lib. iv. cap. 2.) to revive the Hippocratic method of composing narratives of particular cases, in which the nature of the disease, the manner of treating it, and the consequences, are to be specified; to attempt the cure of those diseases which, in his opinion, have been too boldly pronounced incurable; and, last-

ly, to extend their inquiries after the powers of particular medicines in the cure of particular cases; the collections of this society have been already published, under the title of *Medical Observations and Inquiries*, in several volumes.

Societies for  
Promoting  
Science and  
Literature.

4. *The Medical Society* of Edinburgh was incorporated by royal charter in 1778; but there appears to have been in that city a voluntary association of the same name from the first establishment of a regular school of physic in the university. To the voluntary society the public is indebted for six volumes of curious and useful essays, collected principally by the late Dr Monro from June 1731 to June 1736; but in the year 1739 that society was united to another, as we have already observed in a former article. The ordinary members of the present medical society are elected by ballot, and three dissentient exclude a candidate; an ordinary member may also be elected an honorary member, who enjoys the privileges of the others, and receives a diploma, but is freed from the obligation of attendance, delivering papers in rotation, &c. to which the ordinary members are subject; but in this case the votes must be unanimous. The meetings of this society are held every Saturday evening in their own hall, during the winter season, when papers on medical subjects are delivered by the several members in rotation; and four of these are annually elected to fill the chair in rotation, with the title of annual presidents.

5. *The Royal Medical Society* of Paris was instituted in 1776. The members are divided into associates ordinary, limited to 30, honorary to 12, extraordinary to 60, and foreign to 60, and correspondents. This society has published several volumes of Memoirs in 4to.

6. *Asiatic Society*, an institution planned by the late illustrious Sir William Jones, and actually formed at Calcutta on the 15th of January 1784, for the purpose of tracing the history, antiquities, arts, sciences, and literature, of the immense continent of Asia. As it was resolved to follow as nearly as possible the plan of the *ROYAL SOCIETY* of London, of which the king is *patron*, the patronage of the Asiatic Society was offered to the governor-general and council, as the executive power in the territories of the company. By their acceptance of this offer, Mr Hastings, as governor-general, appeared among the patrons of the new society; "but he seemed in his private station as the first liberal promoter of useful knowledge in Bengal, and especially as the great encourager of Persian and Shanscrit literature, to deserve a particular mark of distinction:" he was requested, therefore, to accept the honorary title of president. This was handsomely declined in a letter from Mr Hastings, in which he requested "to yield his pretensions to the gentleman whose genius planned the institution, and was most capable of conducting it to the attainment of the great and splendid purposes of its formation." On the receipt of this letter, Sir William Jones was nominated president of the society; and we cannot give the reader a view of the object of the institution in clearer language than that which he employed in his first discourse from the chair.

"It is your design, I conceive (said the president), to take an ample space for your learned investigations, bounding them only by the geographical limits of Asia; so that, considering Hindollan as a centre, and turning your eyes in idea to the north, you have on your right  
many

many important kingdoms in the eastern peninsula, the ancient and wonderful empire of China with all her Tartarian dependencies, and that of Japan, with the cluster of precious islands, in which many singular curiosities have too long been concealed: before you lies that prodigious chain of mountains, which formerly perhaps were a barrier against the violence of the sea, and beyond them the very interesting country of Tibet, and the vast regions of Tartary, from which, as from the Trojan horse of the poets, have issued so many consummate warriors, whose domain has extended at least from the banks of the Ilysus to the mouths of the Ganges: on your left are the beautiful and celebrated provinces of Iran or Persia, the unmeasured and perhaps unmeasurable deserts of Arabia, and the once flourishing kingdom of Yemen, with the pleasant isles that the Arabs have subdued or colonized; and farther westward, the Asiatic dominions of the Turkish sultans, whose moon seems approaching rapidly to its wane. By this great circumference the field of your useful researches will be inclosed; but since Egypt had unquestionably an old connection with this country, if not with China, since the language and literature of the Abyssinians bear a manifest affinity to those of Asia, since the Arabian arms prevailed along the African coast of the Mediterranean, and even erected a powerful dynasty on the continent of Europe, you may not be displeased occasionally to follow the streams of Asiatic learning a little beyond its natural boundary; and, if it be necessary or convenient that a short name or epithet be given to our society, in order to distinguish it in the world, that of *Asiatic* appears both classical and proper, whether we consider the place or the object of the institution, and preferable to *Oriental*, which is in truth a word merely relative, and though commonly used in Europe, conveys no very distinct idea.

“It now it be asked, What are the intended objects of our inquiries within these spacious limits? we answer, MAN and NATURE; whatever is performed by the *one* or produced by the *other*. Human knowledge has been elegantly analysed according to the three great faculties of the mind, *memory*, *reason*, and *imagination*, which we constantly find employed in arranging and retaining, comparing and distinguishing, combining and diversifying, the ideas, which we receive through our senses, or acquire by reflection: hence the three main branches of learning are, *history*, *science*, and *art*; the first comprehends either an account of natural productions, or the genuine records of empires and states; the second embraces the whole circle of pure and mixed mathematics, together with ethics and law, as far as they depend on the reasoning faculty; and the third includes all the beauties of imagery and the charms of invention, displayed in modulated language, or represented by colour, figure, or sound.

“Agreeably to this analysis, you will investigate whatever is rare in the stupendous fabric of nature, will correct the geography of Asia by new observations and discoveries; will trace the annals and even traditions of those nations who from time to time have peopled or desolated it; and will bring to light their various forms of government, with their institutions civil and religious; you will examine their improvements and methods in arithmetic and geometry; in trigonometry, mensuration, mechanics, optics, astronomy, and general phy-

tics; their systems of morality, grammar, rhetoric, and dialectic; their skill in chirurgery and medicine; and their advancement, whatever it may be, in anatomy and chemistry. To this you will add researches into their agriculture, manufactures, trade; and whilst you inquire with pleasure into their music, architecture, painting, and poetry, will not neglect those inferior arts by which the comforts and even elegancies of social life are supplied or improved. You may observe, that I have omitted their languages, the diversity and difficulty of which are a sad obstacle to the progress of useful knowledge; but I have ever considered languages as the mere instruments of real learning, and think them improperly confounded with learning itself: the attainment of them is, however, indispensably necessary; and if to the Persian, Armenian, Turkish, and Arabic, could be added not only the Sanscrit, the treasures of which we may now hope to see unlocked, but even the Chinese, Tartarian, Japanese, and the various insular dialects, an immense mine would then be open, in which we might labour with equal delight and advantage.”

Of this society three volumes of the *Transactions* have been published, which are replete with information in a high degree curious and important; and we hope that the European world shall soon be favoured with another. The much to be lamented death of the accomplished president may indeed damp the spirit of investigation among the members; for to conquer difficulties so great as they must meet with, a portion seems to be necessary of that enthusiasm which accompanied all the pursuits of Sir William Jones; but his successor is a man of great worth and learning, and we trust will use his utmost endeavours to have the plan completed of which Sir William gave the outlines.

5. *The American Philosophical Society*, held at Philadelphia, was formed in January 1769 by the union of two societies which had formerly subsisted in that city. This society extends its attention to geography, mathematics, natural philosophy, and astronomy; medicine and anatomy; natural history and chemistry; trade and commerce; mechanics and architecture; husbandry and American improvements. Its officers are a patron, president, three vice-presidents, one treasurer, four secretaries, and three curators, who are annually chosen by ballot. The duty of the president, vice-presidents, treasurer, and secretaries, is the same as in other societies. The business of the curators is to take the charge of all specimens of natural productions, whether of the animal, vegetable, or fossil kingdom; all models of machines and instruments; and all other matters belonging to the society which shall be intrusted to them. The ordinary meetings are held on the first and third Fridays of every month from October to May inclusive. This society was incorporated by charter 15th March 1780; and has published three volumes of its *Transactions*, containing many ingenious papers on general literature and the sciences, as well as respecting those subjects peculiar to America. It is a delightful prospect to the philosopher to consider, that Asia, Europe, and America, though far separated and divided into a variety of political states, are all three combined to promote the cause of knowledge and truth.

6. *A Literary and Philosophical Society* of considerable reputation has been lately established at Manchester, under the direction of two presidents, four vice-presidents,

eties for  
moting  
nce and  
rature.

Societies for  
Promoting  
Science and  
Literature.

Societies for  
Promoting  
Science and  
Literature.

dents, and two secretaries. The number of members is limited to 50; besides whom there are several honorary members, all of whom are elected by ballot; and the officers are chosen annually in April. Four volumes of valuable essays have been already published by this society.

7. *Society for Promoting the Discovery of the Interior Parts of Africa.* This society or association for exploring the internal districts of Africa, of which so little is at present known, was formed in London by some opulent individuals in 1788; who, strongly impressed with a conviction of the practicability and utility of thus enlarging the fund of human knowledge, determined if possible to rescue the age from that stigma which attaches to its ignorance of so large and so near a portion of the globe. The founders of this society resolved to admit no man a member for a shorter period than three years, during which he must pay annually into the public fund five guineas. After three years, any member, upon giving a year's notice, may withdraw himself from the association. During the first 12 months each of the members was allowed to recommend for the approbation of the society such of his friends as he might think proper to be admitted into it; but since that period we believe all additional members have been elected by a ballot of the association at large. A committee was chosen by ballot to manage the funds of the society, to choose proper persons to be sent on the discovery of the interior parts of Africa, and to carry on the society's correspondence, with express injunctions to disclose no intelligence received from their agents but to the society at large. But a fuller account of the nature of this establishment, and the very happy efforts they have made, may be seen in the superb edition of their proceedings printed in 1790, 4to, for their own use; or in the 8vo edition since made public. They soon found two gentlemen, Mr Lucas and Mr Ledyard, who were singularly well qualified for the important mission. The information they have acquired will be found in the above work; with a new map by Mr Rennel, exhibiting the geographical knowledge collected by the African association. Mr Ledyard very unfortunately died during his researches at Cairo.

8. *The Society of Antiquaries of London*, was founded about the year 1572 by Archbishop Parker, a munificent patron of learned men. For the space of 20 years it assembled in the house of Sir Robert Cotton; in 1589 they resolved to apply to Queen Elizabeth for a charter and a public building where they might hold their meetings; but it is uncertain whether any such application was ever made. In the mean time, the reputation of the society gradually increased, and at length it excited the jealousy of James I. who was afraid lest it should presume to canvass the secret transactions of his government. He accordingly dissolved it. But in the beginning of the present century, the Antiquarian Society began to revive; and a number of gentlemen, eminent for their affection to this science, had weekly meetings, in which they examined the antiquities and history of Great Britain preceding the reign of James I. but without excluding any other remarkable antiquities that might be offered to them. From this time the society grew in importance; and in 1750 they unanimously resolved to petition the king for a charter or incorporation. This they obtained the year following, by

the influence of the celebrated earl of Hardwicke, then lord chancellor, and Martin Folkes, Esq; who was then their president. The king declared himself their founder and patron, and empowered them to have a body of statutes, and a common seal, and to hold in perpetuity lands, &c. to the yearly value of L. 1000.

The chief object of the inquiries and researches of the society are British antiquities and history; not, however, wholly excluding those of other countries. It must be acknowledged, that the study of antiquity offers to the curious and inquisitive a large field for research and amusement. The inquirer in this branch furnishes the historian with his best materials, while he distinguishes the historian from the fictions of a bold invention, and ascertains the credibility of facts; and to the philosopher he presents a fruitful source of ingenious speculation, while he points out to him the way of thinking, and the manners of men, under all the varieties of aspect in which they have appeared.

An antiquarian ought to be a man of solid judgment, possessed of learning and science, that he may not be an enthusiastic admirer of every thing that is ancient merely because it is ancient; but be qualified to distinguish between those researches which are valuable and important, and those which are trifling and useless. It is from the want of these qualifications that some men have contracted such a blind passion for every thing that is ancient, that they have exposed themselves to ridicule, and their study to contempt. But if a regard to utility were always to regulate the pursuits of the antiquarian, the shafts of satire would no longer be levelled at him; but he would be respected as the man who labours to restore or to preserve such ancient productions as are suited to illuminate religion, philosophy, and history, or to improve the arts of life.

We by no means intend to apply these observations to any particular society of antiquarians; but we throw them out, because we know that an assiduous study of antiquity is apt, like the ardent pursuit of money, to lose sight of its original object, and to degenerate into a passion which mistakes the mean for the end, and considers possession without a regard to utility as enjoyment.

An association similar to that of the Antiquarian Society of London was founded in *Edinburgh* in 1780, and received the royal charter in 1783.

Besides these literary societies here mentioned, there are a great number more in different parts of Europe, some of which are noticed under the article *ACADEMY*. Those which are omitted are not omitted on account of any idea of their inferior importance; but either because we have had no access to authentic information, or because they resemble the societies already described so closely, that we could have given nothing but their names.

### III. SOCIETIES FOR ENCOURAGING AND PROMOTING ARTS, MANUFACTURES, &c.

1. *London Society for the Encouragement of Arts, Manufactures, and Commerce*, was instituted in the year 1754 by Lord Falkstone, Lord Romney, Dr Stephen Hales, and a few private gentlemen; but the merit of this institution chiefly belonged to Mr William Shipley,

Societies for an ingenious mechanic; who, though deriving no advantages from learning, by unwearied personal attendance found means to engage a few persons of rank and fortune to meet at Peckle's coffeehouse in Fleetstreet, and to adopt a plan for promoting arts and manufactures.

No person shall receive any premium, bounty, or encouragement, from the society for any matter for which he has obtained or proposes to obtain a patent. No member of this society shall be a candidate for or intitled to receive any premium, bounty, or reward whatsoever, except the honorary medal of the society.

The office-bearers of this society are a president, 12 vice-presidents, a secretary, and register. Their proceedings are regulated by a body of rules and orders established by the whole society, and printed for the use of the members. All questions and debates are determined by the holding up of hands, or by ballot if required; and no matter can be confirmed without the assent of a majority at two meetings. They invite all the world to propose subjects for encouragement; and whatever is deemed deserving attention, is referred to the consideration of a committee, which, after due inquiry and deliberation, make their report to the whole society, where it is approved, rejected, or altered. A list is printed and published every year of the matters for which they propose to give premiums; which premiums are either sums of money, and those sometimes very considerable ones; or the society's medal in gold or silver, which they consider as the greatest honour they can bestow. All possible care is taken to prevent partiality in the distribution of their premiums, by desiring the claimants names to be concealed, and by appointing committees (who when they find occasion call to their assistance the most skilful artists) for the strict examination of the real merit of all matters and things brought before them, in consequence of their premiums.

The chief objects of the attention of the Society for the Encouragement of Arts, Manufactures, and Commerce, in the application of their rewards, are ingenuity in the several branches of the polite and liberal arts, useful discoveries and improvements in agriculture, manufactures, mechanics, and chemistry, or the laying open of any such to the public; and, in general, all such useful inventions, discoveries, or improvements (though not mentioned in the book of premiums), as may appear to have a tendency to the advantage of trade and commerce.

The following are some of the most important regulations of this society. It is required that the matters for which premiums are offered be delivered in without names, or any intimation to whom they belong; that each particular thing be marked in what manner each claimant thinks fit, such claimant sending with it a paper sealed up, having on the outside a corresponding mark, and on the inside the claimant's name and address; and all candidates are to take notice, that no claim for a premium will be attended to, unless the conditions of the advertisement are fully complied with. No papers shall be opened but such as shall gain premiums, unless where it appears to the society absolutely necessary for the determination of the claim: all the rest shall be returned unopened, with the matters to which they belong, if inquired after by the marks within two years; after which time, if not demanded, they shall be publicly burnt unopened at some meeting of the society. All the premiums of this society are designed for that part of Great Britain called England, the dominion of Wales, and the town of Berwick upon Tweed, unless expressly mentioned to the contrary.

The respectability of the members who compose it may be seen by perusing the list which generally accompanies their Transactions. In the last volume (vol. xii.) it occupies no less than 43 pages. Some idea may be formed of the wealth of this society, by observing that the list of their premiums fills 96 pages, and amounts to 250 in number. These consist of gold medals worth from 30 to 50, and in a few instances to 100, guineas; and silver medals valued at 10 guineas.

This society is one of the most important in Great Britain. Much money has been expended by it, and many are the valuable effects of which it has been productive. Among these we reckon not only the discoveries which it has excited, but the institution of other societies on the same principles to which it has given birth; and we do not hesitate to conclude, that future ages will consider the founding of this society as one of the most remarkable epochs in the history of the arts. We contemplate with pleasure the beneficial effects which must result to this nation and to mankind by the diffusion of such institutions; and rejoice in the hope that the active minds of the people of Great Britain, instead of being employed as formerly in controversies about religion, which engender strife, or in discussions concerning the theory or politics, which lead to the adoption of schemes inconsistent with the nature and condition of man, will soon be more generally united into associations for promoting useful knowledge and solid improvement, and for alleviating the distresses of their fellow-creatures.

2. *Society instituted at Bath for the Encouragement of Agriculture, Arts, Manufactures, and Commerce.* It was founded in the year 1777 by several gentlemen who met at the city of Bath. This scheme met with a very favourable reception both from the wealthy and learned. The wealthy subscribed very liberally, and the learned communicated many important papers. On application to the London and provincial societies instituted for the like purposes, they very politely offered their assistance. Seven volumes of their transactions have already been published, containing very valuable experiments and observations, particularly respecting agriculture, which well deserve the attention of all farmers in the kingdom. We have consulted them with much satisfaction on several occasions, and have frequently referred to them in the course of this work; and therefore, with pleasure, embrace the present opportunity of repeating our obligations. We owe the same acknowledgments to the Society for the Improvement of Arts, &c. of London.

3. *Society for Working Mines*, an association lately formed on the continent of Europe. This institution arose from the accidental meeting of several mineralogists at Skleno near Schemnitz in Hungary, who were collected in order to examine a new method of amalgamation. Struck with the shackles imposed on mineralogy by monopolizers of new and useful processes, they thought no method so effectual to break them, as forming a society, whose common labours should be directed to fix raining on its surest principles; and whose memoirs,

Societies for  
Encouraging and  
Promoting  
Arts, Manu-  
factures,  
&c.

spread over all Europe, might offer to every adventurer the result of the researches, of which they are the object. By these means they supposed, that there would be a mass of information collected; the interests of individuals would be lost in the general interest; and the one would materially assist the other. Imposture and quackery would, by the same means, be banished from a science, which must be improved by philosophy and experience; and the society, they supposed, would find, in the confidence which they inspired, the reward and the encouragement of their labours. They design, that the memoirs which they publish shall be short and clear; truth must be their basis, and every idle discussion, every foreign digression, must be banished; politics and finance must be avoided, though the dissertations may seem to lead towards them; and they oblige themselves to oppose the affectation of brilliancies, and the ostentation of empty speculation, when compared with plain, simple, and useful facts.

The object of the society is physical geography; mineralogy founded on chemistry; the management of ore in the different operations which it undergoes; subterraneous geometry; the history of mining; foundries, and the processes for the extraction of metals from the ores, either by fusion or amalgamation, in every instance applied to practice. The end of this institution is to collect, in the most extensive sense, every thing that can assist the operations of the miner, and to communicate it to the different members, that they may employ it for the public good, in their respective countries. Each member must consider himself as bound to send to the society every thing which will contribute to the end of its institution; to point out, with precision, the several facts and observations; to communicate every experiment which occurs, even the unsuccessful ones, if the relation may seem to be advantageous to the public; to communicate to the society their examination of schemes, and their opinions on questions proposed by it; and to pay annually two ducats (about 18 s. 6 d.) to the direction every Easter. The society, on the other hand, is bound to publish every novelty that shall be communicated to it; to communicate to each member, at the member's expence, the memoirs, designs, models, productions, and every thing connected with the institution; to answer all the necessary demands made, relating in any respect to mining; and to give its opinion on every plan or project communicated through the medium of an honorary member.

The great centre of all intelligence is to be at Zellerfeld in Hartz, Brunswick: but the society is not fixed to any one spot; for every particular state some practical mineralogist is nominated as director. Among these are the names of Baron Born, M. Pallas, M. Charpentier, M. Prebra, and M. Henkel. Their office is to propose the members; to take care that the views of the society are pursued in the different countries where they reside; to answer the requests of the members of their country who are qualified to make them; in case of the death of a director, to choose another; and the majority is to determine where the archives and the strong box is to be placed.

All the eminent mineralogists in Europe are members of this society. It is erected on so liberal and so extensive a plan, that we entertain the highest hopes of its success; and have only to add, that we wish much

to see the study of several other sciences pursued in the same manner.

4. *The Society for the Improvement of Naval Architecture*, was founded in 1791. The object of it is to encourage every useful invention and discovery relating to naval architecture as far as shall be in their power, both by honorary and pecuniary rewards. They have in view particularly to improve the theories of floating bodies and of the resistance of fluids; to procure draughts and models of different vessels, together with calculations of their capacity, centre of gravity, tonnage, &c.; to make observations and experiments themselves, and to point out such observations and experiments as appear best calculated to further their designs, and most deserving those premiums which the society can bestow. But though the improvement of naval architecture in all its branches be certainly the principal object of this institution, yet the society do not by any means intend to confine themselves merely to the form and structure of vessels. Every subordinate and collateral pursuit will claim a share of the attention of the society in proportion to its merits; and whatever may have any tendency to render navigation more safe, salutary, and even pleasant, will not be neglected.

This institution owes its existence to the patriotic disposition and extraordinary attention of Mr Sewel a private citizen of London, who (though engaged in a line of business totally opposite to all concerns of this kind) has been led, by mere accident, to take such ocular notice of, and make such observations on, the actual state of naval architecture in this country, as naturally occurred to a man of plain understanding, zealous for the honour and interest of his country, and willing to bestow a portion of that time for the public good, which men of a different description would rather have devoted to their own private advantage. His attention was the more seriously excited, by finding that it was the opinion of some private ship-builders, who, in a debate on the failure of one of our naval engagements, pronounced, that such "would ever be the case while that business (the construction of our ships of war) was not studied as a science, but carried on merely by precedent; that there had not been one improvement in our navy that did not originate with the French, who had naval schools and seminaries for the study of it; and that our ships were not a match for those of that nation either singly or in a fleet, &c. &c."

In a short time the society were enabled to offer very considerable premiums for particular improvements in the construction of our shipping, &c. &c. and also to encourage our philosophers, mathematicians, and mechanics, to make satisfactory experiments, tending to ascertain the laws of resistance of water to solids of different forms, in all varieties of circumstance. On this head the reward is not less than L. 100 pounds or a gold medal. Other premiums of 50, 30, and 20 guineas, according to the importance or difficulty of the particular subject or point of investigation, are likewise offered, for different discoveries, inventions, or improvements. The terms of admission into the society are a subscription of two guineas annually, or twenty guineas for life.

5. *Society of Artists of Great Britain*, which consists of directors and fellows, was incorporated by charter in 1765, and empowered to purchase and hold lands, not exceeding

Societies  
Encouraging and  
Promoting  
Arts, Manu-  
factures  
&c.



Societies for  
Encouraging and  
Promoting  
Arts, Manu-  
factures,  
&c.

exceeding L. 1000 a year. The directors of this society, annually elected, are to consist of 24 persons, including the president, vice-president, treasurer, and secretary; and it is required that they be either painters, sculptors, architects, or engravers by profession.

6. *British Society for Extending the Fisheries and Improving the Sea-Coasts of this Kingdom*, was instituted in 1786. The end and design of this society will best appear from their charter, of which we present an abstract.

The preamble states, "the great want of improvement in fisheries, agriculture, and manufactures, in the Highlands and islands of North Britain; the prevalence of emigration from the want of employment in those parts; the prospect of a new nursery of seamen, by the establishment of fishing towns and villages in that quarter. The act therefore declares, that the persons therein named, and every other person or persons who shall thereafter become proprietors of the joint stock mentioned therein, shall be a distinct and separate body politic and corporate, by the name of *The British Society for Extending the Fisheries and Improving the Sea-coasts of this Kingdom*: That the said society may raise a capital joint stock not exceeding L. 150,000, to be applied to purchasing or otherwise acquiring lands and tenements in perpetuity, for the building thereon, and on no other land whatever, free towns, villages, and fishing stations: That the joint stock shall be divided into shares of L. 50 each: That no one person shall in his or her name possess more than ten shares, or L. 500: That the society shall not borrow any sum or sums of money whatsoever: That the sums to be advanced for this undertaking, and the profits arising therefrom, shall be divided proportionably to the sum subscribed; and that no person shall be liable for a larger sum than he or she shall have respectively subscribed: That one or two shares shall intitle to one vote and no more, in person or by proxy, at all meetings of proprietors; three or four shares to two votes; five, six, or seven shares, to three votes; eight or nine shares to four votes; and ten shares to five votes and no more: That more persons than one inclining to hold in their joint names one or more shares shall be intitled to vote, by one of such persons, according to the priority or their names, or by proxy: That bodies corporate shall vote by proxy under their seal: That all persons holding proxies shall be proprietors, and that no one person shall hold more than five votes by proxy: That the affairs of the society shall be managed by a governor, deputy governor, and 13 other directors, to be elected annually on the 25th of March, from among the proprietors of the society, holding at least one full share, by signed lists of their names to be transmitted by the proprietors to the secretary of the society: that five proprietors, not being governor, director, or other officer, shall be in like manner annually elected to audit the accounts of the society: That there shall be one general meeting of the proprietors annually on the 25th of March: That occasional general meetings shall be called on the request of nine or more proprietors: That the general meetings of the proprietors shall make all bye-laws and constitutions for the government of the society, and for the good and orderly carrying on of the business of the same: That no transfer shall be made of the stock of the society for three years from the 10th of August 1786: That

the cash of the society shall be lodged in the bank of England, bank of Scotland, or the royal bank of Scotland: That no director, proprietor, agent, or officer of the society, shall retain any sum or sums of money in his hands beyond the space of 30 days, on any account whatsoever: That all payments by the society shall be made by drafts on the said banks, under the hands of the governor or deputy-governor, counter-signed by the secretary or his deputy, and two or more directors: And that the books in which the accounts of the society shall be kept shall be open to all the proprietors."

The institution of this public-spirited society was in a great measure owing to the exertions of the patriotic John Knox; who, in the course of 23 years, travelled and explored the Highlands of Scotland no less than 16 times, and expended several thousand pounds of his own fortune in pursuing his patriotic designs.

7. *British Wool Society*. See *British Wool Society*.

*SOCIETY ISLES*, a cluster of isles, so named by Captain Cook in 1769. They are situated between the latitudes of 16. 10. and 16. 55. south, and between the longitudes of 150. 57. and 152. west. They are eight in number; namely, Otaheite, Huahine, Ulietea, Otaha, Bolabola, Manua, Toobouai, and Tabooyamanoo or Saunders's Island. The soil, productions, people, their language, religion, customs, and manners, are so nearly the same as at Otaheite, that little need be added here on that subject. Nature has been equally bountiful in uncultivated plenty, and the inhabitants are as luxurious and as indolent. A plantain branch is the emblem of peace, and exchanging names the greatest token of friendship. Their dances are more elegant, their dramatic entertainments have something of plot and consistency, and they exhibit temporary occurrences as the objects of praise or satire; so that the crisp of ancient comedy may be already discerned among them. The people of Huahine are in general stouter and fairer than those of Otaheite, and this island is remarkable for its populousness and fertility. Those of Ulietea, on the contrary, are smaller and blacker, and much less orderly. Captain Cook put on shore a Cape ewe at Bolabola, where a ram had been left by the Spaniards; and also an English boar and sow, with two goats, at Ulietea. If the valuable animals which have been transported thither from Europe should be suffered to multiply, no part of the world will equal these islands in variety and abundance of refreshments for future navigators.

*SOCINIANS*, in church-history, a sect of Christian heretics, so called from their founder Faustus Socinus (see *Socinus*). They maintain, "That Jesus Christ was a mere man, who had no existence before he was conceived by the Virgin Mary; that the Holy Ghost is no distinct person, but that the Father is truly and properly God. They own, that the name of God is given in the Holy Scriptures to Jesus Christ; but contend, that it is only a deputed title, which, however, invests him with an absolute sovereignty over all created beings, and renders him an object of worship to men and angels. They deny the doctrines of satisfaction and imputed righteousness; and say that Christ only preached the truth to mankind, set before them in himself an example of heroic virtue, and sealed his doctrines with his blood. Original sin and absolute predestination they esteem scholastic chimeras. They likewise

Societies for  
Encouraging and  
Promoting  
Arts, Manu-  
factures,  
&c.  
Socini-ns.

Socinians,  
Socini.

wife maintain the sleep of the soul, which they say becomes insensible at death, and is raised again with the body at the resurrection, when the good shall be established in the possession of eternal felicity, while the wicked shall be consigned to a fire that will not torment them eternally, but for a certain duration proportioned to their demerits."

This sect has long been indignant at being styled *Socinians*. They disclaim every human leader; and professing to be guided solely by the word of God and the deductions of reason, they call themselves *Unitarians*, and affect to consider all other Christians, even their friends the Arians, as *Polytheists*. Modern Unitarianism, as taught by Dr Priestley, is, however, a very different thing from Socinianism, as we find it in the Racovian catechism and other standard works of the sect. This far-famed philosopher has discovered what escaped the sagacity of all the *fratres poloni*, that Jesus Christ was the son of Joseph as well as Mary; that the evangelists mistook the meaning of Isaiah's prophecy, that "a virgin should conceive and bear a son;" that the applying of this prophecy to the birth of our Saviour, led them to conclude that his conception was miraculous; and that we are not to wonder at this mistake, as the apostles were not always inspired, and were in general inconclusive reasoners. The modesty of the writer in claiming the merit of such discoveries will appear in its proper colours to all our readers: the truth of his doctrine shall be considered in another place. See THEOLOGY.

SOCINUS (Lælius), the first author of the sect of the Socinians, was born at Sienna in Tuscany in 1525. Being designed by his father for the law, he began very early to search for the foundation of that science in the Word of God; and by that study discovered that the Romish religion taught many things contrary to revelation; when, being desirous of penetrating farther into the true sense of the Scriptures, he studied Greek, Hebrew, and even Arabic. In 1547 he left Italy, to go and converse with the Protestants; and spent four years in travelling thro' France, England, the Netherlands, Germany, and Poland, and at length settled at Zurich. He by this means became acquainted with the most learned men of his time, who testified by their letters the esteem they had for him: but as he discovered to them his doubts, he was greatly suspected of heresy. He, however, conducted himself with such address, that he lived among the capital enemies of his opinions, without receiving the least injury. He met with some disciples, who heard his instructions with respect; these were Italians who left their native country on account of religion, and wandered about in Germany and Poland. He communicated likewise his sentiments to his relations by his writings, which he caused to be conveyed to them at Sienna. He died at Zurich in 1562. Those who were of sentiments opposite to his, and were personally acquainted with him, confess that his outward behaviour was blameless. He wrote a Paraphrase on the first chapter of St John; and other works are ascribed to him.

SOCINUS (Faustus), nephew of the preceding, and principal founder of the Socinian sect, was born at Sienna in 1579. The letters which his uncle Lælius wrote to his relations, and which infused into them many seeds of heresy, made an impression upon him; so that,

knowing himself not innocent, he fled as well as the rest when the inquisition began to persecute that family. He was at Lyons when he heard of his uncle's death, and departed immediately to take possession of his writings. He returned to Tuscan; and made himself so agreeable to the grand duke, that the charms which he found in that court, and the honourable posts he filled there, hindered him for twelve years from remembering that he had been considered as the person who was to put the last hand to the system of samofatenian divinity, of which his uncle Lælius had made a rough draught. At last he went into Germany in 1574, and paid no regard to the grand duke's advices to return. He staid three years at Basil, and studied divinity there; and having adopted a set of principles very different from the system of Protestants, he resolved to maintain and propagate them; for which purpose he wrote a treatise *De Jesu Christo Servatore*. In 1579 Socinus retired into Poland, and desired to be admitted into the communion of the Unitarians; but as he differed from them in some points, on which he refused to be silent, he met with a repulse. However, he did not cease to write in defence of their churches against those who attacked them. At length his book against James Paleologus furnished his enemies with a pretence to exasperate the king of Poland against him; but though the mere reading of it was sufficient to refute his accusers, Socinus thought proper to leave Cracow, after having resided there four years. He then lived under the protection of several Polish lords, and married a lady of a good family: but her death, which happened in 1587, so deeply afflicted him as to injure his health; and to complete his sorrow, he was deprived of his patrimony by the death of Francis de Medicis great duke of Florence. The consolation he found in seeing his sentiments at last approved by several ministers, was greatly interrupted in 1598; for he met with a thousand insults at Cracow, and was with great difficulty saved from the hands of the rabble. His house was plundered, and he lost his goods; but this loss was not so unequal to him as that of some manuscripts, which he extremely regretted. To deliver himself from such dangers, he retired to a village about nine miles distant from Cracow, where he spent the remainder of his days at the house of Abraham Blonski, a Polish gentleman, and died there in 1604. All Faustus Socinus's works are contained in the two first volumes of the *Bibliotheca Fratrum Polonorum*.

SOCMANS, SOREMANS, or *Socmen* (*Socmanni*), are such tenants as hold their lands and tenements by socage tenure. See SOCAGE.

SOCOTORA, an island lying between Asia and Arabia Felix; about 50 miles in length, and 22 in breadth. It is particularly noted for its fine aloe, known by the name of *Socotrine Aloes*. The religion of the natives is a mixture of Mahometanism and Paganism; but they are civil to strangers who call there in their passage to the East Indies. It abounds in fruit and cattle; and they have a king of their own, who is dependent on Arabia.

SOCRATES, the greatest of the ancient philosophers, was born at Alopece, a village near Athens, in the fourth year of the 77th olympiad. His parents were of low rank; his father Sophroniscus being a staturary, and his mother Phænareta a midwife. Sophro-

Socinus  
||  
Socrates.

Socrates. niscus brought up his son, contrary to his inclination, in his own manual employment; in which Socrates, though his mind was continually aspiring after higher objects, was not unsuccessful; for whilst he was a young man, he is said to have formed statues of the habited graces, which were allowed a place in the citadel of Athens. Upon the death of his father he was left in such straitened circumstances as laid him under the necessity of exercising that art to procure the means of subsistence, though he devoted, at the same time, all the leisure which he could command to the study of philosophy. His distress, however, was soon relieved by Crito, a wealthy Athenian; who, remarking his strong propensity to study, and admiring his ingenuous disposition and distinguished abilities, generously took him under his patronage, and intrusted him with the instruction of his children. The opportunities which Socrates by this means enjoyed of attending the public lectures of the most eminent philosophers, so far increased his thirst after wisdom, that he determined to relinquish his occupation, and every prospect of emolument which that might afford, in order to devote himself entirely to his favourite pursuits. Under Anaxagoras and Archelaus he prosecuted the study of nature in the usual manner of the philosophers of the age, and became well acquainted with their doctrines. Prodicus the sophist was his preceptor in eloquence, Euenus in poetry, Theodorus in geometry, and Damon in music. Aspasia, a woman no less celebrated for her intellectual than her personal accomplishments, whose house was frequented by the most celebrated characters, had also some share in the education of Socrates. Under such preceptors it cannot reasonably be doubted but that he became master of every kind of learning which the age in which he lived could afford; and being blessed with very uncommon talents by nature, he appeared in Athens, under the respectable characters of a good citizen and a true philosopher. Being called upon by his country to take arms in the long and severe struggle between Athens and Sparta, he signalized himself at the siege of Potidæa, both by his valour and by the hardiness with which he endured fatigue. During the severity of a Thracian winter, whilst others were clad in furs, he wore only his usual clothing, and walked barefoot upon the ice. In an engagement in which he saw ALCEBIADES falling down wounded, he advanced to defend him, and saved both him and his arms: and though the prize of valour was on this occasion unquestionably due to Socrates, he generously gave his vote that it might be bestowed upon Alcibiades, to encourage his rising merit. He served in other campaigns with distinguished bravery, and had the happiness on one occasion to save the life of Xenophon, by bearing him, when covered with wounds, out of the reach of the enemy.

It was not till Socrates was upwards of 60 years of age that he undertook to serve his country in any civil office, when he was chosen to represent his own district, in the senate of five hundred. In this office, though he at first exposed himself to some degree of ridicule from the want of experience in the forms of business, he soon convinced his colleagues that he was superior to them all in wisdom and integrity. Whilst they, intimidated by the clamours of the populace, passed an unjust sentence of condemnation upon the commanders, who, after the engagement at the Arginusian islands, had

been prevented by a storm from paying funeral honours to the dead, Socrates stood forth singly in their defence, and to the last refused to give his suffrage against them, declaring that no force should compel him to act contrary to justice and the laws. Under the subsequent tyranny he never ceased to condemn the oppressive and cruel proceedings of the thirty tyrants; and when his boldness provoked their resentment, so that his life was in hazard, fearing neither treachery nor violence, he still continued to support with undaunted firmness the rights of his fellow-citizens.

Having given these proofs of public virtue both in a military and civil capacity, he wished to do still more for his country. Observing with regret how much the opinions of the Athenian youth were misled, and their principles and taste corrupted by philosophers who spent all their time in refined speculations upon nature and the origin of things, and by sophists who taught in their schools the arts of false eloquence and deceitful reasoning; Socrates turned the wise and generous design of instituting a new and more useful method of instruction. He justly conceived the true end of philosophy to be, not to make an ostentatious display of superior learning and ability in subtile disputations or ingenious conjectures, but to free mankind from the dominion of pernicious prejudices; to correct their vices; to inspire them with the love of virtue; and thus conduct them in the path of wisdom to true felicity. He therefore assumed the character of a moral philosopher; and, looking upon the whole city of Athens as his school, and all who were disposed to lend him their attention as his pupils, he seized every occasion of communicating moral wisdom to his fellow citizens. He passed the greater part of his time in public; and the method of instruction of which he chiefly made use was, to propose a serious of questions to the person with whom he conversed, in order to lead him to some unforeseen conclusion. He first gained the consent of his respondent to some obvious truths, and then obliged him to admit others from their relation or resemblance to those to which he had already assented. Without making use of any direct argument or persuasion, he chose to lead the person he meant to instruct, to deduce the truths of which he wished to convince him, as a necessary consequence from his own concessions. He commonly conducted these conferences with such address, as to conceal his design till the respondent had advanced too far to recede. On some occasions he made use of ironical language, that vain men might be caught in their own replies, and be obliged to confess their ignorance. He never assumed the air of a morose and rigid preceptor, but communicated useful instruction with all the ease and pleasantry of polite conversation. Though eminently furnished with every kind of learning, he preferred moral to speculative wisdom. Convinced that philosophy is valuable, not as it furnishes questions for the schools, but as it provides men with a law of life, he censured his predecessors for spending all their time in abstruse researches into nature, and taking no pains to render themselves useful to mankind. His favourite maxim was, Whatever is above us doth not concern us. He estimated the value of knowledge by its utility, and recommended the study of geometry, astronomy, and other sciences, only so far as they admit of a practical application to the purposes of human life. His great

Socrates.

object in all his conferences and discourses was, to lead men into an acquaintance with themselves; to convince them of their follies and vices; to inspire them with the love of virtue; and to furnish them with useful moral instructions. Cicero might therefore very justly say of Socrates, that he was the first who called down philosophy from heaven to earth, and introduced her into the public walks and domestic retirements of men, that she might instruct them concerning life and manners.

Through his whole life this good man discovered a mind superior to the attractions of wealth and power. Contrary to the general practice of the preceptors of his time, he instructed his pupils without receiving from them any gratuity. He frequently refused rich presents, which were offered him by Alcibiades and others, though importunately urged to accept them by his wife. The chief men of Athens were his stewards: they sent him in provisions, as they apprehended he wanted them; he took what his present wants required, and returned the rest. Observing the numerous articles of luxury which were exposed to sale in Athens, he exclaimed, "How many things are there which I do not want!" With Socrates, moderation supplied the place of wealth. In his clothing and food, he consulted only the demands of nature. He commonly appeared in a neat but plain cloak, with his feet uncovered. Though his table was only supplied with simple fare, he did not scruple to invite men of superior rank to partake of his meals; and when his wife, upon some such occasion, expressed her dissatisfaction on being no better provided, he desired her to give herself no concern; for if his guests were wise men, they would be contented with whatever they found at his table; if otherwise, they were unworthy of notice. Whilst others, says he, live to eat, wife men eat to live.

Though Socrates was exceedingly unfortunate in his domestic connection, he converted this infelicity into an occasion of exercising his virtues. Xantippe, concerning whose ill humour ancient writers relate many amusing tales, was certainly a woman of a high and unmanageable spirit. But Socrates, while he endeavoured to curb the violence of her temper, improved his own. When Alcibiades expressed his surprisè that his friend could bear to live in the same house with so perverse and quarrelsome a companion, Socrates replied, that being daily inured to ill humour at home, he was the better prepared to encounter perverseness and injury abroad.

In the midst of domestic vexations and public disorders, Socrates retained such an unruffled serenity, that he was never seen either to leave his own house or to return home with a disturbed countenance. In acquiring this entire dominion over his passions and appetites, he had the greater merit, as it was not effected without a violent struggle against his natural propensities. Zopyrus, an eminent physiognomist, declared, that he discovered in the features of the philosopher evident traces of many vicious inclinations. The friends of Socrates who were present ridiculed the ignorance of this pretender to extraordinary sagacity. But Socrates himself ingenuously acknowledged his penetration, and confessed that he was in his natural disposition prone to vice, but that he had subdued his inclinations by the power of reason and philosophy.

Through the whole of his life Socrates gave himself

up to the guidance of unbiassed reason, which is supposed by some to be all that he meant by the genius or *dæmon* from which he professed to receive instruction. But this opinion is inconsistent with the accounts given by his followers of that *dæmon*, and even with the language in which he spoke of it himself. Plato sometimes calls it his *guardian*, and Apuleius his *god*; and as Xenophon attests that it was the belief of his master that the gods occasionally communicate to men the knowledge of future events, it is by no means improbable that Socrates admitted, with the generality of his countrymen, the existence of those intermediate beings called *dæmons*, of one of which he might fancy himself the peculiar care.

It was one of the maxims of Socrates, "That a wise man will worship the gods according to the institutions of the state to which he belongs." Convinced of the weakness of the human understanding, and perceiving that the pride of philosophy had led his predecessors into futile speculations on the nature and origin of things, he judged it most consistent with true wisdom to speak with caution and reverence concerning the divine nature.

The wisdom and the virtues of this great man, whilst they procured him many followers, created him also many enemies. The Sophists, whose knavery and ignorance he took every opportunity of exposing to public contempt, became inveterate in their enmity against so bold a reformer, and devised an expedient, by which they hoped to check the current of his popularity. They engaged Aristophanes, the first buffoon of the age, to write a comedy, in which Socrates should be the principal character. Aristophanes, pleased with so promising an occasion of displaying his low and malignant wit, undertook the task, and produced the comedy of *The Clouds*, still extant in his works. In this piece, Socrates is introduced hanging in a basket in the air, and thence pouring forth absurdity and prophaneness. But the philosopher, showing in a crowded theatre that he was wholly unmoved by this ribaldry, the satire failed of its effect; and when Aristophanes attempted the year following to renew the piece with alterations and additions, the representation was so much discouraged, that he was obliged to discontinue it.

From this time Socrates continued for many years to pursue without interruption his laudable design of instructing and reforming his fellow-citizens. At length, however, when the inflexible integrity with which he had discharged the duty of a senator, and the firmness with which he had opposed every kind of political corruption and oppression, had greatly increased the number of his enemies, clandestine arts were employed to raise a general prejudice against him. The people were industriously reminded, that Critias, who had been one of the most cruel of the thirty tyrants, and Alcibiades, who had insulted religion, by defacing the public statues of Mercury, and performing a mock representation of the Eleusinian mysteries, had in their youth been disciples of Socrates; and the minds of the populace being thus prepared, a direct accusation was preferred against him before the supreme court of judicature. His accusers were Anytus a leather-dresser, who had long entertained a personal enmity against Socrates, for reprehending his avarice, in depriving his sons of the benefits of learning, that they might pursue the gains of trade;

Socrates.

Socrates.

trade; Melitus, a young rhetorician, who was capable of undertaking any thing for the sake of gain; and Lycon, who was glad of any opportunity of displaying his talents. The accusation, which was delivered to the senate under the name of Melitus, was this: "Melitus, son of Melitus, of the tribe of Pythos, accuseth Socrates, son of Sophroniscus, of the tribe of Alopee. Socrates violates the laws, in not acknowledging the gods which the state acknowledges, and by introducing new divinities. He also violates the laws by corrupting the youth. Be his punishment DEATH."

This charge was delivered upon oath to the senate; and Crito a friend of Socrates became surety for his appearance on the day of trial. Anytus soon afterwards sent a private message to Socrates, assuring him that if he would desist from censuring his conduct, he would withdraw his accusation. But Socrates refused to comply with so degrading a condition; and with his usual spirit replied, "Whilst I live I will never disguise the truth, nor speak otherwise than my duty requires." The interval between the accusation and the trial he spent in philosophical conversations with his friends, choosing to discourse upon any other subject rather than his own situation.

When the day of trial arrived, his accusers appeared in the senate, and attempted to support their charge in three distinct speeches, which strongly marked their respective characters. Plato, who was a young man, and a zealous follower of Socrates, then rose up to address the judges in defence of his master; but whilst he was attempting to apologise for his youth, he was abruptly commanded by the court to sit down. Socrates, however needed no advocate. Ascending the chair with all the serenity of conscious innocence, and with all the dignity of superior merit, he delivered, in a firm and manly tone, an unpremeditated defence of himself, which silenced his opponents, and ought to have convinced his judges. After tracing the progress of the conspiracy which had been raised against him to its true source, the jealousy and resentment of men whose ignorance he had exposed, and whose vices he had ridiculed and reformed, he distinctly replied to the several charges brought against him by Melitus. To prove that he had not been guilty of impiety towards the gods of his country, he appealed to his frequent practice of attending the public religious festivals. The crime of introducing new divinities, with which he was charged, chiefly as it seems on the ground of the admonitions which he professed to have received from an invisible power, he disclaimed, by pleading that it was no new thing for men to consult the gods and receive instructions from them. To refute the charge of his having been a corrupter of youth, he urged the example which he had uniformly exhibited of justice, moderation, and temperance; the moral spirit and tendency of his discourses; and the effect which had actually been produced by his doctrine upon the manners of the young. Then, disdainingly to solicit the mercy of his judges, he called upon them for that justice which their office and their oath obliged them to administer; and professing his faith and confidence in God, resigned himself to their pleasure.

The judges, whose prejudices would not suffer them to pay due attention to this apology, or to examine

with impartiality the merits of the cause, immediately declared him guilty of the crimes of which he stood accused. Socrates, in this stage of the trial, had a right to enter his plea against the punishment which the accusers demanded, and instead of the sentence of death, to propose some pecuniary amendment. But he at first peremptorily refused to make any proposal of this kind, imagining that it might be construed into an acknowledgment of guilt; and asserted, that his conduct merited from the state reward rather than punishment. At length, however, he was prevailed upon by his friends to offer upon their credit a fine of thirty *minæ*. The judges, notwithstanding, still remained inexorable: they proceeded, without farther delay, to pronounce sentence upon him: and he was condemned to be put to death by the poison of hemlock.

The sentence being passed, he was sent to prison: which, says Seneca, he entered with the same resolution and firmness with which he had opposed the thirty tyrants; and took away all ignominy from the place, which could not be a prison while he was there. He lay in fetters 30 days; and was constantly visited by Crito, Plato, and other friends, with whom he passed the time in dispute after his usual manner. Anxious to save so valuable a life, they urged him to attempt his escape, or at least to permit them to convey him away; and Crito went so far, as to assure him that, by his interest with the jailor, it might be easily accomplished, and to offer him a retreat in Thessaly; but Socrates rejected the proposal, as a criminal violation of the laws; and asked them, whether there was any place out of Attica which death could not reach.

At length the day arrived when the officers to whose care he was committed delivered to Socrates early in the morning the final order for his execution, and immediately, according to the law, set him at liberty from his bonds. His friends, who came thus early to the prison that they might have an opportunity of conversing with their master through the day, found his wife sitting by him with a child in her arms. Socrates, that the tranquillity of his last moments might not be disturbed by her unavailing lamentations, requested that she might be conducted home. With the most frantic expressions of grief she left the prison. An interesting conversation then passed between Socrates and his friends, which chiefly turned upon the immortality of the soul. In the course of this conversation, he expressed his disapprobation of the practice of suicide, and assured his friends that his chief support in his present situation was an expectation, though not unmixed with doubts, of a happy existence after death. "It would be inexcusable in me (said he) to despise death, if I were not persuaded that it will conduct me into the presence of the gods, who are the most righteous governors, and into the society of just and good men: but I derive confidence from the hope that something of man remains after death, and that the condition of good men will then be much better than that of the bad." Crito afterwards asking him, in what manner he wished to be buried? Socrates replied, with a smile, "As you please, provided I do not escape out of your hands." Then, turning to the rest of his friends, he said, "Is it not strange, after all that I have said to convince you that I am going to the society of the hap-

Socrates.

Socrates.

py, that Crito still thinks that this body, which will soon be a lifeless corpse, is Socrates? Let him dispose of my body as he pleases, but let him not at its interment mourn over it as it were Socrates."

Towards the close of the day he retired into an adjoining apartment to bathe; his friends, in the mean time, expressing to one another their grief at the prospect of losing to excellent a father, and being left to pass the rest of their days in the solitary state of orphans. After a short interval, during which he gave some necessary instructions to his domestics, and took his last leave of his children, the attendant of the prison informed him, that the time for drinking the poison was come. The executioner, though accustomed to such scenes, shed tears as he presented the fatal cup. Socrates received it without change of countenance or the least appearance of perturbation: then offering up a prayer to the gods that they would grant him a prosperous passage into the invisible world, with perfect composure he swallowed the poisonous draught. His friends around him burst into tears. Socrates alone remained unmoved. He upbraided their pusillanimity, and entreated them to exercise a manly constancy worthy of the friends of virtue. He continued walking till the chilling operation of the hemlock obliged him to lie down upon his bed. After remaining for a short time silent, he requested Crito (probably in order to refute a calumny which might prove injurious to his friends after his decease) not to neglect the offering of a cock which he had vowed to Esculapius. Then, covering himself with his cloak, he expired. Such was the fate of the virtuous Socrates! A story, says Cicero, which I never read without tears.

The friends and disciples of this illustrious teacher of wisdom were deeply afflicted by his death, and attended his funeral with every expression of grief. Apprehensive, however, for their own safety, they soon afterwards privately withdrew from the city, and took up their residence in distant places. Several of them visited the philosopher Euclid of Megara, by whom they were kindly received. No sooner was the unjust condemnation of Socrates known through Greece, than a general indignation was kindled in the minds of good men, who universally regretted that so distinguished an advocate for virtue should have fallen a sacrifice to jealousy and envy. The Athenians themselves, so remarkable for their caprice, who never knew the value of their great men till after their death, soon became sensible of the folly as well as criminality of putting to death the man who had been the chief ornament of their city and of the age, and turned their indignation against his accusers. Melitus was condemned to death; and Anytus, to escape a similar fate, went into voluntary exile. To give a farther proof of the sincerity of their regret, the Athenians for a while interrupted public business; decreed a general mourning; recalled the exiled friends of Socrates; and erected a statue to his memory in one of the most frequented parts of the city. His death happened in the first year of the 96th olympiad, and in the 70th year of his age.

Socrates left behind him nothing in writing; but his illustrious pupils Xenophon and Plato have in some measure supplied this defect. The Memoirs of Socrates, written by Xenophon, afford, however, a much

more accurate idea of the opinions of Socrates, and of his manner of teaching, than the Dialogues of Plato, who everywhere mixes his own conceptions and diction with the ideas and language of his master. It is related, that when Socrates heard Plato recite his *Lylis*, he said, "How much does this young man make me say which I never conceived!"

His distinguishing character was that of a moral philosopher; and his doctrine concerning God and religion was rather practical than speculative. But he did not neglect to build the structure of religious faith upon the firm foundation of an appeal to natural appearances: He taught, that the Supreme Being, though invisible, is clearly seen in his works; which at once demonstrate his existence and his wise and benevolent providence. He admitted, besides the one Supreme Deity, the existence of beings who possess a middle station between God and man, to whose immediate agency he ascribed the ordinary phenomena of nature, and whom he supposed to be particularly concerned in the management of human affairs. Hence he declared it to be the duty of every one, in the performance of religious rites, to follow the customs of his country. At the same time, he taught, that the merit of all religious offerings depends upon the character of the worshipper, and that the gods take pleasure in the sacrifices of none but the truly pious.

Concerning the human soul, the opinion of Socrates, according to Xenophon, was, that it is allied to the Divine Being, not by a participation of essence, but by a similarity of nature; that man excels all other animals in the faculty of reason; and that the existence of good men will be continued after death in a state in which they will receive the reward of their virtues. Although it appears that on this latter topic he was not wholly free from uncertainty, the consolation which he professed to derive from this source in the immediate prospect of death, leaves little room to doubt that he entertained a real expectation of immortality: and there is reason to believe that he was the only philosopher of ancient Greece whose principles admitted of such an expectation (see *METAPHYSICS*, Part III. Chap. iv.) Of his moral system, which was in a high degree pure, and founded on the surest basis, the reader will find a short view in our article *MORAL PHILOSOPHY*, n° 4.

SOCRATES was also the name of an ecclesiastical historian of the 5th century, born at Constantinople in the beginning of the reign of Theodosius: he professed the law and pleaded at the bar, whence he obtained the name of *Scholasticus*. He wrote an ecclesiastical history from the year 309, where Eusebius ended, down to 440; and wrote with great exactness and judgment. An edition of Eusebius and Socrates, in Greek and Latin, with notes by Reading, was published at London in 1720.

SODA, the name given by the French chemists to the mineral alkali, which is found native in many parts of the world: it is obtained also from common salt, and from the ashes of the *kali*, a species of *salsola*. See *ALKALI*, n° 7. and *CHEMISTRY-Index*.

SODA is also a name for a heat in the stomach or heart-burn. See *MEDICINE*, n° 275.

SODOM, formerly a town of Palestine in Asia, famous in Scripture for the wickedness of its inhabitants, and their destruction by fire from heaven on account of that

Socrates  
||  
Sodom.

Sodom, that wickedness. The place where it stood is now covered by the waters of the Dead Sea, or the Lake Asphaltites. See ASPHALTITES.

SODOMY, an unnatural crime, so called from the city of Sodom, which was destroyed by fire for the same. The Levitical law adjudged those guilty of this execrable crime to death; and the civil law assigns the same punishment to it. The law of England makes it felony. There is no statute in Scotland against Sodomy; the libel of the crime is therefore founded on the divine law, and practice makes its punishment to be burned alive.

SODOR, a name always conjoined with Man, in mentioning the bishop of Man's diocese. Concerning the origin and application of this word, very different opinions have been formed by the learned. Buchanan (lib. i. cap. 34.) says, that before his time the name of Sodor was given to a town in the isle of Man. In Gough's edition of Camden's *Britannia* (vol. iii. p. 701.) it is said, that after the isle of Man was annexed to the crown of England, this appellation was given to a small island within musket-shot of Man, in which the cathedral stands, called by the Norwegians the *Holm*, and by the inhabitants the *Peel*. In support of this opinion a charter is quoted A. D. 1505, in which Thomas earl of Derby and lord of Man confirms to Huan Hesketh bishop of Sodor all the lands, &c. anciently belonging to the bishops of Man. "Ecclesiam cathedralem sancti Germani in *Holm Sodor vel Pels* vocatam, ecclesiam sancti Patricii ibidem, et locum præfatum in quo ecclesiæ præfatæ sitæ sunt." The truth of either, or perhaps of both, these accounts might be allowed; but neither of them are sufficient to account for the constant conjunction of Sodor and Man, in charters, registers, and histories. If Sodor was a small town or island belonging to Man, it cannot be conceived why it is always mentioned before it, or rather why it should be mentioned at all in speaking of a bishop's diocese. To speak of the bishopric of Sodor and Man in this case would be as improper as it would be to call the bishopric of Durham the bishopric of Holy Island and Durham, or the bishopric of Darlington and Durham; the former being a small island and the latter a town belonging to the county and diocese of Durham. Neither of these accounts, therefore, give a satisfactory account of the original conjunction of Sodor and Man.

The island of Iona was the place where the bishop of the isles resided, the cathedral church of which, it is said, was dedicated to our Saviour, in Greek *Soter*, hence *Sotorenfes*, which might be corrupted into *Sodorenfes*, a name frequently given by Danish writers to the western isles of Scotland. That we may be the more disposed to accede to this Grecian etymology, the advocates for this opinion tell us, that the name *Icolumkill*, which is often applied to this island, is also of Greek extraction, being derived from *Columba*, "a pigeon;" a meaning that exactly corresponds to the Celtic word *Colum* and the Hebrew word *Iona*. We must confess, however, that we have very little faith in the conjectures of etymologists, and think that upon no occasion they alone can establish any fact, though when concurring with facts they certainly tend to confirm and explain them. It is only from historical facts that we can know to what Sodor was applied.

It appears from the history of the Orkneys, compiled

by an old Islandic writer, translated and enlarged by Torfæus, that the *Æbudæ* or Western isles of Scotland were divided into two clusters, Nordureys and Sudereys. The Nordureys, which were separated from the Sudereys by the point of Ardnamurchan, a promontory in Argyleshire, consisted of Muck, Egg, Rum, Canna, Sky, Rasay, Barra, South Uist, North Uist, Benbecula, and Lewis, including Harris, with a great number of small isles. The Sudereys were, Man, Arran, Bute, Cumra, Avon, Gid, Ila, Colonsay, Jura, Scarba, Mull, Iona, Tiree, Coll, Ulva, and other small islands. All these, when joined together, and subject to the same prince, made up the kingdom of Man and the isles. In the Norwegian language *Suder* and *Norder*, signifying southern and northern, and *ey* or *ay* an island. When the *Æbudæ* were under one monarch, the seat of empire was fixed in the Sudereys, and the Nordureys were governed by deputies; hence the former are much oftener mentioned in history than the latter; hence, too, the Sudereys often comprehend the Nordureys, as in our days Scotland is sometimes comprehended under England. Sudereys, or *Suder*, when anglicised, became Sodor; and all the western isles of Scotland being included in one diocese under the Norwegian princes, the bishop appointed to superintend them was called the bishop of Man and the isles, or the bishop of Sodor and Man. Since Man was conquered by Edward III. it has been separated from the other isles, and its bishops have exercised no jurisdiction over them. Should it now be asked, why then is the bishop of Man still called the bishop of Sodor and Man? we reply, that we have been able to discover no reason; but suppose the appellation to be continued in the same way, as the title king of France, has been kept up by the kings of Great Britain, for several centuries after the English were entirely expelled from France.

SOFA, in the east, a kind of alcove raised half a foot above the floor of a chamber or other apartment; and used as the place of state, where visitors of distinction are received. Among the Turks the whole floor of their state-rooms is covered with a kind of tapestry, and on the window-side is raised a *so'a* or *sopha*, laid with a kind of matras, covered with a carpet much richer than the other. On this carpet the Turks are seated, both men and women, like the taylors in England, cross-legged, leaning against the wall, which is bolstered with velvet, fatten, or other stuff suitable to the season. Here they eat their meals; only laying a skin over the carpet to serve as a table-cloth, and a round wooden board over all, covered with plates, &c.

SOFALA, or CEPALA, a kingdom of Africa, lying on the coast of Mosambique, near Zanguebar. It is bounded on the north by Monoinotapa; on the east by the Mosambique Sea; on the south by the kingdom of Sabia; and on the west by that of Manica. It contains mines of gold and iron, and a great number of elephants. It is governed by a king, tributary to the Portuguese, who built a fort at the principal town, which is of the same name, and of great importance for their trade to the East Indies. It is seated in a small island, near the mouth of a river. E. Long. 35. 40. S. Lat. 20. 20.

SOFFITA, or SOFFIT, in architecture, any timber ceiling formed of cross beams of flying cornices, the square compartments or panells of which are enriched

Sodor  
||  
Suffita.

Soffita  
||  
Soho.

with sculpture, painting, or gilding; such are those in the palaces of Italy, and in the apartments of Luxembourg at Paris.

SOFFITA, or *Soffit*, is also used for the under-side or face of an architrave; and more particularly for that of the corona or larmier, which the ancients called *lacunar*, the French *plafond*, and we usually the *drip*. It is enriched with compartments of roses; and in the Doric order has 18 drops, disposed in three ranks, six in each, placed to the right of the guttae, at the bottom of the triglyphs.

SOFI, or SOPHI. See SOPHI.

SOFTENING, in painting, the mixing and diluting of colours with the brush or pencil.

SOHO, the name of a set of works, or manufactory of a variety of hard-wares, belonging to Mr Boulton, situated on the borders of Staffordshire, within two miles of Birmingham; now so justly celebrated as to deserve a short historical detail.

About 30 years ago the premises consisted of a small mill and a few obscure dwellings. Mr Boulton, in conjunction with Mr Fothergill, then his partner, at an expense of L. 9000, erected a handsome and extensive edifice, with a view of manufacturing metallic toys. The first productions consisted of buttons, buckles, watch-chains, trinkets, and such other articles as were peculiar to Birmingham. Novelty, taste, and variety, were, however, always conspicuous; and plated wares, known by the name of Sheffield plate, comprising a great variety of useful and ornamental articles, became another permanent subject of manufacture.

To open channels for the consumption of these commodities, all the northern part of Europe was explored by the mercantile partner Mr Fothergill. A wide and extensive correspondence was thus established, the undertaking became well known, and the manufacturer, by becoming his own merchant, eventually enjoyed a double profit.

Impelled by an ardent attachment to the arts, and by the patriotic ambition of forming his favourite Soho into a fruitful seminary of artists, the proprietor extended his views; and men of taste and talents were now sought for, and liberally patronised. A successful imitation of the French or *moulie* ornaments, consisting of vases, tripods, candelabra, &c. &c. extended the celebrity of the works. Services of plate and other works in silver, both massive and airy, were added, and an assay office was established in Birmingham.

Mr Watt, the ingenious improver of the steam-engine, is now in partnership with Mr Boulton; and they carry on at Soho a manufactory of steam-engines, not less beneficial to the public than lucrative to themselves. This valuable machine, the nature and excellences of which are described in another place (see *STEAM-Engine*), Mr Boulton proposed to apply to the operation of coining, and suitable apparatus was erected at a great expense, in the hope of being employed by government to make a new copper-coinage for the kingdom. Artists of merit were engaged, and specimens of exquisite delicacy were exhibited; but as no national coinage has taken place, the works are employed upon high

finished medals and private coins. To enumerate all the productions of this manufactory would be tedious (A).

In a national view, Mr Boulton's undertakings are highly valuable and important. By collecting around him artists of various descriptions, rival talents have been called forth, and by successful competition have been multiplied to an extent highly beneficial to the public. The manual arts partook of the benefit, and became proportionably improved.

A barren heath has been covered with plenty and population; and Mr Boulton's works, which in their infancy were little known and attended to, now cover several acres, give employment to more than 600 persons, and are said to be the first of their kind in Europe.

SOIL, the mould covering the surface of the earth, in which vegetables grow. It serves as a support for vegetables, and as a reservoir for receiving and communicating their nourishment.

Soils are commonly double or triple compounds of the several reputed primitive earths, except the barytic (see *EARTHS*). The magnesian likewise sparingly occurs. The more fertile soils afford also a small proportion of coally substance arising from putrefaction, and some traces of marine acid and gypsum. The vulgar division into clay, chalk, sand, and gravel, is well understood. Loam denotes any soil moderately adhesive; and, according to the ingredient that predominates, it receives the epithets of clayey, chalky, sandy, or gravelly. The intimate mixture of clay with the oxides of iron is called *till*, and is of a hard consistence and a dark reddish colour. Soils are found by analysis to contain their earthy ingredients in very different proportions. According to M. Giobert, fertile mould in the vicinity of Turin, where the fall of rain amounts yearly to 40 inches, affords for each 100 parts, from 77 to 79 of filix, from 8 to 14 of argill, and from 5 to 12 of calx; besides about one-half of carbonic matter, and nearly an equal weight of gas, partly carbonic and partly hydrocarbonic. The same experimenter represents the composition of barren soils in similar situations to be from 42 to 88 *per cent.* of filix, from 25 to 30 of argill, and from 4 to 20 of calx. The celebrated Bergman found rich soils in the valleys of Sweden, where the annual quantity of rain is 24 inches, to contain, for each 100 parts, 56 of siliceous sand, 14 of argill, and 30 of calx. In the climate of Paris, where the average fall of rain is 20 inches, fertile mixtures, according to M. Tillet, vary from 46 to 52 *per cent.* of filix, and from 11 to 17 of argill, with 37 of calx. Hence it appears that in dry countries rich earths are of a closer texture, and contain more of the calcareous ingredient, with less of the siliceous. Mr Arthur Young has discovered, that the value of fertile lands is nearly proportioned to the quantities of gas which equal weights of their soil afford by distillation. See *AGRICULTURE*, n<sup>o</sup> 24. and 118.

SOISSONS, an ancient, large, and considerable city of France, in the department of Aisne and late province of Soissonnois. It was the capital of a kingdom of the same name, under the first race of the French monarchs. It contains about 12,000 inhabitants, and is a bishop's see.

S il.  
Soissons.

(A) It was at this place, in the year 1772, that Mr Eginton invented his expeditious method of copying pictures in oil.



*Sole il platum.* See. The environs are charming, but the streets are narrow, and the houses ill-built. The fine cathedral has one of the most considerable chapters in the kingdom; and the bishop, when the archbishop of Rheims was absent, had a right to crown the king. The castle, though ancient, is not that in which the kings of the first race resided. Soissons is seated in a very pleasant and fertile valley, on the river Aisne, 30 miles west by north of Rheims, and 60 north east of Paris. E. Long. 3. 24. N. Lat. 40. 23.

SOKE, or SOK. See SOGAGE.

SOKEMANS. See SOC and SOGAGE.

SOL, in music, the fifth note of the gamut, *ut, re, mi, fa, sol, la*. See GAMUT.

SOL, or *Sou*, a French coin made up of copper mixed with a little silver, and is worth upwards of an English halfpenny, or the 23d part of an English shilling. The sol when first struck was equal in value to 12 deniers Tournois, whence it was also called *douzain*, a name it still retains, tho' its ancient value be changed; the sol having been since augmented by three deniers, and struck with a punchon of a fleur-de-lis, to make it current for 15 deniers. Soon after the old sols were coined over again, and both old and new were indifferently made current for 15 deniers. In 1709, the value of the same sols was raised to 18 deniers. Towards the latter end of the reign of Louis XIV. the sol of 18 deniers was again lowered to 15; and by the late king it was reduced to the original value of 12. What it is at present posterity may perhaps discover.

The Dutch have also two kinds of sols: the one of silver, called *sols de gros*, and likewise *schelling*; the other of copper, called also the *sluyver*.

SOL, the *Sun*, in astronomy, astrology, &c. See ASTRONOMY, *passim*.

SOL, in chemistry, is gold; thus called from an opinion that this metal is in a particular manner under the influence of the sun.

SOL, in heraldry, denotes Or, the golden colour in the arms of sovereign princes.

SOLEUS, or SOLEUS, in anatomy, one of the extensor muscles of the foot, rising from the upper and hinder parts of the tibia and fibula.

SOLAN-GOOSE, in ornithology. See PELICANUS.

SOLANDRA, in botany: A genus of plants belonging to the class of *monodelphia*, and to the order of *polyandria*; and in the natural system arranged under the 38th order, *Tricocceæ*. The calyx is simple; the capsule oblong, wreathed, and five-celled; the seeds are many, disposed in cells in a double order. The valves after maturity are divaricated, even to the base, and winged inwards by the partition. The only species is the *Lobata*. This genus was first named *Solandra*, in honour of Dr Solander, by Murray in the 14th edition of the *Systema Vegetabilium*.

SOLANUM, in botany: A genus of the *monogynia* order, belonging to the *pentandria* class of plants; and in the natural method ranking under the 28th order, *Luridæ*. The calyx is inferior; the corolla is rotate, and generally monophyllous; the fruit a berry, bilocular, and containing many small and flat seeds. Of this genus there are 66 species, most of them natives of the East and West Indies. The most remarkable of which are the following.

1. The *Dulcamara*, a native of Britain and of Africa

*Solanum.* is a slender climbing plant, rising to six or more feet in height. The leaves are generally oval, pointed, and of a deep green colour; the flowers hang in loose clusters, of a purple colour, and divided into five pointed segments. The calyx is purple, persistent, and divided into five. The five filaments are short, black, and inserted into the tube of the corolla. The antheræ yellow, erect, and united in a point as usual in this genus. The style is long, and terminates in an obtuse stigma. The berry, when ripe, is red, and contains many flat yellowish seeds. It grows in hedges well supplied with water, and flowers about the end of June. On chewing the roots, we first feel a bitter, then a sweet, taste; hence the name. The berries are said to be poisonous, and may easily be mistaken by children for currants. The *stipites* or younger branches are directed for use, and may be employed either fresh or dried: they should be gathered in the autumn. This plant is generally given in decoction or infusion. Razou directs the following: Take dried dulcamara twigs half a dram, and pour upon it 16 ounces of spring water, which must be boiled down to 8 ounces; then strain it. Three or four tea spoonfuls to be taken every four hours, diluted with milk to prevent its exciting a nausea. Several authors take notice, that the dulcamara partakes of the milder powers of the nightshade, joined to a resolvent and saponaceous quality; hence it promotes the secretions of urine, sweat, the menses, and lochia. It is recommended in a variety of disorders; but particularly in rheumatisms, obstructed menses, and lochia, also in some obstinate cutaneous diseases.

2. The *Nigrum*, common in many places in Britain about dunghills and waste places. It rises to about two feet in height. The stalk herbaceous, the leaves alternate, irregularly oval, indented, and clothed with soft hairs. The flowers are white; the berries black and shining. It appears to possess the deleterious qualities of the other nightshades in a very high degree, and even the smell of the plant is said to cause sleep. The berries are equally poisonous with the leaves; causing *cardialgia*, and *delirium*, and violent distortions of the limbs in children. Mr Getaker in 1757 recommended its internal use in old sores, in scrofulous and cancerous ulcers, cutaneous eruptions, and in dropsies. He says, that one grain infused in an ounce of water sometimes produced a considerable effect; that in the dose of two or three grains it seldom failed to evacuate the first passages, to increase very sensibly the discharges by the skin and kidneys, and sometimes to occasion headach, drowiness, giddiness, and dimness of sight. Mr Broomfield declares, that in cases in which he tried this solanum, they were much aggravated by it; and that in one case in the dose of one grain it proved mortal to one of his patients; therefore he contends its use is prejudicial. This opinion seems tacitly to be confirmed, as it is now never given internally. In ancient times it was employed externally as a discutient and anodyne in some cutaneous affections, tumefactions of the glands, ulcers, and disorders of the eyes. The *solanum nigrum rubrum*, a native of the West Indies, is called *gumá* by the negroes. It is so far from having any deleterious quality, that it is daily served up at table as greens or spinach. It has an agreeable bitter taste.

3. *Lycopersum*, the love-apple, or tomato, cultivated in gardens in the warmer parts of Europe and in all tropic

Solanum  
||  
Solder.

pical countries. The stalk is herbaceous, the leaves pinnated, oval, pointed, and deeply divided. The flowers are on simple racemi: they are small and yellow. The berry is of the size of a plum; they are smooth, shining, soft; and are either of a yellow or reddish colour. The tomato is in daily use; being either boiled in soups or broths, or served up boiled as garnishes to flesh-meats.

4. *Melongena*, the egg-plant, or vegetable egg. This is also cultivated in gardens, particularly in Jamaica. It seldom rises above a foot in height. The stalk is herbaceous and smooth; the leaves oval and downy; the flowers are large and blue; the fruit is as big, and very like, the egg of a goose. It is often used boiled as a vegetable along with animal food or butter, and supposed to be aphrodisiac and to cure sterility.

5. *Longum*. This plant is also herbaceous, but grows much ranker than the foregoing. The flowers are blue; and the fruit is six or eight inches long, and proportionally thick. It is boiled and eaten at table as the egg-plant.

6. *Tuberosum*, the common potato. See POTATO.

SOLAR, something belonging to the SUN.

SOLAR-Spots. See ASTRONOMY-Index.

SOLDAN. See SULTAN.

SOLDANELLA, in botany: A genus of plants belonging to the class of *pentandria*, and order of *monogynia*; and in the natural system arranged under the 21st order, *Precia*. The corolla is campanulated; the border being very finely cut into a great many segments. The capsule is unilocular, and its apex polydentate.

SOLDER, SODDER, or *Soder*, a metallic or mineral composition used in soldering or joining together other metals.

Solders are made of gold, silver, copper, tin, bismuth, and lead; usually observing, that in the composition there be some of the metal that is to be soldered mixed with some higher and finer metals. Goldsmiths usually make four kinds of folder, viz. folder of eight, where to seven parts of silver there is one of brass or copper; folder of six, where only a sixth part is copper; folder of four, and folder of three. It is the mixture of copper in the folder that makes raised plate come always cheaper than flat.

As mixtures of gold with a little copper are found to melt with less heat than pure gold itself, these mixtures serve as folders for gold: two pieces of fine gold are soldered by gold that has a small admixture of copper; and gold alloyed with copper is soldered by such as is alloyed with more copper: the workmen add a little silver as well as copper, and vary the proportions of the two to one another, so as to make the colour of the folder correspond as nearly as may be to that of the piece. A mixture of gold and copper is also a folder for fine copper as well as for fine gold. Gold being particularly disposed to unite with iron, proves an excellent folder for the finer kinds of iron and steel instruments.

The folder used by plumbers is made of two pounds of lead to one of block-tin. Its goodness is tried by melting it, and pouring the bigness of a crown-piece on a table; for, if good, there will arise little bright shining stars therein. The folder for copper is made like that of the plumbers; only with copper and tin; and for

very nice works, instead of tin, they sometimes use a quantity of silver. Solder for tin is made of two-thirds of tin and one of lead, or of equal parts of each; but where the work is any thing delicate, as in organ-pipes, where the juncture is scarce discernible, it is made of one part of bismuth and three parts of pewter. The pewterers use a kind of folder made with two parts of tin and one of bismuth; this composition melts with the least heat of any of the folders.

Silver folder is that which is made of two parts of silver and one of brass, and used in foldering those metals. Spelter folder is made of one part of brass and two of spelter or zinc, and is used by the braziers and copper-smiths for foldering brass, copper, and iron. This folder is improved by adding to each ounce of it one pennyweight of silver; but as it does not melt without a considerable degree of heat, it cannot be used when it is inconvenient to heat the work red-hot; in which case copper and brass are foldered with silver.

Though spelter folder be much cheaper than silver-folder, yet workmen in many cases prefer the latter. And Mr Boyle informs us, that he has found it to run with so moderate a heat, as not much to endanger the melting of the delicate parts of the work to be foldered; and if well made, this silver folder will lie even upon the ordinary kind itself; and so fill up those little cavities that may chance to be left in the first operation, which is not easily done without a folder more easily fusible than the first made use of. As to iron, it is sufficient that it be heated to a white heat, and the two extremities, in this state, be hammered together; by which means they become incorporated one with the other.

SOLDERING, the joining and fastening together of two pieces of the same metal, or of two different metals, by the fusion and application of some metallic composition on the extremities of the metals to be joined.

To solder upon silver, brass, or iron: Take silver, five pennyweights; brass, four pennyweights; melt them together for soft folder, which runs soonest. Take silver, five pennyweights; copper, three pennyweights; melt them together for hard folder. Beat the folder thin, and lay it on the place to be foldered, which must be first fitted and bound together with wire as occasion requires; then take borax in powder, and temper it like pap, and lay it upon the folder, letting it dry; then cover it with live coals, and blow, and it will run immediately; take it presently out of the fire, and it is done. It is to be observed, that if any thing is to be foldered in two places, which cannot well be done at one time, you must first folder with the harder folder, and then with the soft; for if it be first done with the soft, it will unfold again before the other is fastened. Let it be observed, that if you would not have your folder run about the piece that is to be foldered, you must rub such places over with chalk—In the foldering either of gold, silver, copper, or either of the metals above mentioned, there is generally used borax in powder, and sometimes rosin. As to iron, it is sufficient that it be heated red-hot, and the two extremities thus hammered together, by which means they will become incorporated with each other. For the finer kinds of iron and steel instruments, however, gold proves an excellent folder. This metal will dissolve twice or thrice its weight of iron in a degree of heat very far less than that in which iron itself melts; hence if a small plate of gold

gold is wrapped round the parts to be joined, and afterwards melted by a blow-pipe, it strongly unites the pieces together without any injury to the instrument, however delicate.

**SOLDIER**, a military man listed to serve a prince or state in consideration of a certain daily pay.

*SOLDIER-Grub.* See **CANCER**

*Fresh Water SOLDIER.* See **STRATIOTES**.

**SOLE**, in the manege, a sort of horn under a horse's foot, which is much more tender than the other horn that encompasses the foot, and by reason of its hardness is properly called the *horn* or *hoof*.

**SOLE**, in ichthyology. See **PLEURONECTES**.

**SOLEA.** See **SANDAL** and **SHOE**.

**SOLECISM**, in grammar, a false manner of speaking, contrary to the rules of grammar, either in respect of declension, conjugation, or syntax.—The word is Greek, *σολοικισμός*, derived from the *Soli*, a people of Attica, who being transplanted to Cilicia, lost the purity of their ancient tongue, and became ridiculous to the Athenians for the improprieties into which they fell.

**SOLEMN**, something performed with much pomp, ceremony, and expence. Thus we say, solemn feasts, solemn funerals, solemn games, &c.—In law, *solemn* signifies something authentic, or what is clothed in all its formalities.

**SOLEN**, **RAZOR-SHEATH**, or *Knife-handle Shell*; a genus belonging to the class of *vermes*, and order of *testacea*. The animal is an ascidia. The shell is bivalve, oblong, and opening at both sides: the hinge has a tooth shaped like an awl, bent back, often double, not inserted into the opposite shell; the rim at the sides somewhat worn away, and has a horny cartilaginous hinge. There are 23 species. Three of them, viz. the siliqua, vagina, and ensis, are found on the British coasts, and lurk in the sand near the low-water mark in a perpendicular direction. When in want of food they elevate one end a little above the surface, and protrude their bodies far out of the shell. On the approach of danger they dart deep into the sand, sometimes two feet at least. Their place is known by a small dimple on the surface. Sometimes they are dug out with a shovel; at other times they are taken by striking a barbed dart suddenly into them. When the sea is down, these fish usually run deep into the sand; and to bring them up, the common custom is to throw a little salt into the holes, on which the fish raises itself, and in a few minutes appears at the mouth of its hole. When half the shell is discovered, the fisherman has nothing more to do than to take hold of it with his fingers and draw it out: but he must be cautious not to lose the occasion, for the creature does not continue a moment in that state; and if by any means the fisherman has touched it, and let it slip away, it is gone for ever; for it will not be decoyed again out of its hole by salt; so that there is then no way of getting it but by digging under it, and throwing it up with the sand. The fish has two pipes, each composed of four or five rings or portions of a hollow cylinder, of unequal lengths, joined one to another; and the places where they join are marked by a number of fine streaks or rays. Now the reason why the salt makes these creatures come up out of their holes, is, that it gives them violent pain, and even corrodes these pipes. This is somewhat strange,

as the creature is nourished by means of salt-water; but it is very evident, that if a little salt be strewed upon these pipes in a fish taken out of its habitation, it will corrode the joinings of the rings, and often make one or more joints drop off: the creature, to avoid this mischief, arises out of its hole, and throws off the salt, and then retires back again. The use of these pipes to the animal is the same with that of many other pipes of a like kind in other shell-fish; they all serve to take in water: they are only a continuation of the outer membrane of the fish, and serve indifferently for taking in and throwing out the water, one receiving, and the other discharging it, and either answering equally well to their purpose. See *Animal MOTION*.

This fish was used as food by the ancients; and Athenæus, from Sopliron, speaks of it as a great delicacy, and particularly grateful to widows. It is often used as food at present, and is brought up to table fried in eggs.

**SOLEURE**, a canton of Swisserland, which holds the 11th rank in the Helvetic confederacy, into which it was admitted in the year 1481. It stretches partly through the plain, and partly along the chains of the Jura, and contains about 50,000 inhabitants. It is 35 miles in length from north to south, and 35 in breadth from east to west. The soil for the most part is exceedingly fertile in corn; and the districts within the Jura abound in excellent pastures. The trade both of the town and canton is of little value, although they are very commodiously situated for an extensive commerce. It is divided into 11 bailiwicks, the inhabitants of which are all Roman Catholics except those of the bailiwick of Buekeberg, who profess the reformed religion. The sovereign power resides in the great council, which, comprising the senate or little council of 36, consists of 102 members, chosen by the senate in equal proportions from the 11 tribes or companies into which the ancient burghers are distributed; and, owing to the distinction between the ancient and the new burghers (the former consisting of only 85 families) the government is a complete aristocracy.

**SOLEURE**, an ancient and extremely neat town of Swisserland, capital of the canton of the same name. It contains about 4000 inhabitants, and is pleasantly seated on the Aar, which here expands into a noble river: Among the most remarkable objects of curiosity in this town is the new church of St Urs, which was begun in 1762 and finished in 1772. It is a noble edifice of a whitish grey stone, drawn from the neighbouring quarries, which admits a polish, and is a species of rude marble. The lower part of the building is of the Corinthian, the upper of the Composite order. The façade, which consists of a portico, surmounted by an elegant tower, presents itself finely at the extremity of the principal street. It cost at least L. 80,000, a considerable sum for such a small republic, whose revenue scarcely exceeds L. 12,000 a year. Soleure is surrounded by regular stone fortifications, and is 20 miles north-east of Bern, 27 south south-west of Basle, and 45 west of Zurich. E. Long 7. 20. N. Lat. 47. 15.

**SOLFAING**, in music, the naming or pronouncing the several notes of a song by the syllables *ut, re, mi, fa, sol*, &c. in learning to sing it.

Of the seven notes in the French scale *ut, re, mi, fa, sol, la, si*, only four are used among us in singing, as

Soleure,  
Solfaing.

Solfaing.  
Solfaterra.

*mi, fa, sol, la*: their office is principally, in singing, that by applying them to every note of the scale, it may not only be pronounced with more ease, but chiefly that by them the tones and semitones of the natural scale may be better marked out and distinguished. This design is obtained by the four syllables *fa, sol, la, mi*. Thus from *fa* to *sol* is a tone, also from *sol* to *la*, and from *la* to *mi*, without distinguishing the greater or less tone; but from *la* to *fa*, also from *mi* to *fa*, is only a semitone. If then these be applied in this order, *fa, sol, la, fa, sol, la, mi, fa*, &c. they express the natural series from C; and if that be repeated to a second or third octave, we see by them how to express all the different orders of tones and semitones in the diatonic scale; and still above *mi* will stand *fa, sol, la*, and below it the same inverted *la, sol, fa*, and one *mi* is always distant from another an octave; which cannot be said of any of the rest, because after *mi* ascending come always *fa, sol, la*, which are repeated invertedly descending.

To conceive the use of this, it is to be remembered, that the first thing in learning to sing, is to make one raise a scale of notes by tones and semitones to an octave, and descend again by the same; and then to rise and fall by greater intervals at a leap, as thirds and fourths, &c. and to do all this by beginning at notes of different pitch. Then those notes are represented by lines and spaces, to which these syllables are applied, and the learners taught to name each line and space thereby, which makes what we call *solfaing*; the use whereof is, that while they are learning to tune the degrees and intervals of sound expressed by notes on a line or space, or learning a song to which no words are applied, they may not only do it the better by means of articulate sounds, but chiefly that by knowing the degrees and intervals expressed by those syllables, they may more readily know the places of the semitones, and the true distance of the notes. See the article SINGING.

SOLFATERRA, a mountain of Italy in the kingdom of Naples, and Terra di Lavoro. This mountain appears evidently to have been a volcano in ancient times; and the soil is yet so hot, that the workmen employed there in making alum need nothing else besides the heat of the ground for evaporating their liquids. Of this mountain we have the following account by Sir William Hamilton. "Near Astruni (another mountain, formerly a volcano likewise) rises the Solfaterra, which not only retains its cone and crater, but much of its former heat. In the plain within the crater, smoke issues from many parts, as also from its sides: here, by means of stones and tiles heaped over the crevices, through which the smoke passes, they collect in an aukward manner what they call *sale armoniaco*; and from the sand of the plain they extract sulphur and alum. This spot, well attended to, might certainly produce a good revenue, whereas I doubt if they have hitherto ever cleared L. 200 a-year by it. The hollow

found produced by throwing a heavy stone on the plain of the crater of the Solfaterra, seems to indicate that it is supported by a sort of arched natural vault; and one is induced to think that there is a pool of water beneath this vault (which boils by the heat of a subterraneous fire still deeper), by the very moist steam that issues from the cracks in the plain of the Solfaterra, which, like that of boiling water, runs off a sword or knife, presented to it, in great drops. On the outside, and at the foot of the cone of the Solfaterra, towards the lake of Agnano, water rushes out of the rocks so hot as to raise the quicksilver in Fahrenheit's thermometer to the degree of boiling water ( $\Delta$ ); a fact of which I was myself an eye-witness. This place, well worthy the observation of the curious, has been taken little notice of; it is called the *Pisciarelli*. The common people of Naples have great faith in the efficacy of this water; and make much of it in all cutaneous disorders, as well as for another disorder that prevails here. It seems to be impregnated chiefly with sulphur and alum. When you approach your ear to the rocks of the Pisciarelli, from whence this water ouzes, you hear a horrid boiling noise, which seems to proceed from the huge cauldron that may be supposed to be under the plain of the Solfaterra. On the other side of the Solfaterra, next the sea, there is a rock which has communicated with the sea, till part of it was cut away to make the road to Puzzole; this was undoubtedly a considerable lava, that ran from the Solfaterra when it was an active volcano. Under this rock of lava, which is more than 70 feet high, there is a stratum of pumice and ashes. This ancient lava is about a quarter of a mile broad; you meet with it abruptly before you come in sight of Puzzole, and it finishes as abruptly within about 100 paces of the town. The ancient name of the Solfaterra was *Forum Vulcani*; a strong proof of its origin from subterraneous fire. The degree of heat that the Solfaterra has preserved for so many ages, seems to have calcined the stones upon its cone and in its crater, as they are very white and crumble easily in the hottest parts. See CHEMISTRY, n<sup>o</sup> 656.

SOLICITOR, a person employed to take care of and manage suits depending in the courts of law or equity. Solicitors are within the statute to be sworn, and admitted by the judges, before they are allowed to practise in our courts, in like manner as attorneys.

There is also a great officer of the law, next to the attorney-general, who is styled the king's solicitor-general; who holds his office by patent during the king's pleasure, has the care and concern of managing the king's affairs, and has fees for pleading, besides other fees arising by patents, &c. He attends on the privy-council; and the attorney-general and he were anciently reckoned among the officers of the exchequer; they have their audience, and come within the bar in all other courts.

SOLID, in philosophy, a body whose parts are so firmly

( $\Delta$ ) "I have remarked, that after a great fall of rain, the degree of heat in this water is much less; which will account for what Padre Toire says (in his book, intitled *Histoire et Phenomenes du Vesuve*), that when he tried it in company with Monsieur de la Condamine, the degree of heat, upon Reaumur's thermometer, was 68 $^{\circ}$ .

*Solidity.* firmly connected together, as not easily to give way or slip from each other; in which sense *solid* stands opposed to *fluid*.

Geometricians define a solid to be the third species of magnitude, or that which has three dimensions, viz. length, breadth, and thickness or depth.

Solids are commonly divided into regular and irregular. The regular solids are those terminated by regular and equal planes, and are only five in number, viz. the tetrahedron, which consists of four equal triangles; the cube or hexahedron, of six equal squares; the octahedron, of eight equal triangles; the dodecahedron, of twelve; and the icosahedron, of twenty equal triangles.

The irregular solids are almost infinite, comprehending all such as do not come under the definition of regular solids; as the sphere, cylinder, cone, parallelogram, prism, paralleliped, &c.

SOLIDS, in anatomy, are the bones, ligaments, membranes, muscles, nerves and vessels, &c.

The solid parts of the body, though equally composed of vessels, are different with regard to their consistence; some being hard and others soft. The hard, as the bones and cartilages, give firmness and attitude to the body, and sustain the other parts: the soft parts, either alone or together with the hard, serve to execute the animal functions. See ANATOMY.

SOLIDAGO, in botany: A genus of plants belonging to the class of *syngenesia*, and to the order of *polygamia superflua*; and in the natural system ranging under the 49th order, *Compositæ*. The receptacle is naked; the pappus simple; the radii are commonly five; the scales of the calyx are imbricated and curved inward. There are 14 species; *sempervirens*, *canadensis*, *altissima*, *lateriflora*, *bicolor*, *lanceolata*, *cœsia*, *mexicana*, *flexicaulis*, *latifolia*, *virgaurea*, *minuta*, *rigida*, *novboracensis*. Among these there is only one species, which is a native of Britain, the *virgaurea*, or golden rod, which grows frequently in rough mountainous pastures and woods. The stems are branched, and vary from six inches to five feet high, but their common height is about a yard. The leaves are a little hard and rough to the touch; the lower ones oval-lanceolate, generally a little serrated and supported on footstalks; those on the stalks are elliptical; the flowers are yellow, and grow in spikes from the ax of the leaves; the scales of the calyx are lanceolate, of unequal length, and of a pale green colour; the female florets in the rays are from five to eight in number; the hermaphrodite flowers in the disc from ten to twelve. There is a variety of this species called *cambrica* to be found on rocks from six inches to a foot high.

SOLIDITY, that property of matter, or body, by which it excludes all other bodies from the place which itself possesses; and as it would be absurd to suppose that two bodies could possess one and the same place at the same time, it follows, that the softest bodies are equally solid with the hardest. See METAPHYSICS, n<sup>o</sup> 44. 173. &c.

Among geometricians, the solidity of a body denotes the quantity or space contained in it, and is called also its solid content.

The solidity of a cube, prism, cylinder, or paralleliped, is had by multiplying its basis into its height. The solidity of a pyramid or cone is had by mul-

tiplying either the whole base into a third part of the height, or the whole height into a third part of the base.

SOLILOQUY, a reasoning or discourse which a man holds with himself; or, more properly, according to Papias, it is a discourse by way of answer to a question that a man proposes to himself.

Soliloquies are become very common on the modern stage; yet nothing can be more inartificial, or more unnatural, than an actor's making long speeches to himself, to convey his intentions to the audience. Where such discoveries are necessary to be made, the poet should rather take care to give the dramatic persons such confidants as may necessarily share their inmost thoughts; by which means they will be more naturally conveyed to the audience; yet even this is a shift which an accurate poet would not have occasion for. The following lines of the duke of Buckingham concerning the use and abuse of soliloquies deserve attention:

Soliloquies had need be very few,  
Extremely short, and spoke in passion too.  
Our lovers talking to themselves, for want  
Of others, make the pit their confidant:  
Nor is the matter mended yet, if thus  
They trust a friend, only to tell it us.

SOLIMAN II. emperor of the Turks, surnamed the *Magnificent*, was the only son of Selim I. whom he succeeded in 1520. He was educated in a manner very different from the Ottoman princes in general; for he was instructed in the maxims of politics and the secrets of government. He began his reign by restoring those persons their possessions whom his father had unjustly plundered. He re-established the authority of the tribunals, which was almost annihilated, and bestowed the government of provinces upon none but persons of wealth and probity: "I would have my viceroys (he used to say) resemble those rivers that fertilize the fields through which they pass, not those torrents which sweep every thing before them."

After concluding a truce with Ismael Sophy of Persia, and subduing Gozeli Bey, who had raised a rebellion in Syria, he turned his arms against Europe. Belgrade was taken in 1521, and Rhodes fell into his hands the year following, after an obstinate and enthusiastic defence. In 1526 he defeated and slew the king of Hungary in the famous battle of Mohatz. Three years after he conquered Buda, and immediately laid siege to Vienna itself. But after continuing 20 days before that city, and assailing it 20 times, he was obliged to retreat with the loss of 80,000 men. Some time after he was defeated by the Persians, and disappointed in his hopes of taking Malta. He succeeded, however, in dispossessing the Genoese of Chio, an island which had belonged to that republic for more than 200 years.

He died at the age of 76, while he was besieging Sigeth, a town in Hungary, on the 3<sup>rd</sup> August 1566.

He was a prince of the strictest probity; a lover of justice, and vigorous in the execution of it; but he tarnished all his glory by the cruelty of his disposition. After the battle of Mohatz he ordered 1500 prisoners, most of them gentlemen, to be raned in a circle, and beheaded in presence of his whole army.

Solipuga  
||  
Solomon.

Soliman thought nothing impossible which he commanded: A general having received orders to throw a bridge over the Drave, wrote him, that it was impossible. The sultan sent him a long band of linen with these words written on it: "The emperor Soliman, thy master, orders thee to build a bridge over the Drave in spite of the difficulties thou mayest meet with. He informs thee at the same time, that if the bridge be not finished upon his arrival, he will hang thee with the very linen which informs thee of his will."

SOLIPUGA, or SOLIFUGA, in natural history, the name given by the Romans to a small venomous insect of the spider-kind, called by the Greeks *belio-centros*; both words signifying an animal which flings most in the country, and seasons where the sun is most hot. Solinus makes this creature peculiar to Sardinia; but this is contrary to all the accounts given us by the ancients. It is common in Africa and some parts of Europe. Almost all the hot countries produce this venomous little creature. It lies under the sand to seize other insects as they go by; and if it meet with any uncovered part of a man, produces a wound which proves very painful: it is said that the bite is absolutely mortal, but probably this is not true. Solinus writes the word *solifuga*, and so do many others, erroneously deriving the name from the notion that this animal flies from the sun's rays, and buries itself in the sand.

SOLIS (Antonio de), an ingenious Spanish writer, of an ancient and illustrious family, born at Placenza in Old Castile, in 1610. He was intended for the law; but his inclination toward poetry prevailed, and he cultivated it with great success. Philip IV. of Spain made him one of his secretaries; and after his death the queen-regent appointed him historiographer of the Indies, a place of great profit and honour: his History of the Conquest of Mexico shows that she could not have named a fitter person. He is better known by his history at least abroad, than by his poetry and dramatic writings, though in these he was also distinguished. He turned priest at 57 years of age, and died in 1686.

SOLITARY, that which is remote from the company or commerce of others of the same species.

SOLITARIES, a denomination of nuns of St Peter of Aleantara, instituted in 1676, the design of which was to imitate the severe penitent life of that saint. Thus they are to keep a continual silence, never to open their mouths to a stranger; to employ their time wholly in spiritual exercises, and leave their temporal concerns to a number of maids, who have a particular superior in a separate part of the monastery: they always go bare-footed, without sandals; gird themselves with a thick cord, and wear no linen.

SOLO in the Italian music, is frequently used in pieces consisting of several parts, to mark those that are to perform alone; as *fauto solo*, *violino solo*. It is also used for sonatas composed for one violin, one German flute, or other instrument, and a bass; thus we say, *Corelli's solos*, *Geminiani's solos*, &c. When two or three parts play or sing separately from the grand chorus, they are called *doi soli*, *a tre soli*, &c. Solo is sometimes denoted by S.

SOLOMON, the son of David king of Israel, renowned in Scripture for his wisdom, riches, and magnificent temple and other buildings. Towards the end of his life he sullied all his former glory by his apostasy

from God; from which cause vengeance was denounced against his house and nation. He died about 975 B. C.

*SOLOMON'S Seal*, in botany; a species of *CONVALLARIA*.

SOLON, one of the seven wise men of Greece, was born at Salamis, of Athenian parents, who were descended from Codrus. His father leaving little patrimony, he had recourse to merchandize for his subsistence. He had, however, a greater thirst after knowledge and fame than after riches, and made his mercantile voyages subservient to the increase of his intellectual treasures. He very early cultivated the art of poetry, and applied himself to the study of moral and civil wisdom. When the Athenians, tired out with a long and troublesome war with the Megarensians, for the recovery of the isle of Salamis, prohibited any one, under pain of death, to propose the renewal of their claim to that island, Solon thinking the prohibition dishonourable to the state, and finding many of the younger citizens desirous to revive the war, feigned himself mad, and took care to have the report of his insanity spread thro' the city. In the mean time he composed an elegy adapted to the state of public affairs, which he committed to memory. Every thing being thus prepared, he sallied forth into the market-place with the kind of cap on his head which was commonly worn by sick persons, and, ascending the herald's stand, he delivered, to a numerous crowd, his lamentation for the desertion of Salamis. The verses were heard with general applause; and Pisistratus seconded his advice, and urged the people to renew the war. The decree was immediately repealed; the claim to Salamis was resumed; and the conduct of the war was committed to Solon and Pisistratus, who, by means of a stratagem, defeated the Megarensians, and recovered Salamis.

His popularity was extended through Greece in consequence of a successful alliance which he formed among the states in defence of the temple at Delphos against the Cirrheans. When dissensions had arisen at Athens between the rich creditors and their poor debtors, Solon was created archon, with the united powers of supreme legislator and magistrate. He soon restored harmony between the rich and poor: He cancelled the debts, which had proved the occasion of so much oppression; and ordained that in future no creditor should be allowed to seize the body of the debtor for his security: He made a new distribution of the people, instituted new courts of judicature, and framed a judicious code of laws, which afterwards became the basis of the laws of the twelve tables in Rome. Among his criminal laws are many wise and excellent regulations; but the code is necessarily defective with respect to those principles which must be derived from the knowledge of the true God, and of pure morality, as the certain foundations of national happiness. Two of them in particular were very exceptionable; the permission of a voluntary exile to persons that had been guilty of premeditated murder, and the appointment of a less severe punishment for a rape than for seduction. Those who wish to see accurately stated the comparative excellence of the laws of Moses, of Lycurgus, and Solon, may consult Prize Dissertations relative to Natural and Revealed Religion by Teyler's Theological Society, Vol. IX.

The interview which Solon is said to have had with Cræsus

Solomon  
Solon.

Solstice  
||  
mbrero.

Cræsus king of Lydia, the solid remarks of the sage after surveying the monarch's wealth, the recollection of those remarks by Cræsus when doomed to die, and the noble conduct of Cyrus on that occasion, are known to every schoolboy. Solon died in the island of Cyprus, about the 80th year of his age. Statues were erected to his memory both at Athens and Salamis. His thirst after knowledge continued to the last: "I grow old (said he) learning many things." Among the apothegms and precepts which have been ascribed to Solon, are the following: Laws are like cobwebs, that entangle the weak, but are broken through by the strong. He who has learned to obey, will know how to command. In all things let reason be your guide. Diligently contemplate excellent things. In every thing that you do, consider the end.

SOLSTICE, in astronomy, that time when the sun is in one of the solstitial points; that is, when he is at his greatest distance from the equator; thus called because he then appears to stand still, and not to change his distance from the equator for some time; an appearance owing to the obliquity of our sphere, and which those living under the equator are strangers to.

The solstices are two in each year; the æstival or summer solstice, and the hyemal or winter solstice. The summer solstice is when the sun seems to describe the tropic of cancer, which is on June 22. when he makes the longest day: the winter solstice is when the sun enters the first degree, or seems to describe the tropic of capricorn, which is on December 22. when he makes the shortest day. This is to be understood as in our northern hemisphere; for in the southern, the sun's entrance into capricorn makes the summer solstice, and that into cancer the winter solstice. The two points of the ecliptic, wherein the sun's greatest ascent above the equator, and his descent below it, are terminated, are called the *solstitial points*; and a circle, supposed to pass through the poles of the world and these points, is called the *solstitial colure*. The summer solstitial point is in the beginning of the first degree of cancer, and is called the *æstival or summer point*; and the winter solstitial point is in the beginning of the first degree of capricorn, and is called the *winter point*. These two points are diametrically opposite to each other.

SOLUTION, in chemistry, denotes an intimate union of solid with fluid bodies, so as to form a transparent liquor. See DISSOLUTION, and *Index to CHEMISTRY*.

*SOLUTION of Metals.* See *METALS (Solution of)*.

SOLVENT, that which dissolves a solid body into a transparent fluid.

SOLWAY MOSS. See *Moving Moss*.

SOMBRERO, the name of an uninhabited island in the West Indies in the form of an hat, whence the name is derived. It is also the name of one of the Nicobar islands in the East Indies.

*Wonderful Plant of SOMBRERO*, is a strange kind of sensitive plant growing in the East Indies, in sandy bays and in shallow water. It appears like a slender straight stick; but when you attempt to touch it, immediately withdraws itself into the sand. Mr Miller gives an account of it in his description of Sumatra. He says, the Malays call it *lilan laut*, that is, sea grass. He never could observe any tentacula; but, after many unsuccessful attempts, drew out a broken piece about a foot

long. It was perfectly straight and uniform, and resembled a worm drawn over a knitting needle. When dry it appears like a coral.

Somers,  
Somerfet-  
shire.

SOMERS (John), lord high chancellor of England, was born at Worcester in 1652. He was educated at Oxford, and afterwards entered himself at the Middle Temple, where he studied the law with great vigour. In 1688 he was one of the counsel for the seven bishops at their trial, and argued with great learning and eloquence against the dispensing power. In the convention which met by the prince of Orange's summons, January 22. 1689, he represented Worcester; and was one of the managers for the House of Commons, at a conference with the House of Lords upon the word *abdicated*. Soon after the accession of King William and Queen Mary to the throne, he was appointed solicitor-general, and received the honour of knighthood. In 1692 he was made attorney general, and in 1693 advanced to the post of lord keeper of the great seal of England. In 1695 he proposed an expedient to prevent the practice of clipping the coin. In 1697 he was created lord Somers, baron of Evesham, and made lord high chancellor of England. In the beginning of 1700 he was removed from his post of lord chancellor, and the year after was impeached of high crimes and misdemeanors by the House of Commons, of which he was acquitted upon trial by the House of Lords. He then retired to a studious course of life, and was chosen president of the Royal Society. In 1706 he proposed a bill for the regulation of the law; and the same year was one of the principal managers for the union between England and Scotland. In 1708 he was made lord president of the council; from which post he was removed in 1710, upon the change of the ministry. In the latter end of Queen Anne's reign his lordship grew very infirm in his health; which is supposed to be the reason that he held no other post than a seat at the council-table, after the accession of King George I. He died of an apoplectic fit in 1716. Mr Addison has drawn his character very beautifully in the *Freeholder*.

SOMERSETSHIRE, a county of England, taking its name from Somerton, once the capital, between 50° and 51° 27' north latitude, and between 1° 25' and 2° 39' west longitude. It is bounded on the west by Devonshire, on the south by Dorsetshire, on the north by Bristol Channel or the Severn Sea, on the north-east by a small part of Gloucestershire, and on the east by Wiltshire. It is one of the largest counties in England, extending in length from east to west about 68 miles; in breadth, where broadest, from south to north, about 47; and 240 in circumference. It is divided into 42 hundreds, in which are 3 cities, 32 market towns, 1700 villages, 385 parishes of which 132 are vicarages, containing more than 1,000,000 of acres, and about 300,000 souls. It sends 18 members to Parliament, viz. two for the county, two for Bristol, two for Bath, two for Wells, two for Taunton, two for Bridgewater, two for Hechester, two for Milbourn-port, and two for Minehead.

The air of this county is very mild and wholesome, especially that of the hilly part. The soil in general is exceeding rich, so that single acres very commonly produce forty or fifty bushels of wheat, and there have been instances of some producing sixty of barley. As there is very fine pasture both for sheep and black cattle, it abounds in both, which are as large as those of

Somer-  
shire  
||  
Sonata.

Lincolnshire, and their flesh of a finer grain. In consequence of this abundance of black cattle, great quantities of cheese are made in it, of which that of Cheddar is thought equal to Parmesan. In the hilly parts are found coal, lead, copper, and lapis calaminaris. Wood thrives in it as well as in any county of the kingdom. It abounds also in pease, beans, beer, cyder, fruit, wild-fowl, and salmon; and its mineral waters are celebrated all over the world.

The riches of this county, both natural and acquired, exceed those of any other in the kingdom, Middlesex and Yorkshire excepted. The woollen manufacture in all its branches is carried on to a very great extent; and in some parts of the county great quantities of linen are made. If to these the produce of various other commodities in which it abounds is added, the amount of the whole must undoubtedly be very great. Its foreign trade must also be allowed to be very extensive, when it is considered that it has a large trade for sea coal, and possesses, besides other ports, that of Bristol, a town of the greatest trade in England, next to London.

Besides small streams, it is well watered and supplied with fish by the rivers Severn, Avon, Parrel, Froome, Ax, Torre, and Tone. Its greatest hills are Mendip, Poulton, and Quantock, of which the first abounds in coal, lead, &c. The rivers Severn and Parrel breed very fine salmon. The chief town is Bristol.

SOMERTON, an ancient town in Somersetshire, from whence the county derives its name. It is 123 miles from London; it has five streets, containing 251 houses, which are mostly built of the blue stone from the quarries in the neighbourhood. It is governed by constables, and has a hall for petty sessions. The market for corn is considerable, and it has several fairs for cattle. The church has what is not very frequent, an octangular tower with six bells. N. Lat. 51.4. W. Long. 1. 53.

SOMNAMBULI, persons who walk in their sleep. See SLEEPWALKERS.

SOMNER (William), an eminent English antiquary, was born at Canterbury in 1606. His first treatise was *The Antiquities of Canterbury*, which he dedicated to Archbishop Laud. He then applied himself to the study of the Saxon language; and having made himself master of it, he perceived that the old glossary prefixed to Sir Roger Twissen's edition of the laws of King Henry I. printed in 1644, was faulty in many places; he therefore added to that edition notes and observations valuable for their learning, with a very useful glossary. His *Treatise of Gavelkind* was finished about 1648, though not published till 1660. Our author was zealously attached to King Charles I. and in 1648 he published a poem on his sufferings and death. His skill in the Saxon tongue led him to inquire into most of the European languages ancient and modern. He assisted Dugdale and Dodsworth in compiling the *Monasticon Anglicanum*. His *Saxon Dictionary* was printed at Oxford in 1659. He died in 1669.

SON, an appellation given to a male child considered in the relation he bears to his parents. See PARENT and FILIAL Piety.

SONATA, in music, a piece or composition, intend-

ed to be performed by instruments only; in which sense it stands opposed to *cantata*, or a piece designed for the voice. See CANTATA.

The sonata then, is properly a grand, free, humorous composition, diversified with a great variety of motions and expressions, extraordinary and bold strokes, figures, &c. And all this purely according to the fancy of the composer; who, without confining himself to any general rules of counterpoint, or to any fixed number or measure, gives a loose to his genius, and runs from one mode, measure, &c. to another, as he thinks fit. This species of composition had its rise about the middle of the 17th century; those who have most excelled in it were Bassani and Corelli. We have sonatas of 1, 2, 3, 4, 5, 6, 7, and even 8 parts, but usually they are performed by a single violin, or with two violins, and a thorough bass for the harpsichord; and frequently a more figured bass for the bass viol, &c.

There are a thousand different species of sonatas; but the Italians usually reduce them to two kinds. *Sonate de chiesa*, that is, sonatas proper for church music, which usually begin with a grave solemn motion, suitable to the dignity and sanctity of the place and the service, after which they strike into a brisker, gayer, and richer manner. These are what they more peculiarly call sonatas. *Sonate de camera*, or sonatas for the chamber, are properly serieses of several little pieces, for dancing, only composed to the same tune. They usually begin with a prelude or little sonata, serving as an introduction to all the rest: afterwards come the allemand, pavane, courant, and other serious dances; then jigs, gavots, minuets, chacons, passecailles, and other gayer airs: the whole composed in the same tune or mode.

SONCHUS, SOW-THISTLE, in botany: A genus of plants belonging to the class of *syngenesia*, and to the order of *polygamia equalis*; and in the natural system ranged under the 49th order, *Compositae*. The receptacle is naked; the calyx is imbricated, bellying and conical; the down of the seed is simple, sessile, and very soft; the seed is oval and pointed. There are 13 species; the *maritimus*, *palustris*, *fruticosus*, *arvensis*, *oleraceus*, *tenerrimus*, *plumieri*, *alpinus*, *floridanus*, *sibiricus*, *tataricus*, *tuberosus*, and *canadensis*. Four of these are natives of Britain.—1. *Palustris*, marsh sow-thistle. The stem is erect, from six to ten feet high, branched and hairy towards the top: the leaves are firm, broad, half pinnated, serrated, and sharp-pointed; the lower ones sagittate at the base: the flowers are of a deep yellow, large, and dispersed on the tops of the branches: the calyx is rough. It is frequent in marshes, and flowers in July or August.—2. *Arvensis*, corn sow-thistle. The leaves are alternate, runcinate, and heart-shaped at the base; the root creeps under ground; the stem is three or four feet high, and branched at the top. It grows in corn-fields, and flowers in August.—3. *Oleraceus*, common sow-thistle. The stalk is succulent, pistular, and a cubit high or more; the leaves are broad, embracing the stem, generally deeply sinuated, smooth or prickly at the edges; the flowers are of a pale yellow, numerous, in a kind of umbel, and terminal; the calyx is smooth. It is frequent in waste places and cultivated grounds.—4. *Alpinus*, blue-flowered sow-thistle. The stem is erect, purplish, branched, or simple, from three to six feet high: the leaves are large, smooth, and sinuated;

Sonata  
Sonata



*Song.* ated; the extreme segment large and triangular: the flowers are blue, and grow on hairy viscid pedicles, in long spikes: the calyx is brown. This species is found in Northumberland.

SONG, in poetry, a little composition, consisting of easy and natural verses, set to a tune in order to be sung. See *POETRY*, n° 120.

SONG, in music, is applied in general to a single piece of music, whether contrived for the voice or an instrument. See *AIR*.

*Song of Birds*, is defined by the honourable Daines Barrington to be a succession of three or more different notes, which are continued without interruption, during the same interval, with a musical bar of four crotchets in an adagio movement, or whilst a pendulum swings four seconds.

It is affirmed, that the notes of birds are no more innate than language in man, and that they depend upon imitation, as far as their organs will enable them to imitate the sounds which they have frequent opportunities of hearing: and their adhering so steadily, even in a wild state, to the same song, is owing to the nestlings attending only to the instruction of the parent bird, whilst they disregard the notes of all others that may perhaps be singing round them.

Birds in a wild state do not commonly sing above 10 weeks in the year, whereas birds that have plenty of food in a cage sing the greatest part of the year: and we may add, that the female of no species of birds ever sings. This is a wise provision of nature, because her song would discover her nest. In the same manner, we may rationally account for her inferiority in plumage. The faculty of singing is confined to the cock birds; and accordingly Mr Hunter, in dissecting birds of several species, found the muscles of the larynx to be stronger in the nightingale than in any other bird of the same size; and in all those instances, where he dissected both cock and hen, the same muscles were stronger in the cock. To the same purpose, it is an observation as ancient as the time of Pliny, that a capon does not crow.

Some have ascribed the singing of the cock-bird in the spring solely to the motive of pleasing his mate during incubation; others, who allow that it is partly for this end, believe it is partly owing also to another cause, viz. the great abundance of plants and insects in the spring, which, as well as seeds, are the proper food of singing birds at that time of the year.

Mr Barrington remarks, that there is no instance of any singing bird which exceeds our blackbird in size; and this, he supposes, may arise from the difficulty of its concealing itself, if it called the attention of its enemies, not only by its bulk, but by the proportionable loudness of its notes. This writer farther observes, that some passages of the song in a few kinds of birds correspond with the intervals of our musical scale, of which the cuckoo is a striking and known instance; but the greater part of their song cannot be reduced to a musical scale; partly, because the rapidity is often so

great, and it is also so uncertain when they may stop, that we cannot reduce the passages to form a musical bar in any time whatsoever; partly also, because the pitch of most birds is considerably higher than the most shrill notes of those instruments which have the greatest compass; and principally, because the intervals used by birds are commonly so minute, that we cannot judge of them from the more gross intervals into which we divide our musical octave. This writer apprehends, that all birds sing in the same key; and in order to discover this key, he informs us, that the following notes have been observed in different birds, A, B flat, C, D, F, and G; and therefore E only is wanting to complete the scale: now these intervals, he says, can only be found in the key of F with a sharp third, or that of G with a flat third; and he supposes it to be the latter, because, admitting that the first musical notes were learned from birds, those of the cuckoo, which have been most attended to, form a flat third, and most of our compositions are in a flat third, where music is simple, and consists merely of melody. As a farther evidence that birds sing always in the same key, it has been found by attending to a nightingale, as well as a robin which was educated under him, that the notes reducible to our intervals of the octave were always precisely the same.

Most people, who have not attended to the notes of birds, suppose, that every species sing exactly the same notes and passages: but this is by no means true; though it is admitted that there is a general resemblance. Thus the London bird-catchers prefer the song of the Kentish goldfinches, and Essex chaffinches; and some of the nightingale-fanciers prefer a Surry bird to those of Middlesex.

Of all singing birds, the song of the nightingale has been most universally admired: and its superiority (deduced from a caged bird) consists in the following particulars; its tone is much more mellow than that of any other bird, though at the same time, by a proper exertion of its musical powers, it can be very brilliant. Another point of superiority is its continuance or song without a pause, which is sometimes no less than 20 seconds; and when respiration becomes necessary, it takes it with as much judgment as an opera-singer. The skylark in this particular, as well as in compass and variety, is only second to the nightingale. The nightingale also sings (if the expression may be allowed) with superior judgment and taste. Mr Barrington has observed, that his nightingale, which was a very capital bird, began softly like the ancient orators; reserving its breath to swell certain notes, which by these means had a most astonishing effect. This writer adds, that the notes of birds, which are annually imported from Asia, Africa, and America, both singly and in concert, are not to be compared to those of European birds.

The following table, formed by Mr Barrington, agreeably to the idea of M. de Piles in estimating the merits of painters, is designed to exhibit the comparative merit of the British singing birds; in which 20 is supposed to be the point of absolute perfection.

Nightingale

Song  
||  
Sophi.  
Pbi. obical  
Translations  
vol. lxiii.

	Mellowness of tone.	Sprightly notes.	Primitive notes.	Compas.	Execution.
Nightingale - - -	19	14	19	19	19
Sky-lark - - -	4	19	4	18	18
Wood-lark - - -	18	4	17	12	8
Tit-lark - - -	12	12	12	12	12
Linnet - - -	12	16	12	16	18
Goldfinch - - -	4	19	4	12	12
Chaffinch - - -	4	12	4	8	8
Greenfinch - - -	4	4	4	4	6
Hedge-sparrow - -	6	0	6	4	4
Aberdavine or siskin	2	4	0	4	4
Red-poll - - -	0	4	0	4	4
Thrush - - -	4	4	4	4	4
Blackbird - - -	4	4	0	2	2
Robin - - -	6	16	12	12	12
Wren - - -	0	12	0	4	4
Reed sparrow - -	0	4	0	2	2
Black-cap, or Norfolk mock nightingale	14	12	12	14	14

SONNA, a book of Mahometan traditions, which all the orthodox mussulmen are required to believe.

SONNERATIA, in botany; a genus of plants belonging to the class of *icofandria*, and to the order of *monogynia*. The calyx is cut into six segments; the petals are six; the capsule is multilocular and succulent; and the cells contain many seeds. The only species is the *oida*.

SONNET, in poetry, a composition contained in 14 verses, viz. two stanzas or measures of four verses each, and two of three, the eight first verses being all in three rhimes.

SONNITES, among the Mahometans, an appellation given to the orthodox mussulmen or true believers; in opposition to the several heretical sects, particularly the Shiites or followers of Ali.

SOOJU, or SOV. See DOLICHOS.

SOONTABURDAR, in the East Indies; an attendant, who carries a silver bludgeon in his hand about two or three feet long, and runs before the palanquin. He is inferior to the Chubdar; the propriety of an Indian newary requiring two Soontaburdars for every Chubdar in the train. The Chubdar proclaims the approach of visitors, &c. He generally carries a large silver staff about five feet long in his hands: and among the Nabobs he proclaims their praises aloud as he runs before their palanquins.

SOOT, a volatile matter arising from wood and other fuel along with the smoke; or rather, it is the smoke itself condensed and gathered to the sides of the chimney. Tho' once volatile, however, soot cannot be again resolved into vapour; but, if distilled by a strong fire, yields a volatile alkali and empyreumatic oil, a considerable quantity of fixed matter remaining at the bottom of the distilling vessel. If burnt in an open fire, it flames with a thick smoke, whence other soot is produced. It is used as a material for making sal ammoniac, and as a manure. See CHEMISTRY, n<sup>o</sup> 796.; and AGRICULTURE, n<sup>o</sup> 20.

SOOT-Black. See COLOUR-Making.

SOPHI, or SOFI, a title given to the emperor of

Persia; importing as much as wise, sage, or philosopher.

The title is by some said to have taken its rise from a young shepherd named *Sophi*, who attained to the crown of Persia in 1370; others derive it from the *sophoi* or sages anciently called *magi*. Vossius gives a different account of the word: *sophi* in Arabic, he observes, signifies *wool*; and he adds, that it was applied by the Turks out of derision to the kings of Persia ever since Ismael's time; because, according to their scheme of religion, he is to wear no other covering on his head but an ordinary red woollen stuff; whence the Persians are also called *bezelbaschs*, q. d. *red-heads*. But Bochart assures us, that *sophi* in the original Persian language, signifies one that is pure in his religion, and who prefers the service of God in all things: and derives it from an order of religious called by the same name. The *sophis* value themselves on their illustrious extraction. They are descended in a right line from Houssin, second son of Ali, Mahomet's cousin, and Fatima, Mahomet's daughter.

SOPHIS, or *Sofees*, a kind of order of religious among the Mahometans in Persia, answering to what are otherwise called *derwises*, and among the Arabs and Indians *saquirs*. Some will have them called *sophis* from a kind of coarse camblet which they wear called *souf*, from the city Souf in Syria, where it is principally manufactured. The more eminent of those *sophis* are complimented with the title *schiek*, that is, *reverend*, much as in Romish countries the religious are called *reverend fathers*. Schiek *sophi*, who laid the foundation of the grandeur of the royal house of Persia, was the founder, or rather the restorer of this order: Ismael, who conquered Persia, was himself a *sophi*, and greatly valued himself on his being so. He chose all the guards of his person from among the religious of this order; and would have all the great lords of his court *sophis*. The king of Persia is still grandmaster of the order; and the lords continue to enter into it, though it be now fallen under some contempt.

SOPHISM, in logic, a specious argument having the appearance of truth, but leading to falsehood. Sophisms are reduced by Aristotle into eight classes, an arrangement so just and comprehensive, that it is equally proper in present as in former times. 1. *Ignoratio elenchi*, in which the *sophist* seems to determine the question, while he only does it in appearance. Thus the question, "Whether excess of wine be hurtful?" seems to be determined by proving, that wine revives the spirits and gives a man courage: but the principal point is here kept out of sight; for still it may be hurtful to health, to fortune, and reputation. 2. *Petito principii*, a begging of the question, or taking for granted that which remains to be proved, as if any one should undertake to prove that the soul is extended through all the parts of the body, because it resides in every member. This is affirming the same thing in different words. 3. Reasoning in a circle; as when the Roman Catholics prove the Scriptures to be the word of God by the authority of the church, and the authority of the church from the Scriptures. 4. *Non causa pro causa*, or the assigning of a false cause to any effect. Thus the supposed principle, that nature abhors a vacuum, was applied to explain the rising of water in a pump before Galileo discovered that it was owing to the pressure of the

Sophi's,  
Sophism

sophism  
||  
sophist'ca-  
tion.

atmosphere In this way the vulgar ascribe accidents to divine vengeance, and the heresies and infidelity of modern times are said to be owing to learning. 5. *Fallacia accidentis*, in which the sophist represents what is merely accidental as essential to the nature of the subject. This is nearly allied to the former, and is committed by the Mahometans and Roman Catholics. The Mahometans forbid wine, because it is sometimes the occasion of drunkenness and quarrels; and the Roman Catholics prohibit the reading of the Bible, because it has sometimes promoted heresies. 6. By deducing an universal assertion from what is true only in particular circumstances, and the reverse; thus some men argue, "transcribers have committed many errors in copying the Scriptures, therefore they are not to be depended on." 7. By asserting any thing in a compound sense which is only true in a divided sense; so when the Scriptures assure us, that the worst of sinners may be saved, it does not mean that they shall be saved while they remain sinners, but that if they repent they may be saved. 8. By an abuse of the ambiguity of words. Thus Mr Hume reasons in his *Essay on Miracles*: "Experience is our only guide in reasoning concerning matters of fact; now we know from experience, that the laws of nature are fixed and invariable. On the other hand, testimony is variable and often false; therefore since our evidence for the reality of miracles rests solely on testimony which is variable, and our evidence for the uniformity of the law of nature is invariable, miracles are not to be believed." The sophistry of this reasoning depends on the ambiguity of the word *experience*, which in the first proposition signifies the maxims which we form from our own observation and reflection; in the second it is confounded with testimony; for it is by the testimony of others, as well as our own observation, that we learn whether the laws of nature are variable or invariable. The *Essay on Miracles* may be recommended to those who wish to see more examples of sophistry; as we believe most of the eight species of sophisms which we have mentioned are well illustrated by examples in that essay.

SOPHIST, an appellation assumed in the early periods of Grecian history by those who devoted their time to the study of science. This appellation appearing too arrogant to Pythagoras, he declined it, and wished to be called a *philosopher*; declaring that, though he could not consider himself as a wife man, he was indeed a lover of wisdom. True wisdom and modesty are generally united. The example of Pythagoras was followed by every man of eminence; while the name *Sophist* was retained only by those who with a pomp of words made a magnificent display of wisdom upon a very slight foundation of knowledge. Those men taught an artificial structure of language, and a false method of reasoning, by which, in argument, the worse might be made to appear the better reason (see *SOPHISM*). In Athens they were long held in high repute, and supported, not only by contributions from their pupils, but by a regular salary from the state. They were among the bitterest enemies of the illustrious Socrates, because he embraced every opportunity of exposing to contempt and ridicule their vain pretensions to superior knowledge, and the pernicious influence of their doctrines upon the taste and morals of the Athenian youth.

SOPHISTICATED, the mixing of any thing

with what is not genuine; a practice too common in the making up of medicines for sale; as also among vintners, distillers, and others, who are accused of sophisticating their wines, spirits, oils, &c. by mixing with them cheaper and coarser materials; and in many cases the cheat is carried on so artfully as to deceive the best judges.

SOPHOCLES, the celebrated Greek tragic poet, the son of Sophilus an Athenian, was born at Colonn, and educated with great attention. Superior vigour and address in the exercises of the palestra, and skill in music, were the great accomplishments of young men in the states of Greece. In these, Sophocles excelled; nor was he less distinguished by the beauty of his person. He was also instructed in the noblest of all sciences, civil polity and religion: from the first of these he derived an unshaken love of his country, which he served in some embassies, and in high military command with Pericles; from the latter he was impressed with a pious reverence for the gods, manifested by the inviolable integrity of his life. But his studies were early devoted to the tragic muse; the spirit of Eschylus lent a fire to his genius, and excited that noble emulation which led him to contend with, and sometimes to bear away the prize from, his great master. He wrote 43 tragedies, of which 7 only have escaped the ravages of time: and having testified his love of his country by refusing to leave it, though invited by many kings; and having enjoyed the uninterrupted esteem and affection of his fellow-citizens, which neither the gallant actions and sublime genius of Eschylus, nor the tender spirit and philosophic virtue of Euripides, could secure to them, he died in the 91st year of his age, about 406 years before Christ. The burial-place of his ancestors was at Decelia, which the Lacedemonians had at that time seized and fortified; but Lyfander, the Spartan chief, permitted the Athenians to inter their deceased poet; and they paid him all the honours due to his love of his country, integrity of life, and high poetic excellence. Eschylus had at once seized the highest post of honour in the field of poetry, the true sublime; to that eminence his claim could not be disputed. Sophocles had a noble elevation of mind, but tempered with so fine a taste, and so chastened a judgment, that he never passed the bounds of propriety. Under his conduct the tragic muse appeared with the chaste dignity of some noble matron at a religious solemnity; harmony is in her voice, and grace in all her motions. From him the theatre received some additional embellishments; and the drama the introduction of a third speaker, which made it more active and more interesting: but his distinguished excellence is in the judicious disposition of the fable, and so nice a connection and dependence of the parts on each other, that they all agree to make the event not only probable, but even necessary. This is peculiarly admirable in his "*Œdipus King of Thebes*;" and in this important point he is far superior to every other dramatic writer.

The ingratitude of the children of Sophocles is well known. They wished to become immediate masters of their father's possessions; and therefore tired of his long life, they accused him before the Areopagus of insanity. The only defence the poet made was to read his tragedy of *Œdipus at Colonus*, which he had lately finished; and then he asked his judges, whether the au-

Sophocles.

Sophora  
||  
Sorbus.

thor of such a performance could be taxed with infamy? The father upon this was acquitted, and the children returned home covered with shame and confusion. The seven tragedies of Sophocles which still remain, together with the Greek Scholia which accompany them, have been translated into Latin by Johnson, and into English by Dr Franklin and Mr Potter.

**SOPHORA**, in botany: A genus of plants belonging to the class of *decandria*, and to the order of *monogynia*; and in the natural system arranged under the 32d order, *Papilionaceæ*. The calyx is quinquefidate and gibbous above: the corolla is papilionaceous; the wings being of the same length with the vexillum: the seed is contained in a legumen. There are 16 species; the tetraptera, microphylla, flavescens, alopecuroides, tomentosa, occidentalis, capensis, aurea, japonica, genilloides, australis, tinctoria, alba, lupinoides, biflora, and hirsuta.

**SOPORIFIC**, or **SOPORIFEROUS**, a medicine that produces sleep. Such are opium, laudanum, the seed of poppies, &c. The word is formed from the Latin *sopor* "sleep." The Greeks in place of it use the word *hypnotic*.

**SORBONNE**, or **SORBON**, the house or college of the faculty of theology established in the university of Paris. It was founded in 1252 by St Louis, or rather by Robert de Sorbon his confessor and almoner, first canon of Cambrai, and afterwards of the church of Paris; who gave his own name to it, which he himself took from the village of Sorbon or Serbon, near Sens, where he was born. The foundation was laid in 1250; queen Blanche, in the absence of her husband, furnishing him with a house which had formerly been the palace of Julian the apostate, of which some remains are still seen. Afterwards the king gave him all the houses he had in the same place, in exchange for some others. The college has been since magnificently rebuilt by the cardinal de Richelieu. The design of its institution was for the use of poor students in divinity. There are lodgings in it for 36 doctors, who are said to be of the *society of the Sorbonne*; those admitted into it without being doctors, are said to be of the *hospitality of the Sorbonne*. Six regent doctors formerly held lectures every day for an hour and a half each; three in the morning, and three in the afternoon.

**SORBONNE**, is also used in general for the whole faculty of theology at Paris; as the assemblies of the whole body are held in the house of the Sorbonne; and the bachelors of the other houses of the faculty, as the house of Navarre, &c. come hither to hold their *sorbonnique*, or act for being admitted doctor in divinity.

**SORBUS**, **SERVICE-TREE**, in botany; a genus of plants belonging to the class of *icosandria*, and to the order of *trigynia*. The calyx is quinquefid; the petals are five; the berry is below the flower, soft and containing three seeds. There are three species; the *aucuparia*, *domestica*, and *hebrida*.

1. The *aucuparia*, mountain-ash, quicken-tree, quick-beam, or roan-tree, rises with a straight upright stem and regular branching head, twenty or thirty feet high or more, covered with a smooth greyish brown bark; pinnated leaves of eight or ten pair of lunc; narrow, serrated folioles, and an odd one, smooth on both sides; and large umbellate clusters of white flowers at the sides

and ends of the branches, succeeded by clusters of fine red berries, ripe in autumn and winter. There is a variety with yellow striped leaves. This species grows wild in many parts of this island in mountainous places, woods, and hedge-rows, often growing to the size of timber; and is admitted into most ornamental plantations, for the beauty of its growth, foliage, flowers, and fruit; the latter, in particular, being produced in numerous red large bunches all over the tree, exhibit a fine appearance in autumn and winter, till devoured by the birds, especially the blackbird and thrush, which are so allured by this fruit as to fluck from all parts and feed on it voraciously.—In the island of Jura the juice of the berries is employed as an acid for punch. It is probable that this tree was in high esteem with the Druids; for it is more abundant than any other tree in the neighbourhood of those Druidical circles of stones, so common in North Britain. It is still believed by some persons, that a branch of this tree can defend them from enchantment or witchcraft. Even the cattle are supposed to be preserved by it from danger. The dairy-maid drives them to the summer pastures with a rod of the roan-tree, and drives them home again with the same. In Strathspay, we are told, a hoop is made of the wood of this tree on the 1st of May, and all the sheep and lambs are made to pass through it.

2. The *domestica*, or cultivated service-tree, with eatable fruit, grows with an upright stem, branching 30 or 40 feet high or more, having a brownish bark, and the young shoots in summer covered with a mealy down; pinnated leaves of eight or ten pair of broadish deeply serrated lobes and an odd one, downy underneath, and large umbellate clusters of white flowers at the sides and ends of the branches, succeeded by bunches of large, fleshy, edible red fruit, of various shapes and sizes. This tree is a native of the southern warm parts of Europe, where its fruit is used at table as a desert, and it is cultivated here in many of our gardens, both as a fruit-tree and as an ornament to diversify hardy plantations.

3. The *hebrida*, or mongrel service-tree of Gotland, grows twenty or thirty feet high; it has half-pinnated leaves, very downy underneath; and clusters of white flowers, succeeded by bunches of round reddish berries in autumn.

**SORCERY**, or **MAGIC**; the power which some persons were formerly supposed to possess of commanding the devil and the infernal spirits by skill in charms and invocations, and of soothing them by fumigations. Sorcery is therefore to be distinguished from witchcraft; an art which was supposed to be practised, not by commanding evil spirits, but by compact with the devil. As an instance of the power of bad smells over demons or evil spirits, we may mention the flight of the evil spirit mentioned in Tobit into the remote parts of Egypt, produced, it is said, by the smell of the burnt liver of a fish. Lilly informs us, that one Evans having raised a spirit at the request of Lord Bothwell and Sir Kenelm Digby, and forgetting a fumigation, the spirit, vexed at the disappointment, pulled him without the circle, and carried him from his house in the Minorities into a field near Battersea Causeway.

King James, in his *Dæmonologia*, has given a very full account of the art of foreery. "Two principal things (says he) cannot well in that errand be wanted:

*Forcery.* holy water (whereby the devill mockes the papists), and some present of a living thing unto him. There are likewise certaine daies and houres that they observe in this purpose. These things being all ready and prepared, circles are made, triangular, quadrangular, round, double, or single, according to the forme of the apparition they crave. When the conjured spirit appears, which will not be while after many circumstances, long prayers, and much muttering and murmurings of the conjurors, like a papist priest dispatching a hunting maske - how soone, I say, he appears, if they have missed one jote of all their rites; or if any of their feete once slyd over the circle, through terror of his fearfull apparition, he paies himself at that time, in his owne hand, of that due debt which they ought him, and otherwise would have delaied longer to have paied him: I mean, he carries them with him, body and soule." How the conjurors made triangular or quadrangular circles, his majesty has not informed us, nor does he seem to imagine there was any difficulty in the matter. We are therefore led to suppose, that he learned his mathematics from the same system as Dr Sacheverell, who, in one of his speeches or sermons, made use of the following simile: "They concur like parallel lines, meeting in one common centre."

Another mode of consulting spirits was by the beryl, by means of a speculator or seer; who, to have a complete sight, ought to be a pure virgin, a youth who had not known woman, or at least a person of irreproachable life and purity of manners. The method of such consultation is this: The conjuror having repeated the necessary charms and adjurations, with the litany or invocation peculiar to the spirits or angels he wishes to call (for every one has his particular form), the seer looks into a crystal or beryl, wherein he will see the answer, represented either by types or figures; and sometimes, though very rarely, will hear the angels or spirits speak articulately. Their pronunciation is, as Lilly says, like the Irish, much in the throat. Lilly describes one of these beryls or crystals. It was, he says, as large as an orange, set in silver, with a cross at the top, and round about engraved the names of the angels Raphael, Gabriel, and Uriel. A delineation of another is engraved in the frontispiece to Aubery's Miscellanies.

These forcerers or magicians do not always employ their art to do mischief; but, on the contrary, frequently exert it to cure diseases inflicted by witches; to discover thieves; recover stolen goods; to foretel future events, and the state of absent friends. On this account they are frequently called *white witches*. See MAGIC, WITCHCRAFT, &c.

Our forefathers were strong believers when they enacted, by statute 33 Hen. VIII. c. 8. all witchcraft and forcery to be felony without benefit of clergy; and again, by statute 1 Jac. I. c. 12. that all persons invoking any evil spirit, or consulting, covenanting with, entertaining, employing, feeding, or rewarding any evil spirit; or taking up dead bodies from their graves to be used in any witchcraft, forcery, charm, or enchantment; or killing or otherwise hurting any person by such infernal arts; should be guilty of felony without benefit of clergy, and suffer death. And if any person should attempt by forcery to discover hidden treasure,

or to restore stolen goods, or to provoke unlawful love, or to hurt any man or beast, though the same were not effected, he or she should suffer imprisonment and pillory for the first offence, and death for the second. These acts continued in force till lately, to the terror of all ancient females in the kingdom; and many poor wretches were sacrificed thereby to the prejudice of their neighbours and their own illusions, not a few having by some means or other confessed the fact at the gallows. But all executions for this dubious crime are now at an end; our legislature having at length followed the wise example of Louis XIV. in France, who thought proper by an edict to restrain the tribunals of justice from receiving informations of witchcraft. And accordingly it is with us enacted, by statute 9 Geo. II. c. 5. that no prosecution shall for the future be carried on against any person for conjuration, witchcraft, forcery, or incantment: But the misdemeanor of persons pretending to use witchcraft, tell fortunes, or discover stolen goods, by skill in the occult sciences, is still deservedly punished with a year's imprisonment, and standing four times in the pillory.

SOREX, the SHREW, in natural history; a genus of animals belonging to the class of *mammalia*, and order of *feræ*. It has two long fore-teeth in the upper jaw, which are divided into two points; in the lower jaw are two or four fore-teeth, the two middle ones, in the latter case, being shorter than the others: On each side in both jaws are two or more tusks: The grinders are knobbed. The animals of this genus have in general thick clumsy bodies, and five toes on each of their feet; the head resembles that of the mole, being thick at the fore-head, much elongated, and ending in a conical snout, and having very small eyes; in other circumstances of general figure they resemble the murine tribe of quadrupeds. They burrow in the ground, some species living mostly about the sides of waters; and most of them feeding on worms and insects. There are 16 species; of which the most remarkable are,

1. The *araneus*, or field shrew-mouse, with short rounded ears; eyes small, and almost hid in the fur; nose long and slender, upper part the longest; head and upper part of the body of a brownish red; belly of a dirty white; length from nose to tail, two inches and a half; tail one and a half. Inhabits Europe: lives in old walls and heaps of stones, or holes in the earth; is frequently near hay-ricks, dung-hills, and necessary-houses; lives on corn, insects, and any filth; is often observed rooting in ordure like a hog; from its food, or the places it frequents, has a disagreeable smell; cats will kill, but not eat it: it brings four or five young at a time. The ancients believed it was injurious to cattle; an error now detected. There seems to be an annual mortality of these animals in August, numbers being then found dead in the paths.

2. The *fodiens*, or water-shrew, has a long slender nose; very minute ears; very small eyes, hid in the fur; colour of the head and upper part of the body black; throat, breast and belly, of a light ash-colour; beneath the tail, a triangular dusky spot; much larger than the last; length, from nose to tail, three inches three quarters; tail, two inches. Inhabits Europe: long since known in England, but lost till May 1768, when it was discovered in the fens near Revesley Abbey,

Sorites  
||  
Sorrel.

by, Lincolnshire; burrows in the banks near the water; is called by the fenmen the *blind-mouse*.

3. The *minutus*, or minute shrew, has a head near as big as the body: very slender nose; broad short naked ears; whiskers reaching to the eyes; eyes small, and capable of being drawn in; hair very fine and shining; grey above, white beneath; no tail; the least of quadrupeds, according to Linnæus. Inhabits Siberia; lives in a nest made of lichens, in some moist place beneath the roots of trees; feeds on seeds, digs, runs swiftly, and has the voice of a bat.

4. The *tucan*, or Mexican shrew, has a sharp nose; small round ears; without sight; two long fore-teeth above and below; thick, fat, and fleshy body; short legs, so that the belly almost touches the ground; long crooked claws; tawny hair; short tail; length, from nose to tail, nine inches. Inhabits Mexico; burrows, and makes such a number of cavities, that travellers can scarce tread with safety; if it gets out of its hole, does not know how to return, but begins to dig another; grows very fat, and is eatable; feeds on roots, kidney-beans, and other seeds. M. de Buffon thinks it a mole; but it seems more properly to belong to the genus of *farex*.

SORITES, in logic, a species of reasoning in which a great number of propositions are so linked together, that the predicate of the one becomes continually the subject of the next following, till at last a conclusion is formed by bringing together the subject of the first proposition and the predicate of the last. Such was that merry argument of Themistocles, to prove that his little son under ten years old governed the whole world. Thus: *My son governs his mother; his mother me; I the Athenians; the Athenians the Greeks; Greece commands Europe; Europe the whole world: therefore my son commands the whole world.* See LOGIC, n° 96. 97.

SORNING, in Scots law. See LAW, N° clxxvi.

30.

SORREL, in botany, a species of the *RUMEX*, which grows in pastures and meadows, and is well known. The natives of Lapland boil large quantities of the leaves in water, and mix the juice when cold with the milk of their rein-deers which they esteem an agreeable and wholesome food. The Dutch are said to cultivate this plant for its usefulness in the dyeing of woollen cloths black; and we know that by means of the common broad-leaved sorrel an excellent black colour is, in many places of Scotland, given to woollen stuffs without the aid of copperas. As this mode of dyeing does not in the smallest degree injure the texture of the cloth, which continues to the last soft and silky, without that hardness to the touch which it acquires when dyed black by means of copperas, our readers will probably thank us for the following receipt, with which we have been favoured by a learned physician:

Let the stuff to be dyed be well washed with soap and water, and afterwards completely dried. Then of the common broad-leaved sorrel boil as much as shall make an acid decoction of sufficient quantity to let the stuff to be dyed lie in it open and easy to be stirred. The greater quantity of sorrel that is used, the better will the colour be; and therefore if the pot or cauldron will not hold enough at once, when part has been sufficiently boiled, it must be taken out and wrung, and a fresh

quantity be boiled in the same juice or decoction. When the liquor is made sufficiently acid, strain it from the sorrel through a sieve, put the cloth or yarn into it, and let it boil for two hours, stirring it frequently. If stockings be among the stuff to be dyed, it will be expedient, after they have been an hour in the boiling liquor, to turn them inside out, and at the end of the second hour let the whole be poured into a tub or any other vessel. The pot or cauldron must then be washed, and water put into it, with half a pound of logwood chips for every pound of dry yarn or cloth. The logwood and water should boil slowly for four hours; and then the cloth or yarn being wrung from the liquor, and put into the logwood decoction, the whole must be suffered to boil slowly for four hours, stockings, if there be any, being turned inside out at the end of two hours. Of this last decoction there must as of the former be enough to let the cloth lie open and easy to be stirred while boiling. At the end of the four hours the cloth must be taken out, and among the boiling liquor, first removed from the fire, must be poured a Scotch pint or English gallon of stale urine for every pound of dry cloth or other stuff to be dyed. When this compound liquor has been stirred and become cold, the cloth must be put into it and suffered to remain well covered for 12 hours, and then dried in the shade; after which, to divest it of smell or any other impurity, it may be washed in cold water, and dried for use.

*Wood-SORREL*, in botany. See OXALIS.

*SORREL-Colour*, in the manege, is a reddish colour, generally thought to be a sign of a good horse.

SORRENTO, a sea-port town of the kingdom of Naples, with an archbishop's see. It is seated in a peninsula, on the bay of Naples, at the foot of a mountain of the same name, 17 miles south-east of Naples. It is the birth-place of Torquato Tasso. E. Long. 14. 24. N. Lat. 40. 36.

SORTILEGE (*Sortilegium*), a species of divination performed by means of *sortes* or lots.

The *sortes Preneſtinae*, famous in antiquity, consisted in putting a number of letters, or even whole words, into an urn; and then, after shaking them together, they were thrown on the ground; and whatever sentences could be made out from them, constituted the answer of the oracle. To this method of divination succeeded that which has been called the *sortes Homericæ* and *sortes Virgilianæ*, a mode of inquiring into futurity, which undoubtedly took its rise from a general custom of the oracular priests of delivering their answers in verse; it subsisted a long time among the Greeks and Romans; and being from them adopted by the Christians, it was not till after a long succession of centuries that it became exploded. Among the Romans it consisted in opening some celebrated poet at random, and among the Christians the Scriptures, and drawing, from the first passage which presented itself to the eye, a prognostic of what would befall one's self or others, or direction for conduct when under any exigency. There is good evidence that this was none of the vulgar errors; the greatest persons, philosophers of the best repute, admitted this superstition. Socrates, when in prison, hearing this line of Homer,

Within three days I Phthia's shore shall see,

immediately.

Sorre  
||  
Sorti'e

*So-tilege.* immediately said, within three days I shall be out of the world; gathering it from the double meaning of the word *Phthia*, which in Greek is both the name of a country and signifies corruption or death. This prediction, addressed to *Æschinus*, was not easily forgotten, as it was verified.

When this superstition passed from Paganism into Christianity, the Christians had two methods of consulting the divine will from the Scriptures; the one, casually, to open the divine writings, and take their direction, as above-mentioned; the other, to go to church with a purpose of receiving, as a declaration of the will of heaven, the words of the Scripture, which were singing at the instant of one's entrance.

This unwarrantable practice of inquiring into futurity prevailed very generally in England till the beginning of the present century; and sometimes the books of Scripture, and sometimes the poems of *Virgil*, were consulted for oracular responses. One remarkable instance is that of King *Charles I.* who being at Oxford during the civil wars, went one day to see the public library, where he was showed, among other books, a *Virgil* nobly printed and exquisitely bound. The lord Falkland, to divert the king, would have his majesty make a trial of his fortune by the *Sortes Virgilianæ*. Whereupon the king opening the book, the period which happened to come up was this:

*At bello audacis populi vexatus, et armis,  
Fimibus extorris, complexu avulsus Iuli,  
Auxilium imploret; videtque indigna suorum  
Funera; nec, cum se sub leges pacis iniquæ  
Tradiderat, regno aut optata luce fruatur;  
Sed esdat ante diem, mediæque inhumatus arena.*

*Æneid.* lib. iv.

Yet let a race, untamed and haughty foes,  
His peaceful entrance with dire arms oppose;  
Oppressed with numbers in the unequal field,  
His men discouraged, and himself expelled,  
Let men for succour sue from place to place,  
Torn from his subjects, and his son's embrace:  
First let him see his friends in battle slain,  
And their untimely fate lament in vain;  
And when at length the cruel war shall cease,  
On hard conditions may he buy his peace.  
Nor let him then enjoy supreme command,  
But fall untimely by some hostile hand,  
And lie unburied on the barren sand.

Lord Falkland observing that the king was concerned at this accident, would likewise try his own fortune in the same manner, hoping he might fall upon some passage that would have no relation to his case, and thereby divert the king's thoughts from any impression which the other might have upon him; but the place he stumbled upon was as much suited to his destiny as the other had been to the king's; being the lamentation of *Evander* for the untimely death of his son *Pallas*: for this lord's eldest son, a young man of an amiable character, had been slain in the first battle of *Newbury*.

We have ourselves known several whose devotion has not always been regulated by judgment pursue this method of divination; and have generally observed, that the consequence has been despair or presumption. To such we beg leave to recommend one passage in Scrip-

ture which will never disappoint them: *Thou shalt not tempt the Lord thy God.*

**SOTERIA**, in antiquity, sacrifices offered to the gods for delivering a person from danger; as also poetical pieces composed for the same purpose.

**SOUBISE**, a town of France, in the department of Lower Charente, and late territory of Saintonge. It is seated on the river Charente, 22 miles south of Rochelle, in W. Long. 1. 2. N. Lat. 45. 57.

**SOUGH**, among miners, denotes a passage dug under ground, to convey off waters from mines. See **MINE**.

**SOVEREIGN**, in matters of government, is applied to the supreme magistrate or magistrates of an independent government or state; because their authority is only bounded by the laws of God and the laws of the state: such are kings, princes, &c. See **PREROGATIVE**, &c.

**SOVEREIGN Power**, or **Sovereignty**, is the power of making laws; for wherever that power resides, all others must conform to it, and be directed by it, whatever appearance the outward form and administration of the government may put on. For it is at any time in the option of the legislature to alter that form and administration by a new edict or rule, and to put the execution of the laws into whatever hands it pleases: and all the other powers of the state must obey the legislative power in the execution of their several functions, or else the constitution is at an end. In our constitution the law ascribes to the king the attribute of sovereignty: but that is to be understood in a qualified sense, *i. e.* as supreme magistrate, not as sole legislator; as the legislative power is vested in the king, lords, and commons, not in any of the three estates alone.

*Blackst.  
Comment.*

**SOU**. See **SOL**.

**SOUL**, the principle of perception, memory, intelligence, and volition, in man; which, since the earliest era of philosophy, has furnished questions of difficult investigation, and materials of keen and important controversy (see **METAPHYSICS**, Part III. chap. ii. iii. iv. v.; and **RESURRECTION**, n<sup>o</sup> 42—48.) In the fourth volume of the *Memoirs of the Literary and Philosophical Society of Manchester*, the reader will find a very valuable paper by Dr *Farrier*, proving, by evidence apparently complete, that every part of the brain has been injured without affecting the act of thought. An abridgment of that memoir would weaken its reasoning; which, built on matters of fact and experience, appears to us to have shaken the modern theory of the **Materialists** from its very foundation.

**SOUL of Brutes**. See **BRUTES**.

**SOUND**, in physics, is a term of which it would be preposterous to offer any definition, as it may almost be said to express a simple idea: But when we consider it as a **SENSATION**, and still more when we consider it as a **PERCEPTION**, it may not be improper to give a description of it; because this must involve certain relations of external things, and certain trains of events in the material world, which make it a proper object of philosophical discussion. Sound is that primary information which we get of external things by means of the sense of hearing. This, however, does not explain it: for were we in like manner to describe our sense of hearing, we should find ourselves obliged to say, that it is the faculty by which we perceive sound. Languages

Sound.

are not the invention of philosophers; and we must not expect precision, even in the simplest cases. Our methods of expressing the information given us by our different senses are not similar, as a philosopher, cautiously contriving language, would make them. We have no word to express the primary or generic object of our sense of seeing; for we believe, that even the vulgar consider light as the medium, but not the object. This is certainly the case (how justly we do not say) with the philosopher. On the other hand, the words smell, sound, and perhaps taste, are conceived by most persons as expressing the immediate objects of the senses of smelling, hearing, and tasting. Smell and sound are hastily conceived as separate existences, and as mediums of information and of intercourse with the odoriferous and sounding bodies; and it is only the very cautious philosopher who distinguishes between the smell which he feels and the perfume which fills the room. Those of the ancients, therefore, who taught that sounds were beings wasted through the air, and felt by our ears, should not, even at this day, be considered as awkward observers of nature. It has required the long, patient, and sagacious consideration of the most penetrating geniuses, from Zeno the stoic to Sir Isaac Newton, to discover that what we call sound, the *immediate* external object of the sense of hearing, is nothing but a particular agitation of the parts of surrounding bodies, acting by mechanical impulse on our organs; and that it is not any separate being, nor even a specific quality inherent in any particular thing, by which it can affect the organ, as we suppose with respect to a perfume, but merely a mode of existence competent to every atom of matter. And thus the description which we proposed to give of sound must be a description of that state of external contiguous matter which is the *cause* of sound. It is not therefore prefatory to any theory or set of doctrines on this subject; but, on the contrary, is the sum or result of them all.

To discover this state of external body by which, without any farther intermedium of substance or of operation, it affects our sensitive faculties, must be considered as a great step in science. It will show us at least one way by which mind and body may be connected. It is supposed that we have attained this knowledge with respect to sound. Our success, therefore, is a very pleasing gratification to the philosophic mind. It is still more important in another view: it has encouraged us to make similar attempts in other cases, and has supplied us with a fact to which an ingenious mind can easily fancy something analogous in many abstruse operations of nature, and thus it enables us to give some sort of explanation of them. Accordingly this use has been most liberally made of the mechanical theory of sound; and there is now scarcely any phenomenon, either of matter or mind, that has not been explained in a manner somewhat similar. But we are sorry to say that these explanations have done no credit to philosophy. They are, for the most part, strongly marked with that precipitate and self-conceited impatience which has always characterised the investigations conducted solely by ingenious racy. The consequences of this procedure have been no less fatal to the progress of true knowledge in modern times than in the schools of ancient Greece; and the ethereal philosophers of this age, like the followers of Aristotle of old, have filled

ponderous volumes with nonsense and error. It is strange, however, that this should be the effect of a great and a successful step in philosophy: But the fault is in the philosophers, not in the science. Nothing can be more certain than the account which Newton has given of the propagation of a certain class of undulations in an elastic fluid. But this procedure of nature cannot be seen with distinctness and precision by any but well-informed mathematicians. They alone can rest with unshaken confidence on the conclusions legitimately deduced from the Newtonian theorems; and even they can insure success only by treading with the most scrupulous caution the steps of this patient philosopher. But few have done this; and we may venture to say, that not one in ten of those who employ the Newtonian doctrines of elastic undulations for the explanation of other phenomena have taken the trouble, or indeed were able, to go through the steps of the fundamental proposition (Prin. II. 5c, &c.) But the general results are so plain, and admit of such impressive illustration, that they draw the assent of the most careless reader; and all imagine that they understand the explanation, and perceive the whole procedure of nature. Emboldened therefore by this successful step in philosophy, they, without hesitation, fancy similar intermediums in other cases; and as air has been found to be a vehicle for sound, they have supposed that something which they call ether, somehow resembling air, is the vehicle of vision. Others have proceeded farther, and have held that ether, or another something like air, is the vehicle of sensation in general, from the organ to the brain: nay, we have got a great volume called *A THEORY OF MAN*, where all our sensations, emotions, affections, thoughts, and purposes or volitions, are said to be so many vibrations of another something equally unseen, gratuitous, and incompetent; and, to crown all, this exalted doctrine, when logically prosecuted, must terminate in the discovery of those vibrations which pervade all others, and which constitute what we have been accustomed to venerate by the name *DEITY*. Such *must* be the termination of this philosophy; and a truly philosophical dissertation on the attributes of the Divine Being *can be nothing else* than an accurate description of these vibrations!

This is not a needless and declamatory rhapsody. If the explanation of sound can be legitimately transferred to those other classes of phenomena, these are certain results; and if so, all the discoveries made by Newton are but the glimmerings of the morning, when compared with this meridian splendor. But if, on the other hand, sound logic forbids us to make this transference of explanation, we must continue to believe, for a little while longer, that mind is something different from vibrating matter, and that no kind of oscillations will constitute infinite wisdom.

It is of immense importance therefore to understand thoroughly this doctrine of sound, that we may see clearly and precisely in what it consists, what are the phenomena of sound that are fully explained, what are the data and the assumptions on which the explanations proceed, and what is the *precise mechanical fact* in which it terminates. For this, or a fact perfectly similar, must terminate every explanation which we derive from this by analogy, however perfect the analogy may be. This *previous* knowledge must be completely possessed by eve-

Sound



Sound

ry person who pretends to explain other phenomena in a similar manner. Then, and not till then, he is able to say what classes of phenomena will admit of the explanation: and, when all this is done, his explanation is still an *hypothesis*, till he is able to prove, from other indisputable sources, the existence and agency of the same thing analogous to the elastic fluid, from which all is borrowed.

Such considerations would justify us for considering with great attention the nature of sound. But a work like this will not give room for a full discussion; and we must refer our readers to the writers who treat it more at large. Much curious information may be got from the pains-taking authors of the last century; such as Lord Bacon; Kircher; Merfennus; Casserius in his great work *De Voce et Auditu*; Perrault in his *Dissertation du Bruit*; Muffenbroek in his great System of Natural Philosophy, in 3 vols 4to; and in his *Essais de Physique*; and the writings of the celebrated physiologists of the present age. We also refer to what has been said by us in the article **ACOUSTICS**.

At present therefore we must content ourselves with giving a short history of the speculations of philosophers on this subject, tracing out the steps by which we have arrived at the knowledge which we have of it. We apprehend this to be of great importance; because it shows us what kind of evidence we have for its truth, and the paths which we must shun if we wish to proceed farther: and we trust that the progress which we have made will appear to be so real, and the object to be attained so alluring to a truly philosophical mind, that men of genius will be incited to exert their utmost efforts to  $\perp$  is the present boundaries of our real progress.

In the infancy of philosophy, sound was held to be a separate existence, something which would be, although no hearing animal existed. This was conceived as wafted through the air to our organ of hearing, which it was supposed to affect in a manner resembling that in which our nostrils are affected when they give us the sensation of smell. It was one of the Platonic species, fitted for exciting the intellectual species, which is the immediate object of the soul's contemplation.

Yet, even in those early years of science, there were some, and, in particular, the celebrated founder of the stoic school, who held that sound, that is, the cause of sound, was only the particular motion of external gross matter, propagated to the ear, and there producing that agitation of the organ by which the soul is immediately affected with the sensation of sound. Zeno, as quoted by Diogenes Laertius\*, says, "Hearing is produced by the air which intervenes between the thing sounding and the ear. The air is agitated in a spherical form, and moves off in waves, and falls on the ear, in the same manner as the water in a cistern undulates in circles when a stone has been thrown into it." The ancients were not remarkable for precision, either of conception or argument in their discussions, and they were contented with a general and vague view of things. Some followed the Platonic notions, and many the opinion of Zeno, but without any farther attempts to give a distinct conception of the explanation, or to compare it with experiment.

But in later times, during the ardent researches in the last century into the phenomena of nature, this be-

Sound.

came an interesting subject of inquiry. The invention of the air-pump gave the first opportunity of deciding by experiment whether the elastic undulations of air were the causes of sound: and the trial fully established this point; for a bell rung *in vacuo* gave no sound, and one rung in condensed air gave a very loud one. It was therefore received as a doctrine in general physics that air was the vehicle of sound.

The celebrated Galileo, the parent of mathematical philosophy, discovered the nature of that connection between the lengths of musical cords and the notes which they produced, which had been observed by Pythagoras, or learned by him in his travels in the east, and which he made the foundation of a refined and beautiful science, the theory of music. Galileo showed, that the real connection subsisted between the tones and the vibrations of these cords, and that their different degrees of acuteness corresponded to the different frequency of their vibrations. The very elementary and familiar demonstration which he gave of this connection did not satisfy the curious mathematicians of that inquisitive age, and the mechanical theory of musical cords was prosecuted to a great degree of refinement. In the course of this investigation, it appeared that the cord vibrated in a manner precisely similar to a pendulum vibrating in a cycloid. It must therefore agitate the air contiguous to it in the same manner; and thus there is a particular kind of agitation which the air *can* receive and maintain, which is very interesting.

Sir Isaac Newton took up this question as worthy of his notice; and endeavoured to ascertain with mathematical precision the mechanism of this particular class of undulations, and gave us the fundamental theorems concerning the undulations of elastic fluids, which make the 47, &c. propositions of Book II of his Principles of Natural Philosophy. They have been (perhaps hastily) considered as giving the fundamental doctrines concerning the propagation of sound. They are therefore given in this work in the article **ACOUSTICS**; and a variety of facts are narrated in the article **PNEUMATICS**, to show that such undulations *actually obtain* in the air of our atmosphere, and are accompanied by a set of phenomena of sound which precisely tally or correspond to all the mechanical circumstances of these undulations. In the mean time, the anatomists and physiologists were busily employed in examining the structure of our organs of hearing. Impressed with the validity of this doctrine of aerial undulations being the causes of sound, their researches were always directed with a view to discover those circumstances in the structure of the ear which rendered it an organ susceptible of agitations from this cause; and they discovered many which appeared as contrivances for making it a drum, on which the aerial undulations from without must make very forcible impulses, so as to produce very sonorous undulations in the air contained in it. These therefore they considered as the *immediate* objects of sensation, or the immediate causes of sound.

But some anatomists saw that this would not be a full account of the matter: for after a drum is agitated, it has done all that it can do; it has produced a noise. But a farther process goes on in our ear: There is behind the membrane, which is the head of this drum a curious mechanism, which communicates the agitations

cf

Sound.

of the membrane (the only thing acted on by the undulating air) to another chamber of most singular construction, where the auditory nerve is greatly expanded. They conceive, therefore, that the organ called the *drum* does not act as a drum, but in some other way. Indeed it seems bad logic to suppose that it acts as a drum merely by producing a noise. This is in no respect different from the noise produced out of the ear; and if it is to be heard as a noise, we must have another ear by which it may be heard, and this ear must be another *such* drum; and this must have another, and so on forever. It is like the inaccurate notion that vision is the contemplation of the picture on the retina. These anatomists attended therefore to the structure. Here they observed a prodigious unfolding of the auditory nerve of the ear, which is curiously distributed through every part of this cavity, lining its sides, hung across it like a curtain, and sending off fibres in every direction, so as to leave hardly a point of it unoccupied. They thought the machinery contained in the drum peculiarly fitted for producing undulations of the air contained in this labyrinth, and that by these agitations of the air the contiguous fibres of the auditory nerve are impelled, and that thus we get the sensation of sound.

The cavity intervening between the external air and this inner chamber appeared to these anatomists to have no other use than to allow a very free motion to the *stop* or little piston that is employed to agitate the air in the labyrinth. This piston condenses on a very small surface the impulse which it receives from a much larger surface, strained by the malleus on the entry of the tympanum, on purpose to receive the gentle agitations of the external air in the outer canal. This membranous surface could not be agitated, unless completely detached from every thing round it; therefore all animals which have this mechanism have it in a cavity containing only air. But they held, that nature had even taken precautions to prevent this cavity from acting as a drum, by making it of such an irregular rambling form; for it is by no means a cavity of a symmetrical shape, like a vessel, but rather resembles the rambling holes and blebs which are often seen in a piece of bread, scattered through the substance of the cranium, and communicating with each other by small passages. The whole of these cavernulæ are lined with a softish membrane, which still farther unfits this cavity for producing sound. This reasoning is specious, but not very conclusive. We might even assert, that this anfractuons form, with narrow passages, is well fitted for producing noise. If we place the ear close to the small hole in the side of a military drum, we shall hear the smallest tap of the drumstick like a violent blow. The lining of the cavernule is nervous, and may therefore be strongly affected in the numerous narrow passages between the cells.

While these speculations were going on with respect to the ear of the breathing animals, observations were occasionally made on other animals, such as reptiles, serpents, and fishes, which give undoubted indications of hearing; and many very familiar facts were observed or recollected, where sounds are communicated through or by means of solid bodies, or by water: therefore, without inquiring how or by what kind of mechanism it is brought about, it became a very general belief among physiologists, that all fishes, and perhaps all ani-

Sound.

mals hear, and that water in particular is a vehicle of sound. In 1767 or 1768 the writer of this article, at the suggestion of the late professor of astronomy in the university of Glasgow, made an experiment in a lake in that neighbourhood, by striking a large hand-bell under water, and heard it very distinctly and strongly when his head was plunged in the water at the distance of more than 1200 feet. Many experiments are mentioned by Kircher and others on the communication of sound through solid bodies, such as masts, yards, and other long beams of dry fir, with similar results. Dr Monro has published a particular account of very curious experiments on the propagation of sound through water in his Dissertation on the Physiology of Fishes; so that it now appears that air is by no means the only vehicle of sound.

In 1760 Cotunni published his important discovery, that the labyrinth or inmost cavity of the ear in animals is completely filled with water. This, after some contest, has been completely demonstrated (see in particular Meckel Junior *de Labyrinthi Auris Contentis*, Argentor., 1777), and it seems now to be admitted by all.

This being the case, our notions of the immediate cause of sound must undergo a great revolution, and a new research must be made into the way in which the nerve is affected: for it is not enough that we substitute the undulations of water for those of air in the labyrinth. The well informed mechanician will see at once, that the vivacity of the agitations of the nerve will be greatly increased by this substitution; for if water be perfectly elastic through the whole extent of the undulatory agitation which it receives, its effect will be greater in proportion to its specific gravity: and this is confirmed by an experiment very easily made. Immerse a table-bell in water contained in a large thin glass vessel. Strike it with a hammer. The sound will be heard as if the bell had been immediately struck on the sides of the vessel. The filling of the labyrinth of the ear with water is therefore an additional mark of the wisdom of the Great Artificer. But this is not enough for informing us concerning the ultimate mechanical event in the process of hearing. The manner in which the nerve is exposed to these undulations must be totally different from what was formerly imagined. The filaments and membranes, which have been described by former anatomists, must have been found by them in a state quite unlike to their situation and condition in the living animal. Accordingly the most eminent anatomists of Europe seem at present in great uncertainty as to the state of the nerve, and are keenly occupied in observations to this purpose. The descriptions given by Monro, Scarpa, Camper, Comparetti, and others, are full of most curious discoveries, which make almost a total change in our notions of this subject, and will, we hope, be productive of most valuable information.

Scarpa has discovered that the solid cavity called the *labyrinth* contains a threefold expansion of the auditory nerve. One part of it, the cochlea, contains it in a fibrous state, ramified in a most symmetrical manner through the whole of the *zona mollis* of the *lamina spiralis*, where it anastomoses with another production of it diffused over the general lining of that cavity. Another department of the nerve, also in a fibrous state, is spread over the external surface of a membranaceous

Sound. bag, which nearly fills that part of the vestibule into which the fœmicircular canals open, and also that orifice which receives the impressions of the stapes. This bag sends off tubular membranaceous ducts, which, in like manner, nearly fill these fœmicircular canals. A third department of the nerve is spread over the external surface of another membranaceous bag, which lies between the one just now mentioned and the cochlea, but having no communication with either, almost completely filling the remainder of the vestibule. Thus the vestibule and canals seem only a case for protecting this sensitive membranaceous vessel, which is almost, but not altogether, in contact with the ossious case, being separated by a delicate and almost fluid cellular substance. The fibrillous expansion of the nerve is not indiscriminately diffused over the surface of these sacculi, but evidently directed to certain foci, where the fibres are congregated. And this is the last appearance of the fibrous state of the nerve; for when the inside of these sacculi is inspected, no fibres appear, but a pulp (judged to be nervous from its similarity to other pulpy productions of the brain) adhering to the membranaceous coat, and not separable from it by gently washing it. It is more abundant, that is, of greater thickness, opposite to the external fibrous foci. No organical structure could be discovered in this pulp, but it probably is organized; for, besides this adhering pulp, the water in the sacculi was observed to be clammy or mucous; so that in all probability the vascular or fibrous state of the nerve is succeeded by an uninterrupted production (perhaps columnar like basalt, though not cohering); and this at last ends in simple dissemination, symmetrical however, where water and nerve are alternate in every direction.

To these observations of Scarpa, Comparetti adds the curious circumstances of another and regular tympanum in the foramen rotundum, the cylindrical cavity of which is inclosed at both ends by a fine membrane. The membrane which separates it from the cochlea appears to be in a state of variable tension, being drawn up to an umbo by a cartilaginous speck in its middle, which he thinks adheres to the lamina spiralis, and thus serves to strain the drumhead, as the malleus strains the great membrane known to all.

These are most important observations, and must greatly excite the curiosity of a truly philological mind, and deserve the most careful inquiry into their justness. If these are accurate descriptions of the organ, they seem to conduct us farther into the secrets of nature than any thing yet known.

We think that they promise to give us the greatest step yet made in physiology, viz. to show us the last mechanical fact which occurs in the long train interposed between the external body and the incitement of our sensitive system. But there is, as yet, great and essential differences in the description given by those celebrated naturalists. It cannot be otherwise. The containing labyrinth can be laid open to our view in no other way than by destroying it; and its most delicate contents are the first sufferers in the search. They are found in very different situations and conditions by different anatomists, according to their address or their good fortune. Add to this, that the natural varieties are very considerable. Faithful descriptions must therefore give very different notions of the ultimate action

and reaction between the unorganized matter in the labyrinth and the ultimate expansion of the auditory nerve.

Sound. We must therefore wait with patience. Since this Work of ours was begun, the progress which has been made in many parts of natural science has been great and wonderful; and perhaps before it be completed, we may be furnished with such a collection of facts respecting the structure and the contents of the organ of hearing, as might enable us to give a juster theory of sound than is yet to be found in the writings of philosophers. There seems to be no abatement of ardour in the researches of the physiologists; and they will not remain long ignorant of the truth or mistake in the accounts given by Scarpa and Comparetti. Should the result of their inquiries be what we expect, we should be glad of a proper opportunity of laying it before our readers, together with some disquisition on the nature of hearing. A collection of accurate observations on the structure of the ear would give us principles on which to proceed in explaining the various methods of producing external sounds. The nature of *continued sounds* might then be treated of, and would appear, we believe, very different from what it is commonly supposed. Under this head animal voices might be particularly considered, and the elements of human speech properly ascertained. When the production of continued sounds is once shown to be a thing regulated by principle, it may be systematically treated, and this principle may be considered as combined with every mechanical state of body that may be pointed out. This will suggest to us methods of producing sound which have not yet been thought of, and may therefore give us sounds with which we are unacquainted. Such an acquisition is not to be despised nor rejected. The bountiful Author of our being and of all our faculties has made it an object of most enchanting relish to the human mind. The Greeks, the most cultivated people who have ever figured on the stage of life, enjoyed the pleasures of music with rapture. Even the poor negro, after toiling a whole day beneath the tropical sun, will go ten miles in the dark to dance all night to the simple music of the balafœ, and return without sleep to his next day's toil. The penetrating eye of the anatomist has discovered in the human larynx an apparatus evidently contrived for tempering the great movements of the glottis, so as to enable us to produce the intended note with the utmost precision. There is no doubt therefore that the consummate Artist has not thought it unworthy of his attention. We ought therefore to receive with thankfulness this present from our Maker—this *laborum dulce lenimen*; and it is surely worthy the attention of the philosopher to add to this innocent elegance of life. This, however, is not the time to enter upon the subject. From the jarring observations which have yet been made, we could only amuse the curious reader by holding up to his view a specious theory; and we are not so desirous of filling our Work with what is called *original matter*, as to attempt the attainment of that end by substituting fiction for fact and hypothesis for science.

SOUND, in geography. denotes in general any strait or inlet of the sea between two headlands. It is given by way of eminence to the strait between Sweden and Denmark,

Denmark,

**Sounding.** Denmark, joining the German ocean to the Baltic, being about three miles over. See DENMARK, n° 32. and ELSINORE.

**SOUNDING**, the operation of trying the depth of the sea, and the nature of the bottom, by means of a plummet sunk from a ship to the bottom.

There are two plummets used for this purpose in navigation; one of which is called the *hand-lead*, weighing about 8 or 9 pounds; and the other the *deep-sea-lead*, which weighs from 25 to 30 pounds; and both are shaped like the frustum of a cone or pyramid. The former is used in shallow waters, and the latter at a great distance from the shore; particularly on approaching the land after a sea-voyage. Accordingly the lines employed for this purpose are called the *deep-sea lead-line*, and the *hand lead-line*.

The hand lead-line, which is usually 20 fathoms in length, is marked at every two or three fathoms; so that the depth of the water may be ascertained either in the day or night. At the depth of two and three fathoms, there are marks of black leather; at 5 fathoms, there is a white rag; at 7, a red rag; at 10, black leather; at 13, black leather; at 15, a white rag; and at 17, a red ditto.

Sounding with the hand lead, which is called *heaving the lead* by seamen, is generally performed by a man who stands in the main chains to windward. Having the line quite ready to run out without interruption, he holds it nearly at the distance of a fathom from the plummet; and having swung the latter backwards and forwards three or four times, in order to acquire the greater velocity, he swings it round his head, and thence as far forward as is necessary; so that, by the lead's sinking whilst the ship advances, the line may be almost perpendicular when it reaches the bottom. The person sounding then proclaims the depth of the water in a kind of song resembling the cries of hawkers in a city. Thus if the mark of five fathoms is close to the surface of the water, he calls, 'By the mark five!' and as there is no mark at four, six, eight, &c. he estimates those numbers, and calls, 'By the dip four,' &c. If he judges it to be a quarter or an half more than any particular number, he calls, 'And a quarter five! and a half four,' &c. If he conceives the depth to be three quarters more than a particular number, he calls it a quarter less than the next: thus, at four fathoms and three fourths he calls 'A quarter less five!' and so on.

The deep sea-lead is marked with two knots at 20 fathoms, three at 30, four at 40, and so on to the end. It is also marked with a single knot in the middle of each interval, as at 25, 35, 45 fathoms, &c. To use this lead more effectually at sea, or in deep water on the sea-coast, it is usual previously to bring to the ship, in order to retard her course: the lead is then thrown as far as possible from the ship on the line of her drift, so that, as it sinks, the ship drives more perpendicularly over it. The pilot, seeing the lead strike the bottom, readily discovers the depth of the water by the mark on the line nearest its surface. The bottom of the lead being also well rubbed over with tallow, retains the distinguishing marks of the bottom, as shells, ooze, gravel, &c. which naturally adhere to it.

The depth of the water, and the nature of the ground, which is called the *soundings*, are carefully marked in the log-book, as well to determine the distance of the place

from the shore, as to correct the observations of former pilots.

**SOUP**, a strong decoction of flesh or other substances.

Portable or dry soup is a kind of cake formed by boiling the gelatinous parts of animal substances till the watery parts are evaporated. This species of soup is chiefly used at sea, and has been found of great advantage. The following receipt will show how it is prepared.

Of calves feet take 4; leg of beef 12 lbs.; knuckle of veal 3 lbs.; and leg of mutton 10 lbs. These are to be boiled in a sufficient quantity of water, and the scum taken off as usual; after which the soup is to be separated from the meat by straining and pressure. The meat is then to be boiled a second time in other water; and the two decoctions, being added together, must be left to cool, in order that the fat may be exactly separated. The soup must then be clarified with five or six whites of eggs, and a sufficient quantity of common salt added. The liquor is then strained through flannel, and evaporated on the water-bath to the consistence of a very thick paste; after which it is spread rather thin upon a smooth stone, then cut into cakes, and lastly dried in a stove until it becomes brittle; these cakes are kept in well closed bottles. The same process may be used to make a portable soup of the flesh of poultry; and aromatic herbs may be used as a seasoning, if thought proper.

These tablets or cakes may be kept four or five years. When intended to be used, the quantity of half an ounce is put into a large glass of boiling water, which is to be covered, and set upon hot ashes for a quarter of an hour, or until the whole is entirely dissolved. It forms an excellent soup, and requires no addition but a small quantity of salt.

**SOUR-CROUTE.** See CROUTE.

**SOUR-Gourd**, or *African Calabash-tree*. See ADANSONIA.

**SOUTH** (Dr Robert), an eminent divine, was the son of Mr William South a merchant of London, and was born at Hackney near that city in 1633. He studied at Westminster school, and afterwards in Christ-church college, Oxford. In 1654, he wrote a copy of Latin verses to congratulate Cromwell upon the peace concluded with the Dutch; and the next year a Latin poem, intitled *Musica Incantans*. In 1660 he was elected public orator of the university; and the next year became domestic chaplain to Edward earl of Clarendon, lord-high-chancellor of England. In 1663 he was installed prebendary of Westminster, admitted to the degree of doctor of divinity, and had a sinecure bestowed on him in Wales by his patron the earl of Clarendon; after whose retirement into France in 1667 he became chaplain to the duke of York. In 1670 he was installed canon of Christ-church in Oxford; and in 1676 attended as chaplain to Laurence Hyde, Esq; ambassador extraordinary to the king of Poland. In 1678 he was presented to the rectory of Islip in Oxfordshire; and in 1680 rebuilt the chancel of that church, as he afterwards did the rectory-house belonging to it. After the revolution he took the oath of allegiance to king William and queen Mary, though he excused himself from accepting a great dignity in the church, vacated by the personal refusal of that oath. His health began to decline

*South.* cline several years before his death, which happened in 1716. He was interred in Westminster Abbey, where a monument is erected to his memory. He published, 1. Animadversions on Dr Sherlock's Vindication of the Holy and Ever Blessed Trinity. 2. A Defence of his Animadversions. 3. Sermons, 8 vols 8vo. And after his decease were published his *Opera Posthuma Latina*, and his posthumous English works. Dr South was remarkable for his wit, which abounds in all his writings, and particularly in his sermons; but at the same time they equally abound in ill-humour, spleen, and satire. He was remarkable for being a time-server. During the life of Cromwell he was a staunch Presbyterian, and then railed against the Independents: at the Restoration he exerted his pulpit-eloquence against the Presbyterians; and in the reign of Queen Anne, was a warm advocate for Sacheverel.

**SOUTH**, one of the four cardinal points from which the winds blow.

*South Sea*, or *Pacific Ocean*, is that vast body of water interposed between Asia and America. It does not however, strictly speaking, reach quite to the continent of Asia, excepting to the northward of the peninsula of Malacca: for the water interposed between the eastern coast of Africa and the peninsula just mentioned has the name of the *Indian Ocean*. The South Sea then is bounded on one side by the western coast of America, through its whole extent, from the unknown regions in the north to the straits of Magellan and Terra del Fuego, where it communicates with the southern part of the Atlantic. On the other side, it is bounded by the coast of Asia, from the northern promontory of Tchukotkoi Nofs, to the peninsula of Malacca already mentioned. Thence it is bounded to the southward by the northern coasts of Borneo, Celebes, Macassar, New Guinea, New Holland, and the other islands in that quarter, which divide it from the Indian Ocean. Then, washing the eastern coast of the great island of New Holland, it communicates with that vast body of water encompassing the whole southern part of the globe, and which has the general name of the *Southern Ocean* all round. Thus does this vast ocean occupy almost the semicircumference of the globe, extending almost from one pole to the other, and about the equatorial parts extending almost 180° in longitude, or 12,500 of our miles.

The northern parts of the Pacific Ocean are entirely destitute of land; not a single island having yet been discovered in it from the latitude of 40° north and upwards, excepting such as are very near the coast either of Asia or America; but in the southern part there are a great number.

Till very lately the South Sea was in a great measure unknown. From the great extent of ice which covers the southern part of the globe, it was imagined that much more land existed there than in the northern regions: but that this could not be justly inferred merely from that circumstance, is plain from what has been advanced under the article AMERICA, n° 3—24; and the southern continent, long known by the name of *Terra Australis*, has eluded the search of the most expert navigators sent out from Britain and France by royal authority. See TERRA AUSTRALIS.

*South Sea Company.* See COMPANY.

VOL. XVII. Part II.

**SOUTHAMPTON**, a sea-port town of Hampshire Southamp-  
in England. It is commodiously seated on an arm of ton  
the sea; is a place of good trade, and well inhabited. It is furrounded by walls and several watch-towers, and had a strong castle to defend the harbour, now in ruins. It is a corporation and a county of itself, with the title of an earldom, and sends two members to parliament. W. Long. 1. 26. N. Lat. 50. 55.

**SOUTHERN** (Thomas), an eminent dramatic writer, was born at Dublin in 1660, and received his education in the university there. He came young to London to study law; but instead of that devoted himself to poetry and the writing of plays. His *Persian Prince*, or *Loyal Brother*, was introduced in 1682, when the Tory interest was triumphant in England; and the character of the loyal brother being intended to compliment James duke of York, he rewarded the author when he came to the throne with a commission in the army. On the Revolution taking place, he retired to his studies, and wrote several plays, from which he is supposed to have derived a very handsome subsistence, being the first who raised the advantage of play-writing to a second and third night. The most finished of all his plays is *Oroonoko*, or the *Royal Slave*, which is built on a true story related in one of Mrs Behn's novels. Mr Southern died in 1746, in the 86th year of his age; the latter part of which he spent in a peaceful serenity, having, by his commission as a soldier, and the profits of his dramatic works, acquired a handsome fortune; and being an exact economist, he improved what fortune he gained to the best advantage. He enjoyed the longest life of all our poets; and died the richest of them, a very few excepted. His plays are printed in two vols 12mo.

*SOUTHERN Continent.* See AMERICA, n° 3—24. and *TERRA Australis*.

**SOUTHERNWOOD**, in botany. See ARTEMISIA.

**SOUTHWARK**, a town of Surry, and a suburb of the city of London, being separated from that metropolis only by the Thames. See LONDON, n° 96.

**SOW**, in zoology. See SUS.

Sow, in the iron works, the name of the block or lump of metal they work at once in the iron furnace.

*Sow-Thistle.* See SONCHUS.

**SOWING**, in agriculture and gardening, the depositing any kind of seed in the earth for a future crop. See AGRICULTURE.

*Drill-Sowing.* See DRILL-SOWING.

**SOY.** See DOLICHOS.

**SOZOMENUS** (Hermias), an ecclesiastical historian of the 5th century, was born in Bethelia, a town of Palestine. He was educated for the law, and became a pleader at Constantinople. He wrote an *Abridgment of Ecclesiastical History*, in two books, from the ascension of our Saviour to the year 323. This compendium is lost; but a continuation of it in nine books, written at greater length, down to the year 440, is still extant. He seems to have copied Socrates, who wrote a history of the same period. The style of Sozomenus is perhaps more elegant; but in other respects he falls far short of that writer, displaying throughout his whole book an amazing credulity and a superstitious attachment to monks and the monastic life. The

Spa. best edition of Sazomenus is that of Robert Stephe in 1544. He has been translated and published by Valefius, and republished with additional notes by Reading at London, 1720, in 3 vols folio.

SPA, a town of Germany, in the circle of Westphalia and bishopric of Liege, famous for its mineral waters, lies in E. Long. 5. 50. N. Lat. 50. 30. about 21 miles south-east from Liege, and 7 south-west from Lomburg. It is situated at one end of a deep valley on the banks of a small rivulet, and is surrounded on all sides by high mountains. The sides of these mountains next to Spa are rude and uncultivated, presenting a rugged appearance as if shattered by the convulsions of earthquakes; but as they are strewed with tall oaks and abundance of shrubs, the country around forms a wild, romantic, and beautiful landscape. The access to the town is very beautiful. The road winds over the mountains till it descends to their bottom, when it runs along a smooth valley for a mile or a mile and a half.

The town consists of four streets in form of a cross, and contains about 400 inhabitants. Spa has no wealth to boast of. It can scarcely furnish the necessaries of life to its own inhabitants during the winter, and almost all the luxuries which are requisite for the great concourse of affluent visitors during the summer are carried from Liege by women. Its only source of wealth is its mineral waters. No sooner does the warm season commence, than crowds of valetudinarians arrive, as well as many other persons who are attracted solely by the love of amusement, and some from less honourable motives. The inhabitants, who spend seven or eight months of the year without seeing the face of a stranger, wait for the return of this period with impatience. The welcome sound of the carriages brings multitudes from the town, either to gratify their curiosity, or to offer their services in the hopes of securing your employment while you remain at Spa. Immediately after your arrival your name and designation is added to the printed list of the annual visitors; for which you pay a stated sum to the bookseller, who has a patent for this purpose from the prince bishop of Liege. This list not only enables one to know at a glance whether any friends or acquaintances are residing there, but also to distinguish persons of rank and fashion from adventurers, who seldom have the effrontery to insert their names.

There are two different ways of accommodating the visitors at Spa with lodging and necessaries. People may either lodge at an hotel, where every thing is furnished them in a splendid and expensive style; or they

may take up their residence in private lodgings, from which they may send for provisions to a cook's shop.

Among the people who visit Spa, there are many persons of the first rank and fashion in Europe. Perhaps indeed there is no place in Europe to which so many kings and princes resort; but it is also visited by many self-created nobility, who, under the titles of counts, barons, marquises, and knights, contrive by their address and artifices, to prey upon the rich and unexperienced.

The manners established at Spa are conducive both to health and amusement. Every body rises early in the morning, at six o'clock or before it, when a great many horses stand ready saddled for those who choose to drink the Sauveniere or Geronstere waters at a little distance from Spa. After this healthy exercise a part of the company generally breakfast together at Vauxhall, a magnificent and spacious building. At this place a number of card-tables are opened every forenoon, round which many persons assemble and play for stakes to a very considerable amount. A ball too is generally held once a week at Vauxhall, besides two balls at the assembly rooms near the Poulon in the middle of the town.

The most remarkable waters at Spa are, 1. The Poulon, situated in the middle of the town; 2. The Sauveniere, a mile and a half east from it; 3. Groisbeck, near to the Sauveniere; 4. Tonnelet, situated a little to the left of the road which leads to the Sauveniere; 5. Geronstere, two miles south from Spa; 6. Wartroz, near to the Tonnelet; 7. Sarts or Niveset, in the district of Sarts; 8. Chevron or Bru, in the principality of Slavelot; 9. Couve; 10. Beverse; 11. Sige; 12. Geremont. These four last are near Malmedy.

Dr Brownrigg was the first person who discovered that fixed air, or, as it is now generally called, *carbonic acid gas*, forms a principal ingredient in the composition of the Spa waters, and actually separated a quantity of this elastic fluid, by exposing it to different degrees of heat from 110° to 170° of Fahrenheit. From 20 ounces 7 drams and 14 grains apothecaries weight of the Poulon water, he obtained 8 ounces 2 drams and 50 grains. Since June 1765, when Dr Brownrigg read a paper on this subject before the Royal Society of London, the waters of Spa have been often analysed, but perhaps by none with more accuracy than by Dr Ath, who published a book on the chemical and medicinal properties of these waters in 1788. We shall present his analysis of the five principal springs in the following table.

Fountains.	Quantity of Water.	Ounce measures of Gas.	Solid contents.	Aerated Lime.	Aerated Magnesia.	Aerated Mineral Alkali.	Aerated Iron.	Selenite.	Aerated Vegetab. Alkali.
	Ounces.		Grains.						
Poulon	33	35.75	16.25	2.75	9.50	2.25	1.75	—	—
Geronstere	32.75	24.75	5.50	2.50	—	1.75	0.75	0.50	—
Sauveniere	32.50	33.50	3.75	1.50	—	0.75	0.50	—	1.
Groisbeck	32.25	35.50	5.25	1.50	—	1.	0.75	—	2
Tonnelet	32.	40.75	2.00	0.25	—	0.75	1.	—	—



Degrees N. from London. 9 8 7 6 5 4 3 2 1 0 1 2 3 4 5 6 7 8 9

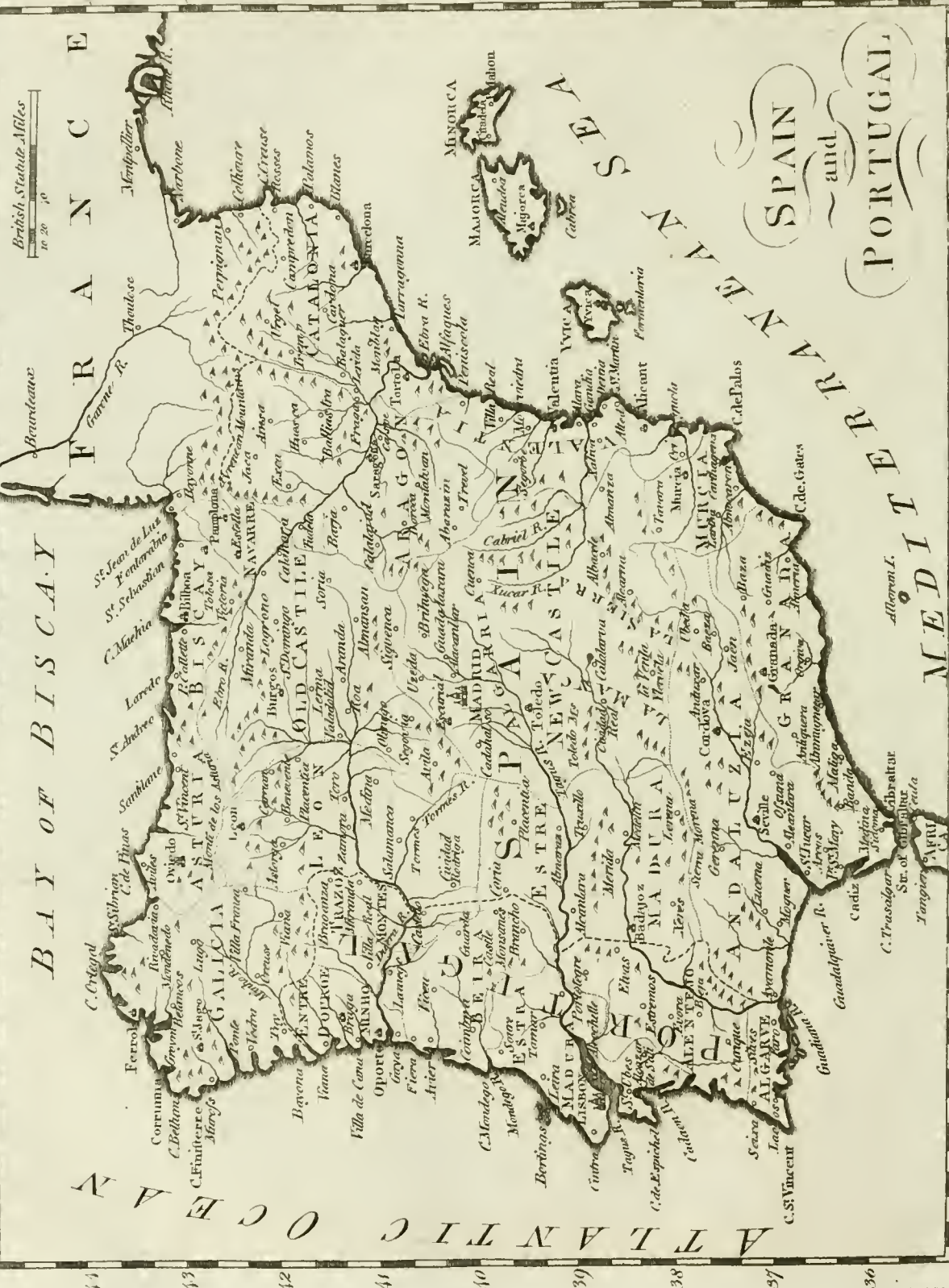

3 London Miles

XX

N. Minutes of Time.

Meridian of London.



<sup>Spa.</sup> The Poulion spring rises from the hill, to the north of Spa, which consists of argillaceous schistous and ferruginous slate. The other fountains rise from the surrounding hills to the south-east, south, west, and north-west of the town; and this ridge of mountains is formed of calcareous earths mixed with siliceous substances. The surface of the mountains is covered with woods, interspersed with large boggy swamps filled with mud and water. The Poulion is considered as the principal spring at Spa, being impregnated with a greater quantity of iron than any of the rest, and containing more fixed air than any except the Tonnelet. It is from this spring that the Spa water for exportation is bottled; for which the demand is so great, that, according to the best information which Mr Thicknesse could obtain, the quantity exported amounts to 200,000 or 250,000 bottles annually. This exported water is inferior in its virtue to that which is drunk on the spot; for the vessels into which it is collected are injudiciously exposed to the sun, rain, wind, and dust, for several hours before they are corked, by which means a considerable part of its volatile ingredients must be evaporated; for it has been found by experiment, that by exposing it to a gentle heat, air-bubbles ascend in great numbers. It is in its greatest perfection when collected in cold dry weather; it is then pellucid, colourless, and without smell, and almost as light as distilled water. It varies in its heat from 52° or 53° to 67° of Fahrenheit's thermometer.

Thicknesse's  
Journey  
through the  
Pais Bas.

The Geronstere is a much weaker chalybeate water than the Poulion; and as it is exceedingly nauseous, and tastes and smells like rotten eggs, it certainly contains some hepatic gas. This is a circumstance which Dr Ash seems not to have attended to sufficiently. The Sauvencic water also, when newly taken from the well, smells a little of sulphur. The Croisheck contains more alkali, and almost as much gas as the Poulion, and has been celebrated for its good effects in the case of calculeous concretions. The Tonnelet contains more gas than any of the rest. So small is the quantity of any fossil body held in suspension by the aerial acid in it, and so volatile is the gas, that it begins to pass off very rapidly the moment it is taken out of the well, and in a short time is entirely gone. Dr Ash informs us, that in the neighbourhood of this well, the cellars, on any approaching change of weather, are found to contain much fixed air; and the best prognostic which they have of rain is the aversion which cats show to be carried into these cellars.

The Spa waters are diuretic, and sometimes purgative. They exhilarate the spirits with an influence much more benign than wine or spirituous liquors, and they are more cooling, and allay thirst more effectually than common water. They are found beneficial in cases of weakness and relaxation, either partial or universal; in nervous disorders; in obstructions of the liver and spleen; in cases where the blood is too thin and putrescent; in cases of excessive discharges proceeding from weakness; in the gravel and stone; and in most cases where a strengthening remedy is wanted. But they are hurtful in confirmed obstructions attended with fever, where there is no free outlet to the matter, as in ulcerations of the lungs. They are also injurious to bilious and plethoric constitutions, when used before the body is cooled by proper evacuations.

SPACE. See METAPHYSICS, Part II. Chap. iv.

SPACE, in geometry, denotes the area of any figure, or that which fills the interval or distance between the lines that terminate it.

Space  
ll.  
S air.

SPADIX, in botany, anciently signified the receptacle of the palms. It is now used to express every flower-stalk that is protruded out of a spathe or sheath.

The spadix of the palms is branched; that of all other plants simple. This last case admits of some variety: in calla, dracontium, and pothos, the florets cover it on all sides; in arum, they are disposed on the lower part only; and in zosteria on one side.

SPAGIRIC ART, a name given by authors to that species of chemistry which works on metals, and is employed in the search of the philosopher's stone.

SPAHIS, horsemen in the Ottoman army, chiefly raised in Asia. The great strength of the grand seignior's army consists in the janisfaries, who are the foot; and the spahis, who are the horse.

SPAIN, a country of Europe, famous both in ancient and modern history, situated in that large peninsula which forms the south-western part of Europe. It is bounded on the south and east by the Mediterranean sea and straits of Gibraltar, on the north and west by the Bay of Biscay and Atlantic Ocean, on the south-west by Portugal, and on the north-east by the Pyrenees.

The most ancient name of Spain was *Iberia*, supposed by some to be derived from the *Iberians*, a people inhabiting Mount Caucasus, a colony of whom settled in this country. Others derive it from the Phœnician word *Ebra* or *Ibra*, signifying a passage or limit. By the Romans it was called *Spania* or *Hispania*, from the Phœnician name *Sphanja*; and this again from *shaphan*, a Phœnician word signifying a rabbit, because the western part of Spain abounded with those animals.

Spain, as well as the rest of Europe, was probably peopled by the Celtes; but the Spanish historians derive the origin of their nation from Tubal the sixth son of Japhet, asserting that Spain had been a monarchy for 2226 years before the coming of the Celtes into it. Till the coming of the Carthaginians into Spain, however, nothing certain can be affirmed of the Spaniards; and this happened not long before the commencement of the first Punic war. Their success in reducing the country, and their final expulsion by the Romans, has already been related under the articles *ROME* and *CARTHAGE*; we have here therefore only to take notice of the state of Spain under the Roman government, until the Romans were in their turn expelled by the northern barbarians.

At the time of the Roman conquest, Spain, though prodigious quantities of silver had been carried out of it by the Carthaginians and Tyrians, was yet a very rich country. In the most ancient times, indeed, its riches are said to have exceeded what is related of the most wealthy country in America. Aristotle assures us, that when the Phœnicians first arrived in Spain, they exchanged their naval commodities for such immense quantities of silver, that their ships could neither contain nor sustain its load, though they used it for ballast, and made their anchors and other implements of silver. When the Carthaginians first came to Spain, they found the quantity of silver nothing lessened, since the inhabitants at that time made all their utensils, and even

Different  
names of  
Spain.

Conquests  
of the Car-  
thaginians  
in Spain.

Exceeding  
great riches  
of the  
country.

Spain. mangers, of that precious metal. In the time of the Romans this amazing plenty was very much diminished; however, their gleanings were by no means despicable, since in the space of nine years they carried off 111,542 pounds of silver, and 4095 of gold, besides an immense quantity of coin and other things of value. The Spaniards were always remarkable for their bravery, and some of Hannibal's best troops were brought from thence. But as the Romans penetrated farther into the country than the Carthaginians had done, they met with nations whose love of liberty was equal to their valour, and whom the whole strength of their empire was scarce able to subdue. Of these the most formidable were the Numantines, Cantabrians, and Asturians.

4  
Vir. thus  
opposes the  
Roman  
power with  
success.

In the time of the third Punic war, one Viriathus, a celebrated hunter, and afterwards the captain of a gang of banditti, took upon him the command of some nations who had been in alliance with Carthage, and ventured to oppose the Roman power in that part of Spain called *Lusitania*, now Portugal. The prætor, named *Fetilius*, who commanded in those parts, marched against him with 10,000 men; but was defeated and killed, with the loss of 4000 of his troops. The Romans immediately dispatched another prætor with 10,000 foot and 1300 horse: but Viriathus having first cut off a detachment of 4000 of them, engaged the rest in a pitched battle; and having entirely defeated them, reduced great part of the country. Another prætor, who was sent with a new army, met with the same fate; so that, after the destruction of Carthage, the Romans thought proper to send a consul named *Quintus Fabius*, who defeated the Lusitanians in several battles, and regained two important places which had long been in the hands of the rebels. After the expiration of Fabius's consulship, Viriathus continued the war with his usual success, till the senate thought proper to send against him the consul *Q. Cæcilius Metellus*, an officer of great valour and experience. With him Viriathus did not choose to venture a pitched battle, but contented himself with acting on the defensive; in consequence of which the Romans recovered a great many cities, and the whole of *Tarraconian Spain* was obliged to submit to their yoke. The other consul, named *Servilianus*, did not meet with the same success; his army was defeated in the field and his camp was nearly taken by Viriathus. Notwithstanding the good fortune of Metellus, however, he could not withstand the intrigues of his countrymen against him, and he was not allowed to finish the war he had begun with so much success. In resentment for this he took all imaginable pains to weaken the army under his command: he disbanded the flower of his troops, exhausted the magazines, let the elephants die, broke in pieces the arrows which had been provided for the Cretan archers, and threw them into a river. Yet, after all, the army which he gave up to his successor *Q. Pompeius*, consisting of 30,000 foot and 2000 horse, was sufficient to have crushed Viriathus if the general had known how to use it. But, instead of opposing Viriathus with success, the imprudent consul procured much more formidable enemies. The *Termantians* and *Numantines*, who had hitherto kept themselves independent, offered very advantageous terms of peace and alliance with Rome; but Pompeius insisted on their delivering up their arms. Upon this,

5  
Is reduced  
to great  
straits by  
Metellus.

6  
War be-  
tween the  
Romans  
and Nu-  
mantines.

Spain. war was immediately commenced. The consul with great confidence invested *Numantia*; but being repulsed with considerable loss, he sat down before *Termantia*, where he was attended with still worse success. The very first day, the *Termantines* killed 700 of his legionaries; took a great convoy which was coming to the Roman camp; and having defeated a considerable body of their horse, pushed them from post to post till they came to the edge of a precipice, where they all tumbled down, and were dashed to pieces. In the mean time *Servilianus*, who had been continued in his command with the title of *proconsul*, managed matters so ill, that Viriathus surrounded him on all sides, and obliged him to sue for peace. The terms offered to the Romans were very moderate; being only that Viriathus should keep the country he at that time possessed, and the Romans remain masters of all the rest. This peace the proconsul was very glad to sign, and afterwards got it signed by the senate and people of Rome.

7  
The Ro-  
mans sur-  
rounded  
all sides,  
and forced  
to conclude  
a peace with  
Viriathus.

The next year *Q. Pompeius* was continued in his command against the *Numantines* in Farther Spain, while *Q. Servilius Cæpio*, the new consul, had for his province Hither Spain, where Viriathus had established his new state. Pompeius undertook to reduce *Numantia* by turning aside the stream of the *Durius*, now the *Douro*, by which it was supplied with water; but, in attempting this, such numbers of his men were cut off, that, finding himself unable to contend with the enemy, he was glad to make peace with them on much worse terms than they had offered of their own accord. The peace, however, was ratified at Rome; but in the mean time Cæpio, desirous of showing his prowess against the renowned Viriathus, prevailed upon the Romans to declare war against him without any provocation. As Cæpio commanded an army greatly superior to the *Lusitanians*, Viriathus thought proper to sue for peace; but finding that Cæpio would be satisfied with nothing less than a surrender at discretion, he resolved to stand his ground. In the mean time, the latter having bribed some of the intimate companions of Viriathus to murder him in his sleep, he by that infamous method put an end to a war which had lasted 14 years, very little to the honour of the republic.

7  
Viriathus  
treache-  
rously mu-  
dered.

8  
The Ro-  
mans de-  
feated by  
the Num-  
antines.  
After the death of Viriathus, the Romans with like treachery ordered their new consul *Popilius* to break the treaty with the *Numantines*. His infamous conduct met with the reward it deserved; the *Numantines* falling out, put the whole Roman army to flight with such slaughter, that they were in no condition to act during the whole campaign. *Mancinus*, who succeeded *Popilius*, met with still worse success; his great army, consisting of 30,000 men, was utterly defeated by 4000 *Numantines*, and 20,000 of them killed in the pursuit. The remaining 10,000, with their general, were pent up by the *Numantines* in such a manner that they could neither advance nor retreat, and would certainly have been all put to the sword or made prisoners, had not the *Numantines*, with a generosity which their enemies never possessed, offered to let them depart upon condition that a treaty should be concluded with them upon very moderate terms. This the consul very willingly promised, but found himself unable to perform. On the contrary, the people, not satisfied with declaring his treaty null and void, ordered him to be delivered up to the *Numantines*. The latter refused to accept him, un-  
less

Spain.

less he had along with him the 10,000 men whom they had relieved as above related. At last, after the consul had remained a whole day before the city, his successor Furius, thinking this a sufficient recompense to the Numantines for breaking the treaty, ordered him to be received again into the camp. However, Furius did not choose to engage with such a desperate and resolute enemy as the Numantines had showed themselves; and the war with them was discontinued till the year 133 B. C. when Scipio Æmilianus, the destroyer of Carthage, was sent against them. Against this renowned commander the Numantines with all their valour were not able to cope. Scipio, having with the utmost care introduced strict discipline among his troops, and reformed the abuses which his predecessors had suffered in their armies, by degrees brought the Romans to face their enemies, which at his arrival they had absolutely refused to do. Having then ravaged all the country round about the town, it was soon blocked up on all sides, and the inhabitants began to feel the want of provisions. At last they resolved to make one desperate attempt for their liberty, and either to break through their enemies, or perish in the attempt. With this view they marched out in good order by two gates, and fell upon the works of the Romans with the utmost fury. The Romans, unable to stand this desperate shock, were on the point of yielding; but Scipio, hastening to the places attacked, with no fewer than 20,000 men, the unhappy Numantines were at last driven into the city, where they sustained for a little longer the miseries of famine. Finding at last, however, that it was altogether impossible to hold out, it was resolved by the majority to submit to the pleasure of the Roman commander. But this resolution was not universally approved. Many shut themselves up in their houses, and died of hunger, while even those who had agreed to surrender repented their offer, and setting fire to their houses, perished in the flames with their wives and children, so that not a single Numantine was left alive to grace the triumph of the conqueror of Carthage.

After the destruction of Numantia the whole of Spain submitted to the Roman yoke; and nothing remarkable happened till the times of the Cimbri, when a prætorian army was cut off in Spain by the Lusitanians. From this time nothing remarkable occurs in the history of Spain till the civil war between Marius and Sylla. The latter having crushed the Marian faction, as related under the article ROME, proscribed all those that had sided against him whom he could not immediately destroy. Among these was Sertorius, a man of consummate valour and experience in war. He had by Marius been appointed prætor of Spain; and upon the overthrow of Marius, retired to that province. Sylla no sooner heard of his arrival in that country, than he sent thither one Caius Anniius with a powerful army to drive him out. As Sertorius had but few troops along with him, he dispatched one Julius Salinator with a body of 6000 men to guard the passes of the Pyrenees, and to prevent Anniius from entering the country. But Salinator having been treacherously murdered by assassins hired by Anniius for that purpose, he no longer met with any obstacle; and Sertorius was obliged to embark for the coast of Africa with 3000 men, being all he had now remaining. With these he landed in Mauritania; but as his men were straggling carelessly about,

great numbers of them were cut off by the Barbarians: This new misfortune obliged Sertorius to re-embark for Spain; but finding the whole coast lined with the troops of Anniius, he put to sea again, not knowing what course to steer. In this new voyage he met with a small fleet of Cilician pirates; and having prevailed with them to join him, he made a descent on the coast of Yvica, overpowered the garrison left there by Anniius, and gained a considerable booty. On the news of this victory Anniius set sail for Yvica, with a considerable squadron, having 5000 land forces on board. Sertorius, not intimidated by the superiority of the enemy, prepared to give them battle. But a violent storm arising, most of the ships were driven on shore and dashed to pieces, Sertorius himself with great difficulty escaping with the small remains of his fleet. For some time he continued in great danger, being prevented from putting to sea by the fury of the waves, and from landing by the enemy; at last, the storm abating, he passed the straits of Gades, now Gibraltar, and landed near the mouth of the river Bæotis. Here he met with some seamen newly arrived from the Atlantic or Fortunate Islands; and was so taken with the account which they gave him of those happy regions, that he resolved to retire thither to spend the rest of his life in quiet and happiness. But having communicated this design to the Cilician pirates, they immediately abandoned him, and set sail for Africa, with an intention to assist one of the barbarous kings against his subjects who had rebelled. Upon this Sertorius sailed thither also, but took the opposite side; and having defeated the king named *Afcalus*, obliged him to shut himself up in the city of Tingis, now Tangier, which he closely besieged. But in the mean time Pacianus, who had been sent by Sylla to assist the king, advanced with a considerable army against Sertorius. Upon this the latter, leaving part of his forces before the city, marched with the rest to meet Pacianus, whose army, though greatly superior to his own in number, he entirely defeated; killed the general, and took all his forces prisoners.—The fame of this victory soon reached Spain; and the Lusitanians, being threatened with a new war from Anniius, invited Sertorius to head their armies. With this request he very readily complied, and soon became very formidable to the Romans. Titus Didius, governor of that part of Spain called *Bætica*, first entered the lists with him; but he being defeated, Sylla next dispatched Metellus, reckoned one of the best commanders in Rome, to stop the progress of this new enemy. But Metellus, notwithstanding all his experience, knew not how to act against Sertorius, who was continually changing his station, putting his army into new forms, and contriving new stratagems. On his first arrival he sent for L. Domitius, then prætor of Hither Spain, to his assistance; but Sertorius being informed of his march, detached Hirtuleius, or Herculeius, his quæstor, against him, who gave him a total overthrow. Metellus then dispatched Lucius Lollius prætor of Narbonne Gaul against Hirtuleius; but he met with no better success, being utterly defeated, and his lieutenant-general killed.

The fame of these victories brought to the camp of Sertorius such a number of illustrious Roman citizens of the Marian faction, that he formed a design of erecting Lusitania into a republic in opposition to that of Rome. Sylla was continually sending fresh supplies to Metellus;

Spain.

9  
Scipio Æmilianus sent against them.

10  
Miserable end of the people.

11  
Sertorius support the Marian faction in Spain.

12  
Is driven out, and undergoes many hardships.

13  
Lands in Africa, and carries on a successful war in that country.

14  
Returns to Spain, and defeats the Romans there.

15  
rests in a republic.

Spain. Metellus; but Sertorius with an handful of men, accustomed to range about the mountains, to endure hunger and thirst, and live exposed to the inclemencies of the weather, so harassed the Roman army, that Metellus himself began to be quite discouraged. At last, Sertorius, hearing that Metellus had spoken disrespectfully of his courage, challenged his antagonist to end the war by single combat; but Metellus very prudently declined the combat, as being advanced in years; yet this refusal brought upon him the contempt of the unthinking multitude, upon which Metellus resolved to retrieve his reputation by some signal exploit, and therefore laid siege to Lacobriga, a considerable city in those parts. This he hoped to reduce in two days, as there was but one well in the place; but Sertorius, having previously removed all those who could be of no service during the siege, and conveyed 6000 skins full of water into the city, Metellus continued a long time before it without making any impression. At last, his provisions being almost spent, he sent out Aquinus at the head of 6000 men to procure a new supply; but Sertorius falling unexpectedly upon them, cut in pieces or took the whole detachment; the commander himself being the only man who escaped to carry the news of the disaster; upon which Metellus was obliged to raise the siege with disgrace.

16  
Obtains  
Metellus to  
raise the  
siege of La-  
cobriga.

17  
Civilizes the  
Lusitanians.

And now Sertorius, having gained some intervals of ease in consequence of the many advantages he had obtained over the Romans, began to civilize his new subjects. Their savage and furious manner of fighting he changed for the regular order and discipline of a well-torned army; he bestowed liberally upon them gold and silver to adorn their arms, and by conversing familiarly with them, prevailed upon them to lay aside their own drefs for the Roman *toga*. He sent for all the children of the principal people, and placed them in the great city of Osea, now Huesca, in the kingdom of Arragon, where he appointed them masters to instruct them in the Roman and Greek learning, that they might, as he pretended, be capable of sharing with him the government of the republic. Thus he made them really hollages for the good behaviour of their parents; however, the latter were greatly pleased with the care he took of their children, and all Lusitania were in the highest degree attached to their new sovereign. This attachment he took care to heighten by the power of superstition; for having procured a young hind of a milk-white colour, he made it so tame that it followed him wherever he went; and Sertorius gave out to the ignorant multitude, that this hind was inspired by Diana, and revealed to him the designs of his enemies, of which he always took care to be well informed by the great number of spies he employed.

While Sertorius was thus employed in establishing his authority, the republic of Rome, alarmed at his success, resolved to crush him at all events. Sylla was now dead, and all the eminent generals in Rome solicited this honourable though dangerous employment. After much debate a decree was passed in favour of Pompey the Great, but without recalling Metellus. In the mean time, the troops of one Perperna, or Perperna, had, in spite of all that their general could do, abandoned him and taken the oath of allegiance to Sertorius. This was a most signal advantage to Sertorius; for Perperna commanded an army of 33,000 men, and had

18  
Pompey  
the Great  
sent against  
him.

Spain. come into Spain with a design to settle there as Sertorius had done; but as he was descended from one of the first families in Rome, he thought it below his dignity to serve under any general, however eminent he might be. But the troops of Perperna were of a different opinion; and therefore declaring that they would serve none but a general who could defend himself, they to a man joined Sertorius; upon which Perperna himself, finding he could do no better, consented to serve also as a subaltern.

On the arrival of Pompey in Spain, several of the cities which had hitherto continued faithful to Sertorius began to waver; upon which the latter resolved, by some signal exploit, to convince them that Pompey could no more screen them from his resentment than Metellus. With this view he laid siege to Lauron, now Liria, a place of considerable strength. Pompey, not doubting but he should be able to raise the siege, marched quite up to the enemy's lines, and found means to inform the garrison that those who besieged them were themselves besieged, and would soon be obliged to retire with loss and disgrace. On hearing this message, "I will teach Sylla's disciple (said Sertorius), that it is the duty of a general to look behind as well as before him." Having thus spoken, he sent orders to a detachment of 6000 men, who lay concealed among the mountains, to come down and fall upon his rear if he should offer to force the lines. Pompey, surpris'd at their sudden appearance, durst not stir out of his camp; and in the mean time the besieged, despairing of relief, surrendered at discretion; upon which Sertorius granted them their lives and liberty, but reduced their city to ashes.

19  
Sertorius  
besieges  
Lauron.

20  
Takes, and  
burns it in  
the sight of  
Pompey.

While Sertorius was thus successfully contending with Pompey, his quaestor Hirtulcius was entirely defeated by Metellus, with the loss of 20,000 men; upon which Sertorius advanced with the utmost expedition to the banks of the Suero in Tarraconian Spain, with a design to attack Pompey before he could be joined by Metellus. Pompey, on his part, did not decline the combat; but, fearing that Metellus might share the glory of the victory, advanced with the greatest expedition. Sertorius put off the battle till towards the evening; Pompey, though he knew that the night would prove disadvantageous to him, whether vanquished or victorious, because his troops were unacquainted with the country, resolved to venture an engagement, especially as he feared that Metellus might arrive in the mean time, and rob him of part of the glory of conquering so great a commander. Pompey, who commanded his own right wing, soon obliged Perperna, who commanded Sertorius's left, to give way. Hereupon Sertorius himself taking upon him the command of that wing, brought back the fugitives to the charge, and obliged Pompey to fly in his turn. In his flight he was overtaken by a gigantic African, who had already lifted up his hand to discharge a blow at him with his broad sword; but Pompey prevented him by cutting off his right hand at one blow. As he still continued his flight, he was wounded and thrown from his horse; so that he would certainly have been taken prisoner, had not the Africans who pursued him quarrelled about the rich furniture of his horse. This gave an opportunity to the general to make his escape; so that at length he reached his camp with much difficul-

21  
Defeats  
Pompey on  
the banks  
of the  
Suero.



<sup>Spain.</sup> rest, and rolling down huge stones from the mountains upon the Moors (the name by which the Saracens were known in Spain), no fewer than 124,000 of these unhappy people perished in one day. The remainder fled till they were stopped by a river, and beginning to coast it, part of a mountain suddenly fell down, (stopped up the channel of the river, and either crushed or drowned, by the sudden rising of the water, almost every one of that vast army.

<sup>30</sup> Another army cut in pieces or taken. The Moors were not so much disheartened by this disaster, but that they made a second attempt against Don Pelagio. Their success was as bad as ever, the greatest part of their army being cut in pieces or taken; in consequence of which, they lost all the Asturias, and never dared to enter the lists with Pelagio afterwards. Indeed, their bad success had in a great measure taken from them the desire of conquering a country where little or nothing was to be got; and therefore they rather directed their force against France, where they hoped for more plunder. Into this country they poured in prodigious multitudes; but were utterly defeated, in 732, by Charles Martel, with the loss of 300,000 men, as the historians of those times pretend.

<sup>31</sup> The Saracens utterly defeated by Charles Martel. Don Pelagio died in 737, and soon after his death such intestine divisions broke out among the Moors, as greatly favoured the increase of the Christian power. In 745 Don Alonso the Catholic, son-in-law to Pelagio, in conjunction with his brother Froila, passed the mountains, and fell upon the northern part of Galicia; and meeting with little resistance, he recovered almost the whole of that province in a single campaign. Next year he invaded the plains of Leon and Castile; and before the Moors could assemble any force to oppose him, he reduced Astorgas, Leon, Saldagna, Montes de Oca, Amaya, Alava, and all the country at the foot of the mountains. The year following he pushed his conquests as far as the borders of Portugal, and the next campaign ravaged the country as far as Castile. Being sensible, however, that he was yet unable to defend the flat country which he had conquered, he laid the whole of it waste, obliged the Christians to retire to the mountains, and carried off all the Moors for slaves. Thus secured by a desert frontier, he met with no interruption for some years; during which time, as his kingdom advanced in strength, he allowed his subjects gradually to occupy part of the flat country, and to rebuild Leon and Astorgas, which he had demolished. He died in 757, and was succeeded by his son Don Froila. In his time Abdelrahman, the khaliff's viceroy in Spain, threw off the yoke, and rendered himself independent, fixing the seat of his government at Cordova. Thus the intestine divisions among the Moors were composed; yet their success seems to have been little better than before; for, soon after, Froila encountered the Moors with such success, that 54,000 of them were killed on the spot, and their general taken prisoner. Soon after he built the city of Oviedo, which he made the capital of his dominions, in order to be in a better condition to defend the flat country, which he now determined to people.

<sup>32</sup> Conquests of the Christians. In the year 758 the power of the Saracens received another blow by the rise of the kingdom of Navarre. This kingdom, we are told, took its origin from an accidental meeting of gentlemen, to the number of 600,

at the tomb of an hermit named *John*, who had died among the Pyrenees. At this place, where they had met on account of the supposed sanctity of the deceased, they took occasion to converse on the cruelty of the Moors, the miseries to which the country was exposed, and the glory that would result from throwing off their yoke; which, they supposed, might easily be done, by reason of the strength of their country. On mature deliberation, the project was approved; one Don Garcia Ximenes was appointed king, as being of illustrious birth, and looked upon as a person of great abilities. He recovered Ainsa, one of the principal towns of the country, out of the hands of the infidels, and his successor Don Garcia Inigas extended his territories as far as Biscay; however, the Moors still possessed Portugal, Murcia, Andalusia, Valentia, Granada, Tortosa, with the interior part of the country as far as the mountains of Castile and Saragossa. Their internal dissensions, which revived after the death of Abdelrahman, contributed greatly to reduce the power of the infidels in general. In 778, Charles the Great being invited by some discontented Moorish governors, entered Spain with two great armies; one passing through Catalonia, and the other through Navarre, where he pushed his conquests as far as the Ebro. On his return he was attacked and defeated by the Moors; though this did not hinder him from keeping possession of all those places he had already reduced. At this time he seems to have been master of Navarre: however, in 831 count Azner, revolting from Pepin son to the emperor Louis, again revived the independency of Navarre; but the sovereigns did not assume the title of kings till the time of Don Garcia, who began to reign in 857.

<sup>35</sup> Conquest of Charles the Great. In the mean time, the kingdom founded by Don Pelagio, now called the kingdom of *Leon* and *Oviedo*, continued to increase rapidly in strength, and many advantages were gained over the Moors, who having two enemies to contend with, lost ground every day. In 921, however, they gained a great victory over the united forces of Navarre and Leon, by which the whole force of the Christians in Spain must have been entirely broken, had not the victors conducted their affairs so wretchedly, that they suffered themselves to be almost entirely cut in pieces by the remains of the Christian army. In short, the Christians became at length so terrible to the Moors, that it is probable they could not long have kept their footing in Spain, had not a great general, named *Mohammed Ebn Amir Almanzor*, appeared, in 979, to support their sinking cause. This man was viceroy to the king of Cordova, and being exceedingly provoked against the Christians on account of what his countrymen had suffered from them, made war with the most implacable fury. He took the city of Leon, murdered the inhabitants, and reduced the houses to ashes. Barcelona shared the same fate; Castile was reduced to a desert; Galicia and Portugal ravaged; and he is said to have overcome the Christians in fifty different engagements. At last, having taken and demolished the city of Compostella, and carried off in triumph the gates of the church of St James, a flux happened to break out among his troops, which the superstitious Christians supposed to be a divine judgement on account of his sacrilege. Taking it for granted, therefore, that the Moors were now entirely destitute of all heavenly aid, they fell upon them with

<sup>Spain.</sup> such fury in the next engagement, that all the valour and conduct of Almanzor could not prevent a defeat. <sup>37</sup> He <sup>is de-</sup> overcome with shame and despair at this misfortune, <sup>seated, and</sup> he desired his followers to shift for themselves, while he <sup>starveshim-</sup> himself retired to Medina Cœli, and put an end to his <sup>self to</sup> life by abstinence in the year 998.

<sup>38</sup> <sup>History of</sup> During this period a new Christian principality appeared in Spain, namely that of Castile, which is now divided into the Old and New Castile. The Old Castile was recovered long before that called the *New*. It was separated from the kingdom of Leon on one side by some little rivers; on the other, it was bounded by the Asturias, Biscay, and the province of Rioja. On the south it had the mountains of Segovia and Avila; thus lying in the middle between the Christian kingdom of Leon and Oviedo, and the Moorish kingdom of Cordova. Hence this district soon became an object of contention between the kings of Leon and those of Cordova; and as the former were generally victorious, some of the principal Castilian nobility retained their independency under the protection of the Christian kings, even when the power of the Moors was at its greatest height. In 884 we first hear of Don Rodriguez assuming the title of *count of Castile*, though it does not appear that either his territory or title were given him by the king of Leon. Nevertheless, this monarch having taken upon him to punish some of the Castilian lords as rebels, the inhabitants made a formal renunciation of their allegiance, and set up a new kind of government. The supreme power was now vested in two persons of quality styled *judges*; however, this method did not long continue to give satisfaction, and the sovereignty was once more vested in a single person. By degrees Castile fell entirely under the power of the kings of Leon and Oviedo; and, in 1035, Don Sanchez bestowed it on his eldest son Don Ferdinand, with the title of *king*; and thus the territories of Castile were first firmly united to those of Leon and Oviedo, and the sovereigns were thenceforth styled *kings of Leon and Castile*.

<sup>39</sup> <sup>History of</sup> Besides all these, another Christian kingdom was set up in Spain about the beginning of the 11th century. This was the kingdom of Arragon. The inhabitants were very brave, and lovers of liberty, so that it is probable they had in some degree maintained their independency, even when the power of the Moors was greatest. The history of Arragon, however, during its infancy, is much less known than that of any of the others hitherto mentioned. We are only assured, <sup>40</sup> <sup>State of</sup> that about the year 1035, Don Sanchez, surnamed the *Great*, king of Navarre, erected Arragon into a kingdom in favour of his son Don Ramira, and afterwards it became very powerful. At this time, then, we may imagine the continent of Spain divided into two unequal parts by a straight line drawn from east to west, from the coasts of Valentia to a little below the mouth of the Duro. The country north of this belonged to the Christians, who, as yet, had the smallest and least valuable share, and all the rest to the Moors. In point of wealth and real power, both by land and sea, the Moors were greatly superior; but their continual dissensions greatly weakened them, and every day facilitated the progress of the Christians. Indeed, had either of the parties been united, the other must soon have yielded; for though the Christians did not make war

upon each other constantly as the Moors did, their mutual feuds were yet sufficient to have ruined them, had their adversaries made the least use of the advantages thus afforded them. But among the Moors almost every city was a kingdom; and as these petty sovereignties supported one another very indifferently, they fell a prey one after another to their enemies. In 1080, the king of Toledo was engaged in a war with the king of Seville, another Moorish potentate; which being observed by Alphonso king of Castile, he also invaded his territories; and in four years made himself master of the city of Toledo, with all the places of importance in its neighbourhood; from thenceforth making Toledo the capital of his dominions. In a short time the whole province of New Castile submitted; and Madrid, the present capital of Spain, fell into the hands of the Christians, being at that time but a small place.

The Moors were so much alarmed at these conquests, that they not only entered into a general confederacy against the Christians, but invited to their assistance Mahomet Ben Joseph the sovereign of Barbary. He accordingly came, attended by an incredible multitude; but was utterly defeated by the Christians in the defiles of the Black Mountain, or Sierra Morena, on the borders of Andalusia. This victory happened on the 16th of July 1212, and the anniversary is still celebrated at Toledo. This victory was not improved; the Christian army immediately dispersed themselves, while the Moors of Andalusia were strengthened by the remains of the African army; yet, instead of being taught, by their past misfortunes, to unite among themselves, their dissensions became worse than ever, and the conquests of the Christians became daily more rapid. In 1236, Don Ferdinand of Castile and Leon took the celebrated city of Cordova, the residence of the first Moorish kings; at the same time that James I. of Arragon dispossessed them of the island of Majorca, and drove them out of Valentia. Two years after, Ferdinand made himself master of Murcia, and took the city of Seville; and in 1303 Ferdinand IV. reduced Gibraltar.

In the time of Edward III. we find England, for the first time, interfering in the affairs of Spain, on the following occasion. In the year 1284 the kingdom of Navarre had been united to that of France by the marriage of Donna Joanna queen of Navarre with Philip the Fair of France. In 1328, however, the kingdoms were again separated, though the sovereigns of Navarre were still related to those of France. In 1350, Charles, surnamed the *Wicked*, ascended the throne of Navarre, and married the daughter of John king of France. Notwithstanding this alliance, and that he himself was related to the royal family of France, he secretly entered into a negotiation with England against the French monarch, and even drew into his schemes the dauphin Charles, afterwards surnamed *the Wise*. The young prince, however, was soon after made fully sensible of the danger and folly of the connections into which he had entered; and, by way of atonement, promised to sacrifice his associates. Accordingly he invited the king of Navarre, and some of the principal nobility of the same party, to a feast at Rouen, where he betrayed them to his father. The most obnoxious were executed, and the king of Navarre was thrown into prison. In this extremity, the party of the king of Navarre had recourse to England. The prince of Wales, surnamed

<sup>Spain.</sup> <sup>41</sup> Toledo and Madrid taken by the Christians.

<sup>42</sup> A signal victory gained over the Moors.

<sup>43</sup> England interferes in the Spanish affairs.

<sup>44</sup> The king of Navarre imprisoned by a king of France.

<sup>Spain.</sup> *the Black Prince*, invaded France, defeated king John at Poitiers, and took him prisoner †; which unfortunate event produced the most violent disturbances in that kingdom. The dauphin, now about 19 years of age, naturally assumed the royal power during his father's captivity: but possessed neither experience nor authority sufficient to remedy the prevailing evils. In order to obtain supplies, he assembled the states of the kingdom: but that assembly, instead of supporting his administration, laid hold of the present opportunity to demand limitations of the prince's power, the punishment of past malversations, and the liberty of the king of Navarre. Marcel, provost of the merchants of Paris, and first magistrate of that city, put himself at the head of the unruly populace, and pushed them to commit the most criminal outrages against the royal authority. They detained the dauphin in a kind of captivity, murdered in his presence Robert de Clermont and John de Couflans, marshals of France; threatened all the other ministers with the like fate; and when Charles, who had been obliged to temporize and dissemble, made his escape from their hands, they levied war against him, and openly rebelled. The other cities of the kingdom, in imitation of the capital, shook off the dauphin's authority, took the government into their own hands, and spread the contagion into every province.

<sup>45</sup>  
Escapes, and heads the French malecontents.

Amidst these disorders, the king of Navarre made his escape from prison, and presented a dangerous leader to the furious malecontents. He revived his pretensions to the crown of France: but in all his operations he acted more like a leader of banditti than one who aspired to be the head of a regular government, and who was engaged by his station to endeavour the re-establishment of order in the community. All the French, therefore, who wished to restore peace to their country, turned their eyes towards the dauphin; who, though not remarkable for his military talents, daily gained by his prudence and vigilance the ascendant over his enemies. Marcel, the seditious provost of Paris, was slain in attempting to deliver that city to the king of Navarre. The capital immediately returned to its duty: the most considerable bodies of the mutinous peasants were dispersed or put to the sword; some bands of military robbers underwent the same fate; and France began once more to assume the appearance of civil government.

John was succeeded in the throne of France by his son Charles V. a prince educated in the school of adversity, and well qualified, by his prudence and experience, to repair the losses which the kingdom had sustained from the errors of his predecessors. Contrary to the practice of all the great princes of those times, who held nothing in estimation but military courage, he seems to have laid it down as a maxim, never to appear at the head of his armies; and he was the first European monarch that showed the advantage of policy and foresight over a rash and precipitate valour.

<sup>46</sup>  
Is defeated and obliged to submit to the terms prescribed by Char. V of France.

Before Charles could think of counterbalancing so great a power as England, it was necessary for him to remedy the many disorders to which his own kingdom was exposed. He accordingly turned his arms against the king of Navarre, the great disturber of France during that age; and he defeated that prince, and reduced him to terms, by the valour and conduct of Bertrand du Guesclin, one of the most accomplished cap-

tains of those times, whom Charles had the discernment to choose as the instrument of his victories. He also settled the affairs of Brittany, by acknowledging the title of Mountfort, and receiving homage for his dominions. But much was yet to be done. On the conclusion of the peace of Bretigni, the many military adventurers who had followed the fortunes of Edward, being dispersed into the several provinces, and possessed of strongholds, refused to lay down their arms, or relinquish a course of life to which they were now accustomed, and by which alone they could earn a subsistence. They associated themselves with the banditti, who were already inured to the habits of rapine and violence; and, under the name of *companies* and *companions*, became a terror to all the peaceable inhabitants. Some English and Gascon gentlemen of character were not ashamed to take the command of these ruffians, whose number amounted to near 40,000, and who bore the appearance of regular armies rather than bands of robbers. As Charles was not able by power to redress so enormous a grievance, he was led by necessity, as well as by the turn of his character, to correct it by policy; to discover some method of discharging into foreign countries this dangerous and intestine evil; and an occasion now offered.

<sup>Spirit.</sup>  
<sup>47</sup>  
Account of the banditti called *companies* or *companions*.

Alphonso XI. king of Castile, who took the city of Algezira from the Moors, after a famous siege of two years, during which artillery are said first to have been used by the besieged, had been succeeded by his son Peter I. surnamed *the Cruel*; a prince equally perfidious, debauched, and bloody. He began his reign with the murder of his father's mistress Leonora de Gusman: his nobles fell every day the victims of his severity: he put to death his cousin and one of his natural brothers, from groundless jealousy; and he caused his queen Blanche de Bourbon, of the blood of France, to be thrown into prison, and afterwards poisoned, that he might enjoy in quiet the embraces of Mary de Padella, with whom he was violently enamoured.

<sup>48</sup>  
Reign of Peter the Cruel, king of Castile.

Henry count of Trastamara, the king's natural brother, alarmed at the fate of his family, and dreading his own, took arms against the tyrant; but having failed in the attempt, he fled to France, where he found the minds of men much inflamed against Peter, on account of the murder of the French princefs. He asked permission of Charles to enlist the *companies* in his service, and to lead them into Castile against his brother. The French king, charmed with the project, employed du Guesclin in negotiating with the leaders of these banditti. The treaty was soon concluded; and du Guesclin having completed his levies, led the army first to Avignon, where the Pope then resided, and demanded, sword in hand, absolution for his ruffian soldiers, who had been excommunicated, and the sum of 200,000 livres for their subsistence. The first was readily promised him; but some difficulty being made with regard to the second, du Guesclin replied, "My fellows, I believe, may make a shift to do without your absolution, but the money is absolutely necessary." His Holiness then extorted from the inhabitants of the city and its neighbourhood the sum of 100,000 livres, and offered it to du Guesclin. "It is not my purpose (cried that generous warrior) to oppress the innocent people." The pope and his cardinals can spare me double the sum from their own pockets. I therefore insist, that

<sup>49</sup>  
The *Companies* employed against him.



<sup>Spain.</sup> this money be restored to the owners; and if I hear they are defrauded of it, I will myself return from the other side of the Pyrenees, and oblige you to make them restitution." The pope found the necessity of submitting, and paid from his own treasury the sum demanded.

<sup>50</sup> He is driven out, but assisted by the Black Prince. A body of experienced and hardy soldiers, conducted by so able a general, easily prevailed over the king of Castile, whose subjects were ready to join the enemy against their oppressor. Peter fled from his dominions, took shelter in Guienne, and craved the protection of the prince of Wales, whom his father had invested with the sovereignty of the ceded provinces, under the title of the *principality of Aquitaine*. The prince promised his assistance to the dethroned monarch; and having obtained his father's consent, he levied an army, and set out on his enterprise.

The first loss which Henry of Trastamara suffered from the interposition of the prince of Wales, was the recalling of the companies from his service; and so much reverence did they pay to the name of Edward, that great numbers of them immediately withdrew from Spain, and enlisted under his standard. Henry, however, beloved by his new subjects, and supported by the king of Arragon, was able to meet the enemy with an army of 100,000 men, three times the number of those commanded by the Black Prince: yet du Guesclin, and all his experienced officers, advised him to delay a decisive action; so high was their opinion of the valour and conduct of the English hero! But Henry, trusting to his numbers, ventured to give Edward battle on the banks of the Ebro, between Najara and Navarrete; where the French and Spaniards were defeated, with the loss of above 20,000 men, and du Guesclin and other officers of distinction taken prisoners. All Castile submitted to the victor; Peter was restored to the throne, and Edward returned to Guienne with his usual glory; having not only overcome the greatest general of his age, but restrained the most blood-thirsty tyrant from executing vengeance on his prisoners.

This gallant warrior had soon reason to repent of his connections with a man like Peter, lost to all sense of virtue and honour. The ungrateful monster refused the stipulated pay to the English forces. Edward abandoned him: he treated his subjects with the utmost barbarity; their animosity was roused against him; and du Guesclin having obtained his ransom, returned to Castile with the count of Trastamara, and some forces levied anew in France. They were joined by the Spanish malecontents; and having no longer the Black Prince to encounter, they gained a complete victory over Peter in the neighbourhood of Toledo. The tyrant now took refuge in a castle, where he was soon after besieged by the victors, and taken prisoner in endeavouring to make his escape. He was conducted to his brother Henry; against whom he is said to have rushed in a transport of rage, disarmed as he was. Henry slew him with his own hand, in resentment of his cruelties; and, though a bastard, was placed on the throne of Castile, which he transmitted to his posterity.

After the death of Peter the Cruel, nothing remarkable happened in Spain for almost a whole century; but the debaucheries of Henry IV. of Castile roused the resentment of his nobles, and produced a most singular in-

urrection, which led to the aggrandizement of the Spanish monarch.

This prince, surnamed the *Impotent*, though continually surrounded with women, began his unhappy reign in 1454. He was totally enervated by his pleasures; and every thing in his court conspired to set the Castilians an example of the most abject flattery and most abandoned licentiousness. The queen, a daughter of Portugal, lived as openly with her parasites and her gallants as the king did with his minions and his mistresses. Pleasure was the only object, and effeminacy the only recommendation to favour: the affairs of the state went every day into disorder; till the nobility, with the archbishop of Toledo at their head, combining against the weak and flagitious administration of Henry, arrogated to themselves, as one of the privileges of their order, the right of trying and passing sentence on their sovereign, which they executed in a manner unprecedented in history.

All the malecontent nobility were summoned to meet at Avila: a spacious theatre was erected in a plain without the walls of the town: an image, representing the king, was seated on a throne, clad in royal robes, with a crown on its head, a sceptre in its hand, and the sword of justice by its side. The accusation against Henry was read, and the sentence of deposition pronounced, in presence of a numerous assembly. At the close of the first article of the charge, the archbishop of Toledo advanced, and tore the crown from the head of the image; at the close of the second, the Conde de Placentia snatched the sword of justice from its side; at the close of the third, the Conde de Benavente wrested the sceptre from its hand; and at the close of the last, Don Diego Lopez de Stuniga tumbled it headlong from the throne. At the same instant, Don Alphonso, Henry's brother, a boy of about twelve years of age, was proclaimed king of Castile and Leon in his stead.

This extraordinary proceeding was followed by a civil war, which did not cease till some time after the death of the young prince, on whom the nobles had bestowed the kingdom. The archbishop and his party then continued to carry on war in the name of Isabella the king's sister, to whom they gave the title of *Infanta*; and Henry could not extricate himself out of these troubles, nor remain quiet upon his throne till he had signed one of the most humiliating treaties ever extorted from a sovereign; he acknowledged his sister Isabella the only lawful heiress of his kingdom, in prejudice to the rights of his reputed daughter Joan, whom the malecontents affirmed to be the offspring of an adulterous commerce between the queen and Don la Cueva.

The grand object of the malecontent party now was the marriage of the prince's Isabella, upon which, it was evident, the security of the crown and the happiness of the people must in a great measure depend. The alliance was sought by several princes: the king of Portugal offered her his hand; the king of France demanded her for his brother, and the king of Arragon for his son Ferdinand. The malecontents very wisely preferred the Arragonian prince, and Isabella prudently made the same choice: articles were drawn up; and they were privately married by the archbishop of Toledo.

Spain.

Henry was enraged at this alliance, which he foresaw would utterly ruin his authority, by furnishing his rebellious subjects with the support of a powerful neighbouring prince. He disinherited his sister, and established the rights of his daughter. A furious civil war desolated the kingdom. The names of Joan and Isabella resounded from every quarter, and were everywhere the summons to arms. But peace was at length brought about. Henry was reconciled to his sister and Ferdinand; though it does not appear that he ever renewed Isabella's right to the succession: for he affirmed in his last moments, that he believed Joan to be his own daughter. The queen swore to the same effect; and Henry left a testamentary deed, transmitting the crown to this princess, who was proclaimed queen of Castile at Placentia. But the superior fortune and superior arms of Ferdinand and Isabella prevailed: the king of Portugal was obliged to abandon his niece and intended bride, after many ineffectual struggles, and several years of war. Joan retired into a convent; and the death of Ferdinand's father, which happened about this time, added the kingdoms of Arragon and Sicily to those of Leon and Castile.

57  
Union of the kingdoms of Arragon and Sicily with Leon and Castile.

58  
Administration of Ferdinand and Isabella.

Ferdinand and Isabella were persons of great prudence, and, as sovereigns, highly worthy of imitation: but they do not seem to have merited all the praises bestowed upon them by the Spanish historians. They did not live like man and wife, having all things in common under the direction of the husband; but like two princes in close alliance; they neither loved nor hated each other; were seldom in company together; had each a separate council; and were frequently jealous of one another in the administration. But they were inseparably united in their common interests; always acting upon the same principles, and forwarding the same ends. Their first object was the regulation of their government, which the civil wars had thrown into the greatest disorder. Rapine, outrage, and murder, were become so common, as not only to interrupt commerce, but in a great measure to suspend all intercourse between one place and another. These evils the joint sovereigns suppressed by their wise policy, at the same time that they extended the royal prerogative.

59  
Institution of the Holy Brotherhood.

About the middle of the 13th century, the cities in the kingdom of Arragon, and after their example those in Castile, had formed themselves into an association, distinguished by the name of the *Holy Brotherhood*. They exacted a certain contribution from each of the associated towns; they levied a considerable body of troops, in order to protect travellers and pursue criminals; and they appointed judges, who opened courts in various parts of the kingdom. Whoever was guilty of murder, robbery, or any act that violated the public peace, and was seized by the troops of the Brotherhood, was carried before their judges; who, without paying any regard to the exclusive jurisdiction which the lord of the place might claim, who was generally the author or abettor of the injustice, tried and condemned the criminals. The nobles often murmured against this salutary institution; they complained of it as an encroachment on one of their most valuable privileges, and endeavoured to get it abolished. But Ferdinand and Isabella, sensible of the beneficial effects of the Brotherhood, not only in regard to the police of their kingdom, but in its tendency to abridge, and by de-

grees annihilate, the territorial jurisdiction of the nobility, countenanced the institution upon every occasion, and supported it with the whole force of royal authority; by which means the prompt and impartial administration of justice was restored, and with it tranquillity and order returned.

Spain.

But at the same time that their Catholic majesties (for such was the title they now bore) were giving vigour to their civil government, and securing their subjects from violence and oppression, an intemperate zeal led them to establish an ecclesiastical tribunal, equally contrary to the natural rights of humanity and the mild spirit of the gospel. This was the court of inquisition; which decides upon the honour, fortune, and even the life, of the unhappy wretch who happens to fall under the suspicion of heresy, or a contempt of any thing prescribed by the church, without his knowing, being confronted with his accusers, or permitted either defence or appeal. Six thousand persons were burnt by order of this sanguinary tribunal within four years after the appointment of Torquemada, the first inquisitor-general; and upwards of 100,000 felt its fury. The same furious and blinded zeal which led to the depopulation of Spain, led also to its aggrandizement.

60  
And of the Inquisition

The kingdom of Granada now alone remained of all the Mahometan possessions in Spain. Princes equally zealous and ambitious were naturally disposed to turn their eyes to that fertile territory, and to think of increasing their hereditary dominions, by expelling the enemies of Christianity, and extending its doctrines. Every thing conspired to favour their project: the Moorish kingdom was a prey to civil wars; when Ferdinand, having obtained the bull of Sixtus IV. authorizing a crusade, put himself at the head of his troops, and entered Granada. He continued the war with rapid success: Isabella attended him in several expeditions; and they were both in great danger at the siege of Malaga; an important city, which was defended with great courage, and taken in 1487. Baza was reduced in 1489, after the loss of 20,000 men. Guadix and Almeria were delivered up to them by the Moorish king Alzagal, who had first dethroned his brother Alboacen, and afterwards been chased from his capital by his nephew Abdali. That prince engaged in the service of Ferdinand and Isabella; who, after reducing every other place of eminence, undertook the siege of Granada. Abdali made a gallant defence; but all communication with the country being cut off, and all hopes of relief at an end, he capitulated, after a siege of eight months, on condition that he should enjoy the revenue of certain places in the fertile mountains of Alpujarros; that the inhabitants should retain the undisturbed possession of their houses, goods, and inheritances; the use of their laws, and the free exercise of their religion. Thus ended the empire of the Arabs in Spain, after it had continued about 800 years. They introduced the arts and sciences into Europe at a time when it was lost in darkness; they possessed many of the luxuries of life, when they were not even known among the neighbouring nations; and they seem to have given birth to that romantic gallantry which so eminently prevailed in the ages of chivalry, and which, blending itself with the veneration of the northern nations for the softer sex, still particularly distinguishes ancient from modern manners.

61  
Conquest of Granada.

<sup>Spain.</sup> ners. But the Moors, notwithstanding these advantages, and the enlogies bestowed upon them by some writers, appear always to have been destitute of the essential qualities of a polished people, humanity, generosity, and mutual sympathy.

<sup>62</sup> The conquest of Granada was followed by the expulsion, or rather the pillage and banishment, of the Jews, who had engrossed all the wealth and commerce of Spain. The inquisition exhausted its rage against these unhappy people, many of whom pretended to embrace Christianity, in order to preserve their property. About the same time their Catholic majesties concluded an alliance with the emperor Maximilian, and a treaty of marriage for their daughter Joan with his son Philip, archduke of Austria and sovereign of the Netherlands. About this time also the contract was concluded with Christopher Columbus for the discovery of new countries; and the counties of Roussillon and Cerdagne were agreed to be restored by Charles VIII. of France, before his expedition into Italy. The discovery of America was soon followed by extensive conquests in that quarter, as is related under the articles MEXICO, PERU, CHILI, &c. which tended to raise the Spanish monarchy above any other in Europe.

<sup>63</sup> On the death of Isabella, which happened in 1506, Philip archduke of Austria came to Castile in order to take possession of that kingdom as heir to his mother-in-law; but he dying in a short time after, his son Charles V. afterwards emperor of Germany, became heir to the crown of Spain. His father at his death left the king of France governor to the young prince, and Ferdinand at his death left cardinal Ximenes sole regent of Castile, till the arrival of his grandson. This man, whose character is no less singular than illustrious, who united the abilities of a great statesman with the abject devotion of a superstitious monk, and the magnificence of a prime minister with the severity of a mendicant, maintained order and tranquillity in Spain, notwithstanding the discontents of a turbulent and high-spirited nobility. When they disputed his right to the regency, he coolly showed them the testament of Ferdinand, and the ratification of that deed by Charles; but these not satisfying them, and argument proving ineffectual, he led them insensibly towards a balcony, whence they had a view of a large body of troops under arms, and a formidable train of artillery. "Behold (said the cardinal) the powers which I have received from his Catholic majesty: by these I govern Castile; and will govern it, till the king, your master and mine, shall come to take possession of his kingdom." A declaration so bold and determined silenced all opposition; and Ximenes maintained his authority till the arrival of Charles in 1517.

<sup>64</sup> The young king was received with universal acclamations of joy; but Ximenes found little cause to rejoice. He was seized with a violent disorder, supposed to be the effect of poison; and when he recovered, Charles, prejudiced against him by the Spanish grandees and his Flemish courtiers, slighted his advice, and allowed him every day to sink into neglect. The cardinal did not bear this treatment with his usual fortitude of spirit. He expected a more grateful return from a prince to whom he delivered a kingdom more flourishing than it had been in any former age, and authority more extensive and better established than the most illustrious of his

ancestors had ever possessed. Conscious of his own integrity and merit, he could not therefore refrain from giving vent, at times, to indignation and complaint. He lamented the fate of his country, and foretold the calamities to which it would be exposed from the insolence, the rapaciousness, and the ignorance of strangers. But in the mean time he received a letter from the king, dismissing him from his councils, under pretence of easing his age of that burden which he had so long and so ably sustained. This letter proved fatal to the minister; for he expired in a few hours after reading it.

<sup>66</sup> While Charles was taking possession of the throne of Spain, in consequence of the death of one grandfather, another was endeavouring to obtain for him the imperial crown. With this view Maximilian assembled a diet at Augsbourg, where he cultivated the favour of the electors by many acts of beneficence, in order to engage them to choose that young prince as his successor. But Maximilian himself never having been crowned by the pope, a ceremony deemed essential in that age, as well as in the preceding, he was considered only as king of the Romans, or emperor elect; and no example occurring in history of any person being chosen successor to a king of the Romans, the Germans, always tenacious of their forms, obstinately refused to confer upon Charles a dignity for which their constitution knew no name.

But though Maximilian could not prevail upon the German electors to choose his grandson of Spain king of the Romans, he had disposed their minds in favour of that prince; and other circumstances, on the death of the emperor, conspired to the exaltation of Charles. The imperial crown had so long continued in the Austrian line, that it began to be considered as hereditary in that family; and Germany, torn by religious disputes, stood in need of a powerful emperor, not only to preserve its own internal tranquillity, but also to protect it against the victorious arms of the Turks, who under Selim I. threatened the liberties of Europe. This fierce and rapid conqueror had already subdued the Mamelukes, and made himself master of Egypt and Syria. The power of Charles appeared necessary to oppose that of Selim. The extensive dominions of the house of Austria, which gave him an interest in the preservation of Germany; the rich sovereignty of the Netherlands and Franche Comte; the entire possession of the great and warlike kingdom of Spain, together with that of Naples and Sicily, all united to hold him up to the first dignity among Christian princes; and the new world seemed only to be called into existence that its treasures might enable him to defend Christendom against the infidels. Such was the language of his partisans.

<sup>67</sup> Francis I. however, no sooner received intelligence of the death of Maximilian, than he declared himself a candidate for the empire; and with no less confidence of success than Charles. He trusted to his superior years and experience; his great reputation in arms; and it was farther urged in his favour, that the impetuosity of the French cavalry, added to the firmness of the German infantry, would prove irresistible, and not only be sufficient, under a warlike emperor, to set limits to the ambition of Selim, but to break entirely the Ottoman power, and prevent it from ever becoming dangerous again to Germany.

Both claims were plausible. The dominions of Francis

Spain.

Maximilian attempts to get Charles elected emperor.

Francis I. aspires to the same dignity.

Spain. cis were less extensive, but more united than those of Charles. His subjects were numerous, active, brave, lovers of glory, and lovers of their king. These were strong arguments in favour of his power, so necessary at this juncture: but he had no natural interest in the Germanic body; and the electors, hearing so much of military force on each side, became more alarmed for their own privileges than the common safety. They determined to reject both candidates, and offered the imperial crown to Frederic, surnamed the *Wise*, duke of Saxony. But he, undazzled by the splendour of an object courted with so much eagerness by two mighty monarchs, rejected it with a magnanimity no less singular than great.

68  
Speech of Frederic duke of Saxony in favour of Charles.

“ In times of tranquillity (said Frederic), we wish for an emperor who has no power to invade our liberties; times of danger demand one who is able to secure our safety. The Turkish armies, led by a warlike and victorious monarch, are now assembling: they are ready to pour in upon Germany with a violence unknown in former ages. New conjunctures call for new expedients. The imperial sceptre must be committed to some hand more powerful than mine or that of any other German prince. We possess neither dominions, nor revenues, nor authority, which enable us to encounter such a formidable enemy. Recourse must be had, in this exigency, to one of the rival monarchs. Each of them can bring into the field forces sufficient for our defence. But as the king of Spain is of German extraction, as he is a member and prince of the empire by the territories which descend to him from his grandfather, and as his dominions stretch along that frontier which lies most exposed to the enemy, his claim, in my opinion, is preferable to that of a stranger to our language, to our blood, and to our country.” Charles was elected in consequence of this speech in the year 1520.

69  
He is elected in consequence of this speech.

The two candidates had hitherto conducted their rivalry with emulation, but without enmity. They had even mingled in their competition many expressions of friendship and regard. Francis in particular declared with his usual vivacity, that his brother Charles and he were fairly and openly suitors to the same mistress: “ The most assiduous and fortunate (added he) will win her; and the other must rest contented.” But the preference was no sooner given to his rival, than Francis discovered all the passions natural to disappointed ambition. He could not suppress his chagrin and indignation at being baulked in his favourite pursuit, and rejected, in the face of all Europe, for a youth yet unknown to fame. The spirit of Charles repented such contempt; and from this jealousy, as much as from opposition of interests, arose that emulation between those two great monarchs which involved them in almost perpetual hostilities, and kept their whole age in movement.

70  
A mutual hatred takes place between Charles and Francis.

Charles and Francis had many interfering claims in Italy; and the latter thought himself bound in honour to restore the king of Navarre to his dominions, unjustly seized by the crown of Spain. They immediately began to negotiate; and as Henry VIII. of England was the third prince of the age in power and in dignity, his friendship was eagerly courted by each of the rivals. He was the natural guardian of the liberties of Europe. Sensible of the consequence which his situation gave him, and proud of his pre-eminence, Henry knew it to

71  
Both court the friendship of Henry VIII. of England.

Spain. be his interest to keep the balance even between the contending powers, and to restrain both, by not joining entirely with either; but he was seldom able to reduce his ideas to practice. Vanity and resentment were the great springs of all his undertakings; and his neighbours, by touching these, found an easy way to draw him into their measures, and force him upon many rash and inconsiderate enterprises.

All the inpolitic steps in Henry's government must not, however, be imputed to himself; many of them were occasioned by the ambition and avarice of his prime minister and favourite cardinal Wolsey. This man, who, by his talents and accomplishments, had risen from one of the lowest conditions in life to the highest employments both in church and state, enjoyed a greater degree of power and dignity than any English subject ever possessed, and governed the haughty, presumptuous, and untractable spirit of Henry, with absolute authority. Francis was equally well acquainted with the character of Henry and of his minister. He had successfully flattered Wolsey's pride, by honouring him with particular marks of his confidence, and bestowing upon him the appellation of *Father, Tutor, and Governor*; and he had obtained the restitution of Tournay, by adding a pension to those respectful titles. He now solicited an interview with the king of England near Calais; in hopes of being able, by familiar conversation, to attach him to his friendship and interest, while he gratified the cardinal's vanity, by affording him an opportunity of displaying his magnificence in the presence of two courts, and of discovering to the two nations his influence over their monarchs. Charles dreaded the effects of this projected interview between two gallant princes, whose hearts were no less susceptible of friendship than their manners were of inspiring it. Finding it impossible, however, to prevent a visit, in which the vanity of all parties was so much concerned, he endeavoured to defeat its purpose, and to pre-occupy the favour of the English monarch, and of his minister, by an act of complaisance still more flattering and more uncommon. Relying wholly upon Henry's generosity for his safety, he landed at Dover, in his way from Spain to the Low Countries. The king of England, who was on his way to France, charmed with such an instance of confidence, haled to receive his royal guest; and Charles, during his short stay, had the address not only to give Henry favourable impressions of his character and intentions, but to detach Wolsey entirely from the interest of Francis. The tiara had attracted the eye of that ambitious prelate; and as the emperor knew that the papacy was the sole point of elevation, beyond his present greatness, at which he could aspire, he made him an offer of his interest on the first vacancy.

72  
An interview proposed between Francis and Henry.

Charles dreaded the effects of this projected interview between two gallant princes, whose hearts were no less susceptible of friendship than their manners were of inspiring it. Finding it impossible, however, to prevent a visit, in which the vanity of all parties was so much concerned, he endeavoured to defeat its purpose, and to pre-occupy the favour of the English monarch, and of his minister, by an act of complaisance still more flattering and more uncommon. Relying wholly upon Henry's generosity for his safety, he landed at Dover, in his way from Spain to the Low Countries. The king of England, who was on his way to France, charmed with such an instance of confidence, haled to receive his royal guest; and Charles, during his short stay, had the address not only to give Henry favourable impressions of his character and intentions, but to detach Wolsey entirely from the interest of Francis. The tiara had attracted the eye of that ambitious prelate; and as the emperor knew that the papacy was the sole point of elevation, beyond his present greatness, at which he could aspire, he made him an offer of his interest on the first vacancy.

73  
Charles visits Henry in England.

The day of Charles's departure, Henry went over to Calais with his whole court, in order to meet Francis. Their interview was in an open plain between Guisnes and Ardres; where the two kings and their attendants displayed their magnificence with such emulation and profuse expence, as procured it the name of the *Field of the Cloth of Gold*. Here Henry erected a spacious house of wood and canvas, framed in London, on which, under the figure of an English archer, was the following motto: “ He prevails whom I favour;” alluding to his own political situation, as holding in his hands

74  
Henry visits Francis in France.

hands the balance of power among the potentates of Europe. Feats of chivalry however, parties of gallantry, and such exercises as were in that age reckoned manly or elegant, rather than serious business, occupied the two courts during the time that they continued together, which was 18 days.

After taking leave of this scene of dissipation, the king of England paid a visit to the emperor and Margaret of Savoy at Gravelines, and engaged them to go along with him to Calais; where the artful and politic Charles completed the impression which he had begun to make on Henry and his favourites, and effaced all the friendship to which the frank and generous nature of Francis had given birth. He renewed his assurances of assisting Wolsey in obtaining the papacy; and he put him in present possession of the revenues belonging to the sees of Badajoz and Palencia in Spain. He flattered Henry's pride, by convincing him of his own importance, and of the justness of the motto which he had chosen; offering to submit to his sole arbitration any difference that might arise between him and Francis.

This important point being secured, Charles repaired to Aix-la-Chapelle, where he was solemnly invested with the crown and sceptre of Charlemagne, in presence of a more splendid and numerous assembly than had appeared on any former inauguration. About the same time Solymán the Magnificent, one of the most accomplished, enterprising, and victorious of the Turkish princes, and a constant and formidable rival to the emperor, ascended the Ottoman throne.

The first act of Charles's administration was to appoint a diet of the empire, to be held at Worms, in order to concert with the princes proper measures for checking the progress of "those new and dangerous opinions which threatened to disturb the peace of Germany, and to overturn the religion of their ancestors." The opinions propagated by Luther and his followers were here meant. But all his efforts for that purpose were insufficient, as is related under the articles LUTHER and REFORMATION,

In 1521, the Spaniards, dissatisfied with the departure of their sovereign, whose election to the empire they foresaw would interfere with the administration of his own kingdom, and incensed at the avarice of the Flemings, to whom the direction of public affairs had been committed since the death of cardinal Ximenes, several grandees, in order to shake off this oppression, entered into an association, to which they gave the name of the *Sancta Junta*; and the sword was appealed to as the means of redress. This seemed to Francis a favourable juncture for reinstating the family of John d'Albert in the kingdom of Navarre. Charles was at a distance from that part of his dominions, and the troops usually stationed there had been called away to quell the commotions in Spain. A French army, under Andrew de Foix, speedily conquered Navarre; but that young and inexperienced nobleman, pushed on by military ardour, ventured to enter Castile. The Spaniards, though divided among themselves, united against a foreign enemy, routed his forces, took him prisoner, and recovered Navarre in a shorter time than he had spent in subduing it.

Hostilities thus begun in one quarter, between the rival monarchs, soon spread to another. The king of France encouraged the duke of Bouillon to make war

against the emperor, and to invade Luxembourg. Charles, after humbling the duke, attempted to enter France; but was repelled and worsted before Mezieres by the famous chevalier Bayard, distinguished among his contemporaries by the appellation of *The Knight without fear and without reproach*; and who united the talents of a great general to the punctilious honour and romantic gallantry of the heroes of chivalry. Francis broke into the Low Countries, where, by an excess of caution, an error not natural to him, he lost an opportunity of cutting off the whole imperial army; and, what was of still more consequence, he disgusted the constable Bourbon, by giving the command of the van to the duke of Alençon.

During these operations in the field, an unsuccessful congress was held at Calais, under the mediation of Henry VIII. It served only to exasperate the parties which it was intended to reconcile. A league was soon after concluded, by the intrigues of Wolsey, between the pope, Henry, and Charles, against France. Leo had already entered into a separate league with the emperor, and the French were fast losing ground in Italy.

The insolence and exactions of Mareschal de Lautrec, governor of Milan, had totally alienated the affections of the Milanese from France. They resolved to expel the troops of that nation, and put themselves under the government of Francis Sforza, brother to Maximilian their late duke. In this resolution, they were encouraged by the pope, who excommunicated Lautrec, and took into his pay a considerable body of Swiss. The papal army, commanded by Prosper Colonna, an experienced general, was joined by supplies from Germany and Naples; while Lautrec, neglected by his court, and deserted by the Swiss in its pay, was unable to make head against the enemy. The city of Milan was betrayed by the inhabitants to the confederates; Parma and Placentia were united to the ecclesiastical state; and of their conquests in Lombardy, only the town of Cremona, the castle of Milan, and a few inconsiderable forts, remained in the hands of the French.

Leo X. received the accounts of this rapid success with such transports of joy, as are said to have brought on a fever, which occasioned his death. The spirit of the confederacy was broken, and its operations suspended by this accident. The Swiss were recalled; some other mercenaries disbanded for want of pay; and only the Spaniards, and a few Germans in the emperor's service, remained to defend the duchy of Milan. But Lautrec, who with the remnant of his army had taken shelter in the Venetian territories, destitute both of men and money, was unable to improve this favourable opportunity as he wished. All his efforts were rendered ineffectual by the vigilance and ability of Colonna and his associates.

Meantime much discord prevailed in the conclave. Wolsey's name, notwithstanding all the emperor's magnificent promises, was scarcely mentioned there. Julio de Medici, Leo's nephew, thought himself sure of the election; when, by an unexpected turn of fortune, cardinal Adrian of Utrecht, Charles's preceptor, who at that time governed Spain in the emperor's name, was unanimously raised to the papacy, to the astonishment of all Europe and the great disgust of the Italians.

Francis,

Spain

77  
Rapid conquests of Charles.

Spain  
78  
Francis in-  
vades Italy.

Francis, roused by the rising consequence of his rival, resolved to exert himself with fresh vigour, in order to wrest from him his late conquests in Lombardy. Lautrec received a supply of money, and a reinforcement of 10,000 Swiss. With this reinforcement he was enabled once more to act offensively, and even to advance within a few miles of the city of Milan; when money again failing him, and the Swiss growing mutinous, he was obliged to attack the imperialists in their camp at Bicocca, where he was repulsed with great slaughter, having lost his bravest officers and best troops. Such of the Swiss as survived set out immediately for their own country; and Lautrec, despairing of being able to keep the field, retired into France. Genoa, which still remained subject to Francis, and made it easy to execute any scheme for the recovery of Milan, was soon after taken by Colonna: the authority of the emperor and his faction was everywhere established in Italy. The citadel of Cremona was the sole fortress which remained in the hands of the French.

The affliction of Francis for such a succession of misfortunes was augmented by the unexpected arrival of an English herald, who in the name of his sovereign declared war against France. The courage of this excellent prince, however, did not forsake him; though his treasury was exhausted by expensive pleasures, no less than by hostile enterprises, he assembled a considerable army, and put his kingdom in a posture of defence for resisting this new enemy, without abandoning any of the schemes which he was forming against the emperor. He was surprised, but not alarmed, at such a denunciation.

79  
Charles vi-  
sit-England  
a second  
time.

Meanwhile Charles, willing to draw as much advantage as possible from so powerful an ally, paid a second visit to the court of England in his way to Spain, where his presence was become necessary. His success exceeded his most sanguine expectations. He not only gained the entire friendship of Henry, who publicly ratified the treaty of Bruges; but disarmed the resentment of Wolsey, by assuring him of the papacy on Adrian's death; an event seemingly not distant, by reason of his age and infirmities. In consequence of these negotiations an English army invaded France, under the command of the earl of Surrey; who, at the end of the campaign, was obliged to retire, with his forces greatly reduced, without being able to make himself master of one place within the French frontier. Charles was more fortunate in Spain: he soon quelled the tumults which had there arisen in his absence.

While the Christian princes were thus wasting each other's strength, Solyman the Magnificent entered Hungary, and made himself master of Belgrade, reckoned the chief barrier of that kingdom against the Turkish power. Encouraged by this success, he turned his victorious arms against the island of Rhodes, at that time the seat of the knights of St John of Jerusalem; and though every prince in that age acknowledged Rhodes to be the great bulwark of Christendom in the east, so violent was their animosity against each other, that they suffered Solyman without disturbance to carry on his operations against that city and island. Lisle Adam, the grandmaster, made a gallant defence; but, after incredible efforts of courage, patience, and military conduct, during a siege of six months, he was obliged to surrender the place, having obtained an honourable ca-

80  
Rhodes ra-  
ken by So-  
lyman.

pitulation from the sultan, who admired and respected his heroic qualities (see RHODES and MALTA). Charles and Francis were equally ashamed of having occasioned such a loss to Christendom by their contests; and the emperor, by way of reparation, granted to the knights of St John the small island of Malta, where they fixed their residence, and continued long to retain their ancient spirit, though much diminished in power and splendour.

Adrian VI. though the creature of the emperor, and devoted to his interest, endeavoured to assume the impartiality which became the common father of Christendom, and laboured to reconcile the contending princes, that they might unite in a league against Solyman, whose conquest of Rhodes rendered him more formidable than ever to Europe. The Italian states were no less desirous of peace than the pope: and so much regard was paid by the hostile powers to the exhortations of his holiness, and to a bull which he issued, requiring all Christian princes to consent to a truce for three years, that the imperial, the French, and the English ambassadors at Rome, were empowered to treat of that matter; but while they wasted their time in fruitless negotiations, their matters were continuing their preparations for war; and other negotiations soon took place. The confederacy against France became more formidable than ever.

The Venetians, who had hitherto adhered to the French interest, formed engagements with the emperor for securing Francis Sforza in the possession of the duchy of Milan; and the pope, from a persuasion that the ambition of the French monarch was the only obstacle to peace, acceded to the same alliance. The Florentines, the dukes of Ferrara and Mantua, and all the Italian powers, followed this example. Francis was left without a single ally, to resist the efforts of a multitude of enemies, whose armies everywhere threatened, and whose territories encompassed his dominions. The emperor in person menaced France with an invasion on the side of Guienne; the forces of England and the Netherlands hovered over Picardy, and a numerous body of Germans was preparing to ravage Burgundy.

The dread of so many and such powerful adversaries, it was thought, would have obliged Francis to keep wholly on the defensive, or at least have prevented him from entertaining any thoughts of marching into Italy. But before his enemies were able to strike a blow, Francis had assembled a great army, with which he hoped to disconcert all the emperor's schemes, by marching it in person into Italy: and this bold measure, the more formidable because unexpected, could scarcely have failed of the desired effect, had it been immediately carried into execution. But the discovery of a domestic conspiracy, which threatened the destruction of his kingdom, obliged Francis to stop short at Lyons.

Charles duke of Bourbon, lord high constable of France, was a prince of the most shining merit: his great talents equally fitted him for the council or the field, while his eminent services to the crown intitled him to its first favour. But unhappily Louisa duchess of Angouleme, the king's mother, had contracted a violent aversion against the house of Bourbon, and had taught her son, over whom she had acquired an absolute ascendant, to view all the constable's actions with a jealous eye. After repeated affronts he retired from court,

Spain. and began to listen to the advances of the emperor's ministers. Meantime the dukes of Bourbon died; and as the constable was no less amiable than accomplished, the dukes of Angouleme, still susceptible of the tender passions, formed the scheme of marrying him. But Bourbon, who might have expected every thing to which an ambitious mind can aspire, from the doating fondness of a woman who governed her son and the kingdom, incapable of imitating Louisa in her sudden transition from hate to love, or of meanly counterfeiting a passion for one who had so long pursued him with unprovoked malice, rejected the match with disdain, and turned the proposal into ridicule. At once despised and insulted by the man whom love only could have made her cease to persecute, Louisa was filled with all the rage of disappointed woman; she resolved to ruin, since she could not marry, Bourbon. For this purpose she commenced an iniquitous suit against him; and by the chicanery of chancellor du Prat, the constable was stripped of his whole family-estate. Driven to despair by so many injuries, he entered into a secret correspondence with the emperor and the king of England; and he proposed, as soon as Francis should have crossed the Alps, to raise an insurrection among his numerous vassals, and introduce foreign enemies into the heart of France.

Happily Francis got intimation of this conspiracy before he left the kingdom; but not being sufficiently convinced of the Constable's guilt, he suffered so dangerous a foe to escape; and Bourbon entering into the emperor's service, employed all the force of his enterprising genius, and his great talents for war, to the prejudice of his prince and his native country.

In consequence of the discovery of this plot, and the escape of the powerful conspirator, Francis relinquished his intention of leading his army in person into Italy. He was ignorant how far the infection had spread among his subjects, and afraid that his absence might encourage them to make some desperate attempt in favour of a man so much beloved. He did not, however, abandon his design on the Milanese, but sent forward an army of 30,000 men, under the command of admiral Bonnivet. Colonna, who was entrusted with the defence of that duchy, was in no condition to resist such a force; and the city of Milan, on which the whole territory depends, must have fallen into the hands of the French, had not Bonnivet, who possessed none of the talents of a general, wasted his time in frivolous enterprises, till the inhabitants recovered from their consternation. The imperial army was reinforced. Colonna died; and Lannoy, viceroy of Naples, succeeded him in the command; but the chief direction of military operations was committed to Bourbon and the marquis de Pescara, the greatest generals of their age. Bonnivet, destitute of troops to oppose this new army, and still more of the talents which could render him a match for its leaders, after various movements and encounters, was reduced to the necessity of attempting a retreat into France. He was followed by the imperial generals, and routed at Biagrasa, where the famous chevalier Bayard was killed.

The emperor and his allies were less successful in their attempts upon France. They were baffled in every quarter: and Francis, though stripped of his Italian dominions, might still have enjoyed in safety

the glory of having defended his native kingdom against one half of Europe, and have bid defiance to all his enemies; but understanding that the king of England, discouraged by his former fruitless enterprises, and disgusted with the emperor, was making no preparations for any attempt on Picardy, his ancient ardour seized him for the conquest of Milan, and he determined, notwithstanding the advanced season, to march into Italy.

The French army no sooner appeared in Piedmont, than the whole Milanese was thrown into consternation. The capital opened its gates. The forces of the emperor and Sforza retired to Lodi; and had Francis been so fortunate as to pursue them, they must have abandoned that post, and been totally dispersed; but his evil genius led him to besiege Pavia, a town of considerable strength, well garrisoned, and defended by Antonio de Leyva, one of the bravest officers in the Spanish service; before which place he was defeated and taken prisoner on the twenty-fourth day of February 1524.

The captivity of Francis filled all Europe with alarm. Almost the whole French army was cut off; Milan was immediately abandoned; and in a few weeks not a Frenchman was left in Italy. The power of the emperor, and still more his ambition, became an object of universal terror; and resolutions were everywhere taken to set bounds to it. Meanwhile Francis, deeply impressed with a sense of his misfortune, wrote to his mother Louisa, whom he had left regent of the kingdom, the following short but expressive letter: "All, Madam, is lost but honour." The same courier that carried this letter, carried also dispatches to Charles; who received the news of the signal and unexpected success which had crowned his arms with the most hypocritical moderation. He would not suffer any public rejoicings to be made on account of it; and said, he only valued it, as it would prove the occasion of restoring peace to Christendom. Louisa, however, did not trust to those appearances; if she could not preserve what was yet left, she determined at least that nothing should be lost through her negligence or weakness. Instead of giving herself up to such lamentations as were natural to a woman so remarkable for maternal tendernefs, she discovered all the foresight, and exerted all the activity, of a consummate politician. She took every possible measure for putting the kingdom in a posture of defence, while she employed all her address to appease the resentment and to gain the friendship of England; and a ray of comfort from that quarter soon broke in upon the French affairs.

Though Henry VIII. had not entered into the war against France from any concerted political views, he had always retained some imperfect idea of that balance of power which it was necessary to maintain between Charles and Francis; and the preservation of which he boasted to be his peculiar office. By his alliance with the emperor, he hoped to recover some part of those territories on the continent which had belonged to his ancestors; and therefore willingly contributed to give him the ascendancy above his rival; but having never dreamt of any event so decisive and fatal as the victory at Pavia, which seemed not only to have broken, but to have annihilated the power of Francis, he now became sensible of his own danger, as well as that of all Europe, from the loss of a proper counterpoise to the power of

Spain  
85 Francis determines to enter Italy in person.

86 Is defeated and taken prisoner at Pavia.

87 Hypocritical conduct of Charles.

83 French army enters Italy.

84 Defeated at Biagrasa.

Spain. Charles. Instead of taking advantage of the distressed condition of France, Henry therefore determined to assist her in her present calamities. Some distrusts also had taken place between him and Charles, and still more between Charles and Wolfey. The elevation of the cardinal of Medici to St Peter's chair, on the death of Adrian, under the name of Clement VII. had made the English minister sensible of the insincerity of the emperor's promises, while it extinguished all his hopes of the papacy; and he resolved on revenge. Charles, too, had so ill supported the appearance of moderation which he assumed, when first informed of his good fortune, that he had already changed his usual style to Henry; and instead of writing to him with his own hand, and subscribing himself "your affectionate son and cousin," he dictated his letters to a secretary, and simply subscribed himself "Charles." Influenced by all these motives, together with the glory of raising a fallen enemy, Henry listened to the flattering submissions of Louisa; entered into a defensive alliance with her as regent of France, and engaged to use his best offices in order to procure the deliverance of her son from a state of captivity.

89  
Francis severely used by his conqueror.

Meanwhile Francis was rigorously confined; and severe conditions being proposed to him as the price of his liberty, he drew his dagger, and, pointing it at his breast, cried, "Twere better that a king should die thus!" His hand was with-held: and flattering himself, when he grew cool, that such propositions could not come directly from Charles, he desired that he might be removed to Spain, where the emperor then resided. His request was complied with; but he languished long before he obtained a sight of his conqueror. At last he was favoured with a visit; and the emperor dreading a general combination against him, or that Francis, as he threatened, might, in the obstinacy of his heart, resign his crown to the dauphin, agreed to abate somewhat of his former demands. A treaty was accordingly concluded at Madrid; in consequence of which Francis obtained his liberty. The chief article in this treaty was, that Burgundy should be restored to Charles as the rightful inheritance of his ancestors, and that Francis's two eldest sons should be immediately delivered up as hostages for the performance of the conditions stipulated. The exchange of the captive monarch for his children was made on the borders between France and Spain. The moment that Francis entered his own dominions, he mounted a Turkish horse, and putting it to its speed, waved his hand, and cried aloud several times, "I am yet a king! I am yet a king!"

90  
is at last released.

91  
Refuses to execute the conditions of his release.

Francis never meant to execute the treaty of Madrid: he had even left a protest in the hands of notaries before he signed it, that his consent should be considered as an involuntary deed, and be deemed null and void. Accordingly, as soon as he arrived in France, he assembled the states of Burgundy, who protested against the article relative to their province; and Francis coldly replied to the imperial ambassadors, who urged the immediate execution of the treaty, that he would religiously perform the articles relative to himself, but in those affecting the French monarchy, he must be directed by the sense of the nation. He made the highest acknowledgments to the king of England for his friendly interposition, and offered to be entirely guided by his counsels. Charles and his ministers saw

Spain. that they were over-reached in those very arts of negotiation in which they so much excelled, while the Italian states observed with pleasure, that Francis was resolved not to execute a treaty which they considered as dangerous to the liberties of Europe. Clement absolved him from the oath which he had taken at Madrid; and the kings of France and England, the Pope, the Swiss, the Venetians, the Florentines, and the duke of Milan, entered into an alliance, to which they gave the name of the *Holy League*, because his Holiness was at the head of it, in order to oblige the emperor to deliver up Francis's two sons on the payment of a reasonable ransom, and to re-establish Sforza in the quiet possession of the Milanese.

In consequence of this league, the confederate army took the field, and Italy once more became the scene of war. But Francis, who it was thought would have infused spirit and vigour into the whole body, had gone through such a scene of distress, that he was become diffident of himself, distrustful of his fortune, and desirous of tranquillity. He flattered himself, that the dread alone of such a confederacy would induce Charles to listen to what was equitable, and therefore neglected to send due reinforcements to his allies in Italy. Meantime the duke of Bourbon, who commanded the Imperialists, had made himself master of the whole Milanese, of which the emperor had promised him the investiture; and his troops beginning to mutiny for want of pay, he led them to Rome, and promised to enrich them with the spoils of that city. He was as good as his word; for though he himself was slain in planting a scaling ladder against the walls, his soldiers, rather engaged than discouraged by his death, mounted to the assault with the utmost ardour, animated by the greatness of the prize, and, entering the city sword in hand, plundered it for several days.

92  
Rome taken by the imperialists.

Never did Rome in any age suffer so many calamities, not even from the Barbarians, by whom she was often subdued, the Huns, Vandals, or Goths, as now from the subjects of a Christian and Catholic monarch. Whatever was respectable in modesty, or sacred in religion, seemed only the more to provoke the rage of the soldiery. Virgins suffered violation in the arms of their parents, and upon those altars to which they had fled for safety. Venerable prelates, after enduring every indignity and every torture, were thrown into dungeons, and menaced with the most cruel death, in order to make them reveal their secret treasures. Clement himself, who had neglected to make his escape in time, was taken prisoner, and found that the sacredness of his character could neither procure him liberty nor respect. He was confined till he should pay an enormous ransom imposed by the victorious army, and surrender to the emperor all the places of strength belonging to the church.

93  
And most cruelly plundered.

94  
The Pope confined.

Charles received the news of this extraordinary event with equal surprize and pleasure; but in order to conceal his joy from his Spanish subjects, who were filled with horror at the insult offered to the sovereign pontiff, and to lessen the indignation of the rest of Europe, he expressed the most profound sorrow for the success of his arms. He put himself and his court into mourning; stopped the rejoicings for the birth of his son Philip, and ordered prayers to be put up in all the churches of Spain for the recovery of the pope's liberty, which

95  
Shameful hypocrisy Charles.



which he could immediately have procured by a letter to his generals.

The concern expressed by Henry and Francis for the calamity of their ally was more sincere. Alarmed at the progress of the imperial arms, they had, even before the taking of Rome, entered into a closer alliance, and agreed to invade the Low Countries with a powerful army; but no sooner did they hear of the Pope's captivity, than they changed, by a new treaty, the scene of the projected war from the Netherlands to Italy, and resolved to take the most vigorous measures for restoring him to liberty. Henry, however, contributed only money. A French army entered Italy, under the command of Marshal Lautrec; Clement obtained his freedom; and war was for a time carried on by the confederates with success; but the death of Lautrec, and the revolt of Andrew Doris, a Genoese admiral in the service of France, entirely changed the face of affairs. The French army was utterly ruined; and Francis, discouraged and almost exhausted by many unsuccessful enterprises, began to think of peace, and of obtaining the release of his sons by concessions, not by the terror of his arms.

At the same time Charles, notwithstanding the advantages he had gained, had many reasons to wish for an accommodation. Sultan Solymán having over-run Hungary, was ready to break in upon the Austrian territories with the whole force of the East; and the progress of the Reformation in Germany threatened the tranquillity of the empire. In consequence of this situation of affairs, though pride made both parties conceal or dissemble their real sentiments, two ladies were permitted to restore peace to Europe. Margaret of Austria, Charles's aunt, and Louisa, Francis's mother, met in 1529 at Cambray, and settled the terms of accommodation between the French king and the emperor. Francis agreed to pay two millions of crowns as the ransom of his two sons, to resign the sovereignty of Flanders and Artois, and to forego all his Italian claims; and Charles ceased to demand the restitution of Burgundy.

All the steps of this negotiation had been communicated to the king of England; and Henry was, on that occasion, so generous to his friend and ally Francis, that he sent him an acquittal of near six hundred thousand crowns, in order to enable him to fulfil his agreement with Charles. But Francis's Italian confederates were less satisfied with the treaty of Cambray. They were almost wholly abandoned to the will of the emperor; and seemed to have no other means of security left but his equity and moderation. Of these, from his past conduct, they had not formed the most advantageous idea. But Charles's present circumstances, more especially in regard to the Turks, obliged him to behave with a generosity inconsistent with his character. The Florentines alone, whom he reduced under the dominion of the family of Medici, had reason to complain of his severity. Sforza obtained the investiture of Milan and his pardon; and every other power experienced the lenity of the conqueror.

After having received the imperial crown from the hands of the Pope at Bologna, Charles proceeded on his journey to Germany, where his presence was become highly necessary; for although the conduct and valour of his brother Ferdinand, on whom he had conferred

the hereditary dominions of the house of Austria, and who had been elected king of Hungary, had obliged Solymán to retire with infamy and loss, his return was to be feared, and the disorders of religion were daily increasing; an account of which, and of the emperor's transactions with the Protestants, is given under the article REFORMATION.

Charles having exerted himself as much as he could against the reformers, undertook his first expedition against the piratical states of Africa. Barbary, or that part of the African continent lying along the coast of the Mediterranean sea, was then nearly in the same condition which it is at present. Morocco, Algiers, and Tunis, were its principal states; and the two last were nests of pirates. Barbarossa, a famous Corsair, had succeeded his brother in the kingdom of Algiers, which he had formerly assisted him to usurp. He regulated with much prudence the interior police of his kingdom, carried on his piracies with great vigour, and extended his conquests on the continent of Africa; but perceiving that the natives submitted to his government with impatience, and fearing that his continual depredations would one day draw upon him a general combination of the Christian powers, he put his dominions under the protection of the grand seignior. Solymán, flattered by such an act of submission, and charmed with the boldness of the man, offered him the command of the Turkish fleet. Proud of this distinction, Barbarossa repaired to Constantinople, and made use of his influence with the sultan to extend his own dominion. Partly by force, partly by treachery, he usurped the kingdom of Tunis; and being now possessed of greater power, he carried on his depredations against the Christian states with more destructive violence than ever.

Daily complaints of the piracies and ravages committed by the galleys of Barbarossa were brought to the emperor by his subjects, both in Spain and Italy; and all Christendom seemed to look up to him, as its greatest and most fortunate prince, for relief from this new and odious species of oppression. At the same time Muley-Hascen, the exiled king of Tunis, finding none of the African princes able or willing to support him in recovering his throne, applied to Charles for assistance against the usurper. Equally desirous of delivering his dominions from the dangerous neighbourhood of Barbarossa, of appearing as the protector of an unfortunate prince, and of acquiring the glory annexed in that age to every expedition against the Mahometans, the emperor readily concluded a treaty with Muley Hascen, and set sail for Tunis with a formidable armament. The Goletta, a sea port town, fortified with 300 pieces of cannon, was taken, together with all Barbarossa's fleet: he was defeated in a pitched battle, and 10,000 Christian slaves, having knocked off their fetters, and made themselves masters of the citadel, Tunis was preparing to surrender. But while Charles was deliberating on the conditions, his troops fearing that they would be deprived of the booty which they had expected, broke suddenly into the town, and pillaged and massacred without distinction. Thirty thousand persons perished by the sword, and 10,000 were made prisoners. The sceptre was restored to Muley Hascen, on condition that he should acknowledge himself a vassal of the crown of Spain, put into the emperor's hands all the fortified sea-ports in the kingdom of Tunis, and

Spain.

99  
He undertakes an expedition against the state of Barbary.

103  
Tunis taken and the inhabitants cruelly massacred.

<sup>Spain.</sup> pay annually 12,000 crowns for the subsistence of the Spanish garrison in the Goletta. These points being settled, and 2,000 Christian slaves freed from bondage either by arms or by treaty, Charles returned to Europe, where his presence was become necessary; while Barbarossa, who had retired to Bona, recovered new strength, and again became the tyrant of the ocean.

<sup>101</sup> Francis attempts in vain to revive his pretensions to Italy. The king of France took advantage of the emperor's absence to revive his pretensions in Italy. The treaty of Cambrai had covered up but not extinguished the flames of discord. Francis in particular, who waited only for a favourable opportunity of recovering the territories and reputation which he had lost, continued to negotiate against his rival with different courts. But all his negotiations were disconcerted by unforeseen accidents. The death of Clement VII. (whom he had gained by marrying his son the duke of Orleans, afterwards Henry II. to Catharine of Medici, the niece of that pontiff), deprived him of all the support which he hoped to receive from the court of Rome. The king of England, occupied with domestic cares and projects, declined engaging in the affairs of the continent; and the Protestant princes, associated by the league of Smalkalde, to whom Francis had also applied, and who seemed disposed at first to listen to him, filled with indignation and resentment at the cruelty with which some of their reformed brethren had been treated in France, refused to have any connection with the enemy of their religion.

<sup>102</sup> His barbarity to the Protestants. Francis was neither cruel nor bigotted: he was too indolent to concern himself about religious disputes; but his principles becoming suspected, at a time when the emperor was gaining immortal glory by his expedition against the Infidels, he found it necessary to vindicate himself by some extraordinary demonstration of reverence for the established faith. The indifereet zeal of some Protestant converts furnished him with the occasion. They had affixed to the gates of the Louvre and other public places papers containing indecent reflections on the rites of the Romish church. Six of the persons concerned in this rash action were seized; and the king, pretending to be struck with horror at their blasphemies, appointed a solemn procession, in order to avert the wrath of heaven. The holy sacrament was carried through the city of Paris in great pomp: Francis walked uncovered before it, bearing a torch in his hand; the princes of the Blood supported the canopy over it; the nobles walked behind. In presence of this numerous assembly, the king declared, that if one of his hands were infected with heresy, he would cut it off with the other; "and I would sacrifice (added he) even my own children, if found guilty of that crime." As an awful proof of his sincerity, the six unhappy persons who had been seized were publicly burnt, before the procession was finished, and in the most cruel manner. They were fixed upon a machine which descended into the flames, and retired alternately, until they expired.—No wonder that the Protestant princes were incensed at such barbarity!

<sup>103</sup> Causes an army march towards Italy. But Francis, though unsupported by any ally, commanded his army to advance towards the frontiers of Italy, under pretence of chastising the duke of Milan for a breach of the law of nations, in putting to death his ambassador. The operations of war, however, soon took a new direction. Instead of marching directly to

the Milanese, Francis commenced hostilities against the duke of Savoy, with whom he had cause to be dissatisfied, and on whom he had some claims; and before the end of the campaign, that feeble prince saw himself stripped of all his dominions, except the province of Piedmont. To complete his misfortunes, the city of Geneva, the sovereignty of which he claimed, and where the reformed opinions had already got footing, threw off his yoke; and its revolt drew along with it the loss of the adjacent territory. Geneva was then an imperial city, and has ever since remained entirely free.

In this extremity the duke of Savoy saw no resource but in the emperor's protection; and as his misfortunes were chiefly occasioned by his attachment to the imperial interest, he had a title to immediate assistance. But Charles, who was just returned from his African expedition, was not able to lend him the necessary support. His treasury was entirely drained, and he was obliged to disband his army till he could raise new supplies. Mean time the death of Sforza duke of Milan entirely changed the nature of the war, and afforded the emperor full leisure to prepare for action. The French monarch's pretext for taking up arms was at once cut off; but as the duke died without issue, all Francis's rights to the duchy of Milan, which he had yielded only to Sforza and his descendants, returned to him in full force. He instantly renewed his claim to it; and if he had ordered his army immediately to advance, he might have made himself master of it. But he unfortunately wasted his time in fruitless negotiations, while his more politic rival took possession of the duchy as a vacant part of the empire; and though Charles seemed still to admit the equity of Francis's claim, he delayed granting the investiture under various pretences, and was secretly taking every possible measure to prevent him from regaining footing in Italy.

During the time gained in this manner Charles had recruited his finances, and of course his armies; and finding himself in a condition for war, he at last threw off the mask under which he had so long concealed his designs from the court of France. Entering Rome with great pomp, he pronounced before the pope and cardinals, assembled in full consistory, a violent invective against Francis, by way of reply to his propositions concerning the investiture of Milan. Yet Francis, by an unaccountable fatality, continued to negotiate, as if it had been still possible to terminate their differences in an amicable manner; and Charles, finding him so eager to run into the snare, favoured the deception, and, by seeming to listen to his proposals, gained yet more time for the execution of his ambitious projects.

His misfortunes had rendered Francis too dissident, success had made Charles too sanguine. He presumed on nothing less than the subversion of the French monarchy; nay, he considered it as an intallible event. Having chased the forces of his rival out of Piedmont and Savoy, he pushed forward at the head of 50,000 men, contrary to the advice of his most experienced ministers and generals, to invade the southern provinces of France; while other two armies were ordered to enter it, the one on the side of Picardy, the other on the side of Champagne. He thought it impossible that Francis could resist so many unexpected attacks on such different quarters; but he found himself mistaken.

The French monarch fixed upon the most effectual plan

Spain. plan for defeating the invasion of a powerful enemy ; and he prudently persevered in following it, though contrary to his own natural temper and to the genius of his people. He determined to remain altogether upon the defensive, and to deprive the enemy of subsistence by laying waste the country before them. The execution of this plan was committed to the marshal Montmorency its author, a man happily fitted for such a trust by the inflexible severity of his disposition. He made choice of a strong camp, under the walls of Avignon, at the confluence of the Rhone and Durance, where he assembled a considerable army ; while the king, with another body of troops, encamped at Valence, higher up the Rhone. Marseilles and Arles were the only towns he thought it necessary to defend ; and each of these he furnished with a numerous garrison of his best troops. The inhabitants of the other towns were compelled to abandon their habitations : the fortifications of such places as might have afforded shelter to the enemy were thrown down ; corn, forage, and provisions of every kind, were carried off or destroyed ; the mills and ovens were ruined, and the wells filled up or rendered useless.

This devastation extended from the Alps to Marseilles, and from the sea to the confines of Dauphiny ; so that the emperor, when he arrived with the van of his army on the confines of Provence, instead of that rich and populous country which he expected to enter, beheld nothing but one vast and desert solitude. He did not, however, despair of success, though he saw that he would have many difficulties to encounter ; and as an encouragement to his officers, he made them liberal promises of lands and honours in France. But all the land which any of them obtained was a grave, and their master lost much honour by this rash and presumptuous enterprize. After unsuccessfully invading Marseilles and Arles, after attempting in vain to draw Montmorency from his camp at Avignon, and not daring to attack it, Charles having spent two inglorious months in Provence, and lost one half of his troops by disease or by famine, was under the necessity of ordering a retreat ; and though he was some time in motion before the enemy suspected his intention, it was conducted with so much precipitation and disorder, as to deserve the name of a flight, since the light troops of France turned it into a perfect rout. The invasion of Picardy was not more successful : the imperial forces were obliged to retire without effecting any conquest of importance.

Charles had no sooner conducted the shattered remains of his army to the frontiers of Milan, than he set out for Genoa ; and unwilling to expose himself to the scorn of the Italians after such a reverse of fortune, he embarked directly for Spain.

109  
Violent animosity between him and Francis.  
Meanwhile Francis gave himself up to that vain resentment which had formerly disgraced the prosperity of his rival. They had frequently, in the course of their quarrels, given each other the lie, and mutual challenges had been sent ; which, though productive of no serious consequences between the parties, had a powerful tendency to encourage the pernicious practice of duelling. Charles, in his invective pronounced at Rome, had publicly accused Francis of perfidy and breach of faith ; Francis now exceeded Charles in the irreverency of his accusations. The Dauphin dying suddenly, his death

was imputed to poison : Montecuculi his cup-bearer was put to the rack ; and that unhappy nobleman, in the agonies of torture, accused the emperor's generals Gonzaga and de Leyva, of infligating him to the detestable act. The emperor himself was suspected ; nay, this extorted confession, and some obscure hints, were considered as incontrovertible proofs of his guilt ; though it was evident to all mankind, that neither Charles nor his generals could have any inducement to perpetrate such a crime, as Francis was still in the vigour of life himself, and had two sons besides the dauphin, grown up to a good age.

But the incensed monarch's resentment did not stop here. Francis was not satisfied with endeavouring to blacken the character of his rival by an ambiguous testimony which led to the most injurious suspicions, and upon which the most cruel constructions had been put ; he was willing to add rebellion to murder. For this purpose he went to the parliament of Paris ; where being seated with the usual solemnities, the advocate-general appeared, and accused Charles of Austria (so he affected to call the emperor) of having violated the treaty of Cambray, by which he was freed from the homage due to the crown of France for the counties of Artois and Flanders ; adding, that this treaty being now void, he was still to be considered as a vassal of France, and consequently had been guilty of rebellion in taking arms against his sovereign. The charge was sustained, and Charles was summoned to appear before the parliament of Paris at a day fixed. The term expired ; and no person appearing in the emperor's name, the parliament gave judgment, that Charles of Austria had forfeited, by rebellion and contumacy, the counties of Flanders and Artois, and declared these fiefs reunited to the crown of France.

Francis, soon after this vain display of his animosity, marched into the Low Countries, as if he had intended to execute the sentence pronounced by his parliament ; but a suspension of arms took place, through the interposition of the queens of France and Hungary, before any thing of consequence was effected ; and this cessation of hostilities was followed by a truce, concluded at Nice, through the mediation of the reigning pontiff Paul III. of the family of France, a man of a venerable character and pacific disposition.

Each of these rival princes had strong reasons to incline them to peace. The finances of both were exhausted ; and the emperor, the most powerful of the two, was deeply impressed with the dread of the Turkish arms, which Francis had drawn upon him by a league with Solyman. In consequence of this league, Barbarossa with a great fleet appeared on the coast of Naples ; filled that kingdom with consternation ; landed without resistance near Taranto ; obliged Castro, a place of some strength, to surrender ; plundered the adjacent country ; and was taking measures for securing and extending his conquests, when the unexpected arrival of Donia, the famous Genoese admiral, together with the pope's galleys and a squadron of the Venetian fleet, made it prudent for him to retire. The Sultan's forces also invaded Hungary, where Mahmet the Turkish general, after gaining several inferior advantages, defeated the Germans in a great battle at Etek on the Drave. Happily for Charles and Europe it was not in Francis's power at this juncture either to join the Turks or as-  
semble

Spain.

110  
Charles summoned to appear at Paris.111  
Francis alarmed with the Turks.

<sup>Spain.</sup> sensible an army strong enough to penetrate into the Milanese. The emperor, however, was sensible that he could not long resist the efforts of two such powerful confederates, nor expect that the same fortunate circumstances would concur a second time in his favour; he therefore thought it necessary, both for his safety and reputation, to give his consent to a truce: and Francis chose rather to run the risk of disobliging his new ally the sultan, than to draw on his head the indignation, and perhaps the arms, of all Christendom, by obstinately obstructing the re-establishment of tranquillity, and contributing to the aggrandizement of the Infidels.

<sup>112</sup>  
A truce concluded.

These considerations inclined the contending monarchs to listen to the arguments of the holy father; but he found it impossible to bring about a final accommodation between them, each inflexibly persisting in asserting his own claims. Nor could he prevail on them to see one another, though both came to the place of rendezvous: so great was the remains of distrust and rancour, or such the difficulty of adjusting the ceremonial! Yet, improbable as it may seem, a few days after signing the truce, the emperor, in his passage to Barcelona, being driven on the coast of Provence, Francis invited him to come ashore; frankly visited him on board his galley, and was received and entertained with the warmest demonstrations of esteem and affection. Charles, with an equal degree of confidence, paid the king next day a visit at Aigues-mortes; where these two hostile rivals and vindictive enemies, who had accused each other of every kind of baseness, conversing together with all the cordiality of brothers, seemed to vie with each other in expressions of respect and friendship.

<sup>113</sup>  
Interview between Francis and Charles.

Besides the glory of having restored tranquillity to Europe, the pope gained a point of much consequence to his family. He obtained for his grandson, Margaret of Austria, the emperor's natural daughter, formerly wife of Alexander de Medici, whom Charles had raised to the supreme power in Florence. Lorenzo de Medici, the kinsman and intimate companion of Alexander, had assassinated him by one of the blackest treasons recorded in history. Under pretence of having secured him an assignation with a lady of the highest rank and great beauty, he drew him into a secret apartment of his house, and there stabbed him as he lay carelessly on a couch, expecting the embrace of the lovely fair, whom he had often solicited in vain. Lorenzo, however, did not reap the fruits of his crime; for though some of his countrymen extolled him as a third Brutus, and endeavoured to seize this occasion for recovering their liberties, the government of Florence passed into the hands of Cosmo II. another kinsman of Alexander. Cosmo was desirous of marrying the widow of his predecessor; but the emperor chose rather to oblige the pope, by bestowing his daughter upon Octavio Farneze, son of the duke of Parma.

<sup>114</sup>  
Advantage gained by the pope from this pacification.

<sup>115</sup>  
Charles distressed.

Charles had soon farther cause to be sensible of his obligations to the holy father for bringing about the treaty of Nice. His troops everywhere mutinied for want of pay, and the ability of his generals only could have prevented a total revolt. He had depended, as his chief resource for discharging the arrears due to his soldiers, upon the subsidies which he expected from his Italian subjects. For this purpose he assembled the

Cortes of Castile at Toledo; and having represented to them the great expence of his military operations, he proposed to levy such supplies as the present exigency of affairs demanded, by a general excise on commodities; but the Spaniards, who already felt themselves oppressed by a load of taxes unknown to their ancestors, and who had often complained that their country was drained of its wealth and inhabitants, in order to prosecute quarrels in which they had no interest, determined not to add voluntarily to their own burdens. The nobles, in particular, inveighed with great vehemence against the imposition proposed, as an encroachment on the valuable and distinguishing privilege of their order, that of being exempted from the payment of any tax. After employing arguments and promises in vain, Charles dismissed the assembly with indignation; and from that period neither the nobles nor the prelates have been called to the Cortes, on pretence that such as pay no part of the public taxes should not claim a vote in laying them on. These assemblies have since consisted merely of the procurators or representatives of 18 cities, two from each; in all 36 members, who are absolutely at the devotion of the crown.

<sup>Spain.</sup>  
<sup>116</sup>  
The Spaniards refuse to assist him with money.

The citizens of Ghent, still more bold, broke out not long after into open rebellion against the emperor's government, on account of a tax which they judged contrary to their ancient privileges, and a decision of the council of Mechlin in favour of the imperial authority. Enraged at an unjust imposition, and rendered desperate on seeing their rights betrayed by that very court which was bound to protect them, they flew to arms, seized several of the emperor's officers, and drove such of the nobility as resided among them out of the city. Sensible, however, of their inability to support what their zeal had prompted them to undertake, and desirous of securing a protector against the formidable forces with which they might expect soon to be attacked, they offered to acknowledge the king of France as their sovereign, to put him into immediate possession of their city, and to assist him in recovering those provinces in the Netherlands which had anciently belonged to his crown. True policy directed Francis to comply with this proposal. The counties of Flanders and Artois were more valuable than the duchy of Milan, for which he had so long contended; and their situation in regard to France made it more easy to conquer or to defend them. But Francis over-rated the Milanese. He had lived in friendship with the emperor ever since their interview at Aigues-mortes, and Charles had promised him the investiture of that duchy. Forgetting, therefore, all his past injuries, and the deceitful promises by which he had been so often duped, the credulous, generous Francis, not only rejected the propositions of the citizens of Ghent, but communicated to the emperor his whole negotiation with the malecontents.

<sup>118</sup>  
Extreme credulity of Francis.

Judging of Charles's heart by his own, Francis hoped by this seemingly disinterested proceeding to obtain at once the investiture of Milan; and the emperor, well acquainted with the weakness of his rival, flattered him in this apprehension, for his own selfish purposes. His presence being necessary in the Netherlands, he demanded a passage through France. It was immediately granted him; and Charles, to whom every moment was precious, let out, notwithstanding the remonstrances of his council and the fears of his Spanish subjects, with a small

<sup>119</sup>  
He allows Charles to pass thro' his dominions.

Spain. small but splendid train of 100 persons. He was met on the frontiers of France by the dauphin and the duke of Orleans, who offered to go into Spain, and remain there as hostages, till he should reach his own dominions; but Charles replied, that the king's honour was sufficient for his safety, and prosecuted his journey without any other security. The king entertained him with the utmost magnificence at Paris, and the two young princes did not take leave of him till he entered the Low Countries; yet he still found means to evade his promise, and Francis continued to believe him sincere.

120  
every-ty of  
Charles- to  
the city of  
Ghent.

The citizens of Ghent, alarmed at the approach of the emperor, who was joined by three armies, sent ambassadors to implore his mercy, and offered to throw open their gates. Charles only condescended to reply, "That he would appear among them as a sovereign and a judge, with the sceptre and the sword." He accordingly entered the place of his nativity on the anniversary of his birth; and instead of that lenity which might have been expected, exhibited an awful example of his severity. Twenty-six of the principal citizens were put to death; a greater number were banished; the city was declared to have forfeited its privileges; a new system of laws and political administration was prescribed; and a large fine was imposed on the inhabitants, in order to defray the expence of erecting a citadel, together with an annual tax for the support of a garrison. They were not only despoiled of their ancient immunities, but made to pay, like conquered people, for the means of perpetuating their own slavery.

121  
his base  
treatment  
Francis.

Having thus re-established his authority in the Low Countries, and being now under no necessity of continuing that scene of falsehood and dissimulation with which he had amused the French monarch, Charles began gradually to throw aside the veil under which he had concealed his intentions with respect to the Milanese, and at last peremptorily refused to give up a territory of such value, or voluntarily to make such a liberal addition to the strength of an enemy by diminishing his own power. He even denied that he had ever made any promise which could bind him to an action so foolish, and so contrary to his own interest.

This transaction exposed the king of France to as much scorn as it did the emperor to censure. The credulous simplicity of Francis seemed to merit no other return, after experiencing so often the duplicity and artifices of his rival. He remonstrated, however, and exclaimed as if this had been the first circumstance in which the emperor had deceived him. The insult offered to his understanding affected him even more sensibly than the injury done to his interest; and he discovered such resentment as made it obvious that he would seize on the first opportunity of revenge, and that a new war would soon desolate the European continent.

122  
is obli-  
ed to make  
concessions  
the Pro-  
stants.

Meanwhile Charles was obliged to turn his attention towards the affairs of Germany. The Protestants having in vain demanded a general council, pressed him earnestly to appoint a conference between a select number of divines of each party, in order to examine the points in dispute. For this purpose a diet was assembled at Ratisbon: and such a conference, notwithstanding the opposition of the pope, was held with great solemnity in the presence of the emperor. But the divines chosen to manage the controversy, though men of

Spain.

learning and moderation, were only able to settle a few speculative opinions, all points relative to worship and jurisdiction serving to inflame the minds of the disputants. Charles, therefore, finding his endeavours to bring about an accommodation ineffectual, and being impatient to close the diet, prevailed on a majority of the members to approve of the following edict of recess; viz. that the articles concerning which the divines had agreed, should be held as points decided; that those about which they had differed, should be referred to the determination of a general council, or if that could not be obtained, to a national synod; and should it prove impracticable also to assemble a synod of Germany, that a general diet of the empire should be called within 18 months, in order to give final judgment on the whole controversy; that, in the mean time, no innovations should be attempted, nor any endeavours employed to gain proselytes.

This diet gave great offence to the pope. The bare mention of allowing a diet, composed chiefly of laymen, to pass judgment in regard to articles of faith, appeared to him no less criminal and profane than the work of those heresies which the emperor seemed so zealous to suppress. The Protestants also were dissatisfied with it, as it considerably abridged the liberty which they at that time enjoyed. They murmured loudly against it; and Charles, unwilling to leave any seeds of discontent in the empire, granted them a private declaration, exempting them from whatever they thought injurious or oppressive in the recess, and ascertaining to them the full possession of all their former privileges.

The situation of the emperor's affairs at this juncture made these extraordinary concessions necessary. He foresaw a rupture with France to be unavoidable, and he was alarmed at the rapid progress of the Turks in Hungary. A great revolution had happened in that kingdom. John Zapol Scæpus, by the assistance of Solyman, had wrested from the king of the Romans a considerable part of the country. John died, and left an infant son. Ferdinand attempted to take advantage of the minority, in order to repossess himself of the whole kingdom; but his ambition was disappointed by the activity and address of George Martinuzzi, bishop of Waradin, who shared the regency with the queen. Sensible that he was unable to oppose the king of the Romans in the field, Martinuzzi satisfied himself with holding out the fortified towns, all of which he provided with every thing necessary for defence; and at the same time he sent ambassadors to Solyman, beseeching him to extend towards the son that imperial protection which had so generously maintained the father on his throne. Ferdinand used his utmost endeavours to thwart this negotiation, and even meanly offered to hold the Hungarian crown on the same ignominious condition by which John had held it, that of paying tribute to the Porte. But the sultan saw such advantages from espousing the interest of the young king, that he instantly marched into Hungary; and the Germans, having formed the siege of Buda, were defeated with great slaughter before that city. Solyman, however, instead of becoming the protector of the infant sovereign whom he had relieved, made use of this success to extend his own dominions: he sent the queen and her son into Transylvania, which province he allotted them, and added Hungary to the Ottoman empire.

Happily

Spain.

Happily for the Protestants, Charles received intelligence of this revolution soon after the diet at Ratibon; and by the concessions which he made them, he obtained such liberal supplies, both of men and money, as left him under little anxiety about the security of Germany.

123  
Under takes  
an un suc-  
cessful ex-  
pedition  
against Al-  
giers.

He therefore hastened to join his fleet and army in Italy, in order to carry into execution a great and favourite enterprize which he had concerted against Algiers: though it would certainly have been more consistent with his dignity to have conducted the whole force of the empire against Solyman, the common enemy of Christendom, who was ready to enter his Austrian dominions. But many reasons induced Charles to prefer the African expedition: he wanted strength, or at least money, to combat the Turks in so distant a country as Hungary; and the glory which he had formerly acquired in Barbary led him to hope for the like success, while the cries of his Spanish subjects roused him to take vengeance on their ravagers. But the unfortunate event of this expedition has already been related under the article ALGIERS, n<sup>o</sup> 14—20.

124  
War be-  
tween  
Francis and  
Charles.

The loss which the emperor suffered in this calamitous expedition encouraged the king of France to begin hostilities, on which he had been for some time resolved; and an action dishonourable to civil society furnished him with too good a pretext for taking arms. The marquis del Guasto, governor of the Milanese, having got intelligence of the motions and destination of two ambassadors, Rincon and Fergoso, whom Francis had dispatched, the one to the Ottoman Porte, the other to the republic of Venice; knowing how much his master wished to discover the intentions of the French monarch, and of what consequence it was to retard the execution of his measures, he employed some soldiers belonging to the garrison of Pavia to lie in wait for these ambassadors as they sailed down the Po, who murdered them and most of their attendants, and seized their papers. Francis immediately demanded reparation for this barbarous outrage; and as Charles endeavoured to put him off with an evasive answer, he appealed to all the courts of Europe, setting forth the heinousness of the injury, the iniquity of the emperor in disregarding his just request, and the necessity of vengeance. But Charles, who was a more profound negotiator, defeated in a great measure the effects of these representations: he secured the fidelity of the Protestant princes in Germany, by granting them new concessions; and he engaged the king of England to espouse his cause, under pretence of defending Europe against the Infidels; while Francis was only able to form an alliance with the kings of Denmark and Sweden (who for the first time interested themselves in the quarrels of the more potent monarchs of the south), and to renew his treaty with Solyman, which drew on him the indignation of Christendom.

But the activity of Francis supplied all the defects of his negotiation. Five armies were soon ready to take the field, under different generals, and with different destinations. Nor was Charles wanting in his preparations. He and Henry a second time made an ideal division of the kingdom of France. But as the hostilities which followed terminated in nothing decisive, and were distinguished by no remarkable events, except the battle of Cerifoles (gained by Francis), which secured the empire to the imperialists, and in which Charles lost the emperor's best

troops fell), at last Francis and Charles, mutually tired of harassing each other, concluded at Crespy a treaty of peace, in which the king of England was not mentioned; and from being implacable enemies, became once more, to appearance, cordial friends, and even allies by the ties of blood.

Spain.  
125  
Peace con-  
cluded at  
Crespy.

The chief articles of this treaty were, that all the conquests which either party had made since the truce of Nice should be restored; that the emperor should give in marriage to the duke of Orleans, either his own eldest daughter, with the Low Countries, or the second daughter of his brother Ferdinand, with the investiture of the Milanese; that Francis should renounce all pretensions to the kingdom of Naples, as well as to the sovereignty of Flanders and Artois, and Charles give up his claim to the duchy of Burgundy; and that both should unite in making war against the Turks.

The emperor was chiefly induced to grant conditions so advantageous to France, by a desire of humbling the Protestant princes in Germany. With the papal jurisdiction, he foresaw they would endeavour to throw off the imperial authority; and he determined to make his zeal for the former a pretence for enforcing and extending the latter. However, the death of the duke of Orleans before the consummation of his marriage, disentangled the emperor from the most troublesome stipulation in the treaty of Crespy; and the French monarch, being still engaged in hostilities with England, was unable to obtain any reparation for the loss which he suffered by this unforeseen event. These hostilities, like those between Charles and Francis, terminated in nothing decisive. Equally tired of a struggle attended with no glory or advantage to either, the contending princes concluded, at Campe, near Ardies, a treaty of peace; in which it was stipulated, that France should pay the arrears due by former treaties to England. But these arrears did not exceed one-third of the sums expended by Henry on his military operations; and Francis being in no condition to discharge them, Boulogne (a chargeable pledge) was left in the hands of the English as a security for the debt.

In consequence of the emperor's resolution to humble the Protestant princes, he concluded a dishonourable peace with the Porte, stipulating that his brother Ferdinand should pay tribute for that part of Hungary which he still possessed; while the sultan enjoyed the imperial and undisturbed possession of all the rest. At the same time he entered into a league with pope Paul III. for the extirpation of heresy; but in reality with a view to oppress the liberties of Germany. Here, however, his ambition met with a severe check; for though he was successful at first, he was obliged in 1552 to conclude a peace with the Protestants on their own terms; as has been related under the article REFORMATION, n<sup>o</sup> 26—32.

126  
Charles ob-  
liged to  
conclude a  
disadvanta-  
geous peace  
with the  
Turks and  
Protest-  
ants.

By the peace concluded on this occasion the emperor lost Metz, Toul, and Verdun, which had formed the barrier of the empire on that quarter; and therefore soon after put himself at the head of an army, in order to recover these three bishoprics. In order to conceal the destination of his army, he gave out, that he intended to lead it into Hungary, to second Maurice in his operations against the Infidels; and as that pretext failed him, when he began to advance towards the Rhine, he propagated a report that he was marching

127  
Attempts  
to recover  
some of his  
provinces.

<sup>Spain.</sup> first to chastise Albert of Brandenburg, who had refused to be included in the treaty of Passau, and whose cruel exactions in that part of Germany called loudly for redress.

The French, however, were not deceived by these arts. Henry immediately guessed the true object of Charles's armament, and resolved to defend his conquests with vigour. The defence of Metz, against which it was foreseen the whole weight of the war would be turned, was committed to Francis of Lorraine, duke of Guise, who possessed in an eminent degree all the qualities that render men great in military command. He repaired with joy to the dangerous station; and many of the French nobility, and even princes of the blood, eager to distinguish themselves under such a leader, entered Metz as volunteers. The city was of great extent, ill fortified, and the suburbs large. For all these defects the duke endeavoured to provide a remedy. He repaired the old fortifications with all possible expedition, labouring with his own hands; the officers imitated his example; and the soldiers, thus encouraged, cheerfully submitted to the most severe toils; he erected new works, and he levelled the suburbs with the ground. At the same time he filled the magazines with provisions and military stores, compelled all useless persons to leave the place, and laid waste the neighbouring country; yet such were his popular talents, as well as his arts of acquiring an ascendant over the minds of men, that the citizens not only refrained from murmuring, but seconded him with no less ardour than the soldiers in all his operations—in the ruin of their estates, and in the havoc of their public and private buildings.

Meanwhile the emperor continued his march towards Lorraine, at the head of 60,000 men. On his approach Albert of Brandenburg, whose army did not exceed 20,000, withdrew into that principality, as if he intended to join the French king; and Charles, notwithstanding the advanced season, it being towards the end of October, laid siege to Metz, contrary to the advice of his most experienced officers.

The attention of both the besiegers and the besieged was turned for some time towards the motions of Albert, who still hovered in the neighbourhood, undetermined which side to take, though resolved to sell his service. Charles at last came up to his price, and he joined the imperial army. The emperor now flattered himself that nothing could resist his force; but he found himself deceived. After a siege of almost 60 days, during which he had attempted all that was thought possible for art or valour to effect, and had lost upwards of 30,000 men by the inclemency of the weather, diseases, or the sword of the enemy, he was obliged to abandon the enterprize.

<sup>129</sup> Miserable condition of his army. When the French sallied out to attack the enemy's rear, the imperial camp was filled with the sick and wounded, with the dead and the dying. All the roads by which the army retired were strewed with the same miserable objects; who, having made an effort beyond their strength to escape, and not being able to proceed, were left to perish without assistance. Happily that, and all the kind offices which their friends had not the power to perform, they received from their enemies. The duke of Guise ordered them all to be taken care of, and supplied with every necessary; he appointed

physicians to attend, and direct what treatment was proper for the sick and wounded, and what refreshments for the feeble; and such as recovered he sent home, under an escort of soldiers, and with money to bear their charges. By these acts of humanity, less common in that age, the duke of Guise completed that heroic character which he had justly acquired by his brave and successful defence of Metz.

The emperor's misfortunes were not confined to Germany. During his residence at Villach, he had been obliged to borrow 200,000 crowns of Cosmo de Medici; and so low was his credit, that he was obliged to put Cosmo in possession of the principality of Piombino as a security for that inconsiderable sum; by which means he lost the footing he had hitherto maintained in Tuscany. Much about the same time he lost Sienna. The citizens, who had long enjoyed a republican government, rose against the Spanish garrison, which they had admitted as a check upon the tyranny of the nobility, but which they found was meant to enslave them; forgetting their domestic animosities, they recalled the exiled nobles; they demolished the citadel, and put themselves under the protection of France.

To these unfortunate events one still more fatal had almost succeeded. The severe administration of the viceroy of Naples had filled that kingdom with murmuring and dissatisfaction. The prince of Salerno, the head of the malecontents, fled to the court of France. The French monarch, after the example of his father, applied to the grand signior; and Solyman, at that time highly incensed against the house of Austria on account of the proceedings in Hungary, sent a powerful fleet into the Mediterranean, under the command of the corsair Dragut, an officer trained up under Barbarossa, and scarce inferior to his master in courage, talents, or in good fortune. Dragut appeared on the coast of Calabria at the time appointed; but not being joined by the French fleet according to concert, he returned to Constantinople, after plundering and burning several places, and filling Naples with consternation.

Highly mortified by so many disasters, Charles retired into the Low Countries, breathing vengeance against France: and here the war was carried on with considerable vigour. Impatient to efface the stain which his military reputation had received before Metz, Charles laid siege to Terouane; and the fortifications being in disrepair, that important place was carried by assault. Hesdin also was invested, and carried in the same manner. The king of France was too late in assembling his forces to afford relief to either of these places; and the emperor afterwards cautiously avoided an engagement.

The imperial arms were less successful in Italy. The viceroy of Naples failed in an attempt to recover Siena; and the French not only established themselves more firmly in Tuscany, but conquered part of the island of Corfica. Nor did the affairs of the house of Austria go on better in Hungary during the course of this year. Isabella and her husband appeared once more in Transylvania, at a time when the people were ready for revolt, in order to revenge the death of Martinuzzi, whose loins they had severely felt. Some noblemen of eminence declared in favour of the emperor; and the bashaw of Belgrade, by Solyman's persuasion, espousing his cause,

Spain.

130 His further misfortunes.

131 His success in the Low Countries.

132 But not so in other places.

Spain.

in opposition to Ferdinand, Castaldo, the Austrian general, was obliged to abandon Transylvania to Isabella and the Turks.

133  
Marriage  
between  
Philip of  
Spain and  
Mary of  
England.

In order to counterbalance these and other losses, the emperor, in 1554, concerted a marriage between his son Philip and Mary of England, in hopes of adding that kingdom to his other dominions. Meanwhile the war between Henry and Charles was carried on with various success in the Low Countries, and in Italy much to the disadvantage of France. The French, under the command of Strozzi, were defeated in the battle of Merciano; Sienna was reduced by Medicino, the Florentine general, after a siege of ten months; and the gallant Sieneſe were subjected to the Spanish yoke. Much about the same time a plot was formed by the Franciscans, but happily discovered before it could be carried into execution, to betray Metz to the Imperialists. The father-guardian, and twenty other monks, received sentence of death on account of this conspiracy; but the guardian, before the time appointed for his execution, was murdered by his incensed accomplices, whom he had seduced; and six of the youngest were pardoned.

While war thus raged in Italy and the Low Countries, Germany enjoyed such profound tranquillity, as afforded the diet full leisure to confirm and perfect the plan of religious pacification agreed upon at Passau, and referred to the consideration of the next meeting of the Germanic body. During the negotiation of this treaty, an event happened which astonished all Europe, and confounded the reasonings of the wisest politicians. The emperor Charles V. though no more than 55, an age when objects of ambition operate with full force on the mind, and are generally pursued with the greatest ardour, had for some time formed the resolution of resigning his hereditary dominions to his son Philip. He now determined to put it in execution. Various have been the opinions of historians concerning a resolution so singular and unexpected; but the most probable seem to be, the disappointments which Charles had met with in his ambitious hopes, and the daily decline of his health. He had early in life been attacked with the gout; and the fits were now become so frequent and severe, that not only the vigour of his constitution was broken, but the faculties of his mind were sensibly impaired. He therefore judged it more decent to conceal his infirmities in some solitude, than to expose them any longer to the public eye; and as he was unwilling to forfeit the fame, or lose the acquisitions of his better years, by attempting to guide the reins of government when he was no longer able to hold them with steadiness, he determined to seek in the tranquillity of retirement, that happiness which he had in vain pursued amidst the tumults of war and the intrigues of state.

In consequence of this resolution, Charles, who had already ceded to his son Philip the kingdom of Naples and the duchy of Milan, assembled the states of the Low Countries at Brussels; and seating himself for the last time in the chair of state, he explained to his subjects the reasons of his resignation, and solemnly devolved his authority upon Philip. He recounted with dignity, but without ostentation, all the great things which he had undertaken and performed since the commencement of his administration. "I have dedicated

(observed he), from the 17th year of my age, all my thoughts and attention to public objects, reserving no portion of my time for the indulgence of ease, and very little for the enjoyment of private pleasure. Either in a pacific or hostile manner, I have visited Germany nine times, Spain six times, France four times, Italy seven times, the Low Countries ten times, England twice, Africa as often; and while my health permitted me to discharge the duty of a sovereign, and the vigour of my constitution was equal in any degree to the arduous office of governing such extensive dominions, I never shunned labour, nor repined under fatigue; but now, when my health is broken, and my vigour exhausted by the rage of an incurable dilemma, my growing infirmities admonish me to retire; nor am I so fond of reigning, as to retain the sceptre in an impotent hand, which is no longer able to protect my subjects. Instead of a sovereign worn out with diseases (continued he), and scarce half alive, I give you one in the prime of life, already accustomed to govern, and who adds to the vigour of youth all the attention and sagacity of maturer years." Then turning towards Philip, who fell on his knees, and kissed his father's hand, "It is in your power (said Charles), by a wife and virtuous administration, to justify the extraordinary proof which I give this day of my paternal affection, and to demonstrate that you are worthy of the extraordinary confidence which I repose in you. Preserve (added he) an inviolable regard for religion; maintain the Catholic faith in its purity; let the laws of your country be sacred in your eyes; encroach not on the rights of your people; and if the time should ever come when you shall wish to enjoy the tranquillity of private life, may you have a son to whom you can resign your sceptre with as much satisfaction as I give up mine to you." A few weeks after, he resigned to Philip the sovereignty of Spain and America; reserving nothing to himself out of all these vast possessions but an annual pension of 100,000 crowns.

Charles was now impatient to embark for Spain, where he had fixed on a place of retreat; but by the advice of his physicians, he put off his voyage for some months, on account of the severity of the season; and, by yielding to their judgment, he had the satisfaction before he left the Low Countries of taking a considerable step towards a peace with France. This he ardently longed for; not only on his son's account, whose administration he wished to commence in quietness, but that he might have the glory, when quitting the world, of restoring to Europe that tranquillity which his ambition had banished out of it almost from the time that he assumed the reins of government.

The great bar to such a pacification, on the part of France, was the treaty which Henry had concluded with the Pope; and the emperor's claims were too numerous to hope for adjusting them suddenly. A truce of five years was therefore proposed by Charles; during which term, without discussing their respective pretensions, each should retain what was in his possession; and Henry, through the persuasion of the constant Montmorency, who represented the imprudence of sacrificing the true interests of his kingdom to the rash engagements that he had come under with Paul, authorized his ambassadors to sign at Vaucelles a treaty,

Spain.

134  
Charles re-  
signs his  
dominions  
to his son  
Philip.

135  
A truce of  
five years  
concluded  
with  
France.



Spain. which would insure to him for so considerable a period the important conquest which he had made on the German frontier, together with the greater part of the duke of Savoy's dominions.

The Pope, when informed of this transaction, was no less filled with terror and astonishment than rage and indignation. But he took equal care to conceal his fear and his anger. He affected to approve highly of the truce; and he offered his mediation, as the common father of Christendom, in order to bring about a definitive peace. Under this pretext, he appointed cardinal Rebibo his nuncio to the court of Brussels, and his nephew cardinal Caraffa to that of Paris. The public instructions of both were the same; but Caraffa, besides these, received a private commission, to spare neither intreaties, promises, nor bribes, in order to induce the French monarch to renounce the truce and renew his engagements with the holy see. He flattered Henry with the conquest of Naples; he gained by his address the Guises, the queen, and even the famous Diana of Poitiers, duchess of Valentinois, the king's mistress; and they easily swayed the king himself, who already leaned to that side towards which they wished to incline him. All Montmorency's prudent remonstrances were disregarded; the nuncio (by powers from Rome) absolved Henry from his oath of truce; and that weak prince signed a new treaty with the Pope; which rekindled with fresh violence the flames of war, both in Italy and the Low Countries.

136  
dairrel be-  
ixt the  
e and  
ng Phi-

No sooner was Paul made acquainted with the success of this negotiation than he proceeded to the most indecent extremities against Philip. He ordered the Spanish ambassador to be imprisoned; he excommunicated the Colonnas, because of their attachment to the imperial house; and he considered Philip as guilty of high treason, and to have forfeited his right to the kingdom of Naples, which he was supposed to hold of the holy see. For afterward affording them a retreat in his dominions.

Alarmed at a quarrel with the Pope, whom he had been taught to regard with the most superstitious veneration, as the vicegerent of Christ and the common father of Christendom, Philip tried every gentle method before he made use of force. He even consulted some Spanish divines on the lawfulness of taking arms against a person so sacred. They decided in his favour; and Paul continuing inexorable, the duke of Alva, to whom the negotiations as well as the war had been committed, entered the ecclesiastical state at the head of 10,000 veterans, and carried terror to the gates of Rome.

The haughty pontiff, though still inflexible and undaunted in himself, was forced to give way to the tears of the cardinals, and a truce was concluded for 40 days. Mean time the duke of Guise arriving with a supply of 20,000 French troops, Paul became more arrogant than ever, and banished all thoughts from his mind but those of war and revenge. The duke of Guise, however, who had precipitated his country into this war, chiefly from a desire of gaining a field where he might display his own talents, was able to perform nothing in Italy worthy of his former fame. He was obliged to abandon the siege of Civetella; he could not bring the duke of Alva to a general engagement; his army perished by diseases; and the Pope neglected to furnish the neces-

sary reinforcements. He begged to be recalled; and France stood in need of his abilities.

Spain. Philip, though willing to have avoided a rupture, was no sooner informed that Henry had violated the truce of Vaucelles, than he determined to act with such vigour, as should convince Europe that his father had not erred in resigning to him the reigns of government. He immediately assembled in the Low Countries a body of 50,000 men, and obtained a supply of 10,000 from England, which he had engaged in his quarrel; and as he was not ambitious of military fame, he gave the command of his army to Emanuel Philibert duke of Savoy, one of the greatest generals of that warlike age.

The duke of Savoy kept the enemy for some time in suspense with regard to his destination; at last he seemed to threaten Champagne; towards which the French drew all their troops; then turning suddenly to the right, he advanced by rapid marches into Picardy, and laid siege to St Quintin. It was deemed in those times <sup>137</sup> The French entirely de-  
defeated at  
St Quintin.  
a town of considerable strength; but the fortifications had been much neglected, and the garrison did not amount to a fifth part of the number requisite for its defence: it must therefore have surrendered in a few days, if the admiral de Coligny had not taken the gallant resolution of throwing himself into it with such a body of men as could be collected on a sudden. This he effected in spite of the enemy, breaking through their main body. The place, however, was closely invested; and the constable Montmorency, anxious to extricate his nephew out of that perilous situation, in which his zeal for the public had engaged him, as well as to save a town of such importance, rashly advanced to its relief with forces one half inferior to those of the enemy. His army was cut in pieces, and he himself made prisoner.

The cautious temper of Philip on this occasion saved France from devastation, if not ruin. The duke of Savoy proposed to overlook all inferior objects, and march speedily to Paris, which, in its present consternation, he could not have failed to make himself master of; but Philip, afraid of the consequences of such a bold enterprise, desired him to continue the siege of St Quintin, in order to secure a safe retreat in case of any disastrous event. The town, long and gallantly defended by Coligny, was at last taken by storm; but not till France was in a state of defence.

Philip was now sensible that he had lost an opportunity which could never be recalled, of distressing his enemy, and contented himself with reducing Horn and Catelet; which petty towns, together with St Quintin, were the sole fruits of one of the most decisive victories gained in the 16th century. The Catholic king, however, continued in high exultation on account of his success: and as all his passions were tinged with superstition, he vowed to build a church, a monastery, and a palace, in honour of St Laurence, on the day sacred to whose memory the battle of St Quintin had been fought. He accordingly laid the foundation of an edifice, in which all these were included, and which he continued to forward at vast expence, for 22 years. The same principle which dictated the vow directed the building. It was so formed as to resemble a gridiron—on which culinary instrument, according to the legendary tale,

Spain. St Laurence had suffered martyrdom. Such is the origin of the famous escorial near Madrid, the royal residence of the kings of Spain.

The first account of that fatal blow which France had received at St Quintin, was carried to Rome by the courier whom Henry had sent to recal the duke of Guise. Paul remonstrated warmly against the departure of the French army; but Guise's orders were peremptory. The arrogant pontiff therefore found it necessary to accommodate his conduct to the exigency of his affairs, and to employ the mediation of the Venetians, and of Cosmo de Medici, in order to obtain peace. The first overtures of this nature were eagerly listened to by the Catholic king, who still doubted the justice of his cause, and considered it as his greatest misfortune to be obliged to contend with the Pope. Paul agreed to renounce his league with France; and Philip stipulated on his part, that the duke of Alba should repair in person to Rome, and after asking pardon of the holy father in his own name and in that of his master, for having invaded the patrimony of the church, should receive absolution from that crime. Thus Paul, thro' the superstitious timidity of Philip, only finished an unpropitious war not without any detriment to the apostolic see, but saw his conqueror humbled at his feet: and so excessive was the veneration of the Spaniards in that age for the papal character, that the duke of Alba, the proudest man perhaps of his time, and accustomed from his infancy to converse with princes, acknowledged, that when he approached Paul, he was so much overawed, that his voice failed, and his presence of mind forsook him.

138  
Peace concluded.

139  
Consequences of the war in Italy.

But though this war, which at its commencement threatened mighty revolutions, was terminated without occasioning any alteration in those states which were its immediate object, it produced effects of considerable consequence in other parts of Italy. In order to detach Octavio Farnese, duke of Parma, from the French interest, Philip restored to him the city of Placentia and its territory, which had been seized by Charles V. and he granted to Cosmo de Medici the investiture of Sienna, as an equivalent for the sums due to him. By these treaties, the balance of power among the Italian states was poised with more equality, and rendered less variable than it had been since it received the first violent shock from the invasion of Charles VIII. and Italy henceforth ceased to be the theatre on which the monarchs of Spain, France, and Germany, contended for fame and dominion. Their hostilities, excited by new objects, stained other regions of Europe with blood, and made other states feel, in their turn, the miseries of war.

140  
The French successful in the Low Countries.

The duke of Guise, who left Rome the same day that his adversary the duke of Alba made his humiliating submission to the Pope, was received in France as the guardian angel of the kingdom. He was appointed lieutenant-general in chief, with a jurisdiction almost unlimited; and, eager to justify the extraordinary confidence which the king had reposed in him, as well as to perform something suitable to the high expectations of his countrymen, he undertook in winter the siege of Calais. Having taken that place, he next invested Thionville in the duchy of Luxembourg, one of the strongest towns on the frontiers of the Netherlands; and forced it to capitulate after a siege of three weeks. But

the advantages on this quarter were more than balanced by an event which happened in another part of the Low Countries. The marshal de Termes governor of Calais, who had penetrated into Flanders and taken Dunkirk, was totally routed near Gravelines, and taken prisoner by count Egmont. This disaster obliged the duke of Guise to relinquish all his other schemes, and hasten towards the frontiers of Picardy, that he might there oppose the progress of the enemy.

The eyes of all France were now turned towards the duke of Guise, as the only general on whose arms victory always attended, and in whose conduct as well as good fortune they could confide in every danger. His strength was nearly equal to the duke of Savoy's, each commanding about 40,000 men. They encamped at the distance of a few leagues from one another; and the French and Spanish monarchs having joined their respective armies, it was expected that, after the vicissitudes of war, a decisive battle would at last determine which of the rivals should take the ascendant for the future in the affairs of Europe. But both monarchs, as if by agreement, stood on the defensive; neither of them discovering any inclination, though each had it in his power, to rest the decision of a point of such importance on the issue of a single battle.

During this state of inaction, peace began to be mentioned in each camp, and both Henry and Philip discovered an equal disposition to listen to any overture that tended to re-establish it. The private inclinations of both kings concurred with their political interests and the wishes of their people. Philip languished to return to Spain, the place of his nativity; and peace only could enable him, either with decency or safety, to quit the Low Countries. Henry was now desirous of being freed from the avocations of war, that he might have leisure to turn the whole force of his government towards suppressing the opinions of the reformers, which were spreading with such rapidity in Paris and the other great towns, that they began to grow formidable to the established church. Court-intrigues conspired with these public and avowed motives to hasten the negotiation, and the abbey of Cercamp was fixed on as the place of congress.

While Philip and Henry were making these advances towards a treaty which restored tranquillity to Europe, Charles V. whose ambition had so long disturbed it, but who had been for some time dead to the world, ended his days in the monastery of St Justus in Estremadura, which he had chosen as the place of his retreat, as is particularly related under the article CHARLES V.

After the death of Charles, the kingdom of Spain soon lost great part of its consequence. Though Charles had used all his interest to get his son Philip elected emperor of Germany, he had been totally disappointed; and thus the grandeur of Philip II. never equalled that of his father. His dominions were also considerably abridged by his tyrannical behaviour in the Netherlands. In consequence of this, the United Provinces revolted; and after a long and bloody war obtained their liberty\*. In this quarrel Elizabeth of England took part against Philip, which brought on a war with Spain. The great losses he sustained in these wars exhausted the kingdom both of men and money, notwithstanding the great sums imported from America. Indeed, the discovery and conquest of that country hath much impoverished, indeed

Spain.

141  
Peace concluded between Henry and Philip.

142  
Death of Charles.

143  
Revolt of the United Provinces.

Spain. <sup>144</sup>stead of enriching Spain; for thus the inhabitants have been rendered lazy and averse from every kind of manufacture or traffic, which only can be a durable source of riches and strength to any nation. The ruin of the kingdom in this respect, however, was completed by Philip III. who, at the instigation of the inquisition, and by the advice of his prime minister the duke of Lerma, expelled from the kingdom all the Moriscoes or Moors, descendants of the ancient conquerors of Spain. Thirty days only were allowed them to prepare for their departure, and it was death to remain beyond that time. The reason for this barbarous decree was, that these people were still Mahometans in their hearts, though they conformed externally to the rites of Christianity, and thus might corrupt the true faith. The Moriscoes, however, chose themselves a king, and attempted to oppose the royal mandate; but, being almost entirely unprovided with arms, they were soon obliged to submit, and all banished the kingdom. By this violent and impolitic measure, Spain lost almost a million of industrious inhabitants; and as the kingdom was already depopulated by bloody wars, by repeated emigrations to America, and enervated by luxury, it now sank into a state of languor from whence it has never recovered.

<sup>145</sup>Revolt of Portugal, &c. In consequence of this languor, and the maladministration of the Spanish governors, Portugal, which had been reduced by Philip II. revolted, and has ever since been an independent kingdom †. However, the memory of what Spain once was, remained for a considerable time, and the power of that kingdom long continued to be feared after it had ceased to be powerful. In the time of queen Anne, a British army was seen for the first time in Spain, in order to support Charles of Austria against Philip the grandson of Louis XIV. The ill success of that attempt is related under the article BRITAIN, n<sup>o</sup> 342—359; and thus the crown of Spain fell to a branch of the house of Bourbon, in consequence of which the courts of France and Spain generally acted in the closest concert till the revolution, which at present astonishes Europe, put an end to monarchical government in the former country. The wars of these two courts with BRITAIN are related under that article and AMERICA; and these, with an unsuccessful attempt on Algiers, and the threatened war respecting *Novorica Sound* (see that article), constitute the most important part of the Spanish history till the deposition and murder of Louis XVI. of France. On that event Spain joined her forces to those of the Empire, Britain, and Prussia, to chastise the Convention, and prevent those democratical principles which had ruined France from being spread through the other nations of Europe. We cannot say that her exertions added much to the strength of the alliance; and being unable to defend herself against the furious inroads of the republican troops, she was glad to make a separate peace with the Convention. See REVOLUTION.

<sup>146</sup>Air and climate of Spain. The air of Spain, during the months of June, July, and August, is excessively hot in the day-time; but the rest of the year it is pleasant and temperate. Even during the above months it is very cool in the shade; and so cold in the night, that it makes a traveller shiver; and in the day-time the violent heat continues only for about four or five hours. In the north, on

the mountains, and near the sea-coast, the air is much less sultry in summer than in the south, especially in the lower parts of the country, and at a distance from the sea. It seldom rains here, except about the equinoxes: the frosts are very gentle towards the south; but on the mountains in the north and north-east the air is very sharp in winter.

<sup>147</sup>Though there are some sandy barren deserts in the south, and many barrea mountains in the north, yet in the greater part of the country, particularly in the valleys and plains, the soil is good, producing a great variety of rich wines, oil, and fruits; such as oranges, lemons, prunes, citrons, almonds, raisins, dates, figs, chestnuts, pomegranates, capers, pears, and peaches; but not a sufficiency of grain, which is chiefly owing to the neglect of tillage. Wheat and barley are the most common grain; the former of which is said by some to be the best in Europe. There is not much flax, hemp, oats, or hay, in Spain: but there is plenty of honey, salt, fine wool, silk, and cotton; and, in some places, of rice and sugar-canes. Here also are abundance of mules, and, in some provinces, of horses, together with deer, wild-fowl, and other game, chamois and other goats, but few horned cattle. Wolves are almost the only wild beasts in the country. The herb kali, which is used in making salt, soap, and glass, grows in great plenty on the sea-shore. The wild bulls, used in their bull-fights, are bred in Andalusia. The seas about Spain are well stored with fish; among which is the anchovy, in the Mediterranean. We may guess at the number of sheep here by that of the shepherds, which is said to be about forty thousand. The sheep that bear the fine-wool move regularly, every summer, from south to north, along the mountains, which yield a great variety of sweet herbs and plants, and return again towards winter. During this progress, large quantities of salt are distributed among them, and all possible care is taken both of their health and fleeces.

<sup>148</sup>The chief mountains are the Pyrenees, which stretch Mountains, from the Mediterranean to the Atlantic Ocean, but not minerals, in a direct line, for near 200 miles: their breadth is, &c. in some places, not less than 80. That called the *Pic de Midi* is of a prodigious height. Over these mountains there are only about five passages out of Spain into France, and these also narrow; even the valleys between the mountains are covered with thick and lofty woods. The other chains in Spain are the Sierra d'Occa, Sierra Molino, Sierra Moreno, and Sierra Novada or the snowy mountains. Near Gibraltar, opposite to Mount Abyla in Africa, stands the celebrated Mount Calpe: these were anciently called *Hercules's pillars*. The mountains yield great quantities of timber for shipping, which are conveyed by the Ebro and other rivers to the Mediterranean. According to the ancient and modern writers, they abound also with gold, silver, iron, lead, tin, cinnabar, quicksilver, alum, vitriol, copperas, lapis calaminaris, &c. besides gems, and mineral waters both hot and cold. The gold and silver mines are not worked at present, but those of iron are. The neglect of the former is owing partly to the indolence of the Spaniards, and partly to the gold and silver imported from America. Besides the rivers Minho, Douro, Tagus, Monda, Lima, and Guadiana, mentioned in Portugal, but which have their sources in Spain, the

Spain.  
149  
Religion.

the most considerable are the Ebro, formerly *Iberus*, Guadalquivir, anciently *Turia*, Guadalquiver or *Batis*, Segura, and Xucar.

The Spaniards are zealous Romanists. Nowhere is there more pomp, farce, and parade, in what regards religion; and nowhere less true Christianity. Their zeal and their superstition exceed that of any other Roman Catholic country, unless perhaps we should except Portugal. Nowhere did the inquisition reign with greater terror; there being no subject who was not liable to be prosecuted by the *holy office*, as it is called; however, the powers of that tribunal are now greatly diminished even in Spain. There are eight archbishops in Spain, seven in America, and one in Asia at Manilla; each of which has his suffragan bishops. The archbishop of Toledo is primate, chancellor of Castile, and, by virtue of his office, privy-counsellor. He is said to have a revenue of 100,000*l.* Sterling *per annum*, or more. The king nominates all archbishops and bishops; and since 1753 all small benefices are also in his gift. He has also lately obtained a power to tax ecclesiastical possessions, according to his pleasure and the exigency of affairs. Though the rest of the nation is poor, the clergy are immensely rich, and their revenues of all kinds very great. Most of the towns and estates belong to them, and are exempt from all public burdens; yet their avarice is insatiable, especially that of the Mendicant friars, though they profess poverty. Their commerce, which is free from all duties and imposts, is also a rich fund to them. Though the Spaniards are naturally men of wit and of an elevated genius, yet little progress in the sciences is to be expected from them, while the clergy use their utmost efforts to keep them in ignorance, branding all literary researches with the name of heresy, and inveighing against the seats of the muses as the schools of hell, where the devil teaches foreery. There are 22 universities, and several academies, in Spain; but so constituted, and under such restrictions, that they can never attain to any measure of true learning. There are few printing-houses in Spain; and most of the books in that language are published in other countries.

150  
Trade and  
manufac-  
tures.

In regard to trade and manufactures, the Spaniards are far from making such a figure as might be expected. Most of the laborious work in their husbandry, manufactures, and handicrafts, is performed by the French, especially in the two Castiles and the midland provinces, the natives being either too lazy or too proud to stoop to such employments. By these means, the French usually return with large fortunes to their own country. The chief manufactures of Spain are those of silk, wool, iron, copper, and other hardwares; but these fall far short of the flourishing condition to which they might be brought: hence a great part of the treasures of America go to the foreign merchants, who supply them with goods for that part of the world. However, it is certain, that Spain, since it hath had princes of the house of Bourbon upon the throne, hath improved its revenues, increased its forces by sea and land, and applied itself more than it did before to manufactures and husbandry; having shaken off, in some measure, that idle indolent disposition which rendered it so contemptible in the eyes of other nations; but it will be a long time before they will be able to supply the wants of their own country, and those of America, in any great

degree. Spain is extremely well situated for trade: but most of its produce is exported by foreigners, except what is carried to the Indies; and even with regard to that trade, they are little better than factors to the English, French, Dutch, and Italians. Smuggling, which was formerly carried to a great height, is now in a great measure suppressed. Since the year 1750, the exportation of silver hath been allowed on the payment of 3 *per cent.* From 1735 almost to 1756, the flotas and galleons were discontinued, and the trade to America carried on in register-ships, which any merchant might send, on permission obtained from the council of the Indies: but then the flotas and galleons were restored. The *Affogee* ships are two vessels which carry quicksilver on the king's account to Vera Cruz. There is a company which has an exclusive grant for trading to the Caraccas; and another for trading to Porto Rico, the Bay of Honduras, the province of Guatimala and Hispaniola; but the Spanish part of the last, it is said, hath been lately ceded to the French. One ship, and sometimes two, sails annually from Manilla, in the island of Luconia, one of the Philippines, for Acapulco in Mexico: her cargo, which belongs to the convents, consists of the principal commodities of that part of the world; but the return from Acapulco is for the most part made in money, and amounts to a vast sum, as appeared from the treasure found on board the Acapulco ship taken by Lord Anson. In return for the manufactures sent to America, the Spaniards receive gold, silver, cochineal, indigo, the cocoa or chocolate nut, logwood and other dyeing woods, sugar, tobacco, snuff, and other productions of that part of the world; supplying most part of Europe and Asia with the silver which they bring from thence in their galleons. In the time of the Moors and Goths, this kingdom was exceedingly populous. It is said to have then contained between twenty and thirty millions; whereas now it does not contain above nine: and this, among other causes, is owing to the pride and laziness of the inhabitants, want of manufactures and good regulations, neglect of the mines and agriculture, the expulsion of the Moors, the peopling of America, heavy taxes, the great number of convents, excessive venery, and the consequent infecundity of both sexes. Their debauchery and sterility are partly occasioned by their way of living; for they make great use of spices, and drink a great deal of chocolate, and strong wine mixed with brandy. The causes assigned for the want of people in Spain will account in some measure for its poverty; notwithstanding it is computed that it receives one year with another, setting aside other sums, above 26 millions of pieces of eight, in registered gold and silver. As most of the manufactures that are sent to America are furnished by Britain, France, Italy, and Holland, so a great part of the treasure brought home by the galleons is paid to the merchants of those nations.

The constitution of Spain is at present an absolute hereditary monarchy, where the females inherit in default of the males. The king, in his title, enumerates most of the provinces and particular parts of the dominions he has been or is possessed of. In speaking of him, he is commonly called his *Catholic Majesty*, or the *Catholic King*. The hereditary prince is commonly styled *Prince of Asturias*, and the other royal children *Infants*. The kings of Spain are never crowned; they seem

Spain.

151  
Constitu-  
tion and go-  
vernment.

Spain. seem to have a power to dispose of the crown to what branch of the royal family they please. For the administration of the government and of justice, here are several councils and tribunals; as the junto or cabinet-council, the privy-council, the council of war, the council of Castile, the council of the inquisition, the council of finances, the council of the Indies, the seven courts of royal audiences, &c.

The general history of Spain proves how great an influence the Cortes had in former times in the most important affairs of government; such as war or peace, and the levying of taxes. But during a long course of years they have not been assembled, except for the sake of form; and the sovereigns, without violence, or formally rejecting their intervention, have found means to elude their authority. They promulgate from the throne certain ordinances under the name of *Pragmatics*, the preambles of which give us to understand, that they claim the same authority as if they had been published in the assembly of the Cortes; who are never convoked but at the accession of a new monarch, to administer to him an oath in the name of the nation, and to swear fidelity to him. As this event happened so lately as the month of September 1789, when the present king of Spain received the homage of all his subjects in the church of St Jerome at Madrid, it may not be unacceptable to give an account of the usual mode of assembling them.

“On this occasion letters of convocation are sent to all the *Grandees*; to all persons bearing titles of Castile; to all the prelates; and to every city which has a right to send deputies to the Cortes. The two first classes represent the nobility; the priests sit in the name of the clergy; and the cities, which depute one of their magistrates, represent the people.” Except on the above-mentioned occasion, the Cortes of the whole kingdom have been assembled but twice during the present century, and only once upon public business, in the year 1713, when Philip V. convoked them to give their approbation to the Pragmatic Sanction, which changed the order of succession to the throne. They are still consulted, for the sake of form, in certain cases; but then, the members of which they are composed correspond with each other without assembling. At their breaking up in 1713, it was regulated, that they should be represented by a permanent committee, whose office it should be to watch over the administration of that part of the taxes known by the name of *Millones*, and which had been granted under Philip II. with the formal consent of the Cortes, upon certain conditions, which the monarch swore to observe. They retained the administration of these imposts until the year 1718, when cardinal Alberoni, whose ardent and imperious genius was irritated at such shackles, transferred it to the hands of the sovereign. From that time, the assemblies of the deputies of the kingdom have received no more of the revenues of the state than is necessary to pay the salaries and defray the expences of the members. These are eight in number, and are chosen in the following manner: All the provinces of Castile unite to nominate six; Catalonia and Majorca appoint one; and the regencies of Valentia and Aragon elect the eighth. These deputies hold their places six years, at the end of which a new election takes place in the same manner. As a relic of their ancient rights, they still retain the privi-

lege of being, by virtue of their places, members of the council of finances, by which the sovereign communicates to the nation the necessity of levying any new tax; and the approbation they are supposed to give to the royal resolution, is a shadow of the consent of the Cortes, without which taxes could not formerly be either levied or augmented. But it is easy to perceive how feeble this rampart of liberty must be, which is only formed of a small number of citizens, who possess but little real power; are under the controul of government, from which they expect favours and preferments; and who, after all, represent the most numerous indeed, but least respected, part of the nation. The provinces of Biscay and Navarre, which have assemblies and particular privileges, send also, on some occasions, deputies to the throne; but they do not make a part of the body of the deputies of the kingdom, and their constituents fix at pleasure the object and duration of their temporary mission.

The administration of Spain is divided into six principal departments. The minister for foreign affairs is in many respects the directing minister, and receives, as a mark of distinction, the title of secretary of state. The minister of war has but a circumscribed authority. He is president of the council of war, which is rather a tribunal than a board of administration; but the inspectors of the infantry, and those of the cavalry, dragoons, and provincial regiments, draw up a statement of whatever relates to the corps of which they have the direction; and the minister at war has only to present the memorials they give in to the king. The marine minister has no associates. The chiefs of the three departments of Ferrol, Carthagena, and Cadiz, and inspectors of the marine, are named by the king, on the representation of the minister; but the marine ordinances prepared by him alone, require only the sanction of the king. The minister of the finances should properly be under the inspection of the superintendent-general of that department; but these two offices were some time since united, and will probably be so continued; for the separation of them would multiply, without necessity, the springs of government; and the interests of the state require that they should be simplified as much as permanent forms, those sacred bulwarks of justice and property, will admit.

The higher nobility consist of counts, marquises, and dukes. The *grandees*, who have precedence of all others, next the king and princes of the blood, are named out of these. They have the privilege of being covered in the king's presence, who styles them in his letters *Illustrious*; and in speaking to them or of them, *their Eminences*: but there are others beside the *grandees* who are covered in the king's presence; as cardinals, nuncios, archbishops, the grand prior of Castile and the grand prior of Malta, the generals of the orders of St Dominic and St Francis, ambassadors of crowned heads, the knights of the golden fleece, and of the three military orders of St James, Calatrava, and Alcantara, when the king assists at their respective chapters in quality of grandmaster. No *grandee* can be apprehended for any crime but by the express order of the king; and they have many other privileges besides these. The inferior nobility style themselves *Cavalleros* and *Hidalgos*.

Of the orders in Spain, that of the golden fleece is

the

Spain.  
152  
Orders of  
knight-  
hood.

the principal; which was instituted in 1430 by Philip the good duke of Burgundy, and is common now to the kings of Spain and the house of Austria. The order of St Jago de Compostella was instituted in the year 1175 by Ferdinand II. king of Leon. The order of Calatrava was founded by Sancho III. of Castile. The order of Alcantara owes its institution to Ferdinand II. king of Leon. The three last orders have large commanderies or estates annexed to them. The masters of them were once so powerful, that they disputed the king's authority over them; whereupon the king procured those masterships to be conferred on himself by the Pope, that they might no longer assume an independency of the state. The knights of these three orders are esteemed noblemen.

153  
Revenues.

In the last century, the revenues of Spain amounted to 32 or 33 millions of livres; but afterwards they were so reduced, that they did not exceed seven or eight millions. At present, the revenues of the crown arising in Spain are computed at five millions Sterling *per annum*, besides what arises from America. The silver mines there are inexhaustible; and of the produce of these a fifth belongs to the king. The taxes in Spain are numerous and heavy. The land forces, in time of peace, are computed at about 80,000; and in time of war, must be much more numerous. Their navy at present cannot be ascertained.

154  
Language.

The language of this country, especially that spoken in Castile, which is by far the purest, approaches the nearest to the Latin of any language in Europe, mixed with Arabic words and terminations introduced by the Moors. In some provinces, the vulgar tongue is a dialect of the old French, or rather Gascon, which is little understood in the others. In Biscay, the language is said to be dialect of the Gothic or Celtic, and to have some analogy with the Welch and Irish. As to what regards the character of the Spaniards, they do not want either an inclination or capacity for the sciences; but have hardly an opportunity of acquiring any true learning or knowledge, at least in their schools and universities. They are admired for their secrecy, constancy, gravity, patience in adversity, and loyalty. They are also said to be true to their word, great enemies to lying, and so nice and jealous in point of honour, that they will stick at nothing to wipe off any stain that is cast upon it. Among their vices and defects are reckoned their pride and contempt of foreigners, their indolence, laziness, lust, bigotry, and credulity in believing the feigned miracles and legends of their monks. They are also said to be extremely passionate, jealous, and vindictive; and are noted, above any other European nation, for despising and neglecting agriculture, arts, and manufactures.

155  
Some di-  
rections for  
travelling  
in Spain.

We will here subjoin some directions for travelling in Spain by Mr Townsend, a late respectable traveller; as they will enable the reader to form a more distinct notion of the state of that country than he could obtain from general description.

Townsend's  
Travels,  
vol. i.

"To travel commodiously in Spain, a man should have a good constitution, two good servants, letters of credit for the principal cities, and a proper introduction to the best families, both of the native inhabitants and of strangers settled in the country.

"The language will be easily acquired.

"His servants should be a Spaniard and a Swiss; of

which one should be sufficiently acquainted with the art of cooking, and with the superior art of providing for the journey; which implies a perfect knowledge of the country through which he is to pass, that he may secure a flock of wine, bread, and meat, in places where these excel, and such a stock as may be sufficient to carry him through the districts in which these are not to be obtained. For himself, his servants, and his baggage, he should purchase three strong mules, able to support the load which is to be put upon them. In his baggage he should have sheets, a matras, a blanket, and a quilt, a table-cloth, knives, forks, and spoons, with a copper vessel sufficiently capacious to boil his meat. This should be furnished with a cover and lock. Each of the servants should have a gun slung by the side of his mule.

Spain,  
Spalatro.

"To travel as an economist in Spain, a man must be contented to take his chance for conveyance, and either go by the post, wherever it is established; or join with officers, going to their various stations; to hire a coach, or quietly resign himself to a calash, a calasina, a horse, a mule, or a borrico. This last is the most convenient for the purpose of crossing the country, or of wandering among the mountains. If he is to traverse any district infested by banditti, it will be safe for him to go by the common carriers, in which case he will be mounted on a good mule, and take the place which would have been occupied by some bale of goods. Any one, who is fond of botany, for short excursions, will make choice of a borrico. This is always to be had when, as in some villages, neither horse nor mule are to be obtained. I have used this honourable appellation for the most patient of all animals, because I would not shock the delicacy of a young traveller, by telling him, at his first setting out, that he may sometimes find himself under the necessity of riding upon an ass. He must, however, know, for his consolation, that an ass does not appear so contemptible in Spain as in the colder regions of the north.

"The best time for him to begin this expedition is in autumn, when he may go by Bayonne, Burgos, Valladolid, and Segovia, hastening to the court at St Idelfonso. Here he is to procure letters for the chief cities in Spain. On these will depend the whole pleasure of his excursion. During the winter he may see all the south of Spain, Toledo, Cordova, Seville, Cadiz, Gibraltar, Malaga, Granada, Carthage, Murcia, Alicante, Valencia, and Barcelona. Returning by Zaragoza to Aranjuez in the spring, he may follow the Merino flock to the mountains of the north, whilst the country, on which he has turned his back, is rendered unfit for travelling, by the dissolving heats, by want of provisions, and by malignant fevers. This season will be best employed in Galicia, the Asturias, and the provinces of Biscay, taking Salamanca and Leon in the way."

*Novo SPAIN.* See MEXICO.

SPALATRO, or SPALATTO, a rich, populous, and strong town of the republic of Venice, capital of Venetian Dalmatia, with a good harbour and an archbishop's see. Here are the ruins of the palace of Dioclesian, of which the late Mr Robert Adam published in 1764 a splendid account, enriched with 71 etching plates. In 1784, Spalatro was nearly depopulated by the plague. It is strong by situation, being built on a peninsula, which is joined to Terra Firma by a neck of land half a mile over. It is seated on the Gulf of Venice, 35 miles south-

pan  
||  
spar.

south-east of Sebenico, and 102 north-west of Ragusa. E. Long. 17. 31. N. Lat. 44. 4.

SPAN, a measure taken from the space between the thumb and the tip of the little finger when both are stretched out. The span is estimated at three hand's breadths or nine inches.

SPANDRELL, the solid work on each haunch of an arch, to keep it from spreading.

SPANHEIM (Ezekiel), a learned writer in the 17th century, was born at Geneva in 1629; and in 1642 went to Leyden to study. Here he distinguished himself to great advantage; and his reputation spreading, Charles Louis elector palatine sent for him to be tutor to his only son. This task our author discharged to the entire satisfaction of the elector; by whom he was also employed in divers negotiations at foreign courts. He afterwards entered into the service of the elector of Brandenburg, who in 1680 sent him envoy-extraordinary to the court of France, and soon after made him a minister of state. After the peace of Ryswic, he was again sent on an embassy to France, where he continued from the year 1697 to 1702. The elector of Brandenburg having during that interval assumed the title of *King of Prussia*, conferred on him the title and dignity of a baron. In 1702 he left France; and went ambassador to England, where he had been several times. Here he died in 1710, aged 81 years. It is surprising, that in discharging the duties of a public minister with so much exactness, and amidst so many different journeys, he could find time enough to write the several books published by him. It may be said of him, that he acquitted himself in his negotiations like a person who had nothing else in his thoughts; and that he wrote like a man who had spent his whole time in his study. The principal of his works are, 1. *De præstantia et usu numismatum antiquorum*; the best edition of which is in two volumes folio. 2. Several letters or dissertations on scarce and curious medals. 3. A preface and notes to the edition of the emperor Julian's works, printed at Leipzig in 1696, folio.

SPANIEL, in zoology. See CANIS.

SPAR, in mineralogy, a name given to those earths which break easily into rhomboidal, cubical, or laminated fragments with polished surfaces. As the term *spar* is thus applied to stones of different kinds, without any regard to the ingredients of which they are composed, some additional term must be used to express the constituent parts as well as the figure; for instance, calcareous spar, gypseous spar, &c. The spars found in Britain and Ireland are of four different species; opaque, refracting, diaphanous, and stalactitical. 1. The opaque spar is rhomboidal, hexangular, and triangular, of various colours, and is found in mines in Wales, Derbyshire, &c. and at Ovens near Cork. 2. The refracting spar is rhomboidal, shows objects seen through it double, and sometimes 8, 12, or 16 images at once. It is frequent in the lead mines of Derbyshire, Yorkshire, &c. 3. Diaphanous spar is rhomboidal, triangular, hexangular, pyramidal or columnar; and is found in mines, quarries, and caverns, in many different places. 4. Stalactitical spar, icicle or drop-stone, is formed by the running or dropping of water, containing a large proportion of calcareous earth. It is opaque, generally laminated, but from accidental circumstances assumes va-

rious forms. It occurs at Knaresborough in Yorkshire, and at Ovens near Cork.

A new species of spar has lately been found in the East Indies, which, from its extreme hardness, approaching to that of a diamond, is called *adamantine spar*. It was discovered by Dr Black of Edinburgh to be a distinct species. Happening one day to visit a lapidary, it was shown to him among other specimens as a stone that was used in the East Indies for polishing gems, and grinding other hard substances. Dr Black immediately singled out a specimen which he sent to Mr Greville, who requested M. Klaproth to analyze it.

There are two varieties of this spar; one of them comes from China, and crystallizes in hexagonal prisms without pyramids, the length of the sides varying from six to twelve lines; their breadth being about nine, of a grey colour with different shades. Though the entire pieces are opaque, the thin laminæ are transparent, and when broken, its surface appears slightly striated. Its crystals are covered with a very fine and strongly adhering crust, composed of scales of silvery mica, mixed with particles of red feld-spar. Sometimes the surface has martial pyrites or yellow sulphuret of iron adhering to it. Its hardness is so great, that it not only cuts glass as easily as the diamond, but even scratches rock-crystal and other very hard stones. Its specific gravity is to that of water as 3710 to 1000. Sometimes it contains crystallized grains of magnetic oxyd of iron, which may be separated from the stone when pulverized by means of the loadstone.

The other kind found in Hindostan is of a whiter colour, and of a more laminated texture than the former: the grains of iron contained in it are likewise of a smaller size than those of the former; they are not diffused through its substance, but only adhere to its surface.

This spar is exceedingly difficult to analyze. To do so, M. Klaproth was obliged to melt it no less than 12 times with 15 parts of soda or mineral alkali, in a silver crucible; the heat being each time continued for five hours as strong as the crucible could bear. After each fusion the mass was softened by boiling distilled water, filtering and precipitating by acids the small quantity of earth which the alkali had dissolved; and lastly, that portion which had not been decomposed was digested at different times with concentrated and boiling acids. By this tedious process he at length found, that the spar consisted of alumine and another kind of earth, in the proportion of 2 to 1, the nature of which is not understood. It is not siliceous earth, as it does not combine with fixed alkalis in a melting heat; and for want of opportunities to make a sufficient number of experiments, our author was unable to determine whether it be a sixth simple earth, or a composition of two or more earths which he was not able to separate.

From a letter of M. Morveau to Mr Crell, it appears that this stone is also found in France. A small bit of this was tried by him in presence of Mr Wedgwood, and he found that its specific gravity was superior to the spar of China, being no less than 4.1803, and the true adamantine spar of China gave 3.8222.

SPARGANIUM, BUR-REED, in botany: A genus of plants belonging to the class of *monœcia*, and to the order of *triandria*; and in the natural system ranged under the 3d order, *Calamaria*. The amentum of the

Spar,  
Sparganium.

parmar-  
nia  
||  
Sparta.

male flower is roundish, the calyx is triphyllous, and there is no corolla. The amentum of the female flower resembles that of the male. The stigma is bioid; the fruit is a dry berry containing one seed. There are two species, the *erectum* and *natans*, both of them natives of Great Britain and Ireland. 1. The *Erectum*, great bur-reed, has a stem two or three feet high, erect, firm and branched; the lower leaves are triangular, the upper ones plain. The male heads are much smaller than the female. This species flowers in July, and is frequent on the banks of rivers and lakes and near stagnant waters. 2. The *Natans*, floating or little bur-reed, has a stalk about two feet long. The leaves float, are about a foot long, one-fourth of an inch wide at the base, and one-eighth in the middle, and end in a point. The male spiciferules are generally three, and all sessile; the female are commonly three, the two lower being supported on peduncles, the uppermost sessile. It flowers in July, and grows in pools and lakes, but is rare.

SPARMANNIA, in botany; a genus of plants belonging to the class of *polyandria*, and to the order of *monogynia*. The corolla consists of four petals, and is bent back; the nectaria are numerous, and swell a little; the calyx is quadriphyllous; the capsule is angulated, quinquelocular and echinated. There is only one species, the *Africana*.

SPARROW, in ornithology. See FRINGILLA.

SPARROW-HAWK, in ornithology. See FALCO.

SPARROW-GRASS. See ASPARAGUS.

SPARRY-ACID. See FLUOR-ACID, and CHEMISTRY-Index.

SPARTA, or LACEDÆMON, the capital of the country of Laconia in Greece, an ancient and most renowned state, the inhabitants of which have been in all ages celebrated for the singularity of their laws and character.—The history of Sparta for many ages is entirely fabulous; and the authentic accounts commence only with the celebrated lawgiver Lycurgus, who flourished about 870 B. C. See the article LYCURGUS.

The history of Sparta mostly fabulous till the time of Lycurgus.

After his death, the first important transaction which we find mentioned in the Spartan history is the Messenian war, which commenced in the year 752 B. C. and ended in the total reduction of the Messenian territory, as related under the article MESSENIA. During this period, according to some authors, a great change took place in the government of Sparta. This was the creation of the ephori, which is ascribed to one of the kings named *Theopompus*. This man perceiving that there was a necessity for leaving magistrates to execute the laws, when the kings were obliged to be in the field, appointed the magistrates above mentioned, who afterwards made so great a figure in the state (see EPHORI). One great privilege of the ephori was, that they did not rise up at the presence of the kings, as all other magistrates did: another was, that if the kings offended against the laws, the ephori took cognizance of the offence, and inflicted a suitable punishment. From the first election of the ephori, the year was denominated, as at Athens, from the first election of the archons.

The conquest of Messenia gave Sparta the superiority over the rest of the states, excepting only that of Athens, which for a long time continued to be a very troublesome rival; but the contests between these two rival states have been so fully related under the article ATHENS, that nothing more is requisite to be added in the

place.—In the time of the Persian war, Leonidas the Spartan king distinguished himself in such a manner, as to become the admiration not only of that but of every succeeding age. It being resolved in a general council to defend the straits of Thermopylae against the Persians, 7000 foot were put under the command of Leonidas; of whom, however, only 30 were Spartans. Leonidas did not think it practicable to defend the pass against such multitudes as the Persian king commanded; and therefore privately told his friends, that his design was to devote himself to death for his country.

Xerxes advancing near the straits, was strangely surpris'd to find that the Greeks were resolv'd to dispute his passage; for he had always flatter'd himself, that on his approach they would betake themselves to flight, and not attempt to oppose his innumerable forces. However, Xerxes still entertaining some hopes of their flight, waited four days without undertaking any thing, on purpose to give them time to retreat. During this time, he us'd his utmost endeavours to gain and corrupt Leonidas, promising to make him master of all Greece if he would come over to his interest. His offers being reject'd with contempt and indignation, the king order'd him by an herald to deliver up his arms. Leonidas, in a style and with a spirit truly laconical, answer'd, "Come thyself, and take them." Xerxes, at this reply, transport'd with rage, command'd the Medes and Cissians to march against them, take them all alive, and bring them to him in fetters. The Medes, not able to stand the shock of the Greeks, soon betook themselves to flight: and in their room Hydarnes was order'd to advance with that body which was call'd *Immortal*, and consist'd of 10,000 chosen men; but when these came to close with the Greeks, they succeeded no better than the Medes and Cissians, being oblig'd to retire with great slaughter. The next day the Persians, reflecting on the small number of their enemies, and supposing so many of them to be wounded that they could not possibly maintain a second fight, resolv'd to make another attempt; but could not by any efforts make the Greeks give way: on the contrary, they were themselves put to a shameful flight. The valour of the Greeks exerted itself on this occasion in a manner so extraordinary, that Xerxes is said to have three times leaped from his throne, apprehending the entire destruction of his army.

Xerxes having lost all hopes of forcing his way through troops that were determin'd to conquer or die, was extremely perplexed and doubtful what measures he should take in this posture of affairs; when one Epialtes, in expectation of a great reward, came to him, and discover'd a secret passage to the top of the hill which overlooked and command'd the Spartan forces. The king immediately order'd Hydarnes thither with his select body of 10,000 Persians; who marching all night, arriv'd at break of day, and possess'd themselves of that advantageous post. The Phocæans, who defend'd this pass, being overpower'd by the enemy's numbers, retir'd with precipitation to the very top of the mountain, prepar'd to die gallantly. But Hydarnes neglecting to pursue them, march'd down the mountain with all possible expedition, in order to attack those who defend'd the straits in the rear. Leonidas being now appriz'd that it was impossible to bear up against the enemy, oblig'd the rest of his allies to retire: but he staid himself, with the Thespians, Thebans, and 300



<sup>Sparta.</sup> Lacedemonians, all resolved to die with their leader; who being told by the oracle, that either Sparta should be destroyed or the king lose his life, determined without the least hesitation to sacrifice himself for his country. The Thebans indeed remained against their inclination, being detained by Leonidas as hostages; for they were suspected to favour the Persians. The Thebians, with their leader Demophilus, could not by any means be prevailed upon to abandon Leonidas and the Spartans. The augur Megistias, who had foretold the event of this enterprize, being pressed by Leonidas to retire, sent home his only son; but remained himself, and died by Leonidas. Those who staid did not feed themselves with any hopes of conquering or escaping, but looked upon Thermopylæ as their graves; and when Leonidas, exhorting them to take some nourishment, said, that they should all sup together with Pluto, with one accord they set up a shout of joy, as if they had been invited to a banquet.

Xerxes, after pouring out a libation at the rising of the sun, began to move with the whole body of his army, as he had been advised by Epialtes. Upon their approach, Leonidas advanced to the broadest part of the passage, and fell upon the enemy with such undaunted courage and resolution, that the Persian officers were obliged to stand behind the divisions they commanded, in order to prevent the flight of their men. Great numbers of the enemy falling into the sea, were drowned; others were trampled under foot by their own men, and a great many killed by the Greeks; who knowing they could not avoid death upon the arrival of those who were advancing to fall upon their rear, exerted their utmost efforts. In this action fell the brave Leonidas; which Abrocomes and Hyperanthes, two of the brothers of Xerxes, observing, advanced with great resolution to seize his body, and carry it in triumph to Xerxes. But the Lacedemonians, more eager to defend it than their own lives, repulsed the enemy four times, killed both the brothers of Xerxes, with many other commanders of distinction, and rescued the body of their beloved general out of the enemy's hands. But in the mean time, the army that was led by the treacherous Epialtes, advancing to attack their rear, they retired to the narrowest place of the passage, and drawing all together except the Thebans, posted themselves on a rising ground. In this place they made head against the Persians, who poured in upon them on all sides, till at length, not vanquished, but oppressed and overwhelmed by numbers, they all fell, except one who escaped to Sparta, where he was treated as a coward and traitor to his country; but afterwards made a glorious reparation in the battle of Platæa, where he distinguished himself in an extraordinary manner. Some time after, a magnificent monument was erected at Thermopylæ, in honour of those brave defenders of Greece, with two inscriptions; the one general, and relating to all those who died on this occasion, importing, that the Greeks of Peloponnesus, to the number only of 4000, made head against the Persian army, consisting of 3,000,000. The other related to the Spartans in particular, and was composed by the poet Simonides, to this purport: "Go, passenger, and acquaint the Spartans that we died here in obedience to their just commands." At those tombs a funeral oration was yearly pronounced in honour of the dead heroes, and public games performed with great solemnity,

wherein none but the Lacedemonians and Thebians had any share, to show that they alone were concerned in the glorious defence of Thermopylæ.

At the end of the 77th Olympiad, a most dreadful earthquake happened at Sparta, in which, according to Diodorus, 20,000 persons lost their lives; and Plutarch tells us, that only five houses were left standing in the whole city. On this occasion the Helotes or slaves, whom the Spartans had all along treated with the utmost cruelty, attempted to revenge themselves, by taking up arms, and marching directly to the ruins of the city, in hopes of cutting off at once those who had escaped from the earthquake. But in this they were prevented by the prudence of the Spartan king Archidamus; for he, observing that the citizens were more desirous of preserving their effects than taking care of their own lives, caused an alarm to be sounded, as if he had known that an enemy was at hand. On this the citizens armed themselves in haste with such weapons as they could come at; and having marched a little way from the city, met the Helotes, whom they soon compelled to retire. The latter, however, knowing that they had now no mercy to expect from those who had already treated them with such cruelty, resolved to defend themselves to the last. Having therefore seized a sea-port town in Messenia, they from thence made such incursions into the Spartan territories, that they compelled those imperious masters to ask assistance from the Athenians. This was immediately granted; but when the Spartans saw that the skill of the Athenians in besieging towns was much greater than their own, they became jealous, and dismissed their allies, telling them, that they had now no farther occasion for their services. On this the Athenians left them in disgust; and as the Helotes and Messenians did not choose to come to an engagement with a Spartan army in the field, but took shelter in their fortified places, the war was protracted for ten years and upwards. At last the Helotes were reduced to their former misery; and the Messenians were obliged to leave Peloponnesus, on pain of being made slaves also. These poor people were then received by the Athenians, who granted them Naupactus for their residence, and afterwards brought them back to a part of their own country, from whence in the course of the Peloponnesian war they had driven the Spartans.

In the year 431 B. C. the Peloponnesian war commenced; of which a full account has been given under the article ATTICA, n<sup>o</sup> 116—165. It ended most unfortunately for the Athenians; their city being taken and dismantled, as related in the article above-mentioned. Thus were the Spartans raised to the highest pitch of glory; and, in the reign of Agesilaus, they seemed to be on the point of subverting the Persian empire, as related under the article PERSIA, n<sup>o</sup> 34. But here their good fortune and their views of empire were suddenly checked. Agesilaus had carried on the war in Asia with the greatest success, and as he would hearken to no terms of accommodation, a Persian governor named *Tithraustes*, having first attempted in vain to bribe the king, dispatched Timocrates the Rhodian with 50 talents into Greece, in order to try whether he could there meet with any persons less incorruptible than the Spartan monarch. This agent found many who inclined to accept his offers; particularly in Thebes, Co-

<sup>Sparta.</sup>  
6  
A dreadful earthquake in Sparta.

7  
War with the Helotes.

8  
With the Athenians and Persians.

Sparta.  
9  
A general  
combination  
against  
Sparta.

rinth, and Argos. By distributing the money in a proper manner, he inflamed the inhabitants of these three cities against the Spartans; and of all others the Thebans came into his terms with the greatest readiness. They saw that their antagonists would not of their own accord break with any of the states of Greece, and did not choose to begin the war themselves, because the chiefs of the Persian faction were unwilling to be accountable for the event. For this reason they persuaded the Locrians to invade a small district which lay in dispute betwixt the Phocians and themselves. On this the Phocians invaded Locris; the Locrians applied to the Thebans, and the Phocians to the Spartans. The latter were glad of an opportunity of breaking with the Thebans; but met with a much warmer reception than they expected. Their old general Lyfander, who had reduced Athens, was defeated and killed, with the loss of 1000 men: on which disaster Agefilus was recalled, and obliged to relinquish all hopes of conquering the Persians. His return changed the fortune of the war so much, that all the states began to grow weary of a contest from which nobody derived any advantage except the king of Persia. In a short time a treaty was concluded, known in history by the name of the *peace of Antalcidas*. The terms of this treaty were highly disadvantageous and dishonourable to the Greeks; for even the Spartans, though successful in Greece, had lost a great battle at sea with the Persian fleet under Conon the Athenian, which entirely broke their power in Asia.

10  
Peace of  
Antalcidas.

§ See *Per-*  
*sea*, n<sup>o</sup> 37.

By the peace of Antalcidas, the government of Bœotia was taken from the Thebans, which they had for a long time enjoyed; and by this they were so much provoked, that at first they absolutely refused to accede to the treaty; but as Agefilus made great preparations to invade them, they thought proper at last to comply. However, it was not long before a new war commenced, which threatened the total subversion of the Spartan state. As, by the peace of Antalcidas, the king of Persia had in a manner guaranteed the sovereignty of Greece to Sparta, this republic very soon began to exercise its power to the utmost extent. The Mantineans were the first who felt the weight of their resentment, although they had been their allies and confederates. In order to have a pretence for making war against them, they commanded them to quit their city, and to retire into five old villages which, they said, had served their forefathers, and where they would live in peace themselves, and give no umbrage to their neighbours. This being refused, an army was sent against them to besiege their city. The siege was continued through the summer with very little success on the part of the Spartans; but having during the winter season dammed up the river on which the city stood, the water rose to such an height, as either to overflow or throw down the houses; which compelled the Mantineans to submit to the terms prescribed to them, and to retire into the old villages. The Spartan vengeance fell next on the Phliasians and Olynthians, whom they forced to come into such measures as they thought proper. After this they fell on the Thebans; and, by attempting to seize on the Piræum, drew the Athenians also into the quarrel. But here their career was stopped: the Thebans had been taught the art of war by Chabrias the Athenian; so that even Agefilus himself took the command

11  
Hostilities  
recommen-  
ced.

of the Spartan army in vain. At sea they were defeated by Timotheus the son of Conon; and by land the battle of Leuctra put an end to the superiority which Sparta had held over Greece for near 500 years. See LEUCTRA.

Sparta.  
12  
The pow-  
er of Sparta  
entirely  
broken.

After this dreadful defeat, the Spartans had occasion to exert all their courage and resolution. The women and nearest relations of those who were killed in battle, instead of spending their time in lamentations, shook each other by the hand, while the relations of those who had escaped from the battle hid themselves among the women; or if they were obliged to go abroad, they appeared in tattered clothes, with their arms folded, and their eyes fixed on the ground. It was a law among the Spartans, that such as fled from battle should be degraded from their honours, should be constrained to appear in garments patched with divers colours, to wear their beards half-shaved, and to suffer any to beat them who pleased, without resistance. At present, however, this law was dispensed with; and Agefilus by his prudent conduct kept up the spirits of the people, at the same time that by his skill in military affairs he checked the progress of the enemy. Yet, during the lifetime of Epaminondas the Theban general, the war went on greatly to the disadvantage of the Spartans; but he being killed at the battle of Mantinea, all parties became quickly desirous of peace. Agefilus did not long survive; and with him, we may say, perished the glory of Sparta. Soon after this all the states of Greece fell under the power of Alexander the Great; and the Spartans, as well as the rest, having become corrupt, and lost their martial spirit, became a prey to domestic tyrants, and to foreign invaders. They maintained their ground, however, with great resolution against the celebrated Pyrrhus king of Epirus; whom they repulsed for three days successively, though not without assistance from one of the captains of Antigonus. Soon after this one of the kings of Sparta named *Agis*, perceiving the universal degeneracy that had taken place, made an attempt to restore the laws and discipline of Lycurgus, by which he supposed the state would be restored to its former glory. But though at first he met with some appearance of success, he was in a short time tried and condemned by the ephori as a traitor to his country. Cleomenes, however, who ascended the throne in 216 B. C. accomplished the reformation which Agis had attempted in vain. He suppressed the ephori; cancelled all debts; divided the lands equally, as they had been in the time of Lycurgus; and put an end to the luxury which prevailed among the citizens. But at last he was overborne by the number of enemies which surrounded him; and being defeated in battle by Antigonus, he fled to Egypt, where he put an end to his own life. With him perished every hope of retrieving the affairs of Sparta: the city for the present fell into the hands of Antigonus; after which a succession of tyrants took place; till at last all disturbances were ended by the Romans, who reduced MACEEDON and GREECE to provinces of their empire, as has been related under these articles.

13  
Agis and  
Cleomenes  
attempt  
vain to r-  
store it.

It remains now only to say something concerning the character, manners, and customs of the Spartans, which, as they were founded on the laws of Lycurgus, may best be learned from a view of these laws.

14  
Institu-  
tion  
of Lycur-  
gus.

The institutions of Lycurgus were divided into 12 tables,

Sparta.  
15  
His laws  
concerning  
religion.

tables. The first comprehended such of the Spartan laws as regarded religion. The statues of all the gods and goddesses were represented in armour, even to Venus herself; the reason of which was, that the people might conceive a military life the most noble and honourable, and not attribute, as other nations did, sloth and luxury to the gods. As to sacrifices, they consisted of things of very small value; for which Lyeurgus himself gave this reason, That want might never hinder them from worshipping the gods. They were forbidden to make long or rash prayers to the heavenly powers, and were enjoined to ask no more than that they might live honestly and discharge their duty. Graves were permitted to be made within the bounds of the city, contrary to the custom of most of the Greek nations; nay, they buried close by their temples, that all degrees of people might be made familiar with death, and not conceive it such a dreadful thing as it was generally esteemed elsewhere: on the same account, the touching of dead bodies, or assisting at funerals, made none unclean, but were held to be as innocent and honourable duties as any other. There was nothing thrown into the grave with the dead body; magnificent sepulchres were forbidden; neither was there so much as an inscription, however plain or modest, permitted. Tears, sighs, outcries, were not allowed in public, because they were thought dishonourable in Spartans, whom their lawgiver would have to bear all things with equanimity. Mourning was limited to 11 days; on the 12th the mourner sacrificed to Ceres, and threw aside his weeds. In favour of such as were slain in the wars, however, and of women who devoted themselves to a religious life, there was an exception allowed as to the rules before-mentioned; for such had a short and decent inscription on their tombs. When a number of Spartans fell in battle, at a distance from their country, many of them were buried together under one common tomb; but if they fell on the frontiers of their own state, then their bodies were carefully carried back to Sparta, and interred in their family-sepulchres.

16  
Concerning  
the division  
of land.

II. Lyeurgus divided all the country of Laconia into 30,000 equal shares: the city of Sparta he divided into 9000, as some say; into 6000, as others say; and, as a third party will have it, into 4500. The intent of the legislator was, that property should be equally divided amongst his citizens, so that none might be powerful enough to oppress his fellows, or any be in such necessity, as to be therefrom in danger of corruption. With the same view he forbade the buying or selling these possessions. If a stranger acquired a right to any of these shares, he might quietly enjoy it, provided he submitted to the laws or the republic. The city of Sparta was unwall'd; Lyeurgus trusting it rather to the virtue of its citizens than to the art of masons. As to the houses, they were very plain; for their ceilings could only be wrought by the axe, and their gates and doors only by the saw; and their utensils were to be of a like stamp, that luxury might have no instruments among them.

17  
Of the city  
zou, chil-  
dren, &c.

III. The citizens were to be neither more nor less than the number of city lots; and if at any time there happened to be more, they were to be led out in colonies. As to children, their laws were equally harsh and unreasonable; for a father was directed to carry his new-born infant to a certain place, where the gravest

men of his tribe looked upon the infant; and if they perceived its limbs straight, and thought it had a wholesome look, then they returned it to its parents to be educated; otherwise it was thrown into a deep cavern at the foot of the mountain Taygetus. This law seems to have had one very good effect, viz. making women very careful, when they were with child, of either eating, drinking, or exercising, to excess: it made them also excellent nurses; for which they were in mighty request throughout Greece. Strangers were not allowed to reside long in the city, that they might not corrupt the Spartans by teaching them new customs. Citizens were also forbid to travel, for the same reason, unless the good of the state required it. Such as were not bred up in their youth according to the law, were not allowed the liberty of the city, because they held it unreasonable, that one who had not submitted to the laws in his youth should receive the benefit of them when a man. They never preferred any stranger to a public office; but if at any time they had occasion for a person not born a Spartan, they first made him a citizen, and then preferred him.

Sparta.

IV. Celibacy in men was infamous, and punished in a most extraordinary manner; for the old bachelor was constrained to walk naked, in the depth of winter, through the market-place: while he did this, he was obliged to sing a song in disparagement of himself; and he had none of the honours paid him which otherwise belonged to old age, it being held unreasonable, that the youth should venerate him who was resolv'd to leave none of his progeny behind him, to reverence them when they grew old in their turn. The time of marriage was also fixed; and if a man did not marry when he was of full age, he was liable to an action; as were such also as married above or below themselves. Such as had three children had great immunities; such as had four were free from all taxes whatsoever. Virgins were married without portions; because neither want should hinder a man, nor riches induce him, to marry contrary to his inclinations. When a marriage was agreed on, the husband committed a kind of rape upon his bride. Husbands went for a long time, secretly and by stealth, to the beds of their wives, that their love might not be quickly and easily extinguished. Husbands were allowed to lend their wives; but the kings were forbid to take this liberty. Some other laws of the like nature there were, which as they were evidently against modesty, so they were far from producing the end for which Lyeurgus designed them: since, though the men of Sparta were generally remarkable for their virtue, the Spartan women were as generally decried for their boldness and contempt of decency.

18  
Of celibacy  
and mar-  
riage.

V. It was the care of Lyeurgus, that, from their very birth, the Lacedemonians should be inured to conquer their appetites: for this reason he directed, that nurses should accustom their children to spare meals, and now and then to fasting; that they should carry them, when 12 or 13 years old, to those who should examine their education, and who should carefully observe whether they were able to be in the dark alone, and whether they had got over all other follies and weaknesses incident to children. He directed, that children of all ranks should be brought up in the same way; and that none should be more favoured in food than another, that they might not, even in their

19  
Education  
of their  
children.  
infancy,

<sup>Sparta.</sup> infancy, perceive any difference between poverty and riches, but consider each other as equals, and even as brethren, to whom the same portions were assigned, and who, through the course of their lives, were to fare alike: the youths alone were allowed to eat flesh; older men ate their black broth and pulse; the lads slept together in chambers, and after a manner somewhat resembling that still in use in Turkey for the Janizaries: their beds, in the summer, were very hard, being composed of the reeds plucked by the hand from the banks of the Eurotas: in winter their beds were softer, but by no means downy, or fit to indulge immoderate sleep. They ate altogether in public; and in case any abtained from coming to the tables, they were fined. It was likewise strictly forbidden for any to eat or drink at home before they came to the common meal; even then each had his proper portion, that every thing might be done there with gravity and decency. The black broth was the great rarity of the Spartans, which was composed of salt, vinegar, blood, &c. so that, in our times, it would be esteemed a very unfavoury soup. If they were moderate in their eating, they were so in their drinking also; thirst was the sole measure thereof; and never any Lacedemonian thought of drinking for pleasure: as for drunkenness, it was both infamous and severely punished; and, that young men might perceive the reason, slaves were compelled to drink to excess, that the beastliness of the vice might appear. When they retired from the public meal, they were not allowed any torches or lights, because it was expected, that men who were perfectly sober should be able to find their way in the dark: and, besides, it gave them a facility of marching without light; a thing wonderfully useful to them in time of war.

<sup>20</sup>  
Of their  
diet, cloth-  
ing, &c.

VI. As the poor ate as well as the rich, so the rich could wear nothing better than the poor: they neither changed their fashion nor the materials of their garments; they were made for warmth and strength, not for gallantry and show: and to this custom even their kings conformed, who wore nothing gaudy in right of their dignity, but were contented that their virtue should distinguish them rather than their clothes. The youths wore a tunic till they were twelve years old; afterwards they had a cloak given them, which was to serve them a year: and their clothing was, in general, so thin, that a Lacedemonian vest became proverbial. Boys were always used to go without shoes; but when they grew up, they were indulged with them, if the manner of life they led required it; but they were always inured to run without them, as also to climb up and slip down steep places with bare feet: nay, the very shoe they used was of a particular form, plain and strong. Boys were not permitted to wear their hair; but when they arrived at the age of twenty, they suffered their hair and beard to grow. Baths and anointing were not much in use among the Lacedemonians; the river Eurotas supplied the former, and exercise the latter. In the field, however, their sumptuary laws did not take place so strictly as in the city; for when they went to war, they wore purple habits; they put on crowns when they were about to engage the enemy; they had also rings, but they were of iron; which metal was most esteemed by this nation. Young women wore their vests or jerkins only to their knees, or, as some think, not quite so low; a custom which both

Greek and Roman authors censure as indecent. Gold, precious stones, and other costly ornaments, were permitted only to common women; which permission was the ironell prohibition to women of virtue, or who affected to be thought virtuous. Virgins went abroad without veils, with which married women, on the contrary, were always covered. In certain public exercises, in which girls were admitted as well as boys, they were both obliged to perform naked. Plutarch apologises for this custom, urging, that there could be no danger from nakedness to the morals of youth whose minds were fortified and habituated to virtue. One of Lycurgus's principal views in his institutions, was to eradicate the very seeds of civil dissension in his republic. Hence proceeded the equal division of estates enjoined by him; hence the contempt of wealth, and the neglect of other distinctions, as particularly birth, he considering the people of his whole state as one great family; distinctions which, in other commonwealths, frequently produce tumults and confusions that shake their very foundation.

VII. Though the Spartans were always free, yet it <sup>21</sup> was with this restriction, that they were subservient to their own laws, which bound them as strictly in the city as soldiers, in other states, were bound by the rules of war in the camp. In the first place, strict obedience to their superiors was the great thing required in Sparta. This they looked upon as the very basis of government; without which neither laws nor magistrates availed much. Old age was an indubitable title to honour in Sparta: to the old men the youth rose up whenever they came into any public place; they gave way to them when they met them in the streets, and were silent whenever their elders spoke. As all children were looked upon as the children of the state, so all the old men had the authority of parents: they reprehended whatever they saw amiss, not only in their own, but in other people's children; and by this method Lycurgus provided, that as youth are everywhere apt to offend, they might be nowhere without a monitor. The laws went still further: if an old man was present where a young one committed a fault, and did not reprove him, he was punished equally with the delinquent. Amongst the youths there was one of their own body, or at most two years older than the rest, who was styled *iren*: he had authority to question all their actions, to look strictly to their behaviour, and to punish them if they did amiss; neither were their punishments light, but, on the contrary, very severe; whereby the youth were made hardy, and accustomed to bear stripes and rough usage. Silence was a thing highly commended at Sparta, where modesty was held to be a most becoming virtue in young people; nor was it restrained only to their words and actions, but to their very looks and gestures; Lycurgus having particularly directed, that they should look forward, or on the ground, and that they should always keep their hands within their robes. A stupid inconsiderate person, one who would not listen to instruction, but was careless of whatever the world might say of him, the Lacedemonians treated as a scandal to human nature; with such an one they would not converse, but threw him off as a rotten branch and worthless member of society.

VIII. The plainness of their manners, and their be- <sup>22</sup> lieving so very much addicted to war, made the Lacedemonians

*Sparta.* Spartans less fond of the sciences than the rest of the Greeks. A soldier was the only reputable profession in Sparta; a mechanic or husbandman was thought a low fellow. The reason of this was, that they imagined professions which required much labour, some constant posture, being continually in the house, or always about a fire, weakened the body and depressed the mind: whereas a man brought up hardily, was equally fit to attend the service of the republic in time of peace, and to fight its battles when engaged in war. Such occupations as were necessary to be followed for the benefit of the whole, as husbandry, agriculture, and the like, were left to their slaves the Helotes; but for curious arts, and such as served only to luxury, they would not so much as suffer them to be introduced in their city; in consequence of which, rhetoricians, augurs, bankers, and dealers in money, were shut out. The Spartans admitted not any of the theatrical diversions among them; they would not bear the representation of evil even to produce good; but other kinds of poetry were admitted, provided the magistrates had the perusal of pieces before they were handed to the public.

Above all things, they affected brevity of speech, and accustomed their children, from their very infancy, never to express themselves in more words than were strictly necessary; whence a concise and sententious oratory is to this day styled *Laconic*. In writing they used the same conciseness; of which we have a signal instance in a letter of Archidamus to the Eleans, when he understood that they had some thoughts of assisting the Arcadians. It ran thus: "Archidamus to the Eleans: It is good to be quiet." And therefore Epaminondas thought that he had reason to glory in having forced the Spartans to abandon their monosyllables, and to lengthen their discourses.

The greatest part of their education consisted in giving their youth right ideas of men and things: the men or master proposed questions, and either commended the answers that were made him, or reproved such as answered weakly. In these questions, all matters, either of a trivial or abstruse nature, were equally avoided; and they were confined to such points as were of the highest importance in civil life; such as, Who was the best man in the city? Wherein lay the merit of such an action? and, Whether this or that hero's fame was well-founded? Harmless raillery was greatly encouraged; and this, joined to their short manner of speaking, rendered laconic replies universally admired.

Music was much encouraged; but in this, as in other things, they adhered to that which had been in favour with their ancestors; nay, they were so strict therein, that they would not permit their slaves to learn either the tune or the words of their most admired odes; or, which is all one, they would not permit them to sing them if they had learned them. Though the youth of the male sex were much cherished and beloved, as those that were to build up and continue the future glory of the state, yet in Sparta it was a virtuous and modest affection, untinged with that sensuality which was so scandalous at Athens. The good effects of this part of Lycurgus's institutions were seen in the union that reigned among his citizens; and which was so extraordinary, that even in cases of competition, it was hardly known that rivals bore ill-will to each other; but,

on the contrary, their love to the same person begat a secondary friendship among themselves, and united them in all things which might be for the benefit of the person beloved.

Some authors have accused this great lawgiver of encouraging theft in his institutions; which, they say, was not held scandalous among the Spartans, if it were so dexterously managed as that the person was not detected in it. But this is certain, and seems to be a strong contradiction of the heinous charge, that when a theft was discovered, it was punished with the utmost severity: a person even suspected of it would endure the heaviest punishments rather than acknowledge it, and be branded with so base a crime.

IX. The exercises instituted by law fall under the ninth table. In these all the Greeks were extremely careful, but the Lacedaemonians in a degree beyond the rest; for if a youth, by his corpulence, or any other means, became unfit for these exercises, he underwent public contempt at least, if not banishment.—Hunting was the usual diversion of their children; nay, it was made a part of their education, because it had a tendency to strengthen their limbs, and to render those who practised it supple and fleet: they likewise bred up dogs for hunting with great care. They had a kind of public dances, in which they exceedingly delighted, and which were common alike to virgins and young men: indeed, in all their sports, girls were allowed to divert themselves with the youths; inasmuch that, at darting, throwing the quoit, pitching the bar, and such-like robust diversions, the women were as dexterous as the men. For the manifest oddity of this proceeding, Lycurgus assigned no other reason, than that he sought to render women, as well as men, strong and healthy, that the children they brought forth might be so too. Violent exercises, and a laborious kind of life, were only enjoined the youth; for when they were grown up to mens estate, that is, were upwards of 30 years old, they were exempted from all kinds of labour, and employed themselves wholly either in affairs of state or in war. They had a method of whipping, at a certain time, young men in the temple of Diana, and about her altar; which, however palliated, was certainly unnatural and cruel. It was esteemed a great honour to sustain these flagellations without weeping, groaning, or showing any sense of pain; and the thirst of glory was so strong in these young minds, that they very frequently suffered death without shedding a tear or breathing a sigh. A desire of overcoming all the weaknesses of human nature, and thereby rendering his Spartans not only superior to their neighbours, but to their species, runs through many of the institutions of Lycurgus; which principle, if well attended to, thoroughly explains them, and without attending to which it is impossible to give any account of them at all.

X. Gold and silver were, by the constitutions of Money, Lycurgus, made of no value in Sparta. He was so well apprized of the danger of riches, that he made the very possession of them venal; but as there was no living without some sort of money, that is, some common measure or standard of the worth of things, he directed an iron coinage, whereby the Spartans were supplied with the useful money, and at the same time had no temptation to covetousness afforded them: for a very small sum was sufficient to load a couple of horses, and

Sparta

23  
Exercises

14

&amp;c.

*Sparta.* a great one must have been kept in a barn or warehouse. The coming in of all foreign money was also prohibited, that corruption might not enter under the name of commerce. The most ancient method of dealing, viz. by barter, or exchange of one commodity for another, was preserved by law in Sparta long after it had been out of date everywhere else. Interest was a thing forbidden in the Spartan commonwealth; where they had also a law against alienation of lands, accepting presents from foreigners, even without the limits of their own country, and when their authority and character might well seem to excuse them.

25  
Courts of  
Justice.

XI. Such of the laws of Sparta as related to courts of justice may be brought under the 11th table. Thirty years must have passed over the head of him who had a right to concern himself in juridical proceedings. Young men were thought unfit for them; and it was even held indecent, and of ill report, for a man to have any fondness for law-suits, or to be busying himself at the tribunals, when he had no affairs there of his own. By these rules Lycurgus thought to shut out litigiousness, and to prevent that multiplicity of suits which is always scandalous in a state. As young people were not permitted to inquire about the laws of other countries, and as they were hindered from hearing judicial proceedings in their courts, so they were likewise forbidden to ask any questions about, or to endeavour to discover, the reasons of the laws by which themselves were governed. Obedience was their duty; and to that alone they would have them kept. Men of abandoned characters, or who were notoriously of ill fame, lost all right of giving their votes in respect of public affairs, or of speaking in public assemblies; for they would not believe that an ill man in private life could mean his country better than he did his neighbour.

26  
Military  
service.

XII. Till a man was 30 years old, he was not capable of serving in the army, as the best authors agree; though some think that the military age is not well ascertained by ancient writers. They were forbidden to march at any time before the full-moon; the reason of which law is very hard to be discovered, if indeed it had any reason at all, or was not rather founded on some superstitious opinion, that this was a more lucky conjuncture than any other. They were likewise forbidden to fight often against the same enemy; which was one of the wisest maxims in the political system of Lycurgus: and Agefilaus, by offending against it, destroyed the power of his country, and lost her that authority which for many ages she maintained over the rest of Greece; for, by continually warring against the Thebans, to whom he had an inveterate hatred, he at last beat them into the knowledge of the art of war, and enabled them, under the command of Epaminondas, to maintain for a time the principality of Greece. Maritime affairs they were forbidden to meddle with, though the necessity of things compelled them, in process of time, to transgress this institution, and by degrees to transfer to themselves the dominion of the sea as well as of the land: but, after the Peloponnesian war, they again neglected naval affairs, from a persuasion that sailors and strangers corrupted those with whom they conversed. As they never fortified Sparta, they were not ready to undertake sieges: fighting in the field was their proper province, and, while they

could overcome their enemies there, they rightly conceived that nothing could hurt them at home. In time of war, they relaxed somewhat of their strict manner of living, in which they were singular. The true reason for this was, in all probability, that war might be less burdensome to them; for, as we have more than once observed, a strong desire to render them bold and warlike was the reigning passion of their legislator. They were forbidden to remain long encamped in the same place, as well to hinder their being surpris'd, as that they might be more troublesome to their enemies, by wasting every corner of their country. They slept all night in their armour; but their outguards were not allowed their shields, that, being unprovided of defence, they might not dare to sleep. In all expeditions they were careful in the performance of religious rites; and, after their evening-meal was over, the soldiers sung together hymns to their gods. When they were about to engage, the king sacrificed to the muses, that, by their assistance, they might be enabled to perform deeds worthy of being recorded to latest times. Then the army advanced in order to the sound of flutes, which played the hymn of Castor. The king himself sung the *præn*, which was the signal to charge. This was done with all the solemnity imaginable; and the soldiers were sure either to die or conquer: indeed they had no other choice; for if they fled they were infamous, and in danger of being slain, even by their own mothers, for disgracing their families. In this consisted all the excellency of the Spartan women, who, if possible, exceeded in bravery the men, never lamenting over husbands or sons, if they died honourably in the field; but deploring the shame brought on their house, if either the one or the other escaped by flight. The throwing away a shield also induced infamy; and, with respect to this, mothers, when they embraced their departing sons, were wont to caution them, that they should either return armed as they were, or be brought back so when they were dead; for, as we have observed, such as were slain in battle were nevertheless buried in their own country. When they made their enemies fly, they pursued no longer than till victory was certain; because they would seem to fight rather for the honour of conquering, than of putting their enemies to death. According to their excellent rules of war, they were bound not to spoil the dead bodies of their enemies; but in process of time, this, and indeed many other of their most excellent regulations, fell into desuetude. He who overcame by stratagem, offered up an ox to Mars; whereas he who conquered by force, offered up only a cock; the former being esteemed more manly than the latter. After 40 years service, a man was, by law, no longer required to go into the field; and consequently, if the military age was 30, the Spartans were not held invalids till they were 70.

SPARTIANUS (*Ælius*), a Latin historian, who wrote the lives of Adrian, Caracalla, and four other Roman emperors. He lived under the reign of Dioclesian, about the year 290.

SPARTIUM, Broom, in botany: A genus of plants belonging to the class of *diadelphia*, and order of *decandria*; and in the natural system arranged under the 32d order, *Papilionaceæ*. The stigma is longitudinal and woolly above: the filaments adhere to the germen. The calyx is produced downwards. There are 16 species, the

*Sparta*  
||  
*Spartium*

the scoparium, contaminatum, separium, junceum, monospermum, sphaerocarpon, purgans, aphyllum, scorpius, angulatum, patens, supranulium, complicatum, radiatum, cytisoides, and spinosum. All these, except the scoparium, are exotics, chiefly from Spain, Portugal, Italy, &c.—The *scoparium*, or common broom, has ternate solitary leaves; the branches angular, and without prickles.

*Uses.* The common broom is used for a variety of purposes. It has been of great benefit sometimes in dropical complaints. The manner in which Dr Cullen administered it was this: He ordered half an ounce of fresh broom tops to be boiled in a pound of water till one half of the water was evaporated. He then gave two table-spoonfuls of the decoction every hour till it operated both by stool and urine. By repeating these doses every day, or every second day, he says some dropics have been cured. Dr Mead relates, that a dropical patient, who had taken the usual remedies, and been tapped three times without effect, was cured by taking half a pint of the decoction of green broom tops, with a spoonful of whole mustard-seed every morning and evening. "An infusion of the seeds drunk freely (says Mr Withering) has been known to produce similar happy effects; but whoever expects these effects to follow in every dropical case, will be greatly deceived. I knew them succeed in one case that was truly deplorable; but out of a great number of cases in which the medicine had a fair trial, this proved a single instance."

The flower buds are in some countries pickled, and eaten as capers; and the seeds have been used as a bad substitute for coffee. The branches are used for making boms, and tanning leather. They are also used instead of thatch to cover houses. The old wood furnishes the cabinet maker with beautiful materials for veneering. The tender branches are in some places mixed with hops for brewing, and the macerated bark may be manufactured into cloth.

The *junceum*, or Spanish broom, grows naturally in the southern provinces of France, as well as other parts of the south of Europe. It grows in the poorest soils, on the steepest declivities of the hills, in a stony soil, where hardly any other plant could vegetate. In a few years it makes a vigorous shrub; insinuating its roots between the interstices of the stones, it binds the soil, and retains the small portion of vegetable earth scattered over these hills, which the autumnal rains would otherwise wash away. It is most easily raised from seed, which is usually sown in January, after the ground has received a slight dressing.

This shrub serves two useful purposes. Its branches yield a thread of which linen is made, and in winter support sheep and goats.

In manufacturing thread from broom, the youngest plants are cut in the month of August, or after harvest, and gathered together in bundles, which at first are laid in the sun to dry: they are then beaten with a piece of wood, washed in a river or pond, and left to steep in the water for about four hours. The bundles thus prepared are taken to a little distance from the water, and laid in a hollow place made for them, where they are covered with fern or straw, and remain thus to steep for eight or nine days; during which time, all that is necessary, is to throw a little water once a-day on the heap, without uncovering the broom. After this, the bundles are well washed, the green rind of the plant or

epidermis comes off, and the fibrous part remains; each bundle is then beaten with a wooden hammer upon a stone, to detach all the threads, which are at the same time carefully drawn to the extremity of the branches. After this operation, the faggots are untied, and spread upon stones or rocks till they are dry. The twigs must not be peeled till they are perfectly dry; they are then dressed with the comb, and the threads are separated according to their fineness, and spun upon a wheel.

The linen made of this thread serves various purposes in rural economy. The coarsest is employed in making sacks and other strong cloths for carrying grain or seeds. Of the finest is made bed, table, and body linen. The peasants in several places use no other, for they are unacquainted with the culture of hemp or flax, their soil being too dry and too barren for raising them. The cloth made with the thread of the broom is very useful; it is as soft as that made of hemp; and it would perhaps look as well as that made of flax if it was more carefully spun. It becomes white in proportion as it is steeped. The price of the finest thread, when it is sold, which seldom happens, is generally about a shilling a-pound.

The other use to which this broom is applied, is to maintain sheep and goats during winter. In the mountains of Lower Languedoc these animals have no other food from November to April, except the leaves of trees preserved. The branches of this broom therefore are a resource the more precious, that it is the only fresh nourishment which at that season the flocks can procure, and they prefer it at all times to every other plant. In fine weather the sheep are led out to feed on the broom where it grows; but in bad weather the shepherds cut the branches, and bring them to the sheep folds. There is, however, an inconvenience attending the continued use of this food. It generally produces inflammation in the urinary passages. But this inconvenience is easily removed by cooling drink, or a change of food, or by mixing the broom with something else.

It is perhaps needless to add, that it differs much from the broom that is common everywhere in the north of Europe, though this too, in many places, is used for food to cattle. Both of them produce flowers that are very much resorted to by bees, as they contain a great quantity of honey juice. And this should be another inducement to the cultivation of the Spanish broom.

SPARUS, GILTHEAD, in natural history; a genus of animals belonging to the class of *pisces*, and the order of *thoracici*. The fore-teeth and dog-teeth are very strong; the grinders are obtuse and thick set; the lips are folded over; there are five rays in the gill membrane; and the opercula are scaly: the body is compressed; the lateral line is crooked behind; and the pectoral fins are roundish.

Gmelin enumerates 39 species, of which only three are found in the British seas, the *pagrus*, *auratus*, and *dentatus*. 1. The *pagrus*, or sea bream, is of a reddish colour. The skin forms a sinus at the roots of the dorsal and anal fins. The body is broad; the back and belly ridged. There is only one dorsal fin. 2. The *auratus*, or gilt-bream. The head and sides of it are gilt, and there is a golden spot between the eyes shaped like a half-moon; there is also a black purple spot on the gills; and it weighs from eight lb. to ten lb. It is one

Spafn  
||  
Speaker.

of the *pisces faxatiles*, or fish that haunts deep waters on bold rocky shores. They feed chiefly on shell-fish, which they comminute with their teeth before they swallow; the teeth of this genus in particular being adapted for that purpose: the grinder are flat and strong, like those of certain quadrupeds: besides which there are certain bones in the lower part of the mouth that assist in grinding their food. They are but a coarse fish: they were known to the Romans, who did not esteem them unless they were fed with Lucrine oysters, as Martial informs us,

*Non omnis laudem pretiumque Aurata meretur,  
Sed qui solus erit concis Lucrina cibis.*

Lib. xiii. Ep. 90.

3. The *dentatus*, toothed sea-bream, is black above, and of a silvery appearance below. The eyes and gills are very large. There are nine rows of teeth in the lower jaw, and one in the upper.

In the account of Captain Cook's voyage published by Mr Foister, we are informed, that the gilthead are sometimes poisonous, owing to their feeding on certain species of the raja, which have an extremely acrid and stimulating property.

SPASM, a convulsion. See MEDICINE, n° 278.

SPATHA, in botany, a sheath; a species of calyx which bursts lengthwise, and protrudes a stalk supporting one or more flowers, which commonly have no perianthium or flower-cup.

SPATHACEÆ (from *spatha*, "a sheath"), the name of the ninth order in Linnæus's Fragments of a Natural Method consisting of plants whose flowers are protruded from a spatka or sheath. See BOTANY, p. 458.

SPATHELIA, in botany; a genus of plants belonging to the class of *pentandria*, and to the order of *trigynia*. The calyx is pentaphyllous; the petals are five; the capsule is three-edged and trilocular; the seeds solitary. There is only one species, the *simplex*, which is a native of Jamaica, and was introduced into the botanic gardens of this country in 1778 by Dr Wright, late of Jamaica.

SPAW. See SPA.

SPAWN, in natural history, the eggs of fishes or frogs. See FISH and RANA.

SPAVENTO. See SCANTO.

SPAVIN, in the manege, a disease in horses, being a swelling or stiffness, usually in the ham, occasioning a lameness. See FARRIERY, § 29.

SPAYING, or SPADING, the operation of castrating the females of several kinds of animals, as sows, bitches, &c. to prevent any further conception, and promote their fattening. It is performed by cutting them in the mid flank, on the left side, with a sharp knife or lancet, taking out the uterus, and cutting it off, and so stitching up the wound, anointing the part with tar, and keeping the animal warm for two or three days. The usual way is to make the incision aslope, two inches and a half long; that the fore-finger may be put in towards the back, to feel for the ovaries, which are two kernels as big as acorns on both sides of the uterus, one of which is drawn to the wound, and thus both taken out.

SPEAKER of the House of Commons, a member of the house elected by a majority of votes thereof to act

as chairman or president in putting questions, reading briefs, or bills, keeping order, reprimanding the refractory, adjourning the house, &c. See PARLIAMENT.

SPEAKING, the art or act of expressing one's thoughts in articulate sounds or words. See GRAMMAR, LANGUAGE, READING, and ORATORY, Part iv.

SPEAKING-Trumpet. See TRUMPET.

SPEAR-MINT, in botany. See MENTHA.

SPEAR-Word. See RANUNCULUS.

SPECIAL, something that is particular, or has a particular designation; from the Latin *species*, in opposition to the *general*, from *genus*.

SPECIES, in logic, a relative term, expressing an idea which is comprised under some general one called a *genus*. See LOGIC, n° 68.

SPECIES, in commerce, the several pieces of gold, silver, copper, &c. which having passed their full preparation and coinage, are current in public. See MONEY.

SPECIFIC, in philosophy, that which is peculiar to any thing, and distinguishes it from all others.

SPECIFICS, in medicine. By specifics is not meant such as infallibly and in all patients produce salutary effects. Such medicines are not to be expected, because the operations and effects of remedies are not formally inherent in them, but depend upon the mutual action and reaction of the body and medicine upon each other; hence the various effects of the same medicine in the same kind of disorders in different patients, and in the same patient at different times. By specific medicines we understand such medicines as are more infallible than any other in any particular disorder.

*Specific Gravity*, is a term much employed in the discussions of modern physics. It expresses the weight of any particular kind of matter, as compared with the weight of the same bulk of some other body of which the weight is supposed to be familiarly known, and is therefore taken for the standard of comparison. The body generally made use of for this purpose is pure water. See HYDROSTATICS, Sect. III.

The specific gravity of bodies is a very interesting question both to the philosopher and to the man of business. The philosopher considers the weights of bodies as measures of the number of material atoms, or the quantity of matter which they contain. This he does on the supposition that every atom of matter is of the same weight, whatever may be its sensible form. This supposition, however, is made by him with caution, and he has recourse to specific gravity for ascertaining its truth in various ways. This shall be considered by and by. The man of business entertains no doubt of the matter, and proceeds on it as a sure guide in his most interesting transactions. We measure commodities of various kinds by tons, pounds, and ounces, in the same manner as we measure them by yards, feet, and inches, or by bushels, gallons, and pints; nay, we do this with much greater confidence, and prefer this measurement to all others, whenever we are much interested to know the exact proportions of matter that bodies contain. The weight of a quantity of grain is allowed to inform us much more exactly of its real quantity of useful matter than the most accurate measure of its bulk. We see many circumstances which can vary the bulk of a quantity of matter, and these are frequently such as we cannot



not regulate or prevent; but we know very few indeed that can make any sensible change in this weight without the addition or abstraction of other matter. Even taking it to the summit of a high mountain, or from the equator to the polar region, will make no change in its weight as it is ascertained by the balance, because there is the same real diminution of weight in the pounds and ounces used in the examination.

Notwithstanding the unavoidable change which heat and cold make in the bulk of bodies, and the permanent varieties of the same kind of matter which are caused by different circumstances of growth, texture, &c. most kinds of matter have a certain constancy in the density of their particles, and therefore in the weight of a given bulk. Thus the purity of gold, and its degree of adulteration, may be inferred from its weight, it being purer in proportion as it is more dense. The density, therefore, of different kinds of tangible matter becomes characteristic of the kind, and a test of its purity; it marks a particular appearance in which matter exists, and may therefore be called, with propriety, SPECIFIC.

But this density cannot be directly observed. It is not by comparing the distances between the atoms of matter in gold and in water that we say the first is 19 times denser than the last, and that an inch of gold contains 19 times as many material atoms as an inch of water; we reckon on the equal gravitation of every atom of matter whether of gold or of water; therefore the weight of any body becomes the indication of its material density, and the weight of a given bulk becomes specific of that kind of matter, marking its kind, and even ascertaining its purity in this form.

It is evident that, in order to make this comparison of general use, the standard must be familiarly known, and must be very uniform in its density, and the comparison of bulk and density must be easy and accurate. The most obvious method would be to form, with all nicety, a piece of the standard matter of some convenient bulk, and to weigh it very exactly, and keep a note of its weight: then, to make the comparison of any other substance, it must be made into a mass of the same precise bulk, and weighed with equal care; and the most convenient way of expressing the specific gravity would be to consider the weight of the standard as unity, and then the number expressing the specific gravity is the number of times that the weight of the standard is contained in that of the other substance. This comparison is most easily and accurately made in fluids. We have only to make a vessel of known dimensions equal to that of the standard which we employ, and to weigh it when empty, and then when filled with the fluid. Nay, the most difficult part of the process, the making a vessel of the precise dimensions of the standard, may be avoided, by using some fluid substance for a standard. Any vessel will then do; and we may ensure very great accuracy by using a vessel with a slender neck, such as a phial or matras; for when this is filled to a certain mark in the neck, any error in the estimation by the eye will bear a very small proportion to the whole. The weight of the standard fluid which fills it to this mark being carefully ascertained, is kept in remembrance. The specific gravity of any other fluid is had by weighing the contents of this vessel when filled with it, and dividing the weight by the weight of the standard. The quotient is the specific gravity of the fluid. But in all other

cases this is a very difficult problem: it requires very nice hands, and an accurate eye, to make two bodies of the same bulk. An error of one hundredth part in the linear dimensions of a solid body makes an error of a 30th part in its bulk; and bodies of irregular shapes and friable substance, such as the ores of metals, cannot be brought into convenient and exact dimensions for measurement.

From all these inconveniences and difficulties we are freed by the celebrated Archimedes, who, from the principles of hydrostatics discovered or established by him, deduced the accurate and easy method which is now universally practised for discovering the specific gravity and density of bodies. (See ARCHIMEDES and HYDROSTATICS, n<sup>o</sup> 11.) Instead of measuring the bulk of the body by that of the displaced fluid (which would have been impossible for Archimedes to do with any thing like the necessary precision), we have only to observe the loss of weight sustained by the solid. This can be done with great ease and exactness. Whatever may be the bulk of the body, this loss of weight is the weight of an equal bulk of the fluid; and we obtain the specific gravity of the body by simply dividing its whole weight by the weight lost: the quotient is the specific gravity when this fluid is taken for the standard, even though we should not know the absolute weight of any given bulk of this standard. It also gives us an easy and accurate method of ascertaining even this fundamental point. We have only to form any solid body into an exact cube, sphere, or prism, of known dimensions, and observe what weight it loses when immersed in this standard fluid. This is the weight of the same bulk of the standard to be kept in remembrance; and thus we obtain, by the by, a most easy and accurate method for measuring the bulk or solid contents of any body, however irregular its shape may be. We have only to see how much weight it loses in the standard fluid; we can compute what quantity of the standard fluid will have this weight. Thus should we find that a quantity of sand, or a furze bush, loses 250 ounces when immersed in pure water, we learn by this that the solid measure of every grain of the sand, or of every twig and prickle of the furze, when added into one sum, amounts to the fourth part of a cubic foot, or to 432 cubic inches.

To all these advantages of the Archimedean method of ascertaining the specific gravity of bodies, derived from his hydrostatical doctrines and discoveries, we may add, that the immediate standard of comparison, namely, water, is, of all the substances that we know, the fittest for the purpose of an universal standard of reference. In its ordinary natural state it is sufficiently constant and uniform in its weight for every examination where the utmost mathematical accuracy is not wanted; all its variations arise from impurities, from which it may at all times be separated by the simple process of distillation: and we have every reason to think that when pure, its density, when of the same temperature, is invariable.

Water is therefore universally taken for the unit of that scale on which we measure the specific gravity of bodies, and its weight is called 1. The specific gravity of any other body is the real weight in pounds and ounces, when of the bulk of one pound or one ounce of water. It is therefore of the first importance, in all

Specific  
Gravity

discussions respecting the specific gravity of bodies, to have the precise weight of some known bulk of pure water. We have taken some pains to examine and compare the experiments on this subject, and shall endeavour to ascertain this point with the precision which it deserves. We shall reduce all to the English cubic foot and avoirdupois ounce of the Exchequer standard, on account of a very convenient circumstance peculiar to this unit, viz. that a cubic foot contains almost precisely a thousand ounces of pure water, so that the specific gravity of bodies expresses the number of such ounces contained in a cubic foot.

We begin with a trial made before the house of commons in 1696 by Mr Everard. He weighed 2145,6 cubic inches of water by a balance, which turned sensibly with 6 grains, when there were 30 pounds in each scale. The weights employed were the troy weights, in the deposit of the Court of Exchequer, which are still preserved, and have been most scrupulously examined and compared with each other. The weight was 1131 ounces 14 pennyweights. This wants just 11 grains of a thousand avoirdupois ounces for 1728 cubic inches, or a cubic foot; and it would have amounted to that weight had it been a degree or two colder. The temperature indeed is not mentioned; but as the trial was made in a comfortable room, we may presume the temperature to have been about 55° of Fahrenheit's thermometer. The dimensions of the vessel were as accurate as the nice hand of Mr Abraham Sharp, Mr Flamsteed's assistant at Greenwich, could execute, and it was made by the Exchequer standard of length.

This is confided in by the naturalists of Europe as a very accurate standard experiment, and it is confirmed by many others both private and public. The standards of weight and capacity employed in the experiment are still in existence, and publicly known, by the report of the Royal Society to parliament in 1742, and by the report of a committee of the house of commons in 1758. This gives it a superiority over all the measures which have come to our knowledge.

The first experiment, made with proper attention, that we meet with, is by the celebrated Snellius, about the year 1615, and related in his *Eratosthenes Batavus*. He weighed a Rhinland cubic foot of distilled water, and found it 62,79 Amsterdam pounds. If this was the ordinary weight of the shops, containing 7626 English troy grains, the English cubic foot must be 62 pounds 9 ounces, only one ounce more than by Everard's experiment. If it was the Mint pound, the weight was 62 pounds 6 ounces. The only other trials which can come into competition with Mr Everard's are some made by the Academy of Sciences at Paris. Picart, in 1691, found the Paris cubic foot of the water of the fountain d'Arcueil to weigh 69,588 pounds *poids de Paris*. DuHamel obtained the very same result; but Mr Monge, in 1783, says that filtered rain-water of the temperature 12° (Reaumur) weighs 69,3792. Both these measures are considerably below Mr Everard's, which is 62,5, the former giving 62,053, and the latter 61,868. M. Lavoisier states the Paris cubic foot at 70 pounds, which makes the English foot 62,47. But there is an inconsistency among them which makes the comparison impossible. Some changes were made in

1688, by royal authority, in the national standards, both of weight and length; and the academicians are exceedingly puzzled to this day in reconciling the differences, and cannot even ascertain with perfect assurance the lineal measures which were employed in their most boasted geodetical operations.

Such variations in the measurements made by persons of reputation for judgment and accuracy engaged the writer of this article some years ago to attempt another. A vessel was made of a cylindrical form, as being more easily executed with accuracy, whose height and diameter were 6 inches, taken from a most accurate copy of the Exchequer standard. It was weighed in distilled water of the temperature 55° several times without varying 2 grains, and it lost 42895 grains. This gives for the cubic foot 998,74 ounces, deficient from Mr Everard's an ounce and a quarter; a difference which may be expected, since Mr Everard used the New River water without distillation.

We hope that these observations will not be thought superfluous in a matter of such continual reference, in the most interesting questions both to the philosopher and the man of business; and that the determination which we have given will be considered as sufficiently authenticated.

Let us, therefore, for the future take water for the standard, and suppose that, when of the ordinary temperature of summer, and in its state of greatest natural purity, viz. in clean rain or snow, an English cubic foot of it weighs a thousand avoirdupois ounces of 437,5 troy grains each. Divide the weight of any body by the weight of an equal bulk of water, the quotient is the specific gravity of that body; and if the three first figures of the decimal be accounted integers, the quotient is the number of avoirdupois ounces in a cubic foot of the body. Thus the specific gravity of the very finest gold which the refiner can produce is 19,365, and a cubic foot of it weighs 19365 ounces.

But an important remark must be made here. All bodies of homogeneous or unorganised texture expand by heat and contract by cooling. The expansion and contraction by the same change of temperature is very different in different bodies. Thus water, when heated from 65° to 100°, increases its volume nearly  $\frac{1}{87}$  of its bulk, and mercury only  $\frac{1}{113}$ , and many substances much less. Hence it follows, that an experiment determines the specific gravity only in that very temperature in which the bodies are examined. It will therefore be proper always to note this temperature; and it will be convenient to adopt some very useful temperature for such trials in general: perhaps about 60° of Fahrenheit's thermometer is as convenient as any. It may always be procured in these climates without inconvenience. A temperature near to freezing would have some advantages, because water changes its bulk very little between the temperature 32° and 45°. But this temperature cannot always be obtained. It will much conduce to the facility of the comparison to know the variation which heat produces on pure water. The following table, taken from the observations of Dr Blagden and Mr Gilpin (*Phil. Trans.* 1792) will answer this purpose.

Specific Gravity.

Temperature of Water.	Bulk of Water.	Specific Gravity.
30		
35	99910	1,00090
40	99070	1,00094
45	99914	1,00086
50	99932	1,00068
55	99962	1,00038
60	100000	1,00000
65	100050	0,99950
70	100106	0,99894
75	100171	0,99830
80	100242	0,99759
85	100320	0,99681
90	100404	0,99598
95	100501	0,99502
100	100602	0,99402

Those gentlemen observed the expansion of water to be very anomalous between  $32^{\circ}$  and  $45^{\circ}$ . This is distinctly seen during the gradual cooling of water to the point of freezing. It contracts for a while, and then suddenly expands. But we seldom have occasion to measure specific gravities in such temperature.

The reader is now sufficiently acquainted with the principles of this hydrostatical method of determining the specific gravity of bodies, and can judge of the propriety of the forms which may be proposed for the experiment.

The specific gravity of a fluid may be determined either by filling with it a vessel with a narrow neck, or by weighing a solid body that is immersed in it. It is hard to say which is the best way. The last is not subject to any error in filling, because we may suspend the solid by a fine wire, which will not displace any sensible quantity of the fluid; and if the solid is but a little heavier than the fluid, the balance being loaded only with the excess, will be very sensible to the smallest want of equilibrium. But this advantage is perhaps compensated by an obstruction to the motion of the solid up or down in the fluid, arising from viscosity. When the weight in the opposite scale is yet too small, we slowly add more, and at last grain by grain, which gradually brings the beam to the level. When it is exactly level, the weight in the scale is somewhat too great; for it not only balances the preponderance of the solid, but also this viscosity of the fluid. But we may get rid of this error. Add a small quantity more; this will bring the beam over to the other side. Now put as much into the scale on the same side with the solid; this will not restore the beam to its level. We must add more till this be accomplished; and this addition is the measure of the viscosity of the fluid, and must be subtracted from the weight that was in the other scale when the beam came *first* to a level. This effect of viscosity is not insensible, with nice apparatus, even in the purest water, and in many fluids it is very considerable—and, what is worse, it is very changeable. It is greatly diminished by heat; and this is an additional reason for making those trials in pretty warm temperatures. But for fluids of which the viscosity is considerable, this method is by no means proper; and we must take the

other, and weigh them in a vessel with a narrow neck. Mercury must also be treated in this way, because we have no solid that will sink in it but gold and platinum.

It is not so easy as one would imagine to fill a vessel precisely to the same degree upon every trial. But if we do not operate on too small quantities, the unavoidable error may be made altogether insignificant, by having the neck of the vessel very small. If the vessel hold a pound of water, and the neck do not exceed a quarter of an inch (and it will not greatly retard the operation to have it half this size), the examiner must be very careful indeed to err one part in two thousand; and this is perhaps as near as we can come with a balance. We must always recollect that the capacity of the vessel changes by heat, and we must know this variation, and take it into the account. But it is affectation to regard (as Mr Tomberg would make us believe that he did) the dilation of the vessel by the pressure of the fluid. His experiments of this kind have by no means the consistency with each other that should convince us that he did not commit much greater errors than what arose from dilation.

In examining either solids or fluids, we must be careful to free their surface, or that of the vessel in which the fluid is to be weighed, from air, which frequently adheres to it in a peculiar manner, and, by forming a bubble, increases the apparent bulk of the solid, or diminishes the capacity of the vessel. The greatest part of what appears on those occasions seems to have existed in the fluid in a state of chemical union, and to be set at liberty by the superior attraction of the fluid for the contiguous solid body. These air bubbles must be carefully brushed off by hand. All greasy matters must be cleared off for the same reason: they prevent the fluid from coming into contact.

We must be no less careful that no water is imbibed by the solid, which would increase its weight without increasing its bulk. In some cases, however, a very long maceration and imbibition is necessary. Thus, in examining the specific gravity of the fibrous part of vegetables, we should err exceedingly if we imagined it as small as appears at first. We believe that in most plants it is at least as great as water, for after long maceration they sink in it.

It is almost needless to say that the nicest and most sensible balances are necessary for this examination. Balances are even constructed on purpose, and fitted with several pieces of apparatus, which make the examination easy and neat. We have described (see BALANCE) Mr Gravesande's as one of the most convenient of any. His contrivance for observing the fractions of a grain is extremely ingenious and expeditious, especially for detecting the effect of viscosity.

The hydrometer, or aecometer, is another instrument for ascertaining the specific gravity of fluids. This very pretty instrument is the invention of a lady, as eminent for intellectual accomplishments as she was admired for her beauty. Hypatia, the learned daughter of the celebrated mathematician Theon of Alexandria, became so eminent for her mathematical knowledge, that she was made public professor of the science in the first school in the world. She wrote a commentary on the works of Apollonius and of Diophantus, and composed Astronomical Tables; all of which are lost. These rare accom-

Specific Gravity.

accom.

Specific Gravity.

accomplishments, however, could not save her from the fury of the fanatics of Alexandria, who cut her in pieces, for having taken an offensive part in a dispute between the governor and patriarch.—We have described some of the most approved of these instruments in the article *HYDROMETER*, and shall in this place make a few observations on the principles of their construction, not as they are usually made, accommodated to the examination of particular liquors, but as indicators of pure specific gravity. And we must premise, that this would, for many reasons, be the best way of constructing them. The very ingenious contrivances for accommodating them to particular purposes are unavoidably attended with many sources of error, both in their adjustment by the maker and in their use; and all that is gained by a very expensive instrument is the saving the trouble of inspecting a table. A simple scale of specific gravity would expose to no error in construction, because all the weights but one, or all the points of the scale but one, are to be obtained by calculation, which is incomparably more exact than any manual operation, and the table can always be more exact than any complex observation. But a still greater advantage is, that the instruments would by this means be fitted for examining all liquors whatever, whereas at present they are almost useless for any but the one for which they are constructed.

Plate  
CCCLXXII.

Hydrometers are of two kinds. The most simple and the most delicate are just a substitute for the hydrostatical balance. They consist of a ball (or rather an egg or pear-shaped vessel, which moves more easily through the fluid) *A* (fig. 1.) having a foot projecting down from it, terminated by another ball *B*, and a slender stalk or wire above, carrying a little dish *C*. The whole is made so light as to float in the lightest fluid we are acquainted with; such as vitriolic or muriatic æther, whose specific gravity is only 0.73. This number should be marked on the dish, indicating that this is the specific gravity of the fluid in which the instrument floats, sinking to the point *D* of the stem. The ball *B* is made heavy, and the foot is of some length, that the instrument may have stability, and swim erect, even if considerably loaded above; and, for the same reason, it must be made very round, otherwise it will lean to a side. When put into a heavier liquor, its buoyancy will cause it to float with a part of the ball above the surface. Weights are now put into the scale *C*, till the instrument sink to *D*. The weight put into the scale, added to the weight of the instrument, is the weight of the displaced fluid. This, compared with the weight of the whole when the instrument is swimming in pure water, gives the specific gravity of the fluid. All trouble of calculation may be avoided by marking the weights with such numbers as shall indicate the specific gravity at once. Thus having loaded the instrument so as to sink it to *D* in pure water, call the whole weight 1000; then weigh the instrument itself, and say, “as the weight when swimming in water is to its present weight, so is 1000 to a 4th proportional.” This is the specific gravity of the liquor which would float the unloaded instrument. Suppose this to be 730. The hydrometer would just float in muriatic æther, and this should be marked on the side. Now make a set of small

Specific Gravity.

weights, and mark them, not by their weights in grains, but in such units that 270 of them shall be equal to the weight which fits the instrument for pure water.

Suppose that, in order to float this instrument in a certain brandy, there are required 186 in these small weights. This added to 730 gives 916 for the specific gravity, and shows it to be precisely excise proof spirit. Nine weights, viz. 256, 128, 64, 32, 16, 8, 4, 2, 1, will suffice for all liquors from æther to the strongest worts. And that the trouble in changing the weights may be greatly lessened, let a few circles *a, b, c, d, e*, be marked on the top of the ball. When we see it float unloaded at the circle *C* for instance, we know it will require at least 128 to sink it to *D* than the stem.

If the weights to be added above are considerable, it raises the centre of gravity so much, that a small want of equilibrium, by laying the weights on one side, will produce a great inclination of the instrument, which is unsightly. Instead therefore of making them loose weights, it is proper to make them round plates, with a small hole in the middle, to go on a pin in the middle of the scale. This will keep the instrument always upright. But unless the hydrometer is of a considerable size, it can hardly be made so as to extend from the lightest to the heaviest fluid which we may have occasion to examine, even though we except mercury. Some of the mineral acids are considerably more than twice the weight of æther. When there is such a load at top, the hydrometer is very apt to overset, and inclines with the smallest want of equilibrium. Great size is inconvenient even to the philosopher, because it is not always in his power to operate on a quantity of fluid sufficient to float the instrument. Therefore two, or perhaps three, are necessary for general examination. One may reach from æther to water; another may serve for all liquors of a specific gravity between 1 and  $1\frac{1}{2}$ ; and the third, for the mineral acids, may reach from this to 2. If each of these be about two solid inches in capacity, we may easily and expeditiously determine the specific gravity within one ten thousandth part of the truth: and this is precision enough for most purposes of science or business.

The chief questions are, 1. To ascertain the specific gravity of an unknown fluid. This needs no farther explanation. 2. To ascertain the proportion of two fluids which are known to be in a mixture. This is done by discovering the specific gravity of the mixture by means of the hydrometer, and then deducing the proportion from a comparison of this with the specific gravities of the ingredients.

In this mode of examination the bulk is always the same; for the hydrometer is immersed in the different fluids to the same depth. Now if an inch, for example, of this bulk is made up of the heaviest fluid, there is an inch wanting of the lightest; and the change made in the weight of the mixture is the difference between the weight of an inch of the heaviest and of an inch of the lightest ingredients. The number of inches therefore of the heaviest fluid is proportional to the addition made to the weight of the mixture. Therefore let *B* and *b* be the bulks of the heaviest and lightest fluids in the bulk *B* of the mixture; and let *D*, *d*, and *s* be the densities, or the weights, or the specific gravities (for they are in one ratio)

Specific Gravity.

ratio) of the heavy fluid, the light fluid, and the mixture (their bulk being that of the hydrometer). We have  $\beta = B + b$ . The addition which would have been made to the bulk  $\beta$ , if the lightest fluid were changed entirely for the heaviest, would be  $D - d$ ; and the change which is really made is  $s - d$ . Therefore  $\beta : b = D - d : s - d$ . For similar reasons we should have  $\beta : B = D - d : D - s$ ; or, in words, "the difference between the specific gravities of the two fluids, is to the difference between the specific gravities of the mixture and of the lightest fluid, as the bulk of the whole to the bulk of the heaviest contained in the mixture;" and "the difference of the specific gravities of the two fluids, is to the difference of the specific gravities of the mixture and of the heaviest fluids, as the bulk of the whole to that of the lightest contained in the mixture." This is the form in which the ordinary business of life requires the answer to be expressed, because we generally reckon the quantity of liquors by bulk, in gallons, pints, quarts. But it would have been equally easy to have obtained the answer in pounds and ounces; or it may be had from their bulks, since we know their specific gravities.

The hydrometer more commonly used is the ancient one of Hypatia, consisting of a ball, A (fig. 2.), made steady by an addition B, below it like the former, but having a long stem CF above. It is so loaded that it sinks to the top F of the stem in the lightest of all the fluids which we propose to measure with it, and to sink only to C in the heaviest. In a fluid of intermediate specific gravity it will sink to some point between C and F.

In this form of the hydrometer the weight is always the same, and the immediate information given by the instrument is that of different bulks with equal weight. Because the instrument sinks till the bulk of the displaced fluid equals it in weight, and the additions to the displaced fluid are all made by the stem, it is evident that equal bulks of the stem indicate equal additions of volume. Thus the stem becomes a scale of bulks to the same weight.

The only form in which the stem can be made with sufficient accuracy is cylindrical or prismatical. Such a stem may be made in the most accurate manner by wire-drawing, that is, passing it through a hole made in a hardened steel plate. If such a stem be divided into equal parts, it becomes a scale of bulks in arithmetical progression. This is the easiest and most natural division of the scale; but it will not indicate densities, specific gravities, or weights of the same bulk in arithmetical progression. The specific gravity is as the weight divided by the bulk. Now a series of divisors (the bulks), in arithmetical progression, applied to the same dividend (the bulk and weight of the hydrometer as it floats in water), will not give a series of quotients (the specific gravities) in arithmetical progression: they will be in what is called *harmonic progression*, their differences continually diminishing. This will appear even when physically considered. When the hydrometer sinks a tenth of an inch near the top of the stem, it displaces one tenth of an inch of a light fluid, compared with that displaced by it when it is floating with all the stem above the surface. In order therefore that the divisions of the stem may indicate equal changes of specific gravity, they must be in a series of harmonic progressions increasing. The point at which the in-

strument floats in pure water should be marked 1000, and those above it 999, 998, 997, &c.; and those below the water mark must be numbered 1001, 1002, 1003, &c. Such a scale will be a very apposite picture of the densities of fluids, for the density or vicinity of the divisions will be precisely similar to the density of the fluids. Each interval is a bulk of fluid of the same weight. If the whole instrument were drawn out into wire of the size of the stem, the length from the water mark would be 1000.

Such are the rules by which the scale must be divided. But there must be some points of it determined by experiment, and it will be proper to take them as remote from each other as possible. For this purpose let the instrument be accurately marked at the point where it stands, in two fluids, differing as much in specific gravity as the instrument will admit. Let it also be marked where it stands in water. Then determine with the utmost precision the specific gravities of these fluids, and put their values at the corresponding points of the scale. Then the intermediate points of the scale must be computed for the different intervening specific gravities, or it must be divided from a pattern scale of harmonic progressions in a way well known to the mathematical instrument-makers. If the specific gravities have been accurately determined, the value 1000 will be found to fall precisely in the water mark. If we attempt the division entirely by experiment, by making a number of fluids of different specific gravities, and marking the stem as it stands in them, we shall find the divisions turn out very anomalous. This is however the way usually practised; and there are few hydrometers, even from the best maker, that hold true to a single division or two. Yet the method by computation is not more troublesome; and one scale of harmonic progressions will serve to divide every stem that offers. We may make use of a scale of equal parts for the stem, with the assistance of two little tables. One of these contains the specific gravities in harmonic progression, corresponding to the arithmetical scale of bulks on the stem of the hydrometer; the other contains the divisions and fractions of a division of the scale of bulks, which correspond to an arithmetical scale of specific gravities. We believe this to be the best method of all. The scale of equal parts on the stem is so easily made, and the little table is so easily inspected, that it has every advantage of accuracy and dispatch, and it gives, by the way, an amusing view of the relation of the bulks and densities.

We have hitherto supposed a scale extending from the lightest to the heaviest fluid. But unless it be of a very inconvenient length, the divisions must be very minute. Moreover, when the bulk of the stem bears a great proportion to that of the body, the instrument does not swim steady; it is therefore proper to limit the range of the instrument in the same manner as those of the first kind. A range from the density of æther to that of water may be very well executed in an instrument of very moderate size, and two others will do for all the heavier liquors; or an equal range in any other densities as may suit the usual occupations of the experimenter.

To avoid the inconveniences of a hydrometer with a very long and slender stem, or the necessity of having a series of them, a third sort has been contrived, in which

Specific Gravity.

Specific Gravity.

which the principle of both are combined. Suppose a hydrometer with a stem, whose bulk is  $\frac{1}{100}$ th of that of the ball, and that it sinks in ether to the top of the stem; it is evident that in a fluid which is  $\frac{1}{100}$ th heavier, the whole stem will emerge; for the bulk of the displaced fluid is now  $\frac{1}{100}$ th of the whole lcs, and the weight is the same as before, and therefore the specific gravity is  $\frac{1}{100}$ th greater.

Thus we have obtained a hydrometer which will indicate, by means of divisions marked on the stem, all specific gravities from 0,73 to 0,803; for 0,803 is  $\frac{1}{100}$ th greater than 0,73. These divisions must be made in harmonic progression, as before directed for an entire scale, placing 0,73 at the top of the stem and 0,803 at the bottom.

When it floats at the lowest division, a weight may be put on the top of the stem, which will again sink it to the top. This weight must evidently be 0,073, or  $\frac{1}{100}$ th of the weight of the fluid displaced by the unloaded instrument. The hydrometer, thus loaded, indicates the same specific gravity, by the top of the stem, that the unloaded instrument indicates by the lowest division. Therefore, when loaded, it will indicate another series of specific gravities, from 0,803 to 0,8833 (= 0,803 + 0,0803), and will float in a liquor of the specific gravity 0,8833 with the whole stem above the surface.

In like manner, if we take off this weight, and put on 1 = 0,0803, it will sink the hydrometer to the top of the stem; and with this new weight it will indicate another series of specific gravities from 0,8833 to 0,97163 (= 0,8833 + 0,08833). And, in the same manner, a third weight = 0,8833 will again sink it to the top of the stem, and fit it for another series of specific gravities up to 1,068793. And thus, with three weights, we have procured a hydrometer fitted for all liquors from ether to a wort for a malt liquor of two barrels *per* quarter. Another weight, in the same progression, will extend the instrument to the strongest wort that is brewed.

This is a very commodious form of the instrument, and is now in very general use for examining spirituous liquors, worts, ales, brines, and many such articles of commerce. But the divisions of the scale are generally adapted to the questions which naturally occur in the business. Thus, in the commerce of strong liquors, it is usual to estimate the article by the quantity of spirit of a certain strength which the liquor contains — This we have been accustomed to call proof spirit, and it is such that a wine gallon weighs 7 pounds 12 ounces; and it is by this strength that the excise duties are levied. Therefore the divisions on the scale, and the weights which connect the successive repetitions of the scale, are made to express at once the number of gallons or parts of a gallon of proof spirits contained in a gallon of the liquor. Such instruments save all trouble of calculation to the exciseman or dealer; but they limit the use of a very delicate and expensive instrument to a very narrow employment. It would be much better to adhere to the expression either of specific gravity or of bulk; and then a very small table, which could be comprised in the smallest case for the instrument, might render it applicable to every kind of fluid.

The reader cannot but have observed that the successive weights, by which the short scale of the instru-

ment is extended to a great range of specific gravities, do not increase by equal quantities. Each difference is the weight of the liquor displaced by the graduated stem of the instrument when it is sunk to the top of the scale. It is a determined aliquot part of the whole weight of the instrument so loaded, (in our example it is always  $\frac{1}{100}$ th of it). It increases therefore in the same proportion with the preceding weight of the loaded instrument. In short, both the successive additions, and the whole weights of the loaded instrument, are quantities in geometrical progression; and, in like manner, the divisions on the scale, if they correspond to equal differences of specific gravity, must also be unequal — This is not sufficiently attended to by themakers; and they commit an error here, which is very considerable when the whole range of the instrument is great. For the value of one division of the scale, when the largest weight is on, is as much greater than its value, when the instrument is not loaded at all, as the full loaded instrument is heavier than the instrument unloaded. No manner whatever of dividing the scale will correspond to equal differences of specific gravity through the whole range with different weights; but if the divisions are made to indicate equal *proportions* of gravity when the instrument is used without a weight, they will indicate equal *proportions* throughout. This is evident from what we have been just now saying; for the proportion of the specific gravities corresponding to any two immediately succeeding weights is always the same.

The best way, therefore, of constructing the instrument, so that the same divisions of the scale may be accurate in all its successive repetitions with the different weights, is to make these divisions in geometrical progression. The corresponding specific gravities will also be in geometric proportion. These being all inserted in a table, we obtain them with no more trouble than by inspecting the scale which usually accompanies the hydrometer. This table is of the most easy construction; for the ratio of the successive bulks and specific gravities being all equal, the differences of the logarithms are equal.

This will be illustrated by applying it to the example already given of a hydrometer extending from 0,73 to 1,068793 with three weights. This gives four repetitions of the scale on the stem. Suppose this scale divided into 10 parts, we have 40 specific gravities. — Let these be indicated by the numbers 0, 1, 2, 3, &c. to 40. The mark 0 is affixed to the top of the stem, and the divisions downwards are marked 1, 2, 3, &c. the lowest being 10. These divisions are easily determined. The stem, which we may suppose 5 inches long, was supposed to be  $\frac{1}{100}$ th of the capacity of the ball. It may therefore be considered as the extremity of a rod of 11 times its length, or 55 inches; and we must find nine mean proportionals between 50 and 55 inches. Subtract each of these from 55 inches, and the remainders are the distances of the points of division from 0, the top of the scale. The smallest weight is marked 10, the next 20, and the third 30. If the instrument loaded with the weight 20 sinks in some liquor to the mark 7, it indicates the specific gravity 27, that is, the 27th of 40 mean proportionals between 0,73 and 1,068793, or 0,944242. To obtain all these intermediate specific gravities, we have only to subtract 9,8633229, the logarithm

Specific Gravity.

Specific Gravity. garithm of 0,73, from that of 1.068793, viz. 0,0288937, and take 0.0041393, the 40th part of the difference. Multiply this by 1, 2, 3, &c. and add the logarithm of 0,73 to each of the products. The sums are the logarithms of the specific gravities required. These will be found to proceed so equably, that they may be interpolated ten times by a simple table of proportional parts without the smallest sensible error. Therefore the stem may be divided into a hundred parts very sensible to the eye (each being nearly the 20th of an inch), and 400 degrees of specific gravity obtained within the range, which is as near as we can examine this matter by any hydrometer. Thus the specific gravities corresponding to n<sup>o</sup> 26, 27, 28, 29, are as follow :

		1st Diff.	2d Diff.
26	0,93529		
		895	
27	0,94424		9
		904	
28	0,95328		9
		913	
29	0,96241		

Nay, the trouble of inspecting a table may be avoided, by forming on a scale the logarithms of the numbers between 7300 and 1068,793, and placing along side of it a scale of the same length divided into 400 equal parts, numbered from 0 to 400. Then, looking for the mark shown by the hydrometer on this scale of equal parts, we see opposite to it the specific gravity.

We have been thus particular in the illustration of this mode of construction, because it is really a beautiful and commodious instrument, which may be of great use both to the naturalist and to the man of business. — A table may be comprised in 20 octavo pages, which will contain the specific gravities of every fluid which can interest either, and answer every question relative to their admixture with as much precision as the observations can be made. We therefore recommend it to our readers, and we recommend the very example which we have given as one of the most convenient. The instrument need not exceed eight inches in length, and may be contained in a pocket case of 2 inches broad and as many deep, which will also contain the scale, a thermometer, and even the table for applying it to all fluids which have been examined.

It is unfortunate that no graduated hydrometer can be made so easily for the examination of the corrosive mineral acids (A). These must be made of glass, and we cannot depend on the accurate cylindric form of any glass stem. But if any such can be procured, the construction is the same. The divided scale may either be on thin paper pasted on the inside of the stem, or it may be printed on the stem itself from a plate, with ink made of a metallic calx, which will attach itself to the glass with a very moderate heat. We would recommend common white enamel, or arsenical glass, as the fittest material for the whole instrument; and the ink used, in taking the impression of the scale, may be the same that is used for the low-priced printing on Delft ware pottery. — First form the scale on the stem. Then, having measured the solid contents of the graduated part as exactly as possible, and determined on the general shape of the ball and counterpoise below, calculate its size, so that it may be a little less than ten times that of the

Vol. XVII. Part II.

stem. The glass blower can copy this very nearly, and join it to the stem. Then make two brines or other liquors, which shall have specific gravities in the ratio of 10 to 11. Load the instrument so that it may sink to 0 in the lightest. When put into the heaviest, it should rise to 10. If it does not rise so high, the immersed part is too small. Let the glass blower enlarge the ball of the counterpoise a little. Repeat this trial till it be exact. Nothing now remains but to form the weights: And here we observe, that when the instrument is to have a very great range, as for examining all states of the vitriolic acid, it has a chance of being very tottering when loaded with the greatest weight on the top of so long a scale. To avoid this, Mr *Quin* and others have added some of their weights below. — But this will not suit the present construction, because it will alter the proportion between the bulks of the stem and immersed part. Therefore let these weights consist of cylinders of metal small enough to go into the stem, and let them be foldered to the end of long wires, which will let them go to the bottom, and leave a small hook or ring at top. These can lie alongside of the instrument in its case. This is indeed the best construction for every hydrometer, because it makes it incomparably more steady. The instrument is poised by small shot or mercury. But it will be much better to do it with Newton's fusible metal (three parts of tin, five parts of lead, and eight parts of bismuth) in coarse filings. When the exact quantity has been put in, the instrument may be set in a vessel of oil, and this kept on the fire till all is completely melted. It soon freezes again, and remains fast. If this metal is not to be had, let a few bits of sealing-wax be added to the mercury or shot, to make up the counterpoise. When heated, it will float a-top, and when it freezes again it will keep all fast. Thus we shall make a very complete and cheap instrument.

There is yet another method of examining the specific gravities of fluids, first proposed by Dr *Wilson*, late professor of astronomy in the university of Glasgow. This is by a series of small glass bubbles, differing equally, or according to some rule, from each other in specific gravity, and each marked with its proper number. When these are thrown into a fluid which is to be examined, all those which are heavier than the fluid will fall to the bottom. Then holding the vessel in the hand, or near a fire or candle, the fluid expands, and one of the floating bubbles begins to sink. Its specific gravity, therefore, was either equal to, or a little less than, that of the fluid; and the degree of the thermometer, when it began to sink, will inform us how much it was deficient, if we know the law of expansion of the liquor. Sets of these bubbles fitted for the examination of spirituous liquors, with a little treatise showing the manner of using them, and calculating by the thermometer, are made by Mr *Brown*, an ingenious artist of Glasgow, and are often used by the dealers in spirits, being found both accurate and expeditious.

Also, though a bubble or two should be broken, the strength of spirits may easily be had by means of the remainder, unless two or three in immediate succession

4 P be

(A) It would be worth while to try copper enamelled.

Specific  
Gravity.

be wanting: for a liquor which answers to N<sup>o</sup> 4 will sink N<sup>o</sup> 2 by heating it a few degrees, and therefore N<sup>o</sup> 3 may be spared. This is a great advantage in ordinary business. A nice hydrometer is not only an expensive instrument, but exceedingly delicate, being so very thin. If broken or even bruised, it is useless, and can hardly be repaired except by the very maker.

As the only question here is, to determine how many gallons of excise proof spirits is contained in a quantity of liquor, the artist has constructed this series of bubbles in the simplest manner possible, by previously making 40 or 50 mixtures of spirits and water, and then adjusting the bubbles to these mixtures. In some sets the number on each bubble is the number of gallons of proof spirits contained in 100 gallons of the liquor. In other sets the number on each bubble expresses the gallons of water which will make a liquor of this strength, if added to 14 gallons of alcohol. Thus, if a liquor answers to N<sup>o</sup> 4, then 4 gallons of water added to 14 gallons of alcohol will make a liquor of this strength. The first is the best method; for we should be mistaken in supposing that 18 gallons, which answer to N<sup>o</sup> 4, contains exactly 14 gallons of alcohol: it contains more than 14, for a reason to be given by and by.

By examining the specific gravity of bodies, the philosopher has made some very curious discoveries. The most remarkable of these is the change which the density of bodies suffers by mixture. It is a most reasonable expectation, that when a cubic foot of one substance is mixed *any how* with a cubic foot of another, the bulk of the mixture will be two cubic feet; and that 18 gallons of water joined to 18 gallons of oil will fill a vessel of 36 gallons. Accordingly this was never doubted; and even Archimedes, the most scrupulous of mathematicians, proceeded on this supposition in the solution of his famous problem, the discovery of the proportion of silver and gold in a mixture of both. He does not even mention it as a postulate that *may* be granted him, so much did he conceive it to be an axiom. Yet a little reflection seems sufficient to make it doubtful, and to require examination. A box filled with musket-balls will receive a considerable quantity of small shot, and after this a considerable quantity of fine sand, and after this a considerable quantity of water. Something like this might happen in the admixture of bodies of porous texture. But such substances as metals, glass, and fluids, where no discontinuity of parts can be perceived, or was suspected, seem free from every chance of this kind of intromission. Lord Bacon, however, without being a naturalist or mathematician *ex professo*, inferred from the mobility of fluids that they consisted of discrete particles, which must have pores interposed, whatever be their figure. And if we ascribe the different densities, or other sensible qualities, to difference in size or figure of those particles, it must frequently happen that the smaller particles will be lodged in the interstices between the larger, and thus contribute to the weight of the sensible mass without increasing its bulk. He therefore suspects that mixtures will be in general less bulky than the sum of their ingredients.

Accordingly, the examination of this question was one of the first employments of the Royal Society of London, and long before its institution had occupied the attention of the gentlemen who afterwards composed it. The register of the Society's early meetings

contains many experiments on this subject, with mixtures of gold and silver, of other metals, and of various fluids, examined by the hydrostatical balance of Mr Boyle. Dr Hooke made a prodigious number, chiefly on articles of commerce, which were unfortunately lost in the fire of London.

It was soon found, however, that Lord Bacon's conjecture had been well founded, and that bodies changed their density very sensibly in many cases. In general, it was found that bodies which had a strong chemical affinity increased in density, and that their admixture was accompanied with heat.

By this discovery it is manifest that Archimedes had not solved the problem of detecting the quantity of silver mixed with the gold in King Hiero's crown, and that the physical solution of it requires experiments made on all the kinds of matter that are mixed together. We do not find that this has been done to this day, although we may assure that there are few questions of more importance. It is a very curious fact in chemistry, and it would be most desirable to be able to reduce it to some general laws: For instance, to ascertain what is the proportion of two ingredients which produces the greatest change of density. This is important in the science of physics, because it gives us considerable information as to the mode of action of those natural powers or forces by which the particles of tangible matter are united. If this intromission, concentration, compenetration, or by whatever name it be called, were a mere reception of the particles of one substance into the interstices of those of another, it is evident that the greatest concentration would be observed when a small quantity of the recipient is mixed with, or disseminated through, a great quantity of the other. It is thus that a small quantity of fine sand will be received into the interstices of a quantity of small shot, and will increase the weight of the bagful without increasing its bulk. The case is nowise different when a piece of freestone has grown heavier by imbibing or absorbing a quantity of water. If more than a certain quantity of sand has been added to the small shot, it is no longer concealed. In like manner, various quantities of water may combine with a mass of clay, and increase its size and weight alike. All this is very conceivable, occasioning no difficulty.

But this is not the case in any of the mixtures we are now considering. In all these, the first additions of either of the two substances produce but an inconsiderable change of general density; and it is in general most remarkable, whether it be condensation or rarefaction, when the two ingredients are nearly of equal bulks. We can illustrate even this difference, by reflecting on the imbibition of water by vegetable solids, such as timber. Some kinds of wood have their weight much more increased than their bulks; other kinds of wood are more enlarged in bulk than in weight. The like happens in grains. This is curious, and shows in the most unquestionable manner that the particles of bodies are not in contact, but are kept together by forces which act at a distance. For this distance between the centres of the particles is most evidently susceptible of variation; and this variation is occasioned by the introduction of another substance, which, by acting on the particles by attraction or repulsion, diminishes or increases their mutual actions, and makes new distances

Speci  
Gravi



necessary for bringing all things again into equilibrium. We refer the curious reader to the ingenious theory of the Abbé Boscovich for an excellent illustration of this subject (*Theor. Phil. Nat. § de Solutione Chémica*).

This question is no less important to the man of business. Till we know the condensation of those metals by mixture, we cannot tell the quantity of alloy in gold and silver by means of their specific gravity; nor can we tell the quantity of pure alcohol in any spirituous liquor, or that of the valuable salt in any solution of it. For want of this knowledge, the dealers in gold and silver are obliged to have recourse to the tedious and difficult test of the assay, which cannot be made in all places or by all men. It is therefore much to be wished, that some persons would institute a series of experiments in the most interesting cases: for it must be observed, that this change of density is not always a small matter; it is sometimes very considerable and paradoxical. A remarkable instance may be given of it in the mixture of brass and tin for bells, great guns, optical speculums, &c. The specific gravity of cast brass is nearly 8,006, and that of tin is nearly 7,363. If two parts of brass be mixed with one of tin, the specific gravity is 8,917; whereas, if each had retained its former bulk, the specific gravity would have been only 7,793 ( $= \frac{2 \times 8,006 + 7,363}{3}$ ). A mixture of equal parts should have the specific gravity 7,684; but it is 8,441. A mixture of two parts tin with one part brass, instead of being 7,577, is 8,027.

In all these cases there is a great increase of specific gravity, and consequently a great condensation of parts or contraction of bulk. The first mixture of eight cubic inches of brass, for instance, with four cubic inches of tin, does not produce 12 cubic inches of bell-metal, but only 10½ nearly, having shrunk ¼. It would appear that the distances of the brass particles are most affected, or perhaps it is the brass that receives the tin into its pores; for we find that the condensations in these mixtures are nearly proportional to the quantities of the brass in the mixtures. It is remarkable that this mixture with the lightest of all metals has made a composition more heavy and dense than brass can be made by any hammering.

The most remarkable instance occurs in mixing iron with platina. If 10 cubic inches of iron are mixed with 1½ of platina, the bulk of the compound is only 9½ inches. The iron therefore has not simply received the platina into its pores: its own particles are brought nearer together. There are similar results in the solution of turbit mineral, and of some other salts, in water. The water, instead of rising in the neck of the vessel, when a small quantity of the salt has been added to it, sinks considerably, and the two ingredients occupy less room than the water did alone.

The same thing happens in the mixture of water with other fluids and different fluids with each other: But we are not able to trace any general rule that is observed with absolute precision. In most cases of fluids the greatest condensation happens when the bulks of the ingredients are nearly equal. Thus, in the mixture of alcohol and water, we have the greatest condensation when 16½ ounces of alcohol are mixed with 20 ounces of water, and the condensation is about ¼ of the whole bulk of the ingredients. It is extremely va-

rious in different substances, and no classification of them can be made in this respect.

A dissertation has been published on this subject by Dr Hahn of Vienna, intitled *Le Efficiacia Mixtionis in mutandis Corporum Voluminibus*, in which all the remarkable instances of the variation of density have been collected. All that we can do (as we have no directing principle) is to record such instances as are of chief importance, being articles of commerce.

The first that occurs to us is the mixtures of alcohol and water in the composition of spirituous liquors. This has been considered by many with great care. The most scrupulous examination of this, or perhaps of any mixture, has been lately made by Dr Blagden (now Sir Charles Blagden) of the Royal Society, on the requisition of the Board of Excise. He has published an account of the examination in the Philosophical Transactions of London in 1791 and 1792. We shall give an account of it under the article *SPIRITUOUS Liquors*; and at present only select one column, in order to show the condensation. The alcohol was almost the strongest that can be produced, and its specific gravity, when of the temperature 60°, was 0,825. The whole mixtures were of the same temperature.

Column 1. contains the pounds, ounces, or other measures by weight, of alcohol in the mixture. Column 2. contains the pounds or ounces of water. Column 3. is the sum of the bulks of the ingredients, the bulk of a pound or ounce of water being accounted 1. Column 4. is the observed specific gravity of the mixture, taken from Dr Blagden's dissertation. Column 5. is the specific gravity which would have been observed if the ingredients had each retained its own specific gravity. This we calculated by dividing the sum of the two numbers of the first and second columns by the corresponding number of the third. Column 6. is the difference of column 4. and column 5. and exhibits the condensation.

T A B L E.

A.	W.	Volume.	Sp. Grav <sup>y</sup> observed.	Sp. Grav <sup>y</sup> al culated.	Conden- sation.
20	0	24,2424	0,8250	0,8250	00
20	1	25,2424	0,8360	0,8320	40
20	2	26,2424	0,8457	0,8383	74
20	3	27,2424	0,8543	0,8443	100
20	4	28,2424	0,8621	0,8498	123
20	5	29,2424	0,8692	0,8549	143
20	6	30,2424	0,8757	0,8597	160
20	7	31,2424	0,8817	0,8642	175
20	8	32,2424	0,8872	0,8684	188
20	9	33,2424	0,8923	0,8724	199
20	10	34,2424	0,8971	0,8761	216
20	11	35,2424	0,9014	0,8796	218
20	12	36,2424	0,9053	0,8829	226
20	13	37,2424	0,9095	0,8860	233
20	14	38,2424	0,9129	0,8891	238
20	15	39,2424	0,9172	0,8919	243
20	16	40,2424	0,923	0,8946	247
20	17	41,2424	0,9223	0,8971	252
20	18	42,2424	0,9250	0,8996	254
20	19	43,2424	0,9276	0,9019	257
20	20	44,2424	0,9300	0,9041	259
19	20	43,2303	0,9325	0,9063	262

Specific Gravity.

A.	W.	Volume.	Sp. Grav <sup>y</sup> observed.	Sp. Grav <sup>y</sup> calculated.	Conden- sation.
18	20	4,81182	0,9349	0,9087	262
17	20	40,6061	0,9375	0,9112	263
16	20	39,3939	0,9402	0,9139	263
15	20	38,1818	0,9430	0,9167	263
14	20	36,9697	0,9458	0,9197	261
13	20	35,7576	0,9488	0,9229	259
12	20	34,5455	0,9518	0,9263	255
11	20	33,3333	0,9549	0,9300	249
10	20	32,1212	0,9580	0,9340	240
9	20	30,9091	0,9612	0,9382	230
8	20	29,6970	0,9644	0,9429	215
7	20	28,4849	0,9675	0,9479	196
6	20	27,2727	0,9707	0,9533	174
5	20	26,0606	0,9741	0,9593	148
4	20	24,8485	0,9777	0,9659	118
3	20	23,6364	0,9818	0,9731	87
2	20	22,4242	0,9865	0,9811	54
1	20	21,2121	0,9924	0,9900	24
0	20	20,0000	1,0000	1,0000	

It is to be remarked, that the condensation is great- est when 16½ ounces of alcohol have been added to 20 of water, and the condensation is  $\frac{263}{27817}$ , or nearly  $\frac{1}{10}$ th of the computed density. Since the specific gravity of alcohol is 0,825, it is evident that 16½ ounces of alco- hol and 20 ounces of water have equal bulks. So that the condensation is greatest when the substances are mix- ed in equal volumes; and 18 gallons of alcohol mixed with 18 gallons of water will produce not 36 gallons of spirits, but 35 only.

We may also observe, that this is the mixture to which our revenue-laws refer, declaring it to be *one to six or one in seven* under proof, and to weigh 7 pounds 13 ounce per gallon. This proportion was probably se- lected as the most easily composed, viz. by mixing equal measures of water and of the strongest spirit which the known processes of distillation could produce. Its specific gravity is 0,939 very nearly.

We must consider this elaborate examination of the mixture of water and alcohol as a standard series of ex- periments, to which appeal may always be made, whe- ther for the purposes of science or of trade. The regu- larity of the progression is so great, that in the column which we have examined, viz. that for temperature 60°, the greatest anomaly does not amount to one part in six thousand. The form of the series is also very judi- ciously chosen for the purposes of science. It would perhaps have been more directly stereometrical had the proportions of the ingredients been stated in bulks, which are more immediately connected with density. But the author has assigned a very cogent reason for his choice, viz. that the proportion of bulks varies by a change of temperature, because the water and spirits fol- low different laws in their expansion by heat.

This is a proper opportunity for taking notice of a mistake which is very generally made in the conclusions drawn from experiments of this kind. Equal addi- tions of the spirit or water produce a series of specific gravities, which decrease or increase by differences con- tinually diminishing. Hence it is inferred that there is a contraction of bulk. Even Dr Lewis, one of our

most accomplished naturalists, advances this position, in a dissertation on the pot-ash of America; and it confi- dably affects his method for estimating the strength of the pot-ash leys. But that it is a mistake, appears plainly from this, that although we add for ever equal quantities of the spirits, we shall never produce a *mix- ture* which has as small a specific gravity as alcohol. Therefore the series of successive gravities must approx- imate to this without end, like the ordinates of a hy- perbolic curve referred to its asymptote.

That this may appear in the most general terms, let *w* represent the weight of the constant quantity of wa- ter in the mixture, and let *a* be the weight of the small addition of spirits. Also let *w* represent the bulk of this quantity of water, and *b* the bulk of the small ad- dition of alcohol. The weight of the mixture is *w + a*, and its bulk is *w + b*, and its specific gravity is  $\frac{w+a}{w+b}$ .

If we now add a second equal quantity of spirits, the weight will be *w + 2a*, and if the spirit retains its den- sity unchanged, the bulk will be *w + 2b*, and the speci- fic gravity is  $\frac{w+2a}{w+2b}$ : and after any number *m* of such

equal additions of spirits, the specific gravity will be  $\frac{w+ma}{w+mb}$ . Divide the numerator of this fraction by its denominator, and the quotient or specific gravity will be  $1 + \frac{m \times a - b}{w + mb}$ . This consists of the constant part 1,

and the variable part  $\frac{m(a-b)}{w+mb}$ . We need attend only to this part. If its denominator were constant, it is plain that the successive specific gravities would have equal differences, each being  $= \frac{a-b}{w+mb}$ , because *m* in- creases by the continual addition of an unit, and *a - b* is a constant quantity. But the denominator *w + mb* continually increases, and therefore the value of the frac- tion  $\frac{a-b}{w+mb}$  continually diminishes.

Therefore the gradual diminution of the increments or decrements of specific gravity, by equal additions of one ingredient to a constant measure of the other, is not of itself an indication of a change of density of either of the ingredients; nor proves that in very diluted mix- tures a greater proportion of one ingredient is absorbed or lodged in the interstices of the other, as is generally imagined. This must be ascertained by comparing each specific gravity with the gravity expressed by  $1 + \frac{m(a-b)}{w+mb}$ .

This series of specific gravities resembles such a nu- merical series as the following, 1; . . . . .; 1,156; 1,163; 1,169; &c. the terms of which also consist of the constant integer 1, and the decimal fractions 0,156; 0,163; 0,169; &c. The fraction  $\frac{m(a-b)}{w+mb}$  expresses this decimal part. Call this *d*, or make  $d = \frac{m(a-b)}{w+mb}$ .

This will give us  $b = \frac{ma-wd}{m(1+d)}$ . Now *a* is the weight of the added ingredient, and *d* is the variable part of the specific gravity observed; and thus we learn whe- ther

Specific Gravity.

Specific Gravity.

ther *b*, the bulk of the added ingredient, suffers any change. We shall have occasion by and by to resume the consideration of this question, which is of the first moment in the theory of specific gravities, and has great influence in many transactions of commerce.

This series of specific gravities is not so well fitted for commercial transactions. In these the usual question is, how many gallons of alcohol is there in a cask, or some number of gallons of spirit? and it is more directly answered by means of a table, formed by mixing the ingredients in aliquant parts of one constant bulk. The following table, constructed from the experiments of Mr Briffon of the academy of Paris, and published in the Memoirs for 1769, is therefore inserted.

W.	A.	Density observed.	Density computed.	Condensation.	Bulk of 10,000 grains.
0	16	0,8371	0,8371		1,0000
1	15	0,8527	0,8473	63	0,9937
2	14	0,8674	0,8575	115	0,9885
3	13	0,8815	0,8677	157	0,9844
4	12	0,8947	0,8778	189	0,9811
5	11	0,9075	0,8880	214	0,9786
6	10	0,9199	0,8982	235	0,9765
7	9	0,9317	0,9084	251	0,9749
8	8	0,9427	0,9186	256	0,9744
9	7	0,9519	0,9287	243	0,9757
10	6	0,9598	0,9389	217	0,9783
11	5	0,9674	0,9491	189	0,9811
12	4	0,9733	0,9593	144	0,9856
13	3	0,9791	0,9695	99	0,9901
14	2	0,9852	0,9796	57	0,9943
15	1	0,9919	0,9898	21	0,9979
16	0	1,0000	1,0000		1,0000

In this table the whole quantity of spirituous liquor is always the same. The first column is the number of measures (gallons, pints, inches, &c.) of water in the mixture; and column 2d gives the measures of alcohol. Column 3d is the specific gravity which was observed by Mr Briffon. Column 4th is the specific gravity which would have been observed if the spirits, or water, or both, had retained their specific density unchanged. And the 5th column marks the augmentation of specific gravity or density in parts of 10,000. A 6th column is added, showing the bulk of the 16 cubic measures of the two ingredients. Each measure may be conceived as the 16th part of 10,000, or 625; and we may suppose them cubic inches, pints, gallons, or any solid measure.

This table scarcely differs from Sir Charles Blagden's; and the very small difference that may be observed, arises from Mr Briffon's having used an alcohol not so completely rectified. Its specific gravity is 0,8371, whereas the other was only 0,8250.

Here it appears more distinctly that the condensation is greatest when the two ingredients are of equal bulk.

Perhaps this series of specific gravities is as declarative as the other, whether or not there is a change of density induced on either of the ingredients. The whole bulk being always the same, it is plain that the

successive equal additions to one of the ingredients is a successive equal abstraction of the other. The change produced, therefore, in the weight of the whole, is the difference between the weight of the ingredient which is taken out and the weight of the equal measure of the other which supplies its place. Therefore, if neither ingredient changes its density by mixture, the weights of the mixtures will be in arithmetical progression. If they are not, there is a variation of density in one or both the ingredients.

We see this very clearly in the mixtures of water and alcohol. The first specific gravity differs from the second by 156, and the last differs from the preceding by no more than 81. Had neither of the densities changed, the common difference would have been 102. We observe also, that the augmentation of specific gravity, by the successive addition of a measure of water, grows less and less till 12 measures of water is mixed with 4 of alcohol, when the augmentation is only 58, and then it increases again to 81.

It also appears, that the addition of one measure of water to a quantity of alcohol produces a greater change of density than the mixture of one measure of alcohol to a quantity of water. Hence some conclude, that the water disappears by being lodged in the interstices of the spirit. But it is more agreeable to the justest notions which we can form of the internal constitution of tangible bodies to suppose that the particles of water diminish the distances between the particles of alcohol by their strong attractions, and that this diminution (exceedingly minute in itself) becomes sensible on account of the great number of particles whose distances are thus diminished. This is merely a probability founded on this, that it would require a much greater diminution of distances if it was the particles of water which had their distances thus diminished. But the greater probability is, that the condensation takes place in both.

We have been so particular in our consideration of this mixture, because the law of variation of density has, in this instance, been ascertained with such precision by the elaborate examination of Sir Charles Blagden, so that it may serve as an example of what happens in almost every mixture of bodies. It merits a still farther discussion, because it is intimately connected with the action of the corpuscular forces; and an exact knowledge of the variations of distance between the particles will go far to ascertain the law of action of these forces. But the limits of a Work like this will not permit us to dwell longer on this subject. We proceed therefore to give another useful table.

The vitriolic or sulphuric acid is of extensive use in manufactures under the name of oil of vitriol. Its value depends entirely on the saline ingredient, and the water is merely a vehicle for the acid. This, being much denser than water, affects its specific gravity, and thus gives us a method of ascertaining its strength.

The strongest oil of vitriol that can be easily manufactured contains  $612\frac{1}{5}$  grains of dry acid, united with  $387\frac{1}{5}$  grains of water, which cannot be separated from it by distillation, making 1000 grains of OIL OF VITRIOL. Its specific gravity in this state is 1,877.

The following table shows its specific gravity at the temperature 55, when diluted by the successive addition of parts of water by weight.

Specific Gravity.

Specific

Specific Gravity.	Ol. Vit	Water.	Specific Gravity.		Cond.
			Observed.	Calculated.	
	10	X 0	1,877	1,877	.00
		4	1,644	1,501	.143
		8	1,474	1,350	.124
		12	1,381	1,269	.112
		16	1,320	1,219	.101
		20	1,274	1,184	.090
		24	1,243	1,159	.084
		28	1,211	1,140	.071
		32	1,195	1,125	.070
		36	1,183	1,113	.070
		40	1,172	1,103	.070
		50	1,148	1,084	.064
		60	1,128	1,069	.059

Here is observed a much greater condensation than in the mixture of alcohol and water. But we cannot assign the proportion of ingredients which produces the greatest condensation; because we cannot, in any case, say what is the proportion of the saline and watery ingredients. The strongest oil of vitriol is already a watery solution; and it is by a considerable and uncertain detour that Mr Kirwan has assigned the proportion of 612 and 388 nearly. If this be the true ratio, it is unlike every other solution that we are acquainted with; for in all solutions of salts, the salt occupies less room in its liquid form than it did when solid; and here it would be greatly the reverse.

This solution is remarkable also for the copious emergence of heat in its dilutions with more water. This has been ascribed to the great superiority of water in its capacity for heat; but there are facts which render this very doubtful. A vessel of water, and another of oil of vitriol, being brought from a cold room into a warm one, they both imbibe heat, and rise in their temperature; and the water employs nearly the same time to attain the temperature of the room.

Aqua fortis or nitrous acid is another fluid very much employed in commerce; so that it is of importance to ascertain the relation between its saline strength and its specific gravity. We owe also to Mr Kirwan a table for this purpose.

The most concentrated state into which it can easily be brought is such, that 1000 grains of it consists of 563 grains of water and 437 of dry acid. In this state its specific gravity is 1,557. Let this be called *nitrous acid*.

Nitr. Ac.	Water.			
10	X 0	1,557	1,557	
	1	1,474	1,474	
	6	1,350	1,273	0,077
	11	1,269	1,191	0,078
	16	1,214	1,147	0,067
	21	1,175	1,120	0,055
	26	1,151	1,101	0,050
	31	1,127	1,087	0,040
	36	1,106	1,077	0,029
	41	1,086	1,068	0,018

There is not the same uniformity in the densities of this acid in its different states of dilution. This seems owing to the variable proportion of the deleterious and vital air which compose this acid. It is more dense in

proportion as it contains more of the latter ingredient.

The proportions of the aeriform ingredients of the muriatic acid are so very variable, and so little under our command, that we cannot frame tables of its specific gravity which would enable us to judge of its strength.

It is a general property of these acids, that they are more expandible by heat as they are more concentrated.

There is another class of fluids which it would be of great consequence to reduce to some rules with respect to specific gravity, namely, the solutions of salts, gums, and resins. It is interesting to the philosopher to know in what manner salts are contained in these watery solutions, and to discover the relation between their strength and density; and to the man of business it would be a most desirable thing to have a criterion of the quantity of salt in any brine, or of extractible matter in a decoction. It would be equally desirable to those who are to purchase them as to those who manufacture or employ them. Perhaps we might ascertain in this way the value of sugar, depending on the quantity of sweetening matter which it contains; a thing which at present rests on the vague determination of the eye or palate. It would therefore be doing a great service to the public, if some intelligent person would undertake a train of experiments with this view. Accuracy alone is required; and it may be left to the philosophers to compare the facts, and draw the consequences respecting the internal arrangement of the particles.

One circumstance in the solution of salts is very general; and we are inclined, for serious reasons, to think it universal: this is a diminution of bulk. This indeed in some salts is inconsiderable. Sedative salt, for instance, hardly shows any diminution, and might be considered as an exception, were it not the single instance. This circumstance, and some considerations connected with our notions of this kind of solution, dispose us to think that this salt differs in contraction from others only in degree, and that there is some, though it was not sensible, in the experiments hitherto made.

These experiments, indeed, have not been numerous. Those of Mr Achard of Berlin, and of Dr Richard Watson of Cambridge, are perhaps the only ones of which we have a descriptive narration, by which we can judge of the validity of the inferences drawn from them. The subject is not susceptible of much accuracy; for salts in their solid form are seldom free from cavities and thivery interstices, which do not admit the water on their first immersion, and thereby appear of greater bulk when we attempt to measure their specific gravity by weighing them in fluids which do not dissolve them, such as spirits of turpentine. They also attach to themselves, with considerable tenacity, a quantity of atmospheric air, which merely adheres, but makes no part of their composition. This escapes in the act of solution, being set at liberty by the stronger affinity of the water. Sal gem, however, and a few others, may be very accurately measured; and in these instances the degree of contraction is very constant.

The following experiments of Dr Watson appear to us the most instructive as to this circumstance. A glass vessel was used, having a slender cylindrical neck, and holding 67 ounces of pure water when filled to a certain

Specific Gravity.

tain mark. The neck above this mark had a scale of equal parts pasted on it. It was filled to the mark with water. Twenty four pennyweights of salt were thrown into it as speedily as possible, and the bulk of the salt was measured by the elevation of the water. Every thing was attended to which could retard the immediate solution, that the error arising from the solution of the first particles, before the rest could be put in, might be as small as possible; and in order that both the absolute bulk and its variations might be obtained by some known scale, 24 pennyweights of water were put in. This raised the surface 58 parts of the scale. Now we know exactly the bulk of 24 pennyweights of pure water. It is 2,275 cubic inches; and thus we obtain every thing in absolute measures: And by comparing the bulk of each salt, both at its first immersion and after its complete solution, we obtain its specific gravity, and the change made on it in passing from a solid to a fluid form. The following table is an abstract of these experiments. The first column of numbers is the elevation of the surface immediately after immersion; the second gives the elevation when the salt is completely dissolved; and the third and fourth columns are the specific gravities of the salts in these two states.

Twenty-four Pennyweights.	I.	II.	III.	IV.
Water -	58			
Glauber's salt -	42	36	1,380	1,611
Mild volatile alkali -	40	33	1,450	1,787
Sal ammoniac -	40	39	1,450	1,487
Refined white sugar -	39	36	1,487	1,611
Course brown sugar -	39	36	1,487	1,611
White sugarcandy -	37	36	1,567	1,611
Lymington Glauber's salt	35	29	1,657	2,000
Terra foliata tartari -	37	30	1,567	1,933
Rochelle salt -	33	28	1,757	2,071
Alum not quite dissolved	33	28	1,757	2,061
Borax not one-half dissolved in two days -	33	31	1,757	
Green vitriol -	32	26	1,612	2,230
White vitriol -	30	24	1,933	2,416
Nitre -	30	21	1,933	2,766
Sal gem from Northwich	27	17	2,143	3,411
Blue vitriol -	26	20	2,230	2,900
Pearl ashes -	25	10	2,320	5,800
Tart. vitriolatus -	22	11	2,636	5,272
Green vitriol calcined to white -	22	11	2,636	5,272
Dry salt of tartar -	21	13	2,761	4,461
Basket sea-salt -	19	15	3,052	3,866
Corrosive sublimate -	14	10	4,42	800
Turbith mineral -	9	0	6,444	

The inspection of this list naturally suggests two states of the case as particularly interesting to the philosopher studying the theory of solution. The first state is when the Exivium approaches to saturation. In the very point of saturation any addition of salt retains its bulk unchanged. In diluted brines, we shall see that the density of the fluid salt is greater, and gradually diminishes as we add more salt. It is an important question, Whether this diminution goes on continually, till the fluid density of the salt is the same with its solid density? or, Whether there is an abrupt passage from some

degree of the one to the fixed degree of the other, as we observe in the freezing of iron, the setting of stucco, and some other instances?

Specific Gravity.

The other interesting state is that of extreme dilution, when the differences between the successive densities bear a great proportion to the densities themselves, and thus enable the mathematician to ascertain with some precision the variations of corpuscular force, in consequence of a variation of distance between the particles. The sketch of an investigation of this important question given by Boscovich, in his Theory of Natural Philosophy, is very promising, and should incite the philosophical chemist to the study. The first thing to be done is to compare the law of specific gravity; that is, the relation between the specific gravity and quantity of salt held in solution.

Wishing to make this work as useful as possible, we have searched for experiments, and trains of experiments, on the density of the many brines which make important articles of commerce; but we were mortified by the scantiness of the information, and disappointed in our hopes of being able to combine the detached observations, suited to the immediate views of their authors, in such a manner as to deduce from them scales (as they may be called) of their strength. We rarely found these detached observations attended with circumstances which would connect them with others; and there was frequently such a discrepancy, nay opposition, in series of experiments made for ascertaining the relation between the density and the strength, that we could not obtain general principles which enable us to construct tables of strength *à priori*.

Mr Lambert, one of the first mathematicians and philosophers of Europe, in a dissertation in the Berlin Memoirs (1762), gives a narration of experiments on the brines of common salt, from which he deduces a very great condensation, which he attributes to an absorption in the weak brines of the salt, or a lodgement of its particles in the interstices of the particles of water. Mr Achard of the same academy, in 1783, gives a very great list of experiments on the bulks of various brines, made in a different way, which show no such intusufception; and Dr Watson, formerly regius professor of chemistry at Cambridge, and now bishop of Landaff, thinks this confirmed by experiments which he narrates in his Chemical Essays. We see great reason for hesitating our assent to either side, and do not think the experiments decisive. We incline to Mr Lambert's opinion; for this reason, that in the successive dilutions of oil of vitriol and aquafortis there is a most evident and remarkable condensation. Now what are these but brines, of which we have not been able to get the saline ingredient in a separate form? The experiments of Mr Achard and Dr Watson were made in such a way that a single grain in the measurement bore too great a proportion to the whole change of specific gravity. At the same time, some of Dr Watson's are so simple in their nature that it is very difficult to withhold the assent.

In this state of uncertainty, in a subject which seems to us to be of public importance, we think it our duty to undertake a train of experiments to which recourse may always be had. Works like this are seldom considered as sources of original information; and it is thought sufficient when the know-  
ledge

Specific Gravity.

ledge already diffused is judiciously compiled. But a due respect for the public, and gratitude for the very honourable reception hitherto given to our labours, induce us to exert ourselves with honest zeal to merit the continuance of public favour. We assure our readers that the experiments were made with care, and on quantities sufficiently large to make the unavoidable irregularities in such cases quite insignificant. The law of density was ascertained in each substance in two ways. We dissolved different portions of salt in the same quantity of water, and examined the specific gravity of the brine by weighing it in a vessel with a narrow neck. The portions of salt were each of them one-eighth of what would make a nearly saturated solution of the temperature 55°. We did not make the brine stronger, that there might be no risk of a precipitation in form of crystals. We considered the specific gravities as the ordinates of a curve, of which the abscissæ were the numbers of ounces of dry salt contained in a cubic foot of the brine. Having thus obtained eight ordinates corresponding to 1, 2, 3, 4, 5, 6, 7, and 8 portions of salt, the ordinates or specific gravities for every other proportion of salt were had by the usual methods of interpolation.

The other method was, by first making a brine nearly saturated, in which the proportion of salt and water was exactly determined. We then took out one-eighth of the brine, and filled up the vessel with water, taking care that the mixture should be complete: for which purpose, besides agitation, the diluted brine was allowed to remain 24 hours before weighing. Taking out one-eighth of the brine also takes out one eighth of the salt; so that the proportion of salt and water in the diluted brine was known. It was now weighed, and thus we determined the specific gravity for a new proportion of salt and water.

We then took out one-seventh of the brine. It is evident that this takes out one-eighth of the original quantity of salt; an abstraction equal to the former. We filled the vessel with water with the same precautions; and in the same manner we proceeded till there remained only one-eighth of the original quantity of salt.

The specific gravities by these two methods agreed extremely well. In the very deliquescent salts the first method exhibited some small irregularities, arising from the unequal quantities of water which they had imbibed from the atmosphere. We therefore confided most in the experiments made with diluted brines.

That the reader may judge of the authority of the tables which we shall insert, we submit to his inspection one series of experiments.

Two thousand one hundred and eighty-eight grains of very pure and dry (but not decrepitated) common salt, prepared in large crystals, were dissolved in 6562 grains of distilled water of the temperature 55°. A small matras with a narrow neck, which held 4200 grains of distilled water, was filled with this brine. Its contents weighed 5027 grains. Now  $6562 + 2188 = 5027 : 1256,75$ . Therefore the bottle of brine contained 1256,75 grains of salt dissolved in 3770,25 grains of water. Its specific gravity is  $\frac{5027}{4200}$ , or 1,196905; and a cubic foot of brine weighs 1196,9 ounces avoirdupois. Also  $5027 : 1256,75 =$

1196,9; 299,28. Therefore a cubic foot of this brine contains 299,28 ounces of perfectly dry salt.

The subsequent steps of the process are represented as follows.

Specific Gravity.

Salt.	Brine.	Water.	Wt. of Cub. Ft.	Salt in Cub. Ft.
8) 1256,75 157,1	8) 5027 628,4	3770,25 = $\frac{1}{8}$ of brine.	1196,9	299,28 37,41 $\frac{1}{8}$
	4398,6 527,4	Remains. Water to fill it again.		
7) 1099,6 157,1	7) 4926,0 703,7	2d Brine. $\frac{1}{7}$ taken out.	1172,7	261,87 37,41
	4222,3 604,7	Water added.		
942,5 157,1	6) 4827,0 804,5	3d Brine. Taken out.	1149,3	224,46
	4022,5 706,5	Remains. Water added.		
785,4 157,1	5) 4729,0 946	4th Brine. Taken out.	1125,9	187,05
	3783 847	Remains. Water added.		
628,3 157,1	4) 4630 1157,5	5th Brine. Taken out.	1102,3	149,64
	3472,5 1054,5	Remains. Water added.		
471,2 157,1	3) 4527 1509	6th Brine. Taken out.	1077,9	112,23
	3018 1405	Remains. Water added.		
314,1 157,1	2) 4423 2212	7th Brine. Taken out.	1053,3	74,82
	2211 2102	Remains. Water added.		
157,0	4313	8th Brine.	1027,9	37,41

Thus, by repeated abstraction of brine, so as always to take out  $\frac{1}{8}$ th of the salt contained in one constant bulk, we have obtained a brine consisting of 157 grains of salt united with 433 - 157, or 4156 grains of water.

Its specific gravity is  $\frac{4313}{4200} = 1,0279$ , and a cubic foot of it weighs 1028 ounces, and contains  $37\frac{1}{8}$  ounces of dry salt. In like manner may the specific gravity, the weight of a cubic foot, and the salt it contains, be estimated for the intermediate brines.

When these eight quantities of salt contained in a cubic foot are made the abscissæ, and the weights of the cubic foot of brine are the corresponding ordinates, the curve

curve will be found to be extremely regular, resembling a hyperbolic arch whose asymptote makes an angle of 30° with the axis. Ordinates were then interpolated analytically for every 10 ounces of contained salt, and thus the table was constructed. We did not, however, rest it on one series alone; but made others, in which 3/4th of the salt was repeatedly abstracted. They agreed, in the case of common salt, with great exactness, and in some others there were some very inconsiderable irregularities.

To show the authority of the tables of strength was by no means our only motive for giving an example of the process. It may be of use as a pattern for similar experiments. But, besides, it is very instructive. We see, in the first place, that there is a very sensible change of density in one or both of the ingredients. For the series is of that nature (as we have formerly explained), that if the ingredients retained their densities in every proportion of commixture, the specific gravities would have been in arithmetical progression; whereas we see that their differences continually diminish as the brines grow more dense. We can form some notion of this by comparing the different brines. Thus in the first brine, weighing 5027 grains, there are 3770 grains of water in a vessel holding 4200. If the density of the water remains the same, there is left for the salt only as much space as would hold 430 grains of water. In this space are lodged 1257 grains of salt, and its specific

gravity, in its liquid form, is  $\frac{1257}{430} = 2,8907$  very nearly. But in the 8th brine the quantity of water is 4156, the space left for 157 grains of salt is only the bulk of 44 grains of water, and the density of the salt is  $\frac{157}{44} = 3,568$ , considerably greater than before. This induced us to continue the dilution of the brine as follows, beginning with the 8th brine.

157	2)4313	8th brine
78,5	2156,5	
	-----	
	2156,5	
	2105,5	
	-----	
78,5	2)4262,0	9th brine
39,7	2131	
	-----	
	2131	
	2102	
	-----	
39,7	2)4233	10th brine
	2116,5	
	-----	
	2116,5	
	2102	
	-----	
19,8	4218	11th brine.

This last brine contains 4198,2 grains of water, leaving only the bulk of 1,8 grains of water to contain 19,8 of salt, so that the salt is ten times denser than water. This will make the strength 243 instead of 210 indicated by the specific gravity. But we do not pretend to measure the densities with accuracy in these diluted brines. It is evident from the process that a single grain of excess or defect in taking out the brine

and replacing it with water has a sensible proportion to the whole variation. But we see with sufficient evidence, that from the strong to the weak brines the space left for the portion of salt is continually diminishing. In the first dilution 527 1/2 grains of water were added to fill up the vessel; but 1/4th of its contents of pure water is only 525; so that here is a diminution of 2 1/2 grains in the space occupied by the remaining salt. The subsequent additions are 604,7; 706 5; 817; 1054,5; 1405; 2102; 2105,5; 2102; 2102; instead of 600; 700; 840; 1050; 1400; 2100; 2100; 2100; 2100. Nothing can more plainly show the condensation in general, though we do not learn whether it happens in one or both of the ingredients; nor do the experiments show with sufficient accuracy the progression of this diminution. The excesses of the added water being only six or seven grains, we cannot expect a nice repartition. When the brine is taken out, the upper part of the vessel remains lined with a briny film containing a portion of salt and water, perhaps equal or superior to the differences. Had our time permitted, we should have examined this matter with scrupulous attention, using a vessel with a still narrower neck, and in each dilution abstracting one half of the brine. The curve, whose abscissæ and ordinates represent the weight of the contained salt and the weight of a constant bulk of the brine, exhibits the best and most synoptical view of the law of condensation, because the position of the tangent in any point, or the

value of the symbol  $\frac{x}{y}$ , always shows the rate at which

the specific gravity increases or diminishes. We are inclined to think that the curve in all cases is of the hyperbolic kind, and complete; that is, having the tangent perpendicular to the axis at the beginning of the curve. The mathematical reader will easily guess the physical notions which incline us to this opinion; and will also see that it is hardly possible to discover this experimentally, because the mistake of a single grain in the very small ordinates will change the position of the tangent many degrees. It was for this reason that we thought it useless to prosecute the dilution any farther. But we think that it may be prosecuted much farther in Dr Watson's or Mr Achard's method, viz. by dissolving equal weights of salt in two vessels, of very different capacities, having tubular necks, in which the change of bulk may be very accurately observed. We can only conclude, that the condensation is greatest in the strongest brines, and probably attains its maximum when the quantities of true saline matter and water are nearly equal, as in the case of vitriolic acid, &c.

We consider these experiments as abundantly sufficient for deciding the question "Whether the salt can be received into the pores of the water, or the water into the pores of the salt, so as to increase its weight without increasing its bulk?" and we must grant that it may. We do not mean that it is simply lodged in the pores as sand is lodged in the interstices of small shot; but the two together occupy less room than when separate. The experiments of Mr Achard were insufficient for a decision, because made on so small a quantity as 600 grains of water. Dr Watson's experiments have, for the most part, the same defect. Some of them, however, are of great value in this question, and are very fit for ascer-

Specific Gravity.

Specific Gravity.

taining the specific gravity of dissolved salts. In one of them (not particularly narrated) he found that a quantity of dissolved salt occupied the same bulk in two very different states of dilution. We cannot pretend to reconcile this with our experiments. We have given these as they stood; and we think them conclusive, because they were so numerous and so perfectly consistent with each other; and their result is so general, that we have not found an exception. Common salt is by no means the most remarkable instance of condensation. Vegetable alkali, sal ammoniac, and some others, exhibit much greater condensation.

We thought this a proper opportunity of considering this question, which is intimately connected with the principles of chemical solution, and was not perhaps considered in sufficient detail under the article CHEMISTRY. We learn from it in general, that the quantities of salt in brines increase at somewhat a greater rate than their specific gravities. This difference is in many cases of sensible importance in a commercial view. Thus an alkaline lixivium for the purposes of bleaching or soap-making, whose specific gravity is 1,234, or exceeds that of water by 234, contains 361 ounces of salt in a cubic foot; a ley, which exceeds the weight of water twice as much, or 468 ounces per cubic foot, contains 777 ounces of salt, which exceeds the double of 361 by 55 ounces more than 7 per cent. Hence we learn, that hydrometers for discovering the strength of brines, having equal divisions on a cylindrical stem, are very erroneous; for even if the increments of specific gravity were proportional to the quantities of salt in a gallon of brine, the divisions at the bottom of the stem ought to be smaller than those above.

The construction of the following table of strengths from the above narrated series of brines is sufficiently obvious. Column 1st is the specific gravity as discovered by the balance or hydrometer, and also is the number of ounces in a cubic foot of the brine. Col. 2d is the ounces of the dry salt contained in it.

TABLE of Brines of Common Salt.

Weight Cub. Ft. Brine.	Salt in Cub. F.	Weight Cub. Ft. Brine.	Salt in Cub. F.
1,000	0	1,115	170
1,008	10	1,122	180
1,015	20	1,128	190
1,022	30	1,134	200
1,029	40	1,140	210
1,036	50	1,147	220
1,043	60	1,153	230
1,050	70	1,159	240
1,057	80	1,165	250
1,064	90	1,172	260
1,070	100	1,178	270
1,077	110	1,184	280
1,083	120	1,190	290
1,090	130	1,197	300
1,096	140	1,203	310
1,103	150	1,206	316
1,109	160	1,208	320

The table differs considerably from Mr Lambert's. The quantities of salt corresponding to any specific gravity are about  $\frac{1}{8}$ th less than in his table. But the reader will see that they correspond with the series of

experiments above narrated; and these were but a few of many which all corresponded within an hundredth part. The cause of the difference seems to be, that most kinds of common salt contain magnesian salts, which contain a very great proportion of water necessary for their crystallization. The salt which we used was of the purest kind, but such as may be had from every salt work, by Lord Dunderdonald's very easy process, viz. by passing through it a saturated solution boiling hot, which carries off with it about  $\frac{1}{4}$ ths of all the bitter salts. Our aim being to ascertain the quantities of pure sea-salt, and to learn by the by its relation to water in respect of density, we thought it necessary to use the purest salt. We also dried it for several days in a stove, so that it contained no water not absolutely necessary for its crystallization. An ounce of such salt will communicate a greater specific gravity to water than an ounce of a salt that is less pure, or that contains extraneous water.

The specific gravity 1,000 is that of ordinary pickles, which are estimated as to strength by floating an egg.

We cannot raise the specific gravity higher than 1,226 by simply dissolving salt in cold water. But it will become much denser, and will even attain the specific gravity 1,240 by boiling, then holding about 365 ounces in the cubic foot of hot brine. But it will deposit by cooling, and when of the temperature 55° or 60°, hardly exceeds 1,206. We obtained a brine by boiling till the salt grained very rapidly. When it cooled to 60°, its specific gravity was 1,2063; for a vessel which held 3506 grains of distilled water held 4229 of this brine. This was evaporated to dryness, and there were obtained 1344 grains of salt. By this was computed the number interposed between 310 and 320 in the table. We have however raised the specific gravity to 1,217, by putting in no more salt than was necessary for this density, and using heat. It then cooled down to 60° without quitting any salt; but if a few grains of salt be thrown into this brine, it will quickly deposit a great deal more, and its density will decrease to 1,206. We find this to hold in all salts; and it is a very instructive fact in the theory of crystallization; it resembles the effect which a magnet produces upon iron filings in its neighbourhood. It makes them temporary magnets, and causes them to arrange themselves as if they had been really made permanent magnets. Just so a crystal already formed disposes the rest to crystallize. We imagine that this analogy is complete, and that the forces are similar in both cases.

The above table is computed for the temperature 55°; but in other temperatures the strength will be different on two accounts, viz. the expansion of the brine and the dissolving power of the water. Water expands about 40 parts in 1000 when heated from 60° to 212°. Saturated brine expands about 48 parts, or  $\frac{1}{2}$ th more than water; and this excess of expansion is nearly proportional to the quantity of salt in the brine. If therefore any circumstance should oblige us to examine a brine in a temperature much above 60°, allowance should be made for this. Thus, should the specific gravity of brine of the temperature 130 (which is nearly half way between 60 and 212) be 1,140, we must increase it by 20 (half of 40); and having found the strength 240 corresponding to this corrected specific gravity, we must correct it again by adding 1 to the specific gravity for every 45 ounces of salt.



Specific Gravity.

Specific Gravity

But a much greater and more uncertain correction is necessary on account of the variation of the dissolving power of water by heat. This indeed is very small in the case of sea-salt in comparison with other salts. We presume that our readers are apprised of this peculiarity of sea-salt, that it dissolves nearly in equal quantities in hot or in cold water. But although water of the temperature 60 will not dissolve more than 320 or 325 ounces of the purest and dryest sea salt, it will take up above 20 ounces more by boiling on it. When thus saturated to the utmost, and allowed to cool, it does not quit any of it till it is far cooled, viz. near to 60°. It then deposits this redundant salt, and holds the rest till it is just going to freeze, when it lets it go in the instant of freezing. If evaporated in the state in which it continues to hold the salt, it will yield above 400 ounces per cubic foot of brine, in good crystals, but rather overcharged with water. And since in this state the cubic foot of brine weighs about 1220 ounces, it follows, that 820 ounces of water will, by boiling, dissolve 400 of crystallized salt.

The table shows how much any brine must be boiled down in order to grain. Having observed its specific gravity, find in the table the quantity of salt corresponding. Call this *x*. Then, since a boiling hot graining or saturated solution contains 340 ounces in the cubic foot of brine, say  $340 : 1000 = x : \frac{1000}{340} x$ . This is the bulk to which every cubic foot (valued at 1000) must be boiled down. Thus suppose the brine has the specific gravity 1109. It holds 160 ounces per foot, and we must boil it down to  $\frac{1000 \times 160}{340}$  or 471; that is, we must boil off  $\frac{529}{1000}$  of every cubic foot or gallon.

These remarks are of importance in the manufacture of common salt; they enable us to appreciate the value of salt springs, and to know how far it may be prudent to engage in the manufacture. For the doctrine of latent heat assures us, that in order to boil off a certain quantity of water, a certain quantity of heat is indispensably necessary. After the most judicious application of this heat, the consumption of fuel may be too expensive.

The specific gravity of sea-water in these climates does not exceed 1,03, or the cubic foot weighs 1030 ounces, and it contains about 41 ounces of salt. The brine-pits in England are vastly richer; but in many parts of the world brines are boiled for salt which do not contain above 10 or 20 ounces in the cubic foot.

In buying salt by weight, it is of importance to know the degree of humidity. A salt will appear pretty dry (if free from magnesia salts) though moistened with 1 per cent. of water; and it is found that incipient humidity exposes it much to farther deliquescence. A much smaller degree of humidity may be discovered by the specific gravity of a brine made with a few ounces of the salt. And the inspection of the table informs us that the brine should be weak; for the differences of specific gravity go on diminishing in the stronger brines: 300 ounces of dry salt dissolved in 897 ounces of water should give the specific gravity 1197. Suppose it be but 1190, the quantity of salt corresponding is only 290; but when mixed with 897 ounces of water, the weight is 1197, although the

weight of the cubic foot is only 1190. There is therefore more than a cubic foot of the brine, and there is as much salt as will make more than a cubic foot of the weight 1190. There is  $290 \times \frac{1197}{1190}$ , or  $291\frac{1}{3}$  ounces, and there is  $8\frac{2}{3}$  ounces of water attached to the salt.

The various informations which we have pointed out as deducible from a knowledge of the specific gravity of the brines of common salt, will serve to suggest several advantages of the knowledge of this circumstance in other lixivia. We shall not therefore resume them, but simply give another table or two of such as are most interesting. Of those alkaline leys are the chief, being of extensive use in bleaching, soap-making, glass-making, &c.

We therefore made a very strong ley of the purest vegetable alkali that is ever used in the manufactories, not thinking it necessary, or even proper, to take it in its state of utmost purity, as obtained from cubic nitre and the like. We took salt of tartar from the apothecary, perfectly dry, of which 3983 grains were dissolved in 3540 grains of distilled water; and after agitation for several days, and then standing to deposit sediment, the clear ley was decanted. It was again agitated; because, when of this strength, it becomes, in a very short time, rarer above and denser at the bottom. A flask containing 4200 grains of water held 6165 of this ley when of the temperature 55°. Its specific gravity was therefore 1,4678, and the 6165 grains of ley contained 3264 grain of salt. We examined its specific gravity in different states of dilution, till we came to a brine containing 51 grains of salt, and 4189 grains of water, and the contents of the flask weighed 4240 grains: its specific gravity was therefore 1,2095. In this train of experiments the progression was most regular and satisfactory; so that when we constructed the curve of specific gravities geometrically, none of the points deviated from a most regular curve. It was considerably more incurvated near its commencement than the curve for sea-salt, indicating a much greater condensation in the diluted brines. We think that the following table, constructed in the same manner as that for common salt, may be depended on as very exact.

Weight of Cub. Foot oz.	Salt cont. oz.	Weight of Cub. Foot oz.	Salt cont. oz.	Weight of Cub. Foot oz.	Salt cont. oz.
1000	0	1224	340	1417	680
1016	20	1236	360	1428	700
1031	40	1248	380	1438	720
1045	60	1259	400	1449	740
1058	80	1270	420	1460	760
1071	100	1281	440	1471	780
1084	120	1293	460	1482	800
1098	140	1305	480	1493	820
1112	160	1317	500	1504	840
1125	180	1329	520	1515	860
1138	200	1340	540	1526	880
1150	220	1351	560	1537	900
1162	240	1362	580	1547	920
1174	260	1372	600	1557	940
1187	280	1384	620	1567	960
1200	300	1395	640	1577	980
1212	320	1406	660	1586	1000

Specific Gravity.

We see the same augmentation of the density of the salt in the diluted brines here as in the case of common salt. Thus a brine, of which the cubic foot weighs 1482 ounces, or which has the specific gravity 1,482, contains 800 ounces of dry alkali and 682 of water. Therefore, if we suppose the density of the water unchanged, there remains the bulk of 318 ounces of water

to receive 840 ounces of salt: its density is therefore  $\frac{800}{318} = 2,512$  nearly. But in the brine whose weight per foot is only 1016 there are 20 ounces of salt, and therefore 996 of water; and there is only four ounce-measures of water, that is, the bulk of four ounces of water, to receive 20 ounces of salt. Its specific gravity therefore is  $\frac{20}{4} = 5$ , almost twice as great as in the strong brine.

Accordingly Mr Achard is disposed to admit the absorption (as it is carelessly termed) in the case of sal tart. But it is a general (we think an universal) fact in the solution of salts. It must be carefully distinguished from the first contraction of bulk which salts undergo in passing from a solid to a fluid form. The contraction now under consideration is analogous to the contraction of oil of vitriol when diluted with water; for oil of vitriol must be considered as a very strong brine which we cannot dephlegmate by distillation, and therefore cannot obtain the dry saline ingredient in a separate form, so as to observe its solid density, and say how much it contracts in first becoming fluid. The way of conceiving the first contraction in the act of solution as a lodging of the particles of the one ingredient on the interstices of the other, "*ou ils se nichent, en augmentant le poids sans affecter le volume de la saumure,*" as Eller and Lambert express themselves, is impossible here, when both are fluids. Indeed it is but a slovenly way of thinking in either case, and should be avoided, because inadvertent persons are apt to use as a physical principle what is merely a mode of speech.

We learn from the table, that a hydrometer with equidistant divisions on a cylindrical or prismatic stem is still more erroneous than in the brines of common salt.

We learn from the experiments of Kirwan, Lavoisier, and others, that dry salt of tartar contains about  $\frac{1}{3}$ th of its weight of fixed air. In many applications of this salt to the purposes of manufacture, this ingredient is of no use. In some it is hurtful, and must be abstracted by lime. Soap-maker's lye consists of the pure alkaline salt dissolved in water. It is therefore of importance to ascertain its quantity by means of the specific gravity of the brine. For this purpose, we took a ley of sal tart. whose specific gravity was 1,20417, containing 314 oz. of mild alkali in a cubic foot of ley, and we rendered it nearly caustic by lime. The specific gravity was then 1,1897. This is a very unexpected result. Nothing is employed with more success than quicklime for dephlegmating any watery fluid. We should rather have expected an increase of specific gravity by the abstraction of some of the water of the menstruum, and perhaps the water of the crystallization, and the aerial part of the salt. But we must ascribe this to the great density in which the fixed air exists in the mild alkali.

It is unnecessary to give similar tables for all the salts, unless we were writing a dissertation on the theory of their solution. We shall only observe, that we examined with particular attention sal ammoniac, because Mr Achard, who denies what is called the absorption of

salts, finds himself obliged to allow something like it in this salt. It does not, however, differ from those of which we have given an account in detail in any other respect than this, that the changes of fluid density are much less than in others (instead of being greater, as Achard's experiments seem to indicate) in all brines of moderate strength. But in the very weak brines there is indeed a remarkable difference; and if we have not committed an error in our examination, the addition of one part of sal ammoniac to 64 of water occupies less room than the water alone. We think that we have met with this as an accidental remark by some author, whose work we do not recollect. But we do not chuse to rest so much on our form of the experiment in such weak brines. The following mixtures will abundantly serve for constructing the table of its strength: Sal ammoniac = 960 grains was dissolved in 3506 grains of water, making a brine of 4466 grains. A phial which held 1600 grains water held 1698 of this brine. It contained  $\frac{1698 \times 960}{4466}$ , or 365 grains of salt. The specific gravity was  $\frac{1698}{1600} = 1,061$ , and the cubic foot weighed

1061 ounces. It also contained  $\frac{1061 \times 365}{1698}$ , or 228 ounces of salt. By repeated abstraction of brine, and replacing with water, we had the following series:

Series.	Brine.	Sp. Gr.	Oz. Salt in Cub. F.
Weight of brine,	1 lb, 1698	1,061	228
After taking out $\frac{1}{3}$ ,	2d, 1676	1,048	171
After taking out $\frac{1}{3}$ ,	3d, 1653	1,033	114
After taking out $\frac{1}{3}$ ,	4th, 1630	1,019	57
After taking out $\frac{1}{3}$ ,	5th, 1616	1,010	23 $\frac{1}{2}$
	$\frac{1}{2}$ , 1610	1,0063	14 $\frac{1}{2}$
	$\frac{1}{2}$ , 1605	1,0038	7 $\frac{1}{8}$

This series is extremely regular, and the progress of density may be confidently deduced from it.

From the whole of this disquisition on the relation between the specific gravities of brines and the quantities of salt contained, we see in general that it may be guessed at, with a useful degree of precision, from the density or specific gravity of saturated solutions. We therefore conclude with a list of the specific gravities of several saturated solutions, made with great care by the bishop of Landaff.—The temperature was 42°. The first numerical column is the density of saturated brine, and the next is the density of a brine consisting of 12 parts (by weight) of water and one of salt. From this may be inferred the quantity in the saturated solution, and from this again may be inferred the quantity corresponding to inferior densities.

Borax,	1,010	
Cor. Sublim.	1,037	
Alum,	1,033	
Glaub. Salt,	1,054	1,029
Common Salt,	1,198	1,059
Sal. cath. amar.	1,232	1,039
Sal ammon.	1,072	1,026
Vol. alk. mite,	1,087	
Nitre,	1,095	1,050
Rochelle salt,	1,114	
Blue vitriol,	1,150	1,052
Green vitriol,	1,157	1,043
White vitriol,	1,386	1,045
Pearl ash,	1,534	

Spectacles  
Spectre.

**SPECTACLES**, in dioptrics, a machine consisting of two lenses set in silver, horn, &c. to assist the defects of the organ of sight. Old people, and others who have flat eyes, use convex spectacles, which cause the rays of light converge so as to meet upon the retina: whereas myopes, or short sighted people, use concave lenses for spectacles, which causes the rays to diverge, and prevent their meeting ere they reach the retina. See **OPTICS**, n<sup>o</sup> 73.

**OCULAR SPECTRA**, images presented to the eye after removing them from a bright object, or closing them. When any one has long and attentively looked at a bright object, as at the setting sun, on closing his eyes, or removing them, an image, which resembles in form the object he was attending to, continues some time to be visible. This appearance in the eye we shall call the ocular spectrum of that object.

These ocular spectra are of four kinds: 1st, Such as are owing to a less sensibility of a defined part of the retina or spectra from defect of sensibility. 2d, Such as are owing to a greater sensibility of a defined part of the retina, or spectra from excess of sensibility. 3d, Such as resemble their object in its colour as well as form; which may be termed direct ocular spectra. 4th, Such as are of a colour contrary to that of their object, which may be termed reverse ocular spectra.

**SPECTRE**, an apparition, something made preternaturally visible to human sight, whether the ghosts of dead men or beings superior to man.

A belief that supernatural beings sometimes make themselves visible, and that the dead sometimes revisit the living, has prevailed among most nations, especially in the rudest stages of society. It was common among the Jews, among the Greeks, and among the Romans, as we find from the Scriptures, and from the poems of Homer and Virgil. Celestial appearances were indeed so often exhibited to the Jews, that the origin of their belief is not difficult to be explained.—The Divine Being manifested himself to each of the Patriarchs by some sensible sign, generally by a flame of fire, as he did to Moses. Under this semblance also did he appear to the Israelites during their abode in the desert, and after they obtained a settlement in the land of Canaan. Nor did they believe that heavenly beings alone assumed a sensible appearance: They believed that deceased men also sometimes revisited this world. When Saul went to consult the witch at Endor, he asked her to bring up the person whom he should name unto her; a proof that he considered his demand as easy to be performed, and therefore that he probably acted under the influence of popular opinion. The same opinions had been generally entertained at a much earlier period; for necromancy and witchcraft, the arts by which the dead were supposed to be raised, had been prohibited while the Israelites were in the wilderness, and yet untainted with the vices of the Canaanites. They must therefore have derived them from Egypt, the cradle of superstition, as well as of the arts and sciences.

Among the Greeks and Romans the apparition of spectres was generally believed. On innumerable occasions the gods are said to have discovered themselves to the eyes of mortals, to have held conferences, and to have interposed their aid. The ghosts of the dead, too, are said to have appeared. When Æneas, amidst the distraction and confusion of his mind in flying from the

destruction of Troy, had lost his wife by the way, he returned in search of her. Her shade appeared to him (for she herself had been slain) with the same aspect as before, but her figure was larger. She endeavoured to assuage the grief of her unhappy husband, by ascribing her death to the appointment of the gods, and by retelling the illustrious honours which yet awaited him. But when Æneas attempted to clasp her in his arms, the phantom immediately vanished into air. From this story we may observe, that the ancients believed that the umbra or shades, retained nearly the same appearance after death as before; that they had so far the resemblance of a body as to be visible; that they could think and speak as formerly, but could not be touched. This description applies equally well to those shades which had passed the river Styx, and taken up their residence in the infernal regions. Such were the shades of Dido, of Deiphobus, and all those which Æneas met with in his journey through the subterraneous world.

It appears from the writings of modern travellers who have visited rude and savage nations, that the belief of spectres is no less common among them. Mr Bruce tells us, that the priest of the Nile affirmed, that he had more than once seen the spirit of the river in the form of an old man with a white beard. Among the Mahometans the doctrine of spectres seems to be reduced to a regular system, by the accounts which they give of genii. Whoever has read the Arabian Nights Entertainments must have furnished his memory with a thousand instances of this kind. Their opinions concerning genii seem to be a corrupted mixture of the doctrines of the Jews and ancient Persians. In Christian countries, too, notwithstanding the additional light which their religion has spread, and the great improvement in the sciences to which it has been subservient, the belief of ghosts and apparitions is very general, especially among the lower ranks. They believe that evil spirits sometimes make their appearance in order to terrify wicked men, especially those who have committed murder.—They suppose that the spirits of dead men assume a corporeal appearance, hover about church yards and the houses of the deceased, or haunt the places where murders have been committed. (See **GHOST**.) In some places it is believed that beings have been seen bearing a perfect resemblance to men alive. In the Highlands of Scotland, what is called the second sight is still believed by many (see **SECOND SIGHT**); viz. that future events are foretold by certain individuals by means of spectral representation.

So general has the belief of spectres been, that this circumstance alone may be thought by some sufficient to prove that it must have its foundation in human nature, or must rest upon rational evidence. When any doctrine has been universally received by all nations, by generations living several thousand years from one another, and by people in all the different stages of society, there is certainly the strongest presumption to conclude that such a doctrine has its foundation in reason and in truth. In this way we argue in favour of the existence of a God, concerning moral distinction, and the doctrine of a future state: and certainly so far we argue well. But if the same argument be applied to idolatry, to sacrifices, or to apparitions, we shall find that it is applied improperly. Idolatry was very general among ancient nations; so was the offering of sacrifices,

Surre.

so was polytheism: but they were by no means universal. Should we allow, for the sake of shortening the argument, that all ancient nations were polytheists and idolaters, and presented oblations to their imaginary deities, all that could be concluded from this concession is, that they fell into these mistakes from their ignorance and from the rude state of society, from which their imperfect knowledge of theology and moral philosophy was never able to rescue them. These erroneous notions fled before the brightness of the Christian system; while the doctrines of the existence of God, of moral distinction, and of a future state, have been more thoroughly confirmed and ascertained. The same thing may be said of the belief of spectres. However generally it has been adopted in the first stages of society, or by civilized nations who had made but little progress in the study of divine things, it has been rejected, we may say invariably, wherever theology and philosophy have gone hand in hand.

As all popular and long established opinions are objects of curiosity and research for the philosopher, we think the belief of spectres worthy of some attention even in this light. It will therefore, we hope, give some satisfaction to the philosophical reader to see a short account of the sources or principles from which this belief is derived. But as the belief of spectres is connected with other opinions which appear to us highly injurious to religion; opinions which have been supported by many learned men, and which are still believed by some men of literary education—it will also be proper, in the first place, to consider the evidence on which this belief rests, in which we must consider both their probability and credibility.

In the present investigation we mean to set aside altogether the celestial appearances recorded in Scripture, as being founded on unquestionable evidence, and perfectly agreeable to those rules by which the Deity acts in the usual course of his Providence. The Israelites, during the existence of their state, were immediately under the authority of God, not only as the moral governor of the world, but as the king of Israel. In the infancy of the world, while men were rude and unenlightened, and entirely under the influence of idolatry, many revelations were necessary to preserve in their minds pure ideas of the nature of God, and of the worship due to Him. They were necessary also to pave the way for that illustrious dispensation which the Lord Jesus came from Heaven to diffuse over the world. Every celestial appearance recorded in Scripture was exhibited for some wise and important purpose, which must be apparent to every person who considers these appearances with attention. But when the Scriptures were written and published, and the Christian religion fully established, revelation ceased, and miracles and heavenly messages were no longer requisite. What credit then ought we to give to those marvellous stories related in ancient authors concerning prodigies in the heavens, and the apparition of angels both good and bad?

It is not pretended that any of those prodigies and appearances were exhibited for purposes equally great and important with those which are described in Scripture: And can we suppose that the all-wise Governor of the World would permit his angels to render themselves visible to the eye of man for no purpose at all, or for a purpose which might have been equally well accomplished

without their interposition? Would this be consistent with perfect wisdom, or would it be consistent even with the excellence and superiority of understanding which we are taught to ascribe to these elevated beings? The whole will of God is revealed to us in the Scriptures; what further use for the visible interposition of angels? It may be objected, Are they not all ministering spirits sent forth to minister for them who shall be heirs of salvation? We answer, That angels may animate and support good men by an invisible interposition. But the Apostle is not speaking of celestial spirits. The word *αγγελοι* signifies “a messenger;” and in Scripture often refers to men. In the passage which we are now reviewing it certainly is applied with much more propriety to men than to angels: for the Apostle is stating a comparison between the *Prophets*, by whom God, at sundry times and in divers manners, spake in time past to the fathers, and *the Son*, by whom he hath spoken in these last days.

And if God has given no commission to his angels to deliver to men since the publication of the Christian religion, is there any probability that he would give any commission or any licence to evil spirits? It will be said, that this doctrine is clearly taught in the New Testament, in these words, “The devil goeth about as a roaring lion seeking whom he may devour.” We will not avail ourselves of the interpretation of some, who say that the word *devil*, which in the Greek language signifies an *adversary*, or *slanderer*, refers here to some human being, who was a violent enemy of the Christians. All that can be deduced from these words, upon the supposition that they refer to a malignant spirit, is merely that he goeth about seducing men to vice. But it is not by assuming a hideous form, and presenting himself to the midnight traveller, that such a purpose is to be accomplished. A spirit may probably have direct access to our minds without the intervention of any thing corporeal; and by exciting our passions may plunge us into vice, which is the only object such a being is supposed to have in view. None of the marvellous stories which we have heard concerning the apparition of evil spirits lead us to conclude that they appear to entice men to commit crimes. We never heard of any evil spirits that required men to steal, to perpetrate robbery or murder. They only appeared to terrify some crazy timorous individuals, who have whims and fancies enough of their own to agitate their minds, though no preternatural vision should ever appear to them. It is not consistent, therefore, with the character of God, and what he has revealed to us of his will, to believe that he would commission good angels, or permit evil angels, to appear to men since the propagation of the gospel, or indeed at any former period of the world, unless some great and mighty purpose was to be fulfilled. It is not consistent with what we know of the nature of good or bad angels to suppose, that though permission were granted them occasionally to show themselves to men, that they would appear in that way which story-tellers describe.

It is equally improbable that the spirits of the dead who have removed from this world should again be permitted to visit it. At death men undergo as great, perhaps a greater change, than when they came first into the light of the sun. Is it not therefore as improbable that a man should return in a visible corporeal form

Surre.

*Spectre.* form after death; as that, after having arrived at manhood, he should return to the state in which he was before his birth? Such changes as these are evidently made permanent by the invariable laws of nature. But suppose it were possible, for what purpose should they return? To describe to us what is passing in the other world, to animate us to virtue, by informing us of the rewards which there await the good; or to alarm us, by describing the punishment of the wicked. These seem important reasons. But Divine Providence has wisely thrown a veil over futurity. We know every thing of the other world from the scripture which it is proper for us at present to know. And as to incentives to virtue, we are already blessed with a number sufficiently great and powerful for moral beings, who are to act from rational motives, and not from compulsion. "He that will not hear Moses and the prophets, will not be persuaded though one rose from the dead"

*John xvi.*

There is one strong objection against the probability of spectres, which is sufficient to prove that they are not intelligent creatures; or at least that they possess but small a degree of intelligence, that they are unqualified to act with prudence, to propose any end to themselves, or use the proper means to accomplish that end. Ghosts often appear in order to discover some crime that has been committed: but they never appear to a magistrate, or person in authority, but to some illiterate clown, who happens to live near the place where the crime was perpetrated; to some person who has no connection with the affair at all, and who in general is the most improper in the world for making the discovery. For instance, in Glanville's *Siducifimus triumphatus* (a book written in the last century by a chaplain of Charles II. in support of the common opinions respecting witchcraft and apparitions), we have the following story: James Haddock, a farmer, was married to Elenor Welsh, by whom he had a son. After the death of Haddock, his wife married one Davis; and both agreed to defraud the son by the former marriage of a lease bequeathed to him by his father. Upon this the ghost of Haddock appeared to one Francis Taverner the servant of lord Chichester, and desired him to go to Elenor Welsh, and to inform her that it was the will of her former husband that their son should enjoy the lease. Taverner did not at first execute this commission; but he was continually haunted by the apparition in the most hideous shapes, which even threatened to tear him in pieces, till at last he delivered the message. Now, had this spectre had the least common sense, it would have appeared first to Elenor Welsh and her husband Davis, and frightened them into compliance at once, and not have kept poor Taverner in such constant inquietude, who had no concern in the matter.

Another very odd circumstance respecting apparitions in general must not be omitted, which is, that they have no power to speak till they are addressed. In the 27th of Glanville's Relations we read of an old woman that appeared often to David Hunter, a neat-herd, at the house of the Bishop of Down and Connor. Whenever she appeared, he found himself obliged to follow her; and for three quarters of a year poor David spent the whole of almost every night in scampering up and down through the woods after this old woman. How long this extraordinary employment might have centi-

nued, it is impossible to guess, had not David's violent fatigue made him one night exclaim, "Lord bless me! would I were dead! - shall I never be delivered from this misery!" On which the phantom replied, "Lord bless me too! It was happy you spoke first, for till then I had no power to speak, though I have followed you so long." Then she gave him a message to her two sons, though David told her he remembered nothing about her. David, it seems, neglected to deliver the message; at which the old beldam was so much provoked, that she returned and hit him a hearty blow on the shoulder, which made him cry out, and then speak to her. Now if she could not speak till David addressed her, why might she not have applied this oratorical medicine the first time she appeared to him? It would have saved both herself and him many a weary journey; and certainly David would much rather have had even half a dozen of blows from her choppy fists than have wanted so many nights sleep. To complete the story, we must add, that when David's wife found it impossible to keep him from following the troublesome visitor, she trudged after him, but never was gratified with a sight of the enchantress. David's little dog too was a dutiful attendant on his master during his pilgrimage.

*Spectre*

It is remarked by Glanville, that ghosts are generally very eager to be gone. Indeed they are often so much so, that they do not stay to tell their errand. One would be induced from this, as well as the circumstances already mentioned, to think that they are the stupidest and dullest of the dead that assume the appearance of ghosts; unless we adopt the ingenious solution of Glanville, "that it is a very hard and painful thing for them to force their thin and tenuous bodies into a visible consistence; that their bodies must needs be exceedingly compressed; and that therefore they must be in haste to be delivered from the unnatural pressure."

With respect to the evidence in favour of spectres, if examined ever so slightly, it will be found very defective. They only appear to one person at a time; they are seen only in the night; they are visible only to ignorant, illiterate, and credulous persons, and never present themselves before men of education and learning.

That spectres only appear to one person at a time, even though there are more in company, is an objection against the credibility of their appearance quite insurmountable. How is it possible that two men of eyesight equally good, directing their eyes to the same spot, should not see so large an object as that of a man or woman at a small distance equally well? Some will tell us that a mist is cast over the eyes of the one, while the view of the other is free from obstruction. But how is this to be proved? and besides what purpose would it serve? Ghosts have seldom any secrets to disclose; they might be proclaimed to a multitude with as much propriety as confined to one person. Shall we be told, that the spectre has the power of becoming visible to some, and of remaining invisible to others? This cannot be allowed without adopting opinions destructive to revealed religion; for it would be a miracle: and we cannot be persuaded, without evidence, that God would empower any inferior being to controul at pleasure the wise laws which he has ordained for governing the world. To him who is of a different opinion, we would

Spectre.

would recommend Farmer on Miracles; a book in which this question is fully examined

Spectres appear only in the night. But why should they shun the light of the sun? Those mischievous ghosts that Glanville mentions might indeed have some reason to choose midnight for the execution of their pranks, as they would be more easily detected in open day. Such was the roguish drummer that haunted Mr Mompesson's house, who beat his drum all night, threw the old gentlewoman's clothes about the room, hid her Bible in the ashes, plucked the clothes off the bed, and amused himself with tossing about Mr Mompesson's shoes. But why should a grave serious ghost appear at midnight? Might it not deliver its message with as much ease and more success in the day-time? In the day-time it would not excite much fear; it would be listened to therefore with more attention; and did it choose to exhibit itself before a number of witnesses, its grievances would be more speedily redressed, because more persons would interest themselves in seeing justice done to the injured ghost.

Spectres not only choose the most improper time, but the most improper persons. To render the testimony of any person credible, he must not only be a man of veracity, but he must have sufficient ability to judge of the subject to which he is to bear witness. It is not on the evidence of an ignorant illiterate person, who has more fancy and fear than judgment, that we are to rest our belief of what is supernatural. It is also worthy of remark, that we have never heard of a ghost appearing to any person who did not previously believe their existence. A man must be prejudiced in favour of this opinion, or he will never see a ghost. But sensible men know, that he who has been accustomed to hear frightful stories of ghosts and apparitions gliding thro' a church yard, or haunting some particular place, can scarcely pass through a church-yard or haunted spot without conjuring up in his imagination the hideous phantoms which he has been accustomed to associate with such places. Is it strange, then, that an ignorant man, with a mind uncultivated and uninformed, with all the prejudices of the nursery about him, should imagine he sees ghosts in those places where he believes they hover, especially in the dead hour of midnight, when, with the slightest aid of the imagination, a cow

may be turned into a monstrous phantom, and the reflection of the beams of the moon from a little water be converted into a ghost with a winding-sheet? But why should apparitions shun men of understanding and learning? Why should learning be formidable to them (A)? It was not so with the celestial messengers mentioned in the Scriptures: they appeared to the patriarchs and prophets; and the miracles there recorded were performed in the most public places, before the eyes of Rabbies, of Scribes, and Pharisees. Indeed this circumstance is sufficient to destroy the evidence of spectres. They have never been seen by any but men of weak or disordered minds, or by men who have previously believed in them.

Having now considered the evidence on which the belief of spectres rests, we will endeavour to give some account of the foundation of it. To trace an opinion that has prevailed so generally in the world to its source, is a labour not unworthy of the philosopher, even tho' the opinion be false. It is always gratifying to detect the causes of error: it is no less useful; for in order to refute error, it is often sufficient to point out the sources from which it has sprung. To reach the origin of the belief of spectres is not more difficult than to account for idolatry or polytheism. In the infant state of the intellectual powers every thing is considered as possessing life and intelligence. The child beats the stool over which he has fallen with the same passion that he would treat his companion: The young girl talks to her doll as if it understood her: The savages ascribe every change which they observe on the face of nature to the action of some animated being. As knowledge advances, they single out those beings which seem to produce the most striking effects, arrange them into some kind of order, and divide the government of the world among them. Unable, at the same time, to conceive any notion of a pure spirit, they imagine those divinities are corporeal beings. This is the foundation of idolatry. The belief of spectres is but another step. That these animated corporeal beings, to whom they address their prayers, and who preside over the world, should on particular occasions display themselves to the human eye, is what they must be previously disposed to expect. Hence the numberless appearances of the heathen gods, of the Persian and Mahometan genii. The belief

Spectre.

(A) The celebrated historian De Thou had a very singular adventure at Saumur, in the year 1593. One night, having retired to rest very much fatigued, while he was enjoying a sound sleep, he felt a very extraordinary weight upon his feet, which, having made him turn suddenly, fell down and awakened him. At first he imagined that it had been only a dream, but hearing soon after some noise in his chamber, he drew aside the curtains and saw, by help of the moon, which at that time shone very bright, a large white figure walking up and down, and at the same time observed upon a chair some rags, which he thought belonged to thieves who had come to rob him. The figure then approaching his bed, he had the courage to ask it what it was. "I am (said it) the Queen of Heaven." Had such a figure appeared to any credulous ignorant man in the dead of night, and made such a speech, would he not have trembled with fear, and have frightened the whole neighbourhood with a marvellous description of it? But De Thou had too much understanding to be so imposed upon. Upon hearing the words which dropped from the figure, he immediately concluded that it was some mad woman, got up, called his servants, and ordered them to turn her out of doors; after which he returned to bed and fell asleep. Next morning he found that he had not been deceived in his conjecture, and that having forgot to shut his door, this female figure had escaped from her keepers, and entered his apartment. The brave Schomberg, to whom De Thou related his adventure some days after, confessed that in such a case he would not have shown so much courage. The king also, who was informed of it by Schomberg, made the same acknowledgement.

*Spectre.* belief of ghosts may be easily deduced from the opinions entertained respecting a future state. These opinions are founded on that essential doctrine of natural religion, that there is another world in which men shall exist when death has removed them hence. This doctrine has been universally received both by savage and civilized nations; but, as might be expected, men have formed very different sentiments concerning the nature of a future state, of the situation and employments of departed spirits, according to the degree of knowledge which they possessed. But the general opinion in ancient and rude nations was, that departed spirits retained the same external appearance, the same passions and principles as before. Nothing therefore was more natural than the opinion, that they might occasionally revisit this world, from an anxious desire to alleviate the sufferings of those beloved friends and relations whom they had left behind them, or to communicate from the unseen world what might be important to their welfare. Upon such an errand did Creusa appear to Æneas. The apparition of the ghosts of murderers is easily explained upon the same general principles. The remorse and horror of mind which the murderer feels are supposed to haunt him in the other world, and to render his situation there intolerable (especially if the murder was never detected and punished), till he return and give information against himself. In this way, then, we think it highly probable the belief of spectres has originated. But many other causes concur to confirm and propagate this belief. These are, imperfect vision united with fear, dreams, opium, diseases, drunkennels, and artifice.

an object, the gigantic appearance it assumed in the eye instantly diminishes, and its apparent magnitude is reduced to its real dimensions. But if, instead of approaching such an object, the spectator flies from it, he can have no other idea of it but from the image which it formed in his eye; and, in this case, he may affirm with truth that he saw an object terrible in its aspect, and enormous in its size. Thus the notions concerning spectres is founded in nature, and depend not, as some philosophers affirm, upon the imagination alone."

*Spectre.*

In addition to these observations of Buffon, we may take notice, that objects are always magnified in a fog; so that when a fog happens in the night-time, objects may be magnified to an enormous size. But, at any rate, whether there be fog in the night or not, there is such a great analogy between darkness and a fog, that if the latter deceive us with respect to the size of objects, the former will also deceive us. The writer of this article was passing the Frith of Forth at Queensferry, near Edinburgh, one morning which was extremely foggy. Though the water be only two miles broad, the boat did not get within sight of the southern shore till it approached very near it. He then saw to his great surprise a large perpendicular rock, where he knew the shore was low and almost flat. As the boat advanced a little nearer, the rock seemed to split perpendicularly into portions, which separated at a little distance from one another. He next saw these perpendicular divisions move; and upon approaching a little nearer, found it was a number of people standing on the beach, waiting the arrival of the ferry-boat.

2. Dreams are another fertile source of apparitions.

1. Indistinct vision is one source of apparitions, especially when the mind is under the influence of fear. It is well known, that the sense of seeing conveys no idea of distance till improved by experience and observation; and how we come at length to distinguish objects at a distance from those that are near, has been explained in another place (see METAPHYSICS, n<sup>o</sup> 50).

In the day-time we seldom commit mistakes, because we know the object at which we look; but at night, when we see objects obscurely, and know not what they are, we have no distinct idea either of their distances or of their magnitude. We may mistake a bush that is near us for a tree at a distance; or if the imagination be under the influence of fear, it will easily convert it into a gigantic figure. "It is generally asserted (says Buffon) that these figures exist only in the imagination; yet they may have a real existence in the eye; for whenever we have no other mode of judging of an unknown object but by the angle it forms in the eye, its magnitude will uniformly increase in proportion to its propinquity. If it appears, when at the distance of 20 or 30 paces, to be only a few feet high, its height, when within two or three feet of the eye, will be many fathoms. An object of this kind must naturally excite terror and astonishment in the spectator, till he approaches and recognises it by actual feeling; for the moment a man knows

it is well known to every person, that while the mind is under the influence of a dream it considers it as much a reality as it does any particular action while awake. Now if a person of a weak superstitious mind should have a very lively dream, which interests his passions, particularly the passion of fear, it may make so deep an impression, that he may be firmly convinced that he has actually seen with his eyes what has only passed before his imagination (See APPARITION) (B). We shall here tell a story, by way of illustration, which we have received on unquestionable authority. An East Indian captain had an honest faithful servant named John, for whom he had a great regard. John died, if we recollect right, on a voyage from England to the East Indies during a French war. As the ship approached the place of its destination the captain had a dream, in which John appeared to him, and earnestly besought him not to sail to the port for which he was bound, as it was in the hands of the French. The captain, though not addicted to superstition, thought it prudent to follow this admonition; and after landing at a different port, he was informed that the place to which he had intended to steer was, according to the information of the dream, captured by the French. On the voyage home, the captain had a second dream, in which John again appeared to him, and gave him notice

4 R

tice

(B) When the thoughts are much troubled, and when a person sleeps without the circumstances of going to bed, or putting off his clothes, as when he nods in his chair, it is very difficult, as Hobbes remarks, to distinguish a dream from a reality. On the contrary, he that composes himself to sleep, in case of any uncouth or absurd fancy, easily suspects it to have been a dream.—*Leviathan*, par. i. c. 1.

Spectre.

tice that he should soon die, and that the ship should be taken in the mouth of the Channel by the French. Next morning the captain called his first mate, told him his dream, which he believed was prophetic, and delivered his papers, that he might take proper care of them after his decease. Every thing happened exactly as the dream had foretold; the captain died, and the vessel was taken by a French man of war in the mouth of the Channel. This dream, wonderful as it appears, is easily explained. In the voyage out to India, nothing was more natural than that the captain should sometimes be thinking, that amidst the various chances of war, the port to which he was bound might be taken; perhaps it was a place of consequence, which the French might be eager to possess. The captain being accustomed to revolve these thoughts in the day time, they would naturally return at night; the regret which he felt for the loss of a faithful servant might mingle with his apprehensions, and thus produce the dream. Perhaps the advice was such as John would have given had he been alive. It is equally easy to explain the cause of the dream in the passage home. The captain, we are told, was very ill, and thought himself dying, at the very time he had the second dream, and therefore did not expect to reach England. This part of the dream, then, was only his own thoughts, delivered by his servant. As to the other part, that his ship should be taken in the mouth of the Channel, it may be thought unaccountable how the very place should be foreseen. But we must recollect, that the mouth of the Channel, being over against the coast of France, was by far the most dangerous place in the whole passage; and that, therefore, the captain had more reason to be afraid of losing his ship there than in any other place. The use which we mean to make of this story is this: Had the captain been a man of a weak mind, he would certainly have considered the dream as a reality, and believed, that instead of having dreamed of the things on which his imagination had dwelled, he had actually seen his servant return from the dead, and heard him deliver the message. But, on the other hand, the captain, though he believed the dream was prophetic, mentioned it without any signs of fear; and no man of courage and reflection ever sees an apparition. This fight is reserved for the weak, the timid, and superstitious. Of this many instances might be mentioned.

3. Spectres are sometimes also occasioned by opium. Gassendi the philosopher found a number of people going to put a man to death for having intercourse with the devil; a crime which the poor wretch readily acknowledged. Gassendi begged of the people that they would permit him first to examine the wizard before putting him to death. They did so; and Gassendi, upon examination, found that the man firmly believed himself guilty of this impossible crime. He even offered to Gassendi to introduce him to the devil. The philosopher agreed; and when midnight came, the man gave him a pill, which he said it was necessary to swallow before setting off. Gassendi took the pill, but gave it to his dog. The man having swallowed his, fell into a profound sleep; during which he seemed much agitated by dreams. The dog was affected in a similar manner. When the man awoke, he congratulated Gaf-

sendi on the favourable reception he had met with from his sible highness. It was with difficulty Gassendi convinced him that the whole was a dream, the effect of soporific medicines, and that he had never stirred from one spot during the whole night.

4. That diseases, especially the night-mare, the hypochondria, hysteric passion, and madness, are another source of spectres, we have the strongest reason to affirm, Persons subject to the night-mare often imagine that they see spectres. This is still more the case with hypochondriac and hysteric persons, and those who are in any degree deranged in their intellects. A fact which fell within the observation of the writer of this article will both prove and illustrate this assertion. In a village in one of the midland counties of Scotland, lived a widow distinguished among her neighbours for decency of manners, integrity, and respect for religion. She affirmed, that for several nights together she had heard a supernatural voice exclaiming aloud, *Murder! murder!* This was immediately reported through the neighbourhood; all were alarmed, and looked around them with solicitude for the detection of the murder which they supposed to have been committed; and it was not long till a discovery seemed actually to be made. It was reported, that a gentleman, who had relations at no great distance, and had been residing in the West Indies, had lately arrived with a considerable fortune; that he had lodged in an inn about three miles off; and that he had afterwards been seen entering a house in the village where the widow lived, from which he had never returned. It was next affirmed, that a tradesman passing the church-yard about twelve at midnight had seen four men carry a dead corpse into that cemetery. These three facts being joined together seemed perfectly to agree and to confirm one another, and all believed some horrible murder had been committed. The relations of the gentleman thought they were called upon to make inquiry into the truth of these allegations: they accordingly came first to the church-yard, where, in company with the sexton, they examined all the graves with great care, in order to discover whether any of them had been lately dug, or had the appearance of containing more than one coffin. But this search was to no purpose, for no alteration had been made upon the graves. It was next reported that the murdered man had been buried in a plantation about a mile distant from the village. As the alarm was now very general, a number of the inhabitants proposed of their own accord to explore it. They accordingly spread themselves over the wood, and searched it with care, but no grave nor new dug earth was found. The writer of this article, who was then a boy at school, was along with them. The matter did not rest here: The person who was said to have seen four men carry a dead corpse into the church-yard at midnight was summoned to appear before a meeting of the justices of the peace. Upon examination he denied any knowledge of the affair, but referred the court to another person from whom he had received his information. This person was examined, and the result was the same as the former. In short, one person had heard it from another, who had received it from a third, who had heard it from a fourth; but it had received a little embellishment from every person who repeated



repeated it. It turned out to be the same with Smollet's story of the three black crows, which some body was said to have vomited.

Upon inquiry at the inn where the West Indian gentleman had lodged, no such gentleman had been seen there. It was found afterwards he had never left the West Indies. Still, however, the veracity of the widow was not disputed; and some dark and secret transaction was suspected. But the whole affair was at length explained by discovering that she was somewhat deranged by melancholy. And the cries which she had at first imagined she had heard were afterwards imitated by some roguish person, who was highly amused with spreading terror among the credulous.

5. Drunkenness also has the power of creating spectres. Its natural effect in most cases is to derange the understanding, to throw it off its guard, and to give full scope to that passion which has a natural disposition to gain an ascendancy; and sometimes it excites passions which scarcely seem to exist at any other time. It makes some men licentious, some furious, some all benevolence and kindness, some from being cowards it renders undaunted heroes. It seldom, if ever, excites fear; and therefore it may be thought strange that men should imagine they see ghosts when intoxicated. But it must be remarked, that the ghosts which the drunkard sees, he sees not with the same alarm and terror as men who are sober. He is not afraid of them. He has the courage to converse with them, and even to fight with them, if they give him provocation. A man returning home intoxicated, assumed that he had met with the devil; and that after a severe encounter he had vanquished him and brought him to the ground, to which he had nailed him fast by driving his staff through his body. Next morning the staff was found stuck with great violence into a heap of turfs!

6. Many apparitions of spectres have no other origin than the artifices of the waggish or self-interested. Dr Plot, in his Natural History of Oxfordshire, relates a marvellous story, which will illustrate this assertion. Soon after the murder of King Charles I. a commission was appointed to survey the king's house at Woodstock, with the manor, park, woods, and other demesnes to that manor belonging; and one Collins, under a feigned name, hired himself as secretary to the commissioners, who, upon the 13th of October 1649, met, and took up their residence in the king's own rooms. His majesty's bed-chamber they made their kitchen, the council-hall their pantry, and the presence-chamber was the place where they sat for the dispatch of business. His majesty's dining-room they made their wood-yard, and stored it with the wood of the famous royal-oak from the High Park, which, that nothing might be left with the name of king about it, they had dug up by the roots, and split and bundled up into faggots for their firing. Things being thus prepared, they sat on the 16th of the same month for the dispatch of business; and in the midst of their first debate there entered a large black dog (as they thought), which made a dreadful howling, overturned two or three of their chairs, and then crept under a bed and vanished. This gave them the greater surprise, as the doors were kept constantly locked, so that no real dog could get in or out. The next day their surprise was increased, when sitting at dinner in a lower room, they heard plainly the noise

of persons walking over their heads, though they well knew the doors were all locked, and there could be no body there. Presently after they heard also all the wood of the king's oak brought by parcels from the dining-room, and thrown with great violence into the presence chamber; as also all the chairs, stools, tables, and other furniture, forcibly hurled about the room; their papers, containing the minutes of their transactions were torn, and the ink-glass broken. When all this noise had ceased, Giles Sharp, their secretary, proposed to enter first into these rooms; and in presence of the commissioners, from whom he received the key, he opened the doors, and found the wood spread about the room, the chairs tossed about and broken, the papers torn, the ink-glass broken (as has been said), but not the least tract of any human creature, nor the least reason to suspect one, as the doors were all fast, and the keys in the custody of the commissioners. It was therefore unanimously agreed, that the power who did this mischief must have entered the room at the key-hole. The night following, Sharp the secretary, with two of the commissioners servants, as they were in bed in the same room, which room was contiguous to that where the commissioners lay, had their bed's feet lifted up so much higher than their heads, that they expected to have their necks broken, and then they were let fall at once with so much violence as shook the whole house, and more than ever terrified the commissioners. On the night of the 19th, as all were in bed in the same room for greater safety, and lights burning by them, the candles in an instant went out with a sulphureous smell, and that moment many trenchers of wood were hurled about the room, which next morning were found to be the same their honours had eaten on the day before, which were all removed from the pantry, though not a lock was found opened in the whole house. The next night they still fared worse; the candles went out as before, the curtains of their honours beds were rattled to and fro with great violence; their honours received many cruel blows and bruises, by eight great pewter-dishes and a number of wooden trenchers being thrown on their beds, which being heaved off, were heard rolling about the room, though in the morning none of these were to be seen. This night likewise they were alarmed with the tumbling down of oaken billets about their beds, and other frightful noises; but all was clear in the morning, as if no such thing happened. The next night the keeper of the king's house and his dog lay in the commissioners room, and then they had no disturbance. But on the night of the 22d, though the dog lay in the room as before, yet the candles went out, a number of brick-bats fell from the chimney into the room, the dog howled piteously, their bed clothes were all stripped off, and their terror increased. On the 24th they thought all the wood of the king's oak was violently thrown down by their bed-sides; they counted 64 billets that fell, and some hit and shook the beds in which they lay; but in the morning none were found there, nor had the door been opened where the billet wood was kept. The next night the candles were put out, the curtains rattled, and a dreadful crack like thunder was heard; and one of the servants running in haste, thinking his master was killed, found three dozen of trenchers laid smoothly under the quilt by him. But all this was nothing to what succeeded afterwards: The

Specul.

29th, about midnight, the candles went out, something walked majestically through the room, and opened and shut the windows; great stones were thrown violently into the room, some of which fell on the beds, others on the floor; and at about a quarter after one a noise was heard as of forty cannon discharged together, and again repeated at about eight minutes distance. This alarmed and raised all the neighbourhood, who coming into their honours room, gathered up the great stones, fourscore in number, and laid them by in the corner of a field, where, in Dr Plot's time, who reports this story, they were to be seen. This noise, like the discharge of cannon, was heard through all the country for 16 miles round. During these noises, which were heard in both rooms together, the commissioners and their servants gave one another over for lost, and cried out for help; and Giles Sharp, snatching up a sword, had well nigh killed one of their honours, mistaking him for the spirit, as he came in his shirt from his own room to theirs. While they were together, the noise was continued, and part of the tiling of the house was stript off, and all the windows of an upper room were taken away with it. On the 30th at midnight something walked into the chamber treading like a bear; it walked many times about, then threw the warming-pan violently on the floor; at the same time a large quantity of broken glass, accompanied with great stones and horses bones, came pouring into the room with uncommon force. These were all found in the morning to the astonishment and terror of the commissioners, who were yet determined to go on with their business. But on the first of November the most dreadful scene of all ensued: Candles in every part of the room were lighted up, and a great fire made; at midnight, the candles all yet burning, a noise like the burbling of a cannon was heard in the room, and the burning billets were tossed about by it even into their honours beds; who called Giles and his companions to their relief, otherwise the house had been burnt to the ground; about an hour after the candles went out as usual, the crack as if many cannon was heard, and many pailsful of green stinking water were thrown upon their honours beds; great stones were also thrown in as before, the bed curtains and bedsteads torn and broken, the windows shattered, and the whole neighbourhood alarmed with the most dreadful noises; nay, the very rabbit-stealers that were abroad that night in the warren were so terrified, that they fled for fear and left their ferrets behind them. One of their honours this night spoke, and, in the name of God, asked what it was, and why it disturbed them so? No answer was given to this; but the noise ceased for a while, when the spirit came again; and, as they all agreed, brought with it seven devils worse than itself. One of the servants now lighted a large candle, and set it in the door-way between the two chambers, to see what passed; and as he watched it, he plainly saw a hoof striking the candle and candle-tick into the middle of the room, and afterwards making three scrapes over the snuff, scraped it out. Upon this the same person was so bold as to draw a sword; but he had scarce got it out when he felt another invisible hand holding it too, and pulling it from him; and at length prevailing, struck him so violently on the head with the pummel, that he fell down for dead with the blow. At this instant was heard another burst like

the discharge of the broadside of a ship of war, and at about a minute or two's distance each no less than 19 more such: these shook the house so violently, that they expected every moment it would fall upon their heads. The neighbours, on this, as has been said, being all alarmed, flocked to the house in great numbers, and all joined in prayer and psalm-singing; during which the noise still continued in the other rooms, and the discharge of cannons was heard as from without, though no visible agent was seen to discharge them. But what was the most alarming of all, and put an end to their proceedings effectually, happened the next day as they were all at dinner, when a paper, in which they had signed a mutual agreement to reserve a part of the premises out of the general survey, and afterwards to share it equally amongst themselves, (which paper they had hid for the present under the earth in a pot in one corner of the room, and in which an orange-tree grew), was consumed in a wonderful manner, by the earth's taking fire with which the pot was filled, and burning violently with a blue fume, and an intolerable stench; so that they were all driven out of the house, to which they could never be again prevailed upon to return.

This wonderful contrivance was all the invention of the memorable Joseph Collins of Oxford, otherwise called *Funny Joe*, who having hired himself as secretary, under the name of *Giles Sharp*, by knowing the private traps belonging to the house, and the help of *pulvis fulminans* and other chemical preparations, and letting his fellow-servants into the scheme, carried on the deceit without discovery to the very last; inasmuch that the late Dr Plot, in his *Natural History*, relates the whole for fact, and concludes in this grave manner, "That though tricks have been often played in affairs of this kind, many of the things above related are not reconcileable with juggling; such as the loud noises, beyond the power of man to make without such instruments as were not there; the tearing and breaking the beds; the throwing about the fire; the hoof treading out the candle; and the striving for the sword, and the blow the man received from the pummel of it."

SPICULARIS LAPIS, in natural history, a genus of talcs, composed of large plates visibly separate, and of extreme thinness; and each fissile again separated into a number of plates still finer. (See TALC.) Of this genus there are three species: 1. The white shining specularis, with large and broad leaves, commonly called *isnglass* and *Muscovy glass*; its lamellæ, or leaves, are extremely thin, elastic, and transparent; it makes not the least effervescence with aquafortis, and is not easily calcined in the fire. It is imported in great quantities; the miniature-painters cover their pictures with it; the lantern-makers sometimes use it instead of horn; and minute objects are usually preserved between two plates of it, for examination by the microscope. 2. The bright brown specularis, with broad leaves; a very valuable species, though inferior to the former. 3. The purple bright specularis, with broad leaves, which is the most elegant of all the talcs, and not less beautifully transparent than the first kind.

SPICULATIVE, something relating to the theory of some art or science, in contradistinction to practical.

SPICULUM for reflecting telescopes, is made of a kind of white copper consisting of 32 parts fine

**Speculum** || **Speed.**  
 red copper, 1 of brass, 15 of grain-tin, and 3 of white arsenic. The process given by the late J. Edwards, who was rewarded by the Board of Longitude for disclosing it to the public, was published in the Nautical Almanack for 1787, and is as follows: Melt the copper in a large crucible, employing some black flux, composed of two parts of tartar and one of nitre; when melted, add to it the brass and the silver. Let the pure tin be melted in another crucible, also with some black flux. Take them both from the fire, and pour the melted tin into the fused mass in the large crucible. Stir the whole well with a dry spatula of birch, and pour off the fused metal immediately into a large quantity of cold water. The sudden chill of the water will cause the fluid metal to divide into an infinite number of small particles, which will cool instantly.

*Cronstedt's  
 Mineralogy,  
 vol. ii.  
 p. 712.*

2. If the copper be completely saturated, the fracture of one piece of this mixed metal will appear bright, and of a glossy look, resembling the face of pure quicksilver. But if it is of a brown reddish colour, it wants a little more tin. To ascertain the required proportion, melt a small quantity, known by weight, of the mixed metal, with a known very small part of tin; and, if necessary, repeat the trial with different dozes, till the fracture of the new mixture looks as already described. Having now ascertained the necessary addition of tin that is required, proceed to the last melting of the whole metal, together with the additional proportional dose of tin; fuse the whole, observing the same cautions as before; and you will find that the mixture will melt with a much less heat than that for the first fusion. Have ready as many ounces of white arsenic in coarse powder as there are pounds in the weight of the metal; wrap up the arsenic in a small paper, and put it, with a pair of tongs, into the crucible; stir it well with the spatula, retaining the breath to avoid the arsenical fumes or vapours (which however are not found to be hurtful to the lungs) till they disappear; take the crucible off the fire, clear away the dross from the top of the metal, pour in about one ounce of powdered rosin, with as much nitre, in order to give the metal a clean surface, and pour out the metal into the moulded flasks.

3. The speculum should be moulded with the concave surface downwards, and many small holes should be made through the sand upwards, to discharge the air. The moulding sand from Highgate near London, used by the founders, is as good as any for casting these metallic mirrors. The cast metal should be taken out from the sand of the flasks whilst it is hot, or else it may happen to crack if left to cool within. See TELESCOPE.

**SPECULUM**, a looking glass or mirror, capable of reflecting the rays of the sun.

**SPECULUM**, in surgery, an instrument for dilating a wound, or the like, in order to examine it attentively. See SURGERY.

**SPEECH**, in general, the art or act of expressing a person's thoughts by means of articulate sounds, which we call words. See LANGUAGE, GRAMMAR, READING, and ORATORY, part iv.

**SPEED** (John), an eminent English historian, was born at Farington, in Cheshire, in 1542. He was by profession a taylor, and freeman of the company of merchant-tailors in the city of London. In 1606, he pub-

lished his Theatre of Great Britain, which was afterwards reprinted in folio, under the title of the *Theatre of the Empire of Great Britaine*. His Genealogies of Scripture were first bound up with the Bible in 1611, when the first edition of the present translation was printed. In 1614 appeared his *History of Great Britaine*, which has been translated into Latin; and in 1616 he published his *Cloud of Witnesses*, in octavo. He lived in marriage 57 years with his wife, by whom he had twelve sons and six daughters; and died in 1629. He was interred in the church of St Giles's, Cripplegate, London, where a monument was erected to his memory.

**Speedwell** || **Spelling.**

**SPEEDWELL**, in botany. See VERONICA.

**SPELL**, a charm consisting of some words of occult power, generally attended with some ceremony.— In order to explain it, we will produce a few examples. On St Agnes's night, 21st of January, take a row of pins, and pull out every one, one after another, saying a Pater-noster on sticking a pin in your sleeve, and you will dream of him or her you shall marry.

Another method to see a future spouse in a dream. The party inquiring must lie in a different county from that in which he commonly resides, and on going to bed must knit the left garter about the right-legged stocking, letting the other garter and stocking alone; and as he rehearses the following verses, at every comma knit a knot:

This knot I knit,  
 To know the thing I know not yet;  
 That I may see  
 The man (woman) that shall my husband (wife) be;  
 How he goes, and what he wears,  
 And what he does all days and years.

Accordingly, in a dream, he will appear with the insignia of his trade or profession.

Another, performed by charming the moon, thus: At the first appearance of the new moon, immediately after the new year's day, (though some say any other new moon is as good), go out in the evening, and stand over the spars of a gate or stile, and, looking on the moon, repeat the following lines:

All hail to the moon! all hail to thee!  
 I prithee, good moon, reveal to me  
 This night who my husband (wife) must be.

Immediately after you must go to bed, when you will dream of the person destined for your future husband or wife.

**SPELLING**, in grammar, that part of orthography which teaches the true manner of resolving words into their syllables.

All words are either simple or compound, as *use*, *disuse*; *done*, *undone*; and the rules for dividing each must be such as are derived from the analogy of language in general, or from the established custom of speaking; which, for the English language, are reduced to the following rules: 1. A consonant between two vowels must be joined with the latter in spelling, as *na-ture*, *ve-ri-ly*, *ge-ne-rous*; except, however, the letter *x*, which is joined to the first, as in *flax-en*, *ox-en*, &c. and compound words, as *in-up-on*, *un-yield*, &c. 2. A double consonant must be divided, as in *let-ter*, *man-ner*, &c. 3. These consonants which can begin a word must not be parted in spelling, as in *de-fraud*,

Spelman *re-prove, distinct*; however, this rule is found sometimes to fail; for though *gn* begins a word, as *gnaw, gnat, &c.* yet it must be divided in spelling, as in *cognizance, malignity, &c.* 4. Those consonants which cannot begin a word must be divided, as *ld* in *seldom, li* in *multitude, mp* in *temper, rd* in *ardent*; but in final syllables there are exceptions, as *tl* in *title, dl* in *handle, &c.* 5. When two vowels come together, and are both of them distinctly founded, they must be separated in spelling, as in *co-eval, mutual, &c.* 6. The grammatical terminations or endings must be separated in spelling, as *ed* in *wing-ed, edst* in *de-li-ver-edst, ing* in *hair-ing, ance* in *de-li-ver-ance, &c.* 7. Compound words must be resolved into their simple or component words, as *up-on, in-to, ne-ver-the-less, not-with-stand-ing, &c.*

SPELMAN (Sir Henry), an eminent English antiquarian, was descended from an ancient family, and born at Cengham, near Lynn in Norfolk, about the year 1561. He was knighted by king James I. who had a particular esteem for him on account of his known capacity for business; and he employed him several times in Ireland on public affairs. When he was about 50 years of age, he went to reside in London; where falling into a study to which his own genius had always inclined him, he collected all such books and MSS. as concerned the subject of antiquities, either foreign or domestic. In 1626, he published the first part of his well-known Glossary, which he never carried beyond the letter L; because, as some have suggested, he had said things under "Magna charta," and "Maximum consilium," that could not then have appeared without giving offence. Upon his death all his papers came into the hands of his son Sir John Spelman, a gentleman who had abilities to have completed his father's design, if death had not prevented him. The second part was afterwards published by Sir William Dugdale; but with all the marks of a scanty unfinished performance. The next work he entered upon was an edition of the English Councils, of which he published the first volume about two years before his death, leaving the second volume, as well of this as of his Glossary, to be published by Sir William Dugdale. Sir Henry wrote several other things, all relating to ancient laws and customs, and died in 1641. His Posthumous Works were published in folio, 1698, under the inspection of Mr Gibson, afterwards bishop of London.

SPELTER, in metallurgy, the same with ZINC.

SPENCE (Joseph), was fellow of New College, Oxford, where he took the degree of A. M. in 1727. About that time he became first known as an author, by an *Essay on Pope's Odyssey, in which some particular beauties and blemishes of that work are considered*; a work of great merit, and which for sound criticism and candid disquisition is almost without a parallel. He was elected professor of poetry by the university in 1728, and held that office ten years, which is as long as the statutes will allow. His History of Stephen Duck was first published in 1731; but it was afterwards much altered, and prefixed to an edition of Duck's poems.

About this time he travelled into Italy as tutor to the earl of Lincoln, afterwards duke of Newcastle.— In 1736 he republished Gorboduc, at Mr Pope's desire, with a preface giving an account of the author, the earl of Dorset. He quitted his fellowship in 1742, up-

on being presented by the Society of New College to the rectory of Great Harwood in Buckinghamshire.— He never resided in his living; but paid it an annual visit, distributing large sums of money among the poor, and providing for many of their children. The same year he was made professor of modern history at Oxford. In 1747 he published *Polymetis*; or an inquiry concerning the agreement between the works of the Roman poets and the remains of ancient artists, being an attempt to illustrate them mutually from each other. This work was treated by Gray with a contempt which it did not deserve. He raises objections because the author did not illustrate his subject from Greek writers; that is, because he failed to execute what he never undertook. He was installed prebendary of the seventh stall at Durham the 24th May 1754. He published the same year, "An Account of the Life, Character, and Poems, of Mr Blacklock, student of philosophy at Edinburgh;" which was afterwards prefixed to his Poems. The prose pieces which he printed in the Museum he collected and published, together with some others, in a pamphlet called *Moralities*, by Sir Harry Beaumont. Under the same name he published "Crito, or a dialogue on beauty;" and "A particular Account of the Emperor of China's Gardens near Peking, in a letter from F. Attiret, a French missionary now employed by that Emperor to paint the apartments in those gardens, to his friend at Paris." Both these treatises are printed in Doddsley's fugitive pieces, as is also "A Letter from a Swifts Officer to his friend at Rome;" which Mr Spence first published in the Museum. In 1758 he published "A Parallel, in the Manner of Plutarch, between a most celebrated man of Florence and one scarce ever heard of in England." This was also inserted in the fugitive pieces. The same year he made a journey into Scotland, which he described in an affectionate letter to Mr Shenilone, published in Hall's Collection of Letters, 1778. In 1764 he was very well described by Mr James Ridley, in his admirable Tales of the Genii, under the name of *Phefoi Ecneps* (his name read backwards), dervise of the groves. A letter from Mr Spence to that ingenious moralist, under the same signature, is preserved in the 3d volume of "Letters of Eminent Persons." In 1768 he published "Remarks and Dissertations on Virgil, with some other classical observations, by the late Mr Holdsworth." On the 20th of August the same year he was unfortunately drowned in a canal in his garden at Byfleet in Surrey. He was found flat upon his face at the edge of the canal, where the water was so shallow as not even to cover his head. The accident, it was supposed, for he was quite alone, was owing to a fit.

The duke of Newcastle possesses some manuscript volumes of anecdotes collected by Mr Spence, from which Dr Johnson was permitted to insert many extracts in his Lives of the Poets.

SPENCER (Dr John), an eminent divine, was born in Kent in 1630, and educated at Cambridge. He was chosen fellow of his college, and took a doctor's degree in 1663. In 1667 he was chosen matter of Corpus Christi College, and preferred to the deanery of Ely in 1677. He died on the 20th of May 1695. His works are, 1. The Righteous Ruler; a sermon on Proverbs xxix. 2. preached June 28. 1660. 2. A Discourse concerning Prodiges, wherein the vanity of presages by them is reprehended, and their true and proper ends asserted and vindicated

Spenser. vindicated. To this excellent work was afterwards added, A Discourse concerning vulgar prophecies, wherein the vanity of receiving them as the certain indications of any future event is exposed; and some marks of distinction between true and pretended prophets are laid down. 3. A Latin Dissertation concerning Urim and Thummin. 4. His famous treatise *De legibus Hebræorum ritualibus et earum rationibus*. The intention of this book, as he informs us himself, was to vindicate the Deity from the imputation of acting from arbitrary and fantastical motives. It has been highly and justly esteemed both for the elegance of style and the uncommon erudition and sound sense which it displays. It has, however, (that part of it particularly which endeavours to deduce some of the Jewish ceremonies from the practices of their heathen neighbours), alarmed many persons, as if such a doctrine, if it could be proved, would derogate from the Divine wisdom, and undermine revelation. But this is so far from being the case, that Dr Spenser's attempt, whether successful or not, deserves the gratitude of Christians, because it has a tendency to throw light on an important and difficult subject.

SPENSER (Edmund), the poet, was born in London in the year 1553, and descended from an ancient family of the Spensers in Northamptonshire. All we know concerning his education is, that he was admitted a sizer of Pembroke-hall in Cambridge, and matriculated in 1569. At this time began his intimacy with Mr Gabriel Harvey, a man of genius and a poet. In 1576, having completed his degrees in arts, he left the university, as it is conjectured, for want of subsistence, and retired to the north of England. Here he had the misfortune to become enamoured of his Rosalind, who, after flattering his passion for a time, at length preferred his happier rival. Spenser continued in the country till the year 1578, when at the persuasion of his friend Mr Harvey he removed to London, where that gentleman introduced him to Mr Sidney (afterwards Sir Philip Sidney). Concerning his first introduction to Sir Philip, there is indeed a different story, which was first told by the writer of his life, prefixed to his works in 1679, and transcribed by Hughes, Cibber, and several others; which, nevertheless, is certainly not true. The purport of it is, that Spenser, being unknown to this Mœœnas of the age, went to Leicester-house, and sent in the 9th canto of the first book of the Fairy Queen; that, on reading part of it, Sir Philip ordered his steward to give the bearer 50l.; on reading a little farther 50l. more; then 200l. bidding him to make haste and pay the money, lest he should give the poet his whole estate. The story tells prettily enough; but it is very certain, that the Fairy Queen was begun long after his acquaintance with Sir Philip. By this universal patron of genius, however, he was presented to queen Elizabeth, who honoured him with the place of poet-laureat. About this time he finished his Shepherd's Calendar, which was first printed in 1579; and in the following year, being recommended by his patron to the earl of

Leicester, he went to Ireland as secretary to the lord Grey of Wilton, then appointed lord-lieutenant of that kingdom. Lord Grey was recalled in 1582, and with him Spenser returned to London, where he continued till after the death of Sir Philip Sidney in 1586; a loss which he bewailed to the end of his life. The following year, our poet, having obtained a royal grant of 3000 acres of forfeited lands in the county of Cork in Ireland, set out for that kingdom, took possession of his estate, and fixed his residence in the castle of Kilkolman, which had belonged to the earl of Desmond. In this retirement he resumed his great work of the Fairy Queen; and continued in Ireland till, being visited by his old friend Sir Walter Raleigh in 1589, he came over with him to England, but returned to Ireland the year following, where he fell in love with a country girl, and married her. Soon after his marriage, he paid another visit to his native country, where we also find him in 1596. In the following year he returned once more to Kilkolman; but on the rebellion of Lord Tyrone, who ravaged the whole county of Cork, he was obliged to fly for safety with his family to England, where, in the year 1599, he died in extreme poverty (A). He was buried in Westminster Abbey, according to his request, near Chaucer. A monument was erected to his memory by Ann countess of Dorset. We know but little of his character as a man; as a poet, considering the age in which he lived, he deserves our utmost veneration. He wrote various pieces besides those above-mentioned. His whole works, with his life by Hughes, were published in six volumes 12mo, in 1715 and 1750.

SPERGULA, SPURRY, in botany: A genus of plants belonging to the class of *decandria*, and the order of *pentagynia*; and in the natural system arranged under the 22d order, *caryophyllex*. The calyx is pentaphyllous; the petals five, and undivided; the capsule oval, unilocular, and containing five valves. There are five species, the *arvensis*, *nodosa*, *pentandra*, *laricina*, and *faginoïdes*; all of which are British: 1. The *arvensis*, corn-spurry, has linear furrowed leaves, from eight to twenty in a whirl. The flowers are small, white, and terminal. It is frequent in corn-fields. In Holland it is cultivated as food for cattle, and has the advantage of growing on the very poorest soils; but does not afford a great deal of food. Poultry are fond of the seeds; and the inhabitants of Finland and Norway make bread of them when their crops of corn fail. Horses, sheep, goats, and swine, eat it. Cows refuse it.

2. The *nodosa*, knotted spurry. Several stalks arise from one root, sometimes reclining and sometimes erect, and from three to five inches high. The leaves are smooth, of a fine green, narrow, pointed, and opposite. The flowers are white, terminal, with yellow antheræ.

3. *Pentandra*, small spurry. The leaves are very narrow, and grow in whorls at the joints. The seeds are black with a white circle. It flowers in July.

4. *Laricina*, larch-leaved spurry. Several stalks arise

(A) This is Camden's account, and it has been generally believed; but Mr Malone, the last editor of Shakespeare's works, by examining the patent roll, 33 Eliz. p. 3. has discovered, that in February 1790-1 Spenser obtained from Queen Elizabeth an annuity or pension of L. 50 during his life; a sum equivalent to L. 200 at present.

Sperm.  
Spermaceti

arise from one root, from an inch to an inch and a half high; the leaves are linear, subulate, and acuminate, somewhat hairy on the edges, and their points turned to one side of the stalk. The petals are white and about the length of the calyx. Lightfoot found this species on a hill in the isle of Bute. He is doubtful whether the *Sagina procumbens*, var.  $\beta$  of Linnæus, be not the same plant with this. It flowers in July.

5. *Saginoides*, pearlwort spurrey, has smooth, linear, opposite leaves: the peduncles are solitary and very long. Aiton says it is a native of England, and flowers from June to August.

SPERM, the seed whereof an animal is formed. See **PHYSIOLOGY**.

SPERMACETI, a whitish, unctuous, flaky substance, prepared from oil, but chiefly from the brains of a species of whale called *Physiter macrocephalus*.

The method of preparing spermaceti is kept a secret; but the process is said to be this: The brains being taken out of the animal, are then, as some say, melted over a gentle fire, poured into moulds, and when cold melted again; and this process is continued till they are purified. Others say, that after being pressed and drained they are more thoroughly purified by steeping them in a ley of alkaline salt and quicklime. The brains are then washed, and cut into thin flakes or slices with wooden knives. One fish is said to afford some tons of brains. Good spermaceti is glossy and semitransparent, in fine white flakes; soft and unctuous to the touch, yet dry and friable; in taste, somewhat like butter, and of a faint smell like that of tallow. Some adulterate it with wax; but the deceit is discovered, either by the smell of the wax or by the dulness of the colour. Some also sell a preparation of oil taken from the tail of the whale instead of that from the brain; but this kind turns yellow as soon as exposed to the air. Indeed it is apt in general to grow yellowish, and to contract a rancid fishy smell if not carefully secured from the air. The more perfectly it has been purified at first, the less susceptible it is of these alterations; and after it has been changed, it may be rendered white and sweet again by steeping it afresh in a ley of alkaline salt and quicklime. It melts in a small degree of heat, and congeals again as it cools.

Spermaceti is of use in medicine. Quincy says it is a noble remedy in the asthma, &c. though chiefly used in bruises, inward hurts, and after delivery. For internal use, it may be dissolved in aqueous liquors into the form of an emulsion, by trituration with almonds, the yolk or white of an egg, and more elegantly by mucilages; or made into a loloeh, by mixing two drams of it with a suitable quantity of yolk of egg, then adding half an ounce of fresh drawn oil of almonds, and an ounce of balsamic syrup. Spermaceti is not capable of being dissolved by caustic alkalis, and of forming soaps, like other oily matters: but it is altogether soluble in oils, and unites by liquefaction with wax and resins; and in these forms is applied externally. But it is certain, its greatest property, and that which makes it so much in vogue in many places, is its softening the skin. Whence it comes to be used by the ladies in pastes, washes, &c.

Spermaceti candles are of modern manufacture: they are made smooth, with a fine gloss, free from rings and scars, superior to the finest wax-candles in colour and

lustre; and, when genuine, leave no spot or stain on the finest silk, cloth, or linen.

A method has been lately proposed by Mr Smith Gibbes of Magdalen college, Oxford, to convert animal muscle into a substance much resembling spermaceti. The process is remarkably simple: Nothing more is necessary than to take a dead carcass and expose it to a stream of running water: it will in a short time be changed to a mass of fatty matter. To remove the offensive smell, a quantity of nitrous acid may then be poured upon it, which uniting with the fetid matter, the fat is separated in a pure state. This acid indeed turns it yellow, but it may be rendered white and pure by the action of the oxygenated muriatic acid. Mr Gibbes brought about the same change in a much shorter time. He took three lean pieces of mutton and poured on them the three mineral acids, and he perceived that at the end of three days each was much altered; that in the nitrous acid was much softened, and on separating the acid from it, he found it to be exactly the same with that which he had before got from the water; that in the muriatic acid was not in that time so much altered; the vitriolic acid had turned the other black.

SPERMACOCE, BURTON-WOOD, in botany: A genus of plants belonging to the class of *tetrandria*, and order of *monogynia*; and in the natural system arranged under the 47th order, *stellate*. The corolla is monopetalous and funnel-shaped, and there are two bidentate seeds. The species are eight, tenuior, verticillata, hirta, articularis, stricta, luspida, procumbens, and spinosa.

SPERMATIC, in anatomy, something belonging to the sperm or seed.

SPEUSIPPUS, an Athenian philosopher, the nephew and successor of Plato. Contrary to the practice of Plato, Speusippus required from his pupils a stated gratuity. He placed statues of the graces in the school which Plato had built. On account of his infirm state of health, he was commonly carried to and from the academy in a vehicle. On his way thither he one day met Diogenes, and saluted him; the surly philosopher refused to return the salute, and told him, that such a feeble wretch ought to be ashamed to live; to which Speusippus replied, that he lived not in his limbs, but in his mind. At length, being wholly incapacitated, by a paralytic stroke, for the duties of the chair, he resigned it to Xenocrates. He is said to have been of a violent temper, fond of pleasure, and exceedingly avaricious. Speusippus wrote many philosophical works, which are now lost, but which Aristotle thought sufficiently valuable to purchase at the expence of three talents. From the few fragments which remain of his philosophy, it appears that he adhered very strictly to the doctrine of his master.

SPEY, a river of Scotland, rising from a lake of the same name in Badenoch, and, after a serpentine course of 76 miles, passes by Rothes castle, and falls into the German sea at Garroch near Elgin. Mr Pennant tells us, that the Spey is a dangerous neighbour to Castle Gordon, overflowing frequently in a dreadful manner, as appears by its ravages far beyond its banks. The bed of the river is wide and full of gravel, and the channel very shifting. In 1746 the duke of Cumberland passed this river at Belly church, near Castle Gordon, when the channel was so deep as to take an officer, from whom

Spermaceti  
Spey.Phil. Trans.  
1794.

whom Mr Pennant had the account, and who was six feet four inches high, up to the breast. The banks are here very high and steep; so that had not the rebels been infatuated in such a manner as to neglect opposition, the passage must have been attended with considerable loss. On this river there is a great salmon-fishery; about 1700 harrels full are caught in the season, and the shore is rented for about 1200*l.* per annum.

SPHACELUS, in surgery and medicine, an absolute and perfect corruption or death of the parts.

SPHÆRANTHUS, in botany: A genus of plants belonging to the class of *syngenesia*, and to the order of *polygamia segregata*; and in the natural system arranged under the 49th order, *Compositæ*. Each partial calyx contains eight florets; the florets are tubulated, the female being scarcely distinguishable. The receptacle is scaly; and there is no pappus. The species are three, the indicus, africanus, and chinensis.

SPHAGNUM, BOG-MOSS, in botany; a genus of plants belonging to the class of *cryptogamia* and order of *musci*. The antheræ are globose; the mouth entire and closed by an operculum; the calyptra is wanting. There are three species, the palustre, alpinum, and arboreum, 1. The *palustre*, common bog-moss, grows on our bogs in wide patches, so as frequently, to cover a large portion of their surface. The stalks are from two inches to two feet long, irregularly surrounded with numerous, conical, pendant branches, and terminated with a roseaceous cluster of erect short ones. It is generally believed, that the roots and decayed stalks of this moss constitute a principal part of that useful bituminous substance called *peat*, which is the chief fuel of the northern regions.—The Lapland matrons are well acquainted with this moss. They dry and lay it in their cradle, to supply the place of bed, bolster, and every covering; and, being changed night and morning, it keeps the infant remarkably clean, dry, and warm. It is sufficiently soft of itself; but the tender mother, not satisfied with this, frequently covers the moss with the downy hairs of the rein-deer; and by that means makes a most delicate nest for the young babe. 2. The *alpinum*, green bog-moss. Its branches are subulate and erect; the antheræ are oval. It grows in mountain bogs in South Britain. 3. The *arboreum*, creeping bog-moss, is branched; the antheræ are numerous, sessile, hairy, and grow along the branches chiefly on one side. It is found on the trunks of trees.

Os SPHENOIDES, the seventh bone of the cranium or skull. See ANATOMY, n° 11.

SPHERE, is a solid contained under one uniform round surface, every point of which is equally distant from a certain point in the middle called its *centre*; and is formed by the revolution of a semicircle about its diameter. See GEOMETRY.

*Projection of the SPHERE.* See PROJECTION.

SPHERE, in astronomy, that concave orb or expanse which invests our globe, and in which the heavenly bodies appear to be fixed, and at an equal distance from the eye.

The better to determine the places of the heavenly bodies in the sphere, several circles are supposed to be described on the surface thereof, hence called the *circles of the sphere*: of these some are called *great circles*, as the equinoctial, ecliptic, meridian, &c. and others *small*

*circles*, as the tropics, parallels, &c. See GEOGRAPHY; and ASTRONOMY, *passim*.

*Armillary SPHERE.* See GEOGRAPHY.

*SPHERE of Activity of a Body*, is that determinate space or extent to which, and no farther, the effluvia continually emitted from that body reach; and where they operate according to their nature.

SPHERES, in optics, the same with metalline mirrors, for telescopes or other purposes. See MIRROR.

SPHEROID, in geometry, a solid approaching to the figure of a sphere. It is generated by the entire revolution of a semi-elliptic about its axis. When the revolution is made round the largest axis, the spheroid is called *prolate*; and when round the shortest, *oblate*. This last is the figure of the earth, and probably of all the planets.

SPHEX, ICHNEUMON WASP, or *Savage*; a genus of insects belonging to the order of *hymenoptera*. The mouth is armed with entire jaws, but contains no tongue; the mandibles are horny, crooked, dentated; the lip horny, the apex membranaceous. The palpi or feelers are four. The antennæ have from 10 to 16 joints. The wings of both sexes are extended without folds, and laid horizontally on the back. The sting is sharp, and concealed within the abdomen. There are 97 species, of which two only are natives of Britain and Ireland, the *viatica* and *cribraria*. 1. The *viatica* is black: the antennæ are short and thick: the three first segments of the abdomen red-brown: the pedicel is short: the length half an inch. 2. The *cribraria* is black, with yellow ringlets on the abdomen: the antennæ are short, and turned backwards: the fore-legs are broad, with an appendix like a shield.

The manner of living is different in the various species, and so is the general form of the body and their haunts; but though the method of life be utterly different, yet the same manners appear innate and inherent in all. They agree in being the fiercest of all flies: they will attack insects much larger than themselves, and this whether they be defenceless or armed, as they are provided with a sting. The strength in all this savage kind is great; their jaws are hard and sharp, and in their sting lies a poison suddenly fatal to the creatures with whom they engage. The savage seizes hardily on the animal he attacks, and gives a stroke of amazing force; after which he falls down as if himself were killed, but it is to rest from his fatigue, and enjoy his victory. He keeps a steady eye on the creature he has struck till it dies, which happens in a few minutes, and then drags it to the nest to feed the young. The number of other insects they destroy is scarce to be conceived; the mouth of their cave is like that of a giant in the days of yore, strewed with the remains of prey. The eyes, the filament that serves as a brain, and a small part of the contents of the body, are all the savage eats, and will kill 50 for a meal.

SPHINCTER, in anatomy, a term applied to a kind of circular muscles, or muscles in form of rings, which serve to close and draw up several orifices of the body, and prevent the excretion of the contents.

SPHINX (fab. hist.), a monster which had the head and breasts of a woman, the body of a dog, the tail of a serpent, the wings of a bird, the paws of a lion, and an human voice. It sprang from the union of Orthos

Sphere  
||  
Sphæra.

**Sphinx.** with the Chimæra, or of Typhon with Echidna. The Sphinx had been sent into the neighbourhood of Thebes by Juno, who wished to punish the family of Cadmus, which she persecuted with immortal hatred, and it laid this part of Bœotia under continual alarms, by proposing enigmas, and devouring the inhabitants if unable to explain them. In the midst of their consternation the Thebans were told by the oracle, that the sphinx would destroy herself as soon as one of the enigmas she proposed was explained. In this enigma she wished to know what animal walked on four legs in the morning, two at noon, and three in the evening. Upon this Creon king of Thebes promised his crown and his sister Jocasta in marriage to him who could deliver his country from the monster by a successful explanation of the enigma. It was at last happily explained by Œdipus, who observed, that man walked on his hands and feet when young, or in the morning of life, at the noon of life he walked erect, and in the evening of his days he supported his infirmities upon a stick. (*Vid. Œdipus*). The sphinx no sooner heard this explanation than she dashed her head against a rock, and immediately expired. Some mythologists wish to unridle the fabulous traditions about the sphinx by the supposition that one of the daughters of Cadmus, or Laius, infested the country of Thebes by her continual depredations, because she had been refused a part of her father's possessions. The lion's paw expressed, as they observe, her cruelty, the body of the dog her lasciviousness, her enigmas the snares she laid for strangers and travellers, and her wings the dispatch she used in her expeditions.

Among the Egyptians the sphinx was the symbol of religion, by reason of the obscurity of its mysteries; and on the same account the Romans placed a sphinx in the pronaos or porch of their temples. Sphinxes were used by the Egyptians to show the beginning of the water's rising in the Nile: with this view, as it had the head of a woman and body of a lion, it signified that the Nile began to swell in the months of July and August, when the sun passes through the signs of Leo and Virgo. There are several of these still to be seen; one in particular, near the pyramids, much spoken of by the ancients; being of a prodigious size, and cut out of the rock; the head and neck appear only at present, the rest of the body being hid in the sand. This, according to Thevenot, is 26 feet high, and 15 feet from the ear to the chin: but Pliny assures us, the head was no less than 102 feet in circumference, and 62 feet high from the belly, and that the body was 143 feet long, and was thought to be the sepulchre of king Amasis.

The learned Mr Bryant\* observes, that the sphinx seems to have been originally a vast rock of different strata; which, from a shapeless mass, the Egyptians fashioned into an object of beauty and veneration. The Egyptians used this figure in their building; from them the Greeks derived it, and afterwards improved it into an elegant ornament. It is also frequently used in modern architecture.

It is proper to observe, that the sphinx of the Egyptians is said in the Asiatic Researches † to have been found in India. Colonel Pearse was told by Murari Pandit, a man of learning among the Hindoos, that the sphinx there called *singh* is to appear at the end of the

world, and as soon as he is born will prey on an elephant: he is therefore figured seizing an elephant in his claws; and the elephant is made small, to show that the *singh*, even a moment after his birth, will be very large in proportion to it. But in opposition to this account given by Murari Pandit, the late Sir William Jones, the learned and illustrious president of the Asiatic Society, was assured by several Brahmans, that the figure taken for a sphinx was a representation of a lion seizing a young elephant. This point therefore requires farther investigation.

**SPHINX, Hawk-Moth,** in natural history; a genus of insects belonging to the order of *lepidoptera*. The antennæ are shaped somewhat like a prism, and are more slender at each end than at the middle. The tongue is generally thrust out: the two palpi are bent back, and the wings deflexed. There are about 165 species already discovered, of which 10 are found in Great Britain and Ireland.

1. The *ocellata*, eyed willow hawk-moth. There is no trunk; the wings are indented. Above, 1st wings dark and light-brown, marbled; 2d, red, with a large yellow-black eye. Beneath, a large red triangle from the base of the 1st wings. The breadth one inch and an half. Caterpillar smooth, green, with oblique white lines on the sides, and a posterior horn. The eggs are green. It lives on willows.
2. *Populi*, poplar hawk-moth. The wings are scalloped, bluish grey, and waved with dark lines. On the 1st wings a long white spot, and the base of the 2d red-brown. Wings reversed. Length one inch. A long spiral trunk caterpillar green, smooth, with oblique white spots, and a posterior horn. It lives on poplars and willows.
3. *Tilia*, lime hawk-moth. No trunk: the wings are scalloped: the antennæ are white on the upper side, yellow on the under. Above, 1st wings grey-brown, with two irregular large green spots; 2d, wings orange. Beneath greenish grey. Caterpillar green, shagreened, with a posterior horn.
4. *Convolvuli*, unicorn, or bindweed hawk-moth. The antennæ are long and thick: the trunk very long and spiral. Above, body marked with black and red belts; wings entire, brown grey, with black zig-zag transverse lines. The breadth three inches. Caterpillar smooth, green, with a posterior horn.
5. *Ligustri*, privet hawk-moth. The antennæ are long, thick, and brown. Trunk long, spiral. 1st wings two inches long, narrow, entire, brown; 2d, short, red, with black bars. The abdomen is red, with black rings. Caterpillar smooth, yellow-green, with a posterior horn.
6. *Atropis*, jessamine hawk-moth. The wings are entire: the trunk long, spiral. Above, 1st wings brown, clouded with grey and yellow, and a yellowish spot in the centre; 2d, yellow, with two waved transverse stripes. The abdomen is yellow, with seven black-brown belts. The thorax marked like a Death's head. Length two inches. Caterpillar very large, yellow, with six green and orange oblique belts, and a posterior horn.
7. *Elephonor*, elephant moth. The wings are angular, entire. Above, 1st wings striped transversely with red and green; 2d, black at the base, and red outwards. The body red and green. Caterpillar smooth, brown and yellow, with a posterior horn, and a snout like a hog. It lives on vines, convolvulus, &c.
8. *Stellatarum*, large bee moth. The antennæ are thick towards the ends, brown.

Lempriere's  
Bibliotheca  
Classica.

\* Ancient  
Mythology,  
vol. iii.  
p. 532.

† Vol. ii.  
p. 334.



*Sphinx*, *izelia* brown. The trunk is spiral: the wings are short and entire: the body is thick, brown, and hairy. First wings are brown, waved; 2d, red brown. It resembles a large bee. Caterpillar smooth, with a posterior blue horn, tipped with red. It lives on gallium. 9. *Tipuliformis*, small bee moth. The thorax is yellow beneath: the wings are short, with black veins. The abdomen black, bearded, yellow at the extremity. Caterpillar on the lonicera. 10. *Filipendule*, burnet moth. The antennæ, legs, and body, are black. Second wings red, with a greenish border. First wings bluish green, with six red spots, in pairs. Length eight lines. Caterpillar yellow, with black spots. It lives on grass.

The name *sphinx* is given to this genus on account of the singular attitudes of their caterpillars, who apply the hinder part of their body to a branch of a tree, holding the rest of it erect, like the fabulous sphinx. Most of them spin their cocoon under ground, making them up with small parcels of earth and grains of corn interwoven with threads. The sphinges fly either early in the morning, or after sunset in the evening. They fly heavily and sluggishly, often emitting a kind of sound.

**SPIGELIA, WORM-GRASS**, in botany: A genus of plants belonging to the class of *pentandria*, and order of *monogynia*; and in the natural system arranged under the 47th order, *Stellata*. The corolla is funnel-shaped; the capsule is didymous, bilocular, and polyipermous. There are two species, the *anthelmia* and *marilandica*.

The *anthelmia* has a herbaceous stem, and its highest leaves are fourfold.

"The effects of this medicine (says Dr Browne) are these: It first procures sleep, almost as certainly, and in an equal degree, with opium; the eyes seem to be distended, and sparkle as it were before the eruption of the small-pox or measles, which may be easily observed after the sleep is over; the pulse grows regular and rises, the fever cools, the symptoms appear more favourable, and the worms are generally discharged by the use of the subsequent purgatives (if not before) in great quantities, often above 100 at a time; but when a few only come away, which is seldom, and these alive, the same doses are again repeated, which seldom or never fail. I never saw this medicine fail when there was the least probability of success; nay, often prove successful when there was not the least reason to expect it. I have been, however, cautious in ordering it for children; for though I never knew it at all hurtful, its effect upon the eyes has often deterred me from ordering it to children, whose fibres are weak and relaxed, and in whom the fevers from this source are seldom so vehement as to hinder the administration of other medicines, likely as effectual in other cases of this nature. This plant is generally had in low dry lands, after they have been turned up some months, and after great rains; its taste is herbaceous, and somewhat clammy, its growth is soft and sudden, its stalk hollow, smooth, and roundish. Its herbaceous taste and sudden growth would alone make me think it capable of little or no action, had not hundreds of careful observations satisfied me to the contrary."

The *marilandica*, perennial worm-grass, or Indian pink. The best description of this plant which we have seen is given by Dr Woodville, in his Medical Botany;

a work which exhibits a complete systematic view of the medicinal effects of vegetables. Its stem is four-cornered; all the leaves opposite.

*Spigelia*,  
Spice.

Dr Garden, in a letter to the late Dr Hope, professor of botany in the university of Edinburgh, dated 1763, gives the following account of the virtues of this plant. "About 40 years ago, the anthelmintic virtues of the root of this plant were discovered by the Indians; since which time it has been much used here by physicians, practitioners, and planters; yet its true dose is not generally ascertained. I have given it in hundreds of cases, and have been very attentive to its effects. I never found it do much service, except when it proved gently purgative. Its purgative quality naturally led me to give it in febrile diseases, which seemed to arise from viscosity in the *primæ viæ*; and, in these cases, it succeeded to admiration, even when the sick did not void worms.

"I have of late, previous to the use of the Indian pink, given a vomit, when the circumstances of the case permitted it; and I have found this method answer so well, that I think a vomit should never be omitted. I have known half a dram of this root purge as briskly as the same quantity of rhubarb; at other times I have known it, though given in large quantities, produce no effect upon the belly: in such cases, it becomes necessary to add a grain or two of sweet mercury, or some grains of rhubarb; but it is to be observed, that the same happy effects did not follow its use in this way, as when it was purgative without addition. The addition, however, of the purgative renders its use safe, and removes all danger of convulsions of the eyes, although neither *ol. rute*, *fabinae*, or any other nervous substance, is given along with it. It is, in general, safer to give it in large doses than in small; for, from the latter, more frequently the giddiness, dimness of the sight, and convulsions, &c. follow; whereas, from large doses, I have not known any other effect than its proving emetic or violently cathartic. To a child of two years of age, who had been taking 10 grains of the root twice a-day, without having any other effect than making her dull and giddy, I prescribed 22 grains morning and evening, which purged her briskly, and brought away five large worms. After some months an increased dose had the same good effects. I prefer the root to the other parts of the plant; of which, when properly dried, I gave from 12 to 60 or 70 grains in substance. In infusion, it may be given to the quantity of two, three, or four drams, twice a-day. I have found that, by keeping, the plant loses its virtue in part; for 40 grains of the root which has not been gathered above two months, will operate as strongly as 60 which has been kept for 15 months."

In Dr Garden's subsequent letters, addressed to Dr Hope, in the years 1764 and 1766, the efficacy of this root in worm cases is further confirmed; and he observes, that the root keeps better than he at first thought (having lately used it several years old with great success). In what he calls continued or remitting low worm fevers, he found its efficacy promoted by the addition of *rad. serpentar virg.*

**SPICE**, any kind of aromatic drug that has hot and pungent qualities: such are pepper, nutmeg, ginger, cinnamon, cloves, &c.

Spice  
||  
Spinal

*Spice-Islands*, in the East Indies. See *BAMBA*, *MOLUCCA-Islands*, and *CEYLON*.

**SPIDER**, in zoology. See *ARANEA*.

**SPIDERWORT**, in botany. See *PHALANGIUM*.

**SPIGNEL**, in botany. See *ATHAMANTA*.

**SPIKE**, or *Oil of SPIKE*, a name given to an essential oil distilled from lavender, and much used by the varnish-makers and the painters in enamel.

**SPIKENARD**, in botany. See *NARDUS*.

**SPILANTHUS**, in botany; a genus of plants belonging to the class of *syngenesia*, and to the order of *polygamia equalis*. The common calyx is erect; the leaflets numerous, sub-equal, and oblong, the two exterior being longer than the rest. The compound corolla is uniform and tubular; the florets are hermaphrodite and equal; the proper corolla is funnel-shaped. The filaments are five in number, and short. The antheræ cylindrical and tubular. The seeds are vertical, oblong, flat, and covered with chaff. The receptacle is paleaceous and conical. There are seven species, the *urens*, *pseudo-acmella*, *acmella*, *salivaria*, *atriplicifolia*, *inspida*, and *oleracea*.

**SPINA CERVINA**, the same as the *rharnnus catharticus*. See *RHAMNUS*.

**SPINA Ventosa**, in surgery, that species of corruption of the bones which takes its rise in the internal parts, and by degrees enlarges the bone, and raises it into a tumor. See *SURGERY*.

**SPINACIA**, *SPINAGE*, in botany: A genus of plants belonging to the class of *diaïo*, and to the order of *pentandria*; and in the natural system arranged under the 12th order, *Holoracea*. The male calyx is quinquepartite; there is no corolla; the female calyx is quadrifid; no corolla; there are four styles, and one seed within the indurated calyx. There are only two species, the *oleracea* and *vera*. 1. The *oleracea*, common spinage, has sessile fruits and sagittated leaves. It has been cultivated in Britain since 1568, but it is not known from what country it was originally brought. When intended for winter use, it should be sown on an open spot of ground in the latter end of July; observing to do it if possible when the weather is rainy. When the young plants are come up, the weeds must be destroyed, and the plants left at about five inches asunder. The ground being kept clear of weeds, the spinage will be fit for use in October. The way of gathering it to advantage is only to take off the longest leaves, leaving those in the centre to grow bigger; and at this rate a bed of spinage will furnish the table for a whole winter, till the spinage sown in spring is become fit for use, which is common in April. 2. The *vera*, wild spinage, produces its fruit on footstalks.

**SPINAGE**, or *SPINACH*. See *SPINACIA*.

**SPINÆ**, in botany, thorns, rigid prickles: a species of *armis*, growing on various parts of certain plants for their defence; *spina ramorum arcent pecora*. On the branches we find examples in the *pyrus*, *prunus*, *citrus*, *hippophæes*, *gmelina*, *rharnnus*, *lycium*, &c.; on the leaves in the *aloe*, *agave*, *yucca*, *ilex*, *hippomane*, *theophrasta*, *carlina*, &c.; on the calyx, in the *carduus*, *enicus*, *centaurea*, *molluccella*, *galeopsis*, &c.; on the fruit, in the *trapa*, *tribulus*, *inurex*, *spinacia*, *agiemonia*, *datura*, &c.

**SPINAL MARROW**. See *ANATOMY*, Part V. n° 132.

**SPINALIS**, in anatomy, the name of several muscles, &c. of the spine.

**SPINDLE-TREE**, in botany. See *EUONYMUS*.

**SPINE**, *SPINA DORSI*. See *ANATOMY*, n° 30.

**SPINE**, in botany. See *SPINÆ*.

**SPINELLO**, a Tuscan painter, of great repute in his time. He painted a picture of the fallen angels, in which he drew so horrid a picture of *Lucifer*, that it frightened him so much as to affect his senses ever after. He flourished about the year 1380.

**SPINET**, or *SPINETT*, a musical instrument ranked in the second or third place among harmonious instruments. It consists of a chest or belly made of the most porous and resinous wood to be found, and a table of fir glued on slips of wood called *summers*, which bear on the sides. On the table is raised two little prominences or bridges, wherein are placed so many pins as there are chords or strings to the instrument. It is played on by two ranges of continued keys, the former range being the order of the diatonic scale, and that behind the order of the artificial notes or semitones. The keys are so many flat pieces of wood, which, touched and pressed down at the end, make the other raise a jack which strike and sound the strings by means of the end of a crow's quill, wherewith it is armed. The 30 first strings are of brass, the other more delicate ones of steel or iron-wire; they are all stretched over the two bridges already mentioned. The figure of the spinet is a long square or parallelogram; some call it an *harp couched*, and the harp an *inverted spinet*. See the article *HARP*.

This instrument is generally tuned by the ear, which method of the practical musicians is founded on a supposition that the ear is a perfect judge of an octave and a fifth. The general rule is to begin at a certain note, as C, taken towards the middle of the instrument, and tuning all the octaves up and down, and also the fifths, reckoning seven semitones to each fifth, by which means the whole is tuned. Sometimes to the common or fundamental play of the spinet is added another similar one in unison, and a third in octave to the first, to make the harmony the fuller; they are either played separately or together by means of a stop: these are called *double* or *triple spinets*; sometimes a play of violins is added, by means of a bow, or a few wheels parallel to the keys, which press the strings and make the sound last as long as the musician pleases, and heighten and soften them more or less, as they are more or less pressed. The harpsichord is a kind of spinet, only with another disposition of the keys (see the article *HARPSICHORD*). The instrument takes its name from the small quill ends which touch the strings, resembling *spina* or thorns.

**SPINIFEX**, in botany; a genus of plants belonging to the class of *polygamia* and order of *monœia*. The hermaphrodite flowers have a calyx with bivalved biflorous glumes, the valvelets being parallel to the rachis; the corolla is bivalved and awnless; there are three stamina and two styles. In the male flowers the calyx is common with the hermaphrodite; the corolla and stamina are similar. There is only one species, the *squarrosus*.

**SPINNING**, in commerce, the act or art of reducing silk, flax, hemp, wool, hair, or other matters, into thread. Spinning is either performed on the wheel, or with a distaff and spindle, or with other machines proper

Spina  
||  
Spinal





Spinning  
||  
Spinoza.

Spinoza.

proper for the several kinds of working. Hemp, flax, nettle-thread, and other like vegetable matters, are to be wetted in spinning: silks, wools, &c. are spun dry, and do not need water; yet there is a way of spinning or reeling silk as it comes off the cases or balls, where hot and even boiling water is to be used (see *SILK*). The vast variety, and the importance of those branches of our manufactures, which are produced from cotton, wool, and flax, spun into yarn, together with the cheapness of provisions, and the low price of labour in many foreign countries, which are our rivals in trade, have occasioned many attempts at home to render spinning more easy, cheap, and expeditious. For which see *COTTON Spinning* and *COTTON Mills*.

Transf. of  
the Society  
for the en-  
couragement  
of Arts, &c.

These contrivances have in some parts of Scotland been applied to the spinning of flax; but a very considerable improvement has lately been made by Mr Antis of Fulneck near Leeds of the common spinning wheel. It is well known, that hitherto much time has been lost by stopping the wheel in order to shift the thread from one staple on the flyer to another; but in Mr Antis's wheel the bobbin is made to move backwards and forwards, so as to prevent the necessity of this perpetual interruption; as well as to obviate the danger of breaking the thread and losing the end. This is effected by the axis of the great wheel being extended through the pillar next the spinner, and formed into a pinion of one leaf A, which takes into a wheel B, seven inches diameter, having on its periphery 97 teeth; so that 97 revolutions of the great wheel cause one of the lesser wheel. On this lesser wheel is fixed a ring of wire CCC; which, being supported on six legs, stands obliquely to the wheel itself, touching it at one part, and projecting nearly three quarters of an inch at the opposite one: near the side of this wheel is an upright lever C, about 15 inches long, moving on a centre, three inches from its lower extremity, and connected at the top to a sliding bar D; from which rises an upright piece of brass E, which working in the notch of a pulley drives the bobbin F backward and forward, according as the oblique wire forces a pin G in or out, as the wheel moves round. To regulate and assist the alternate motion, a weight H hangs by a line to the sliding bar, and passing over a pulley I rises and falls as the bobbin advances or recedes, and tends constantly to keep the pin in contact with the wire. It is evident, from this description, that one staple only is wanted to the flyer; which, being placed near the extremity K, the thread passing through it is by the motion of the bobbin laid regularly thereon. For this invention the Society instituted at London for the Encouragement of Arts, &c. gave the author a premium of twenty guineas.

Plate  
CCCLXXIV.

**SPINOSUS CAULIS**, in botany; a stem covered with strong woody prickles, whose roots are not superficial, but proceeding from the body of the stem. When applied to a leaf, *spinajum folium*, it indicates the margin running out into rigid points or prickles, *quod marginæ exit in acumina duriora, rigidi, pungentia*.

**SPINOUS**, in botany. See **SPINOSUS**.

**SPINOUS FIBRES**, such as have some of the rays of the back fins running out into thorns or prickles, as the perch, &c.

**SPINOZA** (Benedict). was born at Amsterdam the 24th November 1632. His father was a Jew of Por-

tugal, by profession a merchant. After being taught Latin by a physician, he applied himself for many years to the study of theology, and afterwards devoted himself entirely to philosophy. He began very early to be dissatisfied with the Jewish religion; and as his temper was open, he did not conceal his doubts from the synagogue. The Jews, it is said, offered to tolerate his infidelity, and even promised him a pension of a thousand dollars *per annum*, if he would remain in their society, and continue outwardly to practise their ceremonies. But if this offer was really made, he rejected it, perhaps from his aversion to hypocrisy, or rather because he could not endure the restraint which it would have imposed. He also refused being constituted heir to an independent fortune, to the prejudice of the natural claimants; and he learned the art of polishing glass for spectacles, that he might subsist independently of every one.

He would probably have continued in the synagogue for some time longer, if it had not been for an accident. As he was returning home one evening from the theatre, he was stabbed by a Jew: the wound was slight; but the attempt naturally led Spinoza to conclude that the Jews had formed the design of assassinating him. After leaving the synagogue, he became a Christian, and frequented the churches of the Lutherans and Calvinists. He now devoted himself more than ever to his favourite philosophical speculations; and finding himself frequently interrupted by the visits of his friends, he left Amsterdam, and settled at the Hague, where he often continued for three months together without ever stirring from his lodging. During his residence in that city, his hostess, who was a Lutheran, asked him one day if she could be saved while she continued in her religion? "Yes (replied Spinoza), provided you join to your religion a peaceable and virtuous life." From this answer it has been concluded that he was a Christian in appearance only, while in reality he regarded all religions as indifferent. But this conclusion would be too severe, even if the woman had been a Mahometan. His *Traëctus Theologico-politicus*, which was published about that time, is a better proof of his insincerity than a thousand such conclusions; for this book contains all those doctrines in embryo which were afterwards unfolded in his *Opera Posthuma*, and which are generally considered as a system of atheism.

His fame, which had now spread far and wide, obliged him sometimes to interrupt his philosophical reveries. Learned men visited him from all quarters. While the prince of Condé commanded the French army in Utrecht, he intreated Spinoza to visit him; and though he was absent when the philosopher arrived, he returned immediately, and spent a considerable time with him in conversation. The elector Palatine offered to make Spinoza professor of philosophy at Heidelberg; which, however, he declined.

He died of a consumption at the Hague on the 21st February 1677, at the age of 45. His life was a perpetual contradiction to his opinions. He was temperate, liberal, and remarkably disinterested; he was sociable, affable, and friendly. His conversation was agreeable and instructive, and never deviated from the strictest propriety.

The only edition of the works of Spinoza that we have seen is in two volumes small 4to; the former of which

Spinoza.

which was printed at Hamburg in the year 1670, and the latter we know not where, in 1677, a few months after his death. In the *Tractatus Theologico-politicus*, already mentioned, he treats of *prophecy* and *prophets*; and of the *call of the Hebrews*, whom he affirms to have been distinguished from other nations only by the admirable form of their government, and the fitness of their laws for long preserving their political state. He is likewise of opinion, or at least pretends to be so, that God may, in what we call a *supernatural way*, have given political institutes to other nations as well as to the Hebrews, who were, he says, at no time a peculiar people to the Supreme Lord of heaven and earth; for, according to him, all history, sacred and profane, testifies that every nation was blessed with the light of prophecy. That light indeed, if his notions of it be just, was of very little value. He labours to prove, that the prophets were distinguished from other men only by their piety and virtue; that their revelations depended wholly on their imaginations and the dispositions of their minds; that they were often grossly ignorant and highly prejudiced; that the speculative opinions of one prophet are seldom in unison with those of another; and that their writings are valuable to us only for the excellent rules which he acknowledges they contain respecting the practice of piety and virtue. He then proceeds to treat of the divine law and of miracles; and endeavours to prove that no miracle, in the proper sense of the word, can have been at any time performed; because every thing happens by a necessity of nature, the result of the divine decrees, which are from all eternity necessary themselves. He acknowledges, that in the Scriptures, which he professes to admit as true history, miracles are often mentioned; but he says that they were only singular events which the sacred historians *imagined* to be miraculous: and he then gives some very extraordinary rules for interpreting the books of the Old and New Testaments where they treat of miracles, or appear to foretell future events. See our articles *MIRACLE* and *PROPHECY*.

Having thus divested the Scriptures of every thing characteristic of a revelation from heaven, he next calls in question their authenticity. He affirms, in contradiction to the clearest internal evidence, that the Pentateuch and all the other historical books must have been written by one man; and that man, he thinks, could not have flourished at a period earlier than that of Ezra. The grounds of this opinion are unworthy of the talents of Spinoza; for that he had talents is incontrovertible. His principal objection to the authenticity of the Pentateuch is, that Moses is made to speak of himself in the third person, and to talk of the Canaanites being then in the land; and, because he finds in his writings, as well as in the books of Joshua, Judges, Ruth, Samuel, &c. places designed by names which he supposes they had not in the early ages of which these books contain the history, he concludes that these writings must be one compilation from ancient records made at a very late period; more especially as the author often speaks of things of great antiquity remaining to this day. The books of Esther, Ezra, Nehemiah, and Chronicles, must have been compiled, he thinks, under the Maccabees; and he seems to consider as of equal value with them the story of Tobit, and the other

two apocryphal treatises intitled the Wisdom of Solomon and Ecclesiasticus. Spinoza.

These senseless cavils, worthy only of one of those modern freethinkers whose learning, in the opinion of Bishop Warburton, is not sufficient to carry them even to the confines of rational doubt, we have sufficiently obviated in another place (see *SCRIPTURE*, II 8—31.) Spinoza urges them against the other books of the Old Testament. The prophecies of Isaiah, Jeremiah, Ezekiel, Daniel, Hosea, and Jonah, are, as we have them, only fragments, he says, of the writings of those men compiled by the Pharisees under the second temple from ancient and voluminous records.

In the midst of this dogmatical-scepticism, if we may use such a phrase, he bears such a testimony to the last chapters of the book of Daniel, as we should not have looked for in the writings either of a Jew or of a Deist. After detailing the various hypotheses which in his time were held respecting the author and the intention of the book of *Job*; in which, he says, *ΜΟΜΟΣ* is called *SATAN*, he proceeds in these words: “*Transeo ad Danielis librum; hic sine dubio ex cap. 8. ipsius Danielis scripta continet. Undenam autem priora septem capita descripta fuerint, nescio\**,” thus admitting the famous prophecy of the seventy weeks. The canon of the Old Testament, he says, was finally settled by rabbins of the Pharisaical sect, who wished to exclude from it the books of *Proverbs*, *Ecclesiastes*, and *Ezekiel*, as they had actually excluded others of equal value; but the three books in question were inserted by the influence of two of the rabbis of greater wisdom and integrity than the rest.

That so paradoxical a writer, who had been originally a Jew, and was now almost a Deist, should have treated the New Testament with as little ceremony as the Old, will not surprize the intelligent reader. He begins his remarks, however, with affirming, that no man can peruse the Christian Scriptures, and not acknowledge the apostles to have been prophets; but he thinks that their mode of prophesying was altogether different from that which prevailed under the Mosaic dispensation; and that the gift, whatever it was, forsook them the instant that they left off *preaching*, as their *writings* have to him every appearance of human composition. This distinction between Christian and Jewish prophecy is the more wonderful, that he sounds it principally on the dissimilarity of *style* visible in the writings of the Old and New Testaments; though, in his second chapter, which treats of the works of the Jewish prophets, he says expressly, “*Stylus deinde prophetæ pro eloquentia cuiusque prophetæ variabat, prophetæ enim Ezekielis et Amosis non sunt, ut illæ Esaiæ, Nachumi eleganti, sed rudiore stylo scriptæ.*” That the Hebrew scholar may be convinced of the truth of this remark, he recommends to him to study diligently the writings of these prophets, and to consider the occasions on which their prophecies were uttered: “*Quæ si omnia recte perpendentur (says he) facile ostendant, Deum nullum habere stylum peculiarem dicendi, sed tantum pro eruditione, et capacitate prophetæ eatenus esse elegantem, compendiosum, severum, rudem, prolixum, et obscurum.*” Another objection brought by Spinoza against the prophecies of the New Testament arises from the authors of them having been

\* *Trahta-*  
*tus, cap. 2*  
P. 130.

at

Spinoza.

at all times masters of themselves. This, says he, was peculiarly the case of St Paul, who often confirms his doctrine by *reasoning*, which the Jewish prophets never condescended to do, as it would have submitted their dogmas to the examination of *private judgment*. Yet, with singular inconsistency, he affirms, that the Jewish prophets could not know that the impressions made on their imaginations proceeded from God, but by a sign given them, which by their own *reason or judgment* they knew would never be vouchsafed to an impious or a wicked man.

After these very free remarks on the Scriptures of the Old and New Testaments, he naturally enough expresses a suspicion, that by those who consider the Bible as the epistle of God sent from heaven to men, he will be thought to have sinned against the Holy Ghost by vilifying his dictates. This leads him to inquire in what sense the Scriptures are the word of God; and he gravely determines them to be so only as they *actually* contribute to make men more virtuous and holy. It is not enough that they are *calculated* to improve virtue and holiness: for should the words of the languages in which they are written acquire in process of time a signification different from what they had originally; should mankind lose all knowledge of these languages; or even should they agree to neglect the books, whether from ignorance or from wilfulness—those books would cease to be the word of God, and become nothing better than waste paper and ink; just as the two tables, which Moses broke on observing the idolatry of his countrymen, were not the covenant between Jehovah and the Israelites, but merely two pieces of stone! The Scriptures, however, are the word of God, because they teach the true religion of which God is the author; and they have taught it in such a manner, he says, that it can never be lost or corrupted whatever become of the books of the Old and New Testaments, or of the languages in which they are written. The whole of religion, as the Scriptures themselves testify, consists in the love of God above all things, and of our neighbours as ourselves: whence it follows, that we must believe that God exists, and watcheth over all things by his providence; that he is omnipotent, and has decreed the pious to be ultimately happy, and the impious miserable; and that our final salvation depends solely on His grace or favour. These truths, with their necessary consequences, are the word of God: they are clearly taught in the Scriptures, and can never be corrupted; but every thing else in these volumes is vain, he says, and of no greater importance to us than facts related in any other ancient and authentic history.

Such are the opinions which were entertained of revelation by a man whom a critic, writing in a Christian country, and professing to be a zealous Christian himself, has lately pronounced to have been a *chosen vessel*. For what purpose he was *chosen* it is not easy to conceive. His religion, as it appears in the *Treatatus*, is the worst kind of Deism; and his politics are such as our monthly critics are not wont to teach, and such as we trust shall never be seriously taught by any British subject. By the law of nature, he says, every man before the formation of civil government has an unquestionable right to whatever appears eligible either to his reason or to his appetites; and may get possession of it by *intreaty*, by *violence*, by *fraud*, or by *any other means*

attended with less trouble to himself (*sive vi, sive dolo, sive precibus, sive quocunque modo facilius poterit*); and may treat as an enemy every person who shall attempt to obstruct his purpose. But when men agree to devolve this right upon others, and to constitute a political state, which both reason and appetite must persuade them to do, then are they in duty bound to obey every mandate of the government, however absurd it may be (*omnia mandata tametsi absurdissima*), as long as that government can enforce its edicts, and no longer; for, according to him, right and power are so inseparably united, that when a government loses its power, it has no longer the smallest claim to obedience. This doctrine, he says, is most *obviously* just when taught of democratical governments; but it is in fact equally true of monarchies and aristocracies: "Nam quisquis suam habet potestatem, sive unus sit, sive pauci, sive denique omnes, certum est ei summum jus *quicquid velit imperandi*, competere: et præterea quisquis potestatem defendendi, sive sponte, sive vi *coactus*, in alium transtulit, eum suo jure naturali plane cessisse, et consequenter eidem ad omnia absolute parere decevisse quod omnia præstare tenetur, quamdiu rex, sive nobiles, sive populus summam, quam acceperunt, potestatem, quæ juris transferendi fundamentum fuit, conservant; nec his plura addere opus est\*." We heartily agree with him, that to this precious conclusion it is needless to add a single word.

Taking our leave therefore of his *Treatatus Theologico-politicus*, we shall now give our readers a short account of his *Opera Posthuma*. These consist of, 1. ETHICA, more geometrico demonstrata; 2. POLITICA; 3. DE EMENDATIONE INTELLECTUS; 4. EPISTOLÆ, et ad eas RESPONSIONES; 5. COMPENDIUM GRAMMATICES LINGUÆ HEBRÆÆ.

The ETHICA are divided into five parts, which treat in order, de DEO; de natura et origine MENTIS; de origine et natura AFFECTUUM; de SERVITUTE humana, seu de AFFECTUUM VIRIBUS; de POTENTIA INTELLECTUS, seu de LIBERTATE humana. As the author professes to tread in the footsteps of the geometers, and to deduce all his conclusions by rigid demonstration from a few self-evident truths, he introduces his work, after the manner of Euclid, with a collection of *definitions* and *axioms*. These are couched in terms generally ambiguous; and therefore the reader will do well to consider attentively in what sense, if in any, they can be admitted; for it will not be found easy to grant his premises, and at the same time refuse his conclusions. His definition of substance, for instance, is so expressed as to admit of two senses; in one of which it is just, whilst in the other it is the parent of the most impious absurdity. We shall give it in his own words: "Per substantiam intelligo id, quod in se est, et per se concipitur: hoc est id, cujus conceptus non indiget conceptu alterius rei, a quo formari debeat." If by this be meant, that a substance is that which we can conceive by itself without *attending* to any thing else, or *thinking* of its formation, the definition, we believe, will be admitted by every reflecting mind as sufficiently distinguishing the thing defined from an attribute, which, he says, is that which we perceive of a substance, and which we certainly cannot conceive as existing by itself. Thus the writer of this article can shut his eyes and contemplate in idea the small 4to volume now before

Spinoza.

\* *Treatatus*  
cap. xvi.  
p. 181.

Spinoza.

fore him, without attending to any thing else, or thinking of its paradoxical author, or even of the Great Being who created the matter both of him and of it; but he cannot for an instant contemplate the yellow colour of its vellum boards without thinking of triple extension, or, in other words, of body. The book therefore is a *substance*, because conceivable by itself; the colour is an *attribute or quality*, because it cannot be conceived by itself, but necessarily leads to the conception of something else. But if Spinoza's meaning be, that nothing is a substance but what is conceived as existing from eternity, independent of every thing as a cause, his definition cannot be admitted: for every man conceives that which in himself thinks, and wills, and is conscious, as a substance; at the same time that he has the best evidence possible that he existed not as a conscious, thinking, and active being, from eternity.

His fourth axiom is thus expressed: "Effectus cognitio a cognitione causæ dependet; et eandem involvit;" and his fifth, "Quæ nihil commune cum se invicem habent, etiam per se invicem intelligi non possunt, sive conceptus unius alterius conceptum non involvit." The former of these propositions, so far from being self-evident, is not even true; and the latter is capable of two senses very different from each other. That every effect proceeds from a *cause*, is indeed an axiom; but surely we may know the effect accurately, though we be ignorant of the *particular* cause from which it proceeds (see PHILOSOPHY, n° 36; and PHYSICS, n° 91, &c.); nor does the knowledge of the one by any means involve the knowledge of the other. If different things have nothing in common, it is indeed true that the knowledge of one of them will not give us an *adequate conception* of the other; but it will in many cases compel us to believe, that the other *exists* or has existed. A parcel of gunpowder lying at rest has nothing in common with the velocity of a cannon-ball; yet when we know that a ball has been driven with velocity from a cannon, we infer with certainty that there has been a parcel of powder at rest in the chamber of that cannon.

It is upon such ambiguous definitions and axioms as these that Spinoza has raised his pretended demonstrations, that one substance cannot produce another; that every substance must necessarily be infinite; that no substance exists or can be conceived besides God; and that extended substance or body is one of the infinite *attributes* of God. We shall not waste our own time or the reader's with a formal confutation of these impious absurdities. We trust they are sufficiently confuted in other articles of this work (see METAPHYSICS, Part III. PROVIDENCE, and THEOLOGY, Part I.); and whoever wishes for a more particular examination of the author's principles, may find it in Dr Clarke's Demonstration of the Being and Attributes of God. The truth, however, is, that no man will need the assistance of that eminent metaphysician to discover the fallacy of the reasoning by which they are attempted to be proved, if he affix *any one precise meaning* to the definitions and axioms, and adhere to that meaning steadily thro' the whole process of the pretended demonstrations.

By way of apology for this jargon, it has been lately said, that "Spinoza takes the word *substance* in its

most simple and perfect sense; which is necessary, as he writes mathematically, and proposes a simple idea as the foundation of his theory. What is the proper signification of a substance? Is it not that which stands alone, which has the cause of its existence within itself? I wish that this simple meaning of the word could be universally admitted in philosophy. Strictly speaking, no worldly thing is a substance; since all mutually depend on each other, and finally on God, who, in this exalted sense, is the only *substance*. The word *modification* sounds harsh and improper, and therefore it cannot be expected to gain a place in philosophy; but if the school of Leibnitz may term matter the *appearance of substances*, why may not Spinoza be allowed a bolder term? Worldly substances are kept in union by divine power, as it was by divine power that they had existence. They represent also, if you please, *modified* appearances of divine power; each according to the station, the time, and the organs, in and with which it appears. The phrase used by Spinoza is concise, and it gives an unity and simplicity to his whole system, however strange it may sound in our ears."

From this account of Spinozism, one who had never looked into the works of the author would be led to suppose that his system is the same with that of Berkeley; which, denying the existence of material substance, attributes all our perceptions of what we call the qualities of body to the immediate agency of the Deity on our minds (see METAPHYSICS, Part II. Chap. 3.) But Spinoza's doctrine is very different. According to him, bodies are either attributes or affections of God; and as he says there is but one extended substance, he affirms that substance to be indivisible, and employs a long scholium† to prove that those are mistaken who suppose it finite and not *essential to the Deity*. That we do not misrepresent his sentiments, the learned reader will be convinced by the two following definitions, with which he introduces that part of his ethics which treats of the nature and origin of mind. 1. "Per corpus intelligo modum, qui Dei essentiam, quatenus, ut res extensa consideratur, certo et determinato modo exprimit." 2. "Ad essentiam alicujus rei id pertinere dico, quo dato res necessario ponitur, et quo sublato res necessario tollitur; vel id, sine quo res, et vice versa quod sine re nec esse nec concipi potest." In conformity with these definitions, he attempts to prove that God is an extended as well as a thinking substance; that a thinking substance he is the cause of the *idea* of a circle, and as an extended substance of the *circle* itself; and that the minds of men are not substances, but certain modifications of the divine attributes; or, as he sometimes expresses it, "Quod humanæ mentis actualæ constituit, est idea rei singularis actu existentis." Hence, he says, it follows that the human mind is a part of the intellect of the infinite God; so that when we speak of the human mind perceiving this or that, we can only mean that God, not as he is infinite, but as he appears in the human mind or constitutes its essence, has this or that idea; and when we speak of God's having this or that idea, we must conceive of Him not only as constituting the human mind, but as, together with it, having the idea of something else (A). In another place he tells us, that the human mind is nothing but the *idea* which

(A) Hinc sequitur, mentem humanam partem esse infiniti intellectus Dei; ac proinde cum dicimus, mentem humanam



Spinoza. which God has of the human body as actually existing; that this *idea* of the body, and the *body* itself, are one and the same thing; and that thinking and extended substances are in reality but one and the same substance, which is sometimes comprehended under one attribute of the Deity, and sometimes under another\*.

Prop. vii. If this impious jargon be not Atheism, or as it has been sometimes called Pantheism, we know not what it is (see PANTHEISM). According to Spinoza, there is but one substance, which is extended, infinite, and indivisible. That substance indeed he calls God; but he labours to prove that it is corporeal; that there is no difference between mind and matter; that both are attributes of the Deity variously considered; that the human soul is a part of the intellect of God; that the same soul is nothing but the idea of the human body; that this idea of the body, and the body itself, are one and the same thing; that God could not exist, or be conceived, were the visible universe annihilated; and therefore that the visible universe is either the one substance, or at least an essential attribute or modification of that substance. He sometimes indeed speaks of the *power* of this substance; but when he comes to explain himself, we find that by power he means nothing but blind necessity †; and though he frequently talks of the *wisdom* of God, he seems to make use of the word without meaning. This we think evident from the long appendix to his 36th proposition; in which he labours to prove that the notion of final causes is an idle figment of the imagination, since, according to him, nothing but the prejudices of education could have led men to fancy that there is any real distinction between *good* and *evil*, *merit* and *demerit*, *praise* and *reproach*, *order* and *confusion*; that *eyes* were given them that they might be enabled to *see*; *teeth* for the purpose of chewing their *food*; *herbs* and *animals* for the *matter* of that *food*; that the *sun* was formed to give *light*, or the *ocean* to nourish *fishes*. If this be true, it is impossible to discover wisdom in the operations of his *one substance*; since, in common apprehension, it is the very characteristic of folly to act without any end in view.

Such are the reveries of that writer, whose works a German philosopher of some name has lately recommended to the public, as calculated to convey to the mind more just and sublime conceptions of God than are to be found in most other systems. The recommendation has had its effect. A literary journal of our own, reviewing the volume in which it is given, feels a peculiar satisfaction from the discovery that Spinoza, instead of a formidable enemy to the cause of virtue and religion, was indeed their warmest friend; and piously hopes that we shall become more cautious not to suffer ourselves to be deceived by empty names, which those who *cannot* reason (Sir Isaac Newton and Dr Clarke perhaps) give to those who can (Hobbes, we suppose, and Spinoza). But though we have the honour to think on this question with our illustrious countrymen, we have no desire to depict Spinoza as a *reprobate*, which

VOL. XVII. Part II.

the critic says has often been done by ignorance and enthusiasm. We admit that his conduct in active life was irreproachable; and for his speculative opinions, he must stand or fall to his own Matter. His *Ethics* appear to us indeed a system shockingly impious; and in the tract intitled *POLITICA*, *power* and *right* are confounded as in the former volume; but in the treatise *DE INTELLECTUS EMENDATIONE*, are scattered many precepts of practical wisdom, as well as some judicious rules for conducting philosophical investigation; and we only regret, that the reader must wade to them through pages of fatalism, scepticism, and palpable contradictions. His *Compendium Grammaticæ Linguae Hebraeæ*, though left imperfect, appears to have so much merit, that it is to be wished he had fulfilled his intention of writing a philosophical grammar of that language, instead of wasting his time on abstruse speculations, which, though they seem not to have been injurious to his own virtue, are certainly not calculated to promote the virtue of others, or to increase the sum of human happiness.

SPIRÆA, in botany: A genus of plants belonging to the class of *icosandria*, and to the order of *pentagynia*; and in the natural system arranged under the 26th order, *Pomacea*. The calyx is quinquefid; there are five petals; and the capsule is polyspermous. There are 18 species; of which two only are British, the *filipendula* and *ulmaria*. 1. The *filipendula*, dropwort, has pinnated leaves; the leaflets are serrated; the stalk is herbaceous, about a foot and a half high, terminated with a loose umbel of white flowers, often tinged with red. The petals are generally six, and the segments of the calyx are reflexed; the stamina are 30 or more; the germina 12 or upwards. It grows in mountainous pastures. 2. The *ulmaria*, meadow-sweet. The leaves have only two or three pair of pinnæ, with a few smaller ones intermixed; the extreme one being larger than the rest, and divided into three lobes. The calyx is reddish; the petals white, and the number of capsules from six to ten twisted in a spiral. The tuberous pea, like roots of the *filipendula* dried and reduced to powder, have been used instead of bread in times of scarcity. Hogs are very fond of these roots. Cows, goats, sheep, and swine, eat the plant; but horses refuse it. The flowers of the *ulmaria* have a fragrant scent, which rises in distillation. The whole plant indeed is extremely fragrant, so that the common people of Sweden strew their floors with it on holidays. It has also an astringent quality, and has been found useful in dysenteries, ruptures, and in tanning of leather.

SPIRAL, in geometry, a curve line of the circular kind, which in its progress recedes from its centre.

SPIRE, in architecture, was used by the ancients for the base of a column, and sometimes for the astragal or torse; but among the moderns it denotes a steeple that continually diminishes as it ascends, whether conically or pyramidally.

SPIRIT, in metaphysics, an incorporeal being or intelligence;

4 T

intelligence;

humanam hoc vel illud percipere, nihil aliud dicimus quam quod Deus, non quatenus infinitus est, sed quatenus per naturam humanæ mentis explicatur, sive quatenus humanæ mentis essentiam constituit, hanc vel illam habet ideam: et cum dicimus Deum hanc vel illam ideam habere, non tantum, quatenus naturam humanæ mentis constituit; sed quatenus simul cum mente humana alterius rei etiam habet ideam. *Corol.* prop. xi. part 2.

Spinoza  
||  
Spir.

*Spirit*  
||  
*Spirituos*  
*Liquors*

intelligence; in which sense God is said to be a spirit, as are angels and the human soul. See METAPHYSICS, Part III.

SPiRiT, in chemistry and pharmacy, a name applied to every volatile liquid which is not insipid like phlegm or water; and hence the distinction into acid, alkaline, and vinous spirits. See PHARMACY-Index.

SPiRiT of Wine. See CHEMISTRY-Index, DISTILLATION, and PHARMACY-Index.

SPiRITS, or ANIMAL SPiRITS. See ANATOMY, Part V. n° 136, and PHYSIOLOGY, n° 185.

SPiRITUAL, in general, something belonging to or partaking of the nature of spirit. See SPiRIT.

SPiRITUOUS LIQUORS have in all nations been considered as a proper subject of heavy taxation for the support of the state. This has naturally occasioned a nice examination of their strength. It having been at last found that this was intimately connected with the specific gravity, this has been examined with the most scrupulous attention to every circumstance which could affect it, so that the duties might be exactly proportioned to the quantity of spirit in any strong liquor, independent on every other circumstance of flavour or taste, or other valued quality. The chemist at last found that the basis of all strong liquors is the same, produced by the vinous fermentation of pure saccharine matter dissolved in water. He also found, that whether this vegetable salt be taken as it is spontaneously formed in the juices of plants and fruits, or as it may be formed or extricated from farinaceous fruits and roots by a certain part of the process of vegetation, it produces the same ardent spirit, which has always the same density in every mixture with water. The minute portions of aromatic oils, which are in some degree inseparable from it, and give it a different flavour according to the substance from which it was obtained, are not found to have any sensible effect on its density or specific gravity. This seems very completely established in consequence of the unwearied attempts of the manufacturers to lessen the duties payable on their goods by mixtures of other substances, which would increase their density without making them less palatable. The vigilance of the revenue officers was no less employed to detect every such contrivance. In short, it is now an acknowledged point, that the specific gravity is an accurate test of the strength.

But though this is true in general, we cannot derive much benefit from it, unless we know the precise relation between the strength and the density of a spirituous liquor. Do they increase *pari passu*, or by what law are they connected? It was natural to expect that equal additions of ardent spirits or alcohol to a given quantity of water would produce equal diminutions of density. Areometers were accordingly made on this principle above 200 years ago, as may be seen in the works of Gaspar Schottus, Sturmus, Agricola, and other old authors. But when mathematical physics became more generally known, this was easily discovered to be erroneous; and it was shown (we think first by Mr Boyle) that equal additions to the specific gravity would be produced by successively taking out of any vessel a certain measure of alcohol and replacing it with an equal measure of water. This was the most convenient discovery for all parties, because then the duties payable on a cask of spirits would be in the exact pro-

portion of the diminution of its density. But it was soon found by those who were appointed guardians of the revenue that this conclusion was erroneous, and that a mixture which appeared by this rule to contain 35 gallons of alcohol, did really contain 35½. This they found by actually making such a mixture: 18 gallons of alcohol mixed with 18 of water produced only 35 gallons of spirits. The revenue officers, finding that this condensation was most remarkable in mixtures of equal parts of water and the strongest spirits which could then be procured, determined to levy the duties by this mixture; because, whether the spirituous liquor was stronger or weaker than this, it would appear, by its specific gravity, rather stronger than it really was. This sagacious observation, and the simplicity of the composition, which could at all times be made for comparison, seem to be the reasons for our excise offices selecting this mode of estimating the strength and levying the duties. A mixture of nearly equal measures of water and alcohol is called PROOF SPiRIT, and pays a certain duty *per* gallon; and the strength of a spirituous liquor is estimated by the gallons, not of alcohol, but of proof spirit which the cask contains. But because it might be difficult to procure at all times this proof spirit for comparison, such a mixture was made by order of the board of excise: and it was found, that when six gallons of it was mixed with one gallon of water, a wine gallon of the mixture weighed 7 pounds 13 ounces avoirdupois. The board therefore declared, that the spirituous liquor of which the gallon weighed 7 pounds 13 ounces should be reckoned 1 to 6 or 1 in 7 under proof. This is but an awkward and complex formula; it was in order to suit matters to a mode of examination which had by time obtained the sanction of the board. Mr Clarke, an ingenious artist of that time, had made a hydrometer incomparably more exact than any other, and constructed on mathematical principles, fit for computation. This had a set of weights corresponding to the additions of water or proof spirit, and the mixture 1 to 6 or 1 in 7 was the only one which weighed an exact number of ounces *per* gallon without a fraction.

Thus stands the excise law; and Clarke's hydrometer is still the instrument of authority, although others have been since constructed by DICAS, QUIN, and others, which are much more ingenious and convenient. The mathematician who examines Dica's hydrometer, with its sliding scale, by which it is adjusted to the different temperatures, and points out the condensations, will perceive a beautiful and sagacious combination of quantities, which he will find it difficult to bring under any analytical formula. Perhaps Quin's may have some preference in respect of conveniency; but *facile inventis adtere*. Mr Dica's was original.

As naturalists became more accustomed to exact observation in every topic of inquiry, the condensation which obtains in the mixture of different substances became more familiarly known. This evidently affects the present question; and both the excise and the distillers are interested in its accurate decision. This occasioned an application to the Royal Society; and a most scrupulous examination of the strength of spirituous liquors was made by Sir Charles Blagden and Mr Gilpin, of which they have given a very particular account in the PHILOSOPHICAL TRANSACTIONS for 1790 and 1792.

We have taken notice of this in the article SPECIFIC GRAVITY,

**GRAVITY**, mentioning such circumstances of the results as suited our purposes of physical discussion. At present we give the general result in the table of specific gravity, as peculiarly belonging to spirituous liquors, affording the most exact account of their density in every state of dilution of alcohol with water. And as the relation between the proportion of ingredients and the density is peculiar to every substance, so that scarcely any inference can be made from one to another, the reader will consider the tables here given as characteristic with respect to alcohol. In all solutions of salts we found that the condensation increases continually with the dilution, whereas it is greatest when equal bulks of water and alcohol are mixed; yet we do not consider this as an exception; for it is certain, that in the strongest brine the saline ingredient bears but a small proportion to the water—and when we mix two solutions, the condensation is greatest when they are nearly equal in bulk. But we think ourselves entitled to infer, that alcohol is not a dilution of a substance in a quantity of water; but that water, in a certain proportion, not very distant from what we can produce by slow distillation, is an ingredient of alcohol, or is one of its component parts, and not merely a vehicle or menstruum. We therefore imagine that proof spirit contains nearly equal bulks of water and ardent spirits.

The great difficulty in this examination arose from the very dissimilar expansions of water and alcohol by heat. This determined Sir Charles Blagden to eliminate the proportions of ingredients by weight, and made it absolutely necessary to give a scale of specific gravity and strength for every temperature. For it must be remarked, that the question (whether in commerce or philosophy) always is, "How many gallons of alcohol and of water, taken just now and mixed together, will produce a hundred gallons of the spirit we are examining?" The proportion of these two will be different according to the temperature of both. As many mixtures therefore must have been made in each proportion as there were temperatures considered; but by taking the ingredients by weight, and examining the density of the compound in one temperature, it is then heated and cooled, and its change of density observed. Calculation then can tell us the change in the proportion of the bulks or numbers of gallons in the mixture, by means of a previous table showing the expansions of water and of alcohol.

The alcohol selected for this examination had the specific gravity 0,825. This is not the purest that can be procured; some was produced of 0,816, of 0,814, and 0,813, both obtained from rum, from brandy, and from malt spirit. We are informed that Dr Black has obtained it of the specific gravity 0,8 by digesting alcohol with fixed ammoniac (muriatic acid united with lime) made very dry. It dephlegmates alcohol very powerfully without decomposing it, which always happens when we use caustic alkali. Alcohol of 0,825 was chosen because expressed by a number of easy management in computation.

The examination commenced by ascertaining the expansions of water and alcohol. The temperature 60° of Fahrenheit's scale was selected for the general temperature of comparison, being easily attainable even in cold weather, and allowing the examiner to operate at ease. The first and last compartments of the tables

contain the weights and specific gravities of alcohol and water for every fifth degree of heat from 30° to 100°. From these we have constructed the two following little tables of expansion. The bulk of 1000 ounces, pounds, or other weight of water and of alcohol of the temperature 60°, occupies the bulks expressed in the tables for every other temperature. Water could not be easily or usefully examined when of the temperature 30°, because it is with great difficulty kept fluid in that temperature. It is very remarkable, that when it can be so kept, it expands instead of contracting; while cooling down from 35° or thereabouts, and as it approaches to 32°, it expands rapidly. We observe the same thing in the crystallization of Glauber salt, martial vitriol, and some others, which contain much water in their crystals. We observe, on the other hand, a remarkable contraction in the zeolite just before its beginning to swell into bubbles by a red heat.

Spiritus  
Liquora.

Heat	Bulk of 100,000 ounces.			
	Of Water.		Of Alcohol.	
		Diff.		Diff.
30°			119195	319
35	99910	— 4	119514	325
40	99906	+ 8	119839	332
45	99914	18	120172	342
50	99932	30	120514	348
55	99962	38	120868	350
60	100000	50	121212	353
65	100050	56	121565	354
70	100106	64	121919	350
75	100170	71	122279	366
80	100241	79	122645	372
85	100320	84	123017	376
90	100404	96	123393	380
95	100500	108	123773	384
100	100608		124157	

This being premised, the examination was conducted in the following manner. It was determined to mix 100 parts by weight of pure alcohol with five, ten, fifteen, twenty, parts of distilled water, till they were compounded in equal quantities, and then to mix 100 parts of distilled water with 95, 90, 85, 80, &c. parts of alcohol, till they were mixed in the proportion of 100 to 5. Thus a series of mixtures would be obtained, extending from pure alcohol to pure water. This series would be such, that the examinations would be most frequent in the cases most usual in the commerce of strong liquors. A set of phials, fitted with ground stoppers, were provided, of sizes fit to hold the intended mixtures. These mixtures were made by suspending the phial to the arm of a very nice balance, in the opposite scale of which (besides the counterpoise of the phial) there was placed the weight 100. Spirit was then poured into the phial till it exactly balanced the weight 100. The weight for the water to be added was then put into the opposite scale, and water was poured into the phial by means of a slender glass funnel, by small quantities at a time, and the phial frequently agitated to promote the mixture. When the additional weight was exactly balanced, the phial was taken off, its stopper put in, and leather tied over it, and it was set by, for at least a month, that the mixture and the whole

Spirituos  
Liquors.

process of condensation might be completed. The same method was followed in the mixtures where the water was predominant.

When the ingredients of these mixtures were judged to have completely incorporated, their specific gravity was examined by weighing with the most scrupulous precision the contents of a vessel which held 2925 troy grains of water, of the temperature 60°. The balance was so exceedingly sensible, that the 50th part of a grain greatly deranged its position when loaded with the scales and their contents. It was constructed by Mr Ramsden, and some account of its exquisite sensibility may be seen in the *Journal de Physique*, vol. xxxiii. This quantity of materials was therefore thought abundantly sufficient for ascertaining the density of the liquor. It is needless to detail the precautions which were taken for having the contents of the weighing bottle brought to the precise temperature proper for the experiment. They were such as every person conversant with such things is accustomed to take—The bottle had a slender neck, and being put on a lathe, a mark was made round it with a diamond. The bottle was filled till the bottom of the hollow surface of the fluid was in the plane of this mark; and to judge of the accuracy attainable in filling the bottle, the operation was several times repeated and the contents weighed, without the difference of  $\frac{1}{8}$ th of a grain in 2925. The only source of error which was to be guarded against was air-bubbles adhering to the inside of the bottle, or moisture condensing (in the experiments with low temperatures) on the outside. Both of these were attended to as much as possible.

This method of determining the specific gravity was preferred to the usual method, observing the weight lost by a lump of glass when suspended in water; for Mr Gilpin had been enabled, by means of this nice balance, to discover, even in pure water and in alcohol, a want of perfect fluidity. Something like viscosity

rendered the motion of a lump of glass through the liquor sensibly sluggish, so that when the balance was brought to a level, there was not a perfect equilibrium of weights: (See what we have said of this matter in SPECIFIC GRAVITY). Mr Gilpin also tried the ingenious instrument proposed for such experiments by Mr Ramsden, and described by him in a pamphlet on this very subject; and he found the anomalies of experiment much greater than in this method by weighing.—Indeed the regular progression of weights to be seen in the annexed tables is an unquestionable proof of the sufficiency of the method; and it has the evident advantage of all other methods, in point of simplicity and practicability without any uncommon apparatus. Any person possessed of a good ordinary balance and a set of exact weights may examine all questions of this kind, by weighing pure water and the liquor which he may have occasion to examine in a common 6 or 8 ounce phial. For this reason, it is recommended (in preference to all hydrometers) to the board of excise to provide this simple apparatus in every principal office.

Every experiment was made at least three times; and the mean result (which never differed one grain from the extreme) was taken.

From these experiments the annexed tables were constructed. The first is the simple abstract of the experiments, containing the weights of the contents of the bottle of every mixture. The second contains the specific gravities deduced from them.

We have said that the experiments appear surprisingly accurate. This we say on the authority of the regular progression of the specific gravity in any of the horizontal rows. In the series, for instance, for the temperature 60°, the greatest anomaly is in the mixture of 50 parts of spirit with 100 of water. The specific gravity is 95804, wanting 3 or 4 of the regular progression. This does not amount to 1 in 18000.

TABLE I.—Weights at the different Degrees of Temperature.

Heat.	The pure Spirit.	100 grains of Spirit to 5 grains of water.	100 grains of Spirit to 10 grains of water.	100 grains of Spirit to 15 grains of water.	100 grains of Spirit to 20 grains of water.	100 grains of Spirit to 25 grains of water.	100 grains of Spirit to 30 grains of water.	100 grains of Spirit to 35 grains of water.	100 grains of Spirit to 40 grains of water.	100 grains of Spirit to 45 grains of water.	100 grains of Spirit to 50 grains of water.	100 grains of Spirit to 55 grains of water.	100 grains of Spirit to 60 grains of water.	100 grains of Spirit to 65 grains of water.
deg.	Grains.	Grains.	Grains.	Grains.	Grains.	Grains.	Grains.	Grains.	Grains.	Grains.	Grains.	Grains.	Grains.	Grains.
30	2487,35	2519,92	2548,42	2573,80	2596,66	2617,30	2636,23	2653,73	2669,83	2684,74	2698,51	2711,14	2722,89	2733,87
35	2480,87	2513,43	2541,84	2567,26	2590,16	2610,87	2629,92	2647,47	2663,64	2678,60	2692,43	2705,14	2716,92	2727,87
40	2474,30	2506,75	2535,41	2560,74	2583,66	2604,50	2623,56	2641,08	2657,23	2672,30	2686,32	2699,34	2710,81	2721,83
45	2467,62	2500,14	2528,75	2554,09	2577,10	2597,98	2617,03	2634,64	2650,87	2666,04	2679,99	2692,77	2704,57	2715,62
50	2460,75	2493,33	2521,96	2547,47	2570,42	2591,38	2610,54	2628,21	2644,43	2659,55	2673,64	2686,54	2698,42	2709,48
55	2453,80	2486,37	2515,03	2540,60	2563,64	2584,65	2603,80	2621,50	2637,86	2653,04	2667,14	2679,98	2691,83	2702,98
60	2447,00	2479,56	2508,27	2533,83	2556,90	2577,95	2597,22	2615,03	2631,37	2646,53	2660,62	2673,55	2685,52	2696,73
65	2440,12	2472,75	2501,53	2526,99	2550,22	2571,24	2590,55	2608,37	2624,75	2640,01	2654,04	2667,07	2679,15	2690,32
70	2433,23	2465,88	2494,66	2520,03	2543,32	2564,47	2583,88	2601,67	2617,96	2633,32	2647,82	2660,63	2672,74	2684,02
75	2426,23	2458,78	2487,56	2513,08	2536,39	2557,61	2576,93	2594,80	2611,19	2626,55	2640,81	2653,99	2666,06	2677,34
80	2419,02	2451,67	2480,45	2506,08	2529,24	2550,50	2569,86	2587,93	2604,29	2619,52	2633,99	2647,12	2659,36	2670,69
85	2411,92	2444,63	2473,33	2499,01	2522,29	2543,54	2563,01	2580,93	2597,45	2613,02	2627,39	2640,60	2652,78	2664,16
90	2404,90	2437,62	2466,32	2491,99	2515,28	2536,63	2556,11	2574,02	2590,60	2606,16	2620,52	2633,74	2646,00	2657,41
95	2397,68	2430,33	2459,13	2484,74	2508,10	2529,46	2549,13	2567,03	2583,65	2599,24	2613,57	2626,94	2639,25	2650,63
100	2390,60	2423,22	2452,13	2477,64	2500,91	2522,30	2541,92	2559,96	2576,56	2592,14	2606,50	2619,75	2632,17	2643,75

Heat.	100 grains of Spirit to 70 grains of water.	100 grains of Spirit to 75 grains of water.	100 grains of Spirit to 80 grains of water.	100 grains of Spirit to 85 grains of water.	100 grains of Spirit to 90 grains of water.	100 grains of Spirit to 95 grains of water.	100 grains of Spirit to 100 grains of water.	85 grains of Spirit to 100 grains of water.	80 grains of Spirit to 100 grains of water.	75 grains of Spirit to 100 grains of water.	70 grains of Spirit to 100 grains of water.	65 grains of Spirit to 100 grains of water.
deg.	Grains.	Grains.	Grains.	Grains.	Grains.	Grains.	Grains.	Grains.	Grains.	Grains.	Grains.	Grains.
30	2744,20	2753,75	2762,72	2771,08	2778,99	2786,36	2793,22	2799,85	2806,61	2813,35	2821,35	2828,90
35	2738,13	2747,74	2756,91	2765,32	2773,22	2780,59	2787,54	2794,19	2801,14	2808,52	2816,07	2823,68
40	2732,24	2741,86	2750,96	2759,50	2767,48	2774,90	2781,84	2788,69	2795,70	2803,17	2810,73	2818,36
45	2726,09	2735,77	2744,82	2753,36	2761,42	2768,85	2775,94	2782,99	2789,99	2797,45	2805,08	2812,93
50	2719,93	2729,64	2738,74	2747,27	2755,37	2762,95	2770,14	2777,19	2784,30	2791,72	2799,58	2807,56
55	2713,60	2723,35	2732,64	2741,24	2749,27	2756,83	2764,09	2771,29	2778,54	2785,96	2793,82	2801,89
60	2707,40	2717,30	2726,52	2735,17	2743,28	2750,93	2758,17	2765,40	2772,70	2780,26	2788,25	2796,45
65	2701,05	2710,96	2720,25	2728,98	2737,09	2744,86	2752,21	2759,47	2766,73	2774,43	2782,62	2790,81
70	2694,76	2704,64	2713,87	2722,75	2730,94	2738,73	2746,06	2753,41	2760,75	2768,45	2776,72	2784,56
75	2688,14	2698,07	2707,49	2716,35	2724,64	2732,39	2739,89	2747,23	2754,73	2762,58	2770,93	2779,26
80	2681,50	2691,50	2700,94	2709,76	2718,12	2726,06	2733,53	2740,93	2748,42	2756,43	2764,97	2773,33
85	2674,95	2684,93	2694,53	2703,33	2711,86	2719,74	2727,25	2734,80	2742,31	2750,22	2758,80	2767,44
90	2668,29	2678,49	2687,99	2696,91	2705,37	2713,32	2721,01	2728,59	2736,23	2744,24	2752,76	2761,51
95	2661,51	2671,82	2681,34	2690,33	2698,80	2706,88	2714,61	2722,23	2729,89	2737,98	2746,57	2755,34
100	2654,76	2664,99	2674,62	2683,63	2692,25	2700,33	2708,04	2715,73	2723,35	2731,55	2740,43	2749,28

Heat.	60 grains of Spirit to 100 grains of water.	55 grains of Spirit to 100 grains of water.	50 grains of Spirit to 100 grains of water.	45 grains of Spirit to 100 grains of water.	40 grains of Spirit to 100 grains of water.	35 grains of Spirit to 100 grains of water.	30 grains of Spirit to 100 grains of water.	25 grains of Spirit to 100 grains of water.	20 grains of Spirit to 100 grains of water.	15 grains of Spirit to 100 grains of water.	10 grains of Spirit to 100 grains of water.	5 grains of Spirit to 100 grains of water.	Water.
deg.	Grains.	Grains.	Grains.	Grains.	Grains.	Grains.	Grains.	Grains.	Grains.	Grains.	Grains.	Grains.	Grains.
30	2852,03	2859,71	2867,12	2874,43	2881,34	2887,77	2894,22	2900,85	2908,21	2917,19	2928,80	2944,53	
35	2847,45	2855,32	2863,16	2870,87	2878,21	2885,06	2892,07	2899,31	2907,45	2916,95	2928,99	2945,02	2967,14
40	2842,62	2850,88	2859,06	2867,08	2874,81	2882,30	2889,78	2897,61	2906,39	2916,41	2928,43	2945,25	2967,45
45	2837,64	2846,16	2854,67	2863,04	2871,22	2879,22	2887,33	2895,67	2904,98	2915,55	2928,49	2945,20	2967,40
50	2832,76	2841,52	2850,29	2858,96	2867,52	2875,98	2884,57	2893,58	2903,39	2914,42	2927,81	2944,73	2967,05
55	2827,68	2836,69	2845,72	2854,75	2863,75	2872,67	2881,69	2891,11	2901,42	2913,02	2926,73	2943,98	2966,34
60	2822,65	2831,90	2841,12	2850,30	2859,87	2869,15	2878,72	2888,62	2899,35	2911,32	2925,50	2942,98	2965,39
65	2817,49	2826,90	2836,30	2845,97	2855,65	2865,45	2875,49	2885,85	2897,09	2909,43	2923,90	2941,69	2964,11
70	2812,16	2821,78	2831,61	2841,42	2851,53	2861,63	2872,06	2882,90	2894,56	2907,33	2922,21	2940,13	2962,66
75	2806,75	2816,63	2826,56	2836,80	2847,14	2857,70	2868,49	2879,67	2891,79	2905,04	2920,17	2938,33	2960,97
80	2801,25	2811,23	2821,38	2831,92	2842,56	2853,38	2864,54	2876,22	2888,73	2902,35	2917,83	2936,31	2959,07
85	2795,69	2805,85	2816,32	2827,12	2838,07	2849,28	2860,86	2872,88	2885,56	2899,55	2915,46	2934,14	2956,94
90	2790,13	2800,40	2811,05	2822,15	2833,38	2844,81	2856,80	2869,16	2882,25	2896,58	2912,84	2931,77	2954,70
95	2784,30	2794,91	2805,79	2817,08	2828,46	2840,26	2852,47	2865,15	2878,71	2893,44	2910,02	2929,15	2952,08
100	2778,64	2789,32	2800,25	2811,80	2823,55	2835,30	2848,18	2861,12	2875,07	2890,04	2906,97	2926,28	2949,34

TABLE II.—Real specific Gravities at the different Temperatures.

Heat.	The pure spirit.	100 grains of spirit to 5 grains of water.	100 grains of spirit to 10 grains of water.	100 grains of spirit to 15 grains of water.	100 grains of spirit to 20 grains of water.	100 grains of spirit to 25 grains of water.	100 grains of spirit to 30 grains of water.	100 grains of spirit to 35 grains of water.	100 grains of spirit to 40 grains of water.	100 grains of spirit to 45 grains of water.	100 grains of spirit to 50 grains of water.	100 grains of spirit to 55 grains of water.	100 grains of spirit to 60 grains of water.	100 grains of spirit to 65 grains of water.
deg.														
30	,83806	,84995	,85957	,86825	,87585	,88282	,88921	,89511	,90054	,90558	,91023	,91449	,91847	,92217
35	,83672	,84769	,85729	,86587	,87357	,88059	,88701	,89294	,89839	,90345	,90811	,91241	,91640	,92009
40	,83445	,84539	,85507	,86361	,87134	,87838	,88481	,89073	,89617	,90127	,90596	,91026	,91428	,91799
45	,83214	,84310	,85277	,86131	,86907	,87613	,88255	,88849	,89396	,89909	,90380	,90812	,91211	,91584
50	,82977	,84076	,85042	,85902	,86676	,87384	,88030	,88626	,89174	,89684	,90160	,90596	,90997	,91370
55	,82736	,83834	,84802	,85664	,86441	,87150	,87796	,88393	,88935	,89458	,89930	,90367	,90768	,91144
60	,82500	,83599	,84568	,85430	,86208	,86918	,87568	,88169	,88720	,89232	,89707	,90144	,90549	,90927
65	,82262	,83362	,84334	,85193	,85976	,86686	,87337	,87938	,88490	,89006	,89479	,89920	,90328	,90707
70	,82023	,83124	,84092	,84951	,85736	,86451	,87105	,87705	,88254	,88773	,89252	,89695	,90104	,90484
75	,81780	,82878	,83851	,84710	,85493	,86212	,86864	,87468	,88018	,88538	,89018	,89464	,89872	,90252
80	,81530	,82631	,83603	,84462	,85248	,85966	,86623	,87228	,87776	,88301	,88781	,89225	,89639	,90021
85	,81283	,82386	,83355	,84221	,85006	,85723	,86380	,86984	,87541	,88067	,88551	,88998	,89409	,89793
90	,81039	,82142	,83111	,83977	,84762	,85483	,86139	,86743	,87302	,87827	,88312	,88758	,89173	,89558
95	,80788	,81888	,82860	,83724	,84511	,85232	,85896	,86499	,87060	,87586	,88069	,88521	,88937	,89322
100	,80533	,81643	,82618	,83478	,84262	,84984	,85646	,86254	,86813	,87340	,87824	,88271	,88691	,89082
Heat.	100 grains of spirit to 70 grains of water.	100 grains of spirit to 75 grains of water.	100 grains of spirit to 80 grains of water.	100 grains of spirit to 85 grains of water.	100 grains of spirit to 90 grains of water.	100 grains of spirit to 95 grains of water.	100 grains of spirit to 100 grains of water.	95 grains of spirit to 100 grains of water.	90 grains of spirit to 100 grains of water.	85 grains of spirit to 100 grains of water.	80 grains of spirit to 100 grains of water.	75 grains of spirit to 100 grains of water.	70 grains of spirit to 100 grains of water.	65 grains of spirit to 100 grains of water.
deg.														
30	,92563	,92889	,93191	,93474	,93741	,93991	,94222	,94447	,94675	,94920	,95173	,95429	,95681	,95944
35	,92355	,92680	,92986	,93274	,93541	,93790	,94025	,94249	,94484	,94734	,94988	,95246	,95502	,95772
40	,92151	,92476	,92783	,93072	,93341	,93592	,93827	,94058	,94295	,94547	,94802	,95060	,95328	,95602
45	,91937	,92264	,92570	,92859	,93131	,93382	,93621	,93860	,94096	,94348	,94605	,94871	,95143	,95423
50	,91723	,92050	,92358	,92647	,92919	,93177	,93419	,93658	,93897	,94149	,94414	,94683	,94958	,95243
55	,91502	,91837	,92145	,92436	,92707	,92963	,93208	,93452	,93696	,93948	,94213	,94486	,94767	,95057
60	,91287	,91622	,91933	,92225	,92499	,92758	,93002	,93247	,93493	,93749	,94018	,94296	,94579	,94876
65	,91066	,91400	,91715	,92010	,92283	,92546	,92794	,93040	,93285	,93546	,93822	,94109	,94388	,94689
70	,90847	,91181	,91493	,91793	,92069	,92333	,92580	,92828	,93076	,93337	,93616	,93898	,94193	,94500
75	,90617	,90952	,91270	,91569	,91849	,92111	,92364	,92613	,92865	,93132	,93413	,93695	,93989	,94301
80	,90385	,90723	,91042	,91340	,91622	,91891	,92142	,92393	,92646	,92917	,93201	,93488	,93785	,94102
85	,90157	,90496	,90818	,91119	,91403	,91670	,91923	,92179	,92432	,92700	,92989	,93282	,93582	,93902
90	,89925	,90270	,90590	,90891	,91177	,91446	,91705	,91962	,92220	,92491	,92779	,93075	,93381	,93703
95	,89688	,90037	,90358	,90662	,90949	,91221	,91481	,91740	,91998	,92272	,92562	,92858	,93170	,93497
100	,89453	,89798	,90123	,90428	,90718	,90992	,91252	,91513	,91769	,92047	,92346	,92646	,92957	,93293
Heat.	60 grains of spirit to 100 grains of water.	55 grains of spirit to 100 grains of water.	50 grains of spirit to 100 grains of water.	45 grains of spirit to 100 grains of water.	40 grains of spirit to 100 grains of water.	35 grains of spirit to 100 grains of water.	30 grains of spirit to 100 grains of water.	25 grains of spirit to 100 grains of water.	20 grains of spirit to 100 grains of water.	15 grains of spirit to 100 grains of water.	10 grains of spirit to 100 grains of water.	5 grains of spirit to 100 grains of water.	Water.	
deg.														
30	,96209	,96470	,96719	,96967	,97200	,97418	,97635	,97860	,98108	,98412	,98804	,99334		
35	,96048	,96315	,96579	,96840	,97086	,97319	,97556	,97801	,98076	,98397	,98804	,99344	1,00090	
40	,95879	,96159	,96434	,96706	,96967	,97220	,97472	,97737	,98033	,98373	,98795	,99345	1,00094	
45	,95705	,95993	,96280	,96563	,96840	,97110	,97384	,97666	,97980	,98338	,98774	,99338	1,00086	
50	,95534	,95831	,96126	,96420	,96708	,96995	,97284	,97589	,97920	,98293	,98745	,99316	1,00068	
55	,95357	,95662	,95966	,96272	,96575	,96877	,97181	,97500	,97847	,98239	,98702	,99284	1,00038	
60	,95181	,95493	,95804	,96122	,96437	,96752	,97074	,97409	,97771	,98176	,98654	,99244	1,00000	
65	,95000	,95318	,95635	,95962	,96288	,96620	,96959	,97309	,97688	,98106	,98594	,99194	,99950	
70	,94813	,95139	,95469	,95802	,96143	,96484	,96836	,97203	,97596	,98028	,98527	,99134	,99894	
75	,94623	,94957	,95292	,95638	,95987	,96344	,96708	,97086	,97495	,97943	,98454	,99060	,99830	
80	,94431	,94766	,95111	,95467	,95826	,96192	,96568	,96963	,97385	,97844	,98367	,98951	,99759	
85	,94236	,94579	,94932	,95297	,95667	,96046	,96437	,96843	,97271	,97744	,98281	,98891	,99681	
90	,94042	,94389	,94748	,95123	,95502	,95889	,96293	,96711	,97153	,97637	,98185	,98824	,99598	
95	,93839	,94196	,94563	,94944	,95328	,95727	,96139	,96568	,97025	,97523	,98082	,98729	,99502	
100	,93638	,93999	,94368	,94759	,95152	,95556	,95983	,96424	,96895	,97401	,97969	,98625	,99402	

Spirituos  
Liquors.

Spirituos  
Liquors.

We formerly observed, that the series of mixtures chosen by Sir Charles Blagden, for the advantages attending it in making the experiment, was not suited for solving the questions which commonly occur in the spirit business. He accordingly suggests the propriety of forming tables in a convenient series from the data furnished by these experiments, indicating the proportion of ingredients contained in some constant weight or bulk.

To facilitate the construction of such tables, it is necessary to consider the subject in the most general manner. Therefore let  $a$  represent the constant number 100. Let  $w$  and  $s$  represent the quantities of water and spirit by weight in any mixture; that is, the pounds, ounces, or grains of each. Let  $x$  represent the quantity *per cent.* of spirits also by weight; that is, the number of pounds of spirits contained in 100 pounds of the mixture; and let  $y$  be its quantity *per cent.* in gallons, or the number of gallons contained in 100 gallons of the unmixed ingredients. Let  $m$  be the bulk of a pound of spirit of any given temperature, the bulk of a pound of water of the same temperature being accounted 1.

Then  $w+s$  is the weight of any mixture, and  $w+ms$  is its bulk.

We have the following proportions: 1.  $w+s : s = a : x$ , and  $x = \frac{a s}{w+s}$  (Equation 1st); and hence  $s$  may be found when  $x$  the per centage in weight is given, for  $s = \frac{w x}{a-x}$  (Equation 2.)

2.  $w+ms : ms = a : y$ , and  $y = a \frac{m s}{w+ms}$  (Equation 3d); and  $s$  may be found when  $y$ , the per centage in gallons, is given; for  $s = \frac{m y}{a-y}$  (Equation 4th.)

The usual questions which can be solved from these experiments are,

1. To ascertain the quantity of spirits *per cent.* in bulk from observation of the specific gravity, or to tell how many gallons of spirit are in 100 gallons of mixture.

Look for the specific gravity in the table, and at the head of the column will be found the  $w$  and  $s$  corresponding. If the precise specific gravity observed is not in the tables, the  $s$  must be found by interpolation. And here it is proper to remark, that taking the simple proportional parts of specific gravity will not be sufficiently exact, especially near the beginning or the end of the table, because the densities corresponding to the series of mixtures do not change uniformly. We must have recourse to the general rules of interpolation, by means of first and second differences, or be provided with a subsidiary table of differences. A good deal of practice in computations of this kind suggested the following method of making such interpolations with great dispatch and abundant accuracy. On a plate of wood, or metal, or stiff card-paper, draw a line EF (fig. 3.), as a scale of equal parts, representing the leading or equable arithmetical series of any table. (In the present case EF is the scale on which  $s$  is computed.)—Through every point of division draw the perpendiculars BA, EC, FD, &c. Make one of them AB more conspicuous than the rest, and distinguish the others

also in such sort, that the eye shall readily catch their distance from the principal line AB. Let GPL be a thin slip of whalebone, of uniform breadth and thickness, also divided into equal parts properly distinguishable. Lastly, let there be a pin P fixed near the middle of the principal line AB.

Now suppose that a value of  $s$  is to be interpolated by means of an observed specific gravity not in the table. Look for the nearest to it, and note its distance from the preceding and the following. Let these be PH and PK on the flexible scale. Also take notice of the lines K 10 and H 10, whose distances from AB are equal to the constant difference between the successive values of  $S$ , or to any easily estimated multiple of it (as in the present case we have taken 10 and 10, instead of 5 and 5, the running difference of Sir Charles Blagden's table). Then, leaning the middle point P of the whalebone on the pin P in the board, bend it, and place it slantwise till the points K and H fall somewhere on the two parallels K 10 and H 10. No matter how oblique the position of the whalebone is. It will bend in such a manner that its different points of division (representing different specific gravities) will fall on the parallels which represent the corresponding values of  $s$ . We can say that all this may be done in less than half a minute, and less time than is necessary for inspecting a table of proportional parts, and not the tenth part of that necessary for interpolating by second differences. Yet it is exact enough (if of the size of a duodecimo page) for interpolating three decimal places. This is ten times more exact than the present case requires. To return from this digression.

Having thus found  $s$  in the table, we get  $x$  or  $y$  by the equations  $\frac{a s}{w+s} = x$ , and  $a \frac{m s}{w+ms} = y$ .

But here a material circumstance occurs. The weight of alcohol  $s$ , and its per centage  $x$ , was rightly determined by the specific gravity, because it was interpolated between two values, which were experimentally connected with this specific gravity. But in making the transition from  $x$  to  $y$ , we only give the per centage in gallons before mixture, but not the number of gallons of alcohol contained in an hundred gallons of mixed liquor. For when we have taken  $a-y$  and  $y$  instead of  $w$  and  $s$ , they will indeed make a similar compound when mixed, because the proportion of their ingredients is the same. But they will not make 100 gallons of this compound, because there is a shrinking or condensation by mixture, and the specific gravity by which we interpolated  $s$  is the physical or real specific gravity corresponding to  $w$  and  $s$ ; while  $\frac{w+s}{w \times ms}$ , the specific gravity implied in the value of  $y$ , is the mathematical density independent on this condensation. Since therefore  $y$ , together with  $a-y$ , make less than 100 gallons of the compound, there must in 100 gallons of it be more alcohol than is expressed by  $y$ .

Let  $G$  be the mathematical specific gravity ( $= \frac{w+s}{w+ms}$ ), and  $g$  the physical or real observed specific gravity (which we cannot express algebraically); and let  $z$  be the gallons of alcohol really contained in 100 gallons of the compound. The bulk being inverted as the density or specific gravity, it is evident that the

Plate  
CCCLXXII.

Spirituous Liquors. bulk of the compound must be to 100 gallons as  $g$  to  $G$ . And since we want to make it fill up to 100 gallons, we must increase it in the proportion of  $G$  to  $g$ . And because this augmentation must be of the same strength with this contracted liquor, both ingredients must be increased in the proportion of  $G$  to  $g$ , and we must have  $G : g = y : z$ , and  $z = g \times \frac{y}{G}$ . Now, instead of  $y$ , write  $a \frac{m s}{w + m s}$ , and instead of  $\frac{1}{G}$  write  $\frac{w + m s}{w + s}$ , which are respectively equal to them. This

$$\text{gives us } z = g a \times \frac{w + m s}{w + s} \times \frac{m s}{w + s} = g a \times \frac{m s}{w + s}.$$

All this will be illustrated by an example.

Suppose that we have observed the specific gravity of a spirituous liquor of the temperature  $60^\circ$  to be  $0,94128$ . Looking into Sir Charles Blagden's table, we find the gravities  $0,94018$  and  $0,94296$ , and the  $s$  corresponding to them is  $80$  and  $75$ , the water in each mixture being  $100$ . By interpolation we obtain the  $s$  corresponding to  $0,94128$ , viz.  $78$ . At this temperature  $m$

$$= \frac{1}{0,825} = 1,21212, \text{ and } m s = 94,54545. \text{ Therefore } z = 0,94128 \times 100 \times \frac{94,54545}{194,54545} = 49,997, \text{ or very nearly } 50.$$

We have seen even persons not unacquainted with subjects of this kind puzzled by this sort of paradox.  $z$  is said to be the per centage of spirit in the compound. The compound has the same proportion of ingredients when made up to 100 gallons as before, when  $y$  was said to be its per centage, and yet  $y$  and  $z$  are not the same. The fact is, that although  $z$  is the number of gallons of alcohol really contained in 100 gallons of the compound, and this alcohol is in the same proportion as before to the water, this proportion is not that of 50 to 50: for if the ingredients were separated again, there would be 50 gallons of alcohol and 52,876 of water.

The proportion of the ingredients in their separate state is had by the 3d Equation  $y = a \frac{m s}{w + m s}$ , which

is equivalent to  $G a \frac{m s}{w + s}$ . For the present example

$y$  will be found  $48,599$ , and  $a - y$ , or the water per cent.  $51,401$ , making 100 gallons of unmixed ingredients. We see then that there has been added  $1,398$  gallons of alcohol; and since both ingredients are augmented in the proportion of  $G$  to  $g$ , there have also been added  $1,478$  of water, and the whole addition for making up the 100 gallons of compound is  $2,876$  gallons; and if the ingredients of the compound were separate, they would amount to  $102,876$  gallons. This might have been found at the first, by the proportion,  $G : g - G = 100 :$  (*The addition.*)

The next question which usually occurs in business is to find what density will result from any proposed mixture per gallon. This question is solved by means of the equation  $\frac{w y}{m(a-y)} = s$ . In this examination it will be most convenient to make  $w = a$ . If the value of  $s$  found in this manner falls on a value in the tables, we have

the specific gravity by inspection. If not, we must interpolate. Spirituous Liquors.

*N.B.* The value of  $m$ , which is employed in these reductions, varies with the temperature. It is always obtained by dividing the specific gravity of alcohol of that temperature by the specific gravity of water of the same temperature. The quotient is the real specific gravity of alcohol for that temperature. Both of these are to be had in the first and last compartments of Sir Charles Blagden's table.

These operations for particular cases give the answers to particular occasional questions. By applying them to all the numbers in the table, tables may be constructed for solving every question by inspection.

There is another question which occurs most frequently in the excise transactions, and also in all computations of spirituous liquors, viz. What strength will result from a mixture of two compounds of known strength, or mixing any compound with water? To solve questions of this kind by the table so often quoted, we must add into one sum the water per gallon of the different liquors. In like manner, take the sum of the spirits, and say, as the sum of the waters is to that of the alcohols, so is  $a$  to  $s$ ; and operate with  $a$  and  $s$  as before.

Analogous to this is the question of the duties. These are levied on proof spirit; that is, a certain duty is charged on a gallon of proof spirit; and the gauger's business is to discover how many gallons of proof spirit there is in any compound. The specification of proof spirit in our excise laws is exceedingly obscure and complex. A gallon weighing 7 pounds 13 ounces (at  $55^\circ$ ) is accounted 1 to 6 under proof. The gallon of water contains 58476 grains, and this spirit is 54688. Its density therefore is  $0,93523$  at  $55^\circ$ , or (as may be inferred from the table)  $0,9335$  at  $60^\circ$ . This density corresponds to a mixture of 100 grains of water with 93,457 of alcohol. If this be supposed to result from the mixture of 6 gallons of alcohol with 1 of water (as is supposed by the designation of 1 to 6 under proof), the gallon of proof spirits consists of 100 parts of spirits by weight, mixed with 75 parts of water. Such a spirit will have the density  $0,9162$  nearly.

This being premised, in order to find the gallons of proof spirits in any mixture, find the quantity of alcohol by weight, and then say, as 100 to 175, so is the alcohol in the compound to the proof spirit that may be made of it, and for which the duties must be paid.

We have considered this subject at some length, because it is of great importance in the spirit-trade to have these circumstances ascertained with precision; and because the specific gravity is the only sure criterion that can be had of the strength. Firing of gunpowder, or producing a certain bubble by shaking, are very vague tests; whereas, by the specific gravity, we can very securely ascertain the strength within one part in 500, as will presently appear.

Sir Charles Blagden, or Mr Gilpin, have published \* a most copious set of tables, calculated from these valuable experiments. In these, computations are made for every unit of the hundred, and for every degree of the thermometer. But these tables are still not in the most commodious form for business. Mr John Wilson, an ingenious gentleman residing at Dundee, has just published



Spirituos  
Liquors.

lified at Edinburgh tables somewhat similar, founded on the same experiments. Both of these tables show the quantities by measure corresponding to every unit by weight of Sir Charles Blagden's experiments, and for every degree of temperature. They also show the *per centage* of alcohol, and the condensation or the quantity lost by mixture. But as they both retain the original series of parts by weight, which is very unusual, the spirit traders will find considerable difficulty in making use of them. Retaining this series also causes all the *per centage* numbers (which are the only interesting ones to the trader) to be fractional, and no answer can be had without a double interpolation.

We have therefore calculated a table in the form in which it must be most useful and acceptable to those who are engaged in the spirit trade, showing at once the specific gravity which results from any proportion of admixture in hundredth parts of the whole. This answers immediately the chief questions in the terms in which they are usually conceived and proposed. The two first or leading columns show the proportion in gallons, pints, or other cubic measures, of the mixture, the whole quantity being always 100. The second column shows the corresponding specific gravity: so that we can either find the proportion of the ingredients by the

observed specific gravity, or find the gravty resulting from any proportion of the ingredients. A third column shows how much the hundred measures of the two ingredients fall short of making an hundred measures of the compound. A simple proportion, which can be done without the pen, will determine what part of this deficiency must be made up by spirit. The use of this table must now be so familiar to the reader's mind, that we need not give further instructions about it.

This is followed by another similar table, giving an immediate answer to the most usual question, "How many measures of alcohol are there really contained in 100 measures?" This is also accompanied by a column of condensation. It would have been somewhat more elegant, had the specific gravities in this table made the equable series and leading column. But we did not advert to this till we had computed the table, and the labour was too great to be repeated for slight reasons. The tables are only for the temperature 60°. To this the spirituous liquors can always be brought in these climates; and in cases where we cannot, a moment's inspection of Sir Charles Blagden's table will point out very nearly (or exactly, by a short computation) the necessary corrections.

Spirituos  
Liquors.

Compound.		Specific Gravity.	Cond. per cent.	Compound.		Specific Gravity.	Cond. per cent.	Compound.		Specific Gravity.	Cond. per cent.
S.	W.			S.	W.			S.	W.		
100	0	0,8250		66	34	0,9073	2,5	33	67	0,9640	2,3
99	1	0,8278	0,19	65	35	0,9095	2,6	32	68	0,9651	2,3
98	2	0,8306	0,33	64	36	0,9116	2,6	31	69	0,9662	2,2
97	3	0,8333	0,4	63	37	0,9137	2,6	30	70	0,9673	2,1
96	4	0,8360	0,5	62	38	0,9157	2,6	29	71	0,9683	2,
95	5	0,8387	0,6	61	39	0,9177	2,7	28	72	0,9693	1,9
94	6	0,8413	0,7	60	40	0,9198	2,7	27	73	0,9704	1,9
93	7	0,8439	0,8	59	41	0,9218	2,7	26	74	0,9713	1,8
92	8	0,8465	0,9	58	42	0,9238	2,7	25	75	0,9724	1,7
91	9	0,8491	1,	57	43	0,9257	2,7	24	76	0,9734	1,6
90	10	0,8516	1,1	56	44	0,9277	2,8	23	77	0,9744	1,6
89	11	0,8542	1,2	55	45	0,9296	2,8	22	78	0,9754	1,5
88	12	0,8567	1,3	54	46	0,9316	2,8	21	79	0,9763	1,4
87	13	0,8592	1,4	53	47	0,9335	2,8	20	80	0,9773	1,3
86	14	0,8617	1,5	52	48	0,9353	2,8	19	81	0,9783	1,2
85	15	0,8641	1,5	51	49	0,9371	2,8	18	82	0,9793	1,2
84	16	0,8666	1,6	50	50	0,9388	2,8	17	83	0,9802	1,1
83	17	0,8690	1,7	49	51	0,9406	2,8	16	84	0,9812	1,
82	18	0,8713	1,7	48	52	0,9423	2,8	15	85	0,9822	0,9
81	19	0,8737	1,7	47	53	0,9440	2,8	14	86	0,9832	0,9
80	20	0,8760	1,8	46	54	0,9456	2,7	13	87	0,9842	0,8
79	21	0,8764	1,9	45	55	0,9473	2,7	12	88	0,9853	0,7
78	22	0,8807	2,	44	56	0,9489	2,7	11	89	0,9863	0,7
77	23	0,8830	2,	43	57	0,9505	2,7	10	90	0,9874	0,6
76	24	0,8853	2,1	42	58	0,9520	2,7	9	91	0,9886	0,5
75	25	0,8876	2,1	41	59	0,9535	2,6	8	92	0,9897	0,4
74	26	0,8899	2,2	40	60	0,9549	2,6	7	93	0,9909	0,3
73	27	0,8921	2,2	39	61	0,9563	2,6	6	94	0,9921	0,3
72	28	0,8944	2,3	38	62	0,9577	2,5	5	95	0,9933	0,2
71	29	0,8966	2,3	37	63	0,9590	2,5	4	96	0,9946	0,1
70	30	0,8988	2,4	36	64	0,9603	2,4	3	97	0,9959	0,07
69	31	0,9010	2,5	35	65	0,9616	2,4	2	98	0,9972	0,03
68	32	0,9031	2,5	34	66	0,9628	2,3	1	99	0,9985	0,01
67	33	0,9053	2,5	33	67	0,9640	2,3	0	100	1,0000	0,00
66	34	0,9073	2,5								

Spiruous  
Liquors.Spiruous  
Liquor

Spir. per cent.	Specific Gravity.	Contr.	Spir. per cent.	Specific Gravity.	Contr.	Spir. per cent.	Specific Gravity.	Contr.
100	0,82500		66	0,91095	2,59	33	0,96481	2,27
99	0,82629	0,18	65	0,91306	2,62	32	0,96587	2,21
98	0,83142	0,34	64	0,91511	2,64	31	0,96691	2,15
97	0,83449	0,46	63	0,91714	2,66	30	0,96793	2,08
96	0,83750	0,57	62	0,91914	2,68	29	0,96894	2,00
95	0,84048	0,68	61	0,92112	2,70	28	0,96992	1,93
94	0,84339	0,8	60	0,92308	2,72	27	0,97089	1,86
93	0,84621	0,9	59	0,92501	2,74	26	0,97185	1,79
92	0,84900	1,01	58	0,92692	2,76	25	0,97280	1,71
91	0,85172	1,11	57	0,92883	2,77	24	0,97374	1,63
90	0,85443	1,21	56	0,93072	2,78	23	0,97468	1,56
89	0,85704	1,31	55	0,93258	2,80	22	0,97561	1,48
88	0,85971	1,39	54	0,93436	2,81	21	0,97654	1,4
87	0,86228	1,47	53	0,93612	2,81	20	0,97747	1,32
86	0,86483	1,54	52	0,93786	2,82	19	0,97841	1,24
85	0,86737	1,61	51	0,93958	2,81	18	0,97936	1,17
84	0,86987	1,67	50	0,94128	2,79	17	0,98032	1,08
83	0,87235	1,74	49	0,94293	2,78	16	0,98129	1,00
82	0,87481	1,81	48	0,94455	2,76	15	0,98228	,93
81	0,87726	1,88	47	0,94610	2,73	14	0,98328	,85
80	0,87969	1,94	46	0,94768	2,71	13	0,98430	,78
79	0,88207	2,	45	0,94923	2,70	12	0,98534	,71
78	0,88445	2,05	44	0,95074	2,68	11	0,98640	,66
77	0,88676	2,11	43	0,95219	2,66	10	0,98748	,61
76	0,88909	2,17	42	0,95364	2,63	9	0,98858	,57
75	0,89140	2,22	41	0,95502	2,60	8	0,98973	,43
74	0,89367	2,26	40	0,95636	2,58	7	0,99091	,34
73	0,89593	2,31	39	0,95766	2,54	6	0,99211	,25
72	0,89815	2,36	38	0,95894	2,49	5	0,99334	,18
71	0,90035	2,41	37	0,96019	2,46	4	0,99461	,12
70	0,90241	2,49	36	0,96141	2,43	3	0,99591	,07
69	0,90464	2,47	35	0,96258	2,38	2	0,99725	,03
68	0,90675	2,51	34	0,96371	2,33	1	0,99861	,01
67	0,90885	2,55	33	0,96481	2,27	0	1,00000	,00
66	0,91095	2,59						

"In the first table, of which the sole intention is to point out the proportion of ingredients, the specific gravities are computed only to four places, which will always give the answer true to  $\frac{1}{10000}$ th part. In the last, which is more immediately interesting to the merchant in his transactions with the excise office, the computation is carried one place further."

The consideration of the first of these two tables will furnish some useful information to the reader who is interested in the philosophy of chemical mixture, and who endeavours to investigate the nature of those forces which connect the particles of tangible matter. These vary with the distance of the particle; and therefore the law of their action, like that of universal gravitation, is to be discovered by measuring their sensible effects at their various distances. Their change of distance is seen in the change of density or specific gravity.

Did the individual densities of the water and spirit remain unchanged by mixture, the specific gravity would change by equal differences in the series of mixtures on which this table is constructed; for the bulk being always the same, the change of specific gravity must be the difference between the weight of the gallon of water which is added and that of the gallon of spirit which

is taken out. The whole difference of the specific gravities of spirits and water being 1,750 parts in 10,000, the augmentation by each successive change of a measure of spirit for a measure of water would be the 100th part of this, or 17,5. But, by taking the successive differences of density as they occur in the table, we see that they are vastly greater in the first additions of water, being then about 29; after which they gradually diminish to the medium quantity  $17\frac{1}{2}$ , when water and spirits are mixed in nearly equal bulks. The differences of specific gravity still diminish, and are reduced to 9, when about 75 parts of water are mixed with 25 of spirit. The differences now increase again; and the last, when 99 parts of water are mixed with 1 part of spirit, the difference from the specific gravity of pure water is above 14.

The mechanical effect, therefore, of the addition of a measure of water to a great quantity of spirit is greater than the similar effect of the addition of a measure of spirits to a great quantity of water. What we call mechanical effect is the local motion, the change of distance of the particles, that the corpuscular forces may again be in equilibrio. Observe, too, that this change is greater than in the proportion of the distance of the

particles; for the density of water is to that of spirits nearly as 6 to 5, and the changes of specific gravity are nearly as 6 to 3.

We also see that the changing cause, which produces the absolute condensation of each ingredient, ceases to operate when 75 parts of water have been mixed with 25 of alcohol; for the variation of specific gravity, from diminishing comes now to increase; and therefore, in this particular state of composition, is equable. Things are now in the same state as if we were mixing two fluids which did not act on each other, but were mutually disseminated, and whose specific gravities are nearly as 9 to 10; for the variation 9 of specific gravity may be considered as the 100th part of the whole difference, in the same manner as 17,5 would have been had water and alcohol sustained no contraction.

The imagination is greatly assisted in the contemplation of geometrical quantity by exhibiting it in its own form. Specific gravity, being an expression of density (a notion purely geometrical), admits of this illustration.

Therefore let AB (fig. 4.) represent the bulk of any mixture of water and alcohol. The specific gravity of water may be represented by a line of such a length, that AB shall be the difference between the gravities of alcohol and water. Suppose it extended upwards, towards *a*, till Ba is to Aa as 10,000 to 8250. It will suit our purpose better to represent it by a parallelogram a B F e, of any breadth BF. In this case the difference of the specific gravities of alcohol and water will be expressed by the parallelogram ABFE. If there were no change produced in the density of one or both ingredients, the specific gravity of the compound would increase as this parallelogram does, and AGHE would be the augmentation corresponding to the mixture of the quantity AG of alcohol with the quantity GB of water, and so of other mixtures. But, to express the augmentation of density as it really obtains, we must do it by some curvilinear area DABCHD, which varies at the rate determined by Sir Charles Blagden's experiments. This area must be precisely equal to the rectangle ABFE. It must therefore fall without it in some places, and be deficient in others. Let DMHKC be the curve which corresponds with these experiments. It is evident to the mathematical reader, that the ordinates LM, GH, IK, &c. of this curve are in the ultimate ratio of the differences of the observed specific gravities. If A $\alpha$ ,  $\alpha\beta$ , &c. are each = 5, the little spaces A $\alpha\delta$ D,  $\alpha\beta b\delta$ , &c. will be precisely equal to the differences of the specific gravities 0,8250; 0,8387; 0,8516; &c. corresponding to the different mixtures of water and alcohol. The curve cuts the side of the parallelogram in K, where the ordinate GK expresses the mean variation of density 0,0017,5. IK is the smallest variation. The condensation may be expressed by drawing a curve dmGkf parallel to DMGKF, making Dd = AE. The condensation is now represented by the spaces comprehended between this last curve and the abscissa AGB, reckoning those negative which lie on the other side of it. This shows us, not only that the condensation is greatest in the mixture AG $\times$ GB, but also that in mixing such a compound with another AIXIB, there is a rarefaction. Another curve ANPOB may be drawn, of which the ordinates LN, GP, IO, &c. are proportional to the areas ALmd, AGmD,

ALGmD (=AGmD—GIA), &c. This curve shows the whole condensation.

This manner of representing the specific gravities of mixtures will suggest many curious inferences to such as will consider them in the manner of Boseovich, with a view to ascertain the nature of the forces of cohesion and chemical affinities: And this manner of viewing the subject becomes every day more promising, in consequence of our improvements in chemical knowledge; for we now see, that mechanism, or motive forces, are the causes of chemical action. We see in almost every case, that chemical affinities are comparable with mechanical pressures; because the conversion of a liquid into a vapour or gas is prevented by atmospheric pressure, and produced by the great chemical agent heat. The action of heat, therefore, or of the cause of heat, is a mechanical action, and the forces are common mechanical forces, with which we are familiarly acquainted.

"It may be also remarked in the column of contractions, that in the beginning the contractions augment nearly in the proportion of the quantity of spirits (but more slowly); whereas, in the end, the contractions are nearly in the duplicate proportion of the quantity of water. This circumstance deserves the consideration of the philosopher. We have represented it to the eye by the curve *a g b d*."

We should here take some notice of the attempt made to elude some part of the duties, by adding some ingredient to the spirits. But our information on this subject is not very exact; and besides it would be doing no service to the trader to put fraud more in his power. There are some salts which make a very great augmentation of density, but they render the liquor unpalatable. Sugar is frequently used with this view; 16 grains of refined sugar dissolved in 1000 grains of proof spirits gave it no suspicious taste, and increased its specific gravity from 0,920 to 0,925, which is a very great change, equivalent to the addition of 9 grains of water to a mixture of 100 grains of alcohol and 80 of water.

SPITHEAD, a road between Portsmouth and the Isle of Wight, where the royal navy of Great Britain frequently rendezvous.

SPITTLE, in physiology. See SALIVA.

SPITZBERGEN. See GREENLAND, n<sup>o</sup> 10.

SPLACHNUM, in botany: A genus of plants belonging to the class of *cryptogamia*, and order of *musci*. The antheræ are cylindrical, and grow on a large coloured epophysis or umbraculum. The calyptra is caducous. The female star grows on a separate stem. There are six species, the rubrum, luteum, sphaericum, ampullaceum, vasculosum, angustatum. Two of these are natives of Britain.

1. The *ampullaceum*, or crewet splachnum, is found in bogs and marshes, and often upon cow-dung. It grows in thick tufts, and is about two inches high. The leaves are oval lanceolate, terminated with a long point or beard. The top of the filament or peduncle swells into the form of an inverted cone, which Linnæus terms an *apophysis* or *umbraculum*; upon the top of which is placed a cylindrical anthera, like the neck of a crewet. The calyptra is conical, and resembles a small extinguisher.

2. The *vasculosum*, or acorn-shaped splachnum, is found upon bogs and cow-dung, and upon the points of

*Spon*  
*Sporiaris*  
rocks on the top of the Highland mountains, as on Ben-Lomond, and in the Isle of Sky, and elsewhere. This differs little from the preceding, and perhaps is no more than a variety. The filaments are about an inch high. The leaves oval-acute, not so lanceolate and bearded as the other. The apophysis, and the anthera at the top of it, form together nearly an oval figure, not unlike an acorn in its cup, the apophysis being transversely semi-oval, and of a blood-red colour, the anthera short and conical. The calyptra is the same as that of the other. The operculum is short and obtuse, and the rim of the anthera has eight large horizontal cilia. The anthera of the other is also ciliated, but not so distinctly. It is an elegant moss, and very distinguishable on account of its orange-coloured filaments and dark-red capsules.

SPLEEN, in anatomy. See ANATOMY, n<sup>o</sup> 99.

SPLEEN-WORT. See ASPLENIVM.

SPLENETIC, a person afflicted with an obstruction of the spleen.

SPLINT, or SPLINT, among farriers, a callous insensible excrescence, breeding on the shank-bone of horses. See FARRIERY, Sect. xxxi.

SPLICING, in the sea-language, is the untwisting the ends of two cables or ropes, and working the several strands into one another by a sidd, so that they become as strong as if they were but one rope.

SPOILS, whatever is taken from the enemy in time of war. Among the ancient Greeks, the spoils were divided among the whole army; only the general's share was largest: but among the Romans, the spoils belonged to the republic.

SPOLETTO, a duchy of Italy, bounded on the north by the Marquise of Ancona and duchy of Urbino, on the east by Farther Abruzzo, on the south by Sabina and the patrimony of St Peter, and on the west by Orvieto and Perugia. It is about 55 miles in length and 40 in breadth. It was anciently a part of Umbria, and now belongs to the Pope.—The name of the capital city is also *Spoletto*. It was formerly a large place, but in 1703 was ruined by an earthquake; from whence it has never recovered itself.

SPOILIATION, in ecclesiastical law, is an injury done by one clerk or incumbent to another, in taking the fruits of his benefice without any right thereunto, but under a pretended title. It is remedied by a decree to account for the profits so taken. This injury, when the *jus patronatus*, or right of advowson, doth not come in debate, is cognizable in the spiritual court: as if a patron first presents A to a benefice, who is instituted and inducted thereto; and then, upon pretence of a vacancy, the same patron presents B to the same living, and he also obtains institution and induction. Now if A disputes the fact of the vacancy, then that clerk who is kept out of the profits of the living, whichever it be, may sue the other in the spiritual court for spoliation, or taking the profits of his benefice. And it shall there be tried, whether the living were or were not vacant; upon which the validity of the second clerk's pretensions must depend. But if the right of patronage comes at all into dispute, as if one patron presented A, and another patron presented B, there the ecclesiastical court hath no cognizance, provided the tithes sued for amount to a fourth part of the value of the living, but may be prohibited at the in-

*Spon*  
*Spongi*  
stance of the patron by the king's writ of *indicavit*. So also if a clerk, without any colour of title, ejects another from his parsonage, this injury must be redressed in the temporal courts: for it depends upon no question determinable by the spiritual law (as plurality of benefices or no plurality, vacancy or no vacancy), but is merely a civil injury.

SPONDEE, in ancient poetry, a foot consisting of two long syllables, as *omnes*.

SPONDIAS, BRASILIAN OR JAMAICA PLUM, in botany; a genus of plants belonging to the class of *decandria*, and order of *pentagynia*. The calyx is quinque-dentate. The corolla pentapetalous. The fruit contains a quinquelocular kernel. There are only two species, the mombin and myrobalanus, which appear so much confounded in the descriptions of different botanists, that we do not venture to present them to our readers.

SPONGIA, SPONGE, in natural history; a genus of animals belonging to the class of *vermes*, and order of *zoophyta*. It is fixed, flexible, and very torpid, growing in a variety of forms, composed either of reticulated fibres, or masses of small spines interwoven together, and clothed with a living gelatinous flesh, full of small mouths or holes on its surface, by which it sucks in and throws out the water. Fifty species have already been discovered, of which 10 belong to the British coasts.

1. *Oculata*, or branched sponge, is delicately soft and very much branched; the branches are a little compressed, grow erect, and often united together. They have rows of cells on each margin, that project a little. This species is of a pale yellow colour, from five to ten inches high. The fibres are reticulated, and the flesh or gelatinous part is so tender, that when it is taken out of the water it soon dries away. It is very common round the sea-coast of Britain and Ireland. This description will be better understood by Plate ccccxxxv. fig. 1. At *b, b*, along the edges and on the surface of the branches, are rows of small papillary holes, through which the animal receives its nourishment.

2. *Griffata*, or cock's comb sponge, is flat, erect, and soft, growing in the shape of cock's combs, with rows of little holes along the tops, which project a little. It abounds on the rocks to the eastward of Hastings in Suffex, where it may be seen at low-water. It is commonly about three inches long, and two inches high, and of a pale yellowish colour. When put into a glass vessel of sea-water, it has been observed to suck in and squirt out the water through little mouths along the tops, giving evident signs of life.

3. *Stuposa*, tow-sponge, or downy branched sponge, is soft like tow, with round branches, and covered with fine pointed hairs. It is of a pale yellow colour, and about three inches high. It is frequently thrown on the shore at Hastings in Suffex. Fig. 2. represents this sponge; but it is so closely covered with a fine down, that the numerous small holes in its surface are not discernible.

4. *Dichotoma*, dichotomous or forked sponge, is stiff, branched, with round, upright, elastic branches, covered with minute hairs. It is found on the coast of Norway, and also, according to Berkenhout, on the Cornish and Yorkshire coasts. It is of a pale yellow colour, and full of very minute pores, guarded by minute spines. Fig. 3.

*Fig. 4.*

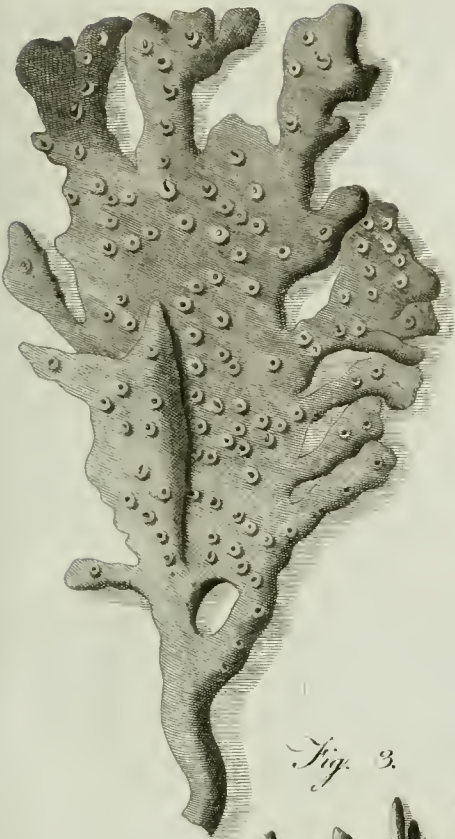

*Fig. 2.*

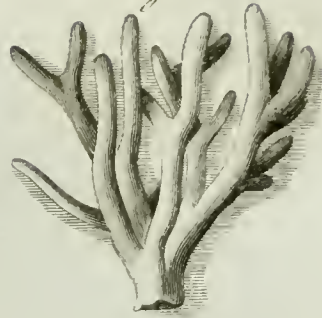

*Fig. 1.*

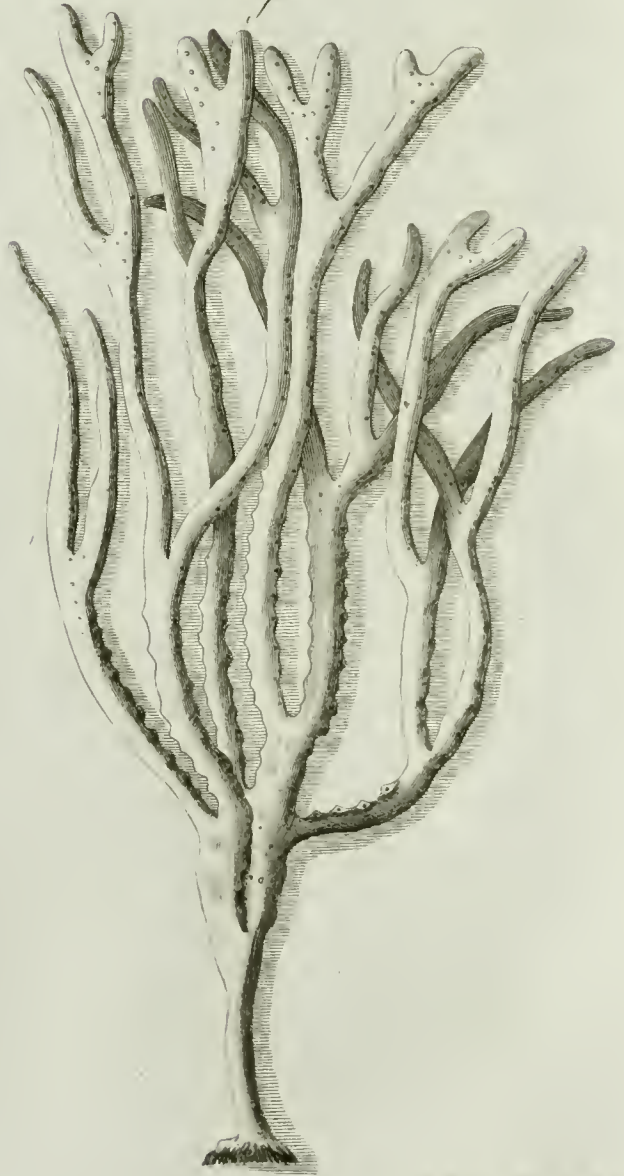

*Fig. 3.*





*Spongia.* 5. *Urens* or *tomentosa*, stinging sponge, or crumb of bread sponge, is of many forms, full of pores, very brittle and soft, and interwoven with very minute spines. It is full of small protuberances, with a hole in each, by which it sucks in and throws out the water. It is very common on the British coast, and is frequently seen surrounding fucuses. It is found also on the shores of North America, Africa, and in the East Indies. When newly taken out of the sea, it is of a bright orange colour, and full of gelatinous flesh; but when dry, it becomes whitish, and when broken has the appearance of crumb of bread. If rubbed on the hand, it will raise blisters; and if dried in an oven, its power of stinging is much increased, especially that variety of it which is found on the sea-coast of North America.

6. *Palmata*, palmated sponge, is like a hand with fingers a little divided at the top. The mouths are a little prominent, and irregularly disposed on the surface. It is found on the beach at Brightelmstone. It is of a reddish colour, inclining to yellow, and of the same soft woolly texture with the *spongia oculata*, fig. 4.

7. *Coronata*, coronet sponge, is very small, consisting of a single tube surrounded at top by a crown of little spines. The tube is open at the top. The rays that compose the little crown are of a bright, shining pearl colour; the body is of a pale yellow. It has been found in the harbour of Emsworth, between Suffex and Hampshire.

8. *Botryoides*, grape sponge, is very tender and branched, as if in bunches: the bunches are hollow, and are made up of oblong oval figures having the appearance of grapes; and each bunch is open at top. This species is of a bright, shining colour. The openings at the top are evidently the mouths by which the animal imbibes and discharges moisture. When the surface is very much magnified, it appears covered with little masses of triple, equidistant, shining spines.

9. *Lacustris*, creeping sponge, has erect, cylindrical, and obtuse branches. It is found in lakes in Sweden and England.

10. *Fluviatilis*, river sponge, is green, erect, brittle, and irregularly disposed in numerous branches. It abounds in many parts of Europe, in the fresh rivers of Russia and England, but particularly in the river Thames. It scarcely exhibits any symptoms of life, is of a fishy smell: its pores or mouths are sometimes filled with green gelatinous globules. It differs very little from the *lacustris*.

So early as the days of Aristotle sponges were supposed to possess animal life; the persons employed in collecting them having observed them shrink when torn from the rocks, thus exhibiting symptoms of sensation. The same opinion prevailed in the time of Pliny: But no attention was paid to this subject till Count Marsigli examined them, and declared them vegetables. Dr Peyssonell, in a paper which he sent to the Royal Society in the year 1752, and in a second in 1757, affirmed they were not vegetables, but the production of animals; and has accordingly described the animals, and the process which they performed in making the sponges. Mr Ellis, in the year 1762, was at great pains to discover these animals. For this purpose he dissected the *spongia urens*, and was surpris'd to find a great number of small worms of the genus of *nereis* or *sea-scolopendra*, which had pierc'd their way through

the soft substance of the sponge in quest of a safe retreat. That this was really the case, he was fully assured of, by inspecting a number of specimens of the same sort of sponge just fresh from the sea. He put them into a glass filled with sea-water; and then, instead of seeing any of the little animals which Dr Peyssonell described, he observed the papillæ or small holes with which the papillæ are surrounded contract and dilate themselves. He examined another variety of the same species of sponge, and plainly perceived the small tubes inspire and expire the water. He therefore concluded, that the sponge is an animal, and that the ends or openings of the branched tubes are the mouths by which it receives its nourishment, and discharges its excrements.

SPONSORS, among Christians, are those persons who, in the office of baptism, answer or are surties for the persons baptized.

SPONTANEOUS, a term applied to such motions of the body and operations of the mind as we perform of ourselves without any constraint.

SPOON BILL, in ornithology. See PLATALEA.

SPOONING, in the sea-language, is said of a ship, which being under sail in a storm at sea, is unable to bear it, and consequently forced to go right before the wind.

SPORADES, among ancient astronomers, a name given to such stars as were not included in any constellation.

SPORADIC DISEASES, among physicians, are such as seize particular persons at any time or season, and in any place; in which sense they are distinguished from epidemical and endemical diseases.

SPOTS, in astronomy, certain places of the sun's or moon's disk, observed to be either more bright or dark than the rest; and accordingly called *facule* & *macule*. See ASTRONOMY-Index.

SPOISWOOD (John), archbishop of St Andrew's in Scotland, was descended from the lairds of Spofwood in the Merse, and was born in the year 1565. He was educated in the university of Glasgow, and succeeded his father in the parsonage of Calder when but 18 years of age. In 1601 he attended Lodowick duke of Lennox as his chaplain, in an embassy to the court of France for confirming the ancient amity between the two nations, and returned in the ambassador's retinue through England. When he entered into the archbishopric of Glasgow, he found there was not 100l. Sterling of yearly revenue left; yet such was his care for his successors, that he greatly improved it, and much to the satisfaction of his diocese. After having filled this see 11 years, he was raised to that of St Andrew's in 1615, and made primate and metropolitan of all Scotland. He presided in several assemblies for restoring the ancient discipline, and bringing the church of Scotland to some sort of uniformity with that of England. He continued in high esteem with king James I. nor was he less valued by king Charles I. who was crowned by him in 1633, in the abbey-church of Holyroodhouse. In 1635, upon the death of the earl of Kinnoul chancellor of Scotland, our primate was advanced to that post; but had scarcely held it four years, when the confusions beginning in Scotland, he was obliged to retire into England; and being broken with age, grief, and sickness, died at London in

*Sprout* 1639, and was interred in Westminster-abbey. He wrote  
 A History of the Church of Scotland from the year  
 1202 to the reign of King James VI. in folio.

*SPOUT*, or *Water-Spout*. See *WATER-SPOUT*.

*SPOUT-Fish*. See *SOLEN*.

*SPRAT* (Dr Thomas), bishop of Rochester, was born in 1636. He had his education at Oxford, and after the Restoration entered into holy orders. He became fellow of the Royal Society, chaplain to George duke of Buckingham, and chaplain in ordinary to king Charles II. In 1667 he published the History of the Royal Society, and a Life of Mr Cowley; who, by his last will, left to his care his printed works and MSS. which were accordingly published by him. In 1668 he was installed prebendary of Westminster; in 1680, was appointed canon of Windsor; in 1683, dean of Westminster; and in 1684, consecrated to the bishopric of Rochester. He was clerk of the closet to king James II.; in 1685, was made dean of the chapel royal; and the year following, was appointed one of the commissioners for ecclesiastical affairs. In 1692 his lordship, with several other persons, was charged with treason by two men, who drew up an association, in which they whose names were subscribed declared their resolution to restore king James; to seize the prince of Orange, dead or alive; and to be ready with 30,000 men to meet king James when he should land. To this they put the names of Sancroft, Sprat, Marlborough, Salisbury, and others. The bishop was arrested, and kept at a messenger's, under a strict guard, for eleven days. His house was searched, and his papers seized, among which nothing was found of a treasonable appearance, except one memorandum, in the following words: *Thorough-paced doctrine*. Being asked at his examination the meaning of the words, he said that, about 20 years before, curiosity had led him to hear Daniel Burgess's preach; and that being struck with his account of a certain kind of doctrine, which he said entered at one ear, and passing through the head went out at the other, he had inserted the memorandum in his table-book, that he might not lose the substance of so strange a sermon. His innocence being proved, he was set at liberty, when he published an account of his examination and deliverance; which made such an impression upon him, that he commemorated it through life by an yearly day of thanksgiving. He lived to the 79th year of his age, and died May 20. 1713. His works, besides a few poems of little value, are, "The History of the Royal Society;" "The Life of Cowley;" "The Answer to Sorbiere;" "The History of the Rye-house Plot;" "The Relation of his own Examination;" and a volume of "Sermons." Dr Johnson says, "I have heard it observed, with great justice, that every book is of a different kind, and that each has its distinct and characteristical excellence."

*SPRAT*, in ichthyology. See *CLUPEA*.

*SPRAY*, the sprinkling of the sea, which is driven from the top of a wave in stormy weather. It differs from spoon drift, as being only blown occasionally from the broken surface of a high wave; whereas the latter continues to fly horizontally along the sea, without intermission, during the excess of a tempest or hurricane.

*SPRING*, in natural history, a fountain or source of water rising out of the ground.

Many have been the conjectures of philosophers con-

cerning the origin of fountains, and great pains have been taken both by the members of the Royal Society and those of the Academy of Sciences at Paris, in order to ascertain the true cause of it. It was Aristotle's opinion, and held by most of the ancient philosophers after him, that the air contained in the caverns of the earth, being condensed by cold near its surface, was thereby changed into water; and that it made its way through, where it could find a passage. But we have no experience of any such transmutation of air into water.

Those who imagine that fountains owe their origin to waters brought from the sea by subterraneous ducts, give a tolerable account how they lose their saltness by percolation as they pass through the earth; but they find great difficulty in explaining by what power the water rises above the level of the sea to near the tops of mountains, where springs generally abound; it being contrary to the laws of hydrostatics, that a fluid should rise in a tube above the level of its source. However, they have found two ways whereby they endeavour to extricate themselves from this difficulty. The one is that of Des Cartes, who imagines, that after the water is become fresh by percolation, it is raised out of the caverns of the earth in vapour towards its surface; where meeting with rocks near the tops of mountains in the form of arches or vaults, it sticks to them, and runs down their sides, (like water in an alembic), till it meets with proper receptacles, from which it supplies the fountains. Now this is a mere hypothesis, without foundation or probability: for, in the first place, we know of no internal heat of the earth to cause such evaporation; or if that were allowed, yet it is quite incredible that there should be any caverns so smooth and void of protuberances as to answer the ends of an alembic, in collecting and condensing the vapours together in every place where fountains arise. There are others (as Varenus, &c.) who suppose that the water may rise through the pores of the earth, as through capillary tubes by attraction. But hereby they show, that they are quite unacquainted with what relates to the motion of a fluid through such tubes: for when a capillary tube opens into a cavity at its upper end, or grows larger and larger, so as to cease to be capillary at that end, the water will not ascend through that tube into the cavity, or beyond where the tube is capillary; because that part of the periphery of the cavity, which is partly above the surface of the water and partly below it, is not of the capillary kind. Nay, if the cavity is continually supplied with water, it will be attracted into the capillary tube, and run down it as through a funnel, if the lower end is immersed in the same fluid, as in this case it is supposed to be.

It has been a generally received opinion, and much espoused by Mariotte (a diligent observer of nature), that the rise of springs is owing to the rains and melted snow. According to him, the rain-water which falls upon the hills and mountains, penetrating the surface, meets with clay or rocks contiguous to each other; along which it runs, without being able to penetrate them, till, being got to the bottom of the mountain, or to a considerable distance from the top, it breaks out of the ground, and forms springs.

In order to examine this opinion, Mr Perrault, De la Hire, and D. Sideleau, endeavoured to make an estimate



Spring.

estimate of the quantity of rain and snow that falls in the space of a year, to see whether it would be sufficient to afford a quantity of water equal to that which is annually discharged into the sea by the rivers. The result of their inquiries was, that the quantity of rain and snow which fell in a year into a cylindrical vessel would fill it (if secured from evaporating) to the height of about nineteen inches. Which quantity D. Sideleau showed, was not sufficient to supply the rivers; for that those of England, Ireland, and Spain, discharge a greater quantity of water annually, than the rain, according to that experiment, is able to supply. Besides which, another observation was made by them at the same time, viz. that the quantity of water raised in vapour, one year with another, amounted to about thirty-two inches, which is thirteen more than falls in rain: a plain indication that the water of fountains is not supplied by rain and melted snow.

Thus the true cause of the origin of fountains remained undiscovered, till Dr Halley, in making his celestial observations upon the tops of the mountains at St Helena, about 800 yards above the level of the sea, found, that the quantity of vapour which fell there (even when the sky was clear) was so great, that it very much impeded his observations, by covering his glasses with water every half quarter of an hour; and upon that he attempted to determine by experiment the quantity of vapour exhaled from the surface of the sea, as far as it rises from heat, in order to try whether that might be a sufficient supply for the water continually discharged by fountains. The process of his experiment was as follows: He took a vessel of water salted to the same degree with that of sea water, in which he placed a thermometer; and by means of a pan of coals brought the water to the same degree of heat, which is observed to be that of the air in our hottest summer; this done, he fixed the vessel of water with the thermometer in it to one end of a pair of scales, and exactly counterpoised it with weights on the other: then, at the end of two hours, he found, by the alteration made in the weight of the vessel, that about a sixtieth part of an inch of the depth of the water was gone off in vapour; and therefore, in twelve hours, one-tenth of an inch would have gone off. Now this accurate observer allows the Mediterranean Sea to be forty degrees long, and four broad, (the broader parts compensating for the narrower, so that its whole surface is 160 square degrees); which, according to the experiment, must yield at least 5,280,000,000 tons of water: In which account no regard is had to the wind and the agitation of the surface of the sea, both which undoubtedly promote the evaporation.

It remained now to compare this quantity of water with that which is daily conveyed into the same sea by the rivers. The only way to do which was to compare them with some known river; and accordingly he takes his computation from the river Thames; and, to avoid all objections, makes allowances, probably greater than what were absolutely necessary.

The Mediterranean receives the following considerable rivers, viz. the Iberus, the Rhone, the Tyber, the Po, the Danube, the Nießer, the Borysthenes, the Tanais, and the Nile. Each of these he supposes to bring down ten times as much water as the Thames, whereby he allows for smaller rivers which fall into the same sea.

The Thames, then, he finds by mensuration to discharge about 20,300,000 tons of water a-day. If therefore the above-said nine rivers yield ten times as much water as the Thames doth, it will follow, that all of them together yield but 1827 millions of tons in a day, which is but little more than one-third of what is proved to be raised in vapour out of the Mediterranean in the same time. We have therefore from hence a source abundantly sufficient for the supply of fountains.

Now having found that the vapour exhaled from the sea is a sufficient supply for the fountains, he proceeds in the next place to consider the manner in which they are raised; and how they are condensed into water again, and conveyed to the sources of springs.

In order to this he considers, that if an atom of water was expanded into a shell or bubble, so as to be ten times as big in diameter as when it was water, that atom would become specifically lighter than air; and therefore would rise so long as the warmth which first separated it from the surface of the water should continue to distend it to the same degree; and consequently, that vapours may be raised from the surface of the sea in that manner, till they arrive at a certain height in the atmosphere, at which they find air of equal specific gravity with themselves. Here they will float till, being condensed by cold, they become specifically heavier than the air, and fall down in dew; or being driven by the winds against the sides of mountains (many of which far surpass the usual height to which the vapours would of themselves ascend), are compelled by the stream of the air to mount up with it to the tops of them; where being condensed into water, they presently precipitate, and gleeting down by the crannies of the stones, part of them enters into the caverns of the hills; which being once filled, all the overplus of water that comes thither runs over by the lowest place, and breaking out by the sides of the hills forms single springs. Many of these running down by the valleys between the ridges of the hills, and coming to unite, form little rivulets or brooks: many of these again meeting in one common valley, and gaining the plain ground, being grown less rapid, become a river; and many of these being united in one common channel, make such streams as the Rhine and the Danube; which latter, he observes, one would hardly think to be a collection of water condensed out of vapour, unless we consider how vast a tract of ground that river drains, and that it is the sum of all those springs which break out on the south side of the Carpathian mountains, and on the north side of the immense ridge of the Alps, which is one continued chain of mountains from Switzerland to the Black Sea.

Thus one part of the vapours which are blown on the land is returned by the rivers into the sea from whence it came. Another part falls into the sea before it reaches the land; and this is the reason why the rivers do not return so much water into the Mediterranean as is raised in vapour. A third part falls on the low lands, where it affords nourishment to plants; yet it does not rest there, but is again exhaled in vapour by the action of the sun, and is either carried by the winds to the sea to fall in rain or dew there, or else to the mountains to become the sources of springs.

However, it is not to be supposed that all fountains are owing to one and the same cause; but that some proceed from rain and melted snow, which, subsiding through

Spring.

Spring.

through the surface of the earth, makes its way into certain cavities, and thence issues out in the form of springs; because the waters of several are found to increase and diminish in proportion to the rain which falls: that others again, especially such as are salt, and spring near the sea-shore, owe their origin to sea-water percolated through the earth; and some to both these causes: though without doubt most of them, and especially such as spring near the tops of high mountains, receive their waters from vapours, as before explained.

This reasoning of Dr Halley's is confirmed by more recent observations and discoveries. It is now found, that though water is a tolerable conductor of the electric fluid, dry earth is an electric *per se*, consequently the dry land must always be in an electrified state compared with the ocean, unless in such particular cases as are mentioned under the article EARTHQUAKE, n° 82. It is also well known, that such bodies as are in an electrified state, whether *plus* or *minus*, will attract vapour, or other light substances that come near them. Hence the vapours that are raised from the ocean must necessarily have a tendency to approach the land in great quantity, even without the assistance of the wind, though this last must undoubtedly contribute greatly towards the same purpose, as Dr Halley justly observes. In like manner, the higher grounds are always in a more electrified state than the lower ones: and hence the vapours having once left the ocean and approached the shore, are attracted by the high mountains; of which Mr Pennant gives an instance in Snowdon. Hence we may see the reason why springs are so common in the neighbourhood of mountains, they being so advantageously formed in every respect for collecting and condensing the vapours into water.

The heat of springs is generally the same with the mean temperature of the atmosphere. The mean temperature of the south of England is 48°; in Scotland, near Edinburgh, it is 45°; in the north of Ireland it is 48°, and on the south coast about 51°. At Upsal, in Sweden, it is 43°, and in Paris 53°. According to accurate experiments made by eminent philosophers, the heat of the springs in these different countries corresponds with the medium temperature. We have not heard that similar experiments have been made in other countries, or we should have been careful to collect them. We do not, however, doubt but they have been made in most countries of Europe; yet we suspect little attention has been paid to this subject within the tropical regions.

Though this coincidence of the heat of springs with the mean temperature of the climate where they flow, seems to be a general fact, yet it admits of many exceptions. In many parts of the world there are springs which not only exceed the mean temperature, but even the strongest meridian heat ever known in the torrid regions. The following table will give a distinct notion of the degrees of heat which different springs have been found to possess, according to the experiments of philosophers. It is necessary to remark, that experiments made upon the same springs, made by different persons, vary a little from one another, which may be owing to many accidents easily accounted for. Where this is the case, we shall mention both the lowest and highest degree of heat which has been ascribed to the same spring, according to Fahrenheit's thermometer.

Places.	Springs.	Highest degree of heat.	Lowest degree of heat.	Springs.
Bristol,	St Vincent's or the hot well,	84	76	
Buxton,	Gentleman's bath,	82		
Matlock,		69		
Bath,	King's bath,	119	113	
Aix-la-Chapelle,		146	136	
Barege,		122		
Pisa,		104		
Caroline baths in Bohemia,	Prudel or furi-ous,	165		
Iceland,	Geyzer,	212		

In cold countries, where congelation takes place, the heat of the earth is considerably above the freezing point, and continues so through the whole year. From experiments that have been made in mines and deep pits, it appears that this heat is uniform and stationary at a certain depth. But as the heat of these springs far exceeds the common heat of the internal parts of the earth, it must be occasioned by causes peculiar to certain places; but what these causes are it is no easy matter to determine. We are certain, indeed, that hot springs receive their heat from some subterranean cause; but it is a matter of difficulty to investigate how this heat is produced and preserved. Theories, however, have been formed on this subject. The subterranean heat has been ascribed to the electrical fluid, and to a great body of fire in the centre of the earth: But we suspect that the nature of the electrical fluid and its effects are not sufficiently understood. As to the supposition that the heat of springs is owing to a central fire, it is too hypothetical to require any refutation. From what then does this heat originate, and whence is the fuel which has produced it for so many ages? To enable us to answer these questions with precision, more information is necessary than we have hitherto obtained respecting the structure of the internal parts of the earth. It is peculiarly requisite that we should be made acquainted with the fossils which are most common in those places where hot springs abound. We should then perhaps discover that hot springs always pass thro' bodies of a combustible nature. It is well known to chemists, that when water is mixed with the vitriolic acid, a degree of heat is produced superior to that of boiling water. It is also an established fact, that when water meets with pyrites, that is, a mixture of sulphur and iron, a violent inflammation takes place. If, therefore, we could prove that these materials exist in the strata from which hot springs are derived, we should be enabled to give a satisfactory account of this curious phenomenon. As some apology for this supposition, we may add, that most of the hot springs mentioned above have been found by analysis to be impregnated with sulphur, and some of them with iron. It must, however, be acknowledged, that the hot springs of Iceland, which are 112°, the heat of boiling water, according to an accurate analysis of their contents by the ingenious Dr Black, were neither found to contain iron nor sulphur. It will therefore, perhaps, be necessary that we should wait with patience, and continue to collect facts, till the sciences of chemistry and mineralogy shall be so far advanced as to enable us to form a permanent theory on this subject.

Springs are of different kinds. Some are perennial,



*Zygæna or Balance Fish.*

*Tigrinus or Tigræ.*



*Maximus or Basking Shark.*



*Carcharias or white Shark.*

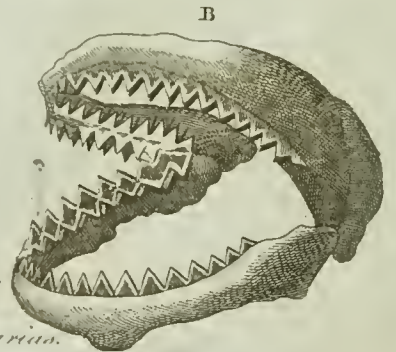
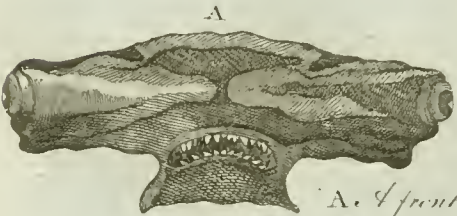
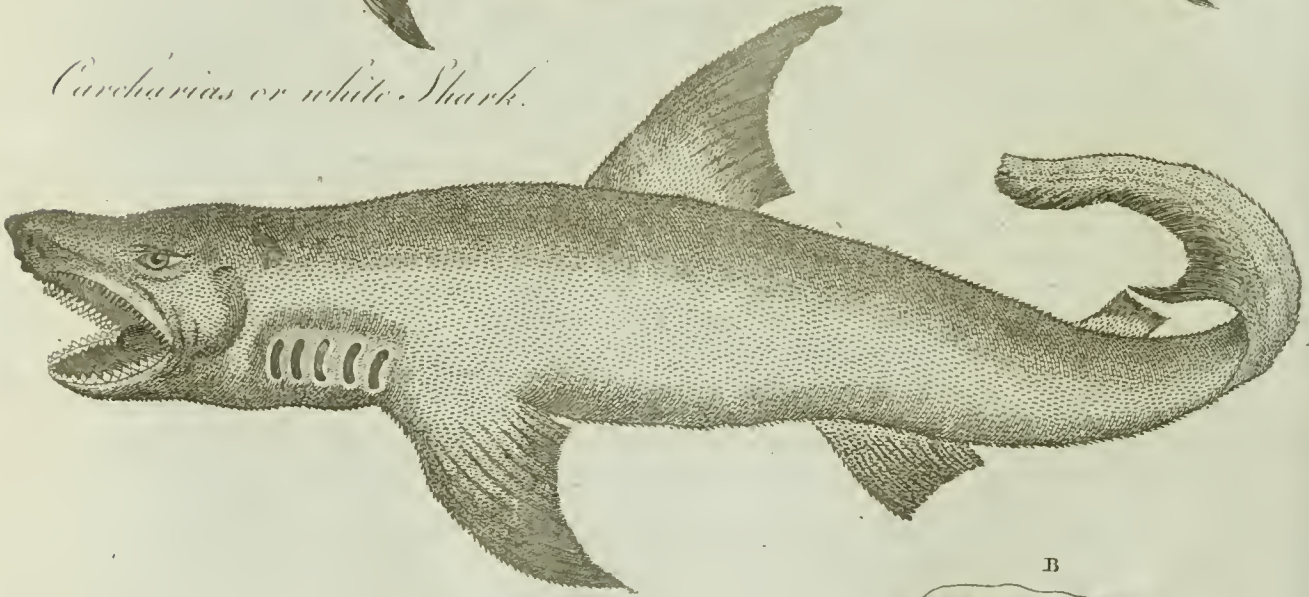

A. A front view of the Tigræ's head.

B. The jaws and head of the Carcharias.

*W. Bull. Pinx. Sulph. sc.*

or continue to flow during the whole year; others flow only during the rainy season; some ebb and flow. At Torbay there is one of this kind, which ebbs and flows five or six inches every hour. There is another near Coriso in Italy, which ebbed and flowed three times a day in the time of Pliny, and continues to do still. A spring near Henly sometimes flows for two years together, and then dries up for an equal period. The cause of this is explained under the article HYDROSTATICS, n<sup>o</sup> 26. For the ingredients found in springs, see *MINERAL Waters, and WATER.*

SPRING, in mechanics, denotes a thin piece of tempered steel, or other elastic substance, which being wound up serves to put machines in motion by its elasticity, or endeavours to unbend itself; such is the spring of a watch, clock, or the like.

SPRING, *Ver*, in cosmography, denotes one of the seasons of the year; commencing, in the northern parts of the world, on the day the sun enters the first degree of Aries, which is about the 10th day of March, and ending when the sun leaves Gemini; or, more strictly and generally, the spring begins on the day when the distance of the sun's meridian altitude from the zenith, being on the increase, is at a medium between the greatest and least. The end of the spring coincides with the beginning of summer. See SUMMER.

*SPRING-Tide.* See *ASTRONOMY-Index*, and *TIDE.*

*Burning Springs.* See *BURNING-Springs.*

SPRINGER, or *SPRING-Boat*, in zoology. See *CAPRA.*

SPRIT, a small boom or pole which crosses the fail of a boat diagonally, from the mast to the upper hindmost corner of the sail, which it is used to extend and elevate; the lower end of the sprit rests in a sort of wreath or collar called the *smotter*, which encircles the mast in that place.

SPRIT-SAIL. See *SAIL and SHIP.*

*SPRITSAIL-Top-sail.* See *SAIL and SHIP.*

SPRUCE-TREE. See *PINUS.*

*SPRUCE-Beer*, a cheap and wholesome liquor, which is thus made: Take of water 16 gallons, and boil the half of it. Put the water thus boiled, while in full heat, to the reserved cold part, which should be previously put into a barrel or other vessel; then add 16 pounds of treacle or molasses, with a few table spoonfuls of the essence of spruce, stirring the whole well together; add half a pint of yeast, and keep it in a temperate situation, with the bung hole open, for two days, till the fermentation be abated. Then close it up or bottle it off, and it will be fit for being drunk in a few days afterwards. In North America, and perhaps in other countries, where the black and white spruce-firs abound, instead of adding the essence of the spruce at the same time with the molasses, they make a decoction of the leaves and small branches of these trees, and find the liquor equally good. It is a powerful anti-scorbutic, and may prove very useful in long sea voyages.

SPUNGE, or SPONGE. See *SPONGIA.*

SPUNGING, in gunnery, the cleaning of the inside of a gun with a sponge, in order to prevent any sparks of fire from remaining in it, which would endanger the life of him that should load it again.

SPUN-YARN, among sailors, is a kind of line made from rope yarn, and used for seizing or fastening things together.

VOL. XVII. Part II.

SPUNK, in botany. See *BOLETUS.*

SPUR, a piece of metal consisting of two branches encompassing a horseman's heel, and a rowel in form of a star, advancing out behind to prick the horse.

*SPUR-Winged Water Hen.* See *PARRA.*

SPURGE, in botany. See *EUPHORBIA.*

*SPURGE-Laurel.* See *DAPHNE.*

SPURREY, in botany. See *SPERGULA.*

SPY, a person hired to watch the actions, motions, &c. of another; particularly what passes in a camp. When a spy is discovered, he is hanged immediately.

SQUADRON, in military affairs, denotes a body of horse whose number of men is not fixed; but is usually from 100 to 200.

*SQUADRON of Ships*, either implies a detachment of ships employed on any particular expedition, or the third part of a naval armament.

SQUADS, in a military sense, are certain divisions of a company into so many squads, generally into three or four. The use of forming companies into as many squads of inspection as it has sergeants and corporals, is proved by those regiments who have practised that method; as by it the irregularity of the soldiers is considerably restrained, their dress improved, and the discipline of the regiment in general most remarkably forwarded. Every officer should have a roll of his company by squads.

SQUALL, a sudden and violent blast of wind, usually occasioned by the interruption and reverberation of the wind from high mountains. These are very frequent in the Mediterranean, particularly that part of it which is known by the name of the *Livant*, as produced by the repulsion and new direction which the wind meets with in its passage between the various islands of the Archipelago.

SQUALUS, SHARK, in ichthyology; a genus arranged by Linnæus under the class of *amphibia*, and the order of *nantes*, but by Gmelin referred to the class of *pisces*, and order of *chondropterygii*. The head is obtuse; on the sides of the neck there are from 4 to 7 semilunar spiracles. The eyes are oblong, vertical, half covered, and before the *foramen temporale*. The mouth is situated in the anterior and lower part of the head, and is armed with several rows of teeth, which are serrated, acute, partly moveable and partly fixed, and unequal in form. The body is oblong, tapering and rough, with very tender prickles. The ventral fins are much less than the pectoral, and are situated round the anus and genitals. There are 32 species; the *isabella* canicula or greater dog fish; *catulus* or smaller dog fish; *stellaris*; *galeus* or tope; *multelus* or smooth hound; *cirratus*; *barbatus* or barbu; *tigrinus* or tigre; *Africanus* or *glonné*; *ocellatus* or *oeillé*; *zygæna* or *balance-fish*; *tibur* or *pantouffier* of Broussonet; *griseus* or *griset*; *vulpes* or *sea-fox*; *longicaudus*; *glaucus* or *blue shark*; *cornubius*, *porbeagle*, or *beatunian-shark*; *cinerens* or *perlon*; *maximus*; *careharius* or *white shark*; *pridlis* or *faie*; *spinolus* or *bouclé*; *acanthias* or *picked dog fish*; *fernandinus*; *spinax* or *lagre*; *squamulosus* or *ecailleux*; *centrina* or *humantim*; *indicus*; *Americanus* or *liche*; *squatina* or *angel fish*; *maffala*; and *kuad*. The following are the most remarkable:

1. The *isabella* has a wrinkly spotted skin, and the anterior dorsal fin is perpendicular to the abdominal fins. The body is somewhat flat; the head short, large, and obtuse.

Squalus.

obtuse. The teeth are disposed in six rows, compressed, short, and triangular, having a notch on each side of their bases. The eyes are sunk; the iris is of a copper colour, and the pupil is black and oblong. The fins of the back are almost square; the caudal fin is divided into two lobes, and the lateral line is parallel to the back. The upper part of the body is of a reddish ash-colour, with blackish spots disposed irregularly. The under part is of a dirty white hue. This species is found near New Zealand, and is about 2½ feet long.

2. *Canicula*, greater dog-fish, or spotted shark, is distinguished by large nostrils, which are covered by a lobe and worm-shaped flap, or by the position of the anal fin, which is at an equal distance from the anus and tail. The body is spotted; the head is small, with a short snout; the eyes are oblong; the iris whitish; the mouth is large and oblong, armed with three rows of teeth; the tongue is cartilaginous; the anus is before the middle of the body; the first dorsal fin is behind the ventral fins; the other, which is less, is almost opposite the anal fin; the caudal fin is narrow and marginated. This species is found in almost every sea, is about four feet long, extremely voracious, generally feeding on fishes, and is long lived. The skin, which is spotted like a leopard's, is used when dried for various purposes.

3. *Catulus*, smaller dog fish, has a large head; the pupil of the eyes is black; the iris white; the snout is of a bright hue; the mouth, which is large, is situated between the nostrils, and is armed with four rows of teeth, ferrated with three points bent inwards; those in the middle between the two mandibles are longer than the rest. The tongue is broad and smooth; the spiracles are five; the back is tapering and yellowish; the sides are somewhat compressed; the tail longer than the body, and the caudal fin is narrow and marginated; the anterior anal and dorsal fins are behind the ventral; the posterior dorsal fin is opposite to the anal. It inhabits the Mediterranean, Northern, and Indian Ocean, and is two or three feet long.

4. *Stellaris*, or greater cat fish. The head is marked with points; the abdominal fins are united and sharp at the apex; the dorsal fins extend almost to the tail; the skin is reddish, marked with black spots of different sizes, and is of a dirty ash colour below. It is from two to six feet long; resembles the *canicula*, but distinguished by larger and fewer spots, by a snout somewhat longer, a tail somewhat shorter, and nostrils almost shut. It brings forth 19 or 20 young at a time. It inhabits the European seas, living chiefly on shell fish, mollusca, and other small fishes. The dorsal fins are equal; the anterior one being behind the middle of the body, and the posterior one being a little behind the anal.

5. *Tigrinus*, or tigre, is about 15 feet long; the body is long, of unequal thickness, black, interspersed with white stripes and spots, irregularly and transversely.—The head is large; the mouth low and transverse, the upper jaw having two curls; the upper lip is thick and prominent; there are five spiracles on each side, the two last being united so as to give the appearance only of four; the mandibles are armed with very small pointed teeth; the tongue is short and thick; the eyes small and oblong; the pupil azure coloured; the iris black. The abdomen is broad; the pectoral fins are broad, and rounded at the extremity. The anterior dorsal is oppo-

sited to the ventral fins, and the posterior dorsal fin to the anal. The tail is compressed on both sides, and the fin which terminates it is hollow. The *tigrinus* is found in the Indian Ocean, and lives chiefly on shell fish. See Plate CCCCLXXXVI. fig. 1.

7. *Zygani*, *maricau*, or balance-fish, is frequently six feet long, and weighs 500 lbs. The head is elongated on each side; the fore part is bent back, and convex both above and below. At the extremities of the elongated part are the eyes, which are large, prominent, and directed downwards; the iris is of a golden colour; the mouth is arched, and near the beginning of the trunk. It has a horrible appearance from the teeth, which are arranged in three or four rows, and are broad, pointed, and ferrated on both sides. The tongue is thick, broad, and like a man's. The trunk is long and tapering; the fins are semicircular on the margin, and black at the basis; the ventral fins are separate; the anal and posterior dorsal fins are small; the anterior dorsal fin is large, and near the head; the caudal is long.—This species inhabits the Mediterranean Sea and the Indian Ocean. It is one of the most voracious of the whole tribe. See fig. 2.

8. *Vulpes*, or sea-fox, is most remarkable for the great length of its tail, the body being about seven feet and the tail six feet long. The head is short and conical; the eyes are large; the jaws are armed in a dreadful manner with three rows of triangular, compressed, and pointed teeth; the tongue is blunt; the lateral line is straight. The anterior dorsal fin is placed about the middle of the back; the posterior, which consists of two pointed lobes, is opposite to the anal fin; the ventral fins are very near one another; the anal is acuminate; the inferior lobe of the tail is about a foot long; the upper, which is shaped like a scythe, is five times longer. This species inhabits the Mediterranean, the coast of Scotland and England. It is covered with small scales; its back is ash coloured, belly whitish. It is extremely voracious. The ancients styled this fish *αλωπύξ*, and *vulpes*, from its supposed cunning. They believed, that when it had the misfortune to have taken a bait, it swallowed the hook till it got at the cord, which it bit off, and so escaped.

9. *Glaucus*, or blue shark, is about seven feet long. The colour of the back is a fine blue; the belly a silvery white; the head is flat; the eyes small and roundish; the teeth are almost triangular, elongated, and pointed, but not ferrated. The anus is very near the tail; the anterior dorsal fin is situated before the ventral fins, about the middle of the body, and is almost triangular; the posterior dorsal fin is equal to the anal fin, and is placed nearer the tail; the pectoral fins are large, long, and marginated; and the ventral are blue above and white below; the caudal is blue, divided into two lobes, of which the superior is much longer than the inferior lobe. This species is frequent in every sea, and is fierce, but not very destructive in our seas.

10. The *maximus*, basking shark, or the sun-fish of the Irish. This species has been long known to the inhabitants of the south and west of Ireland and Scotland, and those of Caernarvonshire and Anglesea; but having never been considered in any other than a commercial view, is described by no English writer except Mr Pennant; and, what is worse, mistaken for and confounded with the *luna* of Rondeletius, the same  
thas

*Squalus*. that our English writers call the sun-fish. The Irish and Welsh give it the same name, from its lying as if to sun itself on the surface of the water; and for the same reason Mr Pennant calls it the basking shark. It was long taken for a species of whale, till Mr Pennant pointed out the bronchial orifices on the sides, and the perpendicular site of the tail. These are migratory fish, or at least it is but in a certain number of years that they are seen in multitudes on the Welsh seas, though in most summers a single, and perhaps a strayed fish appears. They inhabit the northern seas, even as high as the arctic circle. They visited the bays of Caernarvonshire and Anglesea in vast shoals in the summers of 1756 and a few succeeding years, continuing there only the hot months; for they quitted the coast about Michaelmas, as if cold weather was disagreeable to them. Some old people say they recollect the same sort of fish visiting these seas in vast numbers about 40 years ago. They appear in the Frith of Clyde, and among the Hebrides, in the month of June, in small droves of seven or eight, but oftener in pairs. They continue in those seas till the latter end of July, when they disappear.

They have nothing of the fierce and voracious nature of the shark kind, and are so tame as to suffer themselves to be stroked; they generally lie motionless on the surface, commonly on their bellies, but sometimes, like tired swimmers, on their backs. Their food seems to consist entirely of sea plants, no remains of fish being ever discovered in the stomachs of numbers that were cut up, except some green stuff, the half digested parts of algæ, and the like. Linnæus says it feeds on medusæ.

At certain times, they are seen sporting on the waves, and leaping with vast agility several feet out of the water. They swim very deliberately, with the dorsal fins above water. Their length is from three to twelve yards, and sometimes even longer. Their form is rather slender, like others of the shark kind. The upper jaw is much longer than the lower, and blunt at the end. The tail is very large, and the upper part remarkably longer than the lower. The colour of the upper part of the body is a deep leaden; the belly white. The skin is rough like shagreen, but less so on the belly than the back. In the mouth, towards the throat, is a very short sort of whale-bone. The liver is of a great size, but that of the female is the largest; some weigh above 1000 pounds, and yield a great quantity of pure and sweet oil, fit for lamps, and also much used to cure bruises, burns, and rheumatic complaints. A large fish has afforded to the captors a profit of 20 l. They are viviparous; a young one about a foot in length being found in the belly of a fish of this kind. The measurements of one found dead on the shore of Loch Ranza in the isle of Arran were as follow: The whole length, 27 feet 4 inches; first dorsal fin, 3 feet; second, 1 foot; pectoral fin, 4 feet; ventral, 2 feet; the upper lobe of the tail, 5 feet; the lower, 3.

They will permit a boat to follow them, without accelerating their motion till it comes almost within contact when a harpioneer strikes his weapon into them, as near to the gills as possible. But they are often so insensible as not to move till the united strength of two men have forced in the harpoon deeper. As soon as

they perceive themselves wounded, they fling up their tail and plunge headlong to the bottom; and frequently coil the rope round them in their agonies, attempting to disengage the harpoon by rolling on the ground, for it is often found greatly bent. As soon as they discover that their efforts are in vain, they swim away with amazing rapidity, and with such violence, that there has been an instance of a vessel of 70 tons having been towed away against a fresh gale. They sometimes run off with 200 fathoms of line, and with two harpoons in them; and will employ the fishers for 12, and sometimes for 24 hours, before they are subdued. When killed, they are either hauled on shore, or, if at a distance from land, to the vessel's side. The liver (the only useful part), is taken out, and melted into oil in kettles provided for that purpose. A large fish will yield eight barrels of oil, and two of worthless sediment.

11. *Carcharias, requin*, or white shark, is often 30 feet long, and according to Gillius weighs 4000 pounds. The mouth of this fish is sometimes furnished with a six-fold row of teeth, flat, triangular, and exceedingly sharp at their edges, and finely ferrated. Mr Pennant had one rather more than an inch and a half long. Grew says, that those in the jaws of a shark two yards in length are not half an inch; so that the fish to which this tooth belonged must have been six yards long, provided the teeth and body keep pace in their growth.

This dreadful apparatus, when the fish is in a state of repose, lies quite flat in the mouth; but when he seizes his prey, he has power of erecting them by the help of a set of muscles that join them to the jaw. The mouth is placed far beneath; for which reason these, as well as the rest of the kind, are said to be obliged to turn on their backs to seize their prey; which is an observation as ancient as the days of Pliny. The eyes are large; the back broad, flat, and shorter than that of other sharks. The tail is of a semilunar form, but the upper part is longer than the lower. It has vast strength in the tail, and can strike with great force; so that the sailors instantly cut it off with an axe as soon as they draw one on board. The pectoral fins are very large, which enables it to swim with great swiftness. The colour of the whole body and fins is a light ash. The ancients were acquainted with this fish; and Oppian gives a long and entertaining account of its capture. Their flesh is sometimes eaten, but is esteemed coarse and rank.—They are the dread of the sailors in all hot climates, where they constantly attend the ships in expectation of what may drop over-board: a man that has that misfortune perishes without redemption; they have been seen to dart at him like gudgeons at a worm. A master of a Guinea ship informed Mr Pennant, that a rage of suicide prevailed among his new-bought slaves, from a notion the unhappy creatures had, that after death they should be restored again to their families, friends, and country. To convince them at least that they should not reanimate their bodies, he ordered one of their corpses to be tied by the heels to a rope and lowered into the sea; and though it was drawn up again as fast as the united force of the crew could be exerted, yet in that short space the sharks had devoured every part but the feet, which were secured at the end of the cord.

Swimmers very often perish by them; sometimes

Squalus.

they lose an arm or leg, and sometimes are bit quite asunder, serving but for two morsels for this ravenous animal: a melancholy tale of this kind is related in a West-India ballad, preserved in Dr Percy's Relics of ancient English Poetry.

This species inhabits the abyfs of the ocean, and only appears on the surface when allured by its prey. It is the most voracious of all animals, not even it is said sparing its own offspring, and often swallowing its prey entire. At the famous naval battle of the 12th of April 1782, when the Cæsar, one of the French ships of the line, was set on fire, the sailors threw themselves into the sea, Sir Charles Douglas observed great numbers of these sharks, which lay between the French and British fleets, instantly seize on the unhappy victims. He several times saw two of them disputing about their prey, each seizing a leg, and at length disappearing, dragging the body along with them. Notwithstanding the continued roar of artillery, he heard distinctly the cries of those unhappy men.

12. *Pristis, fœc*, or saw-fish, is sometimes 15 feet long, smooth, black on the upper parts, ash coloured on the sides, and white underneath. The head is flat and conical; the beak or snout projecting from the nose is about five feet long, covered with a coriaceous skin, and armed on each side, generally with 24 long, strong, and sharp-pointed teeth; but the number varies with age. The teeth are granulated; the eyes large, the iris of a golden colour, and the spiracles five. The anterior dorsal fin corresponds to those of the belly; the posterior is situated in the middle, between the former and apex of the tail; the pectoral fins are broad and long; the caudal is shorter than in the other species. It inhabits all the seas from Greenland to Brazil: and is found also in the Indian Ocean. It is harmless.

13. *Spinax, sagre*, or picked dog-fish, takes its name from a strong and sharp spine placed just before each of the back-fins, distinguishing it at once from the rest of the British sharks. The nose is long, and extends greatly beyond the mouth, but is blunt at the end. The teeth are disposed in two rows, are small and sharp, and bend from the middle of each jaw towards the corners of the mouth. The back is of a brownish ash-colour; the belly white.—It grows to the weight of about 20 pounds. This species swarms on the coasts of Scotland, where it is taken, split, and dried; and is a food among the common people. It forms a sort of inland commerce, being carried on womens backs 14 or 16 miles up the country, and sold or exchanged for necessaries.

14. *Squatina*, angel-fish, is from six to eight feet long, has a large head; teeth broad at their base, but slender and very sharp above, and disposed in five rows all round the jaws. Like those of all sharks, they are capable of being raised or depressed by means of muscles uniting them to the jaws, not being lodged in sockets as the teeth of cetaceous fish are. The back is of a pale ash-colour, and very rough; along the middle is a prickly tuberculated line: the belly is white and smooth. The pectoral fins are very large, and extend horizontally from the body to a great distance; they have some resemblance to wings, whence its name. The ventral fins are placed in the same manner, and the double penis is placed in them; which forms another character of the males in this genus.

Squalus.

This is the fish which connects the genus of rays and sharks, partaking something of the character of both; yet is an exception to each in the situation of the mouth, which is placed at the extremity of the head. It is a fish not unfrequent on most of our coasts, where it prowls about for prey like others of the kind. It is extremely voracious; and, like the ray, feeds on flounders and flat fish, which keep at the bottom of the water. It is extremely fierce, and dangerous to be approached. Mr Pennant mentions a fisherman whose leg was terribly torn by a large one of this species, which lay within his nets in shallow water, and which he went to lay hold of incautiously. The aspect of these, as well as the rest of the genus, have much malignity in them: their eyes are oblong, and placed lengthwise in their head, sunk in it, and overhung by the skin, and seem fuller of malevolence than fire. Their skin is very rough; the ancients made use of it to polish wood and ivory, as we do at present that of the greater dog-fish. The flesh is now but little esteemed on account of its coarseness and rankness; yet Arcestratus (as quoted by Athenæus, p. 319.), speaking of the fish of Miletus, gives this the first place, in respect to delicacy, of the whole cartilaginous tribe. They grow to a great size; being sometimes near an hundred weight.

Sharks are seldom destructive in the temperate regions; it is in the torrid zone that their ravages are most frequent. In the West Indies accidents happen from them almost every day.

"During the American war in 1780, while the Pallas frigate was lying in Kingston harbour, a young North American jumped overboard one evening to make his escape, and perished by a shark in a shocking manner.

Moseley or Tropical Dye sea.

"He had been captured in a small vessel, lost all his property, and was detained by compulsion in the English navy, to serve in a depredatory war against his country. But he, animated with that spirit which pervaded every bosom in America, resolved, as soon as he arrived at some port, to release himself from the mortifying state of employing his life against his country, which, as he said when dying, he was happy to lay down, as he could not employ it against her enemies.

"He plunged into the water; the Pallas was a quarter of a mile from the shore. A shark perceived him, and followed him, very quietly, till he came to a state of rest, near the shore: where, as he was hanging by a rope, that moored a vessel to a wharf, scarcely out of his depth, the shark seized his right leg, and stripped the flesh entirely away from the bones, and took the foot off at the ankle. He still kept his hold, and called to the people in the vessel near him, who were standing on the deck and saw the affair. The shark then seized his other leg, which the man by his struggling disengaged from his teeth, but with the flesh cut through down to the bone, into a multitude of narrow slips. The people in the vessel threw billets of wood into the water, and frightened the shark away. The young man was brought on shore. Dr Moseley was called to him; but he had lost so much blood before any assistance could be given him, that he expired before the mangled limbs could be taken off.

"A few weeks before this accident happened, a shark, of 12 feet in length, was caught in the harbour; and

on



*Squalus*. on being opened, the entire head of a man was found in his stomach. The scalp, and flesh of the face, were macerated to a soft pulpy substance; which, on being touched, separated entirely from the bones. The bones were somewhat softened, and the sutures loosened."

The following extraordinary instance of intrepidity and friendship is well worth recording. It is given on the authority of Mr Hughes, who published a natural history of Barbadoes. About the latter end of Queen Anne's wars, captain John Beanis, commander of the York Merchant, arrived at Barbadoes from England. Having disembarked the last part of his lading, which was coals, the sailors, who had been employed in that dirty work, ventured into the sea to wash themselves; there they had not been long before one on board espied a large shark making toward them, and gave them notice of their danger; upon which they swam back, and all reached the boat except one: him the monster overtook almost within reach of the oars, and gripping him by the small of his back, soon cut him asunder, and as soon swallowed the lower part of his body; the remaining part was taken up and carried on board, where a comrade of his was, whose friendship with the deceased had been long distinguished by a reciprocal discharge of all such endearing offices as implied an union and sympathy of souls. When he saw the severed trunk of his friend, it was with an horror and emotion too great for words to paint. During this affecting scene, the insatiate shark was seen traversing the bloody surface in search of the remainder of his prey; the rest of the crew thought themselves happy in being on board, he alone unhappy, that he was not within reach of the destroyer. Fired at the sight, and vowing that he would make the devourer disgorge, or be swallowed himself in the same grave, he plunges into the deep, armed with a sharp pointed knife. The shark no sooner saw him, but he made furiously toward him; both equally eager, the one of his prey, the other of revenge. The moment the shark opened his rapacious jaws, his adversary dexterously diving, and grasping him with his left hand somewhat below the upper fins, successfully employed his knife in his right hand, giving him repeated stabs in the belly; the enraged shark, after many unavailing efforts, finding himself overmatched in his own element, endeavoured to disengage himself, sometimes plunging to the bottom, then mad with pain, rearing his uncouth form, now stained with his own streaming blood, above the foaming waves. The crews of the surrounding vessels saw the unequal combat, uncertain from which of the combatants the streams of blood issued; till at length the shark, much weakened by the loss of blood, made toward the shore, and with him his conqueror; who, flushed with an assurance of victory, pushed his foe with redoubled ardour, and by the help of an ebbing tide, dragged him on shore, ripped up his bowels, and united and buried the severed carcase of his friend."

"It is evident (says Dr Musely, to whose valuable work we are indebted for the story of the American related above), that digestion in these animals is not performed by trituration, nor by the muscular action of the stomach; though nature has furnished them with a stomach of wonderful force and thickness, and far exceeding that of any other creature. Whatever their force of digestion is, it has no effect upon their young

ones, which always retreat into their stomachs in time of danger.

"That digestion is not performed by heat in fish, is equally evident. Being on the Banks of Newfoundland in August 1782. I opened many cod-fish, and ripped up their stomachs just as they came alive out of the water; in which were generally found small oysters, mussels, cockles, and crabs, as well as small fishes of their own and other species. The collages of the stomach of these fishes is far greater than the temperature of the water out of which they are taken; or of any other part of the fish, or of any other substance of animated nature I ever felt. On wrapping one of them round my hand, immediately on being taken out of the fish, it caused so much aching and numbness that I could not endure it long."

*SQUAMARIA*, in botany. See *LATHRÆA*.

*SQUAMOUS*, in anatomy, a name given to the spurious or false sutures of the skull, because composed of squamæ, or scales like those of fishes.

*SQUARE*, in geometry, a quadrilateral figure both equilateral and equiangular. See *GEOMETRY*.

*SQUARE-Root*. See *ALGEBRA*, Part I. Chap. iv. and *ARITHMETIC*, n° 33. and 34.

*Hollow SQUARE*, in the military art, a body of foot drawn up with an empty space in the middle, for the colours, drums, and baggage, faced and covered by the pikes every way, to keep off the horse.

*SQUARE*, among mechanics, an instrument consisting of two rules or branches, fastened perpendicularly at one end of their extremities, so as to form a right angle. It is of great use in the description and mensuration of right angles, and laying down perpendiculars.

*SQUARE-Rigged*, an epithet applied to a ship whose yards are very long. It is also used in contradistinction to all vessels whose sails are extended by stays or lateen-yards, or by booms and gaffs; the usual situation of which is nearly in the plane of the keel; and hence,

*SQUARE-Sail*, is a sail extended to a yard which hangs parallel to the horizon, as distinguished from the other sails which are extended by booms and stays placed obliquely. This sail is only used in fair winds, or to stand under in a tempest. In the former case, it is furnished with a large additional part called the *bonnet*, which is then attached to its bottom, and removed when it is necessary to scud. See *SCUDDING*.

*SQUANTINA*. See *SQUALUS*.

*SQUILL*, in botany. See *SCILLA*.

*SQUILLA*, the name of a species of cancer. See *CANCER*.

*SQUINTING*. See *MEDICINE*, n° 383.

*SQUIRREL*, in zoology. See *SCIURUS*.

*STABBING*, in law. The offence of mortally stabbing another, though done upon sudden provocation, is punished as murder; the benefit of clergy being taken away from it by statute. (See *MURDER*). For by Ja. I. c. 8. when one thrusts or stabs another, not then having a weapon drawn, or who hath not then first stricken the party stabbing, so that he dies thereof within six months after, the offender shall not have the benefit of clergy, though he did it not of malice aforethought. This statute was made on account of the frequent quarrels and stabbings with short daggers between the Scotch and the English, at the accession

*Squamaria*  
||  
*Stabbing*.

Stachys.

cession of James I.; and being therefore of a temporary nature, ought to have expired with the mischief which it meant to remedy. For, in point of solid and substantial justice, it cannot be said that the mode of killing, whether by stabbing, strangling, or shooting, can either extenuate or enhance the guilt; unless where, as in the case of poisoning, it carries with it internal evidence of cool and deliberate malice. But the benignity of the law hath construed the statute so favourably in behalf of the subject, and so strictly against him, that the offence of stabbing now stands almost upon the same footing as it did at the common law. Thus, (not to repeat the cases mentioned under MANSLAUGHTER, of stabbing an adulterers, &c. which are barely manslaughter, as at common law), in the construction of this statute it hath been doubted, whether, if the deceased had struck at all before the mortal blow given, this does not take it out of the statute, tho' in the preceding quarrel the stabber had given the first blow; and it seems to be the better opinion, that this is not within the statute. Also it hath been resolved, that the killing a man, by throwing a hammer or other weapon, is not within the statute; and whether a shot with a pistol be so or not is doubted. But if the party slain had a cudgel in his hand, or had thrown a pot or a bottle, or discharged a pistol at the party stabbing, this is a sufficient reason for having a weapon drawn on his side within the words of the statute.

STACHYS, in botany: A genus of plants belonging to the class of *ditynamia*, and order of *gymnospermia*; and in the natural system arranged under the 42d order, *Verticillata*. The upper lip of the corolla is arched; the lower lip reflexed, and the larger intermediate lacinia is marginated. The stamina, after shedding the farina, are bent towards the sides. There are 17 species, the *sylvatica*, *palustris*, *alpina*, *germanica*, *lanata*, *cretica*, *glutinosa*, *orientalis*, *palæstina*, *maritima*, *æthiopica*, *hirta*, *canariensis*, *recta*, *annua*, and *arvensis*. Four only are natives of Britain.

1. *Sylvatica*, hedge-nettle. The plant is hairy all over, erect, a yard high, and branched; the hairs are jointed. The flowers are of a deep red colour, six or eight in a whirl, which terminates in a long spike destitute of leaves. The leaves are heart-shaped, and grow on footstalks. The whole plant has a strong fetid smell. It grows commonly in woods and shady places, and flowers in July or August. 2. *Palustris*, clown's all-heal. The roots are white and tuberous. The stalk is branched at the bottom, and two or three feet high. The flowers are red or purple, from six to ten in a whirl, ending in a long spike. The leaves are sessile, narrow, pointed, and in part surrounding the stem. This plant has a fetid smell and bitter taste, and is reckoned a good vulnerary. It grows on the sides of rivers and lakes, in low moist grounds, and sometimes in corn-fields. 3. *Germanica*, base hore-hound. The stem is downy, and about two feet high. The leaves are white, downy, wrinkled, and indented. The flowers are white, purplish within, and grow in multiflorous whirls. It grows in England. 4. *Arvensis*, corn-itachys, petty ironwort, or all-heal. The stalk is 10 or 12 inches high, square, branched, and hairy. The leaves are heart-shaped, obtuse, bluntly serrated, and less hairy. The calyx is hairy and sessile, and deeply divided into five acute dents of equal length. The flowers are flesh-coloured,

and grow from three to six in a whirl. The lower lip is trifid; the middle segment spotted with red, but not emarginated according to the character of the genus. It is frequent in corn-fields, and grows from June to August.

STADIUM, an ancient Greek long measure, containing 125 geometrical paces, or 625 Roman feet, corresponding to our furlong. The word is said to be formed from the Greek word *στασις* "a station," or *σταδίου* "to stand," because it is reported that Hercules having run a stadium at one breath, stood still at the end of it. The Greeks usually measured distances by stadia, which they called *σταδίων*. Stadium also signified the course on which their races were run.

STADTHOLDER, the principal magistrate or governor of the Seven United Provinces. This office is now abolished by the republican influence of France; but as the prince of Orange is in alliance with this country, our readers will probably not be ill pleased with a short account of his several powers and claims. To render that account the more intelligible, we shall trace the office of Stadtholder from its origin.

The Seven Provinces of the Low Countries were long governed by princes invested with the sovereignty, though limited in their powers, and under various titles; as *Counts of Holland*, *Dukes of Guelder*, *Bishop of Utrecht*, &c. When these countries fell to the princes of the house of Burgundy, and afterwards to those of Austria, who had many other dominions, the absence of the sovereign was supplied by a stadtholder or governor, vested with very ample powers. These stadtholders or lieutenants had the administration of the government, and presided in the courts of justice, whose jurisdiction was not at that time confined merely to the trial of causes, but extended to affairs of state. The stadtholders swore allegiance to the princes at their inauguration, jointly with the states of the provinces they governed. They likewise took an oath to the states, by which they promised to maintain their fundamental laws and privileges.

It was upon this footing that William the First, prince of Orange, was made governor and lieutenant-general of Holland, Zealand, and Utrecht, by Philip the Second, upon his leaving the Low Countries to go into Spain. The troubles beginning soon after, this prince found means to bring about an union, in 1576, between Holland and Zealand; the states of which two provinces put into his hands, as far as was in their power, the sovereign authority (for so long time as they should remain in war and under arms), upon the same footing as Holland had intrusted him with in the year before. In 1581 the same authority was again renewed to him by Holland, as it was soon after by Zealand likewise; and in 1584, being already elected count of Holland, upon certain conditions he would have been formally invested with the sovereignty, had not a wretch, hired and employed by the court of Spain, put an end to his life by a horrid assassination.

In the preamble of the instruments by which the states in 1581 conferred the sovereign authority upon prince William the First, we find these remarkable words, which are there set down as fundamental rules: "That all republics and communities ought to preserve, maintain, and fortify themselves by unanimity; which being impossible to be kept up always among so many

Blackf.  
Comment.  
vol. iv.  
p. 193.

Stadium  
Stadtholder.

Stadtholder-  
cr. many members, often differing in inclinations and sentiments, it is consequently necessary that the government should be placed in the hands of one single chief magistrate." Many good politicians, and the greatest part of the inhabitants of these provinces, have, since the establishment of the republic, looked upon the stadtholderian government as an essential part of her constitution; nor has she been without a stadtholder but twice, that is to say, from the end of 1650 to 1672, and again from March 1702 till April 1747. The provinces of Friesland and Groningen, with Ommelands, have always had a stadtholder without interruption: their instructions, which are now no longer in force, may be seen in Aitzema; but formerly the powers of the stadtholder of these provinces were confined within narrower bounds, and till William the Fourth there was no stadtholder of the seven provinces together.

The stadtholder cannot declare war nor make peace, but he has, in quality of captain-general of the union, the command in chief of all the forces of the state (A); and military persons are obliged to obey him in every thing that concerns the service. He is not limited by instructions, but he has the important power of giving out orders for the march of troops, and the disposition of all matters relative to them. He not only directs their marches, but provides for the garrisons, and changes them at pleasure. All military edicts and regulations come from him alone; he constitutes and authorizes the high council of war of the United Provinces, and, as captain-general of every province, disposes of all military offices, as far as the rank of colonel inclusively. The higher posts, such as those of velt-marshals, generals, lieutenant-generals, major-generals, are given by the states-general, who choose the persons recommended by his highness. He makes the governors, commandants, &c. of towns and strong places of the republic, and of the barrier. The persons nominated present their instruments of appointment to their high mightinesses, who provide them with commissions. The states-general have likewise great regard to the recommendation of the prince stadtholder in the disposition of those civil employments which are in their gift.

The power of the stadtholder as high-admiral, extends to every thing that concerns the naval force of the republic, and to all the other affairs that are here within the jurisdiction of the admiralty. He presides at these boards either in person or by his representatives; and as chief of them all in general, and of every one in particular, he has power to make their orders and instructions be observed by themselves and others. He bestows the posts of lieutenant-admiral, vice-admiral, and rear-admiral, who command under him; and he makes likewise post-captains.

The stadtholder grants likewise letters of grace, pardon, and abolition, as well for the crime called *Communia Delicta*, as for military offences. In Holland and Zealand these letters are made out for crimes of the first

Stadtholder-  
cr. fort, in the name of the states, with the advice of his highness. In military offences he consults the high council of war, and upon the *communia delicta* he takes the advice of the courts of justice, of the counsellors, committees of the provinces, of the council of state, and the tribunals of justice in the respective towns, according to the nature of the case.

In the provinces of Holland and Zealand, the stadtholder elects the magistrates of the towns annually, out of a double number that are returned to him by the towns themselves.

When any of those offices become vacant, which, at the time there was no governor, were in the disposal of the states of Holland, or as formerly in that of the chamber of accounts, the stadtholder has his choice of two, or, in some cases, of three candidates, named by their noble and great mightinesses. He chooses likewise the counsellors, inspectors of the dykes of Rynland, Delfland, and Scheeland, out of three persons presented to him by the boards of the counsellors inspectors; which boards are of very ancient establishment in Holland.

His highness presides in the courts of Holland, and in the courts of justice of the other provinces; and his name is placed at the head of the proclamations and acts, called in Dutch *Mandamenten*, or *Provisien van Justitie*. In Overijssel and in the province of Utrecht the possessors of fiefs hold of the prince stadtholder. He is supreme curator of the universities of Guelder, Friesland, and Groningen; grand forester and grand veneur in Guelder, in Holland, and other places. In the province of Utrecht, his highness, by virtue of the regulation of 1674, disposes of the provostships and other benefices which remain to the chapters, as also of the canonical pretends that fall in the months which were formerly the papal months.

By the first article of the council of state of the United Provinces, the stadtholder is the first member of it, and has a right of voting there, with an appointment of 25,000 guilders a-year. He assists also as often as he thinks it for the service of the state, at the deliberations of the states-general, to make propositions to them, and sometimes also at the conferences which the deputies of their high mightinesses hold in their different committees, in consequence of their standing orders. He likewise assists at the assemblies of the states of each particular province, and at that of the counsellors committees. In Guelder, Holland, and Utrecht, his highness has a share of the sovereignty, as chief or president of the body of nobles; and in Zealand, where he possesses the marquise of Veer and Flushing, as first noble, and representing the whole nobility. In his absence he has in Zealand his representatives, who have the first place and the first voice in all the councils, and the first of whom is always first deputy from the province to the assembly of their high mightinesses.

In 1749 the prince stadtholder was created by the states-

(A) In times of war, however, the states have always named deputies for the army, to accompany the stadtholders in the field, and to serve them as counsellors in all their enterprises, particularly in the most important affairs, such as giving battle, or undertaking a siege, &c. This was always practised till the accession of king William the Third to the crown of Great Britain, and after his death was continued with regard to the general in chief of the army of the republic. In 1747 and 1748 there were likewise deputies with the army, but with more limited power.

Stalhelina  
||  
Staff.

States-general, governor-general and supreme director of the East and West India companies; dignities which give him a great deal of authority and power, and which had never been conferred upon any of his predecessors, nor have they hitherto been made hereditary. He has his representatives in the several chambers of the company, and chooses their directors out of a nomination of three qualified persons. The prince enjoyed this prerogative in Zealand from the time of his elevation to the stadtholderate.

The revenues of the stadtholderate of the seven United Provinces are reckoned (including the 25,000 guilders which the prince enjoys annually as the first member of the council of state, and what he has from the India company's dividends) to amount to 300,000 guilders a year. As captain-general of the union, his serene highness has 120,000 guilders *per annum*, besides 24,000 from Friesland, and 12,000 from Groningen, in quality of captain-general of those provinces. In times of war the state allows extraordinary sums to the captain-general for the expence of every campaign.

To all these powers and privileges the prince of Orange has a legal and constitutional right; but he has been divested of them by a faction which seems determined to sell to the cruel and arbitrary republic of France that country which his ancestors redeemed from Austrian slavery, at the hazard of losing every thing dear to them but liberty and honour.

**STÄHELINA**, in botany: A genus of plants belonging to the class of *Synœnesia*, and order of *polygamia æqualis*; and in the natural system arranged under the 49th order, *Compositæ*. The receptacle is paleaceous, the chaff being very short; the pappus is branchy, and the antheræ caudated. There are eight species, the gnaphaloides, dubia, arborescens, fruticosa, ilicifolia, corymbosa, chamæpeuce, and imbricata.

**STAFF**, an instrument ordinarily used to rest on in walking. The staff is also frequently used as a kind of natural weapon both of offence and defence; and for several other purposes.

**STAFF**, a light pole erected in different parts of a ship, whercon to hoist and display the colours.

The principal of these is reared immediately over the stern, to display the ensign; another is fixed on the bowsprit, to extend the jack; three more are erected at the three mast heads, or formed by their upper ends, to show the flag or pendant of the respective squadron or division to which the ship is appropriated. See **ENSIGN**, **MAST**, **JACK**, and **PENDANT**.

**STAFF**, in military matters, consists of a quartermaster-general, adjutant general, and majors of brigade. The staff properly exists only in time of war. See *Quartier-Maître General*. &c.

**Regimental STAFF**, consists in the adjutant, quartermaster, chaplain, surgeon, &c.

**STAFF**, in music, five lines, on which, with the intermediate spaces, the notes of a song or piece of music are marked.

**FORE-STAFF**. See *Fore-Staff*.

**STAFFA**, one of the Hebrides or Western Islands of Scotland, remarkable for its basaltic pillars. It was visited by Sir Joseph Banks, who communicated the following account of it to Mr Pennant.

“The little island of Staffa lies on the west coast of

Mull, about three leagues north-east from Iona, or I-columbkil: its greatest length is about an English mile, and its breadth about half a one. On the west side of the island is a small bay where boats generally land; a little to the southward of which the first appearance of pillars are to be observed: they are small; and instead of being placed upright, lie down on their sides, each forming a segment of a circle. From thence you pass a small cave, above which the pillars, now grown a little larger, are inclining in all directions: in one place in particular, a small mass of them very much resembles the ribs of a ship. From hence having passed the cave, which, if it is not low-water, you must do in a boat, you come to the first ranges of pillars, which are still not above half as large as those a little beyond. Over against this place is a small island, called in Erse *Boo-sha-la*, separated from the main by a channel not many fathoms wide. This whole island is composed of pillars without any stratum above them; they are still small, but by much the neatest formed of any about the place.

“The first division of the island, for at high water it is divided into two, makes a kind of a cone, the pillars converging together towards the centre: on the other they are in general laid down flat: and in the front next to the main, you see how beautifully they are packed together, their ends coming out square with the bank which they form. All these have their transverse sections exact, and their surfaces smooth; which is by no means the case with the large ones, which are cracked in all directions. I much question, however, if any part of this whole island of Boo-sha-la is two feet in diameter.

“The main island opposite to Boo-sha-la, and farther towards the north-west, is supported by ranges of pillars pretty erect, and, though not tall (as they are not uncovered to the base), of large diameters; and at their feet is an irregular pavement, made by the upper sides of such as have been broken off, which extends as far under water as the eye can reach. Here the forms of the pillars are apparent: these are of three, four, five, six, and seven sides; but the number of five and six are by much the most prevalent. The largest I measured was of seven; it was four feet five inches in diameter.

“The surfaces of these large pillars, in general, are rough and uneven, full of cracks in all directions; the transverse figures in the upright ones never fail to run in their true directions. The surfaces upon which we walked were often flat, having neither concavity nor convexity; the larger number, however, were concave, though some were very evidently convex. In some places, the interstices within the perpendicular figures were filled up with a yellow spar: in one place, a vein passed in among the mass of pillars, carrying here and there small threads of spar. Though they were broken and cracked through in all directions, yet their perpendicular figures might easily be traced: from whence it is easy to infer, that whatever the accident might have been that caused the dislocation, it happened after the formation of the pillars.

“From hence proceeding along shore, you arrive at Fingal's cave. Its dimensions I have given in the form of a table:

Staffa.	Feet.	In.
Length of the cave from the rock without,	371	6
From the pitch of the arch,	250	0
Breadth of ditto at the mouth,	53	7
At the farther end,	20	0
Height of the arch at the mouth,	117	6
At the end,	70	0
Height of an outside pillar,	39	6
Of one at the north-west corner,	54	0
Depth of water at the mouth,	18	0
At the bottom,	9	0

Stratum above the pillar	-	-	61	6	Staffa
" N <sup>o</sup> 4. Another pillar to the westward.	-	-	-	-	
Stratum below the pillar,	-	-	17	1	Staffa l-
Height of the pillar,	-	-	50	0	stair.
Stratum above,	-	-	51	1	
" N <sup>o</sup> 5. Another pillar farther to the westward.	-	-	-	-	
Stratum below the pillar,	-	-	19	8	
Height of the pillar,	-	-	55	1	
Stratum above,	-	-	54	7	

" The cave runs into the rock in the direction of north east by east by the compass.

" Proceeding farther to the north-west, you meet with the highest ranges of pillars; the magnificent appearance of which is past all description. Here they are bare to their very bases, and the stratum below them is also visible: in a short time, it rises many feet above the water, and gives an opportunity of examining its quality. Its surface is rough, and has often large lumps of stone sticking in it as if half immersed: itself, when broken, is composed of a thousand heterogeneous parts, which together have very much the appearance of a lava: and the more so, as many of the lumps appear to be of the very same stone of which the pillars are formed. This whole stratum lies in an inclined position, dipping gradually towards the south-east. As hereabouts is the situation of the highest pillars, I shall mention my measurements of them, and the different strata in this place, premising, that the measurements were made with a line, held in the hand of a person who stood at the top of the cliff, and reaching to the bottom; to the lower end of which was tied a white mark, which was observed by one who stood below for the purpose: when this mark was set off from the water, the person below noted it down, and made signal to him above, who made then a mark in his rope: whenever this mark passed a notable place, the same signal was made, and the name of the place noted down as before: the line being all hauled up, and the distances between the marks measured and noted down, gave, when compared with the book kept below, the distances, as for instance in the cave:

" N<sup>o</sup> 1. in the book below, was called from the water to the foot of the first pillar in the book above; n<sup>o</sup> 1. gave 36 feet 8 inches, the highest of that ascent, which was composed of broken pillars.

" N<sup>o</sup> 1. Pillar at the west corner of Fingal's cave.

	Feet.	In.
1 From the water to the foot of the pillar,	12	0
2 Height of the pillar,	37	3
3 Stratum above the pillar,	66	9

" N<sup>o</sup> 2. Fingal's cave.

1 From the water to the foot of the pillar,	36	8
2 Height of the pillar,	39	6
3 From the top of the pillar to the top of the arch,	31	4

4 Thickness of the stratum above, 34 4  
By adding together the three first measurements, we got the height of the arch from the water, 117 6

" N<sup>o</sup> 3 Corner pillar to the westward of Fingal's cave.

Stratum below the pillar of lava-like matter,	11	0
Length of pillar,	54	0

VOL. XVII. Part II.

" The stratum above the pillars, which is here mentioned, is uniformly the same, consisting of numberless small pillars, bending and inclining in all directions, sometimes so irregularly that the stones can only be said to have an inclination to assume a columnar form; in others more regular, but never breaking into or disturbing the stratum of large pillars, whose tops everywhere keep an uniform and regular line.

" Proceeding now along the shore round the north end of the island, you arrive at *Oua na fearve*, or the Corvorant's Cave. Here the stratum under the pillars is lifted up very high; the pillars above it are considerably less than those at the north-west end of the island, but still very considerable. Beyond is a bay, which cuts deep into the island, rendering it in that place not more than a quarter of a mile over. On the sides of this bay, especially beyond a little valley, which almost cuts the island into two, are two stages of pillars, but small; however, having a stratum between them exactly the same as that above them, formed of innumerable little pillars, shaken out of their places, and leaning in all directions.

" Having passed this bay, the pillars totally cease; the rock is of a dark brown stone, and no signs of regularity occur till you have passed round the south-east end of the island (a space almost as large as that occupied by the pillars), which you meet again on the west side, beginning to form themselves irregularly, as if the stratum had an inclination to that form, and soon arrive at the bending pillars where I began.

" The stone of which the pillars are formed, is a coarse kind of basalt, very much resembling the Giant's Causeway in Ireland, though none of them are near so neat as the specimens of the latter which I have seen at the British Museum; owing chiefly to the colour, which in ours is a dirty brown, in the Irish a fine black; indeed the whole production seems very much to resemble the Giant's Causeway."

STAFFORD, the county town of Staffordshire, in W. Long. 2. 0. N. Lat. 53. 0. It stands on the river Sow, has two parish-churches, a fine square market-place, and a flourishing cloth manufacture. It sends two members to parliament, and is 135 miles from London.

STAFFORDSHIRE, a county of England, bounded on the south by Worcestershire, by Cheshire and Derbyshire on the north, by Warwickshire and Derbyshire on the east, and Shropshire and Cheshire on the west. The length is reckoned 62 miles, the breadth 33, and the circumference 180. It contains 5 hundreds, 150 parishes, 810,000 acres, and 18 market towns. The air, except in those parts that are called the Moorlands and Woodlands, and about the mines, is good, especially upon the hills, where it is accounted

Stafford-  
shire  
||  
Stage.

very fine. The soil in the northern mountainous parts is not fertile; but in the middle, where it is watered by the Trent, the third river in England, it is both fruitful and pleasant, being a mixture of arable and meadow grounds. In the south, it abounds not only with corn, but with mines of iron and pits of coal. The principal rivers of this county, besides the Trent, which runs almost thro' the middle of it, and abounds with salmon, are the Dove and Tame, both of which are well stored with fish. In this county are also a great many lakes, or meres and pools, as they are called; which, having streams either running into them or from them, cannot be supposed to be of any great prejudice to the air; they yield plenty of fish. In divers parts of the county are medicinal waters, impregnated with different sorts of minerals, and consequently of different qualities and virtues; as those at Hints and Brefsord-house, which are mixed with bitumen; those at Ingestre, Codfaldwood, and Willough-bridge park, which are sulphureous. Of the saline kind are the Brine-pits at Chertley, Epsom, Penfact-clofe, of which very good salt is made. There is a well at Newcastle-under-Line that is said to cure the king's evil; another called *Elderwell* near Blemhill, said to be good for sore eyes; and a third called the *Spz*, near Wolverhampton.

Great flocks of sheep are bred in this county, especially in the moorlands, or mountains of the northern part of it; but the wool is said to be somewhat coarser than that of many other counties. Of this wool, however, they make a variety of manufactures, particularly felts. In the low grounds along the rivers are rich pastures for black cattle; and vast quantities of butter and cheese are made. In the middle and southern parts not only grain of all kinds, but a great deal of hemp and flax are raised. This county produces also lead, copper, iron; marble, alabaster, millstones, limestone; coal, salt, and marles of several sorts and colours; brick-earth, fullers earth, and potters clay, particularly a sort used in the glass-manufacture at Amblecot, and sold at seven-pence a bushel; tobacco pipe-clay; a sort of reddish earth called *slip*, used in painting divers vessels; red and yellow ochres; fire-stones for hearths of iron furnaces, ovens, &c.; iron-stones of several sorts; blood-stones, or hæmatites, found in the brook Tent, which, when wet a little, will draw red lines like ruddle; quarry-stones, and grind-stones. For fuel the county is well supplied with turf, peat, and coal of several sorts, as cannel-coal, peacock-coal, and pit-coal. The peacock-coal is so called, because, when turned to the light, it displays all the colours of the peacock's tail; but it is fitter for the forge than the kitchen. Of the pit-coal there is an inexhaustible store: it burns into white ashes, and leaves no such cinder as that of the Newcastle coal. It is not used for malting till it is charred, and in that state it makes admirable winter-fuel for a chamber.

This county is in the diocese of Litchfield and Coventry, and the Oxford circuit. It sends ten members to parliament; namely, two for the county, two for the city of Litchfield, two for Stafford, two for Newcastle-under-Line, and two for Tamworth.

STAG, in zoology. See CERVUS.

STAG-Beetle. See LUCANUS.

STAGE, in the modern drama, the place of action and representation included between the pit and the

scenes, and answering to the proscenium or pulpitum of the ancients. See PLAYHOUSE and THEATRE.

STAGGERS. See FARRIERY, § xiii.

STAHL (George Ernest), an eminent German chemist, was born in Franconia in 1660, and chosen professor of medicine at Hall, when a university was founded in that city in 1694. The excellency of his lectures while he filled that chair, the importance of his various publications, and his extensive practice, soon raised his reputation to a very great height. He received an invitation to Berlin in 1716, which having accepted, he was made counsellor of state and physician to the king. He died in 1734, in the 75th year of his age. Stahl is without doubt one of the greatest men of which the annals of medicine can boast: his name marks the commencement of a new and more illustrious era in chemistry. He was the author of the doctrine of phlogiston, which, though now completely overturned by the discoveries of Lavoisier and others, was not without its use; as it served to combine the scattered fragments of former chemists into a system, and as it gave rise to more accurate experiments and a more scientific view of the subject, to which many of the subsequent discoveries were owing. This theory maintained its ground for more than half a century, and was received and supported by some of the most eminent men which Europe has produced; a sufficient proof of the ingenuity and the abilities of its author. He was the author also of A Theory of Medicine, founded upon the notions which he entertained of the absolute dominion of mind over body; in consequence of which, he affirmed, that every muscular action is a voluntary act of the mind, whether attended with consciousness or not. This theory he and his followers carried a great deal too far, but the advices at least which he gives to attend to the state of the mind of the patient are worthy of the attention of physicians.

His principal works are, 1. *Experimenta et Observationes Chemicæ et Physicæ*, Berlin, 1731, 8vo. 2. *Dissertationes Medicæ*, Hall, 2 vols 4to. This is a collection of theses. 3. *Theoria Medica vera*, 1737, 4to. 4. *Opusculum Chymico-physico-medicum*, 1740, 4to. 5. A Treatise on Sulphur, both Inflammable and Fixed, written in German. 6. *Negotium Otiosum*, Hall, 1720, 4to. It is in this treatise chiefly that he establishes his system concerning the action of the soul upon the body. 7. *Fundamenta Chymicæ Dogmaticæ et Experimentalis*, Nuremberg, 1747, 3 vols 4to. 8. A Treatise on Salts, written in German. 9. *Commentarium in Metallurgiam Beccheri*, 1723.

STAINING or COLOURING of BONE, HORN, MARBLE, PAPER, WOOD, &c. See these articles.

STAIRCASE, in architecture, an ascent inclosed between walls, or a balustrade consisting of stairs or steps, with landing places and rails, serving to make a communication between the several stories of a house. See ARCHITECTURE, n° 89, &c.

STALACTITÆ, in natural history, crystalline spars formed into oblong, conical, round, or irregular bodies, composed of various crusts, and usually found hanging in form of icicles from the roofs of grottoes, &c.

STALAGMITIS, in botany: A genus of the monacia order, belonging to the polygamia class of plants; and in the natural method ranking under the 38th order, *Tricocca*. The calyx is either quadriphyllous or hexaphyllum

Stagger  
||  
Stalagm ti

§ See  
STONE.  
Worc.

Stale  
||  
Stamina.

hexaphyllous; the corolla consists of four or of six petals: the receptacle is fleshy, and somewhat square-shaped; the filaments about 30. In the hermaphrodite flower the *stylus* is short, thick, and erect; the fruit is a berry of a globular shape, unilocular, and crowned with the *stylus* and *stigma*: they contain three oblong jointed triangular seeds. Of this there is only one species, viz. the *Cambogioides*, a native of the East Indies and of the warmer parts of America. From this plant is obtained the gutta cambogia, or gum gamboge of the shops. See **GAMBOGE**.

Till very lately botanists were at a loss for the true nature of the plant which yields this gum. Koenig, a native of Ireland, and an excellent botanist, travelled over a great part of India, and collected a great number of new plants, and among the rest the stalagmitis. These he bequeathed to Sir Joseph Banks president of the Royal Society.

**STALE**, among sportsmen, a living fowl put in a place to allure and bring others where they may be taken. For want of these, a bird shot, his entrails taken out, and dried in an oven in his feathers, with a stick thrust through to keep it in a convenient posture, may serve as well as a live one.

**STALE** is also a name for the urine of cattle.

**ANIMATED STALK**. This remarkable animal was found by Mr Ives at Cuddalore: and he mentions several kinds of it; some appearing like dry straws tied together, others like grass; some have bodies much larger than others, with the addition of two scaly imperfect wings; their neck is no bigger than a pin, but twice as long as their bodies; their heads are like those of an hare and their eyes vertical and very brisk. They live upon flies, and catch these insects very dexterously with the two fore-feet, which they keep doubled up in three parts close to their head, and dart out very quick on the approach of their prey; and when they have caught it, they eat it very voraciously, holding it in the same manner as a squirrel does its food. On the outer joints of the fore-feet are several very sharp books for the easier catching and holding of their prey; while, with the other feet, which are four in number, they take hold of trees or any other thing, the better to surprise whatever they lie in wait for. They drink like a horse, putting their mouths into the water. Their excrements, which are very white, are almost as large as the body of the animal, and as the natives say, dangerous to the eyes.

**S'ALLION**, or **STONE-HORSE**, in the manege, an horse designed for the covering of mares, in order to propagate the species. See **EQUUS**.

**STAMFORD**, an ancient town of Lincolnshire in England; seated on the river Welland, on the edge of Northamptonshire. It is a large handsome place, containing six parish-churches, several good streets, and fine buildings. It had formerly a college, the students of which removed to Brazen-Nose college in Oxford. It has no considerable manufactories, but deals chiefly in malt. W. Long. o. 31. N. Lat. 52. 42.

**STAMINA**, in botany, are those upright filaments which, on opening a flower, we find within the corolla surrounding the pistillum. According to Linnæus, they are the male organs of generation, whose office it is to prepare the pollen. Each stamen consists of two distinct parts, viz. the **FILAMENTUM** and the **ANTHERA**.

**STAMINA**, in the animal body, are defined to be these simple original parts which existed first in the embryo or even in the seed; and by whose distinction, augmentation, and accretion by additional juices, the animal body at its utmost bulk is supposed to be formed.

**STAMP-DUTIES**, a branch of the perpetual revenue. See **REVENUE**.

In Great Britain there is a tax imposed upon all parchment and paper, whereon any legal proceedings or private instruments of almost any nature whatsoever are written; and also upon licences for retailing wines, of all denominations; upon all almanacs, newspapers, advertisements, cards, dice, &c. These imposts are very various; being higher or lower, not so much according to the value of the property transferred, as according to the nature of the deed. The highest do not exceed six pounds upon every sheet of paper or skin of parch-<sup>Smith's</sup> ment; and these high duties fall chiefly upon grants <sup>Wealth of</sup> from the crown, and upon certain law proceedings, <sup>Nations,</sup> without any regard to the value of the subject. <sup>vol. iii.</sup> There are in Great Britain no duties on the registration of deeds or writings, except the fees of the officers who keep the register; and these are seldom more than a reasonable recompense for their labour. The crown derives no revenue from them.

The stamp-duties constitute a tax which, though in some instances it may be heavily felt, by greatly increasing the expence of all mercantile as well as legal proceedings, yet (if moderately imposed) is of service to the public in general, by authenticating instruments, and rendering it much more difficult than formerly to forge deeds of any standing; since, as the officers of this branch of the revenue vary their stamps frequently, by marks perceptible to none but themselves, a man that would forge a deed of King William's time, must know and be able to counterfeit the stamp of that date also. In France and some other countries the duty is laid on the contract itself, not on the instrument in which it is contained; as, with us too in England (besides the stamps on the indentures), a tax is laid, by statute 8 Ann. c. 9. on every apprentice-fee; of 6 d. in the pound if it be 50 l. or under, and 1 s. in the pound if a greater sum: but this tends to draw the subject into a thousand nice disquisitions and disputes concerning the nature of his contract, and whether taxable or not; in which the farmers of the revenue are sure to have the advantage. Our general method answers the purposes of the state as well, and consults the ease of the subject much better. The first institution of the stamp-duties was by statute 5 and 6 W. and M. c. 2. and they have since, in many instances, been increased to five times their original amount.

**STANCHION**, or **STANCHIONS**, a sort of small pillars of wood or iron used for various purposes in a ship; as to support the decks, the quarter-rails, the nettings, the awnings, &c. The first of these are two ranges of small columns fixed under the beams, throughout the ship's length between decks; one range being on the starboard and the other on the larboard side of the hatchways. They are chiefly intended to support the weight of the artillery.

**STAND**, in commerce, a weight from two hundred and an half to three hundred of pitch.

**STANDARD**, in war, a sort of banner or flag, borne

See Stan-  
Stanhope. borge as a signal for the joining together of the several troops belonging to the same body.

STANDARD, in commerce, the original of a weight, measure, or coin, committed to the keeping of a magistrate, or deposited in some public place, to regulate, adjust, and try the weights used by particular persons in traffic. See MONEY.

STANHOPE (Philip Dormer, earl of Chesterfield), was born in 1695, and educated in Trinity-hall, Cambridge; which place he left in 1714, when, by his own account, he was an absolute pedant. In this character he went abroad, where a familiarity with good company soon convinced him he was totally mistaken in almost all his notions: and an attentive study of the air, manner, and address of people of fashion, soon polished a man whose predominant desire was to please; and who, as it afterward appeared, valued exterior accomplishments beyond any other human acquirement. While Lord Stanhope, he got an early seat in parliament; and in 1722, succeeded to his father's estate and titles. In 1728, and in 1745, he was appointed ambassador extraordinary and plenipotentiary to Holland: which high character he supported with the greatest dignity; serving his own country, and gaining the esteem of the states-general. Upon his return from Holland, he was sent lord-lieutenant of Ireland; and during his administration there, gave general satisfaction to all parties. He left Dublin in 1746, and in October succeeded the earl of Harrington as secretary of state, in which post he officiated until February 6th 1748. Being seized with a deafness in 1752 that incapacitated him for the pleasures of society, he from that time led a private and retired life, amusing himself with books and his pen; in particular, he engaged largely as a volunteer in a periodical miscellaneous paper called *The World*, in which his contributions have a distinguished degree of excellence. He died in 1773, leaving a character for wit and abilities that had few equals. He distinguished himself by his eloquence in parliament on many important occasions; of which we have a characteristic instance, of his own relating. He was an active promoter of the bill for altering the style; on which occasion, as he himself writes in one of his letters to his son, he made so eloquent a speech in the house, that every one was pleased, and said he had made the whole very clear to them; "when (says he). God knows, I had not even attempted it. I could just as soon have talked Celtic or Slavonian to them, as astronomy; and they would have understood me full as well." Lord Macclesfield, one of the greatest mathematicians in Europe, and who had a principal hand in framing the bill, spoke afterwards, with all the clearness that a thorough knowledge of the subject could dictate; but not having a flow of words equal to Lord Chesterfield, the latter gained the applause from the former, to the equal credit of the speaker and the auditors. The high character Lord Chesterfield supported during life, received no small injury soon after his death, from a fuller display of it by his own hand. He left no issue by his lady, but had a natural son, Philip Stanhope, Esq; whose education was for many years a close object of his attention, and who was afterward envoy extraordinary at the court of Dresden, but died before him. When Lord Chesterfield died, Mr Stanhope's widow published a course of

letters, written by the father to the son, filled with instructions suitable to the different gradations of the young man's life to whom they were addressed. These letters contain many fine observations on mankind, and rules of conduct: but it is observable that he lays a greater stress on exterior accomplishments and address, than on intellectual qualifications and sincerity; and allows greater latitude to fashionable pleasures than good morals will justify, especially in paternal instructions. Hence it is that a celebrated writer §, and of manners § Dr Johnson, somewhat different from those of the polite earl of Chesterfield, is said to have observed of these letters that "they inculcate only the morals of a whore, with the manners of a dancing-master."

STANHOPE (Dr George), an eminent divine, was born at Hertishorn in Derbyshire, in the year 1660. His father was rector of that place, vicar of St Margaret's church in Leicester, and chaplain to the earls of Chesterfield and Clare. His grandfather Dr George Stanhope was chaplain to James I. and Charles I.; had the chancellorship of York, where he was also a canon residentiary, held a prebend, and was rector of Wel Drake in that county. He was for his loyalty driven from his home with eleven children; and died in 1644. Our author was sent to school, first at Uppingham in Rutland, then at Leicester; afterwards removed to Eaton; and thence chosen to King's college in Cambridge, in the place of W. Cleaver. He took the degree of B. A. in 1681; M. A. 1688; was elected one of the syndics for the university of Cambridge, in the business of Alban Francis, 1687; minister of Quoi near Cambridge, and vice-proctor, 1688; was that year preferred to the rectory of Tring in Hertfordshire, which after some time he quitted. He was in 1689 presented to the vicarage of Lewisham in Kent by Lord Dartmouth, to whom he had been chaplain, and tutor to his son. He was also appointed chaplain to King William and Queen Mary, and continued to enjoy that honour under Queen Anne. He commenced D. D. July 5th 1697, performing all the offices required to that degree publicly and with great applause. He was made vicar of Deptford in 1703; succeeded Dr Hooper as dean of Canterbury the same year; and was thrice chosen prolocutor of the lower house of convocation. His uncommon diligence and industry, assisted by his excellent parts, enriched him with a large stock of polite, solid, and useful learning. His discourses from the pulpit were equally pleasing and profitable; a beautiful intermixture of the clearest reasoning with the purest diction, attended with all the graces of a just elocution. The good Christian, the solid divine, and the fine gentleman, in him were happily united. His conversation was polite and delicate, grave without preciseness, facetious without levity. His piety was real and rational, his charity great and universal, fruitful in acts of mercy, and in all good works. He died March 18th 1728, aged 68 years; and was buried in the chancel of the church at Lewisham. The dean was twice married: 1. to Olivia Cotton, by whom he had one son and four daughters. His second lady, who was sister to Sir Charles Wager, survived him, dying October 1st 1730, aged about 54. One of the dean's daughters was married to a son of bishop Burnet. Bishop Moore of Ely died the day before Queen Anne; who, it has been said, designed our dean for that



Stanhope, see when it should become vacant. Dr Felton says, Stanislau. "The late dean of Canterbury is excellent in the whole. His thoughts and reasoning are light and solid. His style is just, both for the purity of the language and for the strength and beauty of expression; but the periods are formed in so peculiar an order of the words, that it was an observation, nobody could pronounce them with the same grace and advantage as himself." His writings, which are an inestimable treasure of piety and devotion are, A Paraphrase and Comment upon the Epistles and Gospels, 4 vols, 1705, 8vo. Sermons at Boyle's Lectures, 1706, 4to. Fifteen Sermons, 1700, 8vo. Twelve Sermons on several Occasions, 1727, 8vo. Thomas à Kempis 1696, 8vo. Epictetus's Morals, with Simplicius's Comment, and the Life of Epictetus, 1700, 8vo. Parson's Christian Directory, 1716, 8vo. Rochefoucault's Maxims, 1706, 8vo. A Funeral Sermon on Mr Richard Saxe bookseller, 1724; two editions 4to. Twenty Sermons, published singly between the years 1692 and 1724. Private Prayers for every Day in the Week, and for the several Parts of each Day; translated from the Greek Devotions of Bishop Andrews, with Additions, 1730. In his translations, it is well known, Dr Stanhope did not confine himself to a strict and literal version: he took the liberty of paraphrasing, explaining, and improving upon his author; as will evidently appear (not to mention any other work) by the slightest perusal of St Augustine's Meditations, and the Devotions of Bishop Andrews.

STANISLAUS (Leczinski), king of Poland, was born at Leopold the 20th of October 1677. His father was a polish nobleman, distinguished by his rank and the important offices which he held, but still more by his firmness and courage. Stanislaus was sent ambassador in 1704 by the assembly of Warsaw to Charles XII. of Sweden, who had conquered Poland. He was at that time 27 years old, was general of great Poland, and had been ambassador extraordinary to the Grand Signior in 1699. Charles was so delighted with the frankness and sincerity of his disposition, and with the firmness and sweetness which appeared in his countenance, that he offered him the crown of Poland, and ordered him to be crowned at Warsaw in 1705. He accompanied Charles XII. into Saxony, where a treaty was concluded with King Augustus in 1705, by which that prince resigned the crown, and acknowledged Stanislaus king of Poland. The new monarch remained in Saxony with Charles till 1707, when they returned into Poland and attacked the Russians, who were obliged to evacuate that kingdom in 1708. But Charles being defeated by Peter the Great in 1709, Augustus returned into Poland, and being assisted by a Russian army, obliged Stanislaus to retire first into Sweden, and afterwards into Turkey. Soon after he took up his residence at Weissenburg, a town in Alsace. Augustus dispatched Sum his envoy to France to complain of this; but the duke of Orleans, who was then regent, returned this answer: "Tell your king, that France has always been the asylum of unhappy princes." Stanislaus lived in obscurity till 1725, when Louis XV. espoused the princess Mary his daughter. Upon the death of King Augustus in 1733, he returned to Poland in hopes of remounting the throne of that kingdom. A large party declared for him; but his com-

petitor the young elector of Saxony, being supported by the Emperor Charles VI. and the Empress of Russia, was chosen king, though the majority was against him. Dantzic, to which Stanislaus had retired, was quickly taken, and the unfortunate prince made his escape in disguise with great difficulty, after hearing that a price was set upon his head by the Russians. When peace was concluded in 1736 between the Emperor and France, it was agreed that Stanislaus should abdicate the throne, but that he should be acknowledged king of Poland and grand duke of Lithuania, and continue to bear these titles during life; that all his effects and those of the queen his spouse should be restored; that an amnesty should be declared in Poland for all that was past, and that every person should be restored to his possessions, rights, and privileges: that the elector of Saxony should be acknowledged king of Poland by all the powers who acceded to the treaty: that Stanislaus should be put in peaceable possession of the duchies of Lorraine and Bar; but that immediately after his death these duchies should be united for ever to the crown of France. Stanislaus succeeded a race of princes in Lorraine, who were beloved and regretted: and his subjects found their ancient sovereigns revived in him. He tasted then the pleasure which he had so long desired, the pleasure of making men happy. He assisted his new subjects; he embellished Nancy and Lunéville; he made useful establishments; he founded colleges and built hospitals. He was engaged in these noble employments, when an accident occasioned his death. His night-gown caught fire and burnt him so severely before it could be extinguished, that he was seized with a fever, and died the 23d of February 1766. His death occasioned a public mourning: the tears of his subjects indeed are the best eulogium upon this prince. In his youth he had accustomed himself to fatigue, and had thereby strengthened his mind as well as his constitution. He lay always upon a kind of mattress, and seldom required any service from his domestics. He was temperate, liberal, adored by his vassals, and perhaps the only nobleman in Poland who had any friends. He was in Lorraine what he had been in his own country, gentle, affable, compassionate, treating his subjects like equals, participating their sorrows and alleviating their misfortunes. He resembled completely the picture of a philosopher which he himself has drawn. "The true philosopher (said he) ought to be free from prejudices, and to know the value of reason: he ought neither to think the higher ranks of life of more value than they are, nor to treat the lower orders of mankind with greater contempt than they deserve: he ought to enjoy pleasures without being a slave to them, riches without being attached to them, honours without pride or vanity: he ought to support disgraces without either tearing or courting them: he ought to reckon what he possesses sufficient for him, and to regard what he has not as useless: he ought to be equal in every fortune, always tranquil, always gay: he ought to love order, and to observe it in all his actions: he ought to be severe to himself, but indulgent to others: he ought to be frank and ingenuous without rudeness, polite without falsehood, complaisant without baseness: he ought to have the courage to disregard every kind of glory, and to reckon as nothing even philosophy itself." Such was Stanislaus in every situation. His temper was affection-

ate.

Stanislaus  
||  
Stannary.

etc. He told his treasurer one day to put a certain officer on his list, to whom he was very much attached: "In what quality (said the treasurer) shall I mark him down?" "As my friend" (replied the monarch.) A young painter conceiving hopes of making his fortune if his talents were made known to Stanislaus, presented him with a picture, which the courtiers criticised severely. The prince praised the performance, and paid the painter very generously: then turning to his courtiers, he said, "Do ye not see, gentlemen, that this poor man must provide for his family by his abilities? if you discourage him by your censures, he is undone. We ought always to assist men; we never gain any thing by hurting them." His revenues were small; but were we to judge of him by what he did, we should probably reckon him the richest potentate in Europe. A single instance will be sufficient to show the well judged economy with which his benevolent plans were conducted. He gave 18,000 crowns to the magistrates of Bar to be employed in purchasing grain, when at a low price, to be sold out again to the poor at a moderate rate when the price should rise above a certain sum. By this arrangement (say the authors of *Dictionnaire Historique*), the money increases continually, and its good effects may in a short time be extended over the whole province.

He was a protector of the arts and sciences: he wrote several works of philosophy, politics, and morality, which were collected and published in France in 1765, in 4 vols, 8vo. under the title of *Oeuvres du Philosophe Bienfaisant*, "the works of the Benevolent Philosopher."

STANITZAS, villages or small districts of the banks of the Don, inhabited by Cossacs.

STANLEY (Thomas), a very learned English writer in the 17th century, was the son of Sir Thomas Stanley of Cumberlow-Green in Herefordshire, knight. He was born at Cumberlow about 1644, and educated in his father's house, whence he removed to the university of Cambridge. He afterwards travelled; and, upon his return to England, prosecuted his studies in the Middle Temple. He married, when young, Dorothy, the eldest daughter of Sir James Egan of Flower, in Northamptonshire. He wrote, 1. A volume of Poems. 2. History of Philosophy, and Lives of the Philosophers. 3. A Translation of Eschylus, with a Commentary; and several other works. He died in 1678.

STANNARIES, the mines and works where tin is dug and purified; as in Cornwall, Devonshire, &c.

STANNARY COURTS, in Devonshire and Cornwall, for the administration of justice among the tanners therein. They are held before the lord-warden and his substitutes, in virtue of a privilege granted to the workers in the tin-mines there, to sue and be sued only in their own courts, that they may not be drawn from their business, which is highly profitable to the public, by attending their law-suits in other courts. The privileges of the tanners are confirmed by a charter, 33 Edw. I. and fully expounded by a private statute, 50 Edw. III. which has since been explained by a public act, 16 Car. I. c. 15. What relates to our present purpose is only this: That all tanners and labourers in and about the stannaries shall, during the time of their working therein, *bona fide*, be privileged from suits of other courts, and be only pleaded in the stannary court in all matters, excepting pleas of land,

life, and member. No writ of error lies from hence to any court in Westminster hall; as was agreed by all the judges, in 4 Jac. I. But an appeal lies from the steward of the court to the under-warden; and from him to the lord-warden; and thence to the privy-council of the prince of Wales, as duke of Cornwall, when he hath had livery or investiture of the same. And from thence the appeal lies to the king himself, in the last resort.

STANNUM, TIN. See *CHEMISTRY-Index*, and TIN.

STANZA, in poetry, a number of lines regularly adjusted to each other; so much of a poem as contains every variation of measure or relation of rhyme used in that poem.

STAPHYLEA, BLADDER-NUT, in botany: A genus of plants belonging to the class of *pentandria*, and order of *trigynia*; and in the natural system arranged under the 23d order, *tribilata*. The calyx is quinquepartite. There are five petals. The capsules are three, inflated and joined together by a longitudinal suture. The seeds are two, and are globose with a scar. There are two species, the pinnata and trifolia. The *pinnata*, or bladder-nut-tree, is a tall shrub or tree. The leaves are pinnated; the pinnae are generally five, oblong, pointed, and notched round the edges. The flowers are white, and grow in whirls on long pendulous footstalks. This plant flowers in June, and is frequent in hedges about Pontefract and in Kent. The *trifolia*, or three-leaved bladder-nut, is a native of Virginia.

STAPHYLINUS, a genus of animals belonging to the class of *insecta*, and order of *coleoptera*. The antennae are moniliform; the feelers four in number; the elytra are not above half the length of the abdomen; the wings are folded up and concealed under the elytra; the tail or extremity of the abdomen is single, is provided with two long vesicles which the insect can shoot out or draw back at pleasure. Gmelin enumerates 117 species, of which five only are natives of Great Britain; the murinus, maxillofus, rufus, riparius, chrysolinus.

1. *Murinus*. The head is depressed. The colour is grey, clouded with black. The length is six lines. It lives among horse-dung. 2. The *maxillofus* is black, with ash-coloured stripes, and jaws as long as the head. It inhabits the woods. 3. *Rufus* is of an orange-colour; but the posterior part of the elytra and abdomen is black, as are also the thighs at their base. 4. *Riparius* is of a reddish brown colour; but the elytra are azure-coloured; and the head, antennae, and two last rings of the abdomen, are black. It is frequent on the banks of rivers in Europe. 5. *Chrysolinus* is black; the thorax, elytra, and feet being testaceous. It is found in the north of Europe.

The insects have a peculiarity to be met with in almost every species of this genus, which is, that they frequently turn up their tail, or extremity of the abdomen, especially if you chance to touch them; in which case the tail is seen to rise immediately, as if the insect meant to defend itself by stinging. Yet that is not the place where the insect's offensive weapons are situated. Its tail has no sting, but in recompense it bites and pinches strongly with its jaws; and care must be taken, especially in laying hold of the larger species. Their jaws are strong, shoot out beyond the head, and are subservient to the animal in seizing and destroying  
its

Stannum  
||  
Staphylinus

Blackstone's  
Comment.  
vol. iii.  
p. 79 and  
80.

Barbut's  
Genera In-  
sectorum.

Star.  
Star.

its prey. It feeds on all other insects it can catch: even frequently two staphylini of the same species bite and tear each other. Though this insect has very small elytra, yet its wings are large; but they are curiously folded up, and concealed under the elytra. The insect unfolds and expands them when he chooses to fly, which he does very lightly. Among the small species of this genus, there are several whose colours are lively and singularly intermingled.

Some of them are found upon flowers, but they chiefly inhabit the dung of cows. Their larvæ, which resemble them so much as to be scarce distinguishable, live in damp places under ground. They are by some called *Rove beetles*.

STAPLE, primarily signifies a public place or market, whither merchants, &c. are obliged to bring their goods to be bought by the people; as the Greve, or the places along the Seine, for sale of wines and corn, at Paris, whither the merchants of other parts are obliged to bring those commodities.

Formerly, the merchants of England were obliged to carry their wool, cloth, lead, and other like staple commodities of this realm, in order to expose them by wholesale; and these staples were appointed to be constantly kept at York, Lincoln, Newcastle upon Tyne, Norwich, Westminster, Canterbury, Chichester, Winchester, Exeter, and Bristol; in each whereof a public mart was appointed to be kept, and each of them had a court of the mayor of the staple, for deciding differences, held according to the law-merchant, in a summary way.

STAR, in astronomy, a general name for all the heavenly bodies, which, like so many brilliant studs, are dispersed throughout the whole heavens. The stars are distinguished, from the phenomena of their motion, &c. into fixed, and erratic or wandering stars; these last are again distinguished into the greater luminaries, viz. the sun and moon; the planets, or wandering stars, properly so called; and the comets; which have been all fully considered and explained under the article ASTRONOMY. As to the fixed stars, they are so called, because they seem to be fixed, or perfectly at rest, and consequently appear always at the same distance from each other.

*Falling STARS*, in meteorology, fiery meteors which dart through the sky in form of a star. See METEOR.

*Twinkling of the STARS*. See OPTICS, n<sup>o</sup> 21. et seq.

STAR, is also a badge of honour, worn by the knights of the garter, bath, and thistle. See GARTER.

*STAR of Bethlehem*, in botany. See ORNITHOGALUM.

*Court of STAR-CHAMBER*, (*camera stellata*), a famous, or rather infamous, English tribunal, said to have been so called either from a Saxon word signifying to *steer* or govern; or from its punishing the *crimen stellatus*, or cozenage; or because the room wherein it sat, the old council-chamber of the palace of Westminster, (Lamb. 148.) which is now converted into the lottery-office, and forms the eastern side of New Palace-yard, was full of windows; or, (to which Sir Edward Coke, 4 Inst. 66. accedes), because *haply* the roof thereof was at the first garnished with gilded stars. As all these are merely conjectures, (for no stars are now in the roof, nor are any said to have remained there so late as

the reign of queen Elizabeth), it may be allowable to propose another conjectural etymology, as plausible perhaps as any of them. It is well known, that, before the banishment of the Jews under Edward I. their contracts and obligations were denominated in our ancient records *starra* or *starrs*, from a corruption of the Hebrew word, *shetar*, a covenant. (Tovey's *Angl. Judaic.* p. 260. 32. Selden. tit. of hon. ii. 34. *Uxor Ebraic.* i. 14.)

These *starrs*, by an ordinance of Richard the First, preserved by Hoveden, were commanded to be enrolled and deposited in chests under three keys in certain places; one, and the most considerable, of which was in the king's exchequer at Westminster: and no *starr* was allowed to be valid, unless it were found in some of the said repositories. (*Memorand. in Scac' P. 6. Edw. I.* prefixed to Maynard's year-book of Edw. II. fol. 8. Madox hist. exch. c. vii. § 4, 5, 6.) The room at the exchequer, where the chests containing these *starrs* were kept, was probably called the *star-chamber*; and, when the Jews were expelled the kingdom, was applied to the use of the king's council, sitting in their judicial capacity. To confirm this, the first time the *star-chamber* is mentioned in any record, it is said to have been situated near the receipt of the exchequer at Westminster: (the king's council, his chancellor, treasurer, justices, and other judges, were assembled *en la chaumbre des esteilles pres la receipt al Westminster.* *Claus. 41 Edw. III. m. 13.*) For in process of time, when the meaning of the Jewish *starrs* were forgotten, the word *star-chamber* was naturally rendered in law French, *la chaumbre des esteilles*, and in law Latin *camera stellata*; which continued to be the style in Latin till the dissolution of that court.

This was a court of very ancient original; but remodelled by statutes 3 Hen. VII. c. 1. and 21 Hen. VIII. c. 20. consisting of divers lords spiritual and temporal, being privy-counsellors, together with two judges of the courts of common-law, without the intervention of any jury. Their jurisdiction extended legally over riots, perjury, misbehaviour of sheriffs, and other notorious misdemeanors, contrary to the laws of the land. Yet this was afterwards (as lord Clarendon informs us) stretched "to the asserting of all proclamations and orders of state; to the vindicating of illegal commissions and grants of monopolies; holding for honourable that which pleased, and for just that which profited; and becoming both a court of law to determine civil rights, and a court of revenue to enrich the treasury: the council-table by proclamations enjoining to the people that which was not enjoined by the laws, and prohibiting that which was not prohibited; and the *star-chamber*, which consisted of the same persons in different rooms, censuring the breach and disobedience to those proclamations by very great fines, imprisonments, and corporal severities: so that any disrespect to any acts of state, or to the persons of statesmen, was in no time more penal, and the foundations of right never more in danger to be destroyed." For which reasons, it was finally abolished by statute 16 Car. I. c. 10. to the general joy of the whole nation. See *KING'S BENCH*. There is in the British Museum (Harl. MSS. Vol. I. n<sup>o</sup> 126.) a very full, methodical, and accurate account of the constitution and course of this court, compiled by William Hudson of Gray's Inn, an eminent practitioner therein. A short account of the same, with

Star-

Blackst.  
Comment.  
vol. iv.  
p. 260.

Star,  
Starch.

copies of all its procefs, may also be found in 18 Rym. Foed. 192, &c.

*STAR-Board*, the right side of the ship when the eye of the fpe&ccaronator is directed forward.

*STAR-Fish*. See *ASTERIAS*.

*STAR-shot*, a gelatinous substance frequently found in fields, and supposed by the vulgar to have been produced from the meteor called a *falling star*: but, in reality, is the half-digested food of herons, sea mews, and the like birds; for these birds have been found, when newly shot, to disgorge a substance of the same kind.

*STAR-Stone*, in natural history, a name given to certain extraneous fossil stones, in form of short, and commonly somewhat crooked, columns composed of several joints, each resembling the figure of a radiated star, with a greater or smaller number of rays in the different species: they are usually found of about an inch in length, and of the thickness of a goose-quill. Some of them have five angles or rays, and others only four; and in some the angles are equidistant, while in others they are irregularly so: in some also they are short and blunt, while in others they are long, narrow, and pointed; and some have their angles very short and obtuse. The several joints in the same specimen are usually all of the same thickness; this, however, is not always the case: but in some they are larger at one end, and in others at the middle, than in any other part of the body; and some species have one of the rays bifid, so as to emulate the appearance of a six-rayed kind.

*STAR-Thistle*, in botany. See *CENTAUREA*.

*STAR-Wort*, in botany. See *ASTER*.

*STARCH*, a fecula or sediment, found at the bottom of vessels wherein wheat has been steeped in water, of which fecula, after separating the bran from it, by passing it through sieves, they form a kind of loaves, which being dried in the sun or an oven, is afterwards cut into little pieces, and so sold. The best starch is white, soft, and friable, and easily broken into powder. Such as require fine starch, do not content themselves, like the starchmen, with refuse wheat, but use the finest grain. The process is as follows: The grain, being well cleaned, is put to ferment in vessels full of water, which they expose to the sun while in its greatest heat; changing the water twice a-day, for the space of eight or twelve days, according to the season. When the grain bursts easily under the finger, they judge it sufficiently fermented. The fermentation perfected, and the grain thus softened, it is put, handful by handful, into a canvas bag, to separate the flour from the husks; which is done by rubbing and beating it on a plank laid across the mouth of an empty vessel that is to receive the flour.

As the vessels are filled with this liquid flour, there is seen swimming at top a reddish water, which is to be carefully scummed off from time to time, and clean water is to be put in its place, which, after stirring the whole together, is also to be strained through a cloth or sieve, and what is left behind put into the vessel with new water, and exposed to the sun for some time. As the sediment thickens at the bottom, they drain off the water four or five times, by inclining the vessel, but without passing it through the sieve. What remains at bottom is the starch, which they cut in pieces to get

out, and leave it to dry in the sun. When dry, it is laid up for use.

Stark.

*STARK* (Dr William), known to the public by a volume containing *Clinical and Anatomical Observations*, with some curious *Experiments on Diet*, was born at Manchester in the month of July 1740; but the family from which he sprang was Scotch, and respectable for its antiquity. His grandfather John Stark of Killermont was a covenanter; and having appeared in arms against his sovereign at the battle of Bothwell bridge in the year 1679, became obnoxious to the government, and to conceal himself, withdrew into Ireland. There is reason to believe that he had not imbibed either the extravagant zeal or the savage manners of the political and religious party to which he adhered; for after residing a few years in the country which he had chosen for the scene of his banishment, he married Elizabeth daughter of Thomas Stewart Esq; of Balydrene in the north of Ireland; who, being descended of the noble family of Galloway, would not probably have matched his daughter to such an exile as a ruthless fanatic of the last century. By this lady Mr Stark had several children; and his second son Thomas, who settled at Manchester as a wholesale linen-draper, and married Margaret Stirling, daughter of William Stirling, Esq; of Northwoodside, in the neighbourhood of Glasgow, was the father of the subject of this article. Another of his sons, the reverend John Stark, was minister of Lecropt in Perthshire; and it was under the care of this gentleman that our author received the rudiments of his education, which, when we consider the character of the master, and reflect on the relation between him and his pupil, we may presume was calculated to store the mind of Dr Stark with those virtuous principles which influenced his conduct through life.

From Lecropt young Stark was sent to the university of Glasgow, where, under the tuition of the Doctors Smith and Black, with other eminent masters, he learned the rudiments of science, and acquired that mathematical accuracy, that logical precision, and that contempt of hypotheses, with which he prosecuted all his future studies. Having chosen physic for his profession, he removed from the university of Glasgow to that of Edinburgh, where he was soon distinguished, and honoured with the friendship of the late Dr Cullen; a man who was not more eminently conspicuous for the superiority of his own genius, than quick-sighted in perceiving, and liberal in encouraging, genius in his pupils. Having finished his studies at Edinburgh, though he took there no degree, Mr Stark, in the year 1765, went to London, and devoted himself entirely to the study of physic and the elements of surgery; and looking upon anatomy as one of the principal pillars of both these arts, he endeavoured to complete with Dr Hunter what he had begun with Dr Monro; and under these two eminent professors he appears to have acquired a high degree of anatomical knowledge. He likewise entered himself about this time a pupil at St George's hospital; for being disgusted, as he often confessed, with the inaccuracy or want of candour observable in the generality of practical writers, he determined to obtain an acquaintance with dissections at a better school and from an abler master; and to have from his own experience a standard, by which he might judge of the experience

Stark. perience of others. With what industry he prosecuted this plan, and with what success his labours were crowned, may be seen in a series of *Clinical and Anatomical Observations*, which were made by him during his attendance at the hospital, and were published after his death by his friend Dr Carnichael Smyth. These observations give the public no cause to complain of want of candour in their author; for whatever delicacy he may have observed, when relating the cases of patients treated by other physicians, he has related those treated by himself with the utmost impartiality. Whilst attending the hospital, he likewise employed himself in making experiments on the blood, and other animal fluids; and also in a course of experiments in chemical pharmacy; but though accounts of these experiments were left behind him, we believe they have not yet been given to the public.

In the year 1767 Mr Stark went abroad and obtained the degree of M. D. in the university of Leyden, publishing an inaugural dissertation on the dysentery. On his return to London, he recommenced his studies at the hospital; and when Dr Black was called to the chemical chair in Edinburgh, which he has long filled with so much honour to himself and credit to the university, Dr Stark was solicited by several members of the university of Glasgow to stand a candidate for their professorship of the theory and practice of physic, rendered vacant by Dr Black's removal to Edinburgh. This however Dr Stark declined, being influenced by the advice of his English friends, who wished to detain him in London, and having likewise some prospects of an appointment in the hospital.

In the mean time he had commenced (1769) a series of experiments on diet, which he was encouraged to undertake by Sir John Pringle and Dr Franklin, whose friendship he enjoyed, and from whom he received many hints respecting both the plan and its execution. These experiments, or rather the imprudent zeal with which he prosecuted them, proved in the opinion of his friends, fatal to himself; for he began them on the 12th of July 1669 in perfect health and vigour, and from that day, though his health varied, it was seldom if ever good, till the 23d of February 1770, when he died, after suffering much uneasiness. His friend and biographer Dr Smyth thinks, that other causes, particularly chagrin and disappointment, had no small share in hastening his death; and as the Doctor was intimately acquainted with his character and disposition, his opinion is probably well-founded, though the pernicious effects of the experiments are visible in Dr Stark's own journal. When he entered upon them, the weight of his body was 12 stone 3 lb. avoirdupois, which in a very few days was reduced to 11 stone 10 lb 8 oz: and though some kinds of food increased it, by much the greater part of what he used had a contrary effect, and it continued on the whole to decrease till the day of his death. This indeed can excite no wonder. Though the professed object of his experiments was to prove that a pleasant and varied diet is equally conducive to health with a more strict and simple one, most of the dishes which he ate during these experiments were neither pleasant nor simple, but compounds, such as every stomach must nauseate. He began with *bread and water*: from which he proceeded to *bread, water, and sugar*; then to *bread, water, and oil of olives*; then to *bread and water with*

*milk*; afterwards he tried *bread and water with roasted goose*; *bread and water with boiled beef*; *steved lean of beef with the gravy and water without bread*; *steved lean of beef with the gravy, oil of fat or suet and water*; *flour, oil of suet, water and salt*; *flour, water, and salt*; and a number of others infinitely more disagreeable to the stomach than even these, such as *bread, fat of bacon ham, infusion of tea with sugar*; and *bread or flour with honey and the infusion of rosemary*. But though we consider Dr Stark's experiments as whimsical, it cannot be denied that they indicate eccentricity of genius in the person who made them; and such of our readers as think genius hereditary, may perhaps be of opinion, that he derived a ray from the celebrated NAPIER the inventor of the logarithms, who was his ancestor by both parents. At any rate, these experiments, of which a full account is given in the same volume with his clinical and anatomical observations, display an uncommon degree of fortitude, perseverance, self-denial, and zeal for the promoting of useful knowledge in their author; and with respect to his moral character, we believe it is with great justice that Dr Smyth compares him to Cato by applying to him what was said of that virtuous Roman by Sallust.—“Non divitiis cum divite, neque factione cum factioso; sed cum strenua virtute, cum modesto pudore, cum innocente abstinentia certabat; esse, quam videri, bonus malebat \*.”

STARLING. See STURNUS.

STATE OF A CONTROVERSY. See ORATORY, PART I. n<sup>o</sup> 14.

STATES, or ESTATES, a term applied to several orders or classes of people assembled to consult of matters for the public good.

Thus states-general is the name of an assembly consisting of the deputies of the seven United Provinces. These are usually 30 in number, some provinces sending two, others more; and whatever resolution the states-general take, must be confirmed by every province, and by every city and republic in that province, before it has the force of a law. The deputies of each province, of what number soever they be, have only one voice, and are esteemed as but one person, the votes being given by provinces. Each province presides in the assembly in its turn, according to the order settled among them. Gelderland presides first, then Holland, &c.

States of Holland are the deputies of eighteen cities, and one representative of the nobility, constituting the states of the province of Holland: the other provinces have likewise their states, representing their sovereignty; deputies from which make what they call the states-general. In an assembly of the states of a particular province, one dissenting voice prevents their coming to any resolution.

STATICE THRIFT, in botany: A genus of plants belonging to the class of *pentandria*, and order of *pentagynia*; and in the natural system ranging under the 25th order, *aggregata*. The calyx is monophyllous, entire, foisted, and scarious. There are five petals, with one superior seed. There are 22 species, the *armeria*, *pseud-armeria*, *limonium*, *incana*, *cordata*, *reticulata*, *echioides*, *speciosa*, *tatarica*, *echinus*, *flexuosa*, *purpurata*, *minuta*, *suffruticosa*, *monopetala*, *aurea*, *ferulacea*, *limifolia*, *pruinosa*, *sinuata*, *mucronata*, and *lobata*. Three of these are British plants.

1. The *armeria*, thrift, or sea gilly-flower, has a simple naked

Stark  
||  
Stati c.

\* DeHum.  
Custina-  
rium.

Statics.

naked stem about six inches high. The radical leaves are like grass. The flowers are terminal, pale red, with a round head, and not very large. This plant flowers in July or August, and grows in meadows near the sea.

2. *Limonium*, sea-lavender. The stem is naked, branched, and about a foot high. The radical leaves are long, pointed, and grow on footstalks. The flowers are blue, and grow on long spikes on the tops of the branches. It grows on the sea coast in South Britain.

3. *Reticulata*, matted sea-lavender. The stem is prostrate, and terminated by a panicle of flowers. The branches are naked, barren, and bent back. The leaves are wedge shaped. This species is also found on the sea-coast of South Britain.

STATICS, a term which the modern improvements in knowledge have made it necessary to introduce into physico-mathematical science. It was found convenient to distribute the doctrines of universal mechanics into two classes, which required both a different mode of consideration and different principles of reasoning.

Till the time of Archimedes little science of this kind was possessed by the ancients, from whom we have received the first rudiments. His investigation of the centre of gravity, and his theory of the lever, are the foundations of our knowledge of common mechanics: and his theory of the equilibrium of floating bodies contains the greatest part of our hydrostatical knowledge. But it was as yet limited to the simplest cases; and there were some in which Archimedes was ignorant, or was mistaken. The marquis Guido Ubuldi, in 1578, published his theory of mechanics, in which the doctrines of Archimedes were well explained and considerably augmented. Stevinus, the celebrated Dutch engineer, published about 20 years after an excellent system of mechanics, containing the chief principles which now form the science of equilibrium among solid bodies. In particular, he gave the theory of inclined planes, which was unknown to the ancients, though it is of the very first importance in almost every machine. He even states in the most express terms the principle afterwards made the foundation of the whole of mechanics, and published as a valuable discovery by Varignon, viz. that three forces, whose directions and intensities are as the sides of a triangle, balance each other. His theory of the pressure of fluids, or hydrostatics, is no less estimable, including every thing that is now received as a leading principle in the science. When we consider the ignorance, even of the most learned, of that age in mechanical or physico-mathematical knowledge, we must consider those performances as the works of a great genius, and we regret that they are so little known, being lost in a crowd of good writings on those subjects which appeared soon after.

Hitherto the attention had been turned entirely to equilibrium, and the circumstances necessary for producing it. Mechanicians indeed saw, that the energy of a machine might be somehow measured by the force which could be opposed or overcome by its intervention: but they did not remark, that the force which prevented its motion, but did no more than prevent it, was an *exact* measure of its energy, because it was in immediate equilibrium with the pressure exerted by that part of the machine with which it was connected. If this opposed force was less, or the force acting at the other extremity of the machine was greater, the me-

Statics.

chanicians knew that the machine would move, and that work would be performed; but what would be the rate of its motion or its performance, they hardly pretended to conjecture. They had not studied the action of moving forces, nor conceived what was done when motion was communicated.

The great Galileo opened a new field of speculation in his work on Local Motion. He there considers a change of motion as the indication and exact and adequate measure of a moving force; and he considers every kind of pressure as competent to the production of such changes.—He contented himself with the application of this principle to the motion of bodies by the action of gravity, and gave the theory of projectiles, which remains to this day without change, and only improved by considering the changes which are produced in it by the resistance of the air.

Sir Isaac Newton took up this subject nearly as Galileo had left it. For, if we except the theory of the centrifugal forces arising from rotation, and the theory of pendulums, published by Huygens, hardly any thing had been added to the science of motion. Newton considered the subject in its utmost extent; and in his mathematical principles of natural philosophy he considers every conceivable variation of moving force, and determines the motion resulting from its action.—His first application of these doctrines was to explain the celestial motions; and the magnificence of this subject caused it to occupy for a while the whole attention of the mathematicians. But the same work contained propositions equally conducive to the improvement of common mechanics, and to the complete understanding of the mechanical actions of bodies. Philosophers began to make these applications also. They saw that every kind of work which is to be performed by a machine may be considered abstractedly as a retarding force; that the impulse of water or wind, which are employed as moving powers, act by means of pressures which they exert on the impelled point of the machine; and that the machine itself may be considered as an assemblage of bodies moveable in certain limited circumstances, with determined directions and proportions of velocity. From all these considerations resulted a general abstract condition of a body acted on by known powers. And they found, that after all conditions of equilibrium were satisfied, there remains a surplus of moving force. They could now state the motion which will ensue, the new resistance which this will excite, the additional power which this will absorb; and they at last determined a new kind of equilibrium, not thought of by the ancient mechanicians, between the resistance to the machine performing work and the moving power, which exactly balance each other, and is indicated, not by the *rest*, but by the *uniform motion* of the machine.—In like manner, the mathematician was enabled to calculate that precise motion of water which would completely absorb, or, in the new language, balance the superiority of pressure by which water is forced through a sluice, a pipe, or canal, with a constant velocity.

Thus the general doctrines of motion came to be considered in two points of view, according as they balanced each other in a state of rest or of uniform motion. These two ways of considering the same subject required both different principles and a different manner of reasoning. The first has been named STATICS, as expressing

pressing that rest which is the test of this kind of equilibrium. The second has been called DYNAMICS or UNIVERSAL MECHANICS, because the different kinds of motion are characteristic of the powers or forces which produce them. A knowledge of both is indispensably necessary for acquiring any useful practical knowledge of machines; and it was ignorance of the doctrines of accelerated and retarded motions which made the progress of practical mechanical knowledge so very slow and imperfect. The mechanics, even of the moderns, before Galileo, went no further than to state the proportion of the power and resistance which would be balanced by the intervention of a given machine, or the proportion of the parts of a machine by which two known forces may balance each other. This view of the matter introduced a principle, which even Galileo considered as a mechanical axiom, viz. that *what is gained in force by means of a machine is exactly compensated by the additional time which it obliges us to employ.* This is false in every instance, and not only prevents improvement in the construction of machines, but leads us into erroneous maxims of construction. The true principles of dynamics teach us, that there is a certain proportion of the machine, dependent on the kind and proportion of the power and resistance, which enables the machine to perform the greatest possible work.

It is highly proper therefore to keep separate these two ways of considering machines, that both may be improved to the utmost, and then to blend them together in every practical discussion.

Statics therefore is preparatory to the proper study of mechanics; but it does not hence derive all its importance. It is the sole foundation of many useful parts of knowledge. This will be best seen by a brief enumeration.

1. It comprehends all the doctrines of the excitement and propagation of pressure through the parts of solid bodies, by which the energies of machines are produced. A pressure is exerted on the impelled point of a machine, such as the float-boards or buckets of a mill-wheel. This excites a pressure at the pivots of its axle, which act on the points of support. This must be understood, both as to direction and intensity, that it may be effectually resisted. A pressure is also excited at the acting tooth of the cog-wheel on the same axle, by which it urges round another wheel, exciting similar pressures on its pivots and on the acting tooth perhaps of a third wheel.—Thus a pressure is ultimately excited in the working point of the machine, perhaps a wiper, which lifts a heavy stamp, to let it fall again on some matter to be pounded. Now statics teaches us the intensities and direction of all those pressures, and therefore how much remains at the working point of the machine unbalanced by resistance.

2. It comprehends every circumstance which influences the stability of heavy bodies; the investigation and properties of the centre of gravity; the theory of the construction of arches, vaults, and domes; the attitudes of animals.

3. The strength of materials, and the principles of construction, so as to make the proper adjustment of strength and strain in every part of a machine, edifice, or structure of any kind. Statics therefore furnishes us with what may be called a *theory of carpentry*, and

gives us proper instructions for framing floors, roofs, centres, &c.

4. Statics comprehends the whole doctrine of the pressure of fluids, whether liquid or aeriform, whether arising from their weight or from any external action. Hence therefore we derive our knowledge of the stability of ships, or their power of maintaining themselves in a position nearly upright, in opposition to the action of the wind on their sails. We learn on what circumstances of figure and stowage this quality depends, and what will augment or diminish it.

Very complete examples will be given in the remaining part of this work of the advantages of this separate consideration of the condition of a machine at rest and in working motion; and in what yet remains to be delivered of the hydraulic doctrines in our account of *WATER-Works* in general, will be perceived the propriety of stating apart the equilibrium which is indicated by the uniform motion of the fluid. The observations too which we have to make on the strength of the materials employed in our edifices or mechanical structures, will be examples of the investigation of those powers, pressures, or strains, which are excited in all their parts.

STATISTICS, a word lately introduced to express a view or survey of any kingdom, county, or parish.

A Statistical view of Germany was published in 1790 by Mr B. Clarke; giving an account of the imperial and territorial constitutions, forms of government, legislation, administration of justice, and of the ecclesiastical state; with a sketch of the character and genius of the Germans; a short inquiry into the state of their trade and commerce; and giving a distinct view of the dominions, extent, number of inhabitants to a square mile; chief towns, with their size and population; revenues, expences, debts, and military strength of each state. In Prussia, in Saxony, Sardinia, and Tuscany, attempts have also been made to draw up statistical accounts; but they were done rather with a view of ascertaining the present state of these countries, than as the means of future improvement.

A grand and extensive work of this kind, founded on a judicious plan, conducted by the most patriotic and enlightened motives, and drawn up from the communications of the whole body of the clergy, was undertaken in Scotland in the year 1790 by Sir John Sinclair of Ulbster, one of the most useful members of his country. Many praises are heaped upon genius and learning; but to genius and learning no applause is due, except when excited for the benefit of mankind; but gratitude and praise is due to him whose talents shine only in great undertakings, whose happiness seems to consist in patriotic exertions, and whose judgment is uniformly approved by his success. A work of this kind, so important in its object, so comprehensive in its range, so judicious in its plan, and drawn up by more than 900 men of literary education, many of them men of great genius and learning, must be of immense value. Sixteen volumes octavo are already published; and it is supposed that the work will be completed in two or three additional volumes.

The great object of this work is to give an accurate view of the state of the country, its agriculture, its manufactures, and its commerce; the means of improvement, of which they are respectively capable; the amount of the population of a state, and the causes of its increase

Statifical.

or decrease; the manner in which the territory of a country is possessed and cultivated; the nature and amount of the various productions of the soil; the value of the personal wealth or stock of the inhabitants, and how it can be augmented; the diseases to which the people are subject, their causes and their cure; the occupations of the people; where they are entitled to encouragement, and where they ought to be suppressed; the condition of the poor, the best mode of maintaining them, and of giving them employment; the state of schools, and other institutions, formed for purposes of public utility; the state of the villages and towns, and the regulations best calculated for their police and good government; the state of the manners, the morals, and the religious principles of the people, and the means by which their temporal and eternal interests can best be promoted.

To such of our readers as have not an opportunity of perusing this national work, or of examining its plan, we will present the scheme for the statistical account of a parochial district which Sir John Sinclair published for the consideration of the clergy, and which has been generally followed by them, though often with great improvements.

The name of the parish and its origin; situation and extent of the parish; number of acres; description of the soil and surface; nature and extent of the sea coast; lakes, rivers, islands, hills, rocks, caves, woods, orchards, &c.; climate and diseases; instances of longevity; state of property; number of proprietors; number of residing proprietors; mode of cultivation; implements of husbandry; manures; seedtime and harvest; remarkable instances of good and bad seasons; quantity and value of each species of crop; total value of the whole produce of the district; total real and valued rent; price of grain and provisions; total quantity of grain and other articles consumed in the parish; wages and price of labour; services, whether exacted or abolished; commerce; manufactures; manufacture of kelp, its amount, and the number of people employed in it; fisheries; towns and villages; police; inns and alehouses; roads and bridges; ferries, and their state; number of ships and vessels; number of seamen; state of the church; stipend, manse, glebe, and patron; number of poor; parochial funds, and the management of them; state of the schools, and number of scholars; ancient state of population; causes of its increase or decrease; number of families; exact amount of the number of souls now living; division of the inhabitants; 1. by the place of their birth; 2. by their ages; 3. by their religious persuasions; 4. by their occupations and situation in life; 5. by their residence, whether in town, village, or in the country; number of houses; number of uninhabited houses; number of dove-cots, and to what extent they are destructive to the crops; number of horses, their nature and value; number of cattle, their nature and value; number of sheep, their nature and value; number of swine, their nature and value; minerals in general; mineral springs; coal and fuel; eminent men; antiquities; parochial records; miscellaneous observations; character of the people; their manners, customs, stature, &c.; advantages and disadvantages; means by which their situation could be meliorated.

If similar surveys (says the public-spirited editor of this work) were instituted in the other kingdoms of Europe, it might be the means of establishing, on sure foundations, the principles of that most important of all

sciences, viz. political or statistical philosophy; that is, the science, which, in preference to every other, ought to be held in reverence. No science can furnish, to any mind capable of receiving useful information, so much real entertainment; none can yield such important hints, for the improvement of agriculture, for the extension of commercial industry, for regulating the conduct of individuals, or for extending the prosperity of the state; none can tend so much to promote the general happiness of the species.

STATIUS (Publius Papinius), a celebrated Latin poet of the first century, was born at Naples, and was the son of Statius, a native of Epirus, who went to Rome to teach poetry and eloquence, and had Domitian for his scholar. Statius the poet also obtained the favour and friendship of that prince; and dedicated to him his *Thebais* and *Achilleis*; the first in twelve books, and the last in two. He died at Naples about the year 100. Besides the above poems, there are also still extant his *Sylvæ*, in five books; the style of which is purer, more agreeable, and more natural, than that of his *Thebais* and *Achilleis*.

STATUARY, a branch of sculpture, employed in the making of statues. See SCULPTURE and the next article.

Statuary is one of those arts wherein the ancients surpassed the moderns; and indeed it was much more popular, and more cultivated, among the former than the latter. It is disputed between statuary and painting, which of the two is the most difficult and the most artful.

Statuary is also used for the artificer who makes statues. Phidias was the greatest statuary among the ancients, and Michael Angelo among the moderns.

STATUE, is denoted to be a piece of sculpture in full relief, representing a human figure. Daviler more scientifically defines statue a representation, in high relief and intaiate, of some person distinguished by his birth, merit, or great actions, placed as an ornament in a fine building, or exposed in a public place, to preserve the memory of his worth. In Greece one of the highest honours to which a citizen could aspire was to obtain a statue.

Statues are formed with the chisel, of several matters, as stone, marble, plaster, &c. They are also cast of various kinds of metal, particularly gold, silver, brass, and lead. For the method of casting statues, see the article *FOUNDERY of Statues*.

Statues are usually distinguished into four general kinds. The first are those less than the life; of which kind we have several statues of great men, of kings, and of gods themselves. The second are those equal to the life; in which manner it was that the ancients, at the public expence, used to make statues of persons eminent for virtue, learning, or the services they had done. The third are those that exceed the life; among which those that surpassed the life once and a half were for kings and emperors; and those double the life, for heroes. The fourth kind were those that exceeded the life twice, thrice, and even more, and were called *colossuses*. See *COLOSSUS*.

Every statue resembling the person whom it is intended to represent, is called *statua iconica*. Statues acquire various other denominations. 1. Thus, allegorical statue is that which, under a human figure, or other symbol, repre-

Stat  
Stat

repre-



Statue  
||  
Stay.

represents something of another kind; as a part of the earth, a season, age, element, temperament, hour, &c. 2. Curule statues, are those which are represented in chariots drawn by bigæ or quadrigæ, that is, by two or four horses; of which kind there were several in the circuses, hippodromes, &c. or in cars, as we see some, with triumphal arches on antique medals. 3. Equestrian statue, that which represents some illustrious person on horseback, as that famous one of Marcus Aurelius at Rome; that of king Charles I. at Charing-cross; King George II in Leicester-Square, &c. 4. Greek statue, denotes a figure that is naked and antique; it being in this manner the Greeks represented their deities, athletæ of the olympic games, and heroes; the statues of heroes were particularly called *Achillean statues*, by reason of the great number of figures of Achilles in most of the cities of Greece. 5. Hydraulic statue, is any figure placed as an ornament of a fountain or grotto, or that does the office of a *jet d'eau*, a cock, spout, or the like, by any of its parts, or by any attribute it holds: the like is to be understood of any animal serving for the same use. 6. Pedestrian statue, a statue standing on foot; as that of king Charles II. in the Royal Exchange, and of king James II. in the Privy-Gardens. 7. Roman statue, is an appellation given to such as are clothed, and which receive various names from their various dresses. Those of emperors, with long gowns over their armour, were called *statue paludata*: those of captains and cavaliers, with coats of arms, *thoracata*; those of soldiers with cuirasses, *loricata*; those of senators and augurs, *trabeata*; those of magistrates with long robes, *togata*; those of the people with a plain tunica, *tunicata*; and, lastly, those of women with long trains, *stolata*.

In repairing a statue cast in a mould, they touch it up with a chisel, graver, or other instrument, to finish the places which have not come well off: they also clear off the barb, and what is redundant in the joints and projectures.

STATUE. See DWARF and GIANT.

STATUTE, in its general sense, signifies a law, ordinance, decree, &c. See LAW, &c.

STATUTE, in our laws and customs, more immediately signifies an act of parliament made by the three estates of the realm; and such statutes are either general, of which the courts at Westminster must take notice without pleading them; or they are special and private, which last must be pleaded.

STAVESACRÉ, in botany; a species of DELPHINIUM.

STAY, a large strong rope employed to support the mast on the fore-part, by extending from its upper end towards the fore part of the ship, as the shrouds are extended to the right and left, and behind it. See MAST, RIGGING, and SHROUD.

The stay of the fore-mast *a*, fig. 3. plate CCLXXVI. which is called the *fore-stay*, reaches from the mast-head towards the bowsprit end: the main stay *b* extends over the fore-castle to the ship's stem; and the mizen-stay *c* is stretched down to that part of the main-mast which lies immediately above the quarter-deck: the fore-top mast stay *d* comes also to the end of the bowsprit, a little beyond the fore-stay: the main-top-mast stay *e* is attached to the head or hounds of the fore-mast; and the mizen-top-mast stay comes also to

the hounds of the main-mast: the fore-top-gallant stay comes to the outer end of the jib-boom; and the main-top gallant stay is extended to the head of the fore-top-mast.

*Star Sail*, a sort of triangular sail extended upon a stay. See SAIL.

STEAM, is the name given in our language to the visible moist vapour which arises from all bodies which contain juices easily expelled from them by heats not sufficient for their combustion. Thus we say, the steam of boiling water, of malt, of a tan-bed, &c. It is distinguished from smoke by its not having been produced by combustion, by not containing any soot, and by its being condensable by cold into water, oil, inflammable spirits, or liquids composed of these.

We see it rise in great abundance from bodies when they are heated, forming a white cloud, which diffuses itself and disappears at no very great distance from the body from which it was produced. In this case the surrounding air is found loaded with the water or other juices which seem to have produced it, and the steam seems to be completely soluble in air, as salt is in water, composing while thus united a transparent elastic fluid.

But in order to its appearance in the form of an opaque white cloud, the mixture with or dissemination in air seem absolutely necessary. If a tea-kettle boils violently, so that the steam is formed at the spout in great abundance, it may be observed, that the visible cloud is not formed at the very mouth of the spout, but at a small distance before it, and that the vapour is perfectly transparent at its first emission. This is rendered still more evident by fitting to the spout of the tea-kettle a glass pipe of any length, and of as large a diameter as we please. The steam is produced as copiously as without this pipe, but the vapour is transparent through the whole length of the pipe. Nay, if this pipe communicate with a glass vessel terminating in another pipe, and if the vessel be kept sufficiently hot, the steam will be as abundantly produced at the mouth of this second pipe as before, and the vessel will be quite transparent. The visibility therefore of the matter which constitutes the steam is an accidental or extraneous circumstance, and requires the admixture with air; yet this quality again leaves it when united with air by solution. It appears therefore to require a dissemination in the air. The appearances are quite agreeable to this notion: for we know that one perfectly transparent body, when minutely divided and diffused among the parts of another transparent body, but not dissolved in it, makes a mass which is visible. Thus oil beat up with water makes a white opaque mass.

In the mean time, as steam is produced, the water gradually wastes in the tea kettle, and will soon be totally expended, if we continue it on the fire. It is reasonable therefore to suppose, that this steam is nothing but water changed by heat into an aerial or elastic form. If so, we should expect that the privation of this heat would leave it in the form of water again. Accordingly this is fully verified by experiment; for if the pipe fitted to the spout of the tea-kettle be surrounded with cold water, no steam will issue, but water will continually trickle from it in drops: and if the process be conducted with the proper precautions, the water which we thus obtain from the pipe will be found equal

Stay,  
Steam.

Definition.

Appears  
like a  
white  
cloudWhen dis-  
seminated  
in air.Is again  
converted  
into water  
by cold.

<sup>5</sup> Steam, equal in quantity to that which disappears from the tea-  
kettle.

Its appear-  
ances ex-  
plained,  
This is evidently the common process for distilling; and the whole appearances may be explained by saying, that the water is converted by heat into an elastic vapour, and that this, meeting with colder air, imparts to it the heat which it carried off as it arose from the heated water, and being deprived of its heat it is again water. The particles of this water being vastly more remote from each other than when they were in the tea-kettle, and thus being disseminated in the air, become visible, by reflecting light from their anterior and posterior surfaces, in the same manner as a transparent salt becomes visible when reduced to a fine powder. This disseminated water being presented to the air in a very extended surface, is quickly dissolved by it, as pounded salt is in water, and again becomes a transparent fluid, but of a different nature from what it was before, being no longer convertible into water by depriving it of its heat.

Accordingly this opinion, or something very like it, has been long entertained. Muschenbroeck expressly says, that the water in the form of vapour carries off with it all the heat which is continually thrown in by the fuel. But Dr Black was the first who attended minutely to the whole phenomena, and enabled us to form distinct notions of the subject. He had discovered that it was not sufficient for converting ice into water that it be raised to that temperature in which it can no longer remain in the form of ice. A piece of ice of the temperature  $32^{\circ}$  of Fahrenheit's thermometer will remain a very long while in air of the temperature  $50^{\circ}$  before it be all melted, remaining all the while of the temperature  $32^{\circ}$ , and therefore continually absorbing heat from the surrounding air. By comparing the time in which the ice had its temperature changed from  $28^{\circ}$  to  $32^{\circ}$  with the subsequent time of its complete liquefaction, he found that it absorbed about 130 or 140 times as much heat as would raise its temperature one degree; and he found that one pound of ice, when mixed with one pound of water 140 degrees warmer, was just melted, but without rising in its temperature above  $32^{\circ}$ . Hence he justly concluded, that water differed from ice of the same temperature by containing, as a constituent ingredient, a great quantity of fire, or of the cause of heat, united with it in such a way as not to quit it for another colder body, and therefore to as not to go into the liquor of the thermometer and expand it. Considered therefore as the possible cause of heat, it was latent, which Dr Black expressed by the abbreviated term LATENT HEAT. If any more heat was added to the water it was not latent, but would readily quit it for the thermometer, and, by expanding the thermometer, would show what is the degree of this redundant heat, while fluidity alone is the indication of the combined and latent heat.

Dr Black, in like manner, concluded, that in order to convert water into an elastic vapour, it was necessary, not only to increase its uncombined heat till its temperature is  $212^{\circ}$ , in which state it is just ready to become elastic; but also to pour into it a great quantity of fire, or the cause of heat, which combines with every particle of it, so as to make it repel, or to recede from, its adjoining particles, and thus to make it a particle of an elastic fluid. He supposed that this additional heat

might be combined with it so as not to quit it for the thermometer; and therefore so as to be in a latent state, having elastic fluidity for its sole indication.

This opinion was very consistent with the phenomenon of boiling off a quantity of water. The application of heat to it causes it gradually to rise in its temperature till it reaches the temperature  $212^{\circ}$ . It then begins to send off elastic vapour, and is slowly expended in this way, continuing all the while of the same temperature. The steam also is of no higher temperature, as appears by holding a thermometer in it. We must conclude that this steam contains all the heat which is expended in its formation. Accordingly the scalding power of steam is well known; but it is extremely difficult to obtain precise measures of the quantity of heat absorbed by water during its conversion into steam. Dr Black endeavoured to ascertain this point, by comparing the time of raising its temperature a certain number of degrees with the time of boiling it off by the same external heat; and he found that the heat latent in steam, which balanced the pressure of the atmosphere, was not less than  $800$  degrees. He also directed Dr Irvine of Glasgow to the form of an experiment for measuring the heat actually extricated from such steam during its condensation in the refrigeratory of a still, which was found to be not less than  $774$  degrees. Dr Black was afterwards informed by Mr Watt, that a course of experiments, which he had made in each of these ways with great precision, determined the latent heat of steam under the ordinary pressure of the atmosphere to be about  $948$  or  $950$  degrees. Mr Watt also found that water would distil with great ease *in vacuo* when of the temperature  $70^{\circ}$ ; and that in this case the latent heat of the steam is not less than  $1200$  or  $1300$  degrees: and a train of experiments, which he had made by distilling in different temperatures, made him conclude that the sum of the sensible and latent heats is a constant quantity. This is a curious and not an improbable circumstance; but we have no information of the particulars of these experiments. The conclusion evidently presupposes a knowledge of that particular temperature in which the water has no heat; but this is a point which is still *sub judice*.

This conversion of liquids (for it is not confined to water, but obtains also in ardent spirits, oils, mercury, &c.) is the cause of their boiling. The heat is applied to the bottom and sides of the vessel, and gradually accumulates in the fluid, in a sensible state, uncombined and ready to quit it and to enter into any body that is colder, and to diffuse itself between them. Thus it enters into the fluid of a thermometer, expands it, and thus gives us the indication of the degree in which it has been accumulated in the water; for the thermometer swells as long as it continues to absorb sensible heat from the water: and when the sensible heat in both is in equilibrio, in a proportion depending on the nature of the two fluids, the thermometer rises no more, because it absorbs no more heat or fire from the water; for the particles of water which are in immediate contact with the bottom, are now (by this gradual expansion of liquidity) at such distance from each other, that their laws of attraction for each other and for heat are totally changed. Each particle either no longer attracts, or perhaps it repels its adjoining particle, and now accumulates round itself a great number of the particles of heat,

Steam. heat, and forms a particle of elastic fluid, so related to the adjoining new formed particles, as to repel them to a distance at least a hundred times greater than their distances in the state of water. Thus a mass of elastic vapour of sensible magnitude is formed. Being at least ten thousand times lighter than an equal bulk of water, it must rise up through it, as a cork would do, in form of a transparent ball or bubble, and getting to the top, it dissipates, filling the upper part of the vessel with vapour or steam. Thus, by tossing the liquid into bubbles, which are produced all over the bottom and sides of the vessel, it produces the phenomenon of ebullition or boiling. Observe, that during its passage up through the water, it is not changed or condensed; for the surrounding water is already so hot that the sensible or uncombined heat in it, is in equilibrio with that in the vapour, and therefore it is not disposed to absorb any of that heat which is combined as an ingredient of this vapour, and gives it its elasticity. For this reason, it happens that water will not boil till its whole mass be heated up to 212°; for if the upper part be colder, it robs the rising bubble of that heat which is necessary for its elasticity, so that it immediately collapses again, and the surface of the water remains still. This may be perceived by holding water in a Florence flask over a lamp or choffer. It will be observed, some time before the real ebullition, that some bubbles are formed at the bottom, and get up a very little way, and then disappear. The distances which they reach before collapsing increase as the water continues to warm farther up the mass, till at last it breaks out into boiling. If the handle of a tea-kettle be grasped with the hand, a tremor will be felt for some little time before boiling, arising from the little succussions which are produced by the collapsing of the bubbles of vapour. This is much more violent, and is really a remarkable phenomenon, if we suddenly plunge a lump of red hot iron into a vessel of cold water, taking care that no red part be near the surface. If the hand be now applied to the side of the vessel, a most violent tremor is felt, and sometimes strong thumps: these arise from the collapsing of very large bubbles. If the upper part of the iron be too hot, it warms the surrounding water so much, that the bubbles from below come up through it uncondensed, and produce ebullition without this succussion. The great resemblance of this tremor to the feeling which we have during the shock of an earthquake has led many to suppose that these last are produced in the same

way, (See EARTHQUAKE, n° 88—98); and their hypothesis, notwithstanding the objections which we have elsewhere stated to it, is by no means unfeasible. It is owing to a similar cause that violent thumps are sometimes felt on the bottom of a tea-kettle, especially one which has been long in use. Such are frequently crushed on the bottom with a stony concretion. This sometimes is detached in little scales. When one of these is adhering by one end to the bottom, the water gets between them in a thin film. Here it may be heated considerably above the boiling temperature, and it suddenly rises up in a large bubble, which collapses immediately. A smooth shilling lying on the bottom will produce this appearance very violently, or a thimble with the mouth down.

In order to make water boil, the fire must be applied to the bottom or sides of the vessel. If the heat be applied at the top of the water, it will wait away without boiling; for the very superficial particles are first supplied with the heat necessary for rendering them elastic, and they fly off without agitating the rest (A).

Since this disengagement of vapour is the effect of its elasticity, and since this elasticity is a determined force when the temperature is given, it follows, that fluids cannot boil till the elasticity of the vapour overcomes the pressure of the incumbent fluid and of the atmosphere. Therefore, when this pressure is removed or diminished, the fluids must sooner overcome what remains, and boil at a lower temperature. Accordingly it is observed that water will boil in an exhausted receiver when of the heat of the human body. If two glass balls A and B (fig. 1.) be connected by a slender tube, and one of them A be filled with water (a small opening or pipe b being left at top of the other), and this be made to boil, the vapour produced from it will drive all the air out of the other, and will at last come out itself, producing steam at the mouth of the pipe. When the ball B is observed to be occupied by transparent vapour, we may conclude that the air is completely expelled. Now shut the pipe by sticking it into a piece of tallow or bees-wax; the vapour in B will soon condense, and there will be a vacuum. The flame of a lamp and blow-pipe being directed to the little pipe, will cause it immediately to close and seal hermetically. We now have a pretty instrument or toy called a PULSE GLASS. Grasp the ball A in the hollow of the hand; the heat of the hand will immediately expand the bubble

And produces the phenomenon of boiling.

Steam. The noise observed in the boiling of a tea-kettle explained.

Water will not boil unless the fire be applied to the bottom or sides of the vessel.

No fluid can boil till the elasticity of the vapour overcome the pressure of the incumbent bodies.

Plate CCCCXXXVII.

(A) We explained the opaque and cloudy appearance of steam, by saying that the vapour is condensed by coming into contact with the cooler air. There is something in the form of this cloud which is very inexplicable. The particles of it are sometimes very distinguishable by the eye; but they have not the smart star like brilliancy of very small drops of water, but give the fainter reflection of a very thin film or vesicle like a soap-bubble. If we attend also to their motion, we see them descending very slowly in comparison with the descent of a solid drop; and this vesicular constitution is established beyond a doubt by looking at a candle through a cloud of steam. It is seen surrounded by a faint halo with prismatical colours, precisely such as we can demonstrate by optical laws to belong to a collection of vesicles, but totally different from the halo which would be produced by a collection of solid drops. It is very difficult to conceive how these vesicles can be formed of watery particles, each of which was surrounded with many particles of fire, now communicated to the air, and how each of these vesicles shall include within it a ball of air; but we cannot refuse the fact. We know, that if, while linseed-oil is boiling or nearly boiling, the surface be obliquely struck with the ladle, it will be dashed into a prodigious number of exceedingly small vesicles, which will float about in the air for a long while. Mr Saussure was (we think) the first who distinctly observed this vesicular form of mists and clouds; and he makes considerable use of it in explaining several phenomena of the atmosphere.

Steam. ble of vapour which may be in it, and this vapour will drive the water into B, and then will blow up through it for a long while, keeping it in a state of violent ebullition, as long as there remains a drop or film of water in A. But care must be taken that B is all the while kept cold, that it may condense the vapour as fast as it rises through the water. Touching B with the hand, or breathing warm on it, will immediately stop the ebullition in it. When the water in A has thus been dissipated, grasp B in the hand; the water will be driven into A, and the ebullition will take place there as it did in B. Putting one of the balls into the mouth will make the ebullition more violent in the other, and the one in the mouth will feel very cold. This is a pretty illustration of the rapid absorption of the heat by the particles of water which are thus converted into elastic vapour. We have seen this little toy suspended by the middle of the tube like a balance, and thus placed in the inside of a window, having two holes *a* and *b* cut in the pane, in such a situation that when A is full of water and preponderates, B is opposite to the hole *b*. Whenever the room became sufficiently warm, the vapour was formed in A, and immediately drove the water into B, which was kept cool by the air coming into the room through the hole *b*. By this means B was made to preponderate in its turn, and A was then opposite to the hole *a*, and the process was now repeated in the opposite direction; and this amusement continued as long as the room was warm enough.

13  
Liquors differ for much in the temperature necessary for their ebullition.

We know that liquors differ exceedingly in the temperatures necessary for their ebullition. This forms the great chemical distinction between volatile and fixed bodies. But the difference of temperature in which they boil, or are converted into permanently elastic vapour, under the pressure of the atmosphere, is not a certain measure of their differences of volatility. The natural boiling point of a body is that in which it will be converted into elastic vapour under no pressure, or *in vacuo*. The boiling point in the open air depends on the law of the elasticity of the vapour in relation to its heat. A fluid A may be less volatile, that is, may require more heat to make it boil *in vacuo*, than a fluid B: But if the elasticity of the vapour of A be more increased by an increase of temperature than that of the vapour of B, A may boil at as low, or even at a lower temperature, in the open air, than B does; for the increased elasticity of the vapour of A may sooner overcome the pressure of the atmosphere. Few experiments have been made on the relation between the temperature and the elasticity of different vapours. So long ago as the year 1765, we had occasion to examine the boiling points of all such liquors as we could manage in an air-pump; that is, such as did not produce vapours which destroyed the valves and the leathers of the pistons: and we thought that the experiments gave us reason to conclude, that the elasticity of all the vapours was affected by heat nearly in the same degree. For we found that the difference between their boiling points in the air and *in vacuo* was nearly the same in all, namely, about 120 degrees of Fahrenheit's thermometer. It is exceedingly difficult to make experiments of this kind: The vapours are so condensable, and change their elasticity so prodigiously by a trifling change of temperature, that it is almost impossible to examine this point with precision. It is, however, as we shall see by and by, a sub-

14  
Difference between their boiling points in air and *in vacuo* about 120°.

ject of considerable practical importance in the mechanic arts; and an accurate knowledge of the relation would be of great use also to the distiller: and it would be no less important to discover the relation of their elasticity and density, by examining their compressibility, in the same manner as we have ascertained the relation in the case of what we call *aerial fluids*, that is, such as we have never observed in the form of liquids or solids, except in consequence of their union with each other or with other bodies. In the article PNEUMATICS we took notice of it as something like a natural law, that all these airs, or gases as they are now called, had their elasticity very nearly, if not exactly proportional to their density. This appears from the experiments of Achar, of Fontana, and others, on vital air, inflammable air, fixed air, and some others. It gives us some presumption to suppose that it holds in all elastic vapours whatever, and that it is connected with their elasticity; and it renders it somewhat probable that they are all elastic, only because the cause of heat (the matter of fire if you will) is elastic, and that their law of elasticity, in respect of density, is the same with that of fire. But it must be observed, that although we thus assign the elasticity of fire as the immediate cause of the elasticity of vapour, in the same way, and on the same grounds, that we ascribe the fluidity of brine to the fluidity of the water which holds the solid salt in solution, it does not follow that this is owing, as is commonly supposed, to a repulsion or tendency to recede from each other exerted by the particles of fire. We are as much entitled to infer a repulsion of unlimited extent between the particles of water; for we see that by its means a single particle of sea-salt becomes disseminated through the whole of a very large vessel. If water had not been a visible and palpable substance, and the salt only had been visible and palpable, we might have formed a similar notion of chemical solution. But we, on the contrary, have considered the *quaquaversum* motion or expansion of the salt as a dissemination among the particles of water; and we have ascribed it to the strong attraction of the atoms of salt for the atoms of water, and the attraction of these last for each other, thinking that each atom of salt accumulates round itself a multitude of watery atoms, and by so doing must recede from the other saline atoms. Nay, we farther see, that by forces which we naturally consider as attractions, an expansion may be produced of the whole mass, which will act against external mechanical forces. It is thus that wood swells with almost insuperable force by imbibing moisture; it is thus that a sponge immersed in water becomes really an elastic compressible body, resembling a blown bladder; and there are appearances which warrant us to apply this mode of conception to elastic fluids.—When air is suddenly compressed, a thermometer included in it shows a rise of temperature; that is, an appearance of heat now redundant which was formerly combined. The heat seems to be squeezed out as the water from the sponge.

15  
To what the elasticity of fluids may be owing.

Accordingly this opinion, that the elasticity of steam and other vapours is owing merely to the attraction for fire, and the consequent dissemination of their particles through the whole mass of fire, has been entertained by many naturalists, and it has been ascribed entirely to attraction. We by no means pretend to decide; but we think the analogy by far too slight to found any

16  
Ascribed by some to attraction, but improperly.

Steam.

confident opinion on it. The aim is to solve phenomena by attraction only, as if it were of more easy conception than repulsion. Considered merely as facts, they are quite on a par. The appearances of nature in which we observe actual recesses of the parts of body from each other, are as distinct, and as frequent and familiar, as the appearances of actual approach. And if we attempt to go farther in our contemplation, and to conceive the way and the forces by which either the approximations or recesses of the atoms are produced, we must acknowledge that we have no conception of the matter; and we can only say, that there is a cause of these motions, and we call it a force, as in every case of the production of motion. We call it attraction or repulsion just as we happen to contemplate an access or a recess. But the analogy here is not only slight, but imperfect, and fails most in those cases which are most simple, and where we should expect it to be most complete. We can squeeze water out of a sponge, it is true, or out of a piece of green wood; but when the white of an egg, the tremella, or some gums, swell to a hundred times their dry dimensions by imbibing water, we cannot squeeze out a particle. If fluidity (for the reasoning must equally apply to this as to vaporousness) be owing to an accumulation of the extended matter of fire, which gradually expanded the solid by its very minute additions; and if the accumulation round a particle of ice, which is necessary for making it a particle of water, be so great in comparison of what gives it the expansion of one degree, as experiment obliges us to conclude—it seems an inevitable consequence that all fluids should be many times rarer than the solids from which they were produced. But we know that the difference is trifling in all cases, and in some (water, for instance, and iron) the solid is rarer than the fluid. Many other arguments (each of them perhaps of little weight when taken alone, but which are all systematically connected) concur in rendering it much more probable that the matter of fire, in causing elasticity, acts immediately by its own elasticity, which we cannot conceive in any other way than as a mutual tendency in its particles to recede from each other; and we doubt not but that, if it could be obtained alone, we should find it an elastic fluid like air. We even think that there are cases in which it is observed in this state. The elastic force of gunpowder is very much beyond the elasticity of all the vapours which are produced in its deflagration, each of them being expanded as much as we can reasonably suppose by the great heat to which they are exposed. The writer of this article exploded some gunpowder mixed with a considerable portion of finely powdered quartz, and another parcel mixed with fine filings of copper. The elasticity was measured by the penetration of the ball which was discharged, and was great in the degree now mentioned. The experiment was so conducted, that much of the quartz and copper was collected; none of the quartz had been melted, and some of the copper was not melted. The heat, therefore, could not be such as to explain the elasticity by expansion of the vapours; and it became not improbable that fire was acting here as a detached chemical fluid by its own elasticity. But to return to our subject.

There is one circumstance in which we think our own experiments show a remarkable difference (at least in degree) between the condensible and incondensibles.

VOL. XVII. Part II.

vapours. It is well known, that when air is very suddenly expanded, cold is produced, and heat when it is suddenly condensed. When making experiments with the hopes of discovering the connection between the elasticity and density of the vapours of boiling water, and also of boiling spirits of turpentine, we found the change of density accompanied by a change of temperature vastly greater than in the case of incoercible gases. When the vapour of boiling water was suddenly allowed to expand into five times its bulk, we observed the depression of a large and sensible air thermometer to be at least four or five times greater than in a similar expansion of common air of the same temperature. The chemical reader will readily see reasons for expecting, on the contrary, a smaller alteration of temperature, both on account of the much greater rarity of the fluid, and on account of a partial condensation of its water, and the consequent disengagement of combined heat.

This difference in the quantity of fire which is combined in vapours and gases is so considerable as to authorize us to suppose that there is some difference in the chemical constitution of vapours and gases, and that the connection between the specific bases of the vapour and the fire which it contains is not the same in air, for instance, as in the vapour of boiling water; and this difference may be the reason why the one is easily condensible by cold, while the other has never been exhibited in a liquid or solid form, except by means of its chemical union with other substances. In this particular instance we know that there is an essential difference—that in vital or atmospheric air there is not only a prodigious quantity of fire which is not in the vapour of water, but that it also contains light, or the cause of light, in a combined state. This is fully evinced by the great discovery of Mr Cavendish of the composition of water. Here we are taught that water (and consequently its vapour) consists of air from which the light and greatest part of the fire have been separated. And the subsequent discoveries of the celebrated Lavoisier show, that almost all the condensibles gases with which we are acquainted consist either of airs which have already lost much of their fire (and perhaps light too), or of matters in which we have no evidence of fire or light being combined in this manner.

This consideration may go far in explaining this difference in the condensibility of these different species of aerial fluids, the gases and the vapours; and it is with this qualification only that we are disposed to allow that all bodies are condensible into liquids or solids by abstracting the heat. In order that vital air may become liquid or solid, we hold that it is not sufficient that a body be presented to it which shall simply abstract its heat. This would only abstract its uncombined fire.—But another, and much larger portion remains chemically combined by means of light. A chemical affinity must be brought into action which may abstract, not the fire from the oxygen (to speak in the language of Mr Lavoisier), but the oxygen from the fire and light. And our production is not the detached basis of air, but detached heat and light, and the formation of an oxyd of some kind.

To prosecute the chemical consideration of STEAMS GENERAL farther than these general observations, which are applicable to all, would be almost to write a treatise of chemistry, and would be a repetition of many things which have been treated of in sufficient detail in other

Steam.

18  
Probably a great difference between condensibles and incondensibles vapours;

19  
And also some difference in the chemical constitution of vapour.

17  
More probably owing to a mutual repulsion between the particles of fire.

**Steam.** articles of this work. We shall therefore conclude this article with some other observations, which are also general, with respect to the different kinds of coercible vapours, but which have a particular relation to the following article.

20  
Steam rises at different temperatures, according as the air is heavy or light,

Steam or vapour is an elastic fluid, whose elasticity balances the pressure of the atmosphere; and it has been produced from a solid or liquid body raised to a sufficient temperature for giving it this elasticity; that is, for causing the fluid to boil. This temperature must vary with the pressure of the air. Accordingly it is found, that when the air is light (indicated by the barometer being low), the fluid will boil sooner. When the barometer stands at 30 inches, water boils at the temperature 212°. If it stand so low as 28 inches, water will boil at 208½. In the plains of Quito, or at Gondar in Abyssinia, where the barometer stands at about 21 inches, water will boil at 195°. Highly rectified alcohol will boil at 160°, and vitriolic æther will boil at 88° or 89°. This is a temperature by no means uncommon in these places; nay, the air is frequently warmer. Vitriolic æther, therefore, is a liquor which can hardly be known in those countries. It is hardly possible to preserve it in that form. If a phial have not its stopper firmly tied down, it will be blown out, and the liquor will boil and be dissipated in steam. On the top of Chimboracao, the human blood must be disposed to give out air-bubbles.

21  
As fluids boil under the pressure of the vapour which ascends from them, the conclusion mentioned in n° 14, is only a gross approximation.

We said some time ago, that we had concluded, from some experiments made in the receiver of an air-pump, that fluids boil *in vacuo* at a temperature nearly 120 degrees lower than that necessary for their boiling in the open air. But we now see that this must have been but a gross approximation; for in these experiments the fluids were boiling under the pressure of the vapour which they produced, and which could not be abstracted by working the pump. It appears from the experiments of Lord Charles Cavendish, mentioned in the article PNEUMATICS, that water of the temperature 72° was converted into elastic vapour, which balanced a pressure of ½ths of an inch of mercury, and in this state it occupied the receiver, and did not allow the mercury in the gauge to sink to the level. As fast as this was abstracted by working the air-pump, more of it was produced from the surface of the water, so that the pressure continued the same, and the water did not boil. Had it been possible to produce a vacuum above this water, it would have boiled for a moment, and would even have continued to boil, if the receiver could have been kept very cold.

22  
Account of experiments to determine the relation between the temperature of vapour and its elasticity.

Upon reading these experiments, and some very curious ones of Mr Nairne, in the Phil. Trans. vol. lxvii. the writer of this article was induced to examine more particularly the relation between the temperature of the vapour and its elasticity, in the following manner:

ABCD (fig. 2.) is the section of a small digester made of copper. Its lid, which is fastened to the body with serews, is pierced with three holes, each of which had a small pipe soldered into it. The first hole was furnished with a brass safety-valve V, nicely fitted to it by grinding. The area of this valve was exactly ¼th of an inch. There rested on the stalk at top of this valve the arm of a steelyard carrying a sliding weight. This arm had a scale of equal parts, so adjusted to the weight that the number on the scale corresponded to the inches of mercury, whose pressure on the under surface of the

valve is equal to that of the steelyard on its top; so that when the weight was at the division 10, the pressure of the steelyard on the valve was just equal to that of a column of mercury 10 inches high and ¼th of an inch base. The middle hole contained a thermometer T firmly fixed into it, so that no vapour could escape by its sides. The ball of this thermometer was but a little way below the lid. The third hole received occasionally the end of a glass-pipe SGF, whose descending leg was about 36 inches long. When this syphon was not used, the hole was properly shut with a plug.

The vessel was half filled with distilled water which had been purged of air by boiling. The lid was then fixed on, having the third hole S plugged up. A lamp being placed under the vessel, the water boiled, and the steam issued copiously by the safety-valve. The thermometer stood at 213, and a barometer in the room at 29.9 inches. The weight was then put on the fifth division. The thermometer immediately began to rise; and when it was at 220, the steam issued by the sides of the valve. The weight was removed to the 10th division; but before the thermometer could be distinctly observed, the steam was issuing at the valve. The lamp was removed farther from the bottom of the vessel, that the progress of heating might be more moderate; and when the steam ceased to issue from the valve, the thermometer was at 227. The weight was now shifted to 15; and by gradually approaching the lamp, the steam again issued, and the thermometer was at 132½. This mode of trial was continued all the way to the 75th division of the scale. The experiments were then repeated in the contrary order; that is, the weight being suspended at the 75th division, and the steam issuing strongly at the valve, the lamp was withdrawn, and the moment the steam ceased to come out, the thermometer was observed. The same was done at the 70th, 65th, division, &c. These experiments were several times repeated both ways; and the means of all the results for each division are expressed in the following table, where column 1st expresses the elasticity of the steam, being the sum of 29.9, and the division of the steelyard; column 2d expresses the temperature of the steam corresponding to this elasticity.

I.	II
35 inches.	219°
40	226
45	232
50	237
55	242
60	247
65	251
70	255
75	259
80	263
85	267
90	270½
95	274½
100	278
105	281

A very different process was necessary for ascertaining the elasticity of the steam in lower temperatures, and consequently under smaller pressures than that of the atmosphere. The glass syphon SGF was now fixed into its hole in the lid of the digester. The water was made to boil smartly for some time, and the steam issued copiously both at the valve and at the syphon.

lower

Steam

Steam. lower end of the syphon was now immersed into a broad saucer of mercury, and the lamp instantly removed, and every thing was allowed to grow cold. By this the steam was gradually condensed, and the mercury rose in the syphon, without sensibly sinking in the saucer. The valve and all the joints were smeared with a thick clammy cement, composed of oil, tallow, and rosin, which effectually prevented all ingress of air. The weather was clear and frosty, the barometer standing at 29,84, and the thermometer in the vessel at 42°. The mercury in the syphon stood at 29,7, or somewhat higher, thus showing a very complete condensation. The whole vessel was surrounded with pounded ice, of the temperature 32°. This made no sensible change in the height of the mercury. A mark was now made at the surface of the mercury. One observer was stationed at the thermometer, with instructions to call out as the thermometer reached the divisions 42, 47, 52, 57, and so on by every five degrees till it should attain the boiling heat. Another observer noted the corresponding descents of the mercury by a scale of inches, which had its beginning placed at 29,84 from the surface of the mercury in the saucer.

The pounded ice was now removed, and the lamp placed at a considerable distance below the vessel, so as to warm its contents very slowly. These observations being very easily made, were several times repeated, and their mean results are set down in the following table: Only observe, that it was found difficult to note down the descents for every fifth degree, because they succeeded each other so fast. Every 10th was judged sufficient for establishing the law of variation. The first column of the table contains the temperature, and the second the descent (in inches) of the mercury from the mark 29,84.

Temp.	Descent (inches)
32°	0
40	0,1
50	0,2
60	0,35
70	0,55
80	0,82
90	1,18
100	1,61
110	2,25
120	3,00
130	3,95
140	5,15
150	6,72
160	8,65
170	11,05
180	14,05
190	17,85
200	22,62
210	28,65

Four or five numbers at the top of the column of elasticities are not so accurate as the others, because the mercury passed pretty quickly through these points. But the progress was extremely regular through the remaining points; so that the elasticities corresponding to temperatures above 70° may be considered as very accurately ascertained.

Not being altogether satisfied with the method employed for measuring the elasticity in temperatures above that of boiling water, a better form of experiment was adopted. (Indeed it was the want of other apparatus which made it necessary to employ the former). A glass

tube was procured of the form represented in fig. 3. having a little cistern L, from the top and bottom of which proceeded the syphons K and MN. The cistern contained mercury, and the tube MN was of a slender bore, and was about six feet two inches long. The end K was firmly fixed in the third hole of the lid, and the long leg of the syphon was furnished with a scale of inches, and firmly fastened to an upright post.

The lamp was now applied at such a distance from the vessel as to warm it slowly, and make the water boil, the steam escaping for some time through the safety valve. A heavy weight was then suspended on the steelyard; such as it was known that the vessel would support, and at the same time, such as would not allow the steam to force the mercury out of the long tube. The thermometer began immediately to rise, as also the mercury in the tube MN. Their correspondent stations are marked in the following table:

Temp.	Elast.
212°	0,0
220	5,9
230	14,6
240	25,0
250	36,9
260	50,4
270	64,2
280	106,0

This form of the experiment is much more susceptible of accuracy than the other, and the measures of elasticity are more to be depended on. In repeating the experiment, they were found much more constant; whereas, in the former method, differences occurred of two inches and upwards.

We may now connect the two sets of experiments into one table, by adding to the numbers in this last table the constant height 29,9, which was the height of the mercury in the barometer during the last set of observations.

Temp.	Elast.
32°	0,0
40	0,1
50	0,2
60	0,35
70	0,55
80	0,82
90	1,25
100	1,6
110	2,25
120	3,0
130	3,95
140	5,15
150	6,72
160	8,65
170	11,05
180	14,05
190	17,85
200	22,62
210	28,65
220	35,8
230	44,7
240	54,9
250	66,8
260	80,3
270	94,1
280	105,9

Steam.  
23  
Which agree well with those of Mr Achard.

In the memoirs of the Royal Academy of Berlin for 1782, there is an account of some experiments made by Mr Achard on the elastic force of steam, from the temperature 32° to 212°. They agree extremely well with those mentioned here, rarely differing more than two or three tenths of an inch. He also examined the elasticity of the vapour produced from alcohol, and found, that when the elasticity was equal to that of the vapour of water, the temperature was about 35° lower. Thus, when the elasticity of both was measured by 28,1 inches of mercury, the temperature of the watery vapour was 209°, and that of the spirituous vapour was 173°. When the elasticity was 18,5, the temperature of the water was 189,5, and that of the alcohol 154,6. When the elasticity was 11,05, the water was 168°, and the alcohol 134°,4. Observing the difference between the temperatures of equally elastic vapours of water and alcohol not to be constant, but gradually to diminish, in Mr Achard's experiments, along with the elasticity, it became interesting to discover whether and at what temperature this difference would vanish altogether. Experiments were accordingly made by the writer of this article, similar to those made with water. They were not made with the same scrupulous care, nor repeated as they deserved, but they furnished rather an unexpected result. The following table will give the reader a distinct notion of them :

Temp.	Elast.
32°	0,0
40	0,1
60	0,8
80	c,8
100	3,9
120	6,9
140	12,2
160	21,3
180	34,
200	52,4
220	78,5
240	115,

24  
An unexpected result in comparing the temperatures of equally elastic vapours of water and alcohol.

We say that the result was unexpected ; for as the natural boiling point seemed by former experiments to be in all fluids about 120° or more below their boiling point in the ordinary pressure of the atmosphere, it was reasonable to expect that the temperature at which they ceased to emit sensibly elastic steam would have some relation to their temperatures when emitting steam of any determinate elasticity. Now as the vapour of alcohol of elasticity 30 has its temperature about 36° lower than the temperature of water equally elastic, it was to be expected that the temperature at which it ceased to be sensibly affected would be several degrees lower than 32°. It is evident, however, that this is not the case. But this is a point that deserves more attention, because it is closely connected with the chemical relation between the element (if such there be) of fire and the bodies into whose composition it seems to enter as a constituent part. What is the temperature 32°, to make it peculiarly connected with elasticity ? It is a temperature assumed by us for our own convenience, on account of the familiarity of water in our experiments. Æther, we know, boils in a temperature far below this, as appears from Dr Cullen's experiments narrated in the *Essays Physical and Literary of Edinburgh*. On the faith of former experiments, we may be pretty certain that it will boil in vacuo at the tem-

perature -14°, because in the air it boils at +106°. Therefore we may be certain, that the steam or vapour of æther, when of the temperature 32°, will be very sensibly elastic. Indeed Mr Lavoisier says, that if it be exposed in an exhausted receiver in winter, its vapour will support mercury at the height of 10 inches. A series of experiments on this vapour similar to the above would be very instructive. We even wish that those on alcohol were more carefully repeated. If we draw a curve line, of which the abscissa is the line of temperatures, and the ordinates are the corresponding heights of the mercury in these experiments on water and alcohol, we shall observe, that although they both sensibly coincide at 32°, and have the abscissa for their common tangent, a very small error of observation may be the cause of this, and the curve which expresses the elasticity of spirituous vapour may really intersect the other, and go backwards considerably beyond 32°.

This range of experiments gives rise to some curious and important reflections. We now see that no particular temperature is necessary for water assuming the form of permanently elastic vapour ; and that it is highly probable that it assumes this form even at the temperature 32° ; only its elasticity is too small to afford us any sensible measure. It is well known that even ice evaporates (see experiments to this purpose by Mr Wilson in the *Philosophical Transactions*, when a piece of polished metal covered with hoar-frost became perfectly clear by exposing it to a dry frosty wind).

Even mercury evaporates, or is converted into elastic vapour, when all external pressure is removed. The thin film which may frequently be observed in the upper part of a barometer which stands near a stream of air, is found to be small globules of mercury sticking to the inside of the tube. They may be seen by the help of a magnifying glass, and are the best test of a well made barometer. They will be entirely removed by causing the mercury to rise along the tube. It will lick them all up. They consist of mercury which had evaporated in the void space, and was afterwards condensed by the cold glass. But the elasticity is too small to occasion a sensible depression of the column, even when considerably warmed by a candle.

Many philosophers accordingly imagine, that spontaneous evaporation in low temperatures is produced in this way. But we cannot be of this opinion, and must still think that this kind of evaporation is produced by the dissolving power of the air. When moist air is suddenly rarefied, there is always a precipitation of water. This is most distinctly seen when we work an air-pump briskly. A mist is produced, which we see plainly fall to the bottom of the receiver. But by this new doctrine the very contrary should happen, because the tendency of water to appear in the elastic form is promoted by removing the external pressure ; and we really imagine that more of it now actually becomes simple elastic watery vapour. But the mist or precipitation shows incontrovertibly, that there had been a previous solution. Solution is performed by forces which act in the way of attraction ; or, to express it more safely, solutions are accompanied by the mutual approaches of the particles of the menstruum and solvent : all such tendencies are *observed* to increase by a diminution of distance. Hence it *must* follow, that air of double density will dissolve more than twice as much water. Therefore when we suddenly rarefy saturated air (even tho'

Steam

25  
These experiments give rise to important reflections

Vol. 1x

26  
Spontaneous evaporation produced by the dissolving power of the air



its heat should not diminish) some water must be let go. What may be its quantity we know not; but it may be more than what would now become elastic by this diminution of surrounding pressure; and it is not unlikely but this may have some effect in producing the vesicles which we found so difficult to explain. These may be filled with pure watery vapour, and be floating in a fluid composed of water dissolved in air. An experiment of Fontana's seems to put this matter out of doubt. A distilling apparatus AB (fig. 4.) was so contrived, that the heat was applied above the surface of the water in the alembic A. This was done by inclosing it in another vessel CC, filled with hot water. In the receiver B there was a sort of barometer D, with an open cistern, in order to see what pressure there was on the surface of the fluid. While the receiver and alembic contained air, the heat applied at A produced no sensible distillation during several hours: But on opening a cock E in the receiver at its bottom, and making the water in the alembic to boil, steam was produced which soon expelled all the air, and followed it through the cock. The cock was now shut, and the whole allowed to grow cold by removing the fire, and applying cold water to the alembic. The barometer fell to a level nearly. Then warm water was allowed to get into the outer vessel CC. The barometer rose a little, and the distillation went on briskly without the smallest ebullition in the alembic. The conclusion is obvious: while there was air in the receiver and communicating pipe, the distillation proceeded entirely by the dissolving power of this air. Above the water in the alembic it was quickly saturated; and this saturation proceeded slowly along the still air in the communicating pipe, and at last might take place thro' the whole of the receiver. The sides of the receiver being kept cold, should condense part of the water dissolved in the air in contact with them, and this should trickle down the sides and be collected. But any person who has observed how long a crystal of blue vitriol will lie at the bottom of a glass of still water before the tinge will reach the surface, will see that it must be next to impossible for distillation to go on in these circumstances; and accordingly none was observed. But when the upper part of the apparatus was filled with pure watery vapour, it was supplied from the alembic as fast as it was condensed in the receiver, just as in the pulle glass.

27  
A certain law in the dilatation of aeriform fluids by heat.

Another inference which may be drawn from these experiments is, that Nature seems to affect a certain law in the dilatation of aeriform fluids by heat. They seem to be dilatable nearly in proportion of their present dilatation. For if we suppose that the vapours resemble air, in having their elasticity in any given temperature proportional to their density, we must suppose that if steam of the elasticity 60, that is, supporting 60 inches of mercury, were subjected to a pressure of 30 inches, it would expand into twice its present bulk. The augmentation of elasticity therefore is the measure of the bulk into which it would expand in order to acquire its former elasticity. Taking the increase of elasticity therefore as a measure of the bulk into which it would expand under one constant pressure, we see that equal increments of temperature produce nearly equal multiplications of bulk. Thus if a certain diminution of temperature diminishes its bulk

1/2th, another equal diminution of temperature will diminish this new bulk 1/2th very nearly. Thus, in our experiments, the temperatures 110°, 140°, 170°, 200°, 230°, are in arithmetical progression, having equal differences; and we see that the corresponding elasticities 2, 25, 5, 15, 11, 05, 22, 62, 44, 7, are very nearly in the continued proportion of 1 to 2. The elasticity corresponding to the temperature 260 deviates considerably from this law, which would give 83 or 84 instead of 80; and the deviation increases in the higher temperatures. But still we see that there is a considerable approximation to this law; and it will frequently assist us to recollect, that whatever be the present temperature, an increase of 30 degrees doubles the elasticity and the bulk of watery vapour.

Steam.

That 4° will increase the elasticity from 1 to 1 1/15			
8	-	-	1 to 1 1/5
10	-	-	1 to 1 1/4
12 1/2	-	-	1 to 1 1/3
18	-	-	1 to 1 1/2
22	-	-	1 to 1 2/3
24	-	-	1 to 1 3/4
26	-	-	1 to 1 4/5

This is sufficiently exact for most practical purposes. Thus an engineer finds that the injection cools the cylinder of a steam-engine to 192°. It therefore leaves a steam whose elasticity is 1/2th of its full elasticity, = 18 inches  $\phi$ . But it is better at all times to have recourse to the table. Observe, too, that in the lower temperatures, *i. e.* below 110°, this increment of temperature does more than double the elasticity.

This law obtains more remarkably in the incoercible vapours; such as vital air, atmospheric air, fixed air, &c. all of which have also their elasticity proportional to their bulk inversely: and perhaps the deviation from the law in steams is connected with their chemical difference of constitution. If the bulk were always augmented in the same proportion by equal augmentations of temperature, the elasticities would be accurately represented by the ordinates of a logarithmic curve, of which the temperatures are the corresponding abscissæ; and we might contrive such a scale for our thermometer, that the temperatures would be the common logarithms of the elasticities, or of the bulks having equal elasticity; or, with our present scale, we may find such a multiplier *m* for the number *x* of degrees of our thermometer (above that temperature where the elasticity is equal to unity), that this multiple shall be the common logarithm of the elasticity *y*; so that  $m \times x = \log. y$ .

29  
Obtains more remarkably in the incoercible vapours.

But our experiments are not sufficiently accurate for determining the temperature where the elasticity is measured by 1 inch; because in these temperatures the elasticities vary by exceedingly small quantities. But if we take 11,04 for the unit of elasticity, and number our temperature from 170°, and make  $m = 0,010035$ , we shall find the product  $m \times x$  to be very nearly the logarithm of the elasticity. The deviations, however, from this law, are too great to make this equation of any use. But it is very practicable to frame an equation which shall correspond with the experiments to any degree of accuracy; and it has been done for air in a translation of General Roy's Measurement of the Base at Hounslow Heath into French by Mr Prony. It is as follows; Let *x* be the degrees of Reaumur's

Steam. thermometer; let  $y$  be the expansion of 10,000 parts of air; let  $e$  be = 10,  $m = 2,7976$ ,  $n = 0,01768$ : then  $y = e^{m+n \times x} - 627,5$ . Now  $e$  being = 10, it is plain that  $e^{m+n \times x}$  is the number, of which  $m + n \times x$  is the common logarithm. This formula is very exact as far as the temperature  $60^\circ$ : but beyond this it needs a correction; because air, like the vapour of water, does not expand in the exact proportion of its bulk.

29 And is con- We observe this law considerably approximated to in siderably the augmentation of the bulk or elasticity of elastic vapours; that is, it is a fact that a given increment of temperature makes very nearly the same proportional augmentation of bulk and elasticity. This gives us some notion of the manner in which the supposed expanding cause produces the effect. When vapour of the bulk 4 is expanded into a bulk 5 by an addition of 10 degrees of sensible heat, a certain quantity of fire goes into it, and is accumulated round each particle, in such a manner that the temperature of each, which formerly was  $m$ , is now  $m + 10$ . Let it now receive another equal augmentation of temperature. This is now  $m + 20$ , and

the bulk is  $\frac{5 \times 5}{4}$  or  $6\frac{1}{4}$ , and the arithmetical increase of bulk is  $1\frac{1}{4}$ . The absolute quantity of fire which has entered it is greater than the former, both on account of the greater augmentation of space and the greater temperature. Consequently if this vapour be compressed into the bulk 5, there must be heat or fire in it which is not necessary for the temperature  $m + 20$ , far less for the temperature  $m + 10$ . It must therefore emerge, and be disposed to enter a thermometer which has already the temperature  $m + 20$ : that is, the vapour must grow hotter by compression; not by squeezing out the heat, like water out of a sponge, but because the law of attraction for heat is deranged. It would be a very valuable acquisition to our knowledge to learn with precision the quantity of sensible heat produced in this way; but no satisfactory experiments have yet been made. M. Lavoisier, with his chemical friends and colleagues, were busily employed in this inquiry; but the wickedness of their countrymen has deprived the world of this and many other important additions which we might have expected from this celebrated and unfortunate philosopher. He had made, in conjunction with M. de la Place, a numerous train of accurate and expensive experiments for measuring the quantity of latent or combined heat in elastic vapours. This is evidently a very important point to the distiller and practical chemist. This heat must all come from the

Steam. fuel; and it is greatly worth while to know whether any saving may be made of this article. Thus we know that distillation will go on either under the pressure of the air, or in an alembic and receiver from which the air has been expelled by steam; and we know that this last may be conducted in a very low temperature, even not exceeding that of the human body. But it is uncertain whether this may not employ even a greater quantity of fuel, as well as occasion a great expence of time. We are disposed to think, that when there is no air in the apparatus, and when the condensation can be speedily performed, the proportion of fuel expended to the fluid which comes over will diminish continually as the heat, and consequently the density of the steam, is augmented; because in this case the quantity of combined heat must be less. In the mean time, we earnestly recommend the trial of this mode of distillation in vessels cleared of air. It is undoubtedly of great advantage to be able to work with smaller fires; and it would secure us against all accidents of blowing off the head of the still, often attended with terrible consequences (B). We must not conclude this article without taking notice of some natural phenomena which seem to owe their origin to the action of elastic steam.

We have already taken notice of the resemblance of the tremor and successions observed in the shocks of many earthquakes to those which may be felt in a vessel where water is made to boil internally, while the breaking out of the ebullition is stifled by the cold of the upper parts; and we have likewise stated the objections which are usually made to this theory of earthquakes. We may perhaps resume the subject under the article VOLCANO; but in the mean time we do not hesitate to say, that the wonderful appearances of the Geyzer spring in Iceland (see HVER; and ICELAND, n<sup>o</sup> 3-5.) are undoubtedly produced by the expansion of steam in ignited caverns. Of these appearances we suppose the whole train to be produced as follows.

30 A cavern may be supposed of a shape analogous to Explan- CBDEF (fig. 5.), having a perpendicular funnel AB tion of the issuing from a depressed part of the roof. The part F phenomena of the Gey- zer spring in Iceland may be lower than the rest, remote, and red-hot. Such places we know to be frequent in Iceland. Water may be continually trickling into the part CD. It will fill by the force of steam. it up to B, and even up to Ee, and then trickle slowly along into F. As soon as any gets into contact with an ignited part, it expands into elastic steam, and is partly condensed by the cold sides of the cavern, which it gradually warms, till it condenses no more. This produc

(B) We earnestly recommend this subject to the consideration of the philosopher. The laws which regulate the formation of elastic vapour, or the general phenomena which it exhibits, give us that link which connects chemistry with mechanical philosophy. Here we see chemical affinities and mechanical forces set in immediate opposition to each other, and the one made the indication, characteristic, and measure of the other. We have not the least doubt that they make but one science, the Science of Universal Mechanics; nor do we despair of seeing the phenomena of solution, precipitation, crystallization, fermentation, nay animal and vegetable secretion and assimilation, successfully investigated, as cases of local motion, and explained by the agency of central forces. Some thing of this kind, and that not inconsiderable, was done when Dr Cullen first showed how the double affinities might be illustrated by the assistance of numbers. Dr Black gave to this hint (for it was little more) that elegant precision which characterizes all his views. Mr Kirwan has greatly promoted this study by his numerous and ingenious examples of its application; and the most valuable passages of the writings of Mr Lavoisier, are those where he traces with logical precision the balancings of force which appear in the chemical phenomena. It is from the similar balancings and consequent measurements, which may be observed and obtained in the present case, that we are to hope for admission into this almost unbounded science of contemplation. We have another link equally interesting and promising, viz. the production of heat by friction. This also highly deserves the consideration of the mathematical philosopher.

Steam-Engine.

production of steam hinders not in the smallest degree the trickling of more water into F, and the continual production of more steam. This now presses on the surface of the water in CD, and causes it to rise gradually in the funnel BA; but slowly, because its cold surface is condensing an immense quantity of steam. We may easily suppose that the water trickles faster into F than it is expended in the production of steam; so that it reaches farther into the ignited part, and may even fall in a stream into some deeper pit highly ignited. It will now produce steam in vast abundance, and of prodigious elasticity; and at once push up the water thro' the funnel in a solid jet, and to a great height. This must continue till the surface of the water sinks to BD. If the lower end of the funnel have any inequalities or notches, as is most likely, the steam will get admision along with the water, which in this particular place is boiling hot, being superficial, and will get to the mouth of the funnel, while water is still pressed in below. At last the steam gets in at B on all sides; and as it is converging to B, along the surface of the water, with prodigious velocity it sweeps along with it much water, and blows it up through the funnel with great force. When this is over, the remaining steam blows out unmixed with water, growing weaker as it is expended, till the bottom of the funnel is again stopped by the water increasing in the cavern CBD. All the phenomena above ground are perfectly conformable to the necessary consequences of this very probable construction of the cavern. The feeling of being lifted up, immediately before the jet, in all probability is owing to a real heaving up of the whole roof of the cavern by the first expansion of the great body of steam. We had an accurate description of the phenomena from persons well qualified to judge of these matters who visited these celebrated springs in 1789.

*STEAM-Engine*, is the name of a machine which derives its moving power from the elasticity and condensibility of the steam of-boiling water. It is the most valuable present which the arts of life have ever received from the philosopher. The mariner's compass, the telescope, gunpowder, and other most useful servants to human weakness and ingenuity, were the productions of chance, and we do not exactly know to whom we are indebted for them; but the steam-engine was, in the very beginning, the result of reflection, and the production of a very ingenious mind; and every improvement it has received, and every alteration in its construction and principles, were also the results of philosophical study.

Steam-engine invented by the Marquis of Worcester.

The steam-engine was beyond all doubt invented by the marquis of Worcester during the reign of Cha. II. This nobleman published in 1663 a small book intitled *A CENTURY OF INVENTIONS*; giving some obscure and enigmatical account of an hundred discoveries or contrivances of his own, which he extols as of great importance to the public. He appears to have been a person of much knowledge and great ingenuity; but his description or accounts of these inventions seem not so much intended to instruct the public, as to raise wonder; and his encomiums on their utility and importance are to a great degree extravagant, resembling more the puff of an advertising tradesman than the patriotic communications of a gentleman. The marquis of Wor-

Steam-Engine.

cester was indeed a projector, and very impotunate and mysterious withal in his applications for public encouragement. His account, however, of the steam-engine, although by no means fit to give us any distinct notions of its structure and operation, is exact as far as it goes, agreeing precisely with what we now know of the subject. It is N 68. of his inventions. His words are as follow: "This admirable method which I propose of raising water by the force of fire has no bounds if the vessels be strong enough: for I have taken a cannon, and having filled it  $\frac{3}{4}$  this full of water, and shut up its muzzle and touch-hole, and exposed it to the fire for 24 hours, it burst with a great explosion. Having afterwards discovered a method of fortifying vessels internally, and combined them in such a way that they filled and acted alternately, I have made the water spout in an uninterrupted stream 40 feet high; and one vessel of rarefied water raised 40 of cold water. The person who conducted the operation had nothing to do but turn two cocks; so that one vessel of water being consumed, another begins to force, and then to fill itself with cold water, and so on in succession."

It does not appear that the noble inventor could ever interest the public by these accounts. His character as a projector, and the many failures which persons of this turn of mind daily experience, probably prejudiced people against him, and prevented all attention to his projects. It was not till towards the end of the century, when experimental philosophy was prosecuted all over Europe with uncommon ardour, that these notions again engaged attention. Captain Savary, a person also of great ingenuity and ardent mind, saw the reality and practicability of the marquis of Worcester's project. He knew the great expansive power of steam, and had discovered the inconceivable rapidity with which it is reconverted into water by cold; and he soon contrived a machine for raising water, in which both of these properties were employed. He says, that it was entirely his own invention. Dr Defaguliers insists that he only copied the marquis's invention, and charges him with gross plagiarism, and with having bought up and burned the copies of the marquis's book, in order to secure the honour of the discovery to himself. This is a very grievous charge, and should have been substantiated by very distinct evidence. Defaguliers produces none such; and he was much too late to know what happened at that time. The argument which he gives is a very foolish one, and gave him no title to consider Savary's experiment as a falsehood; for it might have happened precisely as Savary relates, and not as it happened to Defaguliers. The fact is, that Savary obtained his patent of invention after a hearing of objections, among which the discovery of the marquis of Worcester was not mentioned: and it is certain that the account given in the *Century of Inventions* could instruct no person who was not sufficiently acquainted with the properties of steam to be able to invent the machine himself.

3: Captain Savary obtained his patent *after having actually erected* several machines, of which he gave a description in a book intitled *THE MINER'S FRIEND*, published in 1696, and in another work published in 1699. Much about this time Dr Papin, a Frenchman and fellow of the Royal Society, invented a method of dissolving bones and other animal solids in water, by confining them

But first reduced to practice by Captain Savary.

3: Papin has no claim to the invention as he French pre-stand.

Steam-  
Engine.

them in close vessels, which he called **DIGESTERS**, so as to acquire a great degree of heat. For it must be observed in this place, that it had been discovered long before (in 1684) by Dr Hooke, the most inquisitive experimental philosopher of that inquisitive age, that water could not be made to acquire above a certain temperature in the open air; and that as soon as it begins to boil, its temperature remains fixed, and an increase of heat only produces a more violent ebullition, and a more rapid waste. But Papin's experiments made the elastic power of steam very familiar to him: and when he left England and settled as professor of mathematics at Marpurgh, he made many awkward attempts to employ this force in mechanics, and even for raising water. It appears that he had made experiments with this view in 1698, by order of Charles Landgrave of Hesse. For this reason the French affect to consider him as the inventor of the steam-engine. He indeed published some account of his invention in 1707; but he acknowledges that Captain Savary had also, and without any communication with him, invented the same thing. Whoever will take the trouble of looking at the description which he has given of these inventions, which are to be seen in the *Acta Eruditorum*, *Lipsiæ*, and in Leupold's *Theatrum Machinarum*, will see that they are most awkward, absurd, and impracticable. His conceptions of natural operations were always vague and imperfect, and he was neither philosopher nor mechanic.

We are thus anxious about the claim of those gentlemen, because a most respectable French author, Mr Boffut, says in his *Hydrodynamique*, that the first notion of the steam-engine was *certainly* owing to Dr Papin, who had not only invented the digester, but had in 1695 published a little performance describing a machine for raising water, in which the pistons are moved by the vapour of boiling water alternately dilated and condensed. Now the fact is, that Papin's first publication was in 1707, and his piston is nothing more than a floater on the surface of the water, to prevent the waste of steam by condensation; and the return of the piston is not produced, as in the steam-engine, by the condensation of the steam, but by admitting the air and a column of water to press it back into its place. The whole contrivance is so awkward, and so unlike any distinct notions of the subject, that it cannot do credit to any person. We may add, that much about the same time Mr Amontons contrived a very ingenious but intricate machine, which he called a *fire-wheel*. It consisted of a number of buckets placed in the circumference of a wheel, and communicating with each other by very intricate circuitous passages. One part of this circumference was exposed to the heat of a furnace, and another to a stream or cistern of cold water. The communications were so disposed, that the steam produced in the buckets on one side of the wheel drove the water into buckets on the other side, so that one side of the wheel was always much heavier than the other; and it must therefore turn round, and may execute some work. The death of the inventor, and the intricacy of the machine, caused it to be neglected. Another member of the Parisian academy of sciences (Mr Deslandes) also presented to the academy a project of a steam-wheel, where the impulsive force of the vapour was employed; but it met with no encouragement.

4  
Mr Amontons's fire-wheel.

The English engineers had by this time so much improved Savary's first invention, that it supplanted all others. We have therefore no hesitation in giving the honour of the first and complete invention to the marquis of Worcester; and we are not disposed to refuse Captain Savary's claim to originality as to the construction of the machine, and even think it probable that his own experiments made him see the whole independent of the marquis's account.

Captain Savary's engine, as improved and simplified by himself, is as follows.

A (fig. 6.) represents a strong copper boiler properly built up in a furnace. There proceeds from its top a large steam-pipe B, which enters into the top of another strong vessel R called the **RECEIVER**. This pipe has a cock at C called the **STEAM-COCK**. In the bottom of the receiver is a pipe F, which communicates sidewise with the rising pipe KGH. The lower end H of this pipe is immersed in the water of the pit or well, and its upper part K opens into the cistern into which the water is to be delivered. Immediately below the pipe of communication F there is a valve G, opening when pressed from below, and shutting when pressed downwards. A similar valve is placed at I, immediately above the pipe of communication. Lastly, there is a pipe ED which branches off from the rising pipe, and enters into the top of the receiver. This pipe has a cock D called the **INJECTION-COCK**. The mouth of the pipe ED has a nozzle *f* pierced with small holes, pointing from a centre in every direction. The keys of the two cocks C and D are united, and the handle *g b* is called the **REGULATOR**.

Let the regulator be so placed that the steam-cock C is open and the injection-cock D is shut; put water into the boiler A, and make it boil strongly. The steam coming from it will enter the receiver, and gradually warm it, much steam being condensed in producing this effect. When it has been warmed so as to condense no more, the steam proceeds into the rising pipe; the valve G remains shut by its weight; the steam lifts the valve I, and gets into the rising pipe, and gradually warms it. When the workman feels this to be the case, or hears the rattling of the valve I, he immediately turns the steam-cock so as to shut it, the injection-cock still remaining shut (at least we may suppose this for the present). The apparatus must now cool, and the steam in the receiver collapses into water. There is nothing now to balance the pressure of the atmosphere; the valve I remains shut by its weight; but the air incumbent on the water in the pit presses up this water through the suction-pipe HG, and causes it to lift the valve G, and flow into the receiver R, and fill it to the top, if not more than 20 or 25 feet above the surface of the pit water.

The steam-cock is now opened. The steam which, during the cooling of the receiver, has been accumulating in the boiler, and acquiring a great elasticity by the action of the fire, now rushes in with great violence, and, pressing on the surface of the water in the receiver, causes it to shut the valve G and open the valve I by its weight alone, and it now flows into the rising pipe, and would stand on a level if the elasticity of the steam were no more than what would balance the atmospheric pressure. But it is much more than this, and therefore is *press'd* the water out of the receiver into the rising pipe;

Steam-  
Engine.5  
Captain Savary's steam-engine described.Plate  
ccccxxxv

Steam-Engine.

pipe, and will even cause it to come out at K, if the elasticity of the steam is sufficiently great. In order to ensure this, the boiler has another pipe in its top, covered with a *safety-valve* V, which is kept down by a weight W suspended on a steelyard L M. This weight is so adjusted that its pressure on the safety-valve is somewhat greater than the pressure of a column of water V k as high as the point of discharge K. The fire is so regulated that the steam is always issuing a little by the loaded valve V. The workman keeps the steam-valve open till he hears the valve I rattle. This tells him that the water is all forced out of the receiver, and that the steam is now following it. He immediately turns the regulator which shuts the steam-cock, and now, for the first time, opens the injection-cock. The cold water trickles at first through the holes of the nozzle f, and falling down through the steam, begins to condense it; and then its elasticity being less than the pressure of the water in the pipe K E D f, the cold water spouts in all directions through the nozzle, and, quick as thought, produces a complete condensation. The valve G now opens again by the pressure of the atmosphere on the water of the pit, and the receiver is soon filled with cold water. The injection-cock is now shut, and the steam-cock opened, and the whole operation is now repeated; and so on continually.

This is the simple account of the process, and will serve to give the reader an introductory notion of the operation; but a more minute attention must be paid to many particulars before we can see the properties and defects of this ingenious machine.

6  
defects of  
this ma-  
chine such,

The water is driven along the rising pipe by the elasticity of the steam. This must in the boiler and every part of the machine, exert a pressure on every square inch of the vessels equal to that of the upright column of water. Suppose the water to be raised 100 feet, about 25 of this may be done in the suction-pipe; that is, the upper part of the receiver may be about 25 feet above the surface of the pit-water. The remaining 75 must be done by forcing, and every square inch of the boiler will be squeezed out by a pressure of more than 30 pounds. This very moderate height therefore requires very strong vessels; and the Marquis of Worcester was well aware of the danger of their bursting. A copper boiler of six feet diameter must be  $\frac{3}{8}$ ths of an inch thick to be just in equilibrio with this pressure: and the soldered joint will not be able to withstand it, especially in the high temperature to which the water must be heated in order to produce steam of sufficient elasticity. By consulting the table of the elasticity of steam deduced from our experiments mentioned in the preceding article, we see that this temperature must be at least 280° of Fahrenheit's thermometer. In this heat soft solder is just ready to melt, and has no tenacity; even spelter solder is considerably weakened by it. Accordingly, in a machine erected by Captain Savary at York Buildings in London, the workman having loaded the safety-valve a little more than usual to make the engine work more briskly, the boiler burst with a dreadful explosion, and blew up the furnace and adjoining parts of the building as if it had been gunpowder. Mr Savary succeeded pretty well in raising moderate quantities of water to small heights, but could make nothing of deep mines. Many attempts were made, on the Marquis's principle, to

Steam-Engine.

strengthen the vessels from within by radiated bars and by hoops, but in vain. Very small boilers or evaporators were then tried, kept red hot, or nearly so, and supplied with a slender stream of water trickling into them; but this afforded no opportunity of making a collection of steam during the refrigeration of the receiver, so as to have a magazine of steam in readiness for the next forcing operation; and the working of such machines was always an employment of great danger and anxiety.

The only situation in which this machine could be employed with perfect safety, and with some effect, was where the whole lift did not exceed 30 or 35 feet. In this case the greatest part of it was performed by the suction-pipe, and a very manageable pressure was sufficient for the rest. Several machines of this kind were erected in England about the beginning of this century. A very large one was erected at a salt-work in the south of France. Here the water was to be raised no more than 18 feet. The receiver was capacious, and it was occasionally supplied with steam from a small salt-pan constructed on purpose with a cover. The entry of the steam into the receiver merely allowed the water to run out of it by a large valve, which was opened by the hand, and the condensation was produced by the help of a small forcing pump also worked by the hand. In particular a situation as this (and many such may occur in the endless variety of human wants), this is a very powerful engine; and having few moving and rubbing parts, it must be of great durability. This circumstance has occasioned much attention to be given to this first form of the engine, even long after it was supplanted by those of a much better construction. A very ingenious attempt was made very lately to adapt this construction to the uses of the miners. The whole depth of the pit was divided into lifts of 15 feet, in the same manner as is frequently done in pump-machines. In each of these was a suction-pipe 14 feet long, having above it a small receiver like R, about a foot high, and its capacity somewhat greater than that of the pipe. This receiver had a valve at the head of the suction-pipe, and another opening outwards into the little cistern, into which the next suction-pipe above dipped to take in water. Each of these receivers sent up a pipe from its top, which all met in the cover of a large vessel above ground, which was of double the capacity of all the receivers and pipes. This vessel was close on all sides. Another vessel of equal capacity was placed immediately above it, with a pipe from its bottom passing through the cover of the lower vessel and reaching near to its bottom. This upper vessel communicates with the boiler, and constitutes the receiver of the steam-engine. The operation is as follows: The lower vessel is full of water. Steam is admitted into the upper vessel, which expels the air by a valve, and fills the vessel. It is then condensed by cold water. The pressure of the atmosphere would cause it to enter by all the suction-pipes of the different lifts, and press on the surface of the water in the lower receiver, and force it into the upper one. But because each suction-pipe dips in a cistern of water, the air presses this water before it, raises it into each of the little receivers which it fills, and allows the spring of the air (which was formerly in them, but which now passes up into the lower receiver) to force the water out of the lower receiver into the

7  
That it can  
be employ-  
ed with  
a manage-  
able pres-  
sure in cer-  
tain situa-  
tions.

Steam-Engine.

upper one. When this has been completed, the steam is again admitted into the upper receiver. This allows the water to run back into the lower receiver, and the air returns into the small receivers in the pit, and allows the water to run out of each into its proper cistern. By this means the water of each pipe has been raised 15 feet. The operation may thus be repeated continually.

The contrivance is ingenious, and similar to some which are to be met with in the hydraulics of Schottus, Stermius, and other German writers. But the operation must be exceedingly slow; and we imagine that the expence of steam must be great, because it must fill a very large and very cold vessel, which must waste a great portion of it by condensation. We see by some late publications of the very ingenious Mr Blackey, that he is still attempting to maintain the reputation of this machine by some contrivance of this kind; but we imagine that they will be ineffectual, except in some very particular situations.

8  
Occasions great waste of steam and fuel.

For the great defect of the machine, even when we can secure it against all risk of bursting, is the prodigious waste of steam, and consequently of fuel. Daily experience shows, that a few scattered drops of cold water is sufficient for producing an almost instantaneous condensation of a great quantity of steam. Therefore when the steam is admitted into the receiver of Savary's engine, and comes into contact with the cold top and cold water, it is condensed with great rapidity; and the water does not begin to subside till its surface has become so hot that it condenses no more steam. It may now begin to yield to the pressure of the incumbent steam; but as soon as it descends a little, more of the cold surface of the receiver comes into contact with the steam, and condenses more of it, and the water can descend no farther till this addition of cold surface is heated up to the state of evaporation. This rapid condensation goes on all the while the water is descending. By some experiments frequently repeated by the writer of this article, it appears that no less than  $\frac{1}{4}$ ths of the whole steam is uselessly condensed in this manner, and not more than  $\frac{1}{7}$ th is employed in allowing the water to descend by its own weight; and he has reason to think that the portion thus wasted will be considerably greater, if the steam be employed to force the water out of the receiver to any considerable height.

Observe, too, that all this waste must be repeated in every succeeding stroke; for the whole receiver must be cooled again in order to fill itself with water.

9  
The attempts made to diminish this waste are unsuccessful.

Many attempts have been made to diminish this waste; but all to little purpose, because the very filling of the receiver with cold water occasions its sides to condense a prodigious quantity of steam in the succeeding stroke. Mr Blackey has attempted to lessen this by using two receivers. In the first was oil; and into this only the steam was admitted. This oil passed to and fro between the two receivers, and never touched the water except in a small surface. But this hardly produced a sensible diminution of the waste: for it must now be observed, that there is a necessity for the first cylinder's being cooled to a considerable degree below the boiling point; otherwise, though it will condense much steam, and allow the water to rise into the receiver, there will be a great diminution of the height of suction, unless the vessel be much cooled. This appears plainly

by inspecting the table of elasticity. Thus, if the vessel be cooled no lower than 180°, we should lose one half of the pressure of the atmosphere; if cooled to 120°, we should still lose  $\frac{1}{3}$ th. The inspection of this table is of great use for understanding and improving this noble machine; and without a constant recollection of the elasticity of steam corresponding to its actual heat, we shall never have a notion of the niceties of its operation.

The rapidity with which the steam is condensed is really astonishing. Experiments have been made on steam-vessels of six feet in diameter and seven feet high; and it has been found, that about four ounces of water, as warm as the human blood, will produce a complete condensation in less than a second; that is, will produce all the condensation that it is capable of producing, leaving an elasticity about  $\frac{1}{3}$ th of the elasticity of the air. In another experiment with the same steam-vessel, no cold water was allowed to get into it, but it was made to communicate by a long pipe four inches in diameter with another vessel immersed in cold water. The condensation was so rapid that the time could not be measured: it certainly did not exceed half a second. Now this condensation was performed by a very trifling surface of contact. Perhaps we may explain it a little in this way: When a mass of steam, in immediate contact with the cold water, is condensed, it leaves a void, into which the adjoining steam instantly expands; and by this very expansion its capacity for heat is increased, or it grows cold, that is, abstracts the heat from the steam situated immediately beyond it. And in this expansion and refrigeration it is itself partly condensed or converted into water, and leaves a void, into which the circumjacent steam immediately expands, and produces the same effect on the steam beyond it. And thus it may happen that the abstraction of a small quantity of heat from an inconsiderable mass of steam may produce a condensation which may be very extensive. Did we know the change made in the capacity of steam for heat by a given change of bulk, we should be able to tell exactly what would be the effect of this local actual condensation. But experiment has not as yet given us any precise notions on this subject. We think that this rapid condensation to a great distance by a very moderate actual abstraction of heat is a proof that the capacity of steam for heat is prodigiously increased by expansion. We say a *very moderate actual abstraction* of heat, because very little heat is necessary to raise four ounces of blood-warm water to a boiling temperature, which will unfit it for condensing steam. The remarkable phenomenon of snow and ice produced in the Hungarian machine, when the air condensed in the receiver is allowed to blow through the cock (see PNEUMATICS), shows this to be the case in moist air, that is, in air holding water in a state of chemical solution. We see something very like it in a thunder-storm. A small black cloud sometimes appears in a particular spot, and in a very few seconds spreads over many hundred acres of sky, that is, a precipitation of water goes on with that rapid diffusion. We imagine that this increase of capacity or demand for heat, and the condensation that must ensue if this demand is not supplied, is much more remarkable in pure watery vapours, and that this is a capital distinction of their constitution from vapours dissolved in air.

Steam-Engine.

to  
The actual  
filling  
the w  
which  
remains  
condens

Steam-Engine.

The reader must now be so well acquainted with what passes in the steam-veffel, and with the exterior results from it, as readily to comprehend the propriety of the changes which we shall now describe as having been made in the construction and principle of the steam-engine.

11  
Attempts  
to improve  
the steam-  
engine.

Of all places in England the tin-mines of Cornwall stood most in need of hydraulic assistance; and Mr Savary was much engaged in projects for draining them by his steam-engine. This made its construction and principles well known among the machinists and engineers of that neighbourhood. Among these were a Mr Newcomen, an iron-monger or blacksmith, and Mr Cawley a glazier at Dartmouth in Devonshire, who had dabbled much with this machine. Newcomen was a person of some reading, and was in particular acquainted with the person, writings, and projects of his countryman Dr Hooke. There are to be found among Hooke's papers, in the possession of the Royal Society, some notes of observations, for the use of Newcomen his countryman, on Papin's boasted method of transmitting to a great distance the action of a mill by means of pipes. Papin's project was to employ the mill to work two air-pumps of great diameter. The cylinders of these pumps were to communicate by means of pipes with equal cylinders furnished with pistons, in the neighbourhood of a distant mine. These pistons were to be connected, by means of levers, with the piston-rods of the mine. Therefore, when the piston of the air-pump at the mill was drawn up by the mill, the corresponding piston at the side of the mine would be pressed down by the atmosphere, and thus would raise the piston-rod in the mine, and draw the water. It would appear from these notes, that Dr Hooke had dissuaded Mr Newcomen from erecting a machine on this principle, of which he had exposed the fallacy in several discourses before the Royal Society. One passage is remarkable. "Could he (meaning Papin) make a speedy vacuum under your second piston, your work is done."

It is highly probable that, in the course of this speculation, it occurred to Mr Newcomen that the vacuum he so much wanted might be produced by steam, and that this gave rise to his new principle and construction of the steam-engine. The specific desideratum was in Newcomen's mind; and therefore, when Savary's engine appeared, and became known in his neighbourhood many years after, he would readily catch at the help which it promised.

Savary however claims the invention as his own; but Switzer, who was personally acquainted with both, is positive that Newcomen was the inventor. By his principles (as a quaker) being averse from contention, he was contented to share the honour and the profits with Savary, whose acquaintance at court enabled him to procure the patent in 1705, in which all the three were associated. Posterity has done justice to the modest inventor, and the machine is universally called NEWCOMEN'S ENGINE. Its principle and mode of operation may be clearly conceived as follows.

12  
Description  
New-  
comen's.

Let A (fig. 7.) represent a great boiler properly built in a furnace. At a small height above it is a cylinder CBBC of metal, bored very truly and smoothly. The boiler communicates with this cylinder by means of the throat or steam-pipe NQ. The lower aperture of this pipe is shut by the plate N, which is

ground very flat, so as to apply very accurately to the whole circumference of the orifice. This plate is called the regulator or steam-cock, and it turns horizontally round an axis *ba* which passes through the top of the boiler, and is nicely fitted to the socket, like the key of a cock, by grinding. The upper end of this axis is furnished with a handle *b T*.

Steam-Engine.

A piston P is suspended in this cylinder, and made air-tight by a packing of leather or soft rope, well filled with tallow; and, for greater security, a small quantity of water is kept above the piston. The piston-rod PD is suspended by a chain which is fixed to the upper extremity F of the arched head FD of the great lever or WORKING BEAM HK, which turns on the rudgeon O. There is a similar arched head EG at the other end of the beam. To its upper extremity E is fixed a chain carrying the pump-rod XL, which raises the water from the mine. The load on this end of the beam is made to exceed considerably the weight of the piston P at the other extremity.

At some small height above the top of the cylinder is a cistern W called the INJECTION CISTERN. From this descends the INJECTION PIPE ZSR, which enters the cylinder through its bottom, and terminates in a small hole R, or sometimes in a nozzle pierced with many smaller holes diverging from a centre in all directions. This pipe has at S a cock called the INJECTION COCK, fitted with a handle V.

At the opposite side of the cylinder, a little above its bottom, there is a lateral pipe, turning upwards at the extremity, and there covered by a clack-valve *f*, called the SNIFFING VALVE, which has a little dish round it to hold water for keeping it air-tight.

There proceeds also from the bottom of the cylinder a pipe *deg b* (passing behind the boiler), of which the lower end is turned upwards, and is covered with a valve *h*. This part is immersed in a cistern of water Y, called the HOT WELL, and the pipe itself is called the EDUCTION PIPE. Lastly, the boiler is furnished with a safety-valve called the PUPPET CLACK (which is not represented in this sketch for want of room), in the same manner as Savary's engine. This valve is generally loaded with one or two pounds on the square inch, so that it allows the steam to escape when its elasticity is  $\frac{1}{3}$  greater than that of common air. Thus all risk of bursting the boiler is avoided, and the pressure outwards is very moderate; so also is the heat. For, by inspecting the table of vaporous elasticity, we see that the heat corresponding to 32 inches of elasticity is only about 216° of Fahrenheit's thermometer.

These are all the essential parts of the engine, and are here drawn in the most simple form, till our knowledge of their particular offices shall show the propriety of the peculiar forms which are given to them. Let us now see how the machine is put in motion, and what is the nature of its work.

The water in the boiler being supposed to be in a state of strong ebullition, and the steam issuing by the safety-valve, let us consider the machine in a state of rest, having both the steam-cock and injection cock shut. The resting position or attitude of the machine must be such as appears in this sketch, the pump rods preponderating, and the great piston being drawn up to the top of the cylinder. Now open the steam cock by turning the handle T of the regulator. The steam from the boiler

13  
How the  
machine  
is put in  
motion,  
and the nature  
of the  
work.

Steam-Engine.

boiler will immediately rush in, and flying all over the cylinder, will mix with the air. Much of it will be condensed by the cold surface of the cylinder and piston, and the water produced from it will trickle down the sides, and run off by the eduction-pipe. This condensation and waste of steam will continue till the whole cylinder and piston are made as hot as boiling water. When this happens, the steam will begin to open the snifting valve *f*, and issue through the pipe; slowly at first and very cloudy, being mixed with much air. The blast at *f* will grow stronger by degrees, and more transparent, having already carried off the greatest part of the common air which filled the cylinder. We supposed that the water was boiling briskly, so that the steam was issuing by the safety-valve which is in the top of the boiler, and through every crevice. The opening of the steam-cock puts an end to this at once, and it has sometimes happened that the cold cylinder abstracts the steam from the boiler with such astonishing rapidity, that the pressure of the atmosphere has burst up the bottom of the boiler. We may here mention an accident of which we were witnesses, which also shows the immense rapidity of the condensation. The boiler was in a frail shed at the side of the engine-house; a sheet of snow from the top of the house fell down and broke through the roof of the shed, and was scattered over the head of the boiler, which was of an oblong or oval shape. In an instant the sides of it were squeezed together by the pressure of the atmosphere.

When the manager of the engine perceives that not only the blast at the snifting valve is strong and steady, but that the boiler is now fully supplied with steam of a proper strength, appearing by the renewal of the discharge at the safety-valve, he shuts the steam-cock, and opens the injection cock *S* by turning its handle *V*. The pressure of the column of water in the injection-pipe *ZS* immediately forces some water through the spout *R*. This coming in contact with the pure vapour which now fills the cylinder, condenses it, and thus makes a partial void, into which the more distant steam immediately expands, and by expanding collapses (as has been already observed). What remains in the cylinder no longer balances the atmospherical pressure on the surface of the water in the injection-cistern, and therefore the water spouts rapidly through the hole *R* by the joint action of the column *ZS* and the unbalanced pressure of the atmosphere; at the same time the snifting valve *f* and the eduction-valve *b* are shut by the unbalanced pressure of the atmosphere. The velocity of the injection water must therefore rapidly increase, and the jet will dash (if single) against the bottom of the piston, and be scattered through the whole capacity of the cylinder. In a very short space of time, therefore, the condensation of the steam becomes universal, and the elasticity of what remains is almost nothing. The whole pressure of the atmosphere is exerted in the upper surface of the piston, while there is hardly any on its under side. Therefore, if the load on the outer end *E* of the working beam is inferior to this pressure, it must yield to it. The piston *P* must descend, and the pump piston *L* must ascend, bringing along with it the water of the mine, and the motion must continue till the great piston reaches the bottom of the cylinder; for it is not like the motion which would take place in a cylinder of air rarefied to the same degree. In this last case, the im-

PELLING force would be continually diminished, because the capacity of the cylinder is diminished by the descent of the piston, and the air in it is continually becoming more dense and elastic. The piston would stop at a certain height, where the elasticity of the included air, together with the load at *E*, would balance the atmospherical pressure on the piston. But when the contents of the cylinder are pure vapour, and the continued stream of injected cold water keeps down its temperature to the same pitch as at the beginning, the elasticity of the remaining steam can never increase by the descent of the piston, nor exceed what corresponds to this temperature. The impelling or accelerating force therefore remains the same, and the descent of the piston will be uniformly accelerated, if there is not an increase of resistance arising from the nature of the work performed by the other end of the beam. This circumstance will come under consideration afterwards, and we need not attend to it at present. It is enough for our present purpose to see, that if the cylinder has been completely purged of common air before the steam-cock was shut, and if none has entered since, the piston will descend to the very bottom of the cylinder. And this may be frequently observed in a good steam-engine where every part is air-tight. It sometimes happens, by the pit pump drawing air, or some part of the communication between the two trains giving way, that the piston comes down with such violence as to knock out the bottom of the cylinder with the blow.

The only observation which remains to be made on the motion of the piston in descending is, that it does not begin at the instant the injection is made. The piston was kept at the top by the preponderancy of the outer end of the working beam, and it must remain there till the difference between the elasticity of the steam below it and the pressure of the atmosphere exceeds this preponderancy. There must therefore be a small space of time between the beginning of the condensation and the beginning of the motion. This is very small, not exceeding the third or the fourth part of a second; but it may be very distinctly observed by an attentive spectator. He will see, that the instant the injection-cock is opened, the cylinder will sensibly rise upwards a little by the pressure of the air on its bottom. Its whole weight is not nearly equal to this pressure; and instead of its being necessary to support it by a strong floor, we must keep it down by strong joists loaded by heavy walls. It is usual to frame these joists into the posts which carry the axis of the working-beam, and are therefore loaded with the whole strain of the machine. This rising of the cylinder shows the instantaneous commencement of the condensation; and it is not till after this has been distinctly observed that the piston is seen to start, and begin to descend.

When the manager sees the piston as low as he thinks proper, he shuts the injection-cock, and opens the steam-cock. The steam has been accumulating above the water in the boiler during the whole time of the piston's descent, and is now rushing violently through the puppet clack. The moment therefore that the steam-cock is opened, it rushes violently into the cylinder, having an elasticity greater than that of the air. It therefore immediately blows open the snifting valve, and allows (at least) the water which had come in by the former injection, and what arose from the conden-

Steam-Engine.

14  
The piston does not begin to descend the moment the injection is made.

15  
The circumstances that succeed the descent of the piston.



Steam-Engine.

fed steam, to descend by its own weight through the eduction-pipe *d e g h* to open the valve *b*, and to run out into the hot well. And we must easily see that this water is boiling hot; for while lying in the bottom of the cylinder, it will condense steam till it acquires this temperature, and therefore cannot run down till it condenses no more. There is still a waste of steam at its first admission, in order to heat the inside of the cylinder and the injected water to the boiling temperature: but the space being small, and the whole being already very warm, this is very soon done; and when things are properly constructed, little more steam is wanted than what will warm the cylinder; for the eduction-pipe receives the injection water even during the descent of the piston, and it is therefore removed pretty much out of the way of the steam.

16  
Effect of the first puff of entering steam

This first puff of the entering steam is of great service: it drives out of the cylinder the vapour which it finds there. This is seldom pure watery vapour: all water contains a quantity of air in a state of chemical union. The union is but feeble, and a boiling heat is sufficient for disengaging the greatest part of it by increasing its elasticity. It may also be disengaged by simply removing the external pressure of the atmosphere. This is clearly seen when we expose a glass of water in an exhausted receiver. Therefore the small space below the piston contains watery vapour mixed with all the air which had been disengaged from the water in the boiler by ebullition, and all that was separated from the injection water by the diminution of external pressures. All this is blown out of the cylinder by the first puff of steam. We may observe in this place, that waters differ exceedingly in the quantity of air which they hold in a state of solution. All spring water contains much of it: and water newly brought up from deep mines contains a great deal more, because the solution was aided in these situations by great pressures. Such waters sparkle when poured into a glass. It is therefore of great consequence to the good performance of a steam-engine to use water containing little air, both in the boiler and in the injection-cistern. The water of running brooks is preferable to all others, and the freer it is from any saline impregnation it generally contains less air. Such engines as are so unfortunately situated that they are obliged to employ the very water which they have brought up from great depth, are found greatly inferior in their performance to others. The air collected below the piston greatly diminishes the accelerating force, and the expulsion of such a quantity requires a long continued blast of the bell steam at the beginning of every stroke. It is advisable to keep such water in a large shallow pond for a long while before using it.

17  
Of great consequence to the good performance of a steam-engine, that the water employed contain little air.18  
How the piston rises.

Let us now consider the state of the piston. It is evident that it will start or begin to rise the moment the steam-cock is opened; for at that instant the excess of atmospherical pressure, by which it was kept down in opposition to the preponderancy of the outer end of the beam, is diminished. The piston is therefore dragged upwards, and it will rise even although the steam which is admitted be not so elastic as common air. Suppose the mercury in the barometer to stand at 30 inches, and that the preponderancy at the outer end of the beam is  $\frac{1}{3}$ th of the pressure of the air on the piston, the piston will not rise if the elasticity of the steam is not equal to

$30 - \frac{10}{3}$ , that is, to 26,7 inches nearly; but if it is just this quantity, the piston will rise as fast as this steam can be supplied through the steam-pipe, and the velocity of its ascent depends entirely on the velocity of this supply. This observation is of great importance; and it does not seem to have occurred to the mathematicians, who have paid most attention to the mechanism of the motion of this engine. In the mean time, we may clearly see that the entry of the steam depends chiefly on the counter weight at E: for suppose there was none, steam no stronger than air would not enter the cylinder at all; and if the steam be stronger, it will enter only by the excess of its strength. Writers on the steam-engine (and even some of great reputation) familiarly speak of the steam giving the piston a push: But this is scarcely possible. During the rise of the piston the snifting valve is never observed to blow; and we have not heard any well attested accounts of the piston-chains ever being slackened by the upward pressure of the steam, even at the very beginning of the stroke. During the rising of the piston the steam is (according to the common conception and manner of speaking) sucked in, in the same way that air is sucked into a common syringe or pump when we draw up the piston; for in the steam-engine the piston is really drawn up by the counter weight. But it is still more sucked in, and requires a more copious supply, for another reason. As the piston descended only in consequence of the inside of the cylinder's being sufficiently cooled to condense the steam, this cooled surface must again be presented to the steam during the rise of the piston, and must condense steam a second time. The piston cannot rise another inch till the part of the cylinder which the piston has already quitted has been warmed up to the boiling point, and steam must be expended in this warming. The inner surface of the cylinder is not only of the heat of boiling water while the piston rises, but is also perfectly dry; for the film of water left on it by the ascending piston must be completely evaporated, otherwise it will be condensing steam. That the quantity thus wasted is considerable, appears by the experiments of Mr Beighton. He found that five pints of water were boiled off in a minute, and produced 16 strokes of an engine whose cylinder contained 113 gallons of 282 inches each; and he thence concluded that steam was 2886 times rarer than water. But in no experiment made with scrupulous care on the expansion of boiling water

Steam-Engine.

does it appear that the density of steam exceeds  $\frac{1}{10,000}$ th of the density of water. Desaguliers says that it is above 14,000 times rarer than water. We have frequently attempted to measure the weight of steam which filled a very light vessel, which held 12,000 grains of water, and found it always less than one grain; so that we have no doubt of its being much more than 10,000 times rarer than water. This being the case, we may safely suppose that the number of gallons of steam, instead of being 16 times 113, were nearly five times as much; and that only  $\frac{1}{3}$ th were employed in allowing the piston to rise, and the remaining  $\frac{2}{3}$ ths were employed to warm the cylinder.

The moving force during the ascent of the piston must be considered as resulting chiefly, if not solely, from the preponderating weight of the piston-rods. The office of this is to return the steam-piston to the top piston-rods.

19

Steam-Engine.

top of the cylinder, where it may again be pressed down by the air, and make another working stroke by raising the pump rods. But the counter-weight at E has another service to perform in this use of the engine; namely, to return the pump pistons into their places at the bottom of their respective working barrels, in order that they also may make a working stroke. This requires force independent of the friction and inertia of the moving parts; for each piston must be pushed down through the water in the barrel, which must rise through the piston with a velocity whose proportion to the velocity of the piston is the same with that of the bulk of the piston to the bulk of the perforation through which the water rises through the piston. It is enough at present to mention this in general terms: we shall consider it more particularly afterwards, when we come to calculate the performance of the engine, and to deduce from our acquired knowledge maxims of construction and improvement.

20  
The ascent of the piston differs greatly from the descent.

From this general consideration of the ascent of the piston, we may see that the motion differs greatly from the descent. It can hardly be supposed to accelerate, even if the steam in the cylinder were in a moment annihilated. For the resistance to the descent of the piston is the same with the weight of the column of water, which would cause it to flow through the box of the pump piston with the velocity with which it really rises through it, and must therefore increase as the square of that velocity increases; that is, as the square of the velocity of the piston increases. Independent of friction, therefore, the velocity of descent through the water must soon become a maximum, and the motion become uniform. We shall see by and by, that in such a pump as is generally used this will happen in less than the 10th part of a second. The friction of the pump will diminish this velocity a little, and retard the time of its attaining uniformity. But, on the other hand, the supply of steam which is necessary for this motion, being susceptible of no acceleration from its previous motion, and depending entirely on the briskness of the ebullition, an almost instantaneous stop is put to acceleration.

21  
The counter weight is different during the two motions of the pump-rods.

Accordingly, any person who observes with attention the working of a steam-engine, will see that the rise of the piston and descent of the pump-rods is extremely uniform, whereas the working stroke is very sensibly accelerated. Before quitting this part of the subject, and lest it should afterwards escape our recollection, we may observe, that the counter weight is different during the two motions of the pump-rods. While the machine is making a working stroke, it is lifting not only the column of water in the pump, but the absolute weight of the pistons and piston-rods also: but while the pump-rods are descending, there is a diminution of the counter weight by the whole weight lost by the immersion of the rod in water. The wooden rods which are generally used, soaked in water, and joined by iron straps, are heavier, and but a little heavier than water, and they are generally about one-third of the bulk of the water in the pumps.

These two motions complete the period of the operation; and the whole may be repeated by shutting the steam-cock and opening the injection-cock whenever the piston has attained the proper height. We have been very minute in our attention to the different circumstances, that the reader may have a distinct notion of

the state of the moving forces in every period of the operation. It is by no means sufficient that we know in general that the injection of cold water makes a void which allows the air to press down the piston, and that the readmission of the steam allows the piston to rise again. This lumping and slovenly way of viewing it has long prevented even the philosopher from seeing the defects of the construction, and the methods of removing them.

We now see the great difference between Savary's and Newcomen's engine in respect of principle. Savary's was really an engine which raised water by the force of steam; but Newcomen's raises water entirely by the pressure of the atmosphere, and steam is employed merely as the most expeditious method of producing a void, into which the atmospherical pressure may impel the *first mover* of his machine. The elasticity of the steam is not the first mover.

We see also the great superiority of this new machine. We have no need of steam of great and dangerous elasticity; and we operate by means of very moderate heats, and consequently with much smaller quantities of fuel; and there is no bounds to the power of this machine. How deep soever a mine may be, a cylinder may be employed of such dimensions that the pressure of the air on its piston may exceed in any degree the weight of the column of water to be raised. And lastly, this form of the machine renders it applicable to almost every mechanical purpose; because a skilful mechanic can readily find a method of converting the reciprocating motion of the working beam into a motion of any kind which may suit his purpose. Savary's engine could hardly admit of such an immediate application, and seems almost restricted to raising water.

Inventions improve by degrees. This engine was first offered to the public in 1705. But many difficulties occurred in the execution, which were removed one by one; and it was not till 1712 that the engine seemed to give confidence in its efficacy. The most exact and unremitting attention of the manager was required to the precise moment of opening and shutting the cocks; and neglect might frequently be ruinous, by beating out the bottom of the cylinder, or allowing the piston to be wholly drawn out of it. Stops were contrived to prevent both of these accidents; then strings were used to connect the handles of the cocks with the beam, so that they should be turned whenever it was in certain positions. These were gradually changed and improved into detents and catches of different shapes; at last, in 1717, Mr Beighton, a very ingenious and well informed artist, simplified the whole of these subordinate movements, and brought the machine into the form in which it has continued, without the smallest material change, to the present day. We shall now describe one of these improved engines, copying almost exactly the drawings and description given by Bossut in his *Hydrodynamique*; these being by far the most accurate and perspicuous of any that have been published.

Fig. 8. n° 1. is a perspective view of the boiler cylinder, and all the parts necessary for turning the cocks. Fig. 8. n° 2. is a vertical section of the same; and the same pieces of both are marked with the same letters of reference.

The

Steam-Engine.

22  
Difference between Savary's and Newcomen's machines.

23  
Superiority of Newcomen's.

24  
Gradually improved.

25  
And simplified.

Plate CCCLXXVII

The rod X of the piston P is suspended from the arch of the working-beam, as was represented in the preceding sketch (fig. 7). An upright bar of timber FG is also seen hanging by a chain. This is suspended from a concentric arch of the beam, as may be seen also in the sketch at *n*. This bar is called the *plug-beam*, and it must rise and fall with the piston, but with a slower motion. The use of this plug-beam is to give motion to the different pieces which turn the cocks.

The steam-pipe K is of one piece with the bottom of the cylinder, and rises within it an inch or two, to prevent any of the cold injection water from falling into the boiler. The lower extremity Z of the steam-pipe penetrates the head of the boiler, projecting a little way. A flat plate of brass, in shape resembling a racket or battledore, called the *regulator*, applies itself exactly to the whole circumference of the steam-pipe, and completely excludes the steam from the cylinder. Being moveable round an upright axis, which is represented by the dotted lines at the side of the steam-pipe in the profile, it may be turned aside by the handle *i*, *n*<sup>o</sup> 1. The profile shows in the section of this plate a protuberance in the middle. This rests on a strong flat spring, which is fixed below it athwart the mouth of the steam-pipe. This spring presses it strongly towards the steam-pipe, causing it to apply very close; and this knob slides along the spring, while the regulator turns to the right or left.

We have said that the injection water is furnished from a cistern placed above the cylinder. When this cistern cannot be supplied by pipes from some more elevated source, its water is raised by the machine itself. A small lifting pump *ik* (fig. 7.), called the *jack-head* or *jacquette*, is worked by a rod *r*, suspended from a concentric arch *e* near the outer end of the working beam. This forces a small portion of the pit water along the rising pipe *i* LM into the injection cistern.

In figure 8. *n*<sup>o</sup> 1. and 2. the letters QM *z* represent the pipe which brings down the water from the injection cistern. This pipe has a cock at R to open or shut the passage of this water. It spouts through the jet *z*, and dashing against the bottom of the piston, it is dispersed into drops, and scattered through the whole capacity of the cylinder, so as to produce a rapid condensation of the steam.

An upright post A may be observed in the perspective view of the cylinder, &c. This supports one end B of a horizontal iron axis BC. The end C is supported by a similar post, of which the place only is marked by the dotted lines A, that the pieces connected with this axis may not be hid by it. A kind of stirrup *abcd* hangs from this axis, supported by the hooks *a* and *d*. This stirrup is crossed near the bottom by a round bolt or bar *e*, which passes through the eyes or rings that are at the ends of the horizontal fork *hfg*, whose long tail *b* is double, receiving between its branches the handle *i* of the regulator. It is plain from this construction, that when the stirrup is made to vibrate round the horizontal axis BC, on which it hangs freely by its hooks, the bolt *e* must pull or push the long fork *hfg* backwards and forwards horizontally, and by so doing will move the regulator round its axis by means of the handle *i*. Both the tail of the fork and the handle of the regulator are pierced with several

holes, and a pin is put through them which unites them by a joint. The motion of the handle may be increased or diminished by choosing for the joint a hole near to the axis or remote from it; and the exact position at which the regulator is to stop on both sides is determined by pins stuck in the horizontal bar on which the end of the handle appears to rest.

This alternate motion of the regulator to the right and left is produced as follows: There is fixed to the axis BC a piece of iron *okl*, called the Y, on account of its resemblance to that letter of the alphabet inverted. The stalk *o* carries a heavy lump *p* of lead or iron; and a long leather strap *qpr* is fastened to *p* by the middle, and the two ends are fastened to the beam above it, in such a manner that the lump may be alternately caught and held up to the right and left of the perpendicular. By adjusting the length of the two parts of the strap, the Y may be stopped in any desired position. The two claws *k* and *l* spread out from each other, and from the line of the stalk, and they are of such length as to reach the horizontal bolt *e*, which crosses the stirrup below, but not to reach the bottom of the fork *hfg*. Now suppose the stirrup hanging perpendicularly, and the stalk of the Y also held perpendicular; carry it a little outward from the cylinder, and then let it go. It will tumble farther out by its weight, without affecting the stirrup till the claw *l* strikes on the horizontal bolt *e*, and then it pushes the stirrup and the fork towards the cylinder, and opens the regulator. It sets it in motion with a smart jerk, which is an effectual way of overcoming the cohesion and friction of the regulator with the mouth of the steam-pipe. This push is adjusted to a proper length by the strap *qp*, which stops the Y when it has gone far enough. If we now take hold of the stalk of the Y, and move it up to the perpendicular, the width between its claws is such as to permit this motion, and something more, without affecting the stirrup. But when pushed still nearer to the cylinder, it tumbles towards it by its own weight, and then the claw *k* strikes the bolt *e*, and drives the stirrup and fork in the opposite direction, till the lump *p* is caught by the strap *rp*, now stretched to its full length, while *qp* hangs slack. Thus by the motion of the Y the regulator is opened and shut. Let us now see how the motion of the Y is produced by the machine itself. To the horizontal axis BC are attached two spanners or handles *m* and *n*. The spanner *m* passes through a long slit in the plug-beam, and is at liberty to move upwards or downwards by its motion round the axis BC. A pin *r* which goes through the plug-beam catches hold of *m* when the beam rises along with the piston; and the pin is so placed, that when the beam is within an inch or two of its highest rise, the pin has lifted *m* and thrown the stalk of the Y past the perpendicular. It therefore tumbles over with great force, and gives a smart blow to the fork, and immediately shuts the regulator. By this motion the spanner *m* is removed out of the neighbourhood of the plug-beam. But the spanner *n*, moving along with it in the same direction, now comes into the way of the pins of the plug-beam. Therefore, when the piston descends again by the condensation of the steam in the cylinder, a pin marked *s* in the side of the plug-beam catches hold of the tail of the spanner *n*, and by pressing it down raises the lump on the stalk

Steam-Engine

stalk of the Y till it passes the perpendicular, and it then falls down, outwards from the cylinder, and the claw *l* again drives the fork in the direction *b i*, and opens the steam valve. This opening and shutting of the steam valve is executed in the precise moment that is proper, by placing the pins *r* and *S* at a proper height in the plug-beam. For this reason, it is pierced through with a great number of holes, that the places of these pins may be varied at pleasure. This, and a proper curvature of the spanners *m* and *n*, make the adjustment as nice as we please.

The injection-cock R is managed in a similar manner. On its key may be observed a forked arm *s t*, like a crab's claw; at a little distance above it is the gudgeon or axis *u* of a piece *y u z'*, called the hammer or the F, from its resemblance to that letter. It has a lump of metal *y* at one end, and a spear *u s* projects from its middle, and passes between the claws *s* and *t* of the arm of the injection-cock. The hammer *y* is held up by a notch in the underside of a wooden lever DE, moveable round the centre D, and supported at a proper height by a string *r E* made fast to the joint above it.

Suppose the injection-cock shut, and the hammer in the position represented in the figure. A pin *z* of the plug-frame rises along with the piston, and catching hold of the detent DE, raises it, and disengages the hammer *y* from its notch. This immediately falls down, and strikes a board L put in the way to stop it. The spear *u s* takes hold of the claw *t*, and forces it aside towards *x*, and opens the injection-cock. The piston immediately descends, and along with it the plug-frame. During its descent the pin *z* meets with the tail *u z'* of the hammer, which is now raised considerably above the level, and brings it down along with it, raising the lump *y*, and gradually shutting the injection-cock, because the spear takes hold of the claw *s* of its arm. When the beam has come to its lowest situation, the hammer is again engaged in the notch of the detent DE, and supported by it till the piston again reaches the top of the cylinder.

In this manner the motions of the injection cock are also adjusted to the precise moment that is proper for them. The different pins are so placed in the plug-frame, that the steam-cock may be completely shut before the injection-cock is opened. The inherent motion of the machine will give a small addition to the ascent of the piston without expending steam all the while; and by leaving the steam rather less elastic than before, the subsequent descent of the piston is promoted. There is a considerable propriety in the gradual shutting of the injection-cock. For after the first dash of the cold water against the bottom of the piston, the condensation is nearly complete, and very little more water is needed; but a continual accession of some is absolutely necessary for completing the condensation, as the capacity of the cylinder diminishes, and the water warms which is already injected.

In this manner the motion of the machine will be repeated as long as there is a supply of steam from the boiler, and of water from the injection cistern, and a discharge procured for what has been injected. We proceed to consider how these conditions also are provided by the machine itself.

The injection cistern is supplied with water by the

jackhead-pump, as we have already observed. From this source all the parts of the machine receive their respective supplies. In the first place, a small branch 13, 13, is taken off from the injection-pipe immediately below the cistern, and conducted to the top of the cylinder, where it is furnished with a cock. The spout is so adjusted, that no more runs from it than what will keep a constant supply of a foot of water above the piston to keep it tight. Every time the piston comes to the top of the cylinder, it brings this water along with it, and the surplus of its evaporation and leakage runs off by a waste pipe 14, 14. This water necessarily becomes almost boiling hot, and it was thought proper to employ its overplus for supplying the waste of the boiler. This was accordingly practised for some time. But Mr Beighton improved this economical thought, by supplying the boiler from the eduction-pipe 2, 2, the water of which must be still hotter than that above the piston. This contrivance required attention to many circumstances, which the reader will understand by considering the perspective and profile. The eduction pipe comes out of the bottom of the cylinder at 1 with a perpendicular part, which bends sidewise below, and is shut at the extremity 1. A deep cup 5 communicates with it, holding a metal valve nicely fitted to it by grinding, like the key of a cock. To secure it being always air-tight, a slender stream of water trickles into it from a branch 6 of the waste pipe from the top of the cylinder. The eduction-pipe branches off at 2, and goes down to the hot well, where it turns up, and is covered with a valve. In the perspective view may be observed an upright pipe 4, 4, which goes through the head of the boiler, and reaches to within a few inches of its bottom. This pipe is called the feeder, and rises about three or four feet above the boiler. It is open at both ends, and has a branch 3, 3, communicating with the bottom of the cup 5, immediately above the metal valve, and also a few inches below the level of the entry 2 of the eduction-pipe. This communicating branch has a cock by which its passage may be diminished at pleasure. Now suppose the steam in the boiler to be very strong; it will cause the boiling water to rise in the feeding pipe above 3, and coming along this branch, to rise also in the cup 5, and run over. But the height of this cup above the surface of the water in the boiler is such, that the steam is never strong enough to produce this effect. Therefore, on the contrary, any water that may be in the cup 5 will run off by the branch 3, 3, and go down into the boiler by the feeding pipe.

These things being understood, let us suppose a quantity of injected water lying at the bottom of the cylinder. It will run into the eduction pipe, fill the crooked branch 1, 1, and open the valve in the bottom of the cup (its weight being supported by a wire hanging from a slender spring), and it will fill the cup to the level of the entry 2 of the eduction-pipe, and will then flow along 3, 3, and supply the boiler by the feeder 4, 4. What more water runs in at 1 will now go along the eduction-pipe 2, 2, to the hot well. By properly adjusting the cock on the branch 3, 3, the boiler may be supplied as fast as the waste in steam requires. This is a most ingenious contrivance, and does great honour to Mr Beighton. It is not, however, of much importance. The small quantity which the boiler requires may

Steam-Engine

Steam-Engine.

may be immediately taken even from a cold cistern, without sensibly diminishing the production of steam: for the quantity of heat necessary for raising the sensible heat of cold water to the boiling temperature is quite insignificant, when compared with the quantity of heat which must then be combined with it in order to convert the water into steam. No difference can be observed in the performance of such engines and of those which have their boilers supplied from a brook. It has, however, the advantage of being purged of air; and when an engine must derive all its supplies from pit water, the water from the eduction-pipe is vastly preferable to that from the top of the cylinder.

We may here observe, that many writers (among them the Abbé Bossut), in their descriptions of the steam-engine, have drawn the branch of communication 3, 3, from the feeding pipe to a part of the crooked pipe 1, 1, lying below the valve in the cup 5. But this is quite erroneous; for, in this case, when the injection is made into the cylinder, and a vacuum produced, the water from the boiler would immediately rush up through the pipes 4, 3, and spout up into the cylinder: so would the external air coming in at the top of the feeder.

23  
Which enables us to form some judgment of the internal state of the engine during the performance.

This contrivance has also enabled us to form some judgment of the internal state of the engine during the performance. Mr Beighton paid a minute attention to the situation of the water in the feeders and eduction-pipe of an engine, which seems to have been one of the best which has yet been erected. It was lifting a column of water whose weight was  $\frac{7}{8}$ ths of the pressure of the air on its piston, and made 16 strokes, of 6 feet each, in a minute. This is acknowledged by all to be a very great performance of an engine of this form. He concluded that the elasticity of the steam in the cylinder was never more than one-tenth greater or less than the elasticity of the air. The water in the feeder never rose more than three feet and a half above the surface of the boiling water, even though it was now lighter by  $\frac{1}{4}$ th than cold water. The eduction-pipe was only  $4\frac{1}{2}$  feet long (vertically), and yet it always discharged the injection water completely, and allowed some to pass into the feeder. This could not be if the steam was much more than  $\frac{1}{10}$ th weaker than air. By grasping this pipe in his hand during the rise of the piston, he could guess very well whereabouts the surface of the hot water in it rested during the motion, and he never found it supported so high as four feet. Therefore the steam in the cylinder had at least  $\frac{9}{10}$ ths of the elasticity of the air. Mr Buat, in his examination of an engine which is erected at Montrelaix, in France, by an English engineer, and has always been considered as the pattern in that country, finds it necessary to suppose a much greater variation in the strength of the steam, and says that it must have been  $\frac{1}{7}$ th stronger and  $\frac{1}{5}$ th weaker than common air. But this engine has not been nearly so perfect. Its lift was not more than  $\frac{1}{2}$  of the pressure of the atmosphere, and it made but nine strokes in a minute.— At W is a valve covering the mouth of a small pipe, and surrounded with a cup containing water to keep it air-tight. This allows the air to escape which had been extricated from the water of last injection. It is driven out by the first strong puff of steam which is admitted into the cylinder, and makes a noise in its exit. This valve is therefore called the snifting valve.

To finish our description, we observe, that besides

VOL. XVII. Part II.

the safety valve 9 (called the PUPPET CLACK), which is loaded with about 3 pounds on the square inch (though the engine will work very well with a load of 1 or 2 pounds), there is another DISCHARGER 10, 10, having a clack at its extremity supported by a cord. Its use is to discharge the steam without doors, when the machine gives over working. There is also a pipe S I near the bottom of the boiler, by which it may be emptied when it needs repairs or cleansing.

Steam-Engine.

There are two final pipes 11, 11, and 12, 12, with cocks called GAGE-PIPPES. The first descends to within two inches of the surface of the water in the boiler, and the second goes about 2 inches below that surface. If both cocks emit steam, the water is too low, and requires a recruit. If neither give steam, it is too high, and there is not sufficient room above it for a collection of steam. Lastly, there is a filling pipe Q, by which the boiler may be filled when the machine is to be set to work.

The engine has continued in this form for many years. <sup>24</sup> The only remarkable change introduced has been the manner of placing the boiler. It is no longer placed below the cylinder, but at one side, and the steam is introduced by a pipe from the top of the boiler into a flat box immediately below the cylinder. The use of this box is merely to lodge the regulator, and give room for its motions. This has been a very considerable improvement. It has greatly reduced the height of the building. This was formerly a tower. The wall which supported the beam could hardly be built with sufficient strength for withstanding the violent shocks which were repeated without ceasing; and the buildings seldom lasted more than a very few years. But the boiler is now set up in an adjoining shed, and the gudgeons of the main beam rest on the top of upright posts, which are framed into the joists which support the cylinder. Thus the whole moving parts of the machine are contained in one compact frame of carpentry, and have little or no connection with the slight walls of the building, which is merely a case to hold the machine, and protect it from the weather.

It is now time to inquire what is to be expected from this machine, and to ascertain the most advantageous proportion between the moving power and the load that is to be laid on the machine. <sup>25</sup>

It may be considered as a great pulley, and is indeed sometimes so constructed, the arches at the ends of the working beam being completed to a circle. It must be unequally loaded that it may move. It is loaded, during the working stroke, by the pressure of the atmosphere on the piston side, and by the column of water to be raised and the pump-gear on the pump side.— During the returning stroke it is loaded, on the piston side, by a small part of the atmospheric pressure, and on the pump side by the pump gear acting as a counter weight. The load during the working stroke must therefore consist of the column of water to be raised and this counter weight. The performance of the machine is to be measured only by the quantity of water raised in a given time to a given height. It varies, therefore, in the joint proportion of the weight of the column of water in the pumps, and the number of strokes made by the machine in a minute. Each stroke consists of two parts, which we have called the working and the returning stroke. It does not, therefore, depend simply on the velocity of the working stroke and the quantity

Steam-Engine.

quantity of water raised by it. If this were all that is to be attended to, we know that the weight of the column of water should be nearly  $\frac{2}{3}$ ths of the pressure of the atmosphere, this being the proportion which gives the maximum in the common pulley. But the time of the returning stroke is a necessary part of the whole time elapsed, and therefore the velocity of the returning stroke equally merits attention. This is regulated by the counter weight. The number of strokes per minute does not give an immediate proof of the goodness of the engine. A small load of water and a great counter weight will ensure this, because these conditions will produce a brisk motion in both directions.— The proper adjustment of the pressure of the atmosphere on the piston, the column of water to be raised, and the counter weight, is a problem of very great difficulty; and mathematicians have not turned much of their attention to the subject, although it is certainly the most interesting question that practical mechanics affords them.

31  
Mr Bossut's solution,

Mr Bossut has solved it very shortly and simply, upon this supposition, that the working and returning stroke should be made in equal times. This, indeed, is generally aimed at in the erection of these machines, and they are not reckoned to be well arranged if it be otherwise. We doubt of the propriety of the maxim. Supposing, however, this condition for the present, we may compute the loadings of the two ends of the beam as follows. Let  $a$  be the length of the inner arm of the working beam, or that by which the great piston is supported. Let  $b$  be the outer arm carrying the pump rods, and let  $W$  be a weight equivalent to all the load which is laid on the machine. Let  $c^2$  be the area of the piston; let  $H$  be the height of a column of water having  $c^2$  for its base, and being equal in weight to the pressure exerted by the steam on the under side of the piston; and let  $b$  be the pressure of the atmosphere on the same area, or the height of a column of water of equal weight. It is evident that both strokes will be performed in equal times, if  $b c^2 a - W b$  be equal to  $(b - H) c^2 a + W b$ . The first of these quantities is the energy of the machine during the working stroke, and the second expresses the similar energy during the returning stroke. This equation gives us  $W = \frac{2 b c^2 a - H c^2 a}{2 b} = \frac{(2 b - H) c^2 a}{2 b}$ . If we suppose

the arms of the lever equal and  $H = b$ , we have  $W = c^2 \frac{b}{2}$ ; that is, the whole weight of the outer end

of the beam should be half the pressure of the air on the great piston. This is nearly the usual practice; and the engineers express it by saying, that the engine is loaded with seven or eight pounds on the square inch. This has been found to be nearly the most advantageous load. This way of expressing the matter would do well enough, if the maxim were not founded on erroneous notions, which hinder us from seeing the state of the machine, and the circumstances on which its improvement depends. The piston bears a pressure of 15 pounds, it is said, on the square inch, if the vacuum below it be perfect; but as this is far from being the case, we must not load it above the power of its vacuum, which very little exceeds eight pounds. But this is very far from the truth. When the cylinder is tight, the vacuum is not more than  $\frac{1}{10}$ th deficient, when the

cylinder is cooled by the injection to the degree that is every day practicable, and the piston really bears during its descent a pressure very near to 14 pounds on the inch. The load must be diminished, not on account of the imperfect vacuum, but to give the machine a reasonable motion. We must consider not only the moving force, but also the quantity of matter to be put in motion. This is so great in the steam engine, that even if it were balanced, that is, if there were suspended on the piston arm a weight equal to the whole column of water and the counter weight, the full pressure of the atmosphere on the steam piston would not make it move twice as fast as it does.

This equation by Mr Bossut is moreover essentially faulty in another respect. The  $W$  in the first member is not the same with the  $W$  in the second. In the first it is the column of water to be raised, together with the counter weight. In the second it is the counter weight only. Nor is the quantity  $H$  the same in both cases, as is most evident. The proper equation for ensuring the equal duration of the two strokes may be had in the following manner. Let it be determined by experiment what portion of the atmospheric pressure is exerted on the great piston during its descent. This depends on the remaining elasticity of the steam. Suppose it  $\frac{2}{3}$ ths: this we may express by  $ab$ ,  $a$  being  $\frac{2}{3}$ ths. Let it also be determined by experiment what portion of the atmospheric pressure on the piston remains unbalanced by the steam below it during its ascent. Suppose this  $\frac{1}{5}$ th, we may express this by  $bb$ . Then let  $W$  be the weight of the column of water to be raised, and  $c$  the counter weight. Then, if the arms of the beam are equal, we have the energy during the working stroke  $= ab - W - c$ , and during the returning stroke it is  $= c - bb$ . Therefore  $c - bb = ab - W - c$ ; and  $c = \frac{b(a + b) - W}{2}$ ; which, on the above

supposition of the values of  $a$  and  $b$ , gives us  $c = \frac{b - W}{2}$ . We shall make some use of this equation afterwards; but it affords us no information concerning the most advantageous proportion of  $b$  and  $W$ , which is the material point.

We must consider this matter in another way: And that we may not involve ourselves in unnecessary difficulties, let us make the case as simple as possible, and suppose the arms of the working-beam to be of equal length.

We shall first consider the adjustment of things at the outer end of the beam.

Since the sole use of the steam is to give room for the action of the atmospheric pressure by its rapid condensation, it is admitted into the cylinder only to allow the piston to rise again, but without giving it any impulse. The pump-rods must therefore be returned to the bottom of the working barrels by means of a preponderancy at the outer end of the beam. It may be the weight of the pump-rods themselves, or may be considered as making part of this weight. A weight at the end of the beam will not operate on the rods which are suspended there by chains, and it must therefore be attached to the rods themselves, but above their respective pump-barrels, so that it may not lose part of its efficacy by immersion in the water. We may consider the whole under the notion of the pump-gear, and call it  $p$ . Its office is to depress the pump-rods with sufficient

Steam-Engine.

33  
And faulty in another respect.

34  
Another way of considering matter.

35  
Adjustment of things at the outer end of the beam considered.

32  
Founded on an erroneous maxim.

Steam-Engine.

Steam-Engine.

cient velocity, by overcoming the resistances arising from the following causes.

1. From the inertia of the beams and all the parts of the apparatus which are in motion during the descent of the pump-rods.
2. From the loss of weight sustained by the immersion of the pump-rods in water.
3. From the friction of all the pistons and the weight of the plug-frame.
4. From the resistance to the piston's motion, arising from the velocity which must be generated in the water in passing through the descending pistons.

The sum of all these resistances is equal to the pressure of some weight (as yet unknown), which we may call  $m$ .

When the pump-rods are brought up again, they bring along with them a column of water, whose weight we may call  $w$ .

It is evident that the load which must be overcome by the pressure of the atmosphere on the steam piston consists of  $w$  and  $p$ . Let this load be called  $L$ , and the pressure of the air be called  $P$ .

If  $p$  be  $= L$ , no water will be raised; if  $p$  be  $= 0$ , the rods will not descend: therefore there is some intermediate value of  $p$  which will produce the greatest effect.

In order to discover this, let  $g$  be the fall of a heavy body in a second.

The descending mass is  $p$ : but it does not descend with its full weight; because it is overcoming a set of resistances which are equivalent to a weight  $m$ , and the moving force is  $p - m$ . In order to discover the space through which the rods will descend in a second, when urged by the force  $p - m$  (supposed constant, notwithstanding the increase of velocity, and consequently of  $m$ ), we must institute this proportion  $p : p - m = g : g(p - m)$ .

The fourth term of this analogy is the space required.

Let  $t$  be the whole time of the descent in seconds. Then  $t^2 : t^2 = \frac{g(p - m)}{p} : \frac{t^2 g(p - m)}{p}$ . This last term is the whole descent or length of the stroke accomplished in the time  $t$ .

The weight of the column of water, which has now got above the piston, is  $w = L - p$ . This must be lifted in the next working stroke through the space  $\frac{t^2 g(p - m)}{p}$ . Therefore the performance of the engine must be  $\frac{t^2 g(p - m)(L - p)}{p}$ .

That this may be the greatest possible, we must consider  $p$  as the variable quantity, and make the fluxion of the fraction  $\frac{t^2 g(p - m)(L - p)}{p} = 0$ .

This will be found to give us  $p = \sqrt{Lm}$ ; that is, the counter weight or preponderancy of the outer end of the beam is  $= \sqrt{Lm}$ .

This gives us a method of determining  $m$  experimentally. We can discover by actual measurement the quantity  $L$  in any engine, it being equal to the un-

balanced weights on the beam and the weight of the water in the pumps. Then  $m = \frac{p^2}{L}$ .

Also we have the weight of the column of water  $= L - p = L - \sqrt{Lm}$ .

When therefore we have determined the load which is to be on the outer end of the beam during the working stroke, it must be distributed into two parts, which have the proportion of  $\sqrt{Lm}$  to  $L - \sqrt{Lm}$ . The first is the counter weight, and the second is the weight of the column of water.

If  $m$  is a fraction of  $L$ , such as an aliquot part of it; that is, if

$$m = \frac{L}{1}, \frac{L}{4}, \frac{L}{9}, \frac{L}{16}, \frac{L}{25}, \&c.$$

$$p = \frac{L}{1}, \frac{L}{2}, \frac{L}{3}, \frac{L}{4}, \frac{L}{5}, \&c.$$

The circumstance which is commonly obtruded on us by local considerations is the quantity of water, and the depth from which it is to be raised; that is,  $w$ : and it will be convenient to determine every thing in conformity to this.

We saw that  $w = L - \sqrt{Lm}$ . This gives us  $L = \pm \sqrt{wm + \frac{m^2}{4}} + \frac{m}{2} + w$ , and the counter weight  $p = \sqrt{wm + \frac{m^2}{4}} + \frac{m}{2}$ .

Having thus ascertained that distribution of the load on the outer end of the beam which produces the greatest effect, we come now to consider what proportion of moving force we must apply, so that it may be employed to the best advantage, or so that any expence of power may produce the greatest performance. It will be so much the greater as the work done is greater, and the power employed is less; and will therefore be properly measured by the quotient of the work done divided by the power employed.

The work immediately done is the lifting up the weight  $L$ . In order to accomplish this, we must employ a pressure  $P$ , which is greater than  $L$ . Let it be  $= L + y$ ; also let  $s$  be the length of the stroke.

If the mass  $L$  were urged along the space  $s$  by the force  $L + y$ , it would acquire a certain velocity, which we may express by  $\sqrt{s}$ ; but it is impelled only by the force  $y$ , the rest of  $P$  being employed in balancing  $L$ . The velocities which different forces generate by impelling a body along the same space are as the square roots of the forces. Therefore  $\sqrt{L + y} : \sqrt{y} = \sqrt{s} :$

$\frac{\sqrt{L + y}}{\sqrt{L + y}}$ . The fourth term of this analogy expresses the velocity of the piston at the end of the stroke. The quantity of motion produced will be had by multiplying this velocity by the mass  $L$ . This gives  $\frac{L \times \sqrt{L + y}}{\sqrt{L + y}}$ ; and this, divided by the power expended, or by  $L + y$ , gives us the measure of the performance; namely,  $\frac{L \times \sqrt{L + y}}{L + y \times \sqrt{L + y}}$ .

That this may be a maximum, consider  $y$  as the variable

Steam-Engine.

riable quantity, and make the fluxion of this formula

$$= 0. \text{ This will give us } y = \frac{L}{2}.$$

Now  $P = L + y, = L + \frac{L}{2}, = \frac{3}{2} L.$  Therefore the whole load on the outer end of the beam, consisting of the water and the counter weight, must be  $\frac{3}{2}$ ds of the pressure of the atmosphere on the steam piston.

We have here supposed that the expenditure is the atmospheric pressure; and so it is if we consider it mechanically. But the expenditure of which we are sensible, and which we are anxious to employ to the best advantage, is fuel. Supposing this to be employed with the same judgment in all cases, we are almost intitled, by what we now know of the production of steam, to say that the steam produced is proportional to the fuel expended. But the steam requisite for merely filling the cylinder is proportional to the area of the piston, and therefore to the atmospheric pressure. The result of our investigation therefore is still just; but the steam wasted by condensation on the sides of the cylinder does not follow this ratio, and this is more than what is necessary for merely filling it. This deranges our calculations, and is in favour of large cylinders; but this advantage must be in a great measure compensated by a similar variation in the production of the steam; for in similar boilers of greater dimensions the fuel is less advantageously employed, because the surface to which the fuel is applied does not increase in the ratio of the capacity, just as the surface of the cylinder which wastes the steam. The rule may therefore be confided in as pretty exact.

37  
The re-  
sults agree  
with the  
most suc-  
cessful  
practice.

It is a satisfactory thing to observe these results agree very well with the most successful practice. By many changes and trials engineers have established maxims of construction, which are probably not very far from the best. It is a pretty general maxim, that the load of water should be  $\frac{2}{3}$  of the atmospheric pressure. They call this loading the engine with  $7\frac{1}{2}$  pounds on the inch, and they say that so small a load is necessary on account of the imperfect vacuum. But we have now seen that it is necessary for giving a reasonable velocity of motion. Since, in this practice,  $w$  is  $m \cdot e \cdot \frac{1}{2}$  or  $\frac{2}{3}$ ths of  $P$ , and  $L$  should be  $\frac{3}{2}$ ths of  $P$ , and  $L$  is  $= w + p$ ; it follows, that the counter weight should be  $\frac{2}{3}$ th of  $P$ ; and we have found this to be nearly the case in several very good engines.

It must be remarked, that in the preceding investigation we introduced a quantity  $M$  to express the resistances to the motion of the engine. This was done in order to avoid a very troublesome investigation. The resistances are of such a nature as to vary with the velocity, and most of them as the square of the velocity. This is the case with the resistance arising from the motion of the water through the pistons of the pumps, and that arising from the friction in the long list during the working stroke. Had we taken the direct method, which is similar to the determination of the motion thro' a medium which resists in the duplicate ratio of the velocity, we must have used a very intricate exponential calculus, which few of our readers would have the patience to look at.

But the greatest part of the quantity  $m$  supposes a motion already known, and its determination depends

on this motion. We must now show how its different component parts may be computed.

Steam-Engine.

1. What arises from the inertia of the moving parts is by far the most considerable portion of it. To obtain it, we must find a quantity of matter which, when placed at the end of the beam, will have the same momentum of inertia with that of the whole moving parts in their natural places. Therefore (in the returning stroke) add together the weight of the great piston with its rod and chains; the pit pump-rods, chains, and any weight that is attached to them; the arch-heads and iron-work at the ends of the beam, and  $\frac{2}{3}$ ths of the weight of the beam itself; also the plug-beam with its arch-head and chain, multiplied by the square of its distance from the axis, and divided by the square of half the length of the beam; also the jack-head pump-rod, chain, and arch-head, multiplied by the square of its distance from the axis, and divided by the square of the half-length of the beam. These articles added into one sum may be called  $M$ , and may be supposed to move with the velocity of the end of the beam. Suppose this beam to have made a six-foot stroke in two seconds, with an uniformly accelerated motion. In one second it would have moved  $1\frac{1}{2}$  feet, and would have acquired the velocity of three feet per second. But in one second gravity would have produced a velocity of 32 feet in the same mass. Therefore the accelerating force which has produced the velocity of three feet is nearly  $\frac{1}{11}$ th of the weight. Therefore  $\frac{M}{11}$  is the first constituent of  $m$  in the above investigation. If the observed velocity is greater or less than three feet per second, this value must be increased or diminished in the same proportion.

38  
Resistances  
to the motion  
of the engine  
computed.

The second cause of resistance, viz. the immersion of the pump-rods in water, is easily computed, being the weight of the water which they displace.

The third cause, the friction of the pistons, &c. is almost insignificant, and must be discovered by experiment.

The fourth cause depends on the structure of the pumps. These pumps, when made of a proper strength, can hardly have the perforation of the piston more than a fourth part of the area of the working barrel; and the velocity with which the water passes through it is increased at least  $\frac{1}{3}$ th by the contraction (see PUMP). The velocity of the water is therefore five times greater than that of the piston. A piston 12 inches diameter, and moving one foot per second, meets with a resistance equal to 20 pounds; and this increases as the square of the diameter and as the square of the velocity. If the whole depth of the pit be divided into several lifts, this resistance must be multiplied by the number of lifts, because it obtains in each pump.

Thus we make up the value of  $m$ ; and we must acknowledge that the method is still indirect, because it supposes the velocity to be known.

We may obtain it more easily in another way, but still with this circumstance of being indirect. We found that  $p$  was equal to  $\sqrt{Lm}$ , and consequently  $m = \frac{p^2}{L}$ . Now in any engine  $L$  and  $p$  can always be had; and unless  $p$  deviates greatly from the proportion which we determined to be the best, the value of  $m$  thus obtained will not be very erroneous.



Steam-Engine

39  
Observations concerning something presumed in the investigation.

It was farther presumed in this investigation, that the motions both up and down were uniformly accelerated; but this cannot be the case when the resistances increase with the velocity. This circumstance makes very little change in the working-stroke, and therefore the theorem which determines the best relation of P to L may be confided in. The resistances which vary with the velocity in this case are a mere trifle when compared with the moving power  $y$ . These resistances are, 1st, The strangling of the water at the entry and at the standing valve of each pump. This is about 37 pounds for a pump 12 inches diameter, and the velocity one foot per second, increasing in the duplicate ratio of the diameter and velocity; and, 2d, The friction of the water along the whole lift. This for a pump of the same size and with the same velocity, lifting 20 fathoms, is only about  $2\frac{1}{2}$  pounds, and varies in the simple proportion of the diameter and the depth, and in the duplicate proportion of the velocity. The resistance arising from inertia is greater than in the returning-stroke; because the M in this case must contain the momentum of the water both of the pit-pumps and the jackhead-pump: but this part of the resistance does not affect the uniform acceleration. We may therefore confide

in the propriety of the formula  $y = \frac{I}{2}$ . And we may obtain the velocity of this stroke at the end of a second with great accuracy as follows. Let  $2g$  be the velocity communicated by gravity in a second, and the velocity at the end of the first second of the steam piston's descent will be somewhat less than  $\frac{y}{M} 2g$ ; where M expresses the inertia of all the parts which are in motion during the descent of the steam piston, and therefore includes L. Compute the two resistances just mentioned for this velocity. Call this  $r$ . Then  $\frac{y - \frac{1}{2}r}{M} 2g$  will give another velocity infinitely near the truth.

But the case is very different in the returning stroke, and the proper ratio of  $p$  to L is not ascertained with the same certainty: for the moving force  $p$  is not so great in proportion to the resistance  $m$ ; and therefore the acceleration of the motion is considerably affected by it, and the motion itself is considerably retarded, and in a very moderate time it becomes sensibly uniform: for it is precisely similar to the motion of a heavy body falling through the air, and may be determined in the manner laid down in the article *RESISTANCE of Fluids*, viz. by an exponential calculus. We shall content ourselves here with saying, that the resistances in the present case are so great that the motion would be to all sense uniform before the pistons have descended  $\frac{1}{3}$ d of their stroke, even although there were no other circumstance to affect it.

40  
The motion affected by a circumstance that deserves particular consideration.

But this motion is affected by a circumstance quite unconnected with any thing yet considered, depending on conditions not mechanical, and so uncertain, that we are not yet able to ascertain them with any precision; yet they are of the utmost importance to the good performance and improvement of the engine, and therefore deserve a particular consideration.

The counter weight has not only to push down the pump-rods, but also to drag up the great piston. This it cannot do unless the steam be admitted into the cy-

Steam-Engine.

linder. If the steam be no stronger than common air, it cannot enter the cylinder except in consequence of the piston's being dragged up. If common air were admitted into the cylinder, some force would be required to drag up the piston, in the same manner as it is required to draw up the piston of a common syringe; for the air would rush through the small entry of the cylinder in the same manner as through the small nozzle of the syringe. Some part of the atmospheric pressure is employed in driving in the air with sufficient velocity to fill the syringe, and it is only with the remainder that the admitted air presses on the under surface of the syringe. Therefore some of the atmospheric pressure on its upper surface is not balanced. This is felt by the hand which draws it up. The same thing must happen in the steam-engine, and some part of the counter weight is expended in drawing up the steam-piston. We could tell how much is thus expended if we knew the density of the steam; for this would tell us the velocity with which its elasticity would cause it to fill the cylinder. If we suppose it 12 times rarer than air, which it certainly is, and the piston rises to the top of the cylinder in two seconds, we can demonstrate that it will enter with a velocity not less than 1400 feet per second, whereas 500 feet is enough to make it maintain a density  $\frac{2}{3}$ ths of that of steam in equilibrium with the air. Hence it follows, that its elasticity will not be less than  $\frac{2}{3}$ ths of the elasticity of the air, and therefore not more than  $\frac{1}{3}$ th of counter weight will be expended in drawing up the steam-piston.

But all this is on the supposition that there is an unbounded supply of steam of undiminished elasticity. This is by no means the case. Immediately before opening the steam-cock, the steam was issuing through the safety-valve and all the crevices in the top of the boiler, and (in good engines) was about  $\frac{1}{10}$ th stronger or more elastic than air. This had been gathering during something more than the descent of the piston, viz. in about three seconds. The piston rises to the top in about two seconds; therefore about twice and a half as much steam as fills the dome of the boiler is now shared between the boiler and cylinder. The dome is commonly about six times more capacious than the cylinder. If therefore no steam is condensed in the cylinder, the density of the steam, when the piston has reached the top, must be about  $\frac{1}{3}$ ths of its former density, and still more elastic than air. But as much steam is condensed by the cold cylinder, its elasticity must be less than this. We cannot tell how much less, both because we do not know how much is thus condensed, and because by this diminution of its pressure on the surface of the boiling water, it must be more copiously produced in the boiler; but an attentive observation of the engine will give us some information. The moment the steam-cock is opened we have a strong puff of steam through the snifting valve. At this time, therefore, it is still more elastic than air; but after this, the snifting valve remains shut during the whole rise of the piston, and no steam any longer issues through the safety-valve or crevices; nay, the whole dome of the boiler may be observed to sink.

These facts give abundant proof that the elasticity of the steam during the ascent of the piston is greatly diminished, and therefore much of the counter weight is expended in dragging up the steam-piston in opposition to the unbalanced part of the atmospheric pressure. The

41  
The elastic force of the steam during the ascent of the piston greatly diminished.

Steam-Engine.

motion of the returning stroke is therefore so much deranged by this foreign and inappreciated circumstance, that it would have been quite useless to engage in the intricate exponential investigation, and we must sit down contented with a less perfect adjustment of the counter weight and weight of water. — Any person who attends to the motion of a steam-engine will perceive that the descent of the pump-rods is so far from being accelerated, that it is nearly uniform, and frequently it is sensibly retarded towards the end. We learn by the way, that it is of the utmost importance not only to have a quick production of steam, but also a very capacious dome, or empty space above the water in the boiler. In engines where this space was but four or five times the capacity of the cylinder, we have always observed a very sensible check given to the descent of the pump rods after having made half their stroke. This obliges us to employ a greater counter weight, which diminishes the column of water, or retards the working stroke; it also obliges us to employ a stronger steam, at the risk of bursting the boiler, and increases the expence of fuel.

42  
How to know the elasticity of the steam in the cylinder.

It would be a most desirable thing to get an exact knowledge of the elasticity of the steam in the cylinder; and this is by no means difficult. Take a long glass tube exactly calibered, and close at the farther end. Put a small drop of some coloured fluid into it, so as to stand at the middle nearly. — Let it be placed in a long box filled with water to keep it of a constant temperature. Let the open end communicate with the cylinder, with a cock between. The moment the steam-cock is opened, open the cock of this instrument. The drop will be pushed towards the close end of the tube, while the steam in the cylinder is more elastic than the air, and it will be drawn the other way while it is less elastic, and, by a scale properly adapted to it, the elasticity of the steam corresponding to every position of the piston may be discovered. The same thing may be done more accurately by a barometer properly constructed, so as to prevent the oscillations of the mercury.

43  
Necessary also to know the state of the cylinder during the descent of the piston.

It is equally necessary to know the state of the cylinder during the descent of the steam-piston. We have hitherto supposed  $P$  to be the full pressure of the atmosphere on the area of the piston, supposing the vacuum below it to be complete. But the inspection of our table of elasticity shows that this can never be the case, because the cylinder is always of a temperature far above  $32^{\circ}$ . We have made many attempts to discover its temperature. We have employed a thermometer in close contact with the side of the cylinder, which soon acquired a steady temperature: this was never less than  $145^{\circ}$ . We have kept a thermometer in the water which lies on the piston: this never sunk below  $135^{\circ}$ . It is probable that the cylinder within may be cooled somewhat lower; but for this opinion we cannot give any very satisfactory reason. Suppose it cooled down to  $120^{\circ}$ ; this will leave an elasticity which would support three inches of mercury. We cannot think therefore that the unbalanced pressure of the atmosphere exceeds that of 27 inches of mercury, which is about  $13\frac{1}{2}$  d pounds on a square inch, or  $10\frac{1}{2}$  on a circular inch. And this is the value which we should employ in the equation  $P = L + y$ . This question may be decided in the same way as the other, by a barometer connected with the inside of the cylinder.

And thus we shall learn the state of the moving forces in every moment of the performance, and the machine will then be as open to our examination as any water or

horse mill; and till this be done, or something equivalent, we can only guesst at what the machine is actually performing, and we cannot tell in what particulars we can lend it a helping hand. We are informed that Messrs Watt and Boulton have made this addition to some of their engines; and we are persuaded that, from the information which they have derived from it, they have been enabled to make the curious improvements from which they have acquired so much reputation and profit.

There is a circumstance of which we have as yet taken no notice, viz. the quantity of cold water injected. Here we confess ourselves unable to give any precise instructions. It is clear at first sight that no more than is absolutely necessary should be injected. It must generally be supplied by the engine, and this expends part of its power. An excess is much more hurtful by cooling the cylinder and piston too much, and therefore wasting steam during the next rise of the piston. But the determination of the proper quantity requires a knowledge, which we have not yet acquired, of the quantity of heat contained in the steam in a latent form. As much water must be injected as will absorb all this without rising near to the boiling temperature. But it is of much more importance to know how far we may cool the cylinder with advantage; that is, when will the loss of steam, during the next rise of the piston, compensate for the diminution of its elasticity during its present descent? Our table of elasticities shows us, that by cooling the cylinder to  $120^{\circ}$ , we still leave an elasticity equal to  $\frac{1}{10}$ th of the whole power of the engine; if we cool it only to  $140^{\circ}$ , we leave an elasticity of  $\frac{1}{3}$ th; if we cool it to a blood-heat, we leave an elasticity of  $\frac{1}{2}$ th. It is extremely difficult to choose among these varieties. Experience, however, informs us, that the best engines are those which use the smallest quantities of injection water. We know an exceedingly good engine having a cylinder of 30 inches and a six-foot stroke, which works with something less than  $\frac{1}{3}$ th of a cubic foot of water at each injection; and we imagine that the quantity should be nearly in the proportion of the capacity of the cylinder. Desaguliers observed, that a very good engine, with a cylinder of 32 inches, worked with 300 inches of water at each injection, which does not much exceed  $\frac{1}{3}$ th of a cubic foot. Mr Watt's observations, by means of the barometer, must have given him much valuable information in this particular, and we hope that he will not always withhold them from the public.

We have gone thus far in the examination, in order to seemingly to ascertain the motion of the engine when loaded and balanced in any known manner, and in order to discover that proportion between the moving power and the load which will produce the greatest quantity of work. The result has been very satisfactory, because the computation of the returning stroke is acknowledged to be beyond our abilities. But it has given us the opportunity of directing the reader's attention to the leading circumstances in this inquiry. By knowing the internal state of the cylinder in machines of very different goodness, we learn the connection between the state of the steam and the performance of the machine; and it is very possible that the result of a full examination may be, that in situations where fuel is expensive, it may be proper to employ a weak steam which will expend less fuel, although less work is performed

Steam-Engine.

44  
Quantity of cold water to be injected.

45  
This examination, though not satisfactory may direct the attention to the principal circumstances.

Steam-Engine.

formed by it. We shall see this confirmed in the clearest manner in some particular employments of the new engines invented by Watt and Boulton.

In the mean time, we see that the equation which we gave from the celebrated Abbé Bossut is in every respect erroneous even for the purpose which he had in view. We also see that the equation which we substituted in its place, and which was intended for determining that proportion between the counter-weight and the moving force, and the load which would render the working stroke and returning stroke of equal duration, is also erroneous, because these two motions are extremely different in kind, the one being nearly uniform, and the other nearly uniformly accelerated. This being supposed true, it should follow that the counter weight should be reduced to one half; and we have found this to be very nearly true in some good engines which we have examined.

46  
An erroneous maxim that the two motions are of equal duration.

We shall add but one observation more on this head. The practical engineers have almost made it a maxim, that the two motions are of equal duration. But the only reason which we have heard for the maxim, is, that it is awkward to see an engine go otherwise. But we doubt exceedingly the truth of this maxim, and, without being able to give any accurate determination, we think that the engine will do more work if the working stroke be made slower than the returning stroke. Suppose the engine so constructed that they are made in equal times; an addition to the counter weight will accelerate the returning stroke and retard the working stroke. But as the counter-weight is but small in proportion to the unbalanced portion of the atmospheric pressure, which is the moving force of the machine, it is evident that this addition to the counter weight must bear a much greater proportion to the counter weight than it does to the moving force, and must therefore accelerate the returning stroke much more than it retards the working stroke, and the time of both strokes taken together must be diminished by this addition and the performance of the machine improved; and this must be the case as long as the machine is not extravagantly loaded. The best machine which we have seen, in respect of performance, raises a column of water whose weight is very nearly  $\frac{2}{3}$  of the pressure of the atmosphere on the piston, making 11 strokes of six feet each per minute, and the working stroke was almost twice as slow as the other. This engine had worked pumps of 12 inches, which were changed for pumps of 14 inches, all other things remaining the same. In its former state it made from  $12\frac{1}{2}$  to  $13\frac{1}{2}$  strokes per minute, the working stroke being considerably slower than the returning stroke. The load was increased, by the change of the pumps, nearly in the proportion of 3 to 4. This had retarded the working stroke; but the performance was evidently increased in the proportion of  $3 \times 13$  to  $4 \times 11$ , or of 39 to 44. About 300 pounds were added to the counterweight, which increased the number of strokes to more than 12 per minute. No sensible change could be observed in the time of the working stroke. The performance was therefore increased in the proportion of 39 to 48. We have therefore no hesitation in saying, that the seemingly equality of the two strokes is a sacrifice to fancy. The engineer who observes the working stroke to be slow, fears that his engine may be thought feeble and unequal to its work; a similar notion has long

misled him in the construction of water-mills, especially of overhot mills; and, even now, he is submitting with hesitation and fear to the daily correction of experience.

Steam-Engine.

It is needless to engage more deeply in scientific calculations in a subject where so many of the data are so very imperfectly understood.

We venture to recommend as a maxim of construction (supposing always a large boiler and plentiful supply of pure steam unmixed with air), that the load of work be not less than 10 pounds for every square inch of the piston, and the counterweight so proportioned that the time of the returning stroke may not exceed  $\frac{2}{3}$  of that of the working stroke. A serious objection may be made to this maxim, and it deserves mature consideration. Such a load requires the utmost care of the machine, that no admission be given to the common air; and it precludes the possibility of its working in case the growth of water, or deepening the pit, should make a greater load absolutely necessary. These considerations must be left to the prudence of the engineer. The maxim now recommended relates only to the best actual performance of the engine.

47  
The load of work should not be less than 10 pounds for every square inch of the piston.

Before quitting this machine, it will not be amiss to give some easy rules, sanctioned by successful practice, for computing its performance. These will enable any artist, who can go through simple calculations, to suit the size of his engine to the task which it is to perform.

48  
Rules for computing the performance of the Steam-engine.

The circumstance on which the whole computation must be founded is the quantity of water which must be drawn in a minute and the depth of the mine; and the performance which may be expected from a good engine is at least 12 strokes per minute of six feet each, working against a column of water whose weight is equal to half of the atmospheric pressure on the steam-piston, or rather to 7,64 pounds on every square inch of its surface.

It is most convenient to estimate the quantity of water in cubic feet, or its weight in pounds, recollecting that a cubic foot of water weighs  $62\frac{1}{2}$  pounds. The depth of the pit is usually reckoned in fathoms of six feet, and the diameter of the cylinder and pump is usually reckoned in inches.

Let  $Q$  be the quantity of water to be drawn per minute in cubical feet, and  $f$  the depth of the mine in fathoms; let  $c$  be the diameter of the cylinder, and  $p$  that of the pump; and let us suppose the arms of the beam to be of equal length.

1st, To find the diameter of the pump, the area of the piston in square feet is  $p^2 \times \frac{0,7854}{144}$ . The length of the column drawn in one minute is 12 times 6 or 72 feet, and therefore its solid contents is  $p^2 \times \frac{72 \times 0,7854}{144}$  cubical feet, or  $p^2 \times 0,3927$  cubical feet. This must be equal to  $Q$ ; therefore  $p^2$  must be  $\frac{Q}{0,3927}$  or nearly

$Q \times 2\frac{1}{2}$ . Hence this practical rule: Multiply the cubical feet of water which must be drawn in a minute by  $2\frac{1}{2}$ , and extract the square root of the product: this will be the diameter of the pump in inches.

Thus suppose that 58 cubic feet must be drawn every minute; 58 multiplied by  $2\frac{1}{2}$  gives 145, of which the square



Steam-Engine.

with the friction of both, does not exceed the whole pressure exerted by the steam-engine during its working stroke; and provided that the momentum of the fly, arising from its great weight and velocity, be very great, so that the resistance of the work during one returning stroke of the steam-engine do not make any very sensible diminution of the velocity of the fly. This is evidently possible and easy. The fly may be made of any magnitude; and being exactly balanced round its axis, it will soon acquire any velocity consistent with the motion of the steam-engine. During the working stroke of the engine it is uniformly accelerated, and by its acquired momentum it produces in the beam the movement of the returning stroke; but in doing this, its momentum is shared with the inert matter of the steam-engine, and consequently its velocity diminished, but not entirely taken away. The next working stroke therefore, by pressing on it afresh, increases its remaining velocity by a quantity nearly equal to the whole that it acquired during the first stroke. We say *nearly*, but not quite equal, because the time of the second working stroke must be shorter than that of the first, on account of the velocity already in the machine. In this manner the fly will be more and more accelerated every succeeding stroke, because the pressure of the engine during the working stroke does more than restore to the fly the momentum which it lost in producing the returning movement of the steam-engine. Now suppose the working part of the machine to be added. The acceleration of the fly during each working stroke of the steam-engine will be less than it was before, because the impelling pressure is now partly employed in driving the working machine, and because the fly will lose more of its momentum during the returning stroke of the steam-engine, part of it being expended in driving the working machine. It is evident, therefore, that a time will come when the successive augmentation of the fly's velocity will cease; for, on the one hand, the continual acceleration diminishes the time of the next working stroke, and therefore the time of action of the accelerating power. The acceleration must diminish in the same proportion; and on the other hand, the resistance of the working machine generally, though not always, increases with its velocity. The acceleration ceases whenever the addition made to the momentum of the fly during a working stroke of the steam-engine is just equal to what it loses by driving the machine, and by producing the returning movement of the steam-engine.

51  
An important addition;

This must be acknowledged to be a very important addition to the engine, and though sufficiently obvious, it is ingenious, and requires considerable skill and address to make it effective (B).

The movement of the working machine, or mill of whatever kind, must be in some degree hobbling or

unequal. But this may be made quite insensible, by making the fly exceedingly large, and disposing the greatest part of its weight in the rim. By these means its momentum may be made so great, that the whole force required for driving the mill and producing the returning movement of the engine may bear a very small proportion to it. The diminution of its velocity will then be very trifling.

No counter weight is necessary here, because the returning movement is produced by the inertia of the fly. A counter weight may, however, be employed, and should be employed, viz. as much as will produce the returning movement of the steam-engine. It will do this better than the same force accumulated in the fly; for this force must be accumulated in the fly by the intervention of rubbing parts, by which some of it is lost; and it must be afterwards returned to the engine with a similar loss. But, for the same reason, it would be improper to make the counter weight also able to drive the mill during the returning stroke.

By this contrivance Mr Fitzgerald hoped to render the steam-engine of most extensive use; and he, or others associated with him, obtained a patent excluding all others from employing the steam-engine for turning a crank. They also published proposals for erecting mills of all kinds driven by steam-engines, and stated very fairly their powers and their advantages. But their proposals do not seem to have acquired the confidence of the public; for we do not know of any mill ever having been erected under this patent.

52  
But seldom or never adopted.

The great obstacle to this extensive use of the steam-engine is the prodigious expense of fuel. An engine having a cylinder of four feet diameter, working night and day, consumes about 3400 chaldron (London) of good coals in a year.

53  
The great expense of fuel

This circumstance limits the use of steam-engines exceedingly. To draw water from coal-pits, where they can be stocked with unsaleable small coal, they are of universal employment: also for valuable mines, for supplying a great and wealthy city with water, and a few other purposes where a great expence can be borne, they are very proper engines; but in a thousand cases where their unlimited powers might be vastly serviceable, the enormous expenses of fuel completely excludes them. We cannot doubt but that the attention of engineers was much directed to every thing that could promise a diminution of this expence. Every one had his particular nostrum for the construction of his furnace, and some were undoubtedly more successful than others. But science was not yet sufficiently advanced: It was not till Dr Black had made his beautiful discovery of latent heat, that we could know the intimate relation between the heat expended in boiling off a quantity of water and the quantity of steam that is produced.

54  
Limits the use of steam-engines.

5 D

Much

(B) We do not recollect at present the date of this proposal of Mr Fitzgerald; but in 1781 the Abbé Arnauld, canon of Alais in Languedoc, entertained a thought of the same kind, and proposed it for working lighters in the inland navigations; a scheme which has been successfully practised (we are told) in America. His brother, a major of engineers in the Austrian service, has carried the thing much farther, and applied it to manufactures; and the Aulic Chamber of Mines at Vienna has patronized the project: (See *Journal Encyclopedique*, 1781). But these schemes are long posterior to Mr Fitzgerald's patent, and are even later than the erection of several machines driven by steam engines which have been erected by Messrs Watt and Boulton. We think it our duty to state these particulars, because it is very usual for our neighbours on the continent to assume the credit of British inventions.

Steam-  
Engine.

Much about the time of this discovery, viz. 1763, Mr James Watt, established in Glasgow in the commercial line, was amusing himself with repairing a working model of the steam-engine which belonged to the philosophical apparatus of the university. Mr Watt was a person of a truly philosophical mind, eminently conversant in all branches of natural knowledge, and the pupil and intimate friend of Dr Black. In the course of the above mentioned amusement many curious facts in the production and condensation of steam occurred to him; among others, that remarkable fact which is always appealed to by Dr Black as the proof of the immense quantity of heat which is contained in a very minute quantity of water in the form of elastic steam. When a quantity of water is heated several degrees above the boiling point in a close digester, if a hole be opened, the steam rushes out with prodigious violence, and the heat of the remaining water is reduced, in the course of three or four seconds, to the boiling temperature. The water of the steam which has issued amounts only to a very few drops; and yet these have carried off with them the whole excess of heat from the water in the digester.

55  
Mr Watt  
discovers  
that steam  
contains an  
immense  
quantity of  
heat

56  
In his at-  
tempts to  
find out a  
way to  
husband  
this heat,

Since then a certain quantity of steam contains so great a quantity of heat, it must expend a great quantity of fuel; and no construction of furnace can prevent this. Mr Watt therefore set his invention to work to discover methods of husbanding this heat. The cylinder of his little model was heated almost in an instant, so that it could not be touched by the hand. It could not be otherwise, because it condensed the vapour by abstracting its heat. But all the heat thus communicated to the cylinder, and wasted by it on surrounding bodies, contributed nothing to the performance of the engine, and must be taken away at every injection, and again communicated and wasted. Mr Watt quickly understood the whole process which was going on within the cylinder, and which we have considered so minutely, and saw that a very considerable portion of the steam must be wasted in warming the cylinder. His first attempts were made to ascertain how much was thus wasted, and he found that it was not less than three or four times as much as would fill the cylinder and work the engine. He attempted to diminish this waste by using wooden cylinders. But though this produced a sensible diminution of the waste, other reasons forced him to give them up. He then cased his metal cylinders in a wooden case with light wood ashes between. By this, and using no more injection than was absolutely necessary for the condensation, he reduced the waste almost one half. But by using so small a quantity of cold water, the inside of the cylinder was hardly brought below the boiling temperature; and there consequently remained in it a steam of very considerable elasticity, which robbed the engine of a proportional part of the atmospherical pressure. He saw that this was unavoidable as long as the condensation was performed in the cylinder. The thought struck

57  
Discovers a  
method of  
condens-  
ing the steam  
at a little  
distance  
from the  
cylinder,

him to attempt the condensation in another place. His first experiment was made in the simplest manner. A globular vessel communicated by means of a long pipe of one inch diameter with the bottom of his little cylinder of four inches diameter and 30 inches long. This pipe had a stop-cock, and the globe was immersed in a vessel of cold water. When the piston was at the top,

and the cylinder filled with strong steam, he turned the cock. It was scarcely turned, nay he did not think it completely turned, when the sides of his cylinder (only strong tin-plate) were crushed together like an empty bladder. This surpris'd and delighted him. A new cylinder was immediately made of brass sufficiently thick, and nicely bored. When the experiment was repeated with this cylinder, the condensation was so rapid, that he could not say that any time was expended in it. But the most valuable discovery was, that the vacuum in the cylinder was, as he hoped, almost perfect. Mr Watt found, that when he used water in the boiler purged of air by long boiling, nothing that was very sensibly inferior to the pressure of the atmosphere on the piston could hinder it from coming quite down to the bottom of the cylinder. This alone was gaining a great deal, for in most engines the remaining elasticity of the steam was not less than  $\frac{1}{4}$ th of the atmospherical pressure, and therefore took away  $\frac{1}{4}$ th of the power of the engine.

Having gained this capital point, Mr Watt found many difficulties to struggle with before he could get the machine to continue its motion. The water produced from the condensed steam, and the air which was extricated from it, or which penetrated through unavoidable leaks, behoved to accumulate in the condensing vessel, and could not be voided in any way similar to that adopted in Newcomen's engine. He took another method: He applied pumps to extract both, which were worked by the great beam. The contrivance is easy to any good mechanic; only we must observe, that the piston of the water-pump must be under the surface of the water in the condenser, that the water may enter the pump by its own weight, because there is no atmospherical pressure there to force it in. We must also observe, that a considerable force is necessarily expended here, because, as there is but one stroke for rarefying the air, and this rarefaction must be nearly complete, the air-pump must be of large dimensions, and its piston must act against the whole pressure of the atmosphere. Mr Watt, however, found that this force could be easily spared from his machine, already so much improved in respect of power.

Thus has the steam-engine received a very considerable improvement. The cylinder may be allowed to remain very hot; nay, boiling hot, and yet the condensation be completely performed. The only elastic steam that now remains is the small quantity in the pipe of communication. Even this small quantity Mr Watt at last got rid of, by admitting a small jet of cold water up this pipe to meet the steam in its passage to the condenser. This both cooled this part of the apparatus in a situation where it was not necessary to warm it again, and it quickened the condensation. He found at last that the small pipe of communication was of itself sufficiently large for the condensation, and that no separate vessel, under the name of condenser, was necessary. This circumstance shows the prodigious rapidity of the condensation. We may add, that unless this had been the case, his improvement would have been vastly diminished; for a large condenser would have required a much larger air-pump, which would have expended much of the power of the engine. By these means the vacuum below the piston is greatly improved: for it will appear clear to any person who understands the subject, that as long as any part of the condenser is

Steam  
Engine

58  
And re-  
moves the  
difficultie  
which at-  
tended the  
improvement  
by means of  
pumps.

59  
Observa-  
tions on the  
advantages  
of these dis-  
coveries.

kept

Steam-Engine.

kept of a low temperature, it will abstract and condense the vapour from the warmer parts, till the whole acquires the elasticity corresponding to the coldest part. By the same means much of the waste is prevented, because the cylinder is never cooled much below the boiling temperature. Many engines have been erected by Mr Watt in this form, and their performance gave universal satisfaction.

We have contented ourselves with giving a very slight description without a figure of this improved engine, because we imagine it to be of very easy comprehension, and because it is only a preparation for still greater improvements, which, when understood, will at the same time leave no part of this more simple form unexplained.

60  
Mr Watt makes the piston descend by the force of steam.

During the progress of these improvements Mr Watt made many experiments on the quantity and density of the steam of boiling water. These fully convinced him, that although he had greatly diminished the waste of steam, a great deal yet remained, and that the steam expended during the rise of the piston was at least three times more than what would fill the cylinder. The cause of this was very apparent. In the subsequent descent of the piston, covered with water much below the boiling temperature, the whole cylinder was necessarily cooled and exposed to the air. Mr Watt's fertile genius immediately suggested to him the expedient of employing the elasticity of the steam from the boiler to impel the piston down the cylinder, in place of the pressure of the atmosphere; and thus he restored the engine to its first principles, making it an engine *really moved by steam*. As this is a new epoch in its history, we shall be more particular in the description; at the same time still restricting ourselves to the essential circumstances, and avoiding every peculiarity which is to be found in the prodigious varieties which Mr Watt has introduced into the machines which he has erected, every individual of which has been adapted to local circumstances, or diversified by the progress of Mr Watt's improvements.

Plate  
CCCLXXVIII.  
61  
Description of the machine after these improvements were added.

Let A (fig. 9.) represent the boiler. This has received great improvements from his complete acquaintance with the procedure of nature in the production of steam. In some of his engines the fuel has been placed in the midst of the water, surrounded by an iron or copper vessel, while the exterior boiler was made of wood, which transmits, and therefore wastes the heat very slowly. In others, the flame not only plays round the whole outside, as in common boilers, but also runs along several flues which are conducted through the midst of the water. By such contrivances the fire is applied to the water in a most extensive surface, and for a long time, so as to impart to it the greatest part of its heat. So skilfully was it applied in the Albion Mills, that although it was perhaps the largest engine in the kingdom, its unconsumed smoke was inferior to that of a very small brew-house. In this second engine of Mr Watt, the top of the cylinder is shut up by a strong metal plate *g h*, in the middle of which is a collar or box of leathers *k l*, formed in the usual manner of a jack-head pump, through which the piston rod *P D*, nicely turned and polished, can move up and down, without allowing any air to pass by its sides. From the dome of the boiler proceeds a large pipe *B C I O Q*, which, after reaching the cylinder with its horizontal part *BC*,

Steam-Engine.

descends parallel to its side, sending off two branches, *viz.* *IM* to the top of the cylinder, and *ON* to its bottom. At *I* is a puppet valve opening from below upwards. At *L*, immediately below this branch, there is a similar valve, also opening from below upwards. The pipe descends to *Q*, near the bottom of a large cistern *c d e f*, filled with cold water constantly renewed. The pipe is then continued horizontally along the bottom of this cistern (but not in contact), and terminates at *R* in a large pump *S T*. The piston *S* has clack valves opening upwards, and its rod *S s*, passing through a collar of leathers at *T*, is suspended by a chain to a small arch head on the outer arm of the beam. There is a valve *R* in the bottom of this pump, as usual, which opens when pressed in the direction *Q R*, and shuts against a contrary pressure. This pump delivers its contents into another pump *X Y*, by means of the small pipe *X*, which proceeds from its top. This second pump has a valve at *X*, and a clack in its piston *Z* as usual, and the piston rod *Z z* is suspended from another arch head on the outer arm of the beam. The two valves *I* and *L* are opened and shut by means of spanners and handles, which are put in motion by a plug frame, in the same manner as in Newcomen's engine.

Lastly, there may be observed a crooked pipe *ab o*, which enters the upright pipe laterally a little above *Q*. This has a small jet hole at *o*; and the other end *a*, which is considerably under the surface of the water of the condensing cistern, is covered with a puppet valve *v*, whose long stalk *v u* rises above the water, and may be raised or lowered by hand or by the plug beam. The valves *R* and *X* and the clacks in the pistons *S* and *Z* are opened or shut by the pressures to which they are immediately exposed.

This figure is not an exact copy of any of Mr Watt's engines, but has its parts so disposed that all may come distinctly into view, and exactly perform their various functions. It is drawn in its quiescent position, the outer end of the beam preponderating by the counter weight, and the piston *P* at the top of the cylinder, and the pistons *S* and *Z* in their lowest situations.

In this situation let us suppose that a vacuum is (by any means) produced in all the space below the piston, the valve *I* being shut. It is evident that the valve *R* will also be shut, as also the valve *v*. Now let the valve *I* be opened. The steam from the boiler, as elastic as common air, will rush into the space above the piston, and will exert on it a pressure as great as that of the atmosphere. It will therefore press it down, raise the outer end of the beam, and cause it to perform the same work as an ordinary engine.

When the piston *P* has reached the bottom of the cylinder, the plug frame shuts the valve *I*, and opens *L*. By so doing the communication is open between the top and bottom of the cylinder, and nothing hinders the steam which is above the piston from going along the passage *M L O N*. The piston is now equally affected on both sides by the steam, even though a part of it is continually condensed by the cylinder, and in the pipe *I O Q*. Nothing therefore hinders the piston from being dragged up by the counter weight, which acts with its whole force, undiminished by any remaining unbalanced elasticity of steam. Here therefore this form of the engine has an advantage (and by no means

Steam-Engine.

a small one) over the common engines, in which a great part of the counter weight is expended in overcoming unbalanced atmospheric pressure.

Whenever the piston P arrives at the top of the cylinder, the valve L is shut by the plug frame, and the valves I and v are opened. All the space below the piston is at this time occupied by the steam which came from the upper part of the cylinder. This being a little wasted by condensation, is not quite a balance for the pressure of the atmosphere. Therefore, during the ascent of the piston, the valve R was shut, and it remains so. When, therefore, the valve v is opened, the cold water of the cistern must spout up through the hole o, and condense the steam. To this must be added the coldness of the whole pipe O Q S. As fast as it is condensed, its place is supplied by steam from the lower part of the cylinder. We have already remarked, that this successive condensation is accomplished with astonishing rapidity. In the mean time, steam from the boiler presses on the upper surface of the piston. It must therefore descend as before, and the engine must perform a second working stroke.

But in the mean time the injection water lies in the bottom of the pipe O Q R, heated to a considerable degree by the condensation of the steam; also a quantity of air has been disengaged from it and from the water in the boiler. How is this to be discharged?—This is the office of the pumps ST and XY. The capacity of ST is very great in proportion to the space in which the air and water are lodged. When, therefore, the piston S has got to the top of its course, there must be a vacuum in the barrel of this pump, and the water and air must open the valve R and come into it. When the piston S comes down again in the next returning stroke, this water and air gets through the valve of the piston; and in the next working stroke they are discharged by the piston into the pump XY, and raised by its piston. The air escapes at Y, and as much of the water as is necessary is delivered into the boiler by a small pipe Y g to supply its waste. It is a matter of indifference whether the pistons S and Z rise with the outer or inner end of the beam, but it is rather better that they rise with the inner end: They are otherwise drawn here, in order to detach them from the rest and show them more distinctly.

Such is Mr Watt's second engine. Let us examine its principles, that we may see the causes of its avowed and great superiority over the common engines.

62  
Causes of its superiority over common engines are, the full operation of the counter weight,

We have already seen one ground of superiority, the full operation of the counter weight. We are authorized by careful examination to say, that in the common engines at least one-half of the counter weight is expended in counteracting an unbalanced pressure of the air on the piston during its ascent. In many engines, which are not the worst, this extends to  $\frac{3}{4}$ th of the whole pressure. This is evident from the examination of the engine at Montrelais by Bossut. This makes a very great counter weight necessary, which exhausts a proportional part of the moving force.

63  
And great saving of steam.

But the great advantage of Mr Watt's form is the almost total annihilation of the waste of steam by condensation in the cylinder. The cylinder is always boiling hot, and therefore perfectly dry. This must be evident to any person who understands the subject. By the time that Mr Watt had completed his improvements, his

Steam-Engine.

experiments on the production of steam had given him a pretty accurate knowledge of its density; and he found himself authorized to say, that the quantity of steam employed did not exceed twice as much as would fill the cylinder, so that not above one half was unavoidably wasted. But before he could bring the engine to this degree of perfection, he had many difficulties to overcome: He inclosed the cylinder in an outer wooden case at a small distance from it. This diminished the expence of heat by communication to surrounding bodies. Sometimes he allowed the steam from the boiler to occupy this interval. This undoubtedly prevented all dissipation from the inner cylinder; but in its turn it dissipated much heat by the outer case, and a very sensible condensation was observed between them. This has occasioned him to omit this circumstance in some of his best engines. We believe it was omitted in the Albion Mills.

The greatest difficulty was to make the great piston tight. The old and effectual method, by water lying on it, was inadmissible. He was therefore obliged to have his cylinders most nicely bored, perfectly cylindrical, and finely polished; and he made numberless trials of different soft substances for packing his piston, which should be tight without enormous friction, and which should long remain so, in a situation perfectly dry, and hot almost to burning.

After all that Mr Watt has done in this respect, he thinks that the greatest part of the waste of steam which he still perceives in his engines arises from the unavoidable escape by the sides of the piston during its descent.

But the fact is, that an engine of this construction, of the same dimensions with a common engine, making the same number of strokes of the same extent, does not consume above one fourth part of the fuel that is consumed by the best engines of the common form. It is also a very fortunate circumstance, that the performance of the engine is not immediately destroyed, nor indeed sensibly diminished, by a small want of tightness in the piston. In the common engine, if air get in, in this way, it immediately puts a stop to the work; but although even a considerable quantity of steam get past the piston during its descent, the rapidity of condensation is such, that hardly any diminution of pressure can be observed, and the waste of steam is the only inconvenience.

Mr Watt's penetration soon discovered another most valuable property of this engine. When an engine of the common form is erected, the engineer must make an accurate estimate of the work to be performed, and must proportion his engine accordingly. He must be careful that it be *fully* able to execute its task; but its power must not exceed its load in any extravagant degree. This would produce a motion which is too rapid, and which, being alternately in opposite directions, would occasion jolts which no building or machinery could withstand. Many engines have been shattered by the pumps drawing air; or a pump-rod breaking; by which accidents the steam-piston descends with such rapidity that every thing gives way. But in most operations of mining, the task of the engine increases, and it must be so constructed at first as to be able to bear this addition. It is very difficult to manage an engine that is much superior to its task; and the easiest way is,

64  
Another valuable property of it



Steam-Engine.

Steam-Engine.

to have it almost full loaded, and to work it only during a few hours each day, and allow the pit water to accumulate during its repose. This increases the first cost, and wastes fuel during the inaction of the engine.

regulated the pins of the plug-frame, in such a manner that the valve should shut the moment that the piston had descended a certain proportion (suppose one-fourth, one-third, one half, &c.) of the cylinder. So far the cylinder was occupied by steam as elastic as common air. In pressing the piston farther down, it behoved the steam to expand, and its elasticity to diminish. It is plain that this could be done in any degree we please, and that the adjustment can be varied in a minute, according to the exigency of the case, by moving the plug pins.

65  
Is, that it can always be exactly fitted to the load which happens to be on it.

But this new engine can at all times be exactly fitted (at least during the working stroke) to the load of work that then happens to be on it. We have only to administer steam of a proper elasticity. At the first erection the engine may be equal to twice its task, if the steam admitted above the cylinder be equal to that of common boiling water; but when once the ebullition is fairly commenced, and the whole air expelled from all parts of the apparatus, it is evident, that by damping the fire, steam of half this elasticity may be continually supplied, and the water will continue boiling although its temperature does not exceed 185° of Fahrenheit's thermometer. This appears by inspecting our table of vaporous elasticity, and affords another argument for rendering that table more accurate by new experiments. We hope that Mr Watt will not withhold from the public the knowledge which he has acquired on this subject. It may very possibly result from an accurate investigation, that it would be advisable to work our steam-engines with weak steams, and that the diminution of work may be more than compensated by the diminution of fuel. It is more probable indeed, and it is Mr Watt's opinion, that the contrary is the case, and that it is much more economical to employ great heats. At any rate, the decision of this question is of great importance for improving the engine; and we see, in the mean time, that the engine can at all times be fitted so as to perform its task with a moderate and manageable motion, and that as the task increases we can increase the power of the engine.

In the mean time, it must be observed, that the pressure on the piston is continually changing, and consequently the accelerating force. The motion therefore will no longer be uniformly accelerated: it will approach much faster to uniformity; nay, it may be retarded, because although the pressure on the piston at the beginning of the stroke may exceed the resistance of the load, yet when the piston is near the bottom the resistance may exceed the pressure. Whatever may be the law by which the pressure on the piston varies, an ingenious mechanic may contrive the connecting machinery in such a way that the chains or rods at the outer end of the beam shall continually exert the same pressure, or shall vary their pressure according to any law he finds most convenient. It is in this manner that the watchmaker, by the form of the fuzee, produces an equal pressure on the wheel-work by means of a very unequal action of the main-spring. In like manner, by making the outer arch heads portions of a proper spiral instead of a circle, we can regulate the force of the beam at pleasure.

66  
One inconvenience

But the method now proposed has a great inconvenience. While the steam is weaker than the atmosphere, there is an external force tending to squeeze in the sides and bottom of the boiler. This could not be resisted when the difference is considerable, and common air would rush in through every crevice of the boiler and soon choke the engine: it must therefore be given up.

Thus we see how much more manageable an engine is in this form than Newcomen's was, and also more easily investigated in respect of its power in its various positions. The knowledge of this last circumstance was of mighty consequence, and without it no notion could be formed of what it could perform. This suggested to Mr Watt the use of the barometer communicating with the cylinder; and by the knowledge acquired by these means has the machine been so much improved by its ingenious inventor.

67  
Remedied in some degree.

But the same effect will be produced by diminishing the passage for the steam into the cylinder. For this purpose, the puppet valve by which the steam enters the cylinder was made in the form of a long taper spigot, and it was lodged in a cone of the same shape; consequently the passage could be enlarged or contracted at pleasure by the distance to which the inner cone was drawn up.

We must not omit in this place one deduction made by Mr Watt from his observations, which may be called a discovery of great importance in the theory of the engine.

68  
But the remedy attended with some difficulties;

In this way several engines were constructed, and the general purpose of suiting the power of the engine to its task was completely answered; but (as the mathematical reader will readily perceive) it was extremely difficult to make this adjustment precise and constant. In a great machine like this, going by jerks, it was hardly possible that every successive motion of the valve should be precisely the same. This occasioned very sensible irregularities in the motion of the engine, which increased and became hazardous when the joints worked loose by long use.

Let ABCD (fig. 10.) represent a section of the cylinder of a steam-engine, and EF the surface of its piston. Let us suppose that the steam was admitted while EF was in contact with AB, and that as soon as it had pressed it down to the situation EF the steam cock is shut. The steam will continue to press it down, and as the steam expands its pressure diminishes. We may express its pressure (exerted all the while the piston moves from the situation AB to the situation EF) by the line EF. If we suppose the elasticity of the steam proportional to its density, as is nearly the case with air, we may express the pressure on the piston in any other position, such as KL or DC, by KL and Dc, the ordinates of a rectangular hyperbola F/c, of which AE, AB are the asymptotes, and A the centre. The accumulated pressure during the motion of the piston from EF to DC will be expressed by the area EFcDE, and the pressure during the whole motion by the area ABF c DA.

69  
Which Mr Watt's fertile genius completely removes.

Mr Watt's genius, always fertile in resources, found out a complete remedy for all these inconveniences. Making the valve of the ordinary form of a puppet clack, he adjusted the button of its stalk or tail so that it should always open full to the same height. He then

Steam-  
Engine.

Now it is well known that the area  $EFcDE$  is equal to  $ABFE$  multiplied by the hyperbolic logarithm of  $\frac{AD}{AE}$ ,  $= L. \frac{AD}{AE}$ , and the whole area  $ABFcDA$  is  $= ABFE \times (1 + L. \frac{AD}{AE})$ .

Thus let the diameter of the piston be 24 inches, and the pressure of the atmosphere on a square inch be 14 pounds; the pressure on the piston is 6333 pounds. Let the whole stroke be 6 feet, and let the steam be stopped when the piston has descended 18 inches, or 1,5 feet. The hyperbolic logarithm of  $\frac{6}{1,5}$  is 1,3862943. Therefore the accumulated pressure  $ABFcDA$  is  $= 6333 \times 2,3862943, = 15114$  pounds.

As few professional engineers are possessed of a table of hyperbolic logarithms, while tables of common logarithms are or should be in the hands of every person who is much engaged in mechanical calculations, let the following method be practised. Take the common logarithm of  $\frac{AD}{AE}$ , and multiply it by 2,3026; the product is the hyperbolic logarithm of  $\frac{AD}{AE}$ .

The accumulated pressure while the piston moves from  $AB$  to  $EF$  is  $6333 \times 1$ , or simply 6333 pounds. Therefore the steam while it expands into the whole cylinder adds a pressure of 8731 pounds.

Suppose that the steam had got free admission during the whole descent of the piston, the accumulated pressure would have been  $6333 \times 6$ , or 25332 pounds.

Here Mr Watt observed a remarkable result. The steam expended in this case would have been four times greater than when it was stopped at  $\frac{1}{4}$ th, and yet the accumulated pressure is not twice as great, being nearly  $\frac{2}{3}$ ds. One-fourth of the steam performs nearly  $\frac{2}{3}$ ths of the work, and an equal quantity performs more than twice as much work when thus admitted during  $\frac{1}{4}$ th of the motion.

This is a curious and an important information, and the advantage of this method of working a steam-engine increases in proportion as the steam is sooner stopped; but the increase is not great after the steam is rarefied four times. The curve approaches near to the axis, and small additions are made to the area. The expense of such great cylinders is considerable, and may sometimes compensate this advantage.

Let the steam be stopped at	Its performance is mult.
$\frac{1}{2}$	1,7
$\frac{1}{3}$	2,1
$\frac{1}{4}$	2,4
$\frac{1}{5}$	2,6
$\frac{1}{6}$	2,8
$\frac{1}{7}$	3,
$\frac{1}{8}$	3,2
&c.	&c.

It is very pleasing to observe so many unlooked-for advantages resulting from an improvement made with the sole view of lessening the waste of steam by condensation. While this purpose is gained, we learn how to husband the steam which is not thus wasted. The engine becomes more manageable, and is more easily adapted to every variation in its task, and all its powers are more easily computed.

Steam-  
Engine.

The active mind of its ingenious inventor did not stop here: It had always been matter of regret that one half of the motion was unaccompanied by any work. It was a very obvious thing to Mr Watt, that as the steam admitted above the piston pressed it down, so steam admitted below the piston pressed it up with the same force, provided that a vacuum were made on its upper side. This was easily done, by connecting the lower end of the cylinder with the boiler and the upper end with the condenser.

Fig. 11. is a representation of this construction exactly copied from Mr Watt's figure accompanying his specification. Here  $BB$  is a section of the cylinder, surrounded at a small distance by the case  $1111$ . The section of the piston  $A$ , and the collar of leathers which embraces the piston rod, gives a distinct notion of its construction, of the manner in which it is connected with the piston rod, and how the packing of the piston and collar contributes to make all tight.

Plate  
ccccxxx  
7  
Description  
of Mr  
Watt's  
steam-en-  
gine in  
its most im-  
proved  
state.

From the top of the cylinder proceeds the horizontal pipe. Above the letter  $D$  is observed the seat of the steam valve, communicating with the box above it. In the middle of this may be observed a dark shaded circle. This is the mouth of the upper branch of the steam pipe coming from the boiler. Beyond  $D$ , below the letter  $N$ , is the seat of the upper condensing valve. The bottom of the cylinder is made spherical, fitting the piston, so that they may come into entire contact. Another horizontal pipe proceeds from this bottom. Above the letter  $E$  is the seat of the lower steam valve, opening into the valve box. This box is at the extremity of another steam pipe marked  $C$ , which branches off from the upper horizontal part, and descends obliquely, coming forward to the eye. The lower part is represented as cut open, to show its interior conformation. Beyond this steam valve, and below the letter  $F$ , may be observed the seat of the lower condensing valve. A pipe descends from hence, and at a small distance below unites with another pipe  $GG$ , which comes down from the upper condensing valve  $N$ . These two education-pipes thus united go downwards, and open at  $L$  into a rectangular box, of which the end is seen at  $L$ . This box goes backward from the eye, and at its farther extremity communicates with the air-pump  $K$ , whose piston is here represented in section with its butterfly valves. The piston delivers the water and air laterally into another rectangular box  $M$ , darkly shaded, which box communicates with the pump  $I$ . The piston-rods of this and of the air-pump are suspended by chains from a small arch head on the inner arm of the great beam. The lower part of the education-pipe, the horizontal box  $L$ , the air-pump  $K$ , with the communicating box  $M$  between it and the pump  $I$ , are all immersed in the cold water of the condensing cistern. The box  $L$  is made flat, broad, and shallow, in order to increase its surface and accelerate the condensation. But that this may be performed with the greatest expedition, a small pipe  $H$ , open below (but occasionally stopped by a plug valve), is inserted laterally into the education-pipe  $G$ , and then divides into two branches; one of which reaches within a foot or two of the upper valve  $N$ , and the other approaches as near to the valve  $F$ .

As it is intended by this construction to give the piston a strong impulse in both directions, it will not be proper

proper to suspend its rod by a chain from the great beam; for it must not only pull down that end of the beam, but also push it upwards. It may indeed be suspended by double chains like the pistons of the engines for extinguishing fires; and Mr Watt has accordingly done so in some of his engines. But in his drawing from which this figure is copied, he has communicated the force of the piston to the beam by means of a toothed rack OO, which engages or works in the toothed sector QQ on the end of the beam. The reader will understand, without any farther explanation, how the impulse given to the piston in either direction is thus transmitted to the beam without diminution. The fly XX, with its pinion Y, which also works in the toothed arch QQ, may be supposed to be removed for the present, and will be considered afterwards.

We shall take the present opportunity of describing Mr Watt's method of communicating the force of the steam-engine to any machine of the rotatory kind. VV represents the rim and arms of a very large and heavy metalline fly. On its axis is the concentric toothed wheel U. There is attached to the end of the great beam a strong and stiff rod TT, to the lower end of which a toothed wheel W is firmly fixed by two bolts, so that it cannot turn round. This wheel is of the same size and in the same vertical plane with the wheel U; and an iron link or strap (which cannot be seen here, because it is on the other side of the two wheels) connects the centres of the two wheels, so that the one cannot quit the other. The engine being in the position represented in the figure, suppose the fly to be turned once round by any external force in the direction of the darts. It is plain, that since the toothed wheels cannot quit each other, being kept together by the link, the inner half (that is, the half next the cylinder) of the wheel U will work on the inner half of the wheel W, so that at the end of the revolution of the fly the wheel W must have got to the top of the wheel U, and the outer end of the beam must be raised to its highest position. The next revolution of the fly will bring the wheel W and the beam connected with it to their first positions; and thus every two revolutions of the fly will make a complete period of the beam's reciprocating movements. Now, instead of supposing the fly to drive the beam, let the beam drive the fly. The motions must be perfectly the same, and the ascent or descent of the piston will produce one revolution of the fly.

A side view of this apparatus is given in fig. 12. marked by the same letters of reference. This shows the situation of parts which were fore-shortened in fig. 11. particularly the descending branch C of the steam pipe, and the situation and communications of the two pumps, K and I. S, S is the horizontal part of the steam pipe. 9 is a part of it whose box is represented by the dark circle of fig. 11. D is the box of the steam clack, and the little circle at its corner represents the end of the axis which turns it, as will be described afterwards. N is the place of the upper eduction valve. A part only of the upper eduction-pipe G is represented, the rest being cut off, because it would have covered the descending steam pipe CC. When continued down, it comes between the eye and the box E of the lower steam valve, and the box F of the lower eduction valve.

Let us now trace the operation of this machine through all its steps. Recurring to fig. 11. let us suppose that the lower part of the cylinder BB is exhausted of all elastic fluids; that the upper steam valve D and the lower eduction valve F are open, and that the lower steam valve E and upper eduction valve N are shut. It is evident that the piston must be pressed toward the bottom of the cylinder, and must pull down the end of the working beam by means of the toothed rack OO and sector QQ, causing the other end of the beam to urge forward the machinery with which it is connected. When the piston arrives at the bottom of the cylinder, the valves D and F are shut by the plug frame, and E and N are opened. By this last passage the steam gets into the eduction-pipe, where it meets with the injection water, and is rapidly condensed. The steam from the boiler enters at the same time by E, and pressing on the lower side of the piston, forces it upwards, and by means of the toothed rack OO and toothed sector QQ forces up that end of the working beam, and causes the other end to urge forward the machinery with which it is connected: and in this manner the operation of the engine may be continued for ever.

The injection water is continually running into the eduction-pipe, because condensation is continually going on, and therefore there is a continual atmospheric pressure to produce a jet. The air which is disengaged from the water, or enters by leaks, is evacuated only during the rise of the piston of the air-pump K. When this is very copious, it renders a very large air-pump necessary; and in some situations Mr Watt has been obliged to employ two air-pumps, one worked by each arm of the beam. This in every case expends a very considerable portion of the power, for the air-pump is always working against the whole pressure of the atmosphere.

It is evident that this form of the engine, by maintaining an almost constant and uninterrupted impulsion, is much fitter for driving any machinery of continued motion than any of the former engines, which were inactive during half of their motion. It does not, however, seem to have this superiority when employed to draw water: But it is equally fitted for this task. Let the engine be loaded with twice as much as would be proper for it if a single stroke engine, and let a fly be connected with it. Then it is plain that the power of the engine during the rise of the steam piston will be accumulated in the fly; and this, in conjunction with the power of the engine during the descent of the steam piston, will be equal to the whole load of water.

In speaking of the steam and eduction valves, we said that they were all puppet valves. Mr Watt employed cocks, and also sliding valves, such as the regulator on steam-valves in the old engines. But he found them always lose their tightness after a short time. This is not surprising, when we consider that they are always perfectly dry, and almost burning hot. He was therefore obliged to change them all for puppet clacks, which, when truly ground and nicely fitted in their motions at first, are not found to go out of order by any length of time. Other engineers now universally use them in the old form of the steam-engine, without the same reasons, and merely by servile and ignorant imitation.

The way in which Mr Watt opens and shuts these valves is as follows. Fig. 13. represents a clack with

Steam-  
Eng ne.

its seat and box. Suppose it one of the eduction valves. HH is part of the pipe which introduces the steam, and GG is the upper part of the pipe which communicates with the condenser. At EE may be observed a piece more faintly shaded than the surrounding parts. This is the seat of the valve, and is a brass or bell-metal ring turned conical on the outside, so as to fit exactly into a conical part of the pipe GG. These two pieces are fitted by grinding; and the cone being of a long taper, the ring sticks firmly in it, especially after having been there for some time and united by rust. The clack itself is a strong brass plate D, turned conical on the edge, so as to fit the conical or sloping inner edge of the seat. These are very nicely ground on each other with emery. This conical joining is much more obtuse than the outer side of the ring; so that although the joint is air-tight, the two pieces do not stick strongly together. The clack has a round tail DG, which is freely moveable up and down in the hole of a cross piece FF. On the upper side of the valve is a strong piece of metal DC firmly joined to it, one side of which is formed into a toothed rack. A is the section of an iron axle which turns in holes in the opposite sides of the valve-box, where it is nicely fitted by grinding, so as to be air-tight. Collets of thick leather, well soaked in melted tallow and rosin, are screwed on the outside of these holes to prevent all ingress of air. One end of this axis projects a good way without the box, and carries a spanner or handle, which is moved by the plug-frame. To this axis is fixed a strong piece of metal B, the edge of which is formed into an arch of a circle having the axis A in its centre, and is cut into teeth, which work in the teeth of the rack DC. K is a cover which is fixed by screws to the top of the box H J J H, and may be taken off in order to get at the valve when it needs repairs.

From this description it is easy to see that by turning the handle which is on the axis A, the sector B must lift up the valve by means of its toothed rack DC, till the upper end of the rack touch the knob or button K. Turning the handle in the opposite direction brings the valve down again to its seat.

This valve is extremely tight. But in order to open it for the passage of the steam, we must exert a force equal to the pressure of the atmosphere. This in a large engine is a very great weight. A valve of six inches diameter sustains a pressure not less than 400 pounds. But this force is quite momentary, and hardly impedes the motion of the engine; for the instant the valve is detached from its seat, although it has not moved the 100th part of an inch, the pressure is over. Even this little inconvenience has been removed by a delicate thought of Mr Watt. He has put the spanner in such a position when it begins to raise the valve, that its mechanical energy is almost infinitely great. Let QR (fig. 14.) be part of the plug-frame descending, and P one of its pins just going to lay hold of the spanner NO moveable round the axis N. On the same axis is another arm NM connected by a joint with the leader MI, which is connected also by a joint with the spanner LA that is on the axis A of the sector within the valve-box. Therefore when the pin P pushes down the spanner NO, the arm NM moves sidewise and pulls down the spanner AL by means of the connecting rod. Things are so disposed, that when the cock is shut, LM

and MN are in one straight line. The intelligent mechanic will perceive that, in this position, the force of the lever O N M is insuperable. It has this further advantage, that if any thing should tend to force open the valve, it would be ineffectual; for no force exerted at A, and transmitted by the rod L M, can possibly push the joint M out of its position. Of such importance is it to practical mechanics, that its professors should be persons of penetration as well as knowledge. Yet this circumstance is unheeded by hundreds who have servilely copied from Mr Watt, as may be seen in every engine that is puffed on the public as a discovery and an improvement. When these puppet valves have been introduced into the common engine, we have not seen one instance where this has been attended to; certainly because its utility has not been observed; and there is one situation where it is of more consequence than in Mr Watt's engine, viz. in the injection-cock. Here the valve is drawn back into a box, where the water is so awkwardly disposed round it that it can hardly get out of its way, and where the pressure even exceeds that of the atmosphere. Indeed this particular substitution of the button-valve for the cock is most injudicious.

We postponed any account of the office of the fly XX (fig. 11.), as it is not of use in an engine regulated by the fly V V. The fly XX is only for regulating the reciprocating motion of the beam when the steam is not admitted during the whole descent of the piston. This it evidently must render more uniform, accumulating a momentum equal to the whole pressure of the full supply of steam, and then sharing it with the beam during the rest of the descent of the piston.

When a person properly skilled in mechanics and chemistry reviews these different forms of Mr Watt's steam-engine, he will easily perceive them susceptible of many intermediate forms, in which any one or more of the distinguishing improvements may be employed. The first great improvement was the condensation in a separate vessel. This increased the original powers of the engine, giving to the atmospheric pressure and to the counter weight their full energy; at the same time the waste of steam is greatly diminished. The next improvement by employing the pressure of the steam instead of that of the atmosphere, aimed only at a still farther diminution of the waste; but was fertile in advantages, rendering the machine more manageable, and particularly enabling us at all times, and without trouble, to suit the power of the engine to its load of work, however variable and increasing; and brought into view a very interesting proposition in the mechanical theory of the engine, viz. that the whole performance of a given quantity of steam may be augmented by admitting it into the cylinder only during a part of the piston's motion. Mr Watt has varied the application of this proposition in a thousand ways; and there is nothing about the machine which gives more employment to the sagacity and judgment of the engineer. The third improvement of the double impulse may be considered as the finishing touch given to the engine, and renders it as uniform in its action as any water-wheel. In the engine in its most perfect form there does not seem to be above one-fourth of the steam wasted by warming the apparatus; so that it is not possible to make it one-fourth part more powerful than it is at present. The only thing that seems susceptible of considerable improvement

Steam-  
Eng ne.72  
Review of  
Mr Watt's  
three great  
improvements.

Fig. 2.

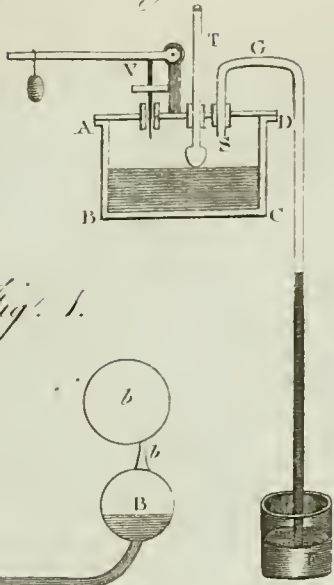

Fig. 1.

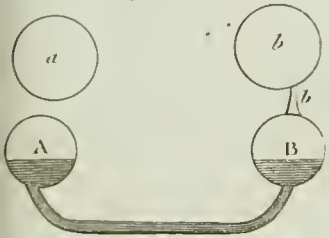
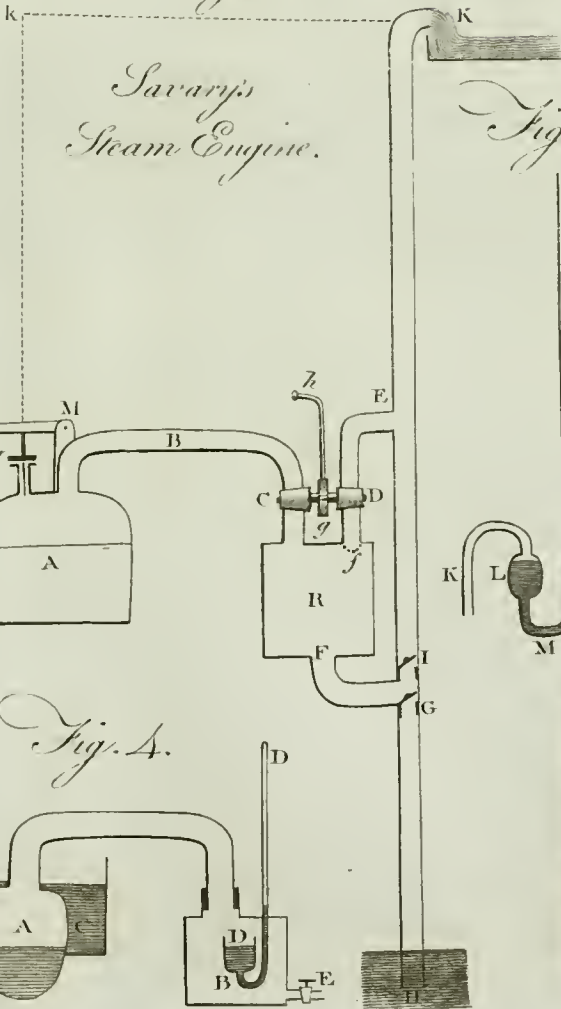

Fig. 6.



Savary's Steam Engine.

Fig. 3.

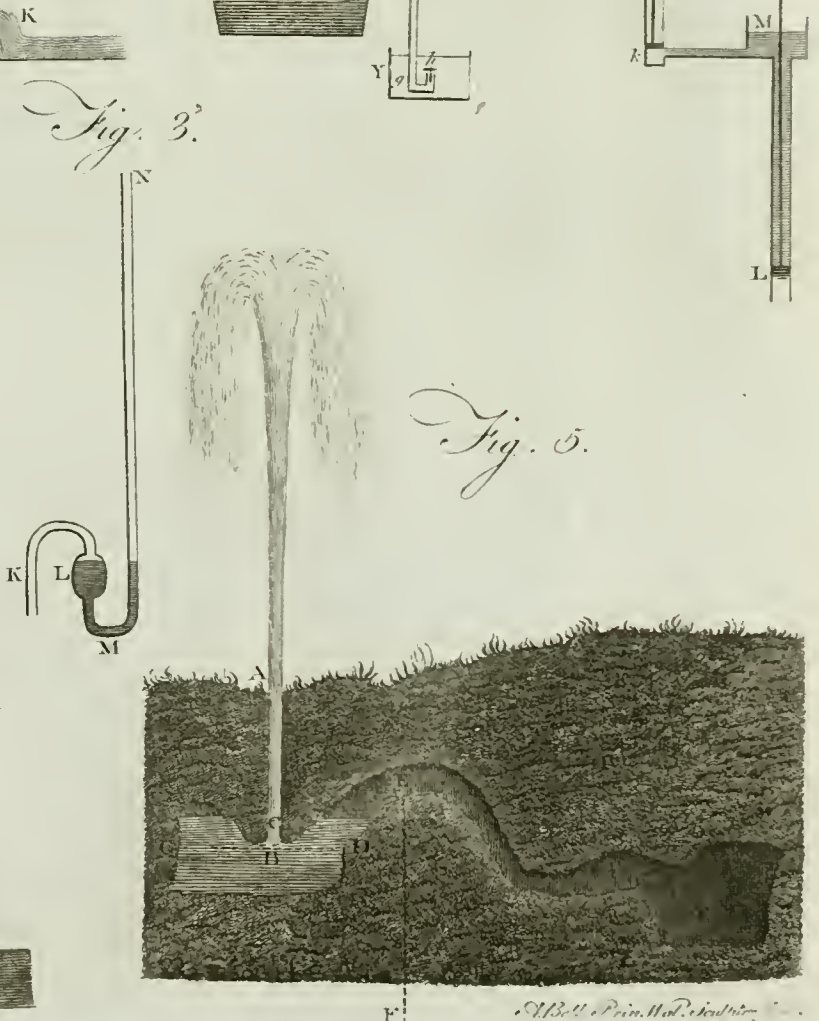
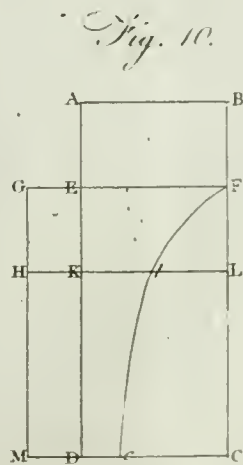
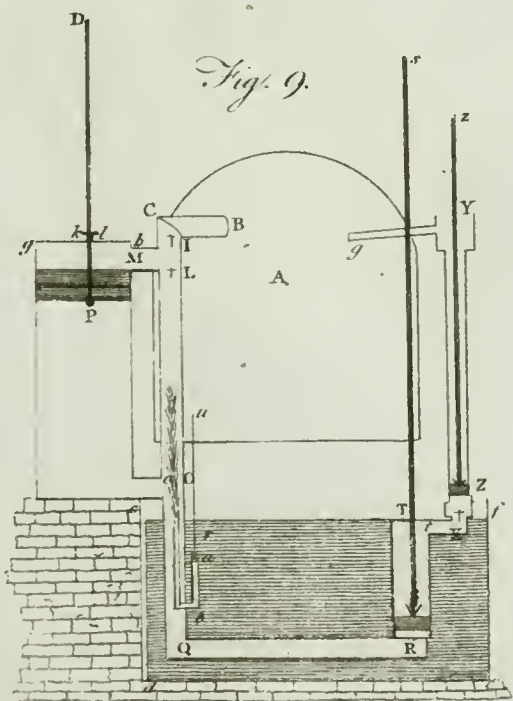
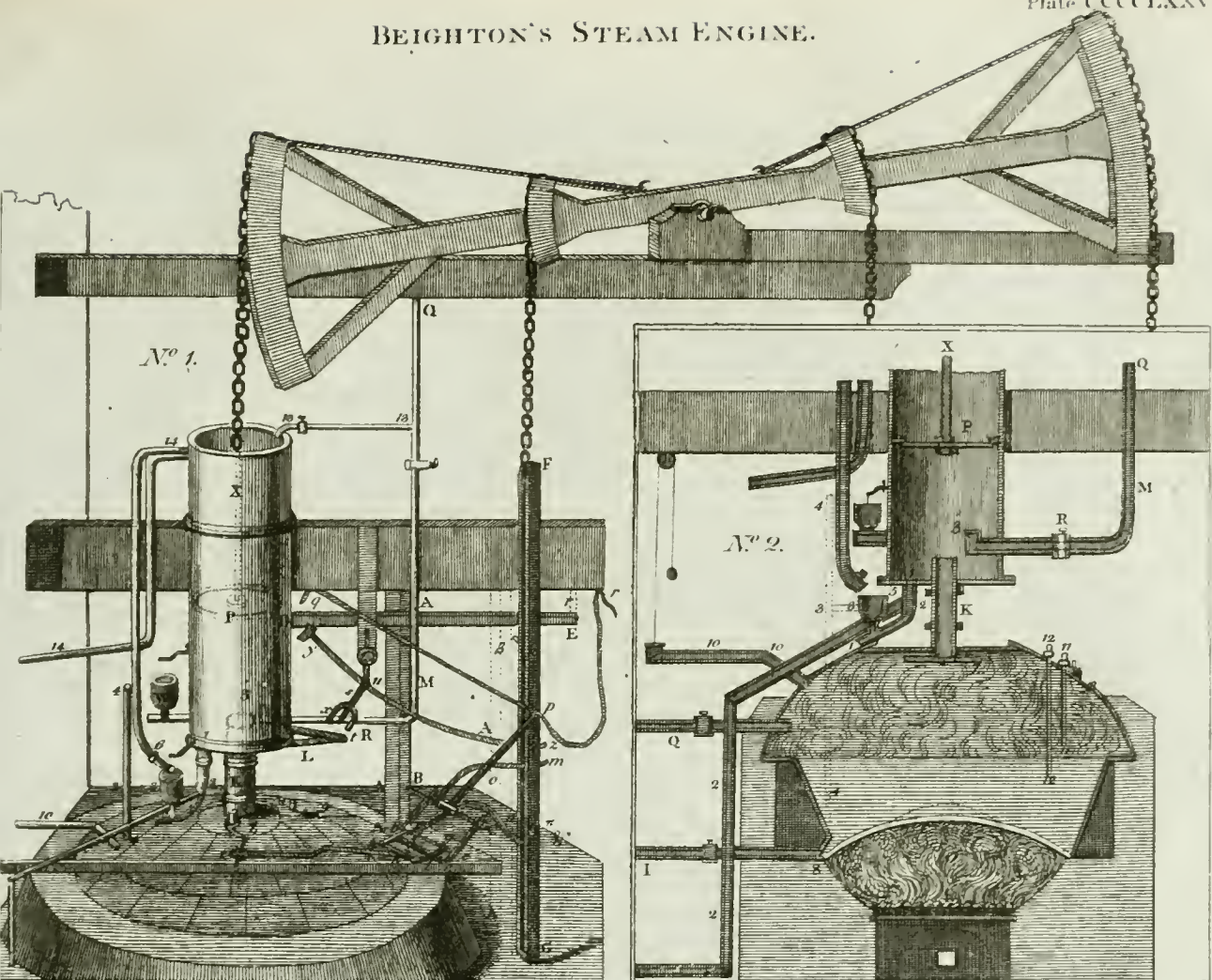

Fig. 5.





BEIGHTON'S STEAM ENGINE.







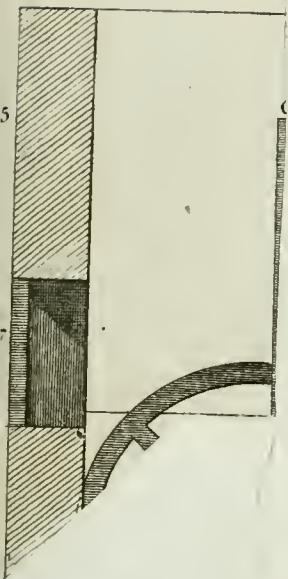

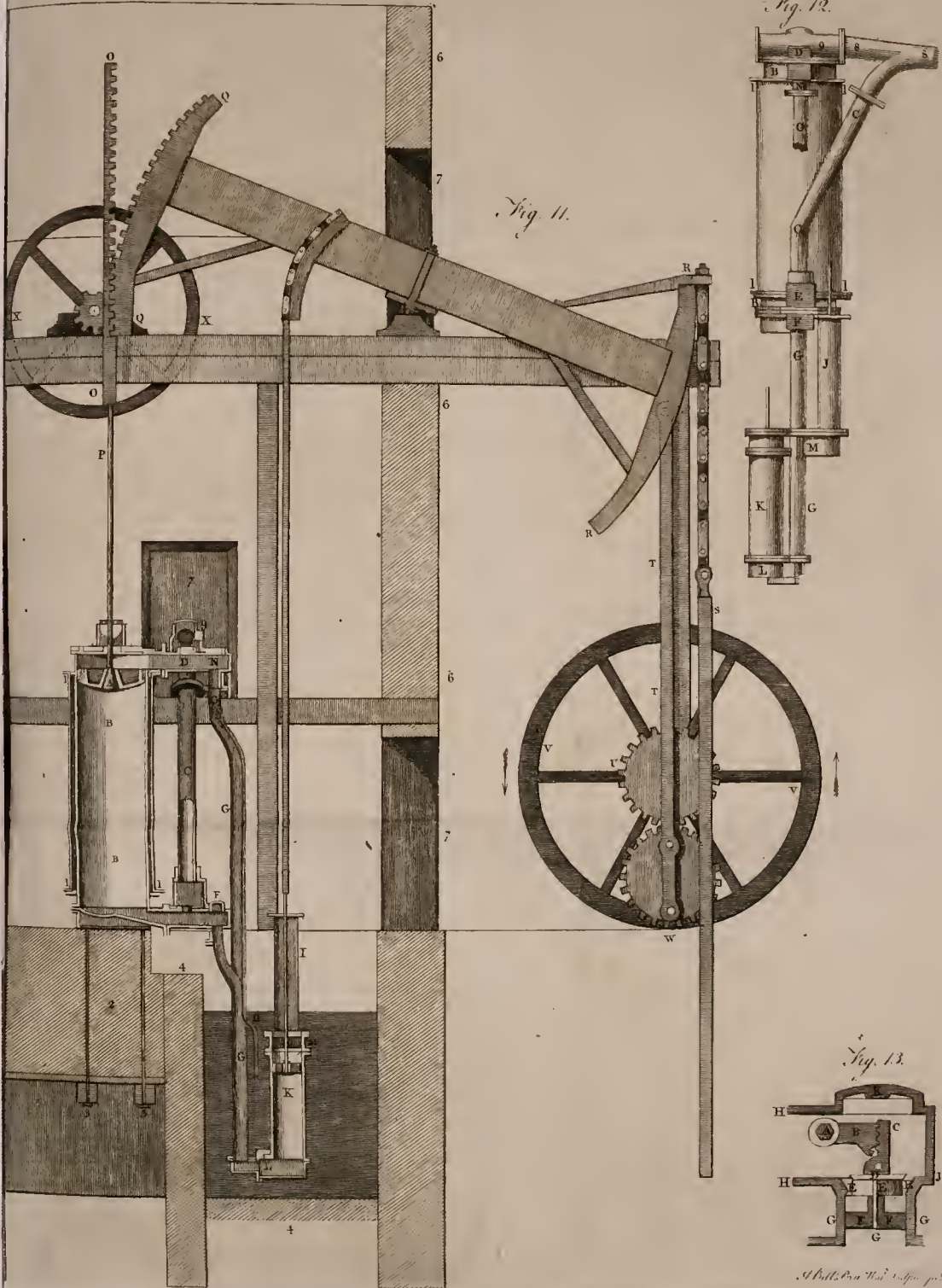

*Fig. 13.*  
A detail view of the valve gear mechanism, showing the valve rod (C) and the valve (B) within the cylinder (H). The valve gear is connected to the piston rod (G) and the valve rod (C) through a series of links (E, F, G). The valve (B) is shown in its open position, allowing steam to enter the cylinder (H).

Steam-Engine.

73  
The only improvement now wanting is a strength on the great beam.

is the great beam. The enormous strains exerted on its arms require a proportional strength. This requires a vast mass of matter, not less indeed in an engine with a cylinder of 54 inches than three tons and a half, moving with the velocity of three feet in a second, which must be communicated in about half a second. This mass must be brought into motion from a state of rest, must again be brought to rest, again into motion, and again to rest, to complete the period of a stroke. This consumes much power; and Mr Watt has not been able to load an engine with more than 10 or 11 pounds on the inch and preserve a sufficient quantity of motion, so as to make 12 or 15 six-foot strokes in a second. Many attempts have been made to lessen this mass by using a light framed wheel, or a light frame of carpentry, in place of a solid beam. These have generally been constructed by persons ignorant of the true scientific principles of carpentry, and have failed accordingly. Mr Watt has made similar attempts; but found, that although at first they were abundantly strong, yet after a short time's employment the straps and bolts with which the wooden parts were connected cut their way into the wood, and the framing grew loose in the joints, and, without giving any warning, went to pieces in an instant. A solid massy simple beam, of sufficient strength, ends, and sensibly complains (as the carpenters express it), before it breaks. In all great engines, therefore, such only are employed, and in smaller engines he sometimes uses cast-iron wheels or pulleys; nay, he frequently uses no beam or equivalent whatever, but employs the steam piston-rod to drive the machinery to which the engine is applied.

74  
Mr Watt associated with Mr Boulton.

We presume that our thinking readers will not be displeased with this rational history of the progress of this engine in the hands of its ingenious and worthy inventor. We owe it to the communications of a friend, well acquainted with him, and able to judge of his merits. The public see him always associated with the no less celebrated mechanic and philosopher Mr Boulton of Soho near Birmingham (see Соно). They have shared the royal patent from the beginning; and the alliance is equally honourable to both.

75  
Whence their profits are derived in erecting engines.

The advantages derived from the patent-right show both the superiority of the engine and the liberal minds of the proprietors. They erect the engines at the expense of the employers, or give working drafts of all the parts, with instructions, by which any resident engineer may execute the work. The employers select the best engine of the ordinary kind in the kingdom, compare the quantities of fuel expended by each, and pay to Messrs Watt and Boulton one-third of the annual savings for a certain term of years. By this the patentees are excited to do their utmost to make the engine perfect; and the employer pays in proportion to the advantage he derives from it.

It may not be here improper to state the actual performance of some of these engines, as they have been ascertained by experiment.

76  
What the actual performance of some of these engines is.

An engine having a cylinder of 31 inches in diameter, and making 17 double strokes per minute, performs the work of forty horses working night and day (for which three relays or 120 horses must be kept), and burns 11,000 pounds of Staffordshire coal per day. A cylinder of 19 inches, making 25 strokes of 4 feet each per minute, performs the work of 12 horses working

VOL. XVII. Part II.

constantly, and burns 3700 pounds of coals per day. A cylinder of 24 inches, making 22 strokes of 5 feet, burns 5500 pounds of coals, and is equivalent to the constant work of 20 horses. And the patentees think themselves authorized by experience to say in general, that these engines will raise more than 20,000 cubic feet of water 24 feet high for every hundred weight of good pit-coal consumed by them.

Steam-Engine.

In consequence of the great superiority of Mr Watt's engines, both with respect to economy and manageableness, they have become of most extensive use; and in every demand of manufacture on a great scale they offer us an indefatigable servant, whose strength has no bounds. The greatest mechanical project that ever engaged the attention of man was on the point of being executed by this machine. The States of Holland were treating with Messrs Watt and Boulton for draining the Haerlem Meer, and even reducing the Zuyder Zee: and we doubt not but that it will be accomplished whenever that unhappy nation has sufficiently felt the difference between liberty and democratic tyranny. Indeed such unlimited powers are afforded by this engine, that the engineer now thinks that no task can be proposed to him which he cannot execute with profit to his employer.

77  
Proposed to drain the Haerlem Meer by the Steam-engine.

No wonder then that all classes of engineers have turned much of their attention to this engine; and feeling that it has done so much, that they try to make it do still more. Numberless attempts have been made to improve Mr Watt's engine; and it would occupy a volume to give an account of them, whilst that account would do no more than indulge curiosity. Our engineers by profession are in general miserably deficient in that accurate knowledge of mechanics and of chemistry which is necessary for understanding this machine; and we have not heard of one in this kingdom who can be put on a par with the present patentees in this respect. Most of the attempts of engineers have been made with the humbler view of availing themselves of Mr Watt's discoveries, so as to construct a steam-engine superior to Newcomen's, and yet of a form sufficiently different from Watt's to keep it without the reach of his patent. This they have in general accomplished by performing the condensation in a place which, with a little stretch of fancy, not unfrequent in a court of law, may be called *part of the cylinder*.

78  
The attempts to improve Mr Watt's engine in general of little advantage;

The success of most of these attempts has interfered so little with the interest of the patentees, that they have not hindered the erection of many engines which the law would have deemed encroachments. We think it our duty to give our opinion on this subject without reserve. These are most expensive undertakings, and few employers are able to judge accurately of the merits of a project presented to them by an ingenious artist. They may see the practicability of the scheme, by having a general notion of the expansion and condensation of steam, and they may be misled by the ingenuity apparent in the construction. The engineer himself is frequently the dupe of his own ingenuity; and it is not always dishonestly, but frequently ignorance, which makes him prefer his own invention or (as he thinks it) improvement. It is a most delicate engine, and requires much knowledge to see what does and what does not improve its performance. We have gone into the preceding minute investigation of Mr Watt's progress with the express purpose of making our readers fully masters

79  
And the success of these has not injured the other.

Steam-Engine.

of its principles, and have more than once pointed out the real improvements, that they may be firmly fixed and always ready in the mind. By having recourse to them, the reader may pronounce with confidence on the merits of any new construction, and will not be deceived by the puffs of an ignorant or dishonest engineer.

So  
Execution  
in favour  
of Mr  
Hornblower.

We must except from this general criticism a construction by Mr Jonathan Hornblower near Bristol, on account of its singularity, and the ingenuity and real skill which appears in some particulars of its construction. The following short description will sufficiently explain its principle, and enable our readers to appreciate its merit.

Plate  
cccclxxx.  
51  
Description  
of his  
Steam-Engine.

A and B (fig. 15.) represent two cylinders, of which A is the largest. A piston moves in each, having their rods C and D moving through collars at E and F. These cylinders may be supplied with steam from the boiler by means of the square pipe G, which has a flanch to connect it with the rest of the steam-pipe. This square part is represented as branching off to both cylinders. *c* and *d* are two cocks, which have handles and tumblers as usual, worked by the plug-beam W. On the fore-side (that is, the side next the eye) of the cylinders is represented another communicating pipe, whose section is also square or rectangular, having also two cocks *a*, *b*. The pipe Y, immediately under the cock *b*, establishes a communication between the upper and lower parts of the small cylinder B, by opening the cock *b*. There is a similar pipe on the other side of the cylinder A, immediately under the cock *d*. When the cocks *c* and *a* are open, and the cocks *b* and *d* are shut, the steam from the boiler has free admission into the upper part of the cylinder B, and the steam from the lower part of B has free admission into the upper part of A; but the upper part of each cylinder has no communication with its lower part.

From the bottom of the great cylinder proceeds the eduction-pipe K, having a valve at its opening into the cylinder, which bends downwards, and is connected with the conical condenser L (*c*). The condenser is fixed on a hollow box M, on which stand the pumps N and O for extracting the air and water; which last runs along the trough T into a cistern U, from which it is raised by the pump V for recruiting the boiler, being already nearly boiling hot. Immediately under the condenser there is a spigot valve at S, over which is a small jet pipe, reaching to the bend of the eduction-pipe. The whole of the condensing apparatus is contained in a cistern R of cold water. A small pipe P comes from the side of the condenser, and terminates on the bottom of the trough T, and is there covered with a valve Q, which is kept tight by the water that is always running over it. Lastly, the pump-rods X cause the outer end of the beam to preponderate, so that the quiescent position of the beam is that represented in the figure, the pistons being at the top of the cylinders.

Suppose all the cocks open, and steam coming in copiously from the boiler, and no condensation going on in L; the steam must drive out all the air, and at last follow it through the valve Q. Now shut the valves *b* and *d*, and open the valve S of the condenser. The

condensation will immediately commence. There is now no pressure on the under side of the piston of A, and it immediately descends. The communication between the lower part of B and the upper part of A being open, the steam will go from B into the space left by the piston of A. It must therefore expand, and its elasticity must diminish, and will no longer balance the pressure of the steam above the piston of B. This piston therefore, if not withheld by the beam, would descend till it is in equilibrio, having steam of equal density above and below it. But it cannot descend so far; for the cylinder A is wider than B, and the arm of the beam at which its piston hangs is longer than the arm which supports the piston of B: therefore when the piston of B has descended as far as the beam will permit it, the steam between the two pistons occupies a larger space than it did when both pistons were at the tops of their cylinders. Its density, therefore, and its elasticity, diminish as its bulk increases. It is therefore not a balance; for the steam on the upper side of B, and the piston B, pulls at the beam with all the difference of these pressures. The slightest view of the subject must show the reader, that as the pistons descend, the steam that is between them will grow continually rarer and less elastic, and that both pistons will pull the beam downwards.

Suppose now that each has reached the bottom of its cylinder. Shut the cock *a* and the eduction cock at the bottom of A, and open the cocks *b* and *d*. The communication being now established between the upper and lower part of each cylinder, nothing hinders the counter weight from raising the pistons to the top. Let them arrive there. The cylinder B is at this time filled with steam of the ordinary density, and the cylinder A with an equal absolute quantity of steam, but expanded into a larger space.

Shut the cocks *b* and *d*, and open the cock *a*, and the eduction cock at the bottom of A; the condensation will again operate, and the pistons descend. And thus the operation may be repeated as long as steam is supplied; and one full of the cylinder B of ordinary steam is expended during each working stroke.

Let us now examine the power of this engine. It is evident, that when both pistons are at the top of their respective cylinders, the active pressure (that is, the difference of the pressure on its two sides) on the piston of B is nothing, while that on the piston of A is equal to the full pressure of the atmosphere on its area. This, multiplied by the length of the arm by which it is supported, gives its mechanical energy. As the pistons descend, the pressure on the piston of B increases, while that on the piston of A diminishes. When both are at the bottom, the pressure on the piston of B is at its maximum, and that on the piston of A at its minimum.

Mr Hornblower saw that this must be a beneficial employment of steam, and preferable to the practice of condensing it while its full elasticity remained; but he has not considered it with the attention necessary for ascertaining the advantage with precision.

Let *a* and *b* represent the areas of the pistons of A and

(c) This, however, was stopped by Watt's patent; and the condensation must be performed as in Newcomen's engine, or at least in the cylinder A.

STEAM ENGINE.

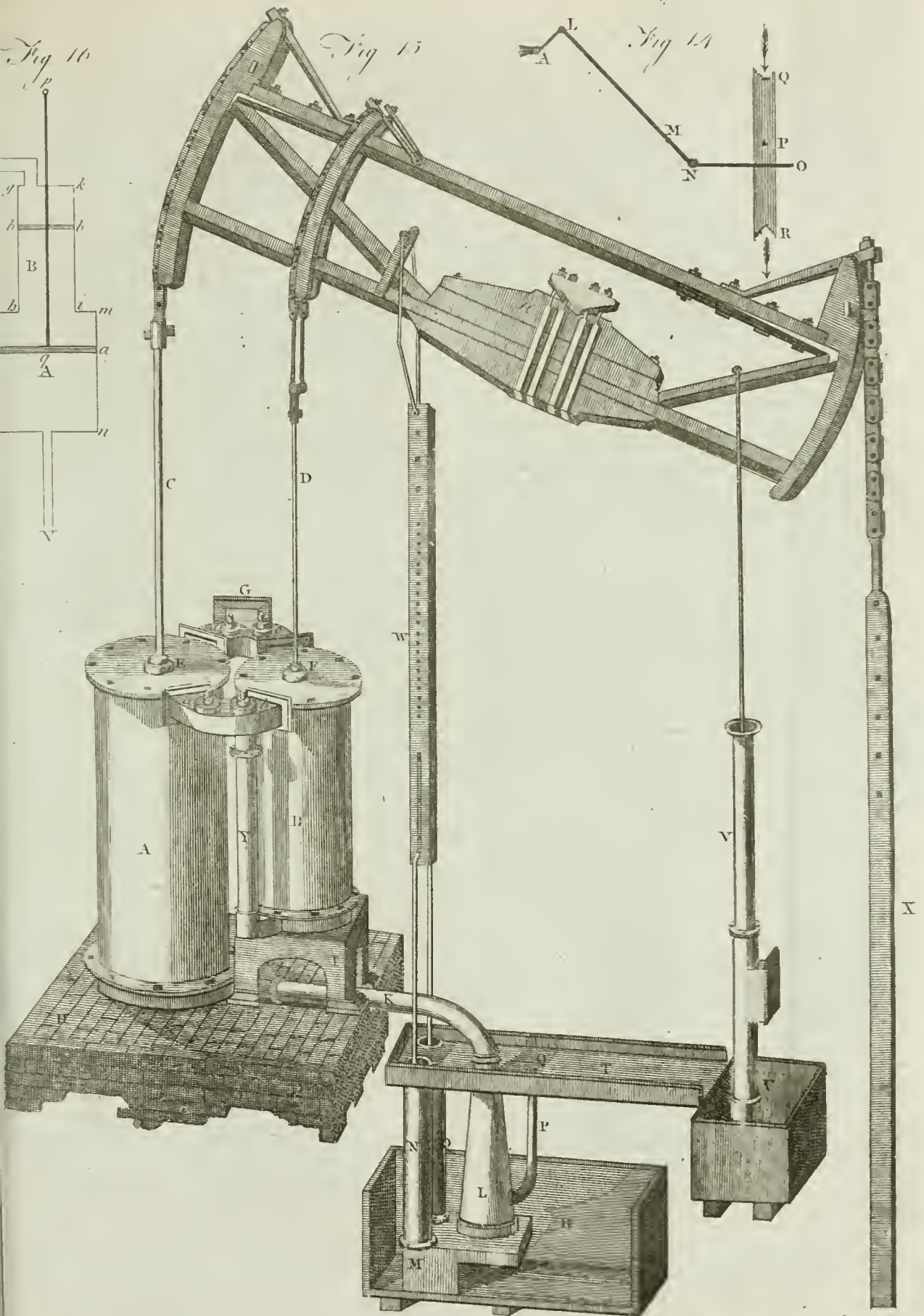



Steam-Engine.

and B, and let  $\alpha$  and  $\beta$  be the lengths of the arms by which they are supported. It is evident, that when both pistons have arrived at the bottoms of their cylinders, the capacities of the cylinders are as  $a^2$  and  $b^2$ . Let this be the ratio of  $m$  to 1. Let  $g h i k$  (fig. 16.) and  $l m n o$  be two cylinders of equal length, communicating with each other, and fitted with a piston-rod  $p q$ , on which are fixed two pistons  $a a$  and  $b b$ , whose areas are as  $m$  and 1. Let the distance between the pistons be precisely equal to the height of each cylinder, which height we shall call  $b$ . Let  $x$  be the space  $g b$  or  $b a$ , through which the pistons have descended. Let the upper cylinder communicate with the boiler, and the lower cylinder with the condenser or vacuum V.

Any person in the least conversant in mechanics and pneumatics will clearly see that the strain or pressure on the piston rod  $p q$  is precisely the same with the united energies of the two piston rods of Mr Hornblower's engine, by which they tend to turn the working beam round its axis.

The base of the upper cylinder being 1, and its height  $b$ , its capacity or bulk is  $1 b$  or  $b$ ; and this expresses the natural bulk of the steam which formerly filled it, and is now expanded into the space  $b b l a a m i b$ . The part  $b b i b$  is plainly  $= b - x$ , and the part  $l a a m$  is  $= m x$ . The whole space therefore is  $m x + b - x$ ,  $= b + m x - x$ , or  $b + m - 1 x$ . Therefore the density of the steam between the pistons is  $\frac{b}{b + m - 1 x}$ .

Let  $p$  be the downward pressure of the steam from the boiler on the upper piston  $b b$ . This piston is also pressed up with a force  $= p \frac{b}{b + m - 1 x}$  by the steam between the pistons. It is therefore, on the whole, pressed downward with a force  $= p \left( 1 - \frac{b}{b + m - 1 x} \right)$ . The lower piston  $a a$ , having a vacuum below it, is pressed downwards with a force  $= p \frac{m b}{b + m - 1 x}$ . Therefore the whole pressure on the piston rod downwards is  $= p \left( 1 + \frac{m b}{b + m - 1 x} - \frac{b}{b + m - 1 x} \right)$ ,  $= p \left( 1 + \frac{m - 1 b}{b + m - 1 x} \right)$ ,  $= p + \frac{p b m - 1}{b + m - 1 x} = p + \frac{p b}{m - 1 + x}$ .

This then is the momentary pressure on the piston rod corresponding to its descent  $x$  from its highest position. When the pistons are in their highest position, this pressure is equal to  $m p$ . When they are in their lowest position, it is  $= p \frac{2 m - 1}{m}$ . Here therefore is an accession of power. In the beginning the pressure is greater than on a single piston in the proportion of  $m$  to 1; and at the end of the stroke, where the pressure is weakest, it is still much greater than the pressure on a single piston. Thus, if  $m$  be 4, the pressure at the beginning of the stroke is  $4 p$ , and at the end it is  $\frac{7}{4} p$ , almost double, and in all intermediate positions it is greater. It is worth while to obtain the sum total of all the

Steam-Engine.

accumulated pressures, that we may compare it with the constant pressure on a single piston.

We may do this by considering the momentary pressure  $p + \frac{p b}{\frac{b}{m-1} + x}$ , as equal to the ordinate GF,

H b, or M c, of a curve F b c (fig. 10.), which has for its axis the line GM equal to  $b$  the height of our cylinder. Call this ordinate  $y$ . We have  $y = p + \frac{p b}{\frac{b}{m-1} + x}$ , and  $y - p = \frac{p b}{\frac{b}{m-1} + x}$ . Now it is plain that

$\frac{p b}{\frac{b}{m-1} + x}$  is the ordinate of an equilateral hyperbola,

of which  $p b$  is the power or rectangle of the ordinate and absciss, and of which the absciss reckoned from the centre is  $\frac{b}{m-1} + x$ . Therefore make GE =  $p$ , and draw DEA parallel to MG, and make EA =  $\frac{GM}{m-1}$ .

$= \frac{b}{m-1}$ . The curve F b c is an equilateral hyperbola, having A for its centre and AD for its asymptote. Draw the other asymptote AB, and its ordinate FB. Since the power of the hyperbola is  $= p b$ , = GEDM (for GE =  $p$ , and GM =  $b$ ); and since all the inscribed rectangles, such as AEFB, are equal to  $p b$ , it follows that AEFB is equal to GEDM, and that the area ABF c DA is equal to the area GF c MG, which expresses the accumulated pressure in Hornblower's engine.

We can now compute the accumulated pressure very easily. It is evidently  $= p b \times \left( 1 + L \frac{AD}{AE} \right)$ .

The intelligent reader cannot but observe that this is precisely the same with the accumulated pressure of a quantity of steam admitted in the beginning, and stopped in Mr Watt's method, when the piston has descended through the  $m$ th part of the cylinder. In considering Mr Hornblower's engine, the thing was presented in so different a form that we did not perceive the analogy at first, and we were surprised at the result.

We could not help even regretting it, because it had the appearance of a new principle and an improvement: and we doubt not but that it appeared so to the ingenious author; for we have had such proofs of his liberality of mind as permit us not to suppose that he saw it from the beginning, and availed himself of the difficulty of tracing the analogy. And as the thing may mislead others in the same way, we have done a service to the public by showing that this engine, so costly and so difficult in its construction, is no way superior in power to Mr Watt's simple method of stopping the steam. It is even inferior, because there must be a condensation in the communicating passages. We may add, that if the condensation is performed in the cylinder A, which it must be unless with the permission of Watt and Boulton, the engine cannot be much superior to a common engine; for much of the steam from below B will be condensed between the pistons by the coldness of the cylinder A; and this diminishes the

Steam-engine.

downward pressure on A more than it increases the downward pressure on B. We learn however that, by confining the condensation to a small part of the cylinder A, Mr Hornblower has erected engines clear of Mr Watt's patent, which are considerably superior to Newcomen's: so has Mr Symington.

83  
Said, however, the engine discovers ingenuity and skill.

We said that there was much ingenuity and real skill observable in many particulars of this engine. The disposition and connection of the cylinders, and the whole condensing apparatus, are contrived with peculiar neatness. The cocks are very ingenious; they are composed of two flat circular plates ground very true to each other, and one of them turns round on a pin through their centres; each is pierced with three sectoral apertures, exactly corresponding with each other, and occupying a little less than one half of their surfaces. By turning the moveable plate so that the apertures coincide, a large passage is opened for the steam; and by turning it so that the solid of the one covers the aperture of the other, the cock is shut. Such regulators are now very common in the cast iron stoves for warming rooms.

Mr Hornblower's contrivance for making the collars for the piston rods air-tight is also uncommonly ingenious. This collar is in fact two, at a small distance from each other. A small pipe, branching off from the main steam-pipe, communicates with the space between the collars. This steam, being a little stronger than the pressure of the atmosphere, effectually hinders the air from penetrating by the upper collar; and though a little steam should get through the lower collar into the cylinder A, it can do no harm. We see many cases in which this pretty contrivance may be of signal service.

84  
The greatest improvement is the framing of the working beam.

But it is in the framing of the great working beam that Mr Hornblower's scientific knowledge is most conspicuous; and we have no hesitation in affirming that it is stronger than a beam of the common form, and containing twenty times its quantity of timber. There is hardly a part of it exposed to a transverse strain, if we except the strain of the pump V on the strutt by which it is worked. Every piece is either pushed or pulled in the direction of its length. We only fear that the bolts which connect the upper beam with the two iron bars under its ends will work loose in their holes, and tear out the wood which lies between them. We would propose to substitute an iron bar for the whole of this upper beam. This working beam highly deserves the attention of all carpenters and engineers. We have that opinion of Mr Hornblower's knowledge and talents, that we are confident that he will see the fairness of our examination of his engine, and we trust to his candour for an excuse for our criticism.

85  
The reciprocating motion of the steam-engine is a defect liable to be remedied.

The reciprocating motion of the steam-engine has always been considered as a great defect; for though it be now obviated by connecting it with a fly, yet, unless it is an engine of double stroke, this fly must be an enormous mass of matter moving with great velocity. Any accident happening to it would produce dreadful effects: A part of the rim detaching itself would have the force of a bomb, and no building could withstand it. Many attempts have been made to produce a circular motion at once by the steam. It has been made to blow on the vanes of a wheel of various forms. But the rarity of steam is such, that even if none is condensed

by the cold of the vanes, the impulse is exceedingly feeble, and the expence of steam, so as to produce any serviceable impulse, is enormous. Mr Watt, among his first speculations on the steam-engine, made some attempts of this kind. One in particular was uncommonly ingenious. It consisted of a drum turning air-tight within another, with cavities so disposed that there was a constant and great pressure urging it in one direction. But no packing of the common kind could preserve it air-tight with sufficient mobility. He succeeded by immersing it in mercury, or in an amalgam which remained fluid in the heat of boiling water; but the continual trituration soon calcined the fluid and rendered it useless. He then tried Parent's or Dr Barker's mill, inclosing the arms in a metal drum, which was immersed in cold water. The steam rushed rapidly along the pipe which was the axis, and it was hoped that a great reaction would have been exerted at the ends of the arms; but it was almost nothing. The reason seems to be, that the greatest part of the steam was condensed in the cold arms. It was then tried in a drum kept boiling-hot; but the impulse was now very small in comparison with the expence of steam. This must be the case.

Mr Watt has described in his specification to the patent office some contrivances for producing a circular motion by the immediate action of the steam. Some of these produce alternate motions, and are perfectly analogous to his double stroke engine. Others produce a continued motion. But he has not given such a description of his valves for this purpose as can enable an engineer to construct one of them. From any plans that we can form, we think the machine very imperfect; and we do not find that Mr Watt has ever erected a continuous circular engine. He has doubtless found all his attempts inferior to the reciprocating engine with a fly. A very crude scheme of this kind may be seen in the Transactions of the Royal Society of Dublin 1787. But although our attempts have hitherto failed, we hope that the case is not yet desperate: We see different principles which have not yet been employed.

We shall conclude our account of this noble engine with observing, that Mr Watt's form suggests the construction of an excellent air-pump. A large vessel may be made to communicate with a boiler at one side, and with the pump-receiver on the other, and also with a condenser. Suppose this vessel of ten times the capacity of the receiver: fill it with steam from the boiler, and drive out the air from it; then open its communication with the receiver and the condenser. This will rarefy the air of the receiver 10 times. Repeating the operation will rarefy it 100 times; the third operation will rarefy it 1000 times; the fourth 10,000 times, &c. All this may be done in half a minute.

*STEAM-KITCHEN.* Ever since Dr Papin contrived his digester (about the year 1690), schemes have been proposed for dressing victuals by the steam of boiling water. A philosophical club used to dine at Saltero's coffee-house, Chelsea, about 30 years ago, and had their victuals dressed by hanging them in the boiler of the steam-engine which raises water for the supply of Piccadilly and its neighbourhood. They were completely dressed, and both expeditiously and with high flavour.

Steam-engine. Mr Watt's attempt produced circular motion. Steam success. Still I case is defective for direct principles employed. Mr Watt's engine rests on construction of excellent air-pump.



Steam-Kitchen.

A patent was lately obtained for an apparatus for this purpose by a tin-man in London; we think of the name of Tate. They are made on a much more effective plan by Gregory, an ingenious tradesman in Edinburgh, and are coming into very general use.

It is well known to the philosopher that the steam of boiling water contains a prodigious quantity of heat, which it retains in a latent state ready to be faithfully accounted for, and communicated to any colder body. Every cook knows the great scalding power of steam, and is disposed to think that it is much hotter than boiling water. This, however, is a mistake; for it will raise the thermometer no higher than the water from which it comes. But we can assure the cook, that if he make the steam from the spout of a tea-kettle pass through a great body of cold water, it will be condensed or changed into water; and when one pound of water has in this manner been boiled off, it will have heated the mass of cold water as much as if we had thrown into it seven or eight hundred pounds of boiling hot water.

It, therefore, a boiler be properly fitted up in a furnace, and if the steam of the water boiling in it be conveyed by a pipe into a pan containing victuals to be dressed, every thing can be cooked that requires no higher degree of heat than that of boiling water: And this will be done without any risk of scorching, or any kind of overheating, which frequently spoils our dishes, and proceeds from the burning heat of air coming to those parts of the pot or pan which is not filled with liquor, and is covered only with a film, which quickly burns and taints the whole dish. Nor will the cook be scorched by the great heat of the open fire that is necessary for dressing at once a number of dishes, nor have his person and clothes soiled by the smoke and soot unavoidable in the cooking on an open fire. Indeed the whole process is so neat, so manageable, so open to inspection, and so cleanly, that it need neither fatigue nor offend the delicacy of the nicest lady.

We had great doubts, when we first heard of this as a general mode of cookery, as to its economy; we had none as to its efficacy. We thought that the steam, and consequently the fuel expended, must be vastly greater than by the immediate use of an open fire; but we have seen a large tavern dinner expeditiously dressed in this manner, seemingly with much less fuel than in the common method. The following simple narration of facts will show the superiority. In a paper manufacture in this neighbourhood, the vats containing the pulp into which the frames are dipped are about six feet diameter, and contain above 200 gallons. This is brought to a proper heat by means of a small cockle or furnace in the middle of the liquor. This is heated by putting in about one hundred weight of coals about eight o'clock in the evening, and continuing this till four next morning, renewing the fuel as it burns away. This method was lately changed for a steam heater. A furnace, having a boiler of five or six feet diameter and three feet deep, is heated about one o'clock in the morning with two hundred weight of coals, and the water kept in brisk ebullition. Pipes go off from this boiler to six vats, some of which are at 90 feet distance. It is conveyed into a flat box or vessel in the midst of the pulp where it condenses, imparting its heat to the sides of the box, and thus heat the surrounding pulp. These six vats are as completely heated in three

hours, expending about three hundred weight of coals, as they were formerly in eight hours, expending near 18 hundred weight of coals. Mr Gregory, the inventor of this steam heater, has obtained (in company with Mr Scott plumber, Edinburgh) a patent for the invention; and we are persuaded that it will come into very general use for many similar purposes. The dyers, hat-makers, and many other manufacturers, have occasion for large vats kept in a continual heat; and there seems no way so effectual.

Indeed when we reflect seriously on the subject, we see that this method has immense advantages considered merely as a mode of applying heat. The steam may be applied to the vessel containing the victuals in every part of its surface: it may even be made to enter the vessel, and apply itself immediately to the piece of meat that is to be dressed, and this without any risk of scorching or overdoing. And it will give out about  $\frac{3}{4}$  of the heat which it contains, and will do this only if it be wanted; so that no heat whatever is wasted except what is required for heating the apparatus. Experience shows that this is a mere trifle in comparison of what was supposed necessary. But with an open fire we only apply the flame and hot air to the bottom and part of the sides of our boiling vessels: and this application is hurried in the extreme; for to make a great heat, we must have a great fire, which requires a prodigious and most rapid current of air. This air touches our pans but for a moment, imparts to them but a small portion of its heat; and, we are persuaded that three-fourths of the heat is carried up the chimney, and escapes in pure waste, while another great portion beams out into the kitchen to the great annoyance of the scorched cook. We think, therefore, that a page or two of this work will not be thrown away in the description of a contrivance by which a saving may be made to the entertainer, and the providing the pleasures of his table prove a less fatiguing task to this valuable corps of practical chemists.

Let A represent a kitchen-boiler, either properly fitted up in a furnace, with its proper fire place, ash-pit, and flue, or set on a tripod on the open fire, or built up in the general fire place. The steam-pipe BC rises from the cover of this boiler, and then is led away with a gentle ascent in any convenient direction. C represents the section of this conducting steam-pipe. Branches are taken off from the side at proper distances. One of these is represented at CDL, furnished with a cock D, and having a taper nozzle E, fitted by grinding into a conical piece F, which communicates with an upright pipe GH, which is soldered to the side of the steaming vessel PQRS, communicating with it by the short pipe I. The vessel is heated with a cover OT, having a staple handle V. The piece of meat M is laid on a tin plate grate KL, pierced with holes like a cullender, and standing on three short feet *nnn*.

The steam from the boiler comes in by the pipe I, and is condensed by the meat and by the sides of the vessel, communicating to them all its heat. What is not so condensed escapes between the vessel and its cover. The condensed water lies on the bottom of the vessel, mixed with a very small quantity of gravy and fatty matter from the victuals. Frequently, instead of a cover, another stew-vessel with a cullender bottom is set on this one, the bottom of the one fitting the mouth

Steam-Kitchen.

Plate  
CCLXXIII.  
fig. 3.

Steam-  
Kitchen

of the other : and it is observed, that when this is done, the dish in the under vessel is more expeditiously and better dressed, and the upper dish is more slowly, but as completely stewed.

This description of one stewing vessel may serve to give a notion of the whole ; only we must observe, that when broths, soups, and dishes with made sauces or containing liquids, are to be dressed, they must be put into a smaller vessel, which is set into the vessel PQRS, and is supported on three short feet, so that there may be a space all round it of about an inch or three quarters of an inch. It is observed, that dishes of this kind are not so expeditiously cooked as on an open fire, but as completely in the end, only requiring to be turned up now and then to mix the ingredients ; because as the liquids in the inner vessel can never come into ebullition, unless the steam from the boiler be made of a dangerous heat, and every thing be close confined, there cannot be any of that tumbling motion that we observe in a boiling pot.

The performance of this apparatus is far beyond any expectation we had formed of it. In one which we examined, six pans were stewing together by means of a boiler 10½ inches in diameter, standing on a brisk open fire. It boiled very briskly, and the steam puffed frequently through the chinks between the stew-pans and their covers. In one of them was a piece of meat considerably above 30 pounds weight. This required above four hours stewing, and was then very thoroughly and equally cooked ; the outside being no more done than the heart, and it was near two pounds heavier than when put in, and greatly swelled. In the mean time, several dishes had been dressed in the other pans. As far as we could judge, this cooking did not consume one-third part of the fuel which an open fire would have required for the same effect.

When we consider this apparatus with a little more knowledge of the mode of operation of fire than falls to the share of the cooks (we speak with deference), and consider the very injudicious manner in which the steam is applied, we think that it may be improved so as to surpass any thing that the cook can have a notion of.

When the steam enters the stew-pan, it is condensed on the meat and on the vessel ; but we do not want it to be condensed on the vessel. And the surface of the vessel is much greater than that of the meat, and continues much colder ; for the meat grows hot, and continues so, while the vessel, made of metal which is a very perfect conductor of heat, is continually robbed of its heat by the air of the kitchen, and carried off by it. If the meat touch the side of the pan in any part, no steam can be applied to that part of the meat, while it is continually imparting heat to the air by the intermedium of the vessel. Nay, the meat can hardly be dressed unless there be a current of steam through it ; and we think this confirmed by what is observed above, that when another stew-pan is set over the first, and thus gives occasion to a current of steam through its cullender bottom to be condensed by its sides and contents, the lower dish is more expeditiously dressed. We imagine, therefore, that not less than half of the steam is wasted on the sides of the different stew-pans. Our first attention is therefore called to this circumstance, and we

wish to apply the steam more economically and effectually.

We would therefore construct the steam-kitchen in the following manner :

We would make a wooden chest (which we shall call the STEW-CHEST) ABCD. This should be made of deal, in very narrow slips, not exceeding an inch, that it may not shrink. This should be lined with very thin copper, lead, or even strong tin-foil. This will prevent it from becoming a conductor of heat by soaking with steam. For further security it might be set in another chest, with a space of an inch or two all round, and this space filled with a composition of powdered charcoal and clay. This should be made by first making a mixture of fine potter's clay and water about as thick as poor cream : then as much powdered charcoal must be beat up with this as can be made to stick together. When this is rammed in and dry, it may be hot enough on one side to melt glass, and will not discolour white paper on the other.

This chest must have a cover LMNO, also of wood, having holes in it to receive the stew-pans P, Q, R. Between each pan is a wooden partition, covered on both sides with milled lead or tin-foil. The whole top must be covered with very spongy leather or felt, and made very flat. Each stew-pan must have a bearing or shoulder all round it, by which it is supported, resting on the felt, and lying so true and close that no steam can escape. Some of the pans should be simple, like the pan F, for dressing broths and other liquid dishes. Others should be like E and G, having in the bottom a pretty wide hole H, K, which has a pipe in its upper side, rising about an inch or an inch and half into the stew-pan. The meat is laid on a cullender plate, as in the common way ; only there must be no holes in the cullender immediately above the pipe.— These stew-pans must be fitted with covers, or they may have others fitted to their mouths, for warming sauces or other dishes, or stewing greens, and many other subordinate purposes for which they may be fitted.

The main-pipe from the boiler must have branches, (each furnished with a cock), which admit the steam into these divisions. At its first entry some will be condensed on the bottom and sides ; but we imagine that these will in two minutes be heated so as to condense no more, or almost nothing. The steam will also quickly condense on the stew-pan, and in half a minute make it boiling hot, so that it will condense no more ; all the rest will now apply itself to the meat and to the cover. It may perhaps be advisable to allow the cover to condense steam, and even to waste it. This may be promoted by laying on it flannel soaked in water. Our view in this is to create a demand for steam, and thus produce a current through the stew-pan, which will be applied in its passage to the victuals. But we are not certain of the necessity of this. Steam is not like common air of the same temperature, which would glide along the surfaces of bodies, and impart to them a small portion of its heat, and escape with the rest. To produce this effect there *must* be a current ; for air hot enough to melt lead, will not boil water, if it be kept stagnant round the vessel. But steam imparts the *whole* of its latent heat to any body colder than boiling water, and goes no farther till this body be made boiling hot.

Steam-  
Kitchen

Fig. 6.

Steam-  
Kitchen

It is a most faithful carrier of heat, and will deliver its whole charge to any body that can take it. Therefore, although there were no partitions in the stew-chest, and the steam were admitted at the end next the boiler, if the pan at the farther end be colder than the rest, it will all go thither: and will, in short, communicate to every thing impartially according to the demand. If any person has not the confidence in the steam which we express, he may still be certain that there must be a prodigious saving of heat by confining the whole in the stew-chest: and he may make the pans with entire bottoms, and admit the steam into them in the common way, by pipes which come through the sides of the chest and then go into the pan. There will be none lost by condensation on the sides of the chest; and the pans will soon be heated up to the boiling temperature; and hardly any of their heat will be wasted, because the air in the chest will be stagnant. The chief reason for recommending our method is the much greater ease with which the stew-pans can be shifted and cleaned. There will be little difference in the performance.

Nay, even the common steam-kitchen may be prodigiously improved by merely wrapping each pan in three or four folds of coarse dry flannel, or making flannel bags of three or four folds fitted to their shape, which can be put on or removed in a minute. It will also greatly conduce to the good performance to wrap the main steam pipe in the same manner in flannel.

We said that this main-pipe is conducted from the boiler with a gentle ascent. The intention of this is, that the water produced by the unavoidable condensation of the steam may run back into the boiler. But the rapid motion of the steam generally sweeps it up hill, and it runs into the branch pipes and descends into the stew-pans. Perhaps it would be as well to give the main-pipe a declivity the other way, and allow all the water to collect in a hot well at the farther end, by means of a descending pipe, having a loaded valve at the end. This may be so contrived as to be close by the fire, where it would be so warm that it would not check the boiling if again poured into the boiler. But the utmost attention must be paid to cleanliness in the whole of this passage, because this water is boiled again, and its steam passes through the heart of every dish. This circumstance forbids us to return into the boiler what is condensed in the stew-pans. This would mix the tastes and flavours of every dish, and be very disagreeable. All this must remain in the bottom of each stew-pan; for which reason we put in the pipe rising up in the middle of the bottom. It might indeed be allowed to fall down into the stew-chest, and to be collected in a common receptacle, while the fat would float at top, and the clear gravy be obtained below, perhaps fit for many sauces.

The completest method for getting rid of this condensed steam would be to have a small pipe running along the under side of the main conductor, and communicating with it at different places, in a manner similar to the air discharger on the mains of water-pipes. In the paper manufacture mentioned above, each steam-box has a pipe in its bottom, with a float cock, by which the water is discharged; and the main pipe being of great diameter, and laid with a proper acclivity, the water runs back into the boiler.

But these precautions are of little moment in a steam-

kitchen even for a great table; and for the general use of private families, would hurt the apparatus, by making it complex and of nice management. For a small family, the whole apparatus may be set on a table four feet long and two broad, which may be placed on casters, so as to be wheeled out of the way when not in use. If the main conductor be made of wood, or properly cased in flannel, it will condense so little steam that the cooking table may stand in the remotest corner of the kitchen without sensibly impairing its performance; and if the boiler be properly set up in a small furnace, and the flue made so that the flame may be applied to a great part of its surface, we are persuaded that three fourths of the fuel used in common cookery will be saved. Its only inconvenience seems to be the indispensable necessity of the most anxious cleanliness in the whole apparatus. The most trifling neglect in this will destroy a whole dinner.

We had almost forgotten to observe, that the boiler must be furnished with a funnel for supplying it with water. This should pass through the top, and its pipe reach near to the bottom. It will be proper to have a cock on this funnel. There should also be another pipe in the top of the boiler, having a valve on the top. If this be loaded with a pound on every square inch, and the fire so regulated that steam may be observed to puff sometimes from this valve, we may be certain that it is passing through our dishes with sufficient rapidity; and if we shut the cock on the funnel, and load the valve a little more, we shall cause the steam to blow at the covers of the stew-pans. If one of these be made very tight, and have a hole also furnished with a loaded valve, this pan becomes a digester, and will dissolve bones, and do many things which are impracticable in the ordinary cookery.

*Si quid novijli rectius istis,*

*Candidus imperti;—si non, his utere nostris.*

STEATITES or Soap-earth, a genus of the magnesian order of earths. Of this genus there are several species, for which see MINERALOGY. According to the analysis of Bergman, 100 parts of steatites contain 80 of silex, 17 of mild magnea, 2 of argillaceous earth, and nearly 1 of iron in a semioxidated state.

This substance may be formed into a paste with water, sufficiently ductile to be worked on the potter's wheel; and by exposure to a great heat it is hardened so as to strike fire with steel. It has also the property of *FELTZER'S Earth* in cleaning cloths from grease: but it does not diffuse in water so well as clays do; and when digested with vitriolic acid, it does not form alum, as clays do, but a salt similar to Epsom salt. From its softness and ductility it may be easily formed into pots for the kitchen; and hence it has got the name of *lapis allaris*.

STEATOMA, a kind of encysted tumor, consisting of a matter like suet or lard, soft, without pain, and without discolouring the skin.

STEEL, iron united with carbone. See IRON.

Steel has properties distinct from those of iron, which render it of superior value. From its higher degree of hardness it admits a finer polish and assumes a brighter colour. When tempered, it possesses a higher degree of elasticity, and is also more sonorous. It is more weakly attracted by the loadstone, it receives more slowly the magnetic power, but it preserves it longer. When exposed to a moist air, it does not contract rust so easily as iron.

Steam-  
Kitchen  
||  
Steel.

Steel.

iron. It is also heavier, increasing in weight, according to Chaptal, one hundred and seventieth part. M. Rinnman has given as the result of several accurate experiments on different kinds of steel the following specific gravity 7,795, while he makes ductile iron 7,700, and crude iron 7,251.

All iron is convertible into steel by exposing it to a certain degree of heat for a certain time along with a quantity of charcoal. Chemists differ in opinion concerning the nature and effects of this process. Some say that steel is produced by absorbing a quantity of caloric or heat in a latent state, as the older chemists had said it was formed by absorbing phlogiston. Lavoisier seems to have ascribed the qualities of steel to a slight degree of oxidation, others to a combination with plumbago or black lead, and others to a union with carbone. In agreeing with those who say the formation of steel is owing to carbone, we do not differ essentially from those who attribute it to plumbago; for the art of chemistry has now found that these substances are very nearly allied. Plumbago is a true charcoal combined with a little iron. The brilliant charcoal of certain vegetable substances, more especially when formed by distillation in close vessels, possesses all the characters of plumbago. The charcoal of animal substances possesses characters still more peculiarly resembling it. Like it they are difficult to incinerate, they leave the same impression on the hands and upon paper; they likewise contain iron, and become converted into carbonic acid by combustion. When animal substances are distilled by a strong fire, a very fine powder sublimes, which attaches itself to the inner part of the neck of the retort, and this substance may be made into excellent black lead pencils.

There are two ways of making steel, namely, by fusion and by cementation. The first way is used to convert iron into steel immediately from the ore, or from crude or cast-iron. By the second way, bar-iron is exposed to a long continued heat surrounded by charcoal. Each of these ways has advantages peculiar to itself; but the same causes in fact predominate in both, for both kinds of steel are produced by heat and charcoal. The only difference between the two methods is this; in making steel by fusion the charcoal is not so equally defended from the access of air as in the other way.

Sweedenborghius has given the following description of the method used in Dalecarlia for making steel from cast-iron. The ore from which the crude iron to be converted into steel is obtained is of a good kind. It is black, friable, and composed of many small grains, and it produces very tough iron. The conversion into steel is made upon a forge-hearth, something smaller than common. The sides and bottom are made of cast-iron. The tuyere is placed, with very little inclination, on one of the side-plates. The breadth of the fire-place is fourteen inches; its length is greater. The lower part of the tuyere is six inches and a half above the bottom. In the interior part of the fire-place there is an oblong opening for the flowing of the superfluous scoriae. The workmen first put scoriae on the bottom, then charcoal and powder of charcoal, and upon these the cast-iron run or cut into small pieces. They cover the iron with more charcoal, and excite the fire. When the pieces of iron are of a red white, and before they begin to melt, they stop the bellows, and carry the mass under a

Steel.

large hammer, where they break it into pieces of three or four pounds each. The pieces are again brought to the hearth, and laid within reach of the workman, who plunges some of them into the fire, and covers them with coal. The bellows are made to blow slowly till the iron is liquefied. Then the fire is increased; and when the fusion has been long enough continued, the scoriae are allowed to flow out; and at that time the iron hardens. The workman adds more of the pieces of crude iron, which he treats in the same manner; and so on a third and a fourth time, till he obtains a mass of steel of about a hundred pounds, which is generally done in about four hours. This mass is raised and carried to the hammer, where it is forged, and cut into four pieces, which are farther beat into square bars four or five feet long. When the steel is thus forged, it is thrown into water that it may be easily broken; for it is yet crude and coarse-grained. The steel is then carried to another hearth similar to the former, and there broken in pieces. These pieces are laid regularly in the fire-place, first two parallel, upon which seven or eight others are placed across; then a third row across the second, in such a manner that there is space left between those of the same row. The whole is then covered with charcoal, and the fire is excited. In about half or three quarters of an hour the pieces are made hot enough, and are then taken from the fire, one by one, to the hammer, to be forged into little bars from half a foot to two feet long, and while hot are thrown into water to be hardened. Of these pieces sixteen or twenty are put together so as to make a bundle, which is heated and welded, and afterwards forged into bars four inches thick, which are then broken into pieces of convenient length for use.

The method of converting iron into steel by cementation is a very simple process. It consists solely in exposing it for a certain time to a strong degree of heat, while closely covered with charcoal and defended from the external air. The furnaces employed for converting iron into steel (says a manufacturer of this metal) are of different sizes; some capable of converting only three or four tons weight, while others are capacious enough to contain from seven to eight or ten tons. The out-sides of these furnaces rise up in the form of a cone, or sugar-loaf, to the height of a very considerable number of feet. In the inside, opposite to each other, are placed two very long chests, made either of stone, or of bricks capable of bearing the strongest fire; which is placed between the two chests. The bars of iron, after the bottom is furnished with a necessary quantity of charcoal dust, are laid in *stratum super stratum*, with intermediate beds of the charcoal dust, to such a height of the chests as only to admit of a good bed at top; which is then all covered over, to prevent the admission of the common air; which, could it procure an entrance, would greatly injure the operation. The iron being thus situated, the fire is lighted; which is some time before it can be raised to a sufficient degree of heat to produce any considerable effect. After which it is continued for so many days as the operator may judge proper; only now and then drawing out what they call a proof bar. This is done by openings fit for the purpose at the ends of the chest, which are easily and with expedition stopped up again, without occasioning any injury to the contents left behind. When the opera-

tor

*Steel.* tor apprehends the conversion is sufficiently completed, the fire is suffered to go out, and the furnace, with its contents, is left gradually to cool. This may take up several days: after which the furnace is discharged, by taking out the bas of steel and the remainder of the charcoal dust.

There is a manufactory established in the parish of Cra-mond, about five miles from Edinburgh, in which this method is practised with great success. Great quantities of steel are made there, which we have reason to believe is of as excellent a quality as any that can be procured from other countries.

When the charcoal is taken out, it is found as black as before it was introduced into the furnace, unless by accident the external air has got admittance. The bars preserve their exterior form only; the surface frequently exhibits a great number of tumors or blisters, whence they are called *blistered steel*.

The hardness of steel is much increased by tempering. This consists in heating it to a red heat, and then plunging it suddenly into cold water. If it be allowed to cool slowly, it still preserves its ductility; or if it be heated again after being tempered, it loses its hardness, and again becomes ductile. In heating steel for tempering it, the most remarkable circumstance is, the different colours it assumes, according to the degree of heat it has received. As it is gradually heated, it becomes white, then yellow, orange, purple, violet, and at last of a deep blue colour.

According to Reaumur, the steel which is most heated in tempering is generally the hardest. Hence it is believed, that the more violent the heat to which steel is exposed, and the more suddenly it is plunged into cold water, the harder the steel will be. Rinman, again, has deduced a conclusion directly opposite, that the steel which is naturally hardest demands the least degree of heat to temper it. Different methods have been proposed to determine what degree of heat is most proper; but the easiest method is to take a bar of steel, so long, that while one end is exposed to a violent heat, the other may be kept cold. By examining the intermediate portions, it may be found what degree of heat has produced the greatest hardness.

By tempering, steel is said to increase both in bulk and in weight. Reaumur says, that a small bar six inches long, six lines broad, and half an inch thick, was increased at least a line in length after being tempered to a reddish white colour; that is, supposing the dilatation proportional in all dimensions increasing at the rate of 48 to 49. Iron also expands when heated; but when the heat passes off, it returns to its former dimensions. That the weight of steel is also augmented by tempering, has been found by experiment. Rinman having weighed exactly in an hydrostatic balance two kinds of fine steel made by cementation, and not tempered, found their density to be to that of water as 7,991 to 1; after being tempered, the density of the one was 7,553, and that of the other 7,708. M. de Morveau took three bars just of a size to enter a certain caliber 28 lines long, and each side two lines broad; one of the bars was soft iron, and the two others were taken from the same piece of fine steel. In order to communicate an equal degree of heat to each, in an earthen vessel in the middle of a wind furnace, the bar of soft iron and one of the bars of steel were thrown into

*Steel.* cold water; the other bar of steel was cooled slowly over some pieces of charcoal at a distance from the furnace. The bar of iron and the one of steel that was allowed to cool slowly passed easily into the caliber again; but the bar of tempered steel was lengthened almost one-ninth of a line.

There is no doubt but tempering changes the grain; that is, the appearance of the texture of a piece of steel when broken. This is the mark which is usually observed in judging of the quality of steel, or of the tempering which suits it best. The tempered bar is broken in several places after having received different degrees of heat in different places. What proves completely the effect of heat upon the grain, at least in some kinds of steel, is, that a bar of steel exposed to all the intermediate degrees of heat, from the smallest sensible heat to a red heat, is found to increase in fineness of grain from the slightly heated to the strongly heated end. The celebrated Rinman has made many experiments on the qualities of steel exposed to different degrees of heat in tempering, but particularly to three kinds, viz. steel heated to an obscure red, to a bright red, and to a red white. Hard brittle steel, made by cementation, and heated to an obscure red and tempered, exhibited a fine grain, somewhat shining, and was of a yellow white colour. When tempered at a bright red heat, the grain was coarser and more shining; when tempered at a red white heat, the grain was also coarse and shining.

With a view to determine how far steel might be improved in its grain by tempering it in different ways, M. de Morveau took a bar of blistered steel, and broke it into four parts nearly of the same weight. They were all heated to a red heat in the same furnace, and withdrawn from the fire at the same instant. One of the pieces was left at the side of the furnace to cool in the air, the second was plunged into cold water, the third into oil, and the fourth into mercury. The piece of steel that was cooled in the air resisted the hammer a long time before it was broken; it was necessary to notch it by the file, and even then it was broken with difficulty. It showed in its fracture a grain sensibly more fine and more shining than it was before. The second piece, which had been plunged into water, broke easily: its grain was rather finer than the first, and almost of the same white colour. The third piece, which was tempered in oil, appeared very hard when tried by the file; it was scarcely possible to break it. Its grain was as fine, but not quite so bright, as that which was tempered in water. The fourth piece, which was dipped into mercury, was evidently superior to all the rest in the fineness and colour of the grain. It broke into many fragments with the first stroke of the hammer, the fractures being generally transverse.

M. de Morveau was not altogether satisfied with these experiments, and therefore thought it necessary to repeat them with finer steel. He took a bar of steel two lines square, such as is used in Germany for tools by engravers and watchmakers; he divided it into four pieces, and treated them in the same way as he had done the blistered steel. The first piece, which was cooled in the air, it was very difficult to break: the fracture appeared in the middle of the grain very fine, but white and shining. The second, which was tempered in water, was broken into three fragments at the

Steel,  
Steel-yard.

first blow; its grain was perfectly equal, of a grey ash-colour, and of remarkable fineness. One of its sides was polished, and a drop of the nitrous acid which was poured upon it left a black spot, but not deep. But when a drop of the same acid was poured on the middle of the fracture, after it had been equally polished, it left a black spot much deeper. The third piece, which was plunged in oil, bent as easily as the piece which was cooled in the air; the file made an impression on it with difficulty; it was necessary to break it with a vice: its grain was inferior in fineness to the second, but it was of a darker colour. The fourth, which was tempered in mercury, exhibited a grain of an intermediate fineness between the second and the third. From these experiments, it appears that steel may be hardened by tempering it, not only with water, but with any other liquid which is capable of accelerating its cooling.

Steel may be unmade, or reduced to the state of iron, by a management similar to that by which it is made, that is, by cementation. But the cement used for this purpose must be composed of substances entirely free from inflammable matter, and rather capable of absorbing it, as calcareous earth or quicklime. By a cementation with calcareous earth, continued during eight or ten hours, steel is reduced to the state of iron. After it has been tempered, it may be again untempered, and softened to any degree that we think proper; for which purpose we have only to heat it more or less, and to let it cool slowly. By this method we may soften the hardest-tempered steel.

STEEL-BOW Tenants. See TENURE.

Salt of STEEL. See CHEMISTRY, n<sup>o</sup> 697.

STEEL-YARD, is one of the most ancient presents which science has made to society; and though long in disuse in this country, is in most nations of the world the only instrument for ascertaining the weight of bodies. What is translated *balance* in the Penta-teuch, is in fact steelyard, being the word used by the Arabs to this day for their instrument, which is a steelyard. It is in common use in all the Asiatic nations. It was the *statera* of the Greeks and Romans, and seems to have been more confided in by them than the balance; for which reason it was used by the goldsmiths, while the balance was the instrument of the people.—*Non aurificis statera sed populari trutina examinare.* Cic. de Or. 238.

The steelyard is a lever of unequal arms; and, in its most perfect form, is constructed much like a common balance. It hangs in sheers E (fig. 1.) resting on the nail C, and the scale L for holding the goods hangs by a nail D on the short arm BC. The counter weight P hangs by a ring of tempered steel, made sharp in the inside, that it may bear by an edge on the long arm CA of the steelyard. The under edge of the centre nail C, and the upper edge of the nail D, are in the straight line formed by the upper edge of the long arm. Thus the three points of suspension are in one straight line. The needle or index of the steelyard is perpendicular to the line of the arms, and plays between the sheers. The short arm may be made so massive, that, together with the scale, it will balance the long arm unloaded. When no goods are in the scale, and the counter weight with its hook are removed, the steelyard acquires a horizontal position, in consequence of its centre of gravity being below the axis of suspension. The

rules for its accurate construction are the same as for a common balance. Steel-y

The instrument indicates different weights in the following manner: The distance CD of the two nails is considered as an unit, and the long arm is divided into a number of parts equal to it; and these are subdivided as low as is thought proper: or in general, the long arm is made a scale of equal parts, commencing at the edge of the nail C; and the short arm contains some determined number of those equal parts. Suppose, then, that a weight A of 10 pounds is put into the scale L. The counterpoise P must be of such a weight, that, when hanging at the division 10, it shall balance this weight A. Now let any unknown weight W be put into the scale. Slide the hook of the counterpoise along the long arm till it balances this weight. Suppose it then hanging at the division 38. We conclude that there is 38 pounds in the scale. This we do on the authority of the fundamental property of the lever, that forces acting on it, and balancing each other, are in the inverse proportion of the distances from the fulcrum to their lines of direction. Whatever weight the counterpoise is, it is to A as CD to 10, and it is to the weight W as CD to 38; therefore A is to the weight W as 10 to 38, and W is 38 pounds: and thus the weight in the scale will always be indicated by the division at which it is balanced by the counterpoise.

Our well informed readers know that this fundamental property of the lever was discovered by the renowned Archimedes, or at least first demonstrated by him; and that his demonstration, besides the defect of being applicable only to commensurable lengths of the arms, has been thought by metaphysicians of the first note to proceed on a postulate which seems equally to need a demonstration. It has accordingly employed the utmost refinement of the first mathematicians of Europe to furnish a demonstration free from objection. Mr D'Alembert has given two, remarkable for their ingenuity and subtlety; Fontenex has done the same; and Professor Hamilton of Trinity-college, Dublin, has given one which is thought the least exceptionable. But critics have even objected to this, as depending on a postulate which should have been demonstrated.

Since we published the volume containing the article MECHANICS, there has appeared (Phil. Trans. 1794) a demonstration by Mr Vince, which we think unexceptionable, and of such simplicity that it is astonishing that it has not occurred to any person who thinks on the subject. Our readers will not be displeased with an account of it.

Let AE (fig. 2.) be a mathematical lever, or inflexible straight line, resting on the prop A, and supported at E by a force acting upwards. Let two equal weights *b* and *d* be hung on at B and D, equidistant from A and E. Pressures are now exerted at A and E; and because every circumstance of weight and distance is the same, the pressure at E, arising from the action of the weight *b* on the point B, must be the same with the pressure at A, arising from the action of the weight *d* on the point D; and the pressure at E, occasioned by the weight *d*, must be the same with the pressure at A, occasioned by the weight *b*. This must be the case wherever the weights are hung, provided that the distance AB and DE are equal. Moreover,

the

Steel-yard. the sum of the pressures at A and E is unquestionably equal to the sum of the weights, because the weights are supported solely at A and E. Let the two weights be hung on at C the middle point; the pressure at E is still the same. Therefore, in general, the pressure excited at the point E, by two equal weights hanging at any points B and D, is the same as if they were hung on at the middle point between them: but the pressure excited at E is a just measure of the effort or energy of the weights *b* and *d* to urge the lever round the point A. It is, at least, a measure of the opposite force which must be applied at E to sustain or balance this pressure. A very fastidious metaphysician may still say, that the demonstration is limited to a point E, whose distance from A is twice AC, or = AB + AD. But it extends to any other point, on the authority of a postulate which cannot be refused, viz. that in whatever proportion the pressure at E is augmented or diminished, the pressure at this other point must augment or diminish in the same proportion. This being proved, the general theorem may be demonstrated in all proportions of distance, in the manner of Archimedes, at once the most simple, perspicuous, and elegant of all.

We cannot help observing, that all this difficulty (and it is a real one to the philosopher who aims at rendering mechanics a demonstrative science) has arisen from an improper search after simplicity. Had Archimedes taken a lever as it really exists in nature, and considered it as *material*, consisting of atoms united by cohesion; and had he traced the intermediate pressures by whose means the two external weights are put in opposition to each other, or rather to the support given to the fulcrum; all difficulty would have vanished. (See what is said on this subject in the article *STRENGTH of Timber*, &c.)

The quantity of goods which may be weighed by this instrument depends on the weight of the counterpoise, and on the distance CD from the fulcrum at which the goods are suspended. A double counterpoise hanging at the same division will balance or indicate a double quantity of goods hanging at D; and any counterpoise will balance and indicate a double quantity of goods, if the distance CD be reduced to one-half. Many steelyards have two or more points of suspension D, to which the scale may occasionally be attached. Fig. 6. of Plate XCI. Vol. II. represents one of these. It is evident, that in this case the value or indication of the divisions of the long arm will be different, according to the point from which the scale is suspended. The same division which would indicate 20 pounds when CD is three inches, will indicate 30 pounds when it is two inches. As it would expose to chance of mistakes, and be otherwise troublesome to make this reduction, it is usual to make as many divided scales on the long arm as there are points of suspension D on the short arm; and each scale having its own numbers, all trouble and all chance of mistake is avoided.

But the range of this instrument is not altogether at the pleasure of the maker. Besides the inability of a slender beam to carry a great load, the divisions of the scale answering to pounds or half-pounds become very minute when the distance CD is very short; and the balance becomes less delicate, that is, less sensibly affect-

ed by small differences of weight. This is because in such cases the thickness which it is necessary to give the edges of the nails does then bear a sensible proportion to the distance CD between them; so that when the balance inclines to one side, that arm is sensibly shortened, and therefore the energy of the preponderating weight is lessened.

We have hitherto supposed the steelyard to be in equilibrio when not loaded. But this is not necessary, nor is it usual in those which are commonly made. The long arm commonly preponderates considerably. This makes no difference, except in the beginning of the scale. The preponderancy of the long arm is equivalent to some goods already in the scale, suppose four pounds. Therefore when there are really 10 pounds in the scale, the counterpoise will balance it when hanging at the division 6. This division is therefore reckoned 10, and the rest of the divisions are numbered accordingly.

A scientific examination of the steelyard will convince us that it is inferior to the balance of equal arms in point of sensibility: But it is extremely compendious and convenient; and when accurately made and attentively used, it is abundantly exact for most commercial purposes. We have seen one at Leipzig which has been in use since the year 1718, which is very sensible to a difference of one pound, when loaded with nearly three tons on the short arm; and we saw a waggon loaded with more than two tons weighed by it in about six minutes.

The steelyard in common use in the different countries of Europe is of a construction still simpler than what we have described. It consists of a batten of hard wood, having a heavy lump A (fig. 5.) at one end, and a swivel-hook B at the other. The goods to be weighed are suspended on the hook, and the whole is carried in a loop of whip-cord C, in which it is slid backward and forward, till the goods are balanced by the weight of the other end. The weight of the goods is estimated by the place of the loop on a scale of divisions in harmonic progression. They are marked (we presume) by trial with known weights.

The chief use that is now made of the steelyard in these kingdoms is for the weighing of loaded waggons and carts. For this it is extremely convenient, and more than sufficiently exact for the purpose in view. We shall describe one or two of the most remarkable; and we shall begin with that at Leipzig already mentioned.

This steelyard is represented in fig. 4. as run out, and just about to be hooked for lifting up the load. The steelyard itself is OPQ, and is about 12 feet long. The short arm PQ has two points of suspension *c* and *b*; and the stirrup which carries the chains for holding the load is made with a double hook, instead of a double eye, that it may be easily removed from the one pin to the other. For this purpose the two hooks are connected above by an hasp or staple, which goes over the arm of the steelyard like an arch. This is represented in the little figure above the steelyard. The suspension is shifted when the steelyard is run in under cover, by hooking to this staple the running block of a small tackle which hangs in the door through which the steelyard is run out and in. This operation is easy,

Steel yard. but necessary, because the stirrup, chains, and the stage on which the load is placed, weigh some hundreds.

The outer pin *b* is 14 inches, and the inner one *c* is seven inches, distant from the great nail which rests in the sheers. The other arm is about  $10\frac{1}{2}$  feet long, formed with an obtuse edge above. On the inclined plane on each side of the ridge is drawn the scale of weights adapted to the inner pin *c*. The scales corresponding to the outer pin *b* are drawn on the upright sides. The counterpoise slides along this arm, hanging from a saddle-piece made of brass, that it may not contract rust. The motion is made easy by means of rollers. This is necessary, because the counterpoise is greatly above a hundred weight. This saddle-piece has like two laps on each side, on which are engraved vernier scales, which divide their respective scales on the arm to quarters of a pound. Above the saddle is an arch, from the summit of which hangs a little plummet, which shows the equilibrium of the steelyard to the weigher, because the sheers are four feet out of the house, and he cannot see their coincidence with the needle of the steelyard. Lastly, near the end of the long arm are two pins *d* and *e*, for suspending occasionally two eke weights for continuing the scale. These are kept hanging on adjoining hooks, ready to be lifted on by a little tackle, which is also hooked immediately above the pins *d* and *e*.

The scales of weights are laid down on the arm as follows. Let the eke-weights appropriated to the pins *d* and *e* be called D and E, and call the counterpoise C. Although the stirrup with its chains and stage weigh some hundreds, yet the length and size of the arm OP gives it a preponderancy of 300 pounds. Here, then, the scale of weights must commence. The counterpoise weighs about 125 pounds. Therefore,

1. When the load hangs by the pin *b*, 14 inches from the centre, the distance from one hundred to another on the scale is about 11 inches, and the first scale (on the side of the arm) reaches from 300 to 1200. In order to repeat or continue this, the eke-weight E is hung on the pin *e*, and the counterpoise C is brought back to the mark 300; and the two together balance 1100 pounds hanging at *b*. Therefore a second scale is begun on the side of the arm, and continued as far out as the first, and therefore its extremity marks 2000; that is, the counterpoise C at 2000 and the eke-weight E at *e* balance 2000 hanging at *b*.

2. To continue the scale beyond 2000, the load must be hung on the inner pin *c*. The eke-weight E is taken off, and the eke-weight D is hung on its pin *d*. The general counterpoise being now brought close to the sheers, it, together with the weight D at *d*, balance 2000 pounds hanging at *c*. A scale is therefore begun on one of the inclined planes a-top, and continued out to 4000, which falls very near to the pin *d*, each hundred pounds occupying about five inches on the arm. To complete the scale, hang on the eke-weight E on its pin *e*, and bring back the counterpoise to the sheers, and the three together balance 3800 hanging at *c*. Therefore when the counterpoise is now slid out to 4000, it must complete the balance with 5800 hanging at *c*.

It required a little consideration to find out what proportion of the three weights C, D, and E, would

make the repetitions of the scale extend as far as possible, having very little of it expressed twice, or upon two scales, as is the case here. We see that the space corresponding to a single pound is a very sensible quantity on both scales, being one-ninth of an inch on the first two scales, and one twentieth on the last two.

This very ponderous machine, with its massy weights, cannot be easily managed without some assistance from mechanics. It is extremely proper to have it susceptible of motion out and in, that it may be protected from the weather, which would soon destroy it by rust. The contrivance here is very effectual, and abundantly simple.

When the steelyard is not in use, it is supported at one end by the iron-rod F, into which the upper end of the sheers is hooked. The upper end of this rod has a strong hook E, and a little below at *a* it is pierced with a hole, in which is a very strong bolt or pin of tempered steel, having a roller on each end close to the rod on each side. These rollers rest on two joists, one of which is represented by MN, which traverse the building, with just room enough between them to allow the rod F to hang freely down. The other end O of the steelyard rests in the bight of a large flat hook at the end of a chain W, which hangs down between the joists, and is supported on them by a frame with rollers H. This is connected with the rollers at G, which carry the sheers by means of two iron-rods, of which one only can be seen. These connect the two sets of rollers in such a manner that they must always move together, and keep their distance invariable. This motion is produced by means of an endless rope HI ZLKVH passing over the pulleys I and K, which turn between the joists, and hanging down in a bight between them. It is evident that by pulling on the part LZ we pull the frame of rollers in the direction GH, and thus bring the whole into the house in the position marked by the dotted figure. It is also plain, that by pulling on the part LK we force the roller frame and the whole apparatus out again.

It remains to show how the load is raised from the ground and weighed. When the steelyard is run out for use, the upper hook E just enters into the ring D, which hangs from the end of the great oaken lever BCA about 22 feet long, turning on gudgeons at C about 5 feet from this end. From the other end A descends a long iron-rod SR, which has one side formed into a toothed rack that is acted on by a frame of wheel-work turned by an endless screw and winch Q. Therefore when the hook E is well engaged in the ring D, a man turns the winch, and thus brings down the end A of the great lever, and raises the load two or three inches from the ground. Every thing is now at liberty, and the weigher now manages his weights on the arm of the steelyard till he has made an equilibrium.

We need not describe the operation of letting down the load, disengaging the steelyard from the great lever, and bringing it again under cover. The whole of this service is performed by two men, and may be done in succession by one, and is over in five or six minutes.

The most compendious and economical machine of this kind that we have seen is one, first used (we have heard) for weighing the riders of race-horses, and afterwards



Steel-yard. terwards applied to the more reputable service of weighing loaded carriages.

Fig. 5. is a plan of the machine. KLMN is the plan of a rectangular box, which has a platform lid or cover, of size sufficient for placing the wheels of a cart or wagon. The box is about a foot deep, and is sunk into the ground till the platform-cover is even with the surface. In the middle of the box is an iron lever supported on the fulcrum pin  $ik$ , formed like the nail of balance, which rests with its edge on arches of hardened steel firmly fastened to the bottom of the box. This lever goes through one side of the box, and is furnished at its extremity with a hard steel pin  $lm$ , also formed to an edge below. In the very middle of the box it is crossed by a third nail of hardened steel  $gh$ , also formed to an edge, but on the upper side. These three edges are in one horizontal plane, as in a well

In the four corners A, A', E, E, of the box are firmly fixed four blocks of tempered steel, having their upper surfaces formed into spherical cavities, well polished and hard tempered. ABCDE represents the upper edge of an iron bar of considerable strength, which rests on the cavities of the steel blocks in A and E, by means of two hard steel studs projecting from its under edge, and formed into obtuse angled points or cones. These points are in a straight line parallel to the side KN of the box. The middle part C of this crooked bar is faced with hard-tempered steel below, and is there formed into an edge parallel to AE and KN, by which it rests on the upper edge of the steel pin  $gh$  which is in the lever. In a line parallel to AE, and on the upper side of the crooked bar ACE, are fixed two studs or points of hardened steel B and D projecting upwards above half an inch. The platform-cover has four short feet like a stool, terminated by hard steel studs, which are shaped into spherical cavities and well polished. With these it rests on the four steel points B, B', D, D'. The bar ACE is kneed in such a manner vertically, that the points A, B, D, E and the edge C are all in a horizontal plane. These particulars will be better understood by looking at the elevation in fig. 6. What has been said of the bar ACE must be understood as also said of the bar A' C' E'.

Draw through the centre of the box the line  $abc$  perpendicular to the line AE, BD. It is evident that the bar ACE is equivalent to a lever  $abc$ , having the fulcrum or axis AE resting with its extremity C on the pin  $gh$  and loaded at  $b$ . It is also evident that  $aC$  is to  $ab$  as the load on this lever to the pressure which it exerts on the pin  $gh$ , and that the same proportion subsists between the whole load on the platform and the pressure which it exerts on the pin  $gh$ . It will also appear, on an attentive consideration, that this proportion is not deranged in whatever manner the load is placed on the platform. If very unequally, the two ends of the pin  $ab$  may be unequally pressed, and the lever wrenched and strained a little; but the total pressure is not changed.

If there be now placed a balance or steelyard at the side LK, in such a manner that one end of it may be directly above the pin  $lm$  in the end of the lever EOF, they may be connected by a wire or slender rod, and a weight on the other arm of the balance or steelyard may be put in equilibrio with any load that can be laid on the platform. A small counterpoise being

first hung on to balance the apparatus when unloaded, any additional weight will measure the load really laid on the platform. If  $ab$  be to  $ac$  as 1 to 8, and EO to EF also as 1 to 8, and if a common balance be used above, 64 pounds on the platform will be balanced by one pound in the scale, and every pound will be balanced by  $\frac{1}{8}$ th of an ounce. This would be a very convenient partition for most purposes, as it would enable us to use a common balance and common weights to complete the machine: Or it may be made with a balance of unequal arms, or with a steelyard.

Some have thought to improve this instrument by using edges like those of the nails of a balance, instead of points. But unless made with uncommon accuracy, they will render the balance very dull. The small deviation of the two edges A and E, or of B and D, from perfect parallelism to KN, is equivalent to a broad surface equal to the whole deviation. We imagine that, with no extraordinary care, the machine may be made to weigh within  $\frac{1}{10000}$ th of the truth, which is exact enough for any purpose in commerce.

It is necessary that the points be attached to the bars. Some have put the points at A and E in the blocks of steel fastened to the bottom, because the cavity there lodged water or dirt, which soon destroyed the instrument with rust. But this occasions a change of proportion in the first lever by any shifting of the crooked bars; and this will frequently happen when the wheels of a loaded cart are pushed on the platform. The cavity in the steel stud should have a little rim round it, and it should be kept full of oil. In a nice machine a quarter of an inch of quicksilver would effectually prevent all these inconveniences.

The simplest and most economical form of this machine is to have no balance or second steelyard; but to make the first steelyard EOF a lever of the first kind, viz. having the fulcrum between O and F, and allow it to project far beyond the box. The long or outward arm of this lever is then divided into a scale of weights, commencing at the side of the box. A counterpoise must be chosen, such as will, when at the beginning of the scale, balance the smallest load that will probably be examined. It will be convenient to carry on this scale by means of eke-weights hung on at the extremity of the lever, and to use but one moveable weight. By this method the divisions of the scale will have always one value. The best arrangement is as follows: Place the mark O at the beginning of the scale, and let it extend only to 100, if for pounds; or to 112, if for cwt.; or to 10, if for stones; and let the eke-weights be numbered 1, 2, 3, &c. Let the lowest weight be marked on the beam. This is always to be added to the weight shown by the operation. Let the eke-weights stand at the end of the beam, and let the general counterpoise always hang at O. When the cart is put on the platform, the end of the beam tilts up. Hang on the heaviest eke-weight that is not sufficient to press it down. Now complete the balance by sliding out the counterpoise. Suppose the constant load to be 312 lb. and that the counterpoise stands at 86, and that the eke-weight is 9; we have the load =  $986 + 312 = 1298$  lbs.

STEELE (Sir Richard), was born about the year 1676 in Dublin; in which kingdom one branch of the family was possessed of a considerable estate in the county

Steel-yard,  
Steele.

Steele.

county of Wexford. His father, a counsellor at law in Dublin, was private secretary to James duke of Ormond; but he was of English extraction: and his son, while very young, being carried to London, he put him to school at the Charter-house, whence he was removed to Merton College in Oxford. Our author left the university, which he did without taking any degree, in the full resolution to enter into the army. This step was highly displeasing to his friends; but the ardour of his passion for a military life rendered him deaf to any other proposal. Not being able to procure a better station, he entered as a private gentleman in the horse guards, notwithstanding he thereby lost the succession to his Irish estate. However, as he had a flow of good-nature, a generous openness and frankness of spirit, and a sparkling vivacity of wit, these qualities rendered him the delight of the soldiery, and procured him an ensign's commission in the guards. In the mean time, as he had made choice of a profession which set him free from all the ordinary restraints in youth, he spared not to indulge his inclinations in the wildest excesses. Yet his gaieties and revels did not pass without some cool hours of reflection; it was in these that he drew up his little treatise intitled *The Christian Hero*, with a design, if we may believe himself, to be a check upon his passions. For this purpose it had lain some time by him, when he printed it in 1701, with a dedication to Lord Cutts, who had not only appointed him his private secretary, but procured for him a company in Lord Lucas's regiment of Fusileers.

The same year he brought out his comedy called *The Funeral*, or *Grief à la mode*. This play procured him the regard of King William, who resolved to give him some essential marks of his favour; and though, upon that prince's death, his hopes were disappointed, yet, in the beginning of Queen Anne's reign, he was appointed to the profitable place of gazetteer. He owed this post to the friendship of lord Halifax and the earl of Sunderland, to whom he had been recommended by his school-fellow Mr Addison. That gentleman also lent him an helping hand in promoting the comedy called *The Tender Husband*, which was acted in 1704 with great success. But his next play, *The Lying Lover*, had a very different fate. Upon this rebuff from the stage, he turned the same humorous current into another channel; and early in the year 1709, he began to publish the *Tatler*: which admirable paper was undertaken in concert with Dr Swift. His reputation was perfectly established by this work; and, during the course of it, he was made a commissioner of the stamp-duties in 1710. Upon the change of the ministry the same year, he joined the duke of Marlborough, who had several years entertained a friendship for him; and upon his Grace's dismissal from all employments in 1711, Mr Steele addressed a letter of thanks to him for the services which he had done to his country. However, as our author still continued to hold his place in the stamp-office under the new administration, he forbore entering with his pen upon political subjects; but, adhering more closely to Mr Addison, he dropt the *Tatler*, and afterwards, by the assistance chiefly of that steady friend, he carried on the same plan much improved, under the title of *The Spectator*. The success of this paper was equal to that of the for-

Steele.

mer; which encouraged him, before the close of it, to proceed upon the same design in the character of the *Guardian*. This was opened in the beginning of the year 1713, and was laid down in October the same year. But in the course of it his thoughts took a stronger turn to politics: he engaged with great warmth against the ministry; and being determined to prosecute his views that way by procuring a seat in the house of commons, he immediately removed all obstacles thereto. For that purpose he took care to prevent a forcible dismissal from his post in the stamp-office, by a timely resignation of it to the Earl of Oxford; and at the same time gave up a pension, which had been till this time paid him by the queen as a servant to the late prince George of Denmark. This done, he wrote the famous *Guardian* upon the demolition of Denbirk, which was published Aug. 7. 1713; and the parliament being dissolved next day, the *Guardian* was soon followed by several other warm political tracts against the administration. Upon the meeting of the new parliament, Mr Steele having been returned a member for the borough of Stockbridge in Dorsetshire, took his seat accordingly in the house of commons; but was expelled thence in a few days after, for writing the close of the paper called the *Englishman*, and one of his political pieces intitled the *Crisis*. Presently after his expulsion, he published proposals for writing the history of the duke of Marlborough: at the same time he also wrote the *Spinster*; and, in opposition to the *Examiner*, he set up a paper called the *Reader*, and continued publishing several other things in the same spirit till the death of the queen. Immediately after which, as a reward for these services, he was taken into favour by her successor to the throne, king George I. He was appointed surveyor of the royal stables at Hampton-Court, governor of the royal company of comedians, put into the commission of the peace for the county of Middlesex, and in 1715 received the honour of knighthood. In the first parliament of that king, he was chosen member for Boroughbridge in Yorkshire; and, after the suppression of the rebellion in the north, was appointed one of the commissioners of the forfeited estates in Scotland. In 1718, he buried his second wife, who had brought him a handsome fortune and a good estate in Wales; but neither that, nor the ample additions lately made to his income, were sufficient to answer his demands. The thoughtless vivacity of his spirit often reduced him to little shifts of wit for its support; and the project of the Fish-pool this year owed its birth chiefly to the projector's necessities. This vessel was intended to carry fish alive, and without waiting, to any part of the kingdom: but notwithstanding all his towering hopes, the scheme proved very ruinous to him; for after he had been at an immense expence in contriving and building his vessel, besides the charge of the patent, which he had procured, it turned out upon trial to be a mere project. His plan was to bring salmon alive from the coast of Ireland; but these fish, though supplied by this contrivance with a continual stream of water while at sea, yet uneasy at their confinement, shattered themselves to pieces against the sides of the pool; so that when they were brought to market they were worth very little.

The following year he opposed the remarkable peerage bill in the house of commons; and, during the

Steele.

course of this opposition to the court, his licence for acting plays was revoked, and his patent rendered ineffectual, at the instance of the lord chamberlain. He did his utmost to prevent so great a loss; and finding every direct avenue of approach to his royal master effectually barred against him by his powerful adversary, he had recourse to the method of applying to the public, in hopes that his complaints would reach the ear of his sovereign, though in an indirect course, by that canal. In this spirit he formed the plan of a periodical paper, to be published twice a-week, under the title of the *Theatre*; the first number of which came out on the 2d of January 1719-20. In the mean time, the misfortune of being out of favour at court, like other misfortunes, drew after it a train of more. During the course of this paper, in which he had assumed the feigned name of *Sir John Edgar*, he was outrageously attacked by Mr Dennis, the noted critic, in a very abusive pamphlet, intitled *The Character and Conduct of Sir John Edgar*. To this insult our author made a proper reply in the Theatre.

While he was struggling with all his might to save himself from ruin, he found time to turn his pen against the mischievous South-Sea scheme, which had nearly brought the nation to ruin in 1720; and the next year he was restored to his office and authority in the play-house in Drury-Lane. Of this it was not long before he made an additional advantage, by bringing his celebrated comedy called the *Conscious Lovers* upon that stage, where it was acted with prodigious success; so that the receipt there must have been very considerable, besides the profits accruing by the sale of the copy, and a purse of 500l. given to him by the king, to whom he dedicated it. Yet notwithstanding these ample supplies, about the year following, being reduced to the utmost extremity, he sold his share in the play-house; and soon after commenced a law-suit with the managers, which in 1726 was determined to his disadvantage. Having now again, for the last time, brought his fortune, by the most heedless profusion, into a desperate condition, he was rendered altogether incapable of retrieving the loss, by being seized with a paralytic disorder, which greatly impaired his understanding. In these unhappy circumstances, he retired to his seat at Llanganor near Caermarthen in Wales, where he paid the last debt to nature on the 21st of September 1729, and was privately interred, according to his own desire, in the church of Caermarthen. Among his papers were found the manuscripts of two plays, one called *The Gentlemen*, founded upon the eunuch of Terence, and the other intitled *The School of Action*, both nearly finished.

Sir Richard was a man of undisssembled and extensive benevolence, a friend to the friendless, and, as far as his circumstances would permit, the father of every orphan. His works are chaste and manly. He was a stranger to the most distant appearance of envy or malevolence; never jealous of any man's growing reputation; and so far from arrogating any praise to himself from his conjunction with Mr Addison, that he was the first who desired him to distinguish his papers. His greatest error was want of economy: however, he was certainly the most agreeable, and (if we may be allowed the expression) the most innocent rake that ever trod the rounds of dissipation.

STEEPLE, an appendage erected generally on the western end of churches, to hold the bells. Steeples are denominated from their form, either spires or towers: the first are such as ascend continually diminishing either conically or pyramidally; the latter are mere parallelo-peds, and are covered a-top platform-like.

STEERAGE, on board a ship, that part of the ship next below the quarter-deck, before the bulk-head of the great cabin where the steersman stands, in most ships of war. See STEERING.

STEERING, in navigation, the art of directing the ship's way by the movements of the helm; or of applying its efforts to regulate her course when she advances.

The perfection of steering consists in a vigilant attention to the motion of the ship's head, so as to check every deviation from the line of her course in the first instant of its motion; and in applying as little of the power of the helm as possible. By this she will run more uniformly in a straight path, as declining less to the right and left; whereas, if a greater effort of the helm is employed, it will produce a greater declination from the course, and not only increase the difficulty of steering, but also make a crooked and irregular tract through the water. See HELM.—The helmsman should diligently watch the movements of the head by the land, clouds, moon, or stars; because, although the course is in general regulated by the compass, yet the vibrations of the needle are not so quickly perceived as the fallies of the ship's head to the right or left, which, if not immediately restrained, will acquire additional velocity in every instant of their motion, and demand a more powerful impulse of the helm to reduce them; the application of which will operate to turn her head as far on the contrary side of her course.—The phrases used in steering a ship vary according to the relation of the wind to her course. Thus, if the wind is fair or large, the phrases used by the pilot or officer who superintends the steerage are, *port, star-board, and steddly*. The first is intended to direct the ship's course farther to the right; the second is to guide her farther to the left; and the last is designed to keep her exactly in the line whereon she advances, according to the course prescribed. The excess of the first and second movement is called *hard-a-port*, and *hard-a-star-board*; the former of which gives her the greatest possible inclination to the right, and the latter an equal tendency to the left.—If, on the contrary, the wind is foul or scant, the phrases are *luff, thus, and no nearer*: the first of which is the order to keep her close to the wind; the second, to retain her in her present situation; and the third, to keep her sails full.

In a ship of war, the exercise of steering the ship is usually divided amongst a number of the most expert sailors, who attend the helm in their turns; and are accordingly called *timoneers*, from the French term *timonier*, which signifies "helmsman." The steerage is constantly supervised by the quarter-masters, who also attend the helm by rotation. In merchant ships every seaman takes his turn in this service, being directed therein by the mate of the watch, or some other officer.—As the safety of a ship, and all contained therein, depends in a great measure on the steerage or effects of the helm, the apparatus by which it is managed should often be diligently examined by the proper officers. In-

Steeple,  
||  
Steering.

Stegarium  
||  
Stem.

Stem  
||  
Stemson.

deed, a negligence in this important duty appears almost unpardonable, when the fatal effects which may result from it are duly considered.

STEGANIUM. See SLATE.

STEGANOGRAPHY, the art of secret writing, or of writing in ciphers, known only to the persons corresponding. See CIPHER.

STELLARIA, STICHWORT, in botany: A genus of plants belonging to the class of *decandria*, and order of *trigynia*; and in the natural system arranged under the 22d order, *Caryophyllea*. The calyx is pentaphyllous and spreading. There are five petals, each divided into two segments. The capsule is oval, unilocular, and polyspermous. There are nine species, the nemorum, dichotoma, radians, holosteia, graminea, cerastoides, undulata, biflora, and arenaria. Three of these are British plants. 1. *Nemorum*, broad-leaved stichwort. The stalks are about a foot or eighteen inches high, and branched in a panicle at the top. The leaves are heart-shaped, and of a paler green on the under than on the upper side; the lower ones being supported by foot-stalks which are hairy and channelled; the upper ones are sessile. The calyx is erect, somewhat hairy and white on the margins. The petals are bifid almost to the base. There is a small nectarium between the longer stamina and the calyx.—2. *Holosteia*, greater stichwort. The stalks are about two feet long; the petals are nearly twice the length of the calyx, and divided half-way to the base. It is common in woods and hedges.—3. *Graminea*, less stichwort. The stem is near a foot high. The leaves are linear and entire, and the flowers grow in loose panicles. It is frequent in dry pastures. There is a variety of this species called *bog stichwort*, with smooth, oval, sessile leaves, and few leaves, which grows often in wet marshy places. The stalk is quadrangular; the petals scarcely longer than the calyx, and bifid to the base.

STELLATE, among botanists, expresses leaves which grow not less than six at a joint, and are arranged like the rays of a star.

STELLERA, GERMAN GROUNDSEL, in botany: A genus of plants belonging to the class of *diandria*, and order of *monogynia*; and in the natural system arranged under the 31st order, *Veprecula*. There is no calyx. The corolla is quadrid. The stamina are very short. There is only one seed, which is black. The species are two in number, passerina and chamaejasme.

STELLIONATE, in the civil law, a kind of crime committed by a fraudulent bargain, where one of the parties sells a thing for what it is not; as if I sell an estate for my own which belongs to another, or convey a thing as free and clear which is already engaged to another, or put off copper for gold, &c.

STEM, in botany, that part of a plant arising out of the root, and which sustains the leaves, flowers,

fruits, &c. By washing and rubbing the stems of trees, their annual increase is promoted; for the method of doing which, see the article TREE.

STEM of a Ship, a circular piece of timber into which the two sides of a ship are united at the fore-end: the lower end of it is scarfed to the keel, and the bowsprit rests upon its upper end. The stem is formed of one or two pieces, according to the size of the vessel; and as it terminates the ship forward, the ends of the wales and planks of the sides and bottom are let into a groove or channel, in the middle of its surface, from the top to the bottom; which operation is called *rabiting*. The outside of the stem is usually marked with a scale, or division of feet, according to its perpendicular height from the keel. The intention of this is to ascertain the draught of water at the fore-part, when the ship is in preparation for a sea-voyage, &c. The stem at its lower end is of equal breadth and thickness with the keel, but it grows proportionally broader and thicker towards its upper extremity. See *SHIP-Building*.

STEMMATA, in the history of insects, are three smooth hemispheric dots, placed generally on the top of the head, as in most of the hymenoptera and other classes. The name was first introduced by Linnaeus.

STEMODIA, in botany: A genus of plants belonging to the class of *didynamia*, and order of *angiospermia*; and in the natural system ranging under the 40th order, *Personate*. The calyx is quinquepartite; the corolla bilabiate; there are four stamina; each of the filaments are bifid, and have two antheræ. The capsule is bilocular. There is only one species, the maritima.

STEMPHYLA, a word used by the ancients to express the husks of grapes, or the remains of the pressings of wine. The same word is also used by some to express the remaining mass of the olives, after the oil is pressed out.

STEMPHYLITES, a name given by the ancients to a sort of wine pressed hard from the husks.

STEMPLES, in mining, cross bars of wood in the shafts which are sunk to mines.

In many places the way is to sink a perpendicular hole, or shaft, the sides of which they strengthen from top to bottom with wood-work, to prevent the earth from falling in: the transverse pieces of wood used to this purpose they call *stemples*, and by means of these the miners in some places descend, without using any rope, catching hold of these with their hands and feet.

STEMSON, in a ship, an arching piece of timber fixed within the apron, to reinforce the scarf thereof, in the same manner as the apron supports the scarf of the stern. In large ships it is usually formed of two pieces.

Fig. 4.

STEELYARD.

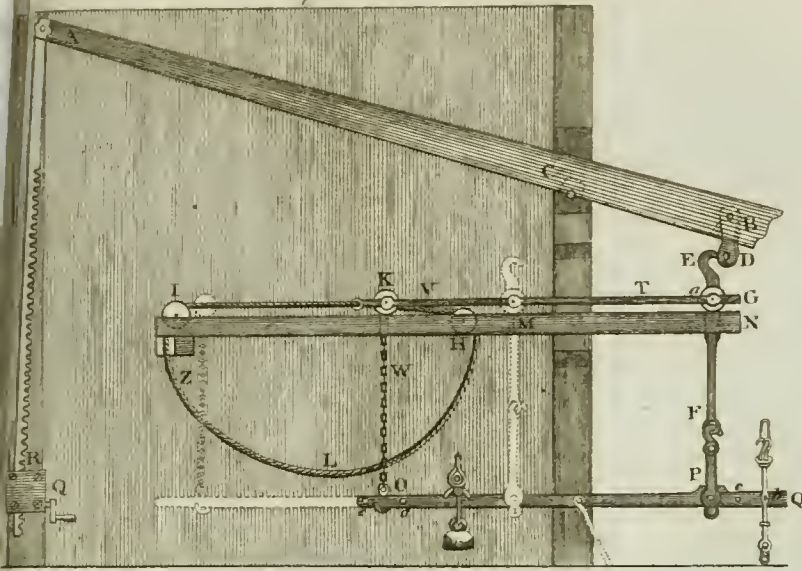

Fig. 2.

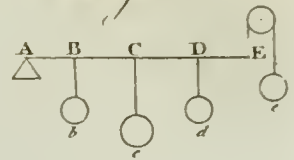

Fig. 1.

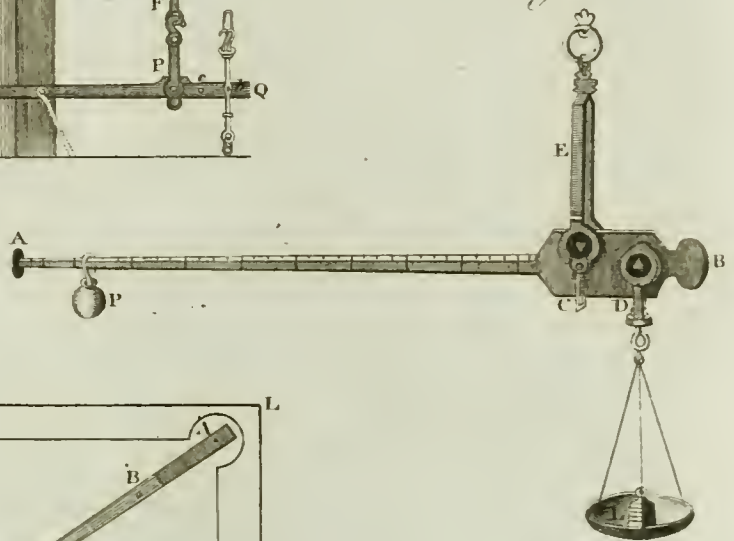

Fig. 5.

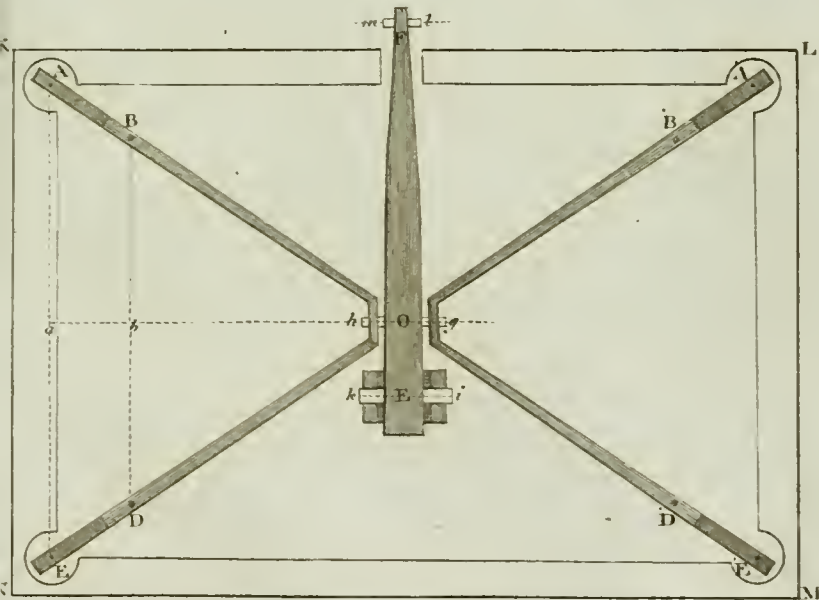

Fig. 3.

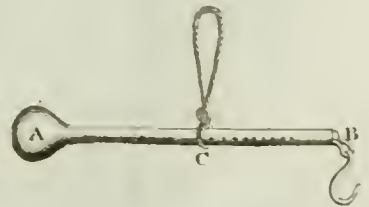
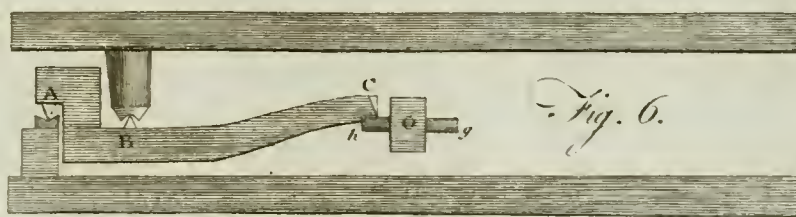

Fig. 6.





## S T E N O G R A P H Y (A).

## C H A P. I.

THE art of stenography, or short writing, was known and practised by most of the ancient civilized nations. The Egyptians, who were distinguished for learning at an early period, at first expressed their words by a delineation of figures called *hieroglyphics*. A more concise mode of writing seems to have been afterwards introduced, in which only a part of the symbol or picture was drawn. This answered the purpose of short-hand in some degree. After them the Hebrews, the Greeks, and the Romans\*, adopted different methods of abbreviating their words and sentences, suited to their respective languages. The initials, the finals, or radicals, often served for whole words; and various combinations of these sometimes formed a sentence. Arbitrary marks were likewise employed to determine the meaning, and to assist legibility; and it seems probable that every writer, and every author of antiquity, had some peculiar method of abbreviation, calculated to facilitate the expression of his own sentiments, and intelligible only to himself.

It is also probable, that some might by these means take down the heads of a discourse or oration; but few, very few, it is presumed, could have followed a speaker through all the meanders of rhetoric, and noted with precision every syllable, as it dropt from his mouth, in a manner legible even to themselves.

To arrive at such consummate perfection in the art was reserved for more modern times, and is still an acquisition by no means general.

In every language of Europe, till about the close of the 16th century, the Roman plan of abbreviating (viz. substituting the initials or radicals, with the help of arbitraries, for words) appears to have been employed. Till then no regular alphabet had been invented expressly for stenography, when an English gentleman of the name of *Willis* invented and published one (B). His plan was soon altered and improved, or at least pretended to be so. One alteration succeeded another; and at intervals, for a series of years past, some men of ingenuity and application have composed and published

VOL. XVII. Part II.

systems of stenography, and doubtless have themselves reaped all the advantages that attend it. But among the various methods that have been proposed, and the different plans that have been adopted by individuals, none has yet appeared fortunate enough to gain general approbation; or proved sufficiently simple, clear, and concise, to be universally studied and practised.

Some systems are replete with unmeaning symbols, perplexing arbitraries, and ill-judged contractions; which render them so difficult to be attained by a common capacity, or ordinary application, that it is not to be wondered at if they have sunk into neglect, and are now no longer known (C). Other systems, by being too prolix, by containing a multiplicity of characters, and those characters not simple or easily remembered, become ineffectual to the purpose of expedition, and are only superior in obscurity to a common hand. Some, again, not only reject all arbitraries and contractions, but even prepositions and terminations; which last, if not too lavishly employed and badly devised, highly contribute to promote both expedition and legibility; and though they reduce their characters to fewer than can possibly express the various modifications of sound, yet they make nearly one half of them complex. In the disposition of the vowels, there is the greatest perplexity in most systems. A dot is sometimes substituted for all the vowels indiscriminately, and the judgment is left to determine which letter out of six any dot is intended to express; or a minute space is allotted them; so that unless they be arranged with mathematical precision they cannot be distinguished from one another; but such a minute attention is inconsistent with the nature of short-hand, which should teach us to write down in a short time, as well as in small bounds, what we wish to preserve of what we hear. Nor is the plan of lifting the pen and putting the next consonant in the vowel's place, in the middle of words, less liable to objections; or that of representing all the vowels by distinct characters, being obviously ill calculated for facility and dispatch, and consequently inadmissible into any useful system.

It is to be confessed, that the person who first proposed

5 G

posed

(A) The value of stenography is not unknown to the learned; and the care and success with which it has been lately cultivated in these kingdoms will, in all probability, soon render it an object of general attention. No one, however, appears to us to have simplified and improved the art so much as Dr Mavor, author of *Universal Stenography*, who has liberally permitted us to present our readers with a complete view of his scheme. To those who wish to become proficient in SHORT-WRITING, we earnestly recommend his entire publication (printed for Cadell and Davis, Strand, London), which in many schools of the first reputation now forms a deserved class-book.

(B) Mr Locke says, a regular method of short-writing seems to be known and practised only in Britain. This is not now the case; and indeed there is no reason to doubt whether characters may not be invented to express the various sounds, or letters, employed in any language, either ancient or modern.

(C) A list of writers on stenography. Mr Addy, Aldridge, Angell, Annet, Blandmore, Blosset, Botley, Bridges, Byrom, Coles, Cross, Dix, Everardt, Ewen, Facey, Farthing, Gibbs, Græme, Gurney, Heath, Holdsworth, Hopkins, Jeake, Labourer, Lane, Lyle, Macauley, Mason, Mavor, Metcalfe, Nicholas, Palmer, Rich, Ridpath, Shelton, Steele, Tanner, Taylor, Thicknesse, Tiffen, Webster, Welton, Williamson, Willis, B. D. and Willis, &c.

posed the omission of vowels in the middle of words (n), which it is obvious are not wanted, and invented letters, which could be connected as in a running hand without lifting the pen in the middle of the word, made a real improvement on the works of his predecessors. But, in fine, most systems, either in their plan or execution, labour under some capital defect, attended with circumstances highly discouraging to the learner, and which in a great measure defeat the end of their invention, by being too complicated to be learned with ease and remembered with accuracy, or to be practised with the expedition which is requisite; and so difficult to be deciphered, that a man can scarcely read what he has just written.

To obviate these defects; to provide against prolixity and conciseness, which might occasion obscurity; to exhibit a system founded on the simplest principles, which might be easily learned and read, and yet be capable of the utmost expedition—were the motives that gave rise to the present attempt.

This method will be found different from any yet published, and superior to all in the disposition of the vowels and the facility of arranging them; the confusion in placing which seems to detract from the merit of the best performances on the subject; and it may be affirmed, without ostentation, that characters simpler in their form, and more perfect in their union, have not been applied to the art of stenography.

As well as it could be determined, the simplest characters are appropriated to the letters most usually employed: indeed, as far as possible, those which are complex have been rejected; but as it was an object always kept in view that the writing should be on a line, a few are admitted into the alphabet for that reason.

The characters for the double and triple consonants are the easiest that could be invented, consistent with perspicuity (E); for care has been taken to provide against all obscurity which might arise by adopting letters too similar in their formation; and with respect to the prepositions and terminations, those which occur most frequently are expressed by the simplest characters, which will be found perfectly easy in their application.

The arbitraries are few in number (F), and the arbitrary abbreviations, as they are entirely from the letters of the alphabet, and chosen from some thousands of words in common use, will well repay the learner for an hour's trouble in committing them to memory.

The last chapter lays down a scheme of abbreviation, comprised in a few rules, perfectly easy to be understood and practised by proficients in this art, which we hope will answer the expectation of the author, and will be

found free from the perplexity complained of in many systems where abbreviation is admitted. The principal rules are new, are so easy, so extensive in their use, and so consistent with expedition and legibility, if applied with judgment, that they alone might suffice. The learner is however advised by no means to adopt any of them, till experience has convinced him that they may be used without error or injury to legibility. All abbreviating rules are suited to those only who have made some progress in the stenographic art; for although they certainly promote expedition in a wonderful manner, and afford the greatest ease to a proficient, yet a learner, as expedition is not his first, though his ultimate view, should admit of nothing that in the least renders the reading difficult.

## CHAP. II.

THE English alphabet consists of twenty-six letters; <sup>I</sup> <sup>The general</sup> six of which are vowels, *a, e, i, o, u,* and *y*; and the principles other twenty consonants, *b, c, d, f, g, h, j, k, l, m, n,* <sup>Stenogra-</sup> *p, q, r, s, t, v, w, x,* and *z.* <sup>phy.</sup>

This alphabet, as is observed by the best grammarians that have written on the language, is both defective and redundant in expressing the various modifications of sound\*.

Custom or prejudice has assigned some letters a place, <sup>\* Lowth's</sup> when others would with much more propriety ex- <sup>Gram.</sup> press the same sound: and to this may be added, that <sup>Priestley's</sup> several letters, sometimes in one word, seem to be ad- <sup>Sheridan's</sup> mitted for no other reason than to perplex a young be- <sup>Lessons on</sup> ginner or a foreigner, as an obstruction to true pronun- <sup>Education.</sup> ciation, and to add to the apparent length of the word, when they are entirely quiescent and useless. That this is the genius of the orthography of our language must be perceived by the most superficial observer; but no modern tongue is absolutely free from the same exceptions. In particular, the French has a great number of dormant letters, which, it is obvious, render the pronunciation more difficult and perplexing to learners (G).

But as it is neither our business nor our intention to propose a mode of spelling different from that in common use, when applied to printing or long-hand writing (since several innovators in orthography have fallen into contempt, and their plans have been only preserved as beacons to warn others of the folly of endeavouring to subvert established principles §); we shall only observe, <sup>§ Preface</sup> that in stenography, where the most expeditious and <sup>of Benson's</sup> concise method is the best, if consistent with perspicuity, <sup>Dictionary</sup> the following simple rules are studiously to be regarded and practised.

RULE I. All quiescent consonants in words are to be

(D) Mr Byrom rejected vowels entirely in the middle of words, as others before him had only done partially. Without critically examining the executive part of his performance, which is very defective, it must be owned, that it is above the reach of human ingenuity to exceed his general plan; which for ever must be the basis of every future rational system.

(E) Those for *th* and *ch* may be either made upright or sloping to the right.

(F) These are not by any means prescribed; they may be employed or not according to the fancy of the learner.

(G) The Latin and Greek claim a just superiority over every modern tongue in this respect. In them no confusion or doubt can arise from the manner of spelling; and the reader can scarcely be wrong (unless in quantity) in sounding all the letters he sees.



2  
Rule for  
the conso-  
nants.

be dropped; and the orthography to be directed only by the pronunciation: which being known to all, will render this art attainable by those who cannot spell with precision in long hand.

RULE II. When the absence of consonants, not entirely dormant, can be easily known, they may often be omitted without the least obscurity.

RULE III. Two or sometimes more consonants may, to promote greater expedition, be exchanged for a single one of nearly similar sound; and no ambiguity as to the meaning ensue (H).

RULE IV. When two consonants of the same kind or same sound come together, without any vowel between them, only one is to be expressed; but if a vowel or vowels intervene, both are to be written: only observe, if they are perpendicular, horizontal, or oblique lines, they must only be drawn a size longer than usual; and characters with loops must have the size of their heads doubled ||.

Might is to be written *mit*, fight *fit*, machine *masbin*, enough *enuf*, laugh *laf*, prophet *profet*, physics *fifiks*, through *thro'*, foreign *foren*, sovereign *soveren*, psalm *salm*, receipt *refit*, write *rite*, wright *rit*, island *iland*, knavery *navery*, temptation *temptat on*, knife *nife*, stick *stik*, thigh *thi'*, honour *onour*, inditement *inditement*, acquaint *aquaint*, chaos *kaos*, &c.

Strength *strenth*, length *lenth*, friendship *frenship*, connect *conck*, commandment *comanment*, conjunct *conjunt*, humble *humle*, lumber *luner*, slumber *sluner*, number *numer*, exemplary *exemplary*, &c.

Rocks *rox*, acts *aks* or *ax*, facts *faks* or *fax*, districts *distriks* or *distrix*, affects *afeks* or *afex*, afflicts *afliks* or *aflix*, conquer *konkr*, &c.

Letter *leter*, little *lile*, command *comand*, error *eror*, terror *teror*, &c. But in *remember*, *moment*, *sister*, and such like words, where two consonants of the same name have an intervening vowel, both of them must be written.

These four rules, with their examples, being carefully considered by the learner, will leave him in no doubt concerning the disposition and management of the consonants in this scheme of short-writing; we shall therefore proceed to lay down rules for the application of the vowels with ease and expedition.

Vide  
Plate  
ccclxxxii.

3  
First rule  
exemplified.

4  
Second rule  
exemplified.

5  
Third rule  
exemplified.

6  
Fourth rule  
exemplified.

7  
Rule for  
the vowels

RULE I. Vowels, being only simple articulate sounds, though they are the connectives of consonants, and employed in every word and every syllable, are not necessary to be inserted in the middle of words; because the consonants, if fully pronounced, with the assistance of connection, will always discover the meaning of a word, and make the writing perfectly legible.

RULE II. If a vowel is not strongly accented in the incipient syllable of a word, or if it is mute in the final, it is likewise to be omitted; because the sound of the incipient vowel is often implied in that of the first consonant, which will consequently supply its place.

RULE III. But if the vowel constitutes the first or last syllable of a word, or is strongly accented at its beginning or end, that vowel is continually to be written.

RULE IV. If a word begins or ends with two or more vowels though separated, or when there is a collision of vowels, as in diphthongs and triphthongs; only one of them is to be expressed, which must be that which agrees best with the pronunciation.

RULE V. In monosyllables, if they begin or end with a vowel, it is always to be inserted, unless the vowel be *e* mute at the end of a word.

Such are the general principles of this art; in vindication and support of which it will be needless to offer any arguments, when it is considered that brevity and expedition are the chief objects, if consistent with legibility; and the subsequent specimens in the orthography recommended will, we hope, be sufficient to show that there is no real deficiency in the last mentioned particular.

He who md us mlt be etrnal, grt, nd mnpnt. It is specimen of the mode of spelling in stenography. A mn tht wd avd blm, lhd be frkmfok in al hs axns, nd ndvr wth al hs mt to pls evry bdy.—I wd nt frm any knxns wth a mn who hd no rgid fr hmself; nthr wd I blv a mn who hd ons tld me a li.—Oar is of al thngs the mlt dflkt to prfrv ntrnsld; nd whn ons mpchd, lk the chifty of a wmn, nvr thus wth its wntd lstr.—Wth gd mnra, kmpfns nd an esy plt adrs, mny mk a fig in the wrk, whs mant abls wd skisly hv rsd thm abv the rnk of a firm.—Idlms is the prnt of a thnsd ms'ntns, wch as nvr fit by the ndtrs: it is a pn nd a pnshunt of itself, nd brngs wnt nd bgry in its trn.—Vrtu is the first thng tht shd be rgrdd; it is a rwrđ of itself; mks a mn rfpktbl hr, nd wl mk hm etrnly hpy hrfr.—Prđ is a mlt prns psn, wch yt ws plntd by hvn in ur ntr, to rs ur emln to imtt grt nd wrthy kaktks or axns, to xt in us a sl fr wht is rt nd gft, nd a ldbl ndgnfn gnft oprfs nd wrks of any knd of nkty; in shrt, to mk us st a prpr vlu upn urslvs, nd dšps a wrthls flo, hu evr xltđ. Ths fr prđ is a vrtu, nd my gttly be kld a grns of fl. Bt prđ, lk othr prns, gnrlly fxs upn rng obgks, or is apld in rng prprfs. Hu kmn is it to se a rтч whm evry vs h3 rrdid msrbl, nd evry fly kntmtbl, vlnz hmself on hs hi brth, nd bšng ths ilstrs nšlstrs, of whm he nšrts nthng bt the nm or tđ! nšlstrs who if thy nu hm, wd dšn thr dpndnt wth kntmt. But al pid of ths fit is fly, nd evr to be avdd.

C H A P. III.

As the whole of this art depends upon a regular method and a simple alphabet, we have not only endeavoured to establish the former on satisfactory principles, but have been careful to appropriate, according to the comparative frequency of their occurrence, such characters for the letters as, after repeated trials and alterations, were conceived to be the best adapted for dispatch.

The stenographic alphabet consists of 18 distinct characters (viz. two for the vowels and the rest for the consonants), taken from lines and semicircular curves; the formation and application of which we shall now explain, beginning with the vowels.

For the three first vowels, *a*, *e*, and *i*, a comma is appropriated

5 G 2

(H) By this rule likewise *g* and *v* in the middle of words, but never in the beginning, may be exchanged for *k* and *f*, when they admit of an easier connection with the following character, or will make the writing appear neater.

propriated in different positions; and for the other three, *o*, *u*, and *y*, a point. The comma and point, when applied to *a* and *o*, is to be placed, as in Plate CCCCLXXXII. at the top of the next character; when for *e* and *u*, opposite to the middle; and when for *i* and *y*, at the bottom.

This arrangement of the vowels is the most simple and distinct that can easily be imagined. Places at the top, the middle, and the bottom of characters, which make three different positions, are as easily distinguished from one another as any three separate characters could be; and a comma is made with the same facility as a point.

<sup>10</sup>  
Lines.

Simple lines may be drawn four different ways; perpendicular, horizontal, and with an angle of about 45 degrees to the right and left. An ascending oblique line to the right, which will be perfectly distinct from the rest when joined to any other character, may likewise be admitted. These characters being the simplest in nature, are assigned to those five consonants which most frequently occur, viz. *l*, *r*, *t*, *c* hard or *k*, and *c* soft or *s*.

<sup>11</sup>  
Circles.

Every circle may be divided with a perpendicular and horizontal line, so as to form likewise four distinct characters. These being the next to lines in the simplicity of their formation, we have appropriated them for *b*, *d*, *n*, and *m*.

<sup>12</sup>  
Curves and  
Lines.

The characters expressing nine of the consonants are all perfectly distinct from one another; eight only remain which are needful, viz. *f*, *g* or *j*, *h*, *p*, *q*, *v*, *w*, and *x*. To find characters for which we must have recourse to mixed curves and lines. The characters which we have adopted are the simplest in nature after those already applied, admit of the easiest joining, and tend to preserve lineality and beauty in the writing.

It must be observed that we have no character for *c* when it has a hard sound, as in *castle*; or soft, as in *city*: for it naturally takes the sound of *k* or *s*, which in all cases will be sufficient to supply its place.

*R* likewise is represented by the same character as *l*; only with this difference, *r* is written with an ascending stroke (1), and *l* with a descending; which is always to be known from the manner of its union with the following character; but in a few monosyllables where *r* is the only consonant in the word, and consequently stands alone, it is to be made as is shown in the alphabet for distinction's sake.

*Z*, as it is a letter seldom employed in the English language, and only a coarser and harder expression of *s*, must be supplied by *s* whenever it occurs; as for *Zede-liab* write *Sedekiab*, &c.

#### C H A P. IV.

THE prepositions and terminations in this scheme are so simple, that the greatest benefit may be reaped from

them, and very little trouble required to attain them; as the incipient letter or the incipient consonant of all the prepositions and of several of the terminations is used to express the whole. But although in Plate CCCCLXXXII. sufficient specimens are given of the manner of their application, that the learner of less ingenuity or more slow perception may have every assistance, we have subjoined the following directions.

RULE I. The preposition is always to be written without joining, yet so near as plainly to show what word it belongs to; and the best way is to observe the same order as if the whole was to be connected.

RULE II. A preposition, though the same letters that constitute it may be met with in the middle or end of a word, is never to be used, because it would expose to obscurity.

RULE III. Observe that the preposition *omni* is expressed by the vowel *o* in its proper position; and for *anti*, *anta*, *ante*, by the vowel *a*, which the radical part of the word will easily distinguish from being only simple vowels.

The first rule for the prepositions is (allowing such exceptions as may be seen in the Plate) to be observed for the terminations; and also the second *mutatis mutandis*; except that whenever *sis*, *sus*, *fys*, *cious*, *tious*, and *ces* occur, they are to be expressed as directed in the fourth rule for the consonants, whether in the beginning, middle, or end of words (κ).

RULE IV. The terminative character for *tion*, *sion*, *cion*, *cian*, *tian*, is to be expressed by a small circle joined to the nearest letter, and turned to the right; and the plurals *tions*, *fions*, *cions*, *cians*, *tians*, *tiences*, by a dot on the same side.

RULE V. The terminative character for *ing*, is to be expressed likewise by a small circle, but drawn to the left hand; and its plural *ings* by a dot (L).

RULE VI. The plural sign *s* is to be added to the terminative characters when necessary.

RULE VII. The separated terminations are never to be used but in polysyllables or words of more syllables than one.

These rules duly observed will point out a method as concise and elegant as can be desired, for expressing the most frequent and longest prepositions and terminations in the English language. If it should be thought necessary to increase their number by the addition of others, it will be an easy matter for any one of the least discernment to do so, by proceeding on the principles before laid down.

#### C H A P. V.

THOUGH a more concise method of writing, or more numerous abbreviations, may not be indispensably necessary, if the foregoing directions be practised for a considerable time, yet contractions will be found extremely

(1) The character for *b*, when lineality requires it, may be made from the bottom and inverted (see Plate CCCCLXXXII.) And often *b* may be omitted entirely, or a vowel may be substituted in its stead, without any injury to legibility, it being rather a breathing than letter.

(κ) But in a few words where three horizontal characters meet, it will be better to express the *sis*, &c. by the semielliptical character in Plate CCCCLXXXII. opposite *tious*.

(L) In horizontal characters, by the left hand is meant the top, and by the right the space below the letter (see *ing* joined, Plate CCCCLXXXII.) In all other characters the right and left positions will naturally be known.

remely useful and convenient to those who have attained a proper knowledge of the subject, and lead to a greater degree of expedition, at the same time that they diminish the labour of writing. It has been observed in the introduction, that abbreviations are only to be employed by proficient in this art; because expedition is not the first, though the ultimate, object in view: and that an easy legibility is of the utmost consequence to the learner; which, however, cannot be preserved, if he adopts too soon those very rules which in time will afford him the greatest ease when applied with judgment.

The following short and practical rules will be found, we hope, fully adequate to every purpose for which they were intended, and are far superior in the facility of their application to any which we have seen.

RULE I. The usual abbreviations in long-hand are always to be followed; as Mr for Master, M. D. for Doctor of Physic, and Abp. for Archbishop, &c.

RULE II. Substantives, adjectives, verbs, and participles, when the sense will direct to the meaning, are to be expressed by their initial consonant with the distinguishing marks exhibited in Plate CCCCLXXXII. viz. a substantive must have the dot exactly over its initial consonant; an adjective must have a dot under it; a verb is to be expressed by a comma over its initial consonant; and a participle by a comma under (M). These being the four principal parts of speech will be sufficient; and an adept will never be at a loss to know when he can with safety apply this rule to them.

RULE III. To render the writing more legible, the last letter of the word may be joined to the first, and the proper mark applied.

RULE IV. The constituent or radical part of words, especially if they are long, will often serve for the whole, or sometimes the first syllable; as, we ought to moderate our *ex.* by our *circum.*; a man's *man.* commonly shape his *for.*

RULE V. All long words without exception may have their prepositions or terminations expressed by the incipient consonant of such preposition or termination.

RULE VI. When there is a great dependence between the parts of a sentence, the initial letter will often suffice: as *L.* is the capital of Great *B.*; the eldest *S.* of the king of Great *B.* is styled prince of *W.* Every one, it is presumed, will allow this to be perfectly legible in long-hand, then why may it not in stenography?

RULE VII. The terminations *ness* and *less* may be omitted; as *faithfulness* is only to be written *faithful*; *forwardness*, *forward*; *heedless*, *heed*; *stubbornness*, *stubborn*, &c.

RULE VIII. The second and third persons of verbs, ending in *eth* and *est*, may be expressed by *s*; as, he *loves*, thou *teaches*; instead of he *loveth*, thou *teachest*: or even without *s*; as, he *love*, &c.

RULE IX. Words may often be entirely omitted, and yet no ambiguity ensue; as, *In beginning God crea-*

*ted heaven and earth,* for *In the beginning God created the heaven and the earth.*

RULE X. When there is an immediate repetition of a sentence or word, a line is to be drawn under the sentence or word to be repeated: as, *Amen, Amen,* is to be written *Amen*; but if any words intervene before a word or sentence is to be repeated, the line must be drawn as before, and a  $\Delta$  or mark of omission placed where the repetition should begin; as, *Is it just the innocents should be condemned & reviled?*

#### The CONTENTS of the STENOGRAPHIC PLATES.

##### Fabritius's Reply to Pyrrhus.

As to my poverty, you have indeed, Sir, been rightly Plate informed. My whole estate consists in a house of but CCCCLXXXII\* mean appearance, and a little spot of ground, from which by my own labour I draw my support. But if by any means you have been persuaded to think, that this poverty makes me less considered in my country, or in any degree unhappy, you are extremely deceived. I have no reason to complain of fortune, she supplies me with all that nature requires; and if I am without superfluities, I am also free from the desire of them. With these I confess I should be more able to succour the necessitous, the only advantage for which the wealthy are to be envied; but as small as my possessions are, I can still contribute something to the support of the state and the assistance of my friends. With regard to honours, my country places me, poor as I am, upon a level with the richest: for Rome knows no qualifications for great employments but virtue and ability. She appoints me to officiate in the most august ceremonies of religion; she entrusts me with the command of her armies; she confides to my care the most important negotiations. My poverty does not lessen the weight and influence of my counsels in the senate; the Roman people honour me for that very poverty which you consider as a disgrace; they know the many opportunities I have had in war to enrich myself without incurring censure; they are convinced of my disinterested zeal for their prosperity; and if I have any thing to complain of in the return they make, it is only the excess of their applause. What value then can I set upon your gold and silver! What king can add any thing to my fortune! Always attentive to discharge the duties incumbent on me, I have a mind free from self-reproach, and I have an honest fame. *Doulety's Preceptor.*

##### Letter to a Friend against waste of Time.

Converse often with yourself, and neither lavish your time, nor suffer others to rob you of it. Many of our hours are stolen from us, and others pass insensibly away; but of both these losses the most shameful is that which happens through our own neglect. If we take the trouble to observe, we shall find that one considerable part of our life is spent in doing evil, and the other in doing

(M) The dot or comma being placed thus will never occasion them to be mistaken for vowels, because they should always be on one side or other; whereas the mark for parts of speech must constantly be placed exactly over or under.

doing nothing, or in doing what we should not do. We don't seem to know the value of time, nor how precious a day is; nor do we consider that every moment brings us nearer our end. Reflect upon this, I entreat you, and keep a strict account of time. Procrastination is the most dangerous thing in life. Nothing is properly ours but the instant we breathe in, and all the rest is nothing; it is the only good we possess; but then it is fleeting, and the first comer robs us of it. Men are so weak, that they think they oblige by giving of trifles, and yet reckon that time as nothing for which the most grateful person in the world can never make amends. Let us therefore consider time as the most valuable of all things; and every moment spent, without some improvement in virtue or some advancement in goodness, as the greatest subluxary loss.

*St Paul's Speech before Agrippa and Festus.*

I think myself happy, king Agrippa, that I shall answer for myself this day before thee, touching all things whereof I am accused of the Jews: especially because I know thee to be expert in all customs and questions which are among the Jews, wherefore I beseech thee to hear me patiently. My manner of life from my youth, which was at first among mine own nation at Jerusalem, know all the Jews, which knew me from the beginning (if they would testify), that, after the strictest sect of our religion I lived a Pharisee. And now I stand and am judged for the hope of the promise made by God unto our fathers: unto which promise our twelve tribes instantly serving God day and night hope to come; for which hope's sake, king Agrippa, I am accused of the Jews. Why should it be thought a thing incredible with you, that God should raise the dead, when God himself has given assurance of it unto all men, in that he hath raised Christ from the dead? As for my own part, most noble Festus, I own I once verily thought that even I myself ought to do many things contrary to the name of Jesus of Nazareth. Which thing I also did in Jerusalem. I punished the saints oft in every synagogue, and compelled them to blaspheme; and being exceedingly mad against them, I persecuted them even unto strange cities. In pursuit of which, as I went to Damascus, with authority and commission from the chief priests: At mid-day, O king, I saw in the way a light from heaven, above the brightness of the sun, shining about me, and them which journeyed with me. And when we were all fallen to the earth, I heard a voice speaking unto me, and saying in the Hebrew tongue, Saul, Saul, why persecutest thou me? It is hard for thee to kick against the pricks. And I said, Who art thou, Lord? And he said, I am Jesus whom thou persecutest. But rise, and stand upon thy feet: for I have appeared unto thee for this purpose, to make thee a minister and a witness both of these things which thou hast seen, and of those things in which I will appear unto thee. Whereupon, O king Agrippa, I was not disobedient to the heavenly vision: but shewed first unto them of Damascus, and at Jerusalem, and throughout all the coasts of Judea, and then to the Gentiles, that they should repent and turn to God. For these causes the Jews caught me in the temple, and went about to kill me. Having therefore obtained help of God, I continue unto this day, witnessing both to small and great, saying none other things

than those which the prophets and Moses did say should come: That Christ should suffer, and that he should be the first that should rise from the dead, and should show light unto the people, and to the Gentiles. This is the real truth: Believe me, I am no pestilent fellow, nor mover of sedition; but always endeavour all that lies in me to preserve a conscience void of offence towards God and towards man: nor can the Jews prove the things whereof they now accuse me. Neither am I, Festus, besides myself; but speak thus freely before the king, because he knows these things to be fact; yea, I am fully persuaded the king knows them all to be fact; for they were not done in a corner. King Agrippa, believest thou the prophets? I know that thou believest. And would to God that not only thou but also all that hear me this day, were altogether such as I am except these bonds. *Holmes's Rhetoric.*

*Pope to Atterbury.*

Once more I write to you as I promised, and this once I fear will be the last; the curtain will soon be drawn between my friend and me, and nothing left but to wish you a long good night; may you enjoy a state of repose in this life not unlike that sleep of the soul which some have believed is to succeed it, where we lie utterly forgetful of that world from which we are gone, and ripening for that to which we are to go. If you retain any memory of the past, let it only image to you what has pleased you best; sometimes present a dream of an absent friend, or bring you back an agreeable conversation. But, upon the whole, I hope you will think less of the time past than the future; as the former has been less kind to you than the latter infallibly will be. Do not envy the world your studies: They will tend to the benefit of men, against whom you can have no complaint; I mean, of all posterity: and, perhaps, at your time of life, nothing else is worth your care. What is every year of a wife man's life but a censure or critic on the past? Those whose date is the shortest, live long enough to laugh at one half of it: The boy despises the infant, the man the boy, the philosopher both, and the Christian all. You may now begin to think your manhood was too much a puerility; and you will never suffer your age to be but a second infancy. The toys and baubles of your childhood are hardly now more below you than those toys of our riper and our declining years; the drums and rattles of ambition, and the dirt and bubbles of avarice. At this time, when you are cut off from a little society, and made a citizen of the world at large, you should bend your talents not to serve a party, or a few, but all mankind. Your genius should mount above that mist, in which its participation and neighbourhood with earth hath long involved it: To shine abroad, and to heaven, ought to be the business and the glory of your present situation. Remember it was at such a time that the greatest lights of antiquity dazzled and blazed the most; in their retreat, in their exile, or in their death. But why do I talk of dazzling or blazing? it was then that they did good, that they gave light, and that they became guides to mankind. Those aims alone are worthy of spirits truly great, and such I therefore hope will be yours. Repentment indeed may remain, perhaps cannot be quite extinguished, in the noblest minds; but revenge will never harbour there; Higher principles than

than those of the first, and better principles than those of the latter, will infallibly influence men whose thoughts and whose hearts are enlarged, and cause them to prefer the whole to any part of mankind, especially to so small a part as one's single self. Believe me, my Lord, I look upon you as a spirit entered into another life, as one just upon the edge of immortality, where the passions and affections must be much more exalted, and where you ought to despise all little views and all mean retrospects. Nothing is worth your looking back;

and therefore look forward, and make (as you can) the world look after you; but take care it be not with pity, but with esteem and admiration. I am, with the greatest sincerity and passion for your fame as well as happiness, your, &c.

The above most charming and most affectionate letter was written about a month before Atterbury bishop of Rochester was sent into banishment, and is universally admired.

S T E

S T E

Stentoro-  
phonic  
||  
Stephens.

Stephens.

**STENTOROPHONIC TUBE**, a speaking trumpet; thus called from Stentor, a person mentioned by Homer. See **TRUMPET**.

ed with beautiful and correct editions of the Greek and Roman authors. Thus the world was not only supplied with an inexhaustible fund of amusement and instruction in these ancient writings; but it is to the ardour which they inspired, and to the model of elegance which they displayed, that the present advanced state of literature is in a great measure owing.

**STEP**, in a ship, a block of wood fixed on the decks or bottom of a ship, and having a hole in its upper side, fitted to receive the heel of a mast or capstern. The steps of the main and foremasts of every ship rest upon the keelson, to which they are firmly secured by knees, bolts, or spike-nails. The step of the mizen-mast usually rests upon the lower deck.

**HENRY STEPHENS**, the first of these illustrious men, was born in France, soon after the discovery of printing, perhaps about the year 1465. He settled as a printer at Paris, and was probably patronized by Louis XII. A great proportion of the books which he published were Latin: They are printed in the Roman letter, and are not inelegant, though some of them abound rather too much in contractions. He died about the year 1520, and left behind him three sons, Francis, Robert, and Charles. His widow married Simon de Colines (*Colinaeus* in Latin), who thus got possession of Henry's printing-house, and continued the profession till his death.

**STEPHANIMUM**, in botany: A genus of the *monogynia* order, belonging to the *pentandria* class of plants; and in the natural method ranking under the 47th order, *Stellata*. The calyx is monophyllous, turbinated, and quinquepartite; the corolla is monopetalous, funnel-shaped, having its tubes curved and ventricose: the pericarpium is a bilocular berry containing two seeds, flattened on one side and round on the other. This genus is nearly allied to that of *Ptychotria*. There is only one species, *viz. Guianense*, a native of the warmer parts of America.

**OF FRANCIS**, the eldest son, little more is known than that he carried on business along with his father-in-law Colinaeus, and that he died at Paris in 1550.

**STEPHANOPHORUS**, in antiquity, the chief priest of Pallas, who presided over the rest. It was usual for every god to have a chief priest; that of Pallas was the Stephanophorus just mentioned, and that of Hercules was called Dadouchus.—Stephanophorus was also a priest that assisted the women in the celebration of the festival Thesmophoria.

**ROBERT STEPHENS**, the second son, was born in 1503. In his youth he made great proficiency in the Roman, Greek, and Hebrew languages, and at the age of 19 had acquired so much knowledge, that his father-in-law entrusted him with the management of his press. An edition of the New Testament was published under his inspection, which gave great offence to the Paris divines, who accused him of heresy, and threatened to prevent the sale of the book. Soon after he began business himself, and married Perrete the daughter of Jodocus Badius, a printer and an author. She was a woman of learning, and understood Latin, which indeed was the necessary consequence of her situation. Her husband always entertained a number of learned men as correctors of the press: Being foreigners, and of different nations, they made use of no other language but Latin; which Perrete being accustomed to hear, was able in a short time not only to understand, but even to speak with tolerable ease.

**STEPHANUS** (Byzantinus), an able grammarian, who lived in the 5th or 6th century. He wrote a Dictionary, in which he made a great number of observations, borrowed from mythology and history, which showed the origin of cities and colonies, of which we have nothing remaining but a mean abridgment by Hermolaus the grammarian; but from that work the learned have received great light; and Sigonius, Casaubon, Scaliger, Salmasius, &c. have employed themselves in illustrating it.

**STEPHEN**, king of England. See **ENGLAND**, n<sup>o</sup> 108, &c.

**STEPHEN**, or *St Stephen's Day*, a festival of the Christian church, observed on the 26th of December, in memory of the first martyr St Stephen.

**STEPHENS**, a family of printers deservedly celebrated. They flourished at the revival of learning, and contributed a great deal towards dispelling the cloud of ignorance which had so long overshadowed Europe. Some of the classics before the 16th century were in a great measure lost, and all of them were exceedingly corrupted. By their abilities and indefatigable industry these defects were supplied, and the learned were furnished

In 1531 he published his Latin "Thesaurus;" a work of great importance, which he laboured at for two years. The mark which he put upon all his books was a tree branched, with a man looking upon it, and these words *noli altum sapere*, to which he sometimes added *sed time*. In 1539, Francis I. made him his printer, and ordered a new set of elegant types to be founded for him. His frequent editions of the New Testament gave great offence to the doctors of the Sorbonne, who

*Stephens.* accused him of heresy for his annotations, and insisted upon the suppression of some of his books. Although Henry the French king in some measure protected him, the persecution of these divines rendered him so unhappy, not to mention the expence and loss of time which an almost constant attendance at court unavoidably occasioned, that in 1552 he abandoned his country and went to Geneva. Here he embraced the Protestant religion, and thus justified in some measure the suspicions of his theological enemies. It has been affirmed by several writers that he carried along with him the royal types, and the moulds also in which they were cast; but it is certain that he never afterwards made use of those types. Besides, is it possible that the author of so daring a theft could have been not only protected in Geneva, but even counted and honoured by the most eminent men of the age? Is it credible that such a crime could have been concealed for 60 years; or that Henry, the son and heir of the perpetrator, would have enjoyed the favour of the French king, if Robert Stephens had acted such a shameful part? If he was burnt in effigy at Paris, it was not for theft, but for having changed his religion. After his arrival at Geneva, he published an account of the dispute between him and the Paris divines, which does as much honour to his abilities as his *Theſaurus* does to his learning. He died in 1559, after a life of the most extraordinary industry. The books of which he was the editor were not fewer than 360. Many of them were ancient classics in different languages. Several were accompanied with annotations which he collected, and all of them were corrected by collating manuscripts. He was so anxious to attain perfect accuracy, that he used to expose his proofs in public, and reward those who discovered a mistake. His books consequently were very correct. It is said that his New Testament, called *O Mirificam* (because the preface begins with these words), has not a single fault.

It was Robert Stephens who first divided the New Testament into verses during a journey between Paris and Lyons. The advantages of this improvement are fully counterbalanced by its defects. It has destroyed the unity of the books, and induced many commentators to consider every verse as a distinct and independent aphorism. To this in some measure is to be ascribed the many absurd interpretations and creeds that have been forced out of that book.

By his last will his estate was left exclusively to such of his children as should settle at Geneva. He left behind him three sons, Henry, Robert, and Francis.

CHARLES STEPHENS, the third son of Henry, was, like the rest of his family, familiarly acquainted with the learned languages. This recommended him to Lazarus de Baif, who made him tutor to his son, and in 1540 carried him along with him to Germany. He studied medicine, and practised it with success in France. He did not, however, forsake the profession of his family, but exercised it in Paris, where he became the editor of many books remarkable for neatness and elegance. He wrote above thirty treatises on different subjects, particularly on botany, anatomy, and history. He died in 1564.

ROBERT STEPHENS, the son of Robert the first of that name, did not accompany his father to Geneva, but continued to profess the Catholic religion, and to

reside at Paris. His letter was remarkably beautiful.—*Stephens.* He was made king's printer, and died about 1589.

His brother FRANCIS was also a printer. He embraced the Protestant religion, and resided at Geneva.

HENRY STEPHENS, the remaining son of Robert, was born at Paris in 1528. He became the most learned and most celebrated of all his family. From his very birth almost he gave proofs of uncommon abilities, and displayed an ardent passion for knowledge. The *Medea* of Euripides, which he saw acted while at school, first kindled his love for poetry, and inspired him with the desire of acquiring the language in which that tragedy is written. He intreated his father not to condemn him to study Latin, which he already understood from conversation, but to initiate him at once into the knowledge of Greek. His father willingly granted his request; and Henry applied with such vigour, that in a short time he could repeat the *Medea* by heart. He afterwards studied Greek under Peter Danæus, who was tutor to the Dauphin, and finally heard the lectures of Tusanus and Turnebus. He became eager at an early age to understand astrology, and accordingly attended a professor of that mysterious art; but he was not long in discovering its absurdity. At 19 he began his travels, which he undertook in order to examine foreign libraries, and to become acquainted with learned men. He spent two years in Italy, and returned into France completely master of Italian, and bringing along with him copies of several scarce authors, particularly a part of Anacreon, which before was thought lost.

He found his father publishing an edition of the New Testament, to which he prefixed some Greek verses.—Soon after, he visited England and the Netherlands, where he met with John Clement, an Englishman, to whom he was indebted for the remaining odes of Anacreon. During this journey he learned the Spanish language, which was very much spoken at that time in the Low Countries.

Whether Henry accompanied his father to Geneva or not is uncertain; at least he must have returned immediately to France, for we find him soon after established at Paris, and publishing the odes of Anacreon. In 1554 he went to Rome, and thence to Naples. This journey was undertaken at the request, and in the service, of the French government. He was discovered, and would have been arrested as a spy, had he not by his address and skill in the language of the country been able to pass himself for a native of Italy. On his return to France he assumed the title of printer to Ulric Fugger, a very rich and learned German nobleman, who allowed him a considerable pension.

In 1560 he married a relation, as is generally supposed, of Henry Scrimigeour, a Scotch nobleman, with whom he was intimately acquainted. She was a woman, as he himself informs us, endowed with the noblest spirit and the most amiable dispositions. Her death, which happened in 1566, brought on a disease that had twice attacked him before. It was a disgust at all those pursuits which had formerly charmed him, an aversion to reading and the sight of books. It was probably occasioned by too constant and severe an application to literary pursuits. In 1572 he published his *Theſaurus Linguae Græcæ*, one of the greatest works, perhaps, that ever was executed by one man, if we consi-







FABRICIUS' Reply to PYRRHUS.

Handwritten shorthand text for Fabricius' Reply to Pyrrhus, consisting of approximately 15 lines of dense characters.

LETTER &c. ... Handwritten shorthand text starting with 'LETTER &c.' and continuing with several lines of characters.

St PAUL'S SPEECH.

Handwritten shorthand text for St Paul's Speech, consisting of approximately 15 lines of dense characters.

POPE to ATTERBURY.

Handwritten shorthand text for Pope to Atterbury, consisting of approximately 15 lines of dense characters.

Handwritten shorthand text for Pope to Atterbury, continuing from the previous block, consisting of approximately 15 lines of dense characters.



Stephens.

der the wretched materials which more ancient dictionaries could furnish, if we consider the size and perfection of the work, and the immense labour and learning which must have been employed in the compilation. This work had been carried on at a greater expence than he could well bear. He expected to be reimbursed by the sale of the book, but he was unfortunately disappointed. John Scapula, one of his own servants, extracted from it whatever he thought would be most serviceable to students, and published it beforehand in 4to. By this act of treachery Henry was reduced to poverty.

See Scapula.

About this time he was much beloved by Henry III. of France, who treated him so kindly, and made him such flattering promises, that he resided frequently at Court. But these promises were never fulfilled, owing to the civil wars which soon after distracted France, and the unfortunate death of king Henry himself. During the remainder of his life his situation was very unsettled. We find him sometimes at Paris, sometimes in Geneva, in Germany, and even in Hungary. He died at Lyons in 1598, at the age of 70. He was fond of poetry from his very infancy. It was a custom of his to compose verses on horseback, and even to write them, though he generally rode a very mettlesome steed. His *Theaurus* was his great work, but he was also the author of several other treatises. His poems are numerous: His *Apology for Herodotus* is a witty satire on the Roman Catholics. His *Concordance to the New Testament* must have been a laborious work, and has deservedly endeared him to every Christian who wishes to acquire a rational and critical knowledge of the Scriptures. The number of books which he published, though fewer than his father, was great, and superior in elegance to any thing which the world had then seen. A great proportion of them were Greek; he was the editor, however, of many Roman and even of some eastern writings. His Greek classics are remarkably correct; the principal of them are Homer, Anacreon, Æschylus, Maximus Tyrius, Diodorus Siculus, Pindar, Xenophon, Thucydides, Herodotus, Sophocles, Diogenes Laertius, Plutarch, Plato, Apollonius Rhodius, Æschines, Lycias, Callimachus, Theocritus, Herodian, Dionysius Hallicarnassensis, Dion Cassius, Iocrates, Appian, Xiphilin, &c. His temper in the latter part of his life is represented as haughty and severe, owing probably to his disappointments. He left behind him a son and two daughters, one of whom was married to the learned Isaac Casaubon,

PAUL STEPHENS, the son of Henry, continued his father's profession at Geneva. He was a man of learning, and wrote translations of several books, and published a considerable number of the ancient classics; but his editions possess little of his father's elegance. He died in 1627, at the age of 60, after selling his types to one Chouet a printer.—His son ANTHONY, the last printer of the family, abandoned the Protestant religion, and returned to France, the country of his ancestors. He received letters of naturalization in 1612, and was made printer to the king; but managing his affairs ill, he was reduced to poverty, and obliged to retire into an hospital, where he died in 1674, miserable and blind, at the age of 80.

STEPHENS'S *Medicine for the Stone*. See ALKALI,

no 17.

Vol. XVII. Part II.

STERCORARIANS, or STERCORANISTÆ, formed from *stercus* "dung," a name which those of the Romish church anciently gave to such as held that the host was liable to digestion, and all its consequences, like other food.

Stercorarians  
||  
Sterling.

STERCULIA, in botany: A genus of plants belonging to the class of *monocia*, and order of *monodelphia*; and in the natural system under the 38th order, *tricolceæ*. The male calyx is quinquepartite; there is no corolla, but there are 15 filaments. The female calyx is quinquepartite; there is no corolla; the germen is placed on a pillar, and the capsule is quinquelocular, and many-seeded. There are three species, the *balanghas*, *scetida*, and *platanifolium*, all foreign plants.

STEREOGRAPHIC PROJECTION, is the projection of the circles of the sphere on the plane of some one great circle, the eye being placed in the pole of that circle. See *PROJECTION of the Sphere*.

STEREOMETRY, ΣΤΕΡΕΩΜΕΤΡΙΑ, formed of *στερεος* *solid*, and *μετρον* *measure*, that part of geometry which teaches how to measure solid bodies, i. e. to find the solidity or solid contents of bodies; as globes, cylinders, cubes, vessels, ships, &c.

STEREOTOMY, formed from *σειρος*, and *τομη*, *section*, the act or act of cutting solids, or making sections thereof; as walls and other membranes in the profiles of architecture.

STERILIFY, barrenness, in opposition to fertility. It has been asserted by many authors, that all monsters produced by a mixture of different species of animals, such as mules, are barren; but this does not hold universally, even with the mule, which is the instance most generally adduced. See MULE.

Sterility in women sometimes happens from a miscarriage, or violent labour injuring some of the genital parts; but one of the most frequent causes is the suppression of the menstrual flux.—There are other causes arising from various diseases incident to those parts; by which the uterus may be unfit to receive or retain the male seed;—from the tubæ fallopianæ being too short, or having lost their erectile power; in either of which cases no conception can take place:—from universal debility and relaxation; or a local debility of the genital system; by which means, the parts having lost their tone or contractile power, the semen is thrown off immediately *post coitum*;—from imperforation of the vagina, the uterus, or the tubæ, or from diseased ovas, &c. Hence medical treatment can only avail in cases arising from topical or universal debility; in correcting irregularities of the menstrual flux, or in removing tumors, cicatrices, or constrictions of the passage, by the art of surgery.

STERIS, in botany: A genus of plants belonging to the class of *pentandria*, and order of *dignia*. The calyx is quinquepartite; the corolla wheel-shaped; the berry is unilocular, and many-seeded. There is only one species, the *javana*, a foreign plant.

STERLING, an epithet by which genuine English money is distinguished. It is unnecessary to mention the various conjectures of antiquaries about the origin and meaning of this appellation. The most probable opinion seems to be this, that some artists from Germany, who were called *Esterlings*, from the situation of their country, had been employed in fabricating our money,

Henry's  
History of  
Great Britain,  
vol. iii. p. 541.

Stern,  
Sterna.

money, which consisted chiefly of silver pennies; and that from them the penny was called an *esterling*, and our money *esterling* or *sterling* money.

**STERN**, the posterior face of a ship; or that part which is represented to the view of a spectator, placed on the continuation of the keel behind. The stern is terminated above by the taffarel, and below by the counters; it is limited on the sides by the quarter-pieces, and the intermediate space comprehends the galleries and windows of the different cabins. See *QUARTER of a Ship*, *SHIP*, and *SHIP-BUILDING*.

**STERN-Post**, a rope used to confine the stern of a ship or boat to any wharf or jetty-head, &c.

**STERN-Mast**, in sea language, usually denotes that part of a fleet of ships which is in the rear, or farnett a-stern, as opposed to head-moat.

**STERN-Post**, a long straight piece of timber erected on the extremity of the keel, to sustain the rudder and terminate the ship behind.

This piece, which is expressed by B in the pieces of the hull, Plate CCCCLIV. fig. 1. ought to be well secured and supported; because the ends of all the lower planks of the ship's bottom are fixed in a channel, cut on its surface; and the whole weight of the rudder is sustained by it.

**STERN-Sheets**, that part of a boat which is contained between the stern and the utmost or hindmost seat of the rowers. It is generally furnished with benches to accommodate the passengers. See *BOAT*.

**STERNA**, the **TERN**; a genus of birds arranged under the order of *palmipedes*. The marks of this genus are a straight, slender, pointed bill, linear nostrils, a slender and sharp tongue, very long wings, a small back toe, and a forked tail. There are 25 species, according to Dr Latham; the *caesia*, *cayana*, *surinamensis*, *fuliginosa*, *africana*, *stolidia*, *philippina*, *simplex*, *nilotica*, *boylii*, *striata*, *vittata*, *spadicea*, *pileata*, *hirundo*, *panaya*, *cinerea*, *alba*, *minuta*, *sinensis*, *australis*, *metopolencos*, *fissipes*, *nigra*, and *obscura*. Three of these only are found in Great Britain; the *hirundo*, *minuta*, and *fissipes*.

1. The *hirundo*, common tern, or great sea-swallow, weighs four ounces one-quarter; the length is 14 inches; the breadth 30; the bill and feet are of a fine crimson; the former tipped with black, straight, slender, and sharp-pointed; the crown, and hind part of the head, black; the throat, and whole under side of the body, white; the upper part, and the coverts of the wings, a fine pale grey. The tail consists of 12 feathers; the exterior edges of the three outmost are grey, the rest white; the exterior on each side is two inches longer than the others: in flying, the bird frequently closes them together, so as to make them appear one slender feather.

This is a very common species; frequents our sea-coasts and banks of lakes and rivers during the summer, but most common in the neighbourhood of the sea. It is found also in various parts of Europe and Asia, according to the season; in the summer as far as Greenland and Spitzbergen, migrating in turn to the south of Austria and Greece. It lays three or four eggs about the month of June, of a dull olive colour, an inch and three quarters in length, marked with irregular black spots, intermixed with some others of a smaller size, and less bright; the little end is almost free from any mark-

Sterna,  
sterne.

ings. These are laid among the grass or moss. The young are hatched in July, and quit the nest very soon after. They are carefully fed by their parents, and fly in about six weeks. This bird appears to have all the actions on the water which the swallow has on land, skimming on the surface, and seizing on every insect which comes in its way; besides which, the moment it spies a fish in the water, it darts into that element, and seizing its prey arises as quickly to the place from which it dipped.

These birds are also found in America; come into New England in May, and go away in autumn, and are called there the mackarel gull. At Hudson's Bay they are known by the name of black-head. They are observed to lay their eggs in small hollows on the shore, sometimes lined with a few leaves. They are often found in great numbers on the islets in the middle of the rivers, and are thought good eating. The natives of Hudson's Bay call them *Kenouch ene ou keash*. They are bold, not fearing mankind, and in the time of incubation will attack any one, frequently darting down so as to touch a person's hat, without his giving the least offence.

2. The *minuta*, or smaller sea-swallow, (called by Linnaeus *larus minuta*), weighs only two ounces five grains; the length 8 inches and a half; the breadth 19 and a half. The bill is yellow, tipped with black; the forehead and cheeks white; from the eyes to the bill is a black line; the top of the head and hind part black; the breast and under side of the body clothed with feathers so closely set together, and of such an exquisite rich gloss and so fine a white, that no satin can be compared to it: the back and wings of a pale grey: the tail short, less forked than that of the former, and white; the legs yellow: the irides dusky.—These two species are very delicate, and seem unable to bear the inclemency of the weather on our shores during winter, for we observe that they quit their breeding places at the approach of it, and do not return till spring. The manners, haunts, and food of this species are the same with those of the former; but they are far less numerous.

3. The *fissipes*, or black tern, is of a middle size between the first and second species. The usual length is 10 inches; the breadth 24; the weight two ounces and a half. The head, neck, breast, and belly, as far as the vent, are black; beyond is white; the male has a white spot under its chin; the back and wings are of a deep ash colour: the tail is short and forked; the exterior feather on each side is white; the others ash-coloured: the legs and feet of a dusky red. Mr Ray calls this a *cloven-footed gull*, as the webs are depressed in the middle, and form a crescent. These birds frequent fresh waters, breed on their banks, and lay three small eggs of a deep olive colour, much spotted with black. They are found during spring and summer in vast numbers in the Fens of Lincolnshire, make an incessant noise, and feed on flies as well as water insects and small fish. Birds of this species are seen very remote from land. Kalm saw flocks of hundreds in the Atlantic Ocean, midway between England and America, and a later voyager saw one 240 leagues from the Lizard, in the same ocean.

**STERNE** (Laurence), an English writer of a very peculiar cast, was born at Clomwell, in the south of Ireland, on 24th November 1713. His father Roger Sterne was the grandson of Sterne archbishop of York, who has been supposed, we know not upon what grounds,

Sterne  
||  
Sternom-  
y. d. u. s.

to have been the author of the excellent book intitled "The Whole Duty of Man." Laurence inherited nothing of his ancestor's manner of writing, but rather resembled Rabelais, whose wit he carried with him even into the pulpit.

In 1722 he was sent to school at Halifax in Yorkshire, where he continued till 1732, when he was removed to Jesus College in Cambridge. How long he resided in college, or what progress he made in literature or science, is not known: his works display rather native genius than profound erudition. Upon quitting the university he went to York, and being in orders was presented to the living of Sutton by the interest of his uncle Dr Sterne, a prebendary of that church. In 1741 he married, and was soon afterwards made a prebendary of York, by the interest also of his uncle, who was then upon very good terms with him; but "quickly quarrelled with him (he says), and became his bitterest enemy, because he would not be a party man, and write paragraphs in the newspapers." By his wife's means he got the living of Stillington, but remained near 20 years at Sutton, doing duty at both places. He was then in very good health, which, however, soon after forsook him; and books, painting, fiddling, and shooting, were, as he tells us, his amusements.

In 1760, he went to London to publish his two first volumes of "Tristram Shandy;" and was that year presented to the curacy of Coxwold. In 1762 he went to France, and two years after to Italy, for the recovery of his health; but his health never was recovered. He languished under a consumption of the lungs, without the slightest depression of spirits, till 1768, when death put a period to his terrestrial existence.

The works of Sterne are very generally read. They consist of, 1. The Life and Opinions of Tristram Shandy; 2. Sermons; 3. A Sentimental Journey; 4. Letters, published since his death. In every serious page, and in many of much levity, the author writes in praise of benevolence, and declares that no one who knew him could suppose him one of those wretches who heap misfortune upon misfortune: But we have heard anecdotes of him extremely well authenticated, which proved that it was easier for him to praise this virtue than to practise it. His wit is universally allowed; but many readers have persuaded themselves that they found wit in his blank pages, while it is probable that he intended nothing but to amuse himself with the idea of the sage conjectures to which these pages would give occasion. Even his originality is not such as is generally supposed by those fond admirers of the Shandean manner, who have presumed to compare him with Swift, Arbuthnot, and Butler. He has borrowed both matter and manner from various authors, as every reader may be convinced by the learned, elegant, and candid comments on his works published by Dr Farrier, in the fourth volume of the Memoirs of the Literary and Philosophical Society of Manchester.

STERNOCOSTALES, commonly called the *musculi triangulares sterni*, in anatomy, are five pairs of fleshy planes, disposed more or less obliquely on each side the sternum, on the insides of the cartilages of the second, third, fourth, fifth, and sixth true ribs.

STERNOMASTOIDEUS, in anatomy. See *Table of the Muscles*, under the article ANATOMY.

STERNOMANTIS, in antiquity, a designation given to the Delphian priestesses, more usually called PYTHIA.—Sternomantis is also used for any one that had a prophesying demon within him.

STERNOMASTOIDÆUS, a muscle. See *Table of the Muscles*, under ANATOMY.

STERNOTHYRCIDEUS, a muscle. See *Table of the Muscles*, under ANATOMY.

STERNUM. See ANATOMY, n<sup>o</sup> 37.

STERNUTATIVE, or STERNUTATORY, a medicine proper to produce sneezing. See SNEEZING.

STETTIN, or STETTIN, a seaport town of Germany, in the circle of Upper Saxony, and capital of Hither Pomerania, with the title of a duchy, and a castle. It had long a famous school, which the wars of Germany never disturbed. The ancient dukes of Pomerania resided here; and it was taken by the elector of Brandenburg in 1676, but given to Sweden by the treaty of Nimeguen. In 1713 it submitted to the allies; and then the said elector was put in possession again of this important place, which is a bulwark to the Marche of Brandenburg; and the fortifications have been greatly improved. It is now a flourishing place, and carries on a considerable trade. It is seated on the river Oder, 72 miles north of Francfort, and 70 north by east of Berlin. E. Long. 14. 38. N. Lat. 53. 35. The duchy is 125 miles in length, and borders upon Mecklenburg, and partly upon Brandenburg. The breadth is from 17 to 25 miles, and it is divided by the river Oder into two parts.

STEW, a small kind of fish-pond, the peculiar use of which is to maintain fish, and keep them in readiness for the daily use of the family, &c.

STEWs (from the French *gluves*, i. e. *thermæ*, *balneum*), those places which were permitted in England to women of professed incontinency, and that for hire would prostitute their bodies to all comers; so called, because dissolute persons are wont to prepare themselves for venereous acts by bathing; and hot baths were by Homer reckoned among the effeminate sort of pleasures. These stews were suppressed by King Hen. VIII. about the year 1546.

STEWARD (*senescallus*, compounded of the Saxon *steda*, i. e. "room;" or *stead* and *weard*, "a ward" or "keeper"), an officer appointed in another's stead or place, and always taken for a principal officer within his jurisdiction. Of these there are various kinds. The greatest officer under the crown is the lord high-steward of England, an office that was anciently the inheritance of the earls of Leicester, till forfeited by Simon de Mountfort to King Henry III. But the power of this officer is so very great, that it has not been judged safe to trust it any longer in the hands of a subject, excepting only *pro hac vice*, occasionally: as to officiate at a coronation, at the arraignment of a nobleman for high-treason, or the like. During his office, the steward bears a white staff in his hand; and the trial, &c. ended, he breaks the staff, and with it his commission expires. There is likewise a lord-steward of the king's household, who is the chief officer of the king's court, has the care of the king's house, and authority over all the officers and servants of the household, except such as belong to the chapel, chamber, and stable.

STEWARD, an officer in a ship of war, appointed by the purser to distribute the different species of provisions

Steward. fions to the officers and crew; for which purpose he is furnished with a mate and proper assistants.

*Court of the Lord High STEWARD of Great Britain*, is a court instituted for the trial of peers indicted for treason or felony, or for misprision of either. The office of this great magistrate is very ancient, and was formerly hereditary, or at least held for life, or *dum bene se gesserit*: but now it is usually, and hath been for many centuries past, granted *pro hac vice* only; and it hath been the constant practice (and therefore seems now to have become necessary) to grant it to a lord of parliament, else he is incapable to try such delinquent peer. When such an indictment is therefore found by a grand jury of freeholders in the King's bench, or at the assizes before the justices of *oyer and terminer*, it is to be removed by a writ of *certiorari* into the court of the lord high-steward, which has the only power to determine it. A peer may plead a pardon before the court of King's-bench, and the judges have power to allow it, in order to prevent the trouble of appointing an high-steward merely for the purpose of receiving such plea: but he may not plead in that inferior court any other plea, as guilty or not guilty of the indictment, but only in this court; because, in consequence of such plea, it is possible that judgment of death might be awarded against him. The king, therefore, in case a peer be indicted of treason, felony, or misprision, creates a lord high-steward *pro hac vice* by commission under the great seal; which recites the indictment so found, and gives his Grace power to receive and try it *secundum legem et consuetudinem Angliæ*. Then when the indictment is regularly removed by writ of *certiorari*, commanding the inferior court to certify it up to him, the lord high-steward directs a precept to a serjeant at arms, to summon the lords to attend and try the indicted peer. This precept was formerly issued to summon only 18 or 20 selected from the body of the peers; then the number came to be indefinite; and the custom was for the lord-high-steward to summon as many as he thought proper (but of late years not less than 23); and that those lords only should sit upon the trial; which threw a monstrous weight of power into the hands of the crown, and this its great officer, of selecting only such peers as the then predominant party should most approve of. And accordingly, when the earl of Clarendon fell into disgrace with Charles II. there was a design formed to prorogue the parliament, in order to try him by a select number of peers; it being doubted whether the whole house could be induced to fall in with the views of the court. But now, by statute 7 W. III. c. 3. upon all trials of peers for treason or misprision, all the peers who have a right to sit and vote in parliament shall be summoned at least 20 days before such trial, to appear and vote therein; and every lord appearing shall vote in the trial of such peer, first taking the oaths of allegiance and supremacy, and subscribing the declaration against popery.

During the session of parliament, the trial of an indicted peer is not properly in the court of the lord high-steward, but before the court last mentioned of our lord the king in parliament. It is true, a lord high-steward is always appointed in that case to regulate and add weight to the proceedings: but he is rather in the nature of a speaker *pro tempore*, or chairman of the court, than the judge of it; for the collective body of the peers

are therein the judges both of law and fact, and the high-steward has a vote with the rest in right of his peerage. But in the court of the lord high-steward, which is held in the recess of parliament, he is the sole judge of matters of law, as the lords triors are in matters of fact; and as they may not interfere with him in regulating the proceedings of the court, so he has no right to intermix with them in giving any vote upon the trial. Therefore, upon the conviction and attainder of a peer for murder in full parliament, it hath been holden by the judges, that in case the day appointed in the judgment for execution should lapse before execution done, a new time of execution may be appointed by either the high court of parliament during its sitting, though no high-steward be existing, or, in the recess of parliament, by the court of King's bench, the record being removed into that court.

It has been a point of some controversy, whether the bishops have now a right to sit in the court of the lord-high-steward to try indictments of treason and misprision. Some incline to imagine them included under the general words of the statute of King William "all peers who have a right to sit and vote in parliament;" but the expression had been much clearer, if it had been "all lords," and not "all peers;" for though bishops, on account of the baronies annexed to their bishoprics, are clearly lords of parliament, yet their blood not being ennobled, they are not universally allowed to be peers with the temporal nobility: and perhaps this word might be inserted purposely with a view to exclude them. However, there is no instance of their sitting on trials for capital offences, even upon impeachments or indictments in full parliament, much less in the court we are now treating of; for indeed they usually withdraw voluntarily, but enter a protest, declaring their right to stay. It is observable, that in the 11th chapter of the constitutions of Clarendon, made in parliament 11th Hen. II. they are expressly excused, rather than excluded, from sitting and voting in trials, when they come to concern life or limb: *episcopi, sicut cæteri barones, debent interesse judiciis cum baronibus, quousque perveniat ad diminutionem membrorum vel ad mortem*. And Becket's quarrel with the king hereupon was not on account of the exception (which was agreeable to the canon law), but of the general rule, that compelled the bishops to attend at all. And the determination of the house of lords in the earl of Danby's case, which hath ever since been adhered to, is consonant to these constitutions; "that the lords spiritual have a right to stay and sit in court in capital cases, till the court proceeds to the vote of guilty or not guilty." It must be noted, that this resolution extends only to trials in full parliament; for to the court of the lord high-steward (in which no vote can be given, but merely that of guilty or not guilty), no bishop, as such, ever was or could be summoned: and though the statute of King William regulates the proceedings in that court, as well as in the court of parliament, yet it never intended to new-model or alter its constitution; and consequently does not give the lords spiritual any right, in cases of blood, which they had not before. And what makes their exclusion more reasonable is, that they have no right to be tried themselves in the court of the lord high-steward, and therefore surely ought not to be judges there. For the privilege of being thus tried

Steward,  
Stewart.

depends upon nobility of blood rather than a feat in the house, as appears from the trials of popish lords, of lords under age, and (since the union) of the Scotch nobility, though not in the number of the sixteen; and from the trials of females, such as the queen consort or dowager, and of all peeresses by birth; and peeresses by marriage also, unless they have, when dowagers, disparaged themselves by taking a commoner to their second husband.

*STEWART of the Chiltern Hundreds.* See *CHILTERN Hundreds*.

*STEWART* (Dr Matthew), was in 1717 born at Rothsay in the isle of Bute, of which parish his father was the minister. Being intended for the church, he went through the usual course of a grammar-school education, and was in 1734 received as a student into the university of Glasgow. There he had the happiness of having for his preceptors in moral science and in mathematics the celebrated professors Hutcheson and Simson; by the latter of whom he was instructed in what may not improperly be called the *arcana* of the ancient geometry.

Mr Stewart's views making it necessary for him to remove to Edinburgh, he was introduced by Dr Simson to Mr Maclaurin, that his mathematical studies might suffer no interruption; and he attended the lectures of that great master with such advantage as might be expected from eminent abilities, directed by the judgment of him who made the philosophy and geometry of Newton intelligible to ordinary capacities. Mr Stewart, however, had acquired, from his intimacy with Dr Simson, such a predilection for the ancient geometry, as the modern analysis, however powerfully recommended, could not lessen; and he kept up a regular correspondence with his old master, giving him an account of his progress and his discoveries in geometry, and receiving in return many curious communications respecting the *Loci Plani* and the porisms of Euclid. See *PORISM* and *SIMSON*.

While the second invention of porisms, to which more genius was perhaps required than to the first discovery of them, employed Dr Simson, Mr Stewart pursued the same subject in a different and new direction. In doing so, he was led to the discovery of those curious and interesting propositions which were published under the title of *General Theorems* in 1746. They were given without the demonstrations; but did not fail to place their discoverer at once among the geometers of the first rank. They are for the most part porisms, though Mr Stewart, careful not to anticipate the discoveries of his friend, gave them no other name than that of theorems.

Our author had before this period entered into the church; and obtained, through the patronage of the duke of Argyll and the earl of Bute, the living of Roseneath, a retired country parish in the west of Scotland: but in 1747 he was elected to the mathematical chair in the university of Edinburgh, which had become vacant the year before by the death of Mr Maclaurin. The duties of this office gave a turn somewhat different to his pursuits, and led him to think of the most simple and elegant means of explaining those difficult propositions which were hitherto only accessible to men deeply versed in the modern analysis. In doing this, he was pursuing the object which of all others he most ardent-

Stewart.

ly wished to attain, *viz.* the application of geometry to such problems as the algebraic calculus alone had been thought able to resolve. His solution of Kepler's problem was the first specimen of this kind which he gave to the world; and it was impossible to have produced one more to the credit of the method he followed, or of the abilities with which he applied it. On this problem the utmost resources of the integral calculus had been employed. But though many excellent solutions had been given, there was none of them at once direct in its method and simple in its principles. Dr Stewart was so happy as to attain both these objects; and his solution appeared in the second volume of the *Essays* of the Philosophical Society of Edinburgh for the year 1736. In the first volume of the same collection there are some other propositions of Mr Stewart's, which are an extension of a curious theorem in the fourth book of Pappus. They have a relation to the subject of porisms, and one of them forms the 91st of Dr Simson's *Restoration*. They are besides very beautiful propositions, and are demonstrated with all the elegance and simplicity of the ancient analysis.

The prosecution of the plan which he had formed of introducing into the higher parts of mixed mathematics the strict and simple form of ancient demonstration, produced the *Treatises Physical and Mathematical*, which were published in 1761, and the *Essay on the Sun's Distance*, which was published in 1763. In this last work it is acknowledged that he employed geometry on a task which geometry cannot perform; but while it is granted that his determination of the sun's distance is by no means free from error, it may safely be asserted that it contains a great deal which will always interest geometers, and will always be admired by them. Few errors in science are redeemed by the display of so much ingenuity, and what is more singular, of so much sound reasoning. The investigation is everywhere elegant, and will probably be long regarded as a specimen of the most arduous inquiry which has been attempted by mere geometry.

The *Sun's Distance* was the last work which Dr Stewart published; and though he lived to see several animadversions on it made public, he declined entering into any controversy. His disposition was far from polemical; and he knew the value of that quiet which a literary man should rarely suffer his antagonists to interrupt. He used to say, that the decision of the point in question was now before the public; that if his investigation was right it would never be overturned, and that if it was wrong it ought not to be defended. A few months before he published the essay just mentioned, he gave to the world another work, intitled *Propositiones Geometricae Alore Veterum Demonstratae*. This title, it is said, was given to it by Dr Simson, who rejoiced in the publication of a work so well calculated to promote the study of the ancient geometry. It consists of a series of geometrical theorems for the most part new; investigated first by an analysis, and afterwards synthetically demonstrated by the inversion of the same analysis.

Dr Stewart's constant use of the geometrical analysis had put him in possession of many valuable propositions which did not enter into the plan of any of the works that have been enumerated. Of these not a few have

Account of  
Dr Stewart  
in the Edinburgh  
Philosophical  
Transactions, vol. i.  
by Mr  
P. Stewart.

Stewart  
||  
Sti c k e-  
back.

have found a place in the writings of Dr Simson, where they will for ever remain to mark the friendship of these two mathematicians, and to evince the esteem which Dr Simson entertained for the abilities of his pupil.

Soon after the publication of the *Sun's Distance*, Dr Stewart's health began to decline, and the duties of his office became burdensome to him. In the year 1772 he retired to the country, where he afterwards spent the greater part of his life, and never resumed his labours in the university. But though mathematics had now ceased to be his business, they continued to be his amusement till a very few years before his death, which happened on the 23d of January 1785, at the age of 68.

The habits of study, in a man of original genius, are objects of curiosity, and deserve to be remembered. Concerning those of Dr Stewart, his writings have made it unnecessary to remark, that from his youth he had been accustomed to the most intense and continued application. In consequence of this application, added to the natural vigour of his mind, he retained the memory of his discoveries in a manner that will hardly be believed. He rarely wrote down any of his investigations till it became necessary to do so for the purpose of publication. When he discovered any proposition, he would put down the enunciation with great accuracy, and on the same piece of paper would construct very neatly the figure to which it referred. To these he trusted for recalling to his mind at any future period the demonstration or the analysis, however complicated it might be. Experience had taught him, that he might place this confidence in himself without any danger of disappointment; and for this singular power he was probably more indebted to the activity of his invention than the mere tenaciousness of his memory. Tho' he was extremely studious, he read few books, and verified the observation of M. D'Alembert, that of all the men of letters, mathematicians read least of the writings of one another. His own investigations occupied him sufficiently; and indeed the world would have had reason to regret the misapplication of his talents, had he employed in the mere acquisition of knowledge that time which he could dedicate to works of invention.

STEWART, in Scots law. See LAW, N° clviii. 5.

STEWARTIA, in botany: A genus of plants belonging to the class of *monodelphia*, and order of *polyandria*; and in the natural system ranging under the 37th order, *Columnifera*. The calyx is simple; the style is simple, with a quinquefid stigma; the apple is without juice, quinquelobed, monospermous, bursting open with a spring five ways. There is only one species, the *malacodendron*, which is a foreign plant.

STIBADIUM, among the Romans, a low kind of table couch or bed of a circular form, which succeeded to the triclinia, and was of different sizes, according to the number of guests they were designed for. They were called *hexaclina*, *oñaclina*, or *enneaclina*, according as they held six, eight, or nine guests, and so of any other number.

STIBIUM, a name for ANTIMONY.

STICHOS, a name given by the old writers to a pectoral confection, the principal ingredient of which was the herb *marrubium* or horehound.

STICKLEBACK, in ichthyology. See GASTEROLOSTEUS.

FOOT-STICKS, in printing, slips of wood that lie between the foot of the page and the chase, to which they are wedged fast by the quoins, to keep the form firm, in conjunction with the side-sticks, which are placed at the side of the page, and fixed in the same manner by means of quoins.

Foot-sticks  
||  
S-t-i.

STIFFLE, or GREAT MUSCLE, in the manege, is the part of the hind leg of a horse which advances towards his belly. This is a most dangerous part to receive a blow upon.

STIGMA, a brand or impression with a hot iron; a mark of infamy. See STIGMATIZING.

STIGMA, in botany, the summit or top of the style, accounted by the sexualists the female organ of generation in plants, which receives the fecundating dust of the tops of the stamina, and transmits its vapour or effluvia through the style into the heart of the seed-bud, for the purpose of impregnating the seeds.

STIGMATA, in natural history, the apertures in different parts of the bodies of insects communicating with the tracheæ or air-vessels, and serving for the office of respiration.

STIGMATA, in antiquity, certain marks impressed on the left shoulders of the soldiers when listed.

STIGMATA, were also a kind of notes or abbreviations, consisting only of points, disposed various ways; as in triangles, squares, crosses, &c.

STIGMATA, is also a term introduced by the Franciscans, to express the marks or prints of our Saviour's wounds, said to have been miraculously impressed by him on the body of their seraphic father St Francis.

STIGMATIZING, among the ancients, was inflicted upon slaves as a punishment, but more frequently as a mark to know them by: in which case, it was done by applying a red-hot iron marked with certain letters to their fore-heads, till a fair impression was made; and then pouring ink into their furrows, that the inscription might be the more conspicuous.

Soldiers were branded in the hand with the name or character of their general.

After the same manner, it was customary to stigmatize the worshippers and votaries of some of the gods. The marks used on these occasions were various; sometimes they contained the name of the god, sometimes his particular ensign, as the thunderbolt of Jupiter, the trident of Neptune, the ivy of Bacchus, &c. or they marked themselves with some mystical number, whereby the god's name was described. To these three ways of stigmatizing St John is supposed to refer (Rev. chap. xiii. ver. 16, 17.). Theodoret is of opinion, that the Jews were forbidden to brand themselves with stigmata, because the idolaters, by that ceremony, used to consecrate themselves to their false gods.

Among some nations, stigmatizing was considered as a distinguishing mark of honour and nobility. In Thrace, as Herodotus tells us\*, it was practised by none but persons of credit, nor omitted by any but persons of the meanest rank. The ancient Britons are also said to have imprinted on the bodies of their infants the figures of animals, and other marks, with hot irons.

STIL DE GRAIN, in the colour trade, the name of a composition used for painting in oil or water, and is made of a decoction of the lycium or Avignon berry, in alum-water, which is mixed with whiting into a paste, and formed into twisted sticks. It ought to be

chosu



Stilago  
||  
Stilling-  
fleet.

Stilling-  
fleet.

chosen of a fine gold yellow, very fine, tender, and friable, and free from dirt.

**STILAGO**, in botany; a genus of plants belonging to the class of *gynandria*, and order of *triandria*. There is one female. The calyx is monophyllous, and almost three-lobed. There is no corolla, and the berry is globular. There is only one species, the bunius.

**STILBE**, in botany; a genus of plants belonging to the class of *polygamia*, and order of *diœcia*. The exterior calyx of the hermaphrodite flower is triphyllous; the interior is quinque-dentate and cartilaginous. The corolla is funnel-shaped and quinquefid. There are four lamina; and there is one seed in the interior calyx calyptrate. The female flower is similar, has no interior calyx nor fruit. There are three species, the pinastra, ericoides, and cornua, all foreign plants.

**STILE**. See **STYLE**.

**STILL**, the name of an apparatus used in chemistry and in the distillation of ardent spirits. See **CHEMISTRY-Index** at *Distillation* and *Still*.

**Still-Bottoms**, in the distillery, a name given by the traders to what remains in the still after working the wash into low wines. These bottoms are procured in the greatest quantity from the malt wash, and are of so much value to the distiller in the fattening of hogs, &c. that he often finds them one of the most valuable articles of the business.

**STILLINGFLEET** (Edward), bishop of Worcester, was the son of Samuel Stillingfleet gentleman, and was born at Cranborn in Dorsetshire in 1635. He was educated at St John's College, Cambridge; and having received holy orders, was, in 1657, presented to the rectory of Sutton in Nottinghamshire. By publishing his *Origines Sacrae*, one of the ablest defences of revealed religion that has ever been written, he soon acquired such reputation, that he was appointed preacher of the Rolls Chapel; and in January 1665 was presented to the rectory of St Andrew's, Holborn. He was afterwards chosen lecturer at the Temple, and appointed chaplain in ordinary to king Charles II. In 1668 he took the degree of doctor of divinity; and was soon after engaged in a dispute with those of the Romish religion, by publishing his discourse concerning the idolatry and fanaticism of the church of Rome, which he afterwards defended against several antagonists. In 1680 he preached at Guildhall chapel a sermon on Phil. iii. 26. which he published under the title of *The Mischief of Separation*; and this being immediately attacked by several writers, he in 1683 published his *Unreasonableness of Separation*. In 1685 appeared his *Origines Britannicae*, or the Antiquities of the British Church, in folio. During the reign of king James II. he wrote several tracts against popery, and was prolocutor of the convocation, as he had likewise been under Charles II. After the Revolution he was advanced to the bishopric of Worcester, and was engaged in a dispute with the Socinians, and also with Mr Locke; in which last contest he is generally thought to have been unsuccessful. He died at Westminster in 1699, and was interred in the cathedral of Worcester, where a monument was erected to his memory by his son. Dr Stillingfleet wrote other works besides those here mentioned, which, with the above, have been reprinted in 6 vols folio.

**STILLINGFLEET** (Benjamin), an ingenious natura-

list, was grandson of the preceding. His father Edward was fellow of St John's College in Cambridge, F. R. S. M. D and Gresham professor of physic: but marrying in 1692, he lost his lucrative offices and his father's favour; a misfortune that affected both himself and his posterity. However, going into orders, he obtained, by his father's means, the living of Newington-Butts, which he immediately exchanged for those of Wood-Norton and Swanton in Norfolk. He died in 1708.

Benjamin, his only son, was educated at Norwich school, which he left in 1720, with the character of an excellent scholar. He then went to Trinity-College in Cambridge, at the request of Dr Bentley, the master, who had been private tutor to his father, domestic chaplain to his grandfather, and much indebted to the family. Here he was a candidate for a fellowship, but was rejected by the master's influence. This was a severe and unexpected disappointment, and but little alleviated afterwards by the Doctor's apology, that it was a pity that a gentleman of Mr Stillingfleet's parts should be buried within the walls of a college.

Perhaps, however, this ingratitude of Dr Bentley was not of any real disservice to Mr Stillingfleet. By being thrown into the world, he formed many honorable and valuable connections. He dedicated some translations of Linnæus to the late lord Lyttleton, partly, he says, from motives of private respect and honour. Lord Barrington gave him, in a very polite manner, the place of the master of the barracks at Kennington; a favour to which Mr Stillingfleet, in the dedication of his Calendar of Flora to that nobleman, alludes with equal politeness, as well as with the warmest gratitude. His Calendar of Flora was formed at Stratton in Norfolk in the year 1755, at the hospitable seat of his very worthy and ingenious friend Mr Marsham, who had made several observations of that kind, and had communicated to the public his curious observations on the growth of trees. But it was to Mr Wyndham of Felbrig in Norfolk that he appears to have had the greatest obligations: he travelled abroad with him, spent much of his time at his house, and was appointed one of his executors (Mr Garrick was another), with a considerable addition to an annuity which that gentleman had settled upon him in his lifetime.

Mr Stillingfleet's genius seems, if we may judge from his works, to have led him principally to the study of natural history; which he prosecuted as an ingenious philosopher, an useful citizen, and a good man. In this walk of learning he mentions, as his friends, Dr Watson, Mr (afterwards Dr) Solander, Mr Hudson, Mr Price of Foxley, and some others; to whom may be added the ingenious Mr Pennant. Nor can we omit the flattering mention which the late Mr Gray makes of him in one of his letters, dated from London in 1761: "I have lately made an acquaintance with this philosopher, who lives in a garret here in the winter, that he may support some near relations who depend upon him. He is always employed, consequently (according to my old maxim) always happy, always cheerful, and seems to me a very worthy honest man. His present scheme is to send some persons, properly qualified, to reside a year or two in Attica, to make themselves acquainted with the climate, productions,

Stilling-  
fleet  
||  
Stilpo.

and natural history of the country, that we may understand Aristotle, Theophrastus, &c. who have been heathen Greek to us for so many ages; and this he has got proposed to lord Bute, no unlikely person to put it in execution, as he is himself a botanist."

Mr Stillingfleet published a volume of miscellaneous tracts, which is in much esteem, and does great honour to his head and heart. They are chiefly translations of some essays in the *Amanitates Academicæ*, published by Linnæus, interspersed with some observations and additions of his own. In this volume he shows also a taste for classical learning, and entertains us with some elegant poetical effusions of his own. But his Essay on Conversation, published in the first volume of Doddsley's Collection of Poems, entitles him to a distinguished rank among our English poets. This poem is addressed to Mr Wyndham, with all that warmth of friendship which distinguishes Mr Stillingfleet. As it is chiefly didactic, it does not admit of so many ornaments as some compositions of other kinds. However, it contains much good sense, shows a considerable knowledge of mankind, and has several passages that in point of harmony and easy versification would not disgrace the writings of our most admired poets. Here more than once Mr Stillingfleet shows himself still sore for Dr Bentley's cruel treatment of him; and towards the beautiful and moral close of it (where it is supposed he gives us a sketch of himself) seems to hint at a mortification of a more delicate nature, which he is said to have suffered from the other sex.

To these disappointments it was perhaps owing that Mr Stillingfleet neither married nor went into orders. His London residence was at a saddler's in Piccadilly; where he died in 1771, aged above 70, leaving several valuable papers behind him. He was buried in St James's church, without the slightest monument of his having existed.

**STILLINGIA**, in botany; a genus of plants belonging to the class of *monœcia*, and to the order of *monodelphia*. The male calyx is hemispherical and multiflorous. The corolla is tubulous, and erose or gnawed. The female calyx is uniflorous and inferior. The corolla is superior. The style is trifid, and the capsule three-grained. There is only one species, the *sylvatica*.

**STILYARD**. See *STÆEL-Yard*.

**STILPO**, a celebrated philosopher of Megara, flourished under the reign of Ptolemy Euergetes. In his youth he had been addicted to licentious pleasures, from which he religiously restrained from the moment that he ranked himself among philosophers. When Ptolemy Soter, at the taking of Megara, offered him a large sum of money, and requested that he would accompany him into Egypt, he accepted but a small part of the offer, and retired to the island of Ægina, whence, on Ptolemy's departure, he returned to Megara. That city being again taken by Demetrius the son of Antigonus, and the philosopher required to give an account of any effects which he had lost during the hurry of the plunder, he replied, that he had lost nothing; for no one could take from him his learning and eloquence. So great was the fame of Stilpo, that the most eminent philosophers of Athens took pleasure in attending upon his discourses. His peculiar doctrines were, that species or universals have no real existence, and that one

thing cannot be predicated of another. With respect to the former of these opinions, he seems to have taught the same doctrine with the sect afterwards known by the appellation of *Nominalists*. To prove that one thing cannot be predicated of another, he said, that *goodness* and *man*, for instance, are different things, which cannot be confounded by asserting the one to be the other: he argued farther, that goodness is an universal, and universals have no real existence; consequently, since nothing cannot be predicated of any thing, goodness cannot be predicated of man. Thus, whilst this subtle logician was, through his whole argument, predicating one thing of another, he denied that any one thing could be the accident or predicate of another. If Stilpo was serious in this reasoning; if he meant any thing more than to expose the sophistry of the schools, he must be confessed to have been an eminent master of the art of wrangling; and it was not wholly without reason that Glycera, a celebrated courtesan, when she was reproved by him as a corrupter of youth, replied, that the charge might be justly retorted upon himself, who spent his time in filling their heads with sophistical quibbles and useless subtleties. In ethics he seems to have been a Stoic, and in religion he had a public and a private doctrine, the former for the multitude, and the latter for his friends. He admitted the existence of a supreme divinity, but had no reverence for the Grecian superstitions.

**STILOBATUM**, in architecture, denotes the body of the pedestal of any column.

**STILTON**, a town of England, in the county of Huntingdonshire, 75 miles from London, south-west of Yaxley, on the Roman highway from Caistor to Huntingdon, called *Erminz-street*, some parts of which, in this neighbourhood, appear still paved with stone. This place is famous for cheese which is called *Englyb Parmesan*, and is brought to table full of mites or maggots. For making Stilton cheese, we have the following receipt in the first volume of the *Repository of Arts and Manufactures*:

"Take the night's cream, and put it to the morning's new milk, with the rennet; when the curd is come, it is not to be broken, as is done with other cheeses, but take it out with a foil-dish altogether, and place it in a sieve to drain gradually; and as it drains, keep gradually pressing it till it becomes firm and dry; then place it in a wooden hoop; afterwards to be kept dry on boards, turned frequently, with cloth binders round it, which are to be tightened as occasion requires, and changed every day until the cheese become firm enough to support itself; after the cloth is taken off, the cheese is rubbed every day all over, for two or three months, with a brush; and if the weather be damp or moist twice a-day; and even before the cloth is taken off, the top and bottom are well rubbed every day."

**STIMULANTS**, in medicine, substances which increase the action of certain parts of the body. In particular, they quicken the motion of the blood, increase the action of the muscular fibres, and affect the nervous system.

**STIMULI**, in botany; a species of armature or offensive weapon, with which some plants, as nettle, cassida, acalypha, and tragia, are furnished. Their use, says Linnæus, is by their venomous punctures to keep

Stilobaton  
||  
Stimuli.

Enfield's  
History of  
Philosophy,  
vol. i.

Sting  
||  
Stiria.

keep off naked animals that would approach to hurt them.

STING, an apparatus in the bodies of certain insects, in form of a little spear, serving them as a weapon of offence.

STING-RAY, in ichthyology. See *RAIA*.

STINK-POT, an earthen jar or shell, charged with powder, grenades, and other materials of an offensive and suffocating smell. It is frequently used by privateers, in the western ocean, in the attack of an enemy whom he designs to board: for which purpose it is furnished with a light fuse at the opening or touch-hole. See *BOARDING*.

STINT, a species of the *TRINGA*.

STIPA, FEATHER GRASS, in botany: A genus of plants belonging to the class of *trindria*, and order of *dizygia*; and in the natural system ranging under the 4th order, *Gramina*. The calyx is bivalved. The exterior valve of the corolla is terminated by an awn; the base is jointed.

There are nine species, the pennata, juncea, capillata, aristella, tenacissima, avenacea, membranacea, arguens, and spicata. Of these one only is British, the *pennata* or common feather grass. The beards are feathered. The plant rises to the height of 10 inches, grows on mountains, and flowers in July or August.

STIPEND, among the Romans, signifies the same with tribute; and hence *stipendarii* were the same with *tributarii*.

STIPEND, in Scots law. See *LAW*, § clix. 12.

STIPULA, in botany, one of the fulera or prods of plants, defined by Linnæus to be a scale, or small leaf, stationed on each side the base of the footstalks of the flower and leaves, at their first appearance, for the purpose of support. Elmgren restricts it to the footstalks of the leaves only.

STIPULATION, in the civil law, the act of stipulating, that is, of treating and concluding terms and conditions to be inserted in a contract. Stipulations were anciently performed at Rome, with abundance of ceremonies; the first whereof was, that one party should interrogate, and the other answer, to give his consent, and oblige himself. By the ancient Roman law, nobody could stipulate but for himself; but as the *Tabelliones* were public servants, they were allowed to stipulate for their masters; and the notaries succeeding the *Tabelliones* have inherited the same privilege.

STIRIA, a province of Germany, in the circle of Austria, with the title of a duchy. It is bounded on the north by the archduchy of Austria, on the east by Hungary, on the south by Caroliola, and on the west by Carinthia and the archbishopric of Saltsburg; being 125 miles in length and 17 in breadth. It is said to contain 22 cities, 95 towns, 338 castles, 15 convents, and 200,000 inhabitants. Though it is a mountainous country, yet there is a great deal of land fit for tillage, and the soil is so good, that the inhabitants never were in want of corn. It contains mines of very good iron; whence the arms made there are in great esteem. The women differ greatly from the Austrians, and are very plain and downright. They have all swellings on their throats, called *bronchoceles*. The men are also very simple, and are very zealous worshippers of the Virgin

VOL. XVII. Part II.

Mary. They delight to sit at home in the chimney-corner, never troubling their heads about foreign affairs. The chief town is Gratz. Stirling.

STIRLING, a town of Scotland, situated on the river Forth, 35 miles north-west of Edinburgh, in W. Long. 3. 59 N. Lat. 56. 6. It is also called *Stirling* and *Striveling*; from the former of which Boethius falsely derives the name *Sterling money*; because, says he, Osbein, a Saxon prince, after the overthrow of the Scots, established a mint there. The name of *Striveling* is said to have been derived from the frequency of strifes or conflicts in the neighbourhood. The town contains about 4000 inhabitants. It has a manufacture of tartans and shalloons, and employs about 30 looms in that of carpets. The great street is very broad. In it is the tolbooth, where is kept the standard for the wet measures of Scotland. The other streets are narrow and irregular.—Stirling is in miniature a resemblance of Edinburgh; being built on a rock of the same form, with a fortress on the summit. The origin of the castle is unknown. The rock of Stirling was strongly fortified by the Picts, amongst whom architecture and several other useful arts had made a considerable progress. As it lay in the extremities of their kingdom, the possession of it was the occasion of frequent contests betwixt them and their neighbours the Scots and Northumbrians; each of whose dominions did, for some time, terminate near it.

When the Scots, under Kenneth II. overthrew the Pictish empire near the middle of the ninth century, they endeavoured to obliterate every memorial of that people. They not only gave new names to provinces and towns, but, with all the rage of barbarians, demolished many magnificent and useful edifices which had been reared up by them, and this fortress among the rest. It was, however, soon rebuilt, though upon an occasion not very honourable to the Scots.

Upon the death of Kenneth II. in 855, his brother Donald V. mounted the throne of Scotland. In the beginning of his reign the kingdom was invaded by Osbrecht and Ella, two Northumbrian princes, who, uniting their forces with the Cumbrian Britons, and a number of Picts, who upon their expulsion from their native country had taken refuge in England, advanced to Jedburgh, where Donald encountered them; and, after a fierce and bloody battle, obtained a complete victory: but, having taken up his station in Leirwick, in supine security, the Northumbrians, informed of the careless posture in which the Scottish army lay, surprised them by a hasty march, dispersed them, and made a prisoner of the king. Pursuing the advantage they had gained, they marched northward, and subdued all before them to the Irish of Forth and the town of Stirling. But the forlorn situation of the Scots, without a king and without an army, obliging them to sue for peace, they obtained it, upon condition that they should pay a sum of money for the ransom of the king, and yield up all their dominions upon the south side of the Forth to the conquerors.

The Northumbrians taking possession of the territories ceded to them by this treaty, rebuilt the castle of Stirling, and planted it with a strong garrison, in order to preserve their new conquests, upon the frontiers of which it was situated. Our authorities also inform

Stirling.

us, that they erected a stone-bridge over the Forth, upon the summit of which a cross was raised, with the following inscription in monkish rhyme.

*Angles a Scotis separat crux ista remotis ;  
Armis hic stant Bruti, Scoti stant hic, cruce tuti.*

Which is thus translated by Bellenden.

I am free marche, as passengeris may ken,  
To Scottis, to Britonis, and to Inglis-men.

None of the ancient English historians mention this conquest. The whole story, as well as the inscription, wears much of a monkish garb; yet its authenticity is not a little confirmed by the arms of the town of Stirling, upon which is a bridge, with a cross, and the last line of the above Latin dithich is the motto round it.

We must not, however, imagine, that in those times that fortrefs bore any resemblance to the present structure, which is adapted to the use of fire-arms. Its size and form probably resembled those castles which, under the feudal constitution, the English and Scottish barons used to erect upon their estates for dwelling-houses; and which, in those barbarous ages, they found necessary to fortify for their defence, not only against foreign invaders, but often against the attacks of their own neighbours. It is directly such a Gothic figure as this which represents the *Castrum Strivelense* upon the arms of Stirling.

This fortrefs, after it had continued in the possession of the Northumbrian Saxons about 20 years, was, together with the whole country upon the south side of the Forth, restored to the Scots, upon condition of their assisting the Saxons against their turbulent invaders the Danes. Upon the arms of Stirling are two branches of a tree, to represent the *Nimis Strivelense*; but the situation and boundaries of that forest, which was probably a wing of the Caledonian, cannot be ascertained. Upon the south of Stirling, vestiges of a forest are still discernible for several miles. Banks of natural timber still remain in the castle park, at Murray's wood, and near Nether Bannockburn; and stumps of trees, with much brushwood, are to be seen in all the adjacent fields.

When Kenneth III. received intelligence of the Danes having invaded his dominions, he appointed the castle of Stirling to be the place of rendezvous for his army; and he marched from thence to the battle of Loncarty, where he obtained a victory over those rovers, in the end of the 10th century.

In the 12th century, this castle is spoken of as a place of great importance, and one of the strongest fortresses in the kingdom. In 1174, a calamity, not unusual amongst the Scottish monarchs, befel William, who at that time occupied the throne. He was taken prisoner in an unsuccessful expedition which he made into England; and, after having been detained 12 months in captivity, was released, upon stipulating to pay a large sum of money for his ransom; and, until payment thereof, delivering into the hands of the English the four principal fortresses in the kingdom, which in those days were Stirling, Edinburgh, Roxburgh, and Berwick. This was the first great attendant that England obtained over Scotland; and indeed the most important transaction which had passed between these kingdoms from the Norman conquest.

Stirling.

Though the Scottish monarchs, in their frequent perambulations through the kingdom, often visited Stirling, and held their courts for some time in the castle; yet it did not become a royal residence till the family of Stuart mounted the throne, and it was from different princes of this family that it received its present form. It was the place of the nativity of James II.; and, when raised to the throne, he frequently kept his court in it. It is well known to have been the place where that prince perpetrated an atrocious deed, the murder of William earl of Douglas, whom he stabbed with his own hand. The royal apartments were at that time in the north-west corner of the castle, and are now the residence of the fort-major. The room where the murder was committed still goes by the name of *Douglas's room*. See SCOTLAND, n<sup>o</sup> 304, 305.

James III. contracting a fondness for the castle on account of its pleasant situation, made it the chief place of his residence, and added several embellishments to it. He built within it a magnificent hall, which in those days was deemed a noble structure, and is still entire. It now goes by the name of the *parliament-house*, having been designed for the accommodation of that supreme court. It was covered with an oaken roof of exquisite workmanship, which, though very little decayed, was a few years ago removed to make way for one of more modern structure. James also erected a college of secular priests in the castle, which he called the *chapel-royal*, and which proved one cause of his own ruin. As the expences necessary for maintaining the numerous officers of such an institution were considerable, he annexed to it the revenues of the rich priory of Coldingham in the Merse, which at that time happened to become vacant. This priory had for a long time been holden by persons connected with the family of Hume; and that family, considering it as belonging to them, strongly opposed the annexation. The dispute seems to have lasted several years; for one parliament had passed a vote, annexing the priory to the chapel-royal, and a subsequent one enacted a statute prohibiting every attempt that was contrary or prejudicial to that annexation.

James V. was crowned in the castle of Stirling; and the palace, which is the chief ornament of it, was the work of that prince. This is a stately and commodious structure, all of hewn stone, with much statuary work upon it. It is built in form of a square, with a small court in the middle, in which the king's lions are said to have been kept; and hence it still goes by the name of the *lions den*. The palace contains many large and elegant apartments; the ground-story is now converted into barrack-rooms for the soldiers of the garrison; the upper affords a house for the governor, with lodgings for some of the subaltern officers.

Opposite to the palace, upon the north, stands an elegant chapel, which was built by James VI. for the baptism of his son prince Henry in 1594. In this chapel is preserved the hulk of a large boat, which that whimsical monarch caused to be built and placed upon carriages, in order to convey into the castle the provisions for that solemnity.

A strong battery, with a tier of guns pointing to the bridge over the Forth, was erected during the regency of Mary of Lorraine, mother to queen Mary. It is called the *French battery*, probably because constructed by engineers of that nation. The last addition was made

Stirling.  
Stirling-  
shire.

to the fortifications in the reign of queen Anne. Formerly they reached no farther than the old gate, upon which the flag-staff now stands: but in that reign they were considerably enlarged upon the side towards the town; and barracks, which are bomb-proof, with several other conveniences for a siege, were erected.

Upon the south side of the castle lies a park inclosed with a stone-wall, called the *king's park*, and near to the foot of the rock on which the castle stands, lay the royal gardens; vestiges of the walks and parterres, with a few stumps of fruit-trees, are still visible; but by long neglect, and the natural wetness of the soil, the place is now little better than a marsh. In the gardens is a mount of earth in form of a table, with benches of earth around it, where, according to tradition, the court sometimes held *fetes-champetres*. In the castle-hill is an hollow, comprehending about an acre of ground, and having all the appearance of an artificial work, which was used for jousts, tournaments, and other feats of chivalry.

Northward of the castle lies the Govan, or perhaps more properly the *Gowling* hill (A); in the middle of which is a small mount called *Hurly Haaky*, upon which duke Murdoch and his two sons were executed for treasonable practices in the reign of James I.

The prospect from the castle is most delightful, as well as extensive, being greatly beautified, especially upon the east, by the windings of the Forth; which are so many, that though the distance by land from Stirling to Alloa is, in a straight line, not quite six miles, it is said to be 24 by water. As this river generally runs upon plain ground, it rolls its stream in so slow and silent a manner, that what Silius Italicus saith of the Ticinus is applicable to it, if, instead of *luenti* in that poet, we should for once read *lutofo*; for the clay-banks, together with the tide, which flows above Stirling, render the Forth perpetually muddy:

*Vix credas labi, ripis tam mitis opacis  
Somniferam ducit lutofo gurgite lympham.*

The lordship and castle of Stirling were a part of the usual dowry of the queens of Scotland, at least after the family of Stuart came to the throne, in which they were invested at their marriage.

Robert lord Erskine was appointed governor of the castle by king David II. and the office continued in that family till 1715.

This fortress hath been the scene of many transactions. Being by its situation considered as a key to the northern parts of the kingdom, the possession of it hath been always esteemed of great importance to those who sought to be masters of Scotland. It was undoubtedly a place of strength when the art of war by ordnance was in its infancy; but though it resisted the utmost efforts of the rebels in 1746, it could not now hold out three days if besieged by an army of a few thousand men conducted by an engineer of knowledge and integrity.

STIRLINGSHIRE, a county of Scotland, of which Stirling is the capital. It extends 25 miles in length and 12 in breadth; being bounded on the west

by part of Lennox and Clydesdale; on the east, by Clackmannashire, the river Forth, and part of Lothian; on the south-east, by Lothian; and on the north, by Monteith. The face of the country is open and agreeable, diversified by hill and dale, well watered with streams and rivers; the principal of which is the Forth, rising in the neighbourhood of a high mountain called *Ben-Lomond*, and, running eastward, forms the frith of Edinburgh. The southern part is hilly, affording plenty of game, and pasturage for sheep, horses, and black cattle. The eastern part is fertile, producing plentiful harvests of corn, and great abundance of coal. Lead-ore is found in different parts of the shire; and the rivers abound with pike, trout, and salmon.

STIRRUP, in the manage, a rest or support for the horseman's foot, for enabling him to mount and for keeping him firm in his seat.

Stirrups were unknown to the ancients. The want of them in getting upon horseback was supplied by a dexterity or art. Some horses were taught to stoop to take their riders up; but the riders often leapt up by the help of their spears, or were assisted by their slaves, or made use of ladders for the purpose. Gracchus filled the highways with stones, which were intended to answer the same end. The same was also required of the surveyors of the roads in Greece as part of their duty.

Menage observes, that St Jerome is the first author who mentions them. But the passage alluded to is not to be found in his epistles; and if it were there, it would prove nothing, because St Jerome lived at a time when stirrups are supposed to have been invented, and after the use of saddles. Montfaucon denies the authenticity of this passage; and, in order to account for the ignorance of the ancients with regard to an instrument so useful and so easy of invention, he observes, that while cloths and housings only were laid upon the horses backs, on which the riders were to sit, stirrups could not have been used, because they could not have been fastened with the same security as upon a saddle. But it is more probable, that in this instance, as in many others, the progress of human genius and invention is uncertain and slow, depending frequently upon accidental causes.

STIRRUP of a Ship, a piece of timber put upon a ship's keel, when some of her keel happens to be beaten off, and they cannot come conveniently to put or fit in a new piece; then they patch in a piece of timber, and bind it on with an iron, which goes under the ship's keel, and comes up on each side of the ship, where it is nailed strongly with spikes; and this they call a stirrup.

STOBÆUS (John), a laborious Greek writer, who lived at the end of the fourth century, composed many works, of which there are only his Collections remaining, and even these are not as he composed them; many things being inserted by later authors. This work contains many important sentiments collected from the ancient writers, poets, and philosophers.

STOCK, in gardening, &c. the stem or trunk of a tree. What stock is most proper for each kind of fruit, ought as well to be considered and known, as what soil

Stirrup

Stock.

(A) So called from the wailings and lamentations (in Scotch *gowlings*) that were made for Duke Murdoch.

*Stock.* *Stockholm.* is most suitable to trees; for on these two things the future vigour of trees, and the goodness of fruit, equally depend. The best way for those who intend to plant, is to raise their own stocks, by which they will be better assured of what they do; but if they should buy their trees of nurserymen, they should diligently inquire upon what stocks they were propagated. See *GRAFTING*.

*Stock*, in trade. See *CAPITAL Stock*.

*Stock-Broker*. See *BROKER* and *STOCKS*.

*Stock-Dove*, in zoology. See *COLUMBA*.

*Stock-Jobbing*, the art or mystery of trafficking in the public stocks or funds. See *FUND* and *Stock-JOB-BING*.

*Stock Gilly-flower*, in botany. See *CHEIRANTHUS*.

*STOCKHOLM*, the capital of Sweden, is situated in the province of Upland, in E. Long. 19. 30. and N. Lat. 59. 20. Its foundation is by the best Swedish writers generally attributed to Birger Jarl, regent of the kingdom about the middle of the 13th century during the minority of his son Waldemar, who had been raised to the throne by the states of the kingdom; but it was not before the last century that the royal residence was transferred from Upsala to this city.

This capital, which is very long and irregular, occupies, beside two peninsulas, seven small rocky islands, scattered in the Mæler, in the streams which issue from that lake, and in a bay of the gulf of Bothnia. A variety of contrasted and enchanting views are formed by numberless rocks of granite rising boldly from the surface of the water, partly bare and craggy, partly dotted with houses, or feathered with wood. The harbour is an inlet of the Baltic: the water is clear as crystal, and of such depth that ships of the largest burthen can approach the quay, which is of considerable breadth, and lined with spacious buildings and ware-houses. At the extremity of the harbour several streets rise one above another in the form of an amphitheatre; and the palace, a magnificent building, crowns the summit. Towards the sea, about two or three miles from the town, the harbour is contracted into a narrow strait, and, winding among high rocks, disappears from the sight; and the prospect is terminated by distant hills, overspread with forest. It is far beyond the power of words, or of the pencil, to delineate these singular views. The central island, from which the city derives its name, and the Ritterholm, are the handsomest parts of the town. Excepting in the suburbs, where the houses are of wood painted red, the generality of the buildings are of stone, or brick stuccoed white. The royal palace, which stands in the centre of Stockholm, and upon the highest spot of ground, was begun by Charles XI.: it is a large quadrangular stone edifice, and the style of architecture is both elegant and magnificent.

It is the habitation not only of the royal family, but also of the greater part of the officers belonging to the household. It likewise comprehends the national or supreme court of justice, the colleges of war, chancery, treasury, and commerce; a chapel, armoury, library, and office for the public records; but the greater number of inferior officers and servants belonging to the court, are, with the foot guards, quartered on the burghers. The castle, and all the stately edifices in the kingdom, are covered with copper. The palace of the nobility, in which this order sits during the session

of the diet, is an elegant building adorned on the outside with marble statues and columns, and on the inside with painting and sculpture. This and three other palaces stand on the banks of the lake, and are built on the same model, so as to compose a uniform piece of architecture. The bank, built at the expense of the city, is a noble edifice, and joins with many sumptuous houses belonging to the nobility in exhibiting a splendid appearance. The houses of the burghers are generally built of brick in the city; but in the suburbs they are commonly made up of timber, and therefore very subject to conflagrations. These houses are often framed in Finland, according to the plan and dimensions prescribed: whence they are transported in pieces to Stockholm by water, and there set up by the carpenters. These wooden habitations, if kept in proper repair, will last 30 or 40 years, and are deemed warmer, neater, and more healthy, than those of brick or stone. To prevent the danger of conflagrations, the city is divided into 12 wards. In each of these there is a master and four assistants, who forthwith repair to the place where the fire breaks out; and all porters and labourers are obliged to range themselves under the master of the ward to which they belong. A fire-watch patrols the streets by night, to give warning or assistance as it may be wanted; and a centinel is maintained in the steeple of every church, to toll the bell on the first appearance of any such accident. The police of Stockholm is entirely subjected to the regulations of the grand governor, assisted by a deputy and bailiff of the castle. This city is the staple of Sweden, to which all the commodities of the kingdom are brought for exportation, and where almost all the imports from abroad are deposited. The port or haven formed by the lake Mæler is large enough to contain 1000 sail of shipping; and furnished with a key or wharf about an English mile in length, to which the vessels may lie with their broadsides. The greatest inconveniences attending this situation are, the distance from the sea, which is not within less than 10 miles of the town; the want of tides; and the winding of the river, which is remarkably crooked. It opens into the Baltic; and the entrance, which is dangerous and rocky, the Swedes have secured with two small forts: within, it is perfectly safe and commodious. The northern suburbs are remarkable for the king's gardens, and for the great number of artificers who have chosen their habitations in this quarter. In the southern suburbs the Muscovite commodities are sold; and here is a magnificent exchange where the merchants daily assemble.

*STOCKING*, that part of the clothing of the leg and foot which immediately covers and screens them from the rigour of the cold. Anciently, the only stockings in use were made of cloth, or of milled stuffs sewed together; but since the invention of knitting and weaving stockings of silk, wool, cotton, thread, &c. the use of cloth stockings is quite discontinued. Dr Howel, in his *History of the World* (vol. ii. p. 222.) relates, that queen Elizabeth, in 1501, was presented with a pair of black knit silk stockings by her silk-woman, and thenceforth she never wore cloth ones any more. The same author adds, that king Henry VIII. ordinarily wore cloth hose, except there came from Spain, by great chance, a pair of silk stockings. His son, king Edward VI. was presented with a pair of long Spanish silk stockings by Sir Thomas Gresham, and

Stocking,  
Stocks.

and the present was then much taken notice of. Hence it should seem, that the invention of knit silk stockings originally came from Spain. Others relate, that one William Rider, an apprentice on London bridge, seeing at the house of an Italian merchant a pair of knit worsted stockings from Mantua, took the hint, and made a pair exactly like them, which he presented to William earl of Pembroke, and that they were the first of that kind worn in England, anno 1564.

The modern stockings, whether woven or knit, are formed of an infinite number of little knots, called *stitches*, *loops*, or *meshes*, intermingled in one another.

Knit stockings are wrought with needles made of polished iron, or brass wire, which interweave the threads and form the meshes the stocking consists of. At what time the art of knitting was invented it is perhaps impossible to determine, though it has been usually attributed to the Scots, as it is said that the first works of this kind came from Scotland. It is added, that it was on this account that the company of stocking-knitters, established at Paris 1527, took for their patron St Fiacre, who is said to have been the son of a king of Scotland. But it is most probable that the method of knitting stockings by wires or needles was first brought from Spain.

Woven stockings are generally very fine; they are manufactured on a frame or machine made of polished iron, the structure of which it is needless to describe, as it may be seen in almost every considerable town in Great Britain. The invention of this machine is, by Mr Anderson, attributed to William Lee, M. A. of St John's College, Cambridge, at a period so early as 1589. Others have given the credit of this invention to a student of Oxford at a much later period, who, it is said by Aaton Hill\*, was driven to it by dire necessity. His young man, falling in love with an inn-keeper's daughter, married her though she had not a penny, and he by his marriage lost a fellowship. They soon fell into extreme poverty; and their marriage producing the consequences naturally to be expected from it, the amorous pair became miserable, not so much on account of their sufferings, as from the melancholy dread of what would become of their yet unborn infant. Their only means of support were the knitting of stockings, at which the woman was very expert: "But sitting constantly together from morning to night, and the scholar often fixing his eyes, with steadfast observation, on the motion of his wife's fingers in the dexterous management of her needles, he took it into his imagination, that it was not impossible to contrive a little loom which might do the work with much more expedition. This thought he communicated to his wife, and joining his head to her hands, the endeavour succeeded to their wish. Thus the ingenious stocking-loom, which is so common now, was first invented; by which he did not only make himself and his family happy, but has left his nation indebted to him for a benefit which enables us to export silk stockings in great quantities, and to a vast advantage, to those very countries from whence before we used to bring them at considerable loss in the balance of our traffic."

**STOCKS, or PUBLIC FUNDS in England.** By the word *stock* was originally meant a particular sum of money contributed to the establishing of a fund to enable

Stocks,  
Stockton.

a company to carry on a certain trade, by means of which the person became a partner in that trade, and received a share of the profit made thereby, in proportion to the money employed. But this term has been extended farther, though improperly, to signify any sum of money which has been lent to the government, on condition of receiving a certain interest till the money is repaid, and which makes a part of the national debt. As the security both of the government and of the public companies is esteemed preferable to that of any private person, as the stocks are negotiable and may be sold at any time, and as the interest is always punctually paid when due; so they are thereby enabled to borrow money on a lower interest than what could be obtained from lending it to private persons, where there must be always some danger of losing both principal and interest.

But as every capital stock or fund of a company is raised for a particular purpose, and limited by parliament to a certain sum, it necessarily follows, that when that fund is completed, no stock can be bought of the company; though shares already purchased may be transferred from one person to another. This being the case, there is frequently a great disproportion between the original value of the shares and what is given for them when transferred: for it there are more buyers than sellers, a person who is indifferent about selling will not part with his share without a considerable profit to himself; and on the contrary, if many are disposed to sell, and few inclined to buy, the value of such shares will naturally fall in proportion to the impatience of those who want to turn their stock into specie.

A stock may likewise be affected by the court of chancery; for if that court should order the money, which is under their direction, to be laid out in any particular stock, that stock, by having more purchasers, will be raised to a higher price than any other of the like value.

By what has been said, the reader will perceive how much the credit and interest of the nation depends on the support of the public funds. While the annuities and interest for money advanced is there regularly paid, and the principal insured by both prince and people (a security not to be had in other nations), foreigners will lend us their property, and all Europe be interested in our welfare; the paper of the companies will be converted into money and merchandise, and Great Britain can never want cash to carry her schemes into execution. See the article **FUND**.

**STOCKS**, a frame erected on the shore of a river or harbour, whereon to build shipping. It generally consists of a number of wooden blocks, ranged parallel to each other, at convenient distances, and with a gradual declivity towards the water.

**STOCKS**, a wooden machine to put the legs of offenders in, for securing disorderly persons, and by way of punishment in divers cases, ordained by statute, &c.

**STOCKTON** upon Tees, a handsome town in the county of Durham, about 16 miles south of the city of Durham. It is now a port of considerable trade; though, at the Restoration, it was a despicable village, the best house in which could hardly boast of any thing better than clay-walls and a thatched roof.

About

\* See An Account of the Rise and Progress of the Beech Oil Invention, Sec. 8vo. 1715.

**Stoeb:** About 40 years ago it sent out in one year 75 vessels for the port of London; and the trade is much increased since.

**STOEBE, BASTARD ETHIOPIAN**, in botany: A genus of plants belonging to the class of *synzenfia*, and order of *polygamia frigidata*; and in the natural system ranging under the 49th order, *composita*. The calycle is uniflorous; the corollets are tubular and hermaphrodite; the receptacle is naked, and the pappus is feathery. There are nine species, the *athiopica*, *ericoides*, *prostrata*, *gnaphaloides*, *gemphrenoides*, *scabra*, *reflexa*, *rhinocerotis*, and *disticha*; all plants of foreign growth.

**STOICS**, the name given to a sect of Grecian philosophers, from *στῆρα*, "the porch in Athens," which the founder of the sect chose for his school. For the peculiar tenets of this sect, see *METAPHYSICS*, Chap. IV. Part 3. *MORAL PHILOSOPHY*, n° 8. and *ZENO*.

**STOLBERG**, a small town of Germany, in the circle of Upper Saxony, and territory of Thuringia, of which it is the capital place. It is seated between two mountains, 58 miles north-west of Leipsic. E. Long. 11. 8. N. Lat. 51. 42.

**STOLE**, a sacerdotal ornament worn by the Romish parish-priests above their surplice, as a mark of superiority in their respective churches; and by other priests over the alb, at celebrating of mass, in which case it goes across the stomach; and by deacons, over the left-shoulder, scarf-wise: when the priest reads the gospel for any one, he lays the bottom of his stole on his head. The stole is a broad swath, or slip of stuff, hanging from the neck to the feet, with three crosses thereon.

*Groom of the STOLE*, the eldest gentleman of his Majesty's bed-chamber, whose office it is to present and put on his majesty's first garment, or shirt, every morning, and to order the things in the chamber.

**STOMACH**, in anatomy. See *ANATOMY*, n° 91.

**STOMACHIC**, medicines that strengthen the stomach and promote digestion, &c.

Stomachic corroboratives are such as strengthen the tone of the stomach and intestines; among which are carminatives, as the roots of galangals, red gentian, zedoary, pimpinella, calamus aromaticus, and arum. Of barks and rinds, those of canella alba, saffras, citrons, Seville and China oranges, &c. Of spices, pepper, ginger, cloves, cinnamon, cardamums, and mace.

**STONE** (Edmund), a distinguished self-taught mathematician, was born in Scotland; but neither the place nor time of his birth are well known; nor have we any memoirs of his life, except a letter from the Chevalier de Ramsay, author of the *Travels of Cyrus*, in a letter to father Caffel, a Jesuit at Paris, and published in the *Memoirs de Trevoux* p. 109, as follows: "True genius overcomes all the disadvantages of birth, fortune, and education; of which Mr Stone is a rare example. Born a son of a gardener of the duke of Argyle, he arrived at eight years of age before he learnt to read.—By chance a servant having taught young Stone the letters of the alphabet, there needed nothing more to discover and expand his genius. He applied himself to study, and he arrived at the knowledge of the most sublime geometry and analysis, without a master, with-

out a conductor, without any other guide but pure genius. Stone.

"At 18 years of age he had made these considerable advances without being known, and without knowing himself the prodigies of his acquisitions. The duke of Argyle, who joined to his military talents a general knowledge of every science that adorns the mind of a man of his rank, walking one day in his garden, saw lying on the grass a Latin copy of Sir Isaac Newton's celebrated *Principia*. He called some one to him to take and carry it back to his library. Our young gardener told him that the book belonged to him. 'To you?' replied the Duke. 'Do you understand geometry, Latin, Newton?' I know a little of them, replied the young man with an air of simplicity arising from a profound ignorance of his own knowledge and talents. The Duke was surprised; and having a taste for the sciences, he entered into conversation with the young mathematician: he asked him several questions, and was astonished at the force, the accuracy, and the candour of his answers. 'But how, said the Duke, came you by the knowledge of all these things?' Stone replied, 'A servant taught me, ten years since, to read: does one need to know any thing more than the 24 letters in order to learn every thing else that one wishes?' The Duke's curiosity redoubled—he sat down upon a bank, and requested a detail of all his proceedings in becoming so learned.

"I first learned to read, said Stone: the masons were then at work upon your house: I went near them one day, and I saw that the architect used a rule, compasses, and that he made calculations. I inquired what might be the meaning and use of these things; and I was informed that there was a science called Arithmetic: I purchased a book of arithmetic, and I learned it.—I was told there was another science called Geometry: I bought the books, and I learnt geometry. By reading I found that there were good books in these two sciences in Latin: I bought a dictionary, and I learned Latin. I understood also that there were good books of the same kind in French: I bought a dictionary, and I learned French. And this, my lord, is what I have done: it seems to me that we may learn every thing when we know the 24 letters of the alphabet."

This account charmed the Duke. He drew this wonderful genius out of his obscurity; and he provided him with an employment which left him plenty of time to apply himself to the sciences. He discovered in him also the same genius for music, for painting, for architecture, for all the sciences which depend on calculations and proportions."

"I have seen Mr Stone. He is a man of great simplicity." He is at present sensible of his own knowledge; but he is not puffed up with it. He is possessed with a pure and disinterested love for the mathematics, though he is not solicitous to pass for a mathematician; vanity having no part in the great labour he sustains to excel in that science. He despises fortune also: and he has solicited me twenty times to request the duke to give him less employment, which may not be worth the half of that he now has, in order to be more retired, and less taken off from his favourite studies. He discovers sometimes, by methods of his own,



Stone. own, truths which others have discovered before him. He is charmed to find on these occasions that he is not a first inventor, and that others have made a greater progress than he thought. Far from being a plagiarist, he attributes ingenious solutions, which he gives to certain problems, to the hints he has found in others, although the connection is but very distant," &c.

Mr Stone was author and translator of several useful works; viz. 1. A New Mathematical Dictionary, in 1 vol. 8vo, first printed in 1726. 2. Fluxions, in 1 vol. 8vo, 1730. The Direct Method is a translation from the French, of Hospital's *Analyse des Infiniments Petits*; and the Inverse Method was supplied by Stone himself. 3. The Elements of Euclid, in 2 vols. 8vo, 1731. A neat and useful edition of those Elements, with an account of the life and writings of Euclid, and a defence of his elements against modern objectors. Beside other smaller works. Stone was a fellow of the Royal Society, and had inserted in the Philosophical Transactions (vol. 41, p. 218) an "Account of two species of lines of the 3d order, not mentioned by Sir Isaac Newton or Mr Stirling."

STONE (Jerome), the son of a reputable seaman, was born in the parish of Scoonie, in the county of Fife, North Britain. His father died abroad when he was but three years of age, and his mother, with her young family, was left in very narrow circumstances. Jerome, like the rest of the children, having got the ordinary school education, reading English, writing, and arithmetic, betook himself to the business of a travelling chapman. But the dealing in buckles, garters, and such small articles, not suiting his superior genius, he soon converted his little stock into books, and for some years went through the country, and attended the fairs as an itinerant bookseller. There is great reason to believe that he engaged in this new species of traffic, more with a view to the improvement of his mind than for any pecuniary emolument. Formed by nature for literature, he possessed a peculiar talent for acquiring languages with amazing facility. Whether from a desire to understand the Scriptures in their original languages, or from being informed that these languages are the parents of many others, he began his philological pursuits with the study of the Hebrew and Greek tongues; and, by a wonderful effort of genius and application, made himself so far master of these, without any kind of assistance, as to be able to interpret the Hebrew Bible and Greek Testament into English *ad aperturam libri*. At this time he did not know one word of Latin. Scarcely that he could make no great progress in learning, without the knowledge of at least the grammar of that language, he made application to the parish schoolmaster for his assistance. Some time afterwards, he was encouraged to prosecute his studies at the University of St Andrew's. An unexampled proficiency in every branch of literature recommended him to the esteem of the professors; and an uncommon fund of wit and pleasantry rendered him, at the same time, the favourite of all his fellow students, some of whom speak of him to this day with an enthusiastic degree of admiration and respect. About this period some very humorous poetical pieces of his composition were published in the Scots Magazine. Before he had finished his third session, or term, at St Andrew's, on an

application to the College by the master of the school of Dunkeld for an usher, Mr Stone was recommended as the best qualified for that office; and about two or three years after, the master being removed to Perth, Mr Stone, by the favour of his Grace the Duke of Atholl, who had conceived a high opinion of his abilities, was appointed his successor.

When he first went to Dunkeld, he entertained but an unfavourable opinion of the Gaelic language, which he considered as nothing better than a barbarous inarticulate gibberish; but being bent on investigating the origin and descent of the ancient Scots, he suffered not his prejudices to make him neglect the study of their primitive tongue. Having, with his usual assiduity and success, mastered the grammatical difficulties which he encountered, he set himself to discover something of the true genius and character of the language. He collected a number of ancient poems, the production of Irish or Scottish bards, which, he said, were daring, innocent, passionate, and bold. Some of these poems were translated into English verse, which several persons now alive have seen in manuscript, before Mr Macpherison published any of his translations from Ossian.

He died while he was writing and preparing for the press a treatise, intitled, "An Inquiry into the Original of the Nation and Language of the ancient Scots, with Conjectures about the Primitive State of the Celtic and other European Nations;" an idea which could not have been conceived by an ordinary genius. In this treatise he proves that the Scots drew their original, as well as their language, from the ancient Gauls. Had Mr Stone lived to finish this work, which discovers great ingenuity, immense reading, and indefatigable industry, it would have thrown light upon the dark and early periods of the Scottish history, as he opens a new and plain path for leading us through the unexplored labyrinths of antiquity. But a fever put an end to his life, his labours, and his usefulness, in the year 1757, being then only in the 30th year of his age. He left, in manuscript, a much esteemed and well-known allegory, intitled "The Immortality of Authors," which has been published and often reprinted since his death, and will be a lasting monument of a lively fancy, sound judgement, and correct taste. It was no small ornament of this extraordinary character, that he paid a pious regard to his aged mother, who survived him two years, and received an annual pension from the Dutchess of Atholl as a testimony of respect to the memory of her son.

STONEHIVE, or STONEHAVEN, a small town in the county of Kincardine, in Scotland, 15 miles south from Aberdeen. It was built in the time of Charles II. and stands at the foot of some high cliffs, in a small bay, with a rocky bottom, opening a little in one part, so that small vessels may find admittance, but only at high water. A pier laps over this harbour from the north side to secure them after their entrance. The town contains about 800 inhabitants. The manufactures are sail-cloths and Osnaburghs, knit worsted and thread stockings.

STONES, in natural history, bodies which are insipid, not ductile, nor inflammable, nor soluble in water. But as this is the definition given of earths by chemists and naturalists, we must refer the reader to the articles EARTH, and MINERALOGY, Part II. clais 1. for a

view of the classification of stones. Here we will only make a few observations concerning their natural history.

As philosophers have perplexed themselves much about the origin and formation of the earth (a subject certainly far beyond the ken of the human intellect, at least if we believe that it was made by the Almighty power of God), so they have also proposed theories to explain the origin of stones. When philosophers limit their inquiries within the boundaries of science, where they are led by the sober and safe conduct of observation and experiment, their conclusions may be solid and may be useful; but when, throwing experiment and observation aside, they rear a theory upon an airy nothing, or upon a single detached fact, their theories will vanish before the touch of true philosophy as a romantic palace before the rod of the enchanter. Sometimes from whim, or caprice, or vanity, they attempt to confound every thing: They wish to prove that the soul is mere matter, that plants are animals, and that fossils are plants, and thus would banish two substances, spirit and dead matter, entirely from the world; as if the Author of Nature were actuated by sordid views of parsimony in the works of creation, though we evidently see that a generous profusion is one of the characteristic marks of these works. We leave the task of confounding the different classes of being to those philosophers whose minds are too contracted to comprehend a great variety of being at one view, or who prefer novelty to every thing else. We content ourselves with the old opinion, that the soul is a spiritual substance; that plants are plants, and that stones are stones.

We have been led into these remarks by finding that some philosophers say that stones are vegetables; that they grow and increase in size like a plant. This theory, we believe, was first offered to the world by M. Tournefort, in the year 1702, after returning from his travels in the east. It was founded on a curious fact. In surveying the labyrinth of Crete, he observed that the names which visitors had engraved upon the rock were not formed of hollow but of prominent letters like basso relievo. He supposes that these letters were at first hollowed out by knives; that the hollows have since been filled up by the growth of the stone; and hence he concludes that stones vegetate. We wish we were fully assured of the fact that the letters were at first hollowed, before we attempt to account for their prominency. But even allowing the supposition to be true that they were at first hollow, we

reply it is only a single fact, and that it is altogether unphilosophical to deduce a general system from a single fact.

In the *second* place, this protuberancy of the characters is very improperly called vegetation, for it is not produced by a process in any respect like the vegetation of a plant. Vegetation supposes vessels containing fluids and growth by expansion; but who ever heard of vessels in a stone, of fluids moving in them, or of the different parts expanding and swelling like the branch or trunk of a tree? Even the fact which Tournefort mentions proves nothing. He does not pretend to say, that the rock itself is increasing, but only that a few small hollows are filled with new stony matter, which rises a little above the surrounding surface of the rock. This matter evidently has been once liquid, and at length has congealed in the channel into which it had run.— But is not this easily explained by a common process, the formation of stalactites? When water charged with calcareous matter is exposed to the action of air, the water evaporates, and leaves the calcareous earth behind, which hardens and becomes like a stone.

Having thus examined the principal fact upon which M. Tournefort founds his theory, it is unnecessary to follow him minutely through the rest of his subject.— He compares the accretion of matter in the labyrinth to the consolidation of a bone when broken, by a callus formed of the extravasated nutritious juice. This observation is thought to be confirmed, by finding that the projecting matter of the letters is whitish and the rock itself greyish. But it is easy to find comparisons. The difficulty, as Pope says, is to apply them. The resemblance between the filling up of the hollow of a stone, and the consolidation of a broken bone by a callus, we confess ourselves not philosophers enough to see. Were we writing poetry in bad taste, perhaps it might appear. The circumstance, that the prominent matter of the letters is whitish, while the rock is greyish, we flatter ourselves strengthens our supposition that it consists of a deposition of calcareous matter. Upon the whole, we conclude, we hope logically, that no such theory as this, that stones are vegetables, can be drawn from the supposed fact respecting the labyrinth. We have to regret, that the account which we have seen of the subject is so imperfect, that we have not sufficient materials for a proper investigation. Tournefort has not even told us of what kind of stone or earth the accretion consists; yet this single information would probably have decided the question (A).

*Artificial*

(A) To give a more distinct notion of Tournefort's theory, we shall subjoin his conclusions: From these observations (he says) it follows, that there are stones which grow in the quarries, and of consequence that are fed; that the same juice which nourishes them serves to rejoin their parts when broken; just as in the bones of animals, and the branches of trees, when kept up by bandages; and, in a word, that they vegetate. There is, then (he says), no room to doubt but that they are organized; or that they draw their nutritious juice from the earth. This juice must be first filtrated and prepared in their surface, which may be here esteemed as a kind of bark; and hence it must be conveyed to all the other parts. It is highly probable the juice which filled the cavities of the letters was brought thither from the bottom of the roots; nor is there any more difficulty in conceiving this than in comprehending how the sap should pass from the roots of our largest oaks to the very extremities of their highest branches. Some stones, then (he concludes), must be allowed to vegetate and grow like plants: but this is not all; (he adds), that probably they are generated in the same manner; at least, that there are abundance of stones whose generation is inconceivable, without supposing that they come from a kind of seeds, wherein the organical parts of the stones are wrapped up as those of the largest plants are in their seeds.

Stone.

*Artificial STONE.* See STUCCO.*Elastic STONE.* See ELASTIC MARBLE.*Philosopher's STONE.* See PHILOSOPHER'S STONE.*Precious STONES.* See GEM.

*Rocking STONE,* or *Logan*, a stone of a prodigious size, so exactly poised, that it would rock or shake with the smallest force. Of these stones the ancients give us some account. Pliny says, that at Harpasa, a town of Asia, there was a rock of such a wonderful nature, that if touched with the finger it would shake, but could not be moved from its place with the whole force of the body\*. Ptolemy Hephæstion mentions† a gygonian stone near the ocean, which was agitated when struck by the stalk of an asphodel, but could not be removed by a great exertion of force. The word *gygonius* seems to be Celtic; for *gwingog* signifies *motitans*, the rocking-stone.

Many rocking stones are to be found in different parts of this island; some natural, others artificial, or placed in their position by human art. In the parish of St Leven, Cornwall, there is a promontory called *Cas-tle Treryn*. On the western side of the middle group, near the top, lies a very large stone, so evenly poised that any hand may move it from one side to another; yet it is so fixed on its base, that no lever nor any mechanical force can remove it from its present situation. It is called the *Logan-stone*, and is at such a height from the ground that no person can believe that it was raised to its present position by art. But there are other rocking stones, which are so shaped and so situated, that there can be no doubt but they were erected by human strength. Of this kind Borlase thinks the great *Quoit* or *Karn-lebau*, in the parish of Tywidnek, to be. It is 30 feet in circumference, and four feet thick at a medium, and stands on a single pedestal. There is also a remarkable stone of the same kind in the island of St Agnes in Scilly. The under rock A is 10 feet 6 inches high, 47 feet round the middle, and touches the ground with no more than half its base. The upper rock C rests on one point only, and is so nicely balanced, that two or three men with a pole can move it. It is eight feet six inches high, and 47 in circumference. On the top there is a basin D hollowed out, three feet eleven inches in diameter at a medium, but wider at the brim, and three feet deep. From the globular shape of this upper stone, it is highly probable that it was rounded by human art, and perhaps even placed on its pedestal by human strength. In Sithney parish, near Helston, in Cornwall, stood the famous logan, or rocking stone, commonly called *Men Amber*, q. d. *Men an Bar*, or the *top-stone*. It was eleven feet by six and four high, and so nicely poised on another stone that a little child could move it, and all travellers who came this way desired to see it. But Shrobsfall, Cromwell's governor of Pendennis, with much ado caused it to be undermined, to the great grief of the country. There are some marks of the tool on it, and, by its quadrangular shape, it was probably dedicated to Mercury.

That the rocking stones are monuments erected by the Druids cannot be doubted; but tradition has not informed us for what purpose they were intended. Mr Toland thinks that the Druids made the people believe that they alone could move them, and that by a miracle; and that by this pretended miracle they condemned

VOL. XVII. Part II.

or acquitted the accused, and brought criminals to confess what could not otherwise be extorted from them. How far this conjecture is right we shall leave to those who are deeply versed in the knowledge of antiquities to determine.

*Sonorous STONE*, a kind of stone remarkable for emitting an agreeable sound when struck, and much used in China for making musical instruments which they call *king*.

The various kinds of sonorous stones known in China differ considerably from one another in beauty, and in the strength and duration of their tone; and what is very surprising, is, that this difference cannot be discovered either by the different degrees of their hardness, weight, or fineness of grain, or by any other qualities which might be supposed to determine it. Some stones are found remarkably hard, which are very sonorous; and others exceedingly soft, which have an excellent tone; some extremely heavy emit a very sweet sound; and there are others as light as pumice-stone which have also an agreeable sound.

The chemists and naturalists of Europe have never yet attempted to discover, whether some of our stones may not have the same properties as the sonorous stones of the extremities of Asia. It however appears, that the Romans were formerly acquainted with a sonorous stone of the class of *hiang-che*. Pliny (says the Abbé du Bos, in his Reflections on Poetry and Painting, when speaking of curious stones) observes that the stone called *chalcophonas*, or *brazen sound*, is black; and that, according to the etymology of its name, it sends forth a sound much resembling that of brass when it is struck. The passage of Pliny is as follows: *Chalcophonas nigra est; sed elisa æris tinnitum red lit.*

Some sonorous stones were at length sent into France, and the late Duke de Chaulnes examined them with particular attention. The following are some of his observations: "The Academy of Sciences, Mr Roué de Lisle, and several other learned mineralogists, when asked if they were acquainted with the black stone of which the Chinese king was made, for answer cited the passage of Pliny mentioned by Boethius de Bott, Linnæus, and in the Dictionary of Bomare, and added what Mr Anderson says in his Natural History of Iceland respecting a bluish kind of stone which is very sonorous. As the black stone of the Chinese becomes of a bluish colour when filed, it is probably of the same species. None of the rest who were consulted had ever seen it. The Chinese stone has a great resemblance at first sight to black marble, and like it is calcareous; but marble generally is not sonorous. It also externally resembles touchstone, which is a kind of basalt, and the basaltes found near volcanos; but these two stones are vitrifications."

The duke next endeavoured to procure some information from the stone-cutters. They all replied, that blue-coloured marble was very sonorous, and that they had seen large blocks of it which emitted a very strong sound; but the duke having ordered a king to be constructed of this kind of stone, it was found that it did not possess that property. By trying the black marble of Flanders, a piece was at length found which emitted an agreeable sound: it was cut into a king, which is almost as sonorous as those of China. All these observa-

5 K

tions

Stone.

• Lib. ii.  
c. 69.  
† Lib. iii.  
c. 3.

Plate  
ccclxxii.  
Fig. 7.

Borlase,  
chap. iv.  
p. 151.

Stone.

tions give us reason to believe that the stones of which the king are formed are nothing else but a black kind of marble, the constituent parts of which are the same as those of the marble of Europe, but that some difference in their organization renders them more or less sonorous.

*Swine-Stone* (*lapis fuillus*), or *fetid stone*, so called from its excessively fetid smell, calcareous earth impregnated with petroleum. It is found, 1. Solid, with the particles scarcely visible, of a black colour, as the marble does in Flanders, and in the province of Jutland in Sweden. 2. With visible grains of a blackish brown colour, found likewise in some places of Sweden. 3. With coarse scales, found also in Sweden. Great part of the limestones found in England belong to this class, and emit a very fetid smell when struck violently, but it soon goes off in the fire.

*STONE Marrow.* See CLAY, species 4.

*STONE-Ware*, a species of pottery so called from its hardness. See *D-LEFT-Ware*, PORCELAIN, and POTTERY.

Clay is a principal ingredient in pottery of all kinds which has the property of hardening in the fire, and of receiving and preserving any form into which it is moulded. One kind of clay resists the most violent action of the fire after being hardened to a certain degree, but is incapable of receiving a sufficient degree of hardness and solidity. A second kind assumes a hardness resembling that of flint, and such a compactness that vessels made of it have a glossy appearance in their fracture resembling porcelain. These two species owe their peculiar properties of resisting heat without melting, to sand, chalk, gypsum or ferruginous earth, which they contain. A third species of clay begins to harden with a moderate fire, and melts entirely with a strong fire. It is of the second species that stone-ware is made.

The most famous manufactory of stone-ware, as well as of other kinds of pottery, is at Burslem in Staffordshire. This can be traced with certainty at least two centuries back; but of its first introduction no tradition remains. In 1686, as we learn from Dr Plot's *Natural History of Staffordshire* published in that year, only the coarse yellow, red, black, and mottled wares, were made in this country; and the only materials employed for them appear to have been the different coloured clays which are found in the neighbourhood, and which form some of the measures or strata of the coal-mines. These coarse clays made the body of the ware, and the glaze was produced by powdered lead-ore, sprinkled on the pieces before firing, with the addition of a little manganese for some particular colours. The quantity of goods manufactured was at that time so inconsiderable, that the chief sale of them, the Doctor says, was "to poor crate-men, who carried them on their backs all over the country."

About the year 1692, two ingenious artificers from Germany, of the name of Eller, settled near Burslem, and carried on a small work for a little time. They brought into this country the method of glazing stone-ware, by casting salt into the kiln while it is hot, and some other improvements of less importance; but finding they could not keep their secrets to themselves, they left the place rather in disgust. From this time various kinds of stone-ware, glazed by the fumes of salt in the manner above-mentioned, were added to the wares

before made. The white kind, which afterwards became, and for many succeeding years continued, the staple branch of pottery, is said to have owed its origin to the following accident. A potter, Mr Alsbury, travelling to London, perceived something amiss with one of his horse's eyes, an hostler at Dunstable said he could soon cure him, and for that purpose put a common black flint stone into the fire. The potter observing it, when taken out, to be of a fine white, immediately conceived the idea of improving his ware by the addition of this material to the whitest clay he could procure: accordingly he sent home a quantity of the flint stones of that country, where they are plentiful among the chalk, and by mixing them with tobacco-pipe clay, produced a white stone ware much superior to any that had been seen before.

Some of the other potters soon discovered the source of this superiority, and did not fail to follow his example. For a long time they pounded the flint stones in private rooms by manual labour in mortars; but many of the poor workmen suffered severely from the dust of the flint getting into their lungs, and producing dreadful coughs, consumptions, and other pulmonary disorders. These disasters, and the increased demand for the flint powder, induced them to try to grind it by mills of various constructions; and this method being found both effectual and safe, has continued in practice ever since. With these improvements, in the beginning of the present century, various articles were produced for tea and coffee equipages. Soon after attempts were made to furnish the dinner table also; and before the middle of the century, utensils for the table were manufactured in quantity as well for exportation as home consumption.

But the salt glaze, the only one then in use for this purpose, is in its own nature so imperfect, and the potters, from an injudicious competition among themselves for cheapness, rather than excellence, had been so inattentive to elegance of form and neatness of workmanship, that this ware was rejected from the tables of persons of rank; and about the year 1765, a white ware, much more beautiful and better glazed than ours, began to be imported in considerable quantities from France.

This inundation of a foreign manufacture, so much superior to any of our own, must have had very bad effects upon the potteries of this kingdom, if a new one, still more to the public taste, had not appeared soon after. In the year 1763, Mr Josiah Wedgwood, who had already introduced several improvements into this art, invented a species of earthen ware for the table quite new in its appearance, covered with a rich and brilliant glaze, bearing sudden alternations of heat and cold, manufactured with ease and expedition, and consequently cheap, and having every requisite for the purpose intended. To this new manufacture the queen was pleased to give her name and patronage, commanding it to be called *Queen's ware*, and honouring the inventor by appointing him her majesty's potter.

The common clay of the country is used for the ordinary sorts; the finer kinds are made of clay from Devonshire and Dorsetshire, chiefly from Biddeford; but the flints from the Thames are all brought rough by sea, either to Liverpool or Hull, and so by Burton. There is no conjecture formed of the original rea-

Stone,  
Stone-  
henge.

son of fixing the manufacture in this spot, except for the convenience of plenty of coals, which abound under all the country.

The flints first are ground in mills, and the clay prepared by breaking, washing, and fitting, and then they are mixed in the requisite proportions. The flints are bought first by the people about the country, and by them burnt and ground, and sold to the manufacturers by the peck.

The mixture is then laid in large quantities on kilns to evaporate the moisture; but this is a nice work, as it must not be too dry; next it is beat with large wooden hammers, and then is in order for throwing, and is moulded into the forms in which it is to remain: this is the most difficult work in the whole manufacture. A boy turns a perpendicular wheel, which by means of thorns turns a small horizontal one, just before the thrower, with such velocity, that it twirls round the lump of clay he lays on it into any form he directs it with his fingers.

There are 300 houses which are calculated to employ, upon an average, twenty hands each, or 6000 in the whole; but of all the variety of people that work in what may be called the preparation for the employment of the immediate manufacturers, the total number cannot be much short of 10,000, and it is increasing every day. Large quantities are exported to Germany, Ireland, Holland, Russia, Spain, the East Indies, and much to America; some of the finest sorts to France.

STONE in the Bladder. See MEDICINE, n° 400. SURGERY-Index; and ALKALI, n° 17, 18, 19.

STONE, in merchandize, denotes a certain weight for weighing commodities. A stone of beef at London is the quantity of eight pounds: in Herefordshire 12 pounds: in the North 16 pounds. A stone of glass is five pounds; of wax eight pounds. A stone of wool (according to the statute of 11 Hen VII.) is to weigh 14 pounds; yet in some places it is more, in others less; as in Gloucestershire 15 pounds; in Herefordshire 12 pounds. Among horse-courfers a stone is the weight of 14 pounds.

The reason of the name is evident. Weights at first were generally made of stone. See Deut. xxv. 13, where the word כֶּסֶם, translated *weight*, properly signifies *a stone*.

STONE-Chatte, in ornithology. See MOTACILLA.

STONEHENGE, a celebrated monument of antiquity, stands in the middle of a flat area near the summit of a hill six miles distant from Salisbury. It is inclosed by a circular double bank and ditch near 30 feet broad, after crossing which we ascend 30 yards before we reach the work. The whole fabric consisted of two circles and two ovals. The outer circle is about 108 feet diameter, consisting when entire of 60 stones, 30 uprights and 30 imposts, of which remain only 24 uprights, 17 standing and 7 down, 3½ feet asunder, and 8 imposts. Eleven uprights have their 5 imposts on them by the grand entrance. These stones are from 13 to 25 feet high. The lesser circle is somewhat more than 8 feet from the inside of the outer one, and consisted of 40 lesser stones (the highest 6 feet), of which only 19 remain, and only 11 standing: the walk between these two circles is 300 feet in circumference. The Adytum or Cell is an oval formed of 10 stones (from 16 to 22 feet high), in pairs, with imposts, which Dr Stukeley

calls *trilithons*, and above 30 feet high, rising in height as they go round, and each pair separate, and not connected as the outer pair; the highest 8 feet. Within these are 19 more smaller single stones, of which only 6 are standing. At the upper end of the Adytum is the altar, a large slab of blue coarse marble, 20 inches thick, 16 feet long, and 4 broad; prested down by the weight of the vast stones that have fallen upon it. The whole number of stones, uprights, imposts, and altar, is exactly 140. The stones are far from being artificial, but were most probably brought from those called the *Grey Weathers* on Marlborough Downs, 15 or 16 miles off; and if tried with a tool they appear of the same hardness, grain, and colour, generally reddish. The heads of oxen, deer, and other beasts, have been found on digging in and about Stonehenge; and human bones in the circumjacent barrows. There are three entrances from the plain to this structure, the most considerable of which is from the north-east, and at each of them were raised on the outside of the trench two huge stones with two smaller within parallel to them.

It has been long a dispute among the learned, by what nation, and for what purpose, these enormous stones were collected and arranged. The first account of this structure we meet with is in Geoffroy of Monmouth, who, in the reign of King Stephen, wrote the history of the Britons in Latin. He tells us, that it was erected by the counsel of Merlin the British enchanter, at the command of Aurelius Ambrosius the last British king, in memory of 460 Britons who were murdered by Hengist the Saxon. The next account is that of Polydore Virgil, who says that the Britons erected this as a sepulchral monument of Aurelius Ambrosius. Others suppose it to have been a sepulchral monument of Boadicea the famous British Queen. Inigo Jones is of opinion, that it was a Roman temple; from a stone 16 feet long, and four broad, placed in an exact position to the eastward, altar-fashion. Mr Charlton attributed it to the Danes, who were two years masters of Wiltshire; a tin tablet, on which were some unknown characters, supposed to be Punic, was digged up near it in the reign of Henry VIII. but is lost; probably that might have given some information respecting its founders. Its common name, *Stonehenge*, is Saxon, and signifies a "stone gallows," to which those stones, having transverse imposts, bear some resemblance. It is also called in Welch *choir gour*, or "the giants dance."

Mr Grose thinks that Dr Stukeley has completely proved this structure to have been a British temple in which the Druids officiated. He supposes it to have been the metropolitan temple of Great Britain, and translates the words *choir gour* "the great choir or temple." The learned Mr Bryant is of opinion that it was erected by a colony of Cuthites probably before the time of the Druids; because it was usual with them to place one vast stone upon another for a religious memorial; and these they often placed so equably, that even a breath of wind would sometimes make them vibrate. Of such stones one remains at this day in the pile of Stonehenge. The ancients distinguished stones erected with a religious view, by the name of *amber*; by which was signified any thing solar and divine. The Grecians called them *σπίραι ἀμβροσίου*, *petra ambrosia*. Stonehenge, according

Stone-  
henge.

Stook  
||  
Stove.

According to Mr Bryant, is composed of these amber stones: hence the next town is denominated *Ambresbury*; not from a Roman Ambrosius, for no such person ever existed, but from the *ambrosie petreæ*, in whose vicinity it stood. Some of these were rocking stones; and there was a wonderful monument of this sort near Penzance in Cornwall, which still retains the name of *main-amber*, or the sacred stones. Such a one is mentioned by Apollonius Rhodius, supposed to have been raised in the time of the Argonautæ, in the island Tenos, as the monument of the two-winged sons of Boreas, slain by Hercules; and there are others in China and other countries.

STOOK, a term used in many parts of the kingdom for a sheck of corn containing 12 sheaves.

STOOL, in medicine, an evacuation or discharge of the fæces by the anus.

STOOL, in mining, is used when the miners leave off digging deeper, and work in the ends forward. The end before them is called the *stool*.

STOOL, in ship-building, the name of the supporters of the poop and top lanterns.

STOOPING, in falconry, is when a hawk, being upon her wings at the height of her pitch, bends down violently to take the fowl.

STOPPERS, in a ship, certain short pieces of rope, which are usually knotted at one or both ends, according to the purpose for which they are designed. They are either used to suspend any heavy body, or to retain a cable, shroud, &c. in a fixed position. Thus, the anchors, when first hoisted up from the ground, are hung to the cat-head by a stopper attached to the latter, which passing through the anchor-ring, is afterwards fastened to the timber-head; and the same rope serves to fasten it on the bow at sea; or to suspend it by the ring which is to be sunk from the ship to the bottom. The stoppers of the cable have a large knot and a laniard at one end, and are fastened to a ring-bolt in the deck by the other. They are attached to the cable by the laniard, which is fastened securely round both by several turns passed behind the knot, or about the neck of the stopper; by which means the cable is restrained from running out of the ship when she rides at anchor.

The stoppers of the shroud have a knot and a laniard at each end. They are only used when the shrouds are cut afunder in battle, or disabled by tempestuous weather; at which time they are lashed, in the same manner as those of the cables, to the separated parts of the shroud, which are thereby reunited, so as to be fit for immediate service. This, however, is only a temporary expedient.

STOPS. See PUNCTUATION; and SCRIPTURE; n<sup>o</sup> 136.

STORAX. See STYRAX.

STORK, in ornithology. See ARDEA.

STOVE for heating apartments, greenhouses, hot-houses, fruit-walls, &c.

When treating of the mechanical properties of air, we explained in sufficient detail the manner in which the expansion produced in a mass of air by heat produces that motion up our chimneys which is called the draught of the chimney; and, in the article SMOKE, we considered the circumstances which tend to check, to promote, or to direct this current, so as to free us from the smoke and vitiated air which necessarily accom-

Stove.

panies the consumption of the fuel. In PNEUMATICS we also attended to the manner in which our fires immediately operate in warming our apartments. At present, when about to describe a method of warming intrinsically different, we must pay some more attention to the distinguishing circumstance. Without pretending to explain the physical connection of heat and light, it may suffice to observe, that heat, as well as light, is communicated to distant bodies in an instant by radiation. A person passing hastily by the door of a glass-house feels the glow of heat in the very moment he sees the dazzling light of the furnace mouth, and it is interrupted by merely screening his face with his hand. In this way is an apartment partly warmed by an open fire; and we avoid the oppressive heat by sitting where the fire is not seen, or by interposing a screen. We are apt to connect this so strongly in the imagination with the light emitted by the fire, that we attribute the heat to the immediate action of the light. But this opinion is shown to be gratuitous by a curious experiment made before the Royal Society by Dr Hooke, and afterwards, with more care and accurate examination, by Mr Scheele. They found, that by bringing a plate of the most transparent glass briskly between the fire and one's face, the heat is immediately intercepted without any sensible diminution of the light. Scheele, by a very pretty investigation, discovered that the glass made the separation, and did it both in refraction and reflection; for he found, that when the light of the same fire was collected into a focus by means of a polished metal concave speculum, a thermometer placed there was *instantly* affected. But if we employ a glass speculum foiled in the usual manner with quicksilver, of the same diameter and focal distance, and of equally brilliant reflection, there is hardly any sensible heat produced in the focus, and the thermometer must remain there for a very long while before it is sensibly affected. When we repeated this curious experiment, we found, that after the glass has remained a long while in this position, whether transmitting or reflecting the light, it loses in a great measure its power of intercepting the heat. By varying this observation in many of its circumstances, we think ourselves entitled to conclude, that the glass absorbs the heat which it intercepts, and is very quickly heated by the absorption. While it rises in its own temperature, it intercepts the heat powerfully; but when it is, as it were, saturated, attracting no more than what it immediately imparts to the air in corporeal contact with it, the heat passes freely through along with the light. If the glass be held so near the fire that the surrounding air is very much heated, no sensible interruption of heat is perceived after the glass is thus saturated. We found the cheek more quickly sensible than the thermometer of this instantaneous radiation of the heat which accompanies the light, or is separated from it in this experiment. It is a very instructive experiment in the physiology of heat.

We cannot say how far this radiation of heat may extend, nor whether the accompaniment of light is absolutely necessary. The mathematician proceeds on the supposition that it extends as far as the radiation of light, and that, being also rectilineal, the density of the heat is proportional to that of the light. But these notions are somewhat gratuitous; and there are

appearances

appearances which render them doubtful. When with a lens of an inch in diameter we form a focus on a piece of black unpolished marble of an inch diameter, the mathematician must allow that no more rays fall on the marble than if the lens were away: therefore the marble should be equally warmed in either case. But it is by no means so, as we have repeatedly found by exposing it during equal times, and then dropping it into water. The water which is heated by the marble on which the focus has been formed will be found to have acquired from it much more heat than from the other. The tops of lofty mountains which are never shaded by clouds, but enjoy perpetual sunshine and serenity, instead of being warmer than the valleys below, are covered with never-melting snow; and we have some grounds to suspect that the genial influence of the sun requires the co-operation of the atmosphere, and to doubt whether there is any warmth at the moon, on which no atmosphere like ours can be observed. Perhaps the heat which cheers us, and fertilizes our earth, is chemically separated from our atmosphere by its elective attraction for the light of the sun. Our successors in the study of meteorology need not fear that the subject of their research will be soon deprived of scientific allurements. We know but little of it after all the progress we have made during this last century, and it still presents an ample field of discussion.

We said that the accompaniment of light is not demonstrably necessary. We are certain that heat may be imparted without any sensible light, in a manner which we can hardly suppose any thing but radiation. If a piece of very hot iron be placed a little without the principal focus of a metallic concave speculum, and a very sensible air-thermometer be placed in its conjugate focus, it will instantly show an elevation of temperature, although the iron is quite imperceptible to an eye which has even been a long while in the dark. No such rise of temperature is observed if the thermometer be placed a little to one side of the focus of the speculum; therefore the phenomenon is precisely similar to the radiation of light. We are obliged therefore to acknowledge that the heat is radiated in this experiment in the same way that light is in the common optical experiments.

Although this is the most usual way that we in this country employ fuel for warming our apartments, it is by no means the only way in which the heat diffused from this fuel may be imparted to distant bodies. It is not even the most effectual method; it is diffused also by immediate communication to bodies in contact. The air in immediate contact with the burning fuel is heated, and imparts some of its heat to the air lying beyond it, and this is partly shared with the air which is still further off; and this diffusion, by communication *in contactu*, goes on till the remote air contiguous to the walls, the floor, the ceiling, the furniture, the company, all get a share of it in proportion to their attractions and their capacities. And as the air is thus continually supplied, and continually gives out heat, the walls, &c. become gradually warmer, and the room becomes comfortable and pleasant. But we apprehend that no great proportion of the heat actually acquired by the room is communicated in this way. This diffusion by contact is but slow, especially in air which is very dry; so slow indeed, that the air in the immediate neighbourhood of the fuel is hurried up the chimney be-

fore it has time to impart any of the heat received in contact. We know that the time employed in diffusing itself in this way through stagnant air to any moderate distance is very considerable. We imagine therefore that the heat communicated to our rooms by an open fire is chiefly by radiation, but in a way something different from what we mentioned before. We imagine, that as the piece of glass in Dr Hooke's experiment absorbs the heat, so the whole mass of air which fills the room intercepts the radiated heat in every part of the room where the fire is seen, and is as it were saturated with it throughout, and ready to impart it to every body immersed in it. We cannot otherwise account for the *equability* of the heat in the different parts of the room. Mere radiation on the solid bodies would warm them in the inverse duplicate ratio of their distances from the fire; and diffusion by contact, if compatible with the rapid current up the chimney, would heat the room still more unequally. Recollect how slowly, and with what rapid diminution of intensity, the colour of blue vitriol is communicated to water even to a very small distance. But because all parts of the air of the room absorb radiated heat, what is saturated at a higher temperature, being nearer to the fire, rises to the ceiling, spreads outwards along the ceiling, and has its place supplied by the air, which is thus pushed towards the fire from the places which are not directly illuminated.

Far different is the method of warming the room by a stove. Here the radiation, if any, is very feeble or scanty; and if a passage were allowed up the chimney for the warmed air, it would be quickly carried off. This is well known to the English who reside in the cold climates of St Petersburg, Archangel, &c. They love the exhilarating flutter of an open fire, and often have one in their parlour; but this, so far from warming the room during the extreme cold weather, obliges them to heat their stoves more frequently, and even abstracts the heat from a whole suite of apartments. But all passages this way is shut up when we warm a room by stoves. The air immediately contiguous to the stove is heated by contact, and this heat is gradually, though slowly, diffused through the whole room. The diffusion would however be very slow indeed, were it not for the great expansibility of air by heat. But the air surrounding the stove quickly expands and rises to the ceiling, while the neighbouring air slides in to supply the place, nay is even pushed in by the air which goes outwards aloft. Thus the whole air is soon mixed, and the room acquires almost an equal temperature throughout.

The warming by stoves must therefore be managed upon very different principles from those adopted in the employment of open fires. The general principle is, *1<sup>st</sup>*, To employ the fuel in the most effectual manner for heating the external part of the stove, which is immediately efficient in warming the contiguous air; and, *2<sup>d</sup>*, To keep in the room the air already warmed, at least as much as is consistent with wholesomeness and cleanliness.

The first purpose is accomplished by conducting the flue of the furnace round its external parts, or, in short, by making every part of the flue external. Of all forms, that of a long pipe, returned backwards and forwards, up and down (provided only that the place of

Stove.

its last discharge be considerably higher than its entry from the fire-place), would be the most effectual. We have seen a very small stove constructed in this way, the whole being inclosed in a handsome case of polished iron plate, pierced and cut into elegant foliage like the cock of a watch, so that the odd looking pipes were completely concealed. Though only three feet long, one foot thick, and six feet high, it warmed a very lofty room of 24 feet by 18, and consumed less than half the fuel of a stove of the more usual make, which did not fully warm a smaller chamber.

It would occupy a volume to describe the immense variety of stoves which ingenuity or architectonic taste has constructed. We shall content ourselves with giving a specimen of the two chief classes into which they may be distinguished.

The air of a room may be equally warmed, either by applying it to the surface of a small stove made very hot, or to the surface of a much larger stove more moderately heated. The first kind is chiefly used in Holland, Flanders, and the milder climates of Germany and Poland. The last are universally used in the frozen climates of Russia and Sweden. The first are generally made of cast-iron, and the last of brick-work covered with glazed tiles or stucco.

Plate  
-ccclxxiv.

Fig. 1. represents a small German stove fully sufficient for warming a room of 24 feet by 18. The base is about three feet broad and 14 inches deep, that is, from back to front, and six or seven feet high. The decoration is in the fashion of that country; but the operative structure of it will admit of any style of ornament. A, is the fire-place, and the wood or charred coal is laid on the bottom, which has no bars. Bars would admit the air too freely among the fuel, and would both consume it too fast and raise too great a heat. That no heat may be uselessly expended, the sole of the fire-place and the whole bottom of the stove is raised an inch or two above the floor of the room, and the air is therefore warmed by it in succession, and rises upwards. For the same reason the back of the stove is not in contact with the wall of the room, or of the niche in which it is placed. The fire-place is shut up by a door which fits closely to its case, and has a small wicket at the bottom, whose aperture is regulated by a sliding plate, so as to admit no more air than what suffices for slowly consuming the fuel. The flame and heated air rise to the top of the fire-place three or four inches above the arch or mantle-piece, and get out laterally by two narrow passages B, B, immediately below the top plate of the base. The current bends downward on each side, passes at C, C, under the partition plates which divide the two side chambers, and then rises upwards through the outer division of each, and passes through narrow slits D, D, in the top plate, and from thence along the two hollow piers E, E. The two lateral currents unite at the top of the arch, and go through the single passage F into the larger hollow behind the escutcheon G. From this place it either goes straight upwards into the vent in the wall by a pipe on the top of the stove, or it goes into the wall behind by a pipe inserted in the back of the stove. The propriety of this construction is very obvious. The current of hot air is applied to exterior parts of the stove everywhere except in the two side chambers of the base, where the partition-plates form one side of

the canal. Even this might be avoided by making each of these side-chambers a detached hollow pillar. But this would greatly increase the trouble of construction and joining together, and is by no means necessary. The arch H has a graceful appearance, and affords a very warm situation for any thing that requires it, such as a drink in a sick person's bed-chamber, &c. Persons of a certain class use this place for keeping a dish warm; nay, the lower part of the arch is frequently occupied by an inclosed chamber, where the heat rises high enough even for dressing viands, as will be easily imagined when we reflect that the sole of it is the roof of the fire place.

The stove now described is supplied with fuel and with air by the front door opening into the room. That there may be room for fuel, this middle part projects a few inches before the two side chambers. These last, with the whole upper part of the stove, are not more than ten inches deep. The passages, therefore, from the fire-place are towards the back of it; so that if we have a mind to see the fire (which is always cheerful), the door may be thrown open, and there is no danger of the smoke coming out after the current has once warmed the upper part of the stove. When the stove is of such dimensions that the base is about two feet and a half or three feet high, the fire-place may be furnished with a small grate in the British style. If the door is so hung that it can not only be thrown back, but lifted off its hinges, we have a stove grate of the completest kind, fully adequate, in our mild climate, to warm a handsome apartment, even with an open fire; and when we hang on the door, and shut up the fire-place, a stove of the dimensions already given is almost too much for a large drawing-room.

We have frequently remarked, that one side of these stoves grows much warmer than the other, and that it was difficult to prevent or remedy this; and we imagine that this is an unavoidable defect in all stoves with a double flue. It is scarcely possible to make the fire so equable in the fire-place, that one side shall not be a little warmer than the other, and a brisker current will then be produced in it. This must increase the consumption of the fuel on this side, which will increase the current, will heat this side still more, and thus go on continually till the fuel on this side is expended; after which the other side will obtain and increase the superiority. The flue is made double, that the fire-place may occupy the middle of the front; and it will be difficult to gain this point of symmetry with one flue. The inconvenience may, however, be corrected by damping valves placed in some part of the upright funnels E, E.

In the colder winters on the continent, it is thought necessary to increase the effect by making the fire-place open to the back of the stove. Its mouth or door communicates with or is joined to an opening of the same dimensions formed in the wall, and the door is on the other side in an antichamber or lobby. In Westphalia, and other places of Germany, the apartments are disposed round a spacious lobby, into which all their fire-places open, and are there supplied with fuel. By this construction it is plain that the air of the room, already warmed by the stove, is not carried off, and the room is more heated. But this method is very unfavourable to cheerfulness and health. The same air confined, and repeatedly



Stove.

repeatedly breathed and compounded with all the volatile emanations of the room, quickly loses that refreshing quality that is so desirable, and even so necessary for health. It is never renewed except by very partial admixtures when the room doors are thrown open, and becomes disagreeable to any person coming in from the open air; and in the houses of the less opulent becomes really offensive and nauseous.

Something of this is unavoidable in all rooms heated by stoves. Even in our apartments in this island, persons of delicate nerves are hurt by what they call the close air of a room; and it is long before the smell of dinner is quite removed from a dining-room, notwithstanding the copious current up the chimney. This must be incomparably more sensible in a room heated by a stove; and this inconvenience is peculiarly sensible with respect to the stove which we are considering at present, where we employ a small surface heated to a great degree.

Such stoves are seldom made of any thing else than cast-iron. This (in those parts at least which are in immediate contact with the fuel) is in a state of continual calcination, and even throwing off scales. This indeed is not seen, because it is the bottom or sole of the fire-place which is so heated: but the effect on the air of the room is the same. The calcination of the iron is occasioned by the combination of pure vital air with the iron. This is abstracted from the general mass of atmospheric air in the room, of which it usually constitutes about  $\frac{2}{3}$ ths. By this abstraction the remainder becomes less fit for supporting animal life or flame, and may even become highly deleterious. In every degree the remainder becomes less refreshing, and grows dull and oppressive. This is always accompanied by a peculiar smell, which, though not disgusting, is unpleasant. It resembles the smell of burnt feathers, or more exactly the smell we feel if we rub violently for some time the palms of our hands together when perfectly dry.

For similar reasons these iron stoves occasion a sickly smell, by burning every particle of dust which falls on the hot parts; and if they be wiped with a woollen cloth, or any cloth not perfectly free from every kind of greasy or oily matter, a smell is produced for a day or days afterwards; so that without the most scrupulous attention we suffer by our very cleanliness.

For such reasons we think that the stoves of brick-work covered with stucco or with glazed tiles are vastly preferable. These are much used in the genteeler houses in Flanders and Holland, where they are made in the most elegant forms, and decorated with beautiful sculpture or enamel; but it is plain that they cannot be so effectual, nor equally warm a room with the same expense of fuel. Earthen ware, especially when covered with porous stucco, is far inferior to metal in its power of conducting heat. If built of bricks, they must be vastly more bulky when the fire-place and flues are of the same dimensions. The most perfect way of constructing them would certainly be to make them of pottery, in parts exactly fitted to each other, and joined by a proper cement. This mode of constructing would admit of every elegance of form or richness of ornament, and would not be so bulky as those which are built of bricks. The great difficulty is to prevent their crack-

Stove.

ing by the heat. Different parts of the stove being of very different heats, they expand unequally, and there is no cement which can withstand this, especially when we recollect that the same heat which expands the baked earth causes the clay or cement, with which the parts of the stove are put together or covered, to contract. Accordingly those earthen ware stoves seldom stand a winter or two without cracking in some place or other, even when strengthened by iron hoops and cramps judiciously disposed within them. Even hoopsing them externally, which would be very unsightly, will not prevent this; for nothing can resist the expansion and contraction by heat and cold. When a crack happens in a stove, it is not only unsightly, but highly dangerous; because it may be so situated, that it will discharge into the room the air vitiated by the fire.

For these and other reasons, we can scarcely hope to make stoves of brick-work or pottery which shall bear the necessary heat without cracking; and their use must therefore be confined to cases where very moderate heat is sufficient. We need not describe their construction. It is evident that it should be more simple than that of iron stoves; and we imagine that in the very few cases in which they are likely to be employed in this country, a single fire-place and an arch over it, divided, if we please, by a partition or two of thin tile to lengthen the flue, will be quite enough. If the stove is made in whole or in part of potters ware, a base for the fire-place, with an urn, column, obelisk, or pyramid above it, for increasing the surface, will also be sufficient. The failure commonly happens at the joinings, where the different pieces of a different heat, and perhaps of a different baking, are apt to expand unequally, and by working on each other one of them must give way. Therefore, instead of making the joints close and using any cement, the upper piece should stand in a groove formed in the undermost, having a little powdered chalk or clay sprinkled over it, which will effectually prevent the passage of any air; and room being thus given for the unequal expansion, the joint remains entire. This may be considered as a general direction for all furnace-work, where it is in vain to attempt to hinder the mutual working of the parts.

We have seen stoves in small apartments at St Petersburg, which were made internally of potters ware, in a great variety of forms, and then covered with a thick coat of stucco, finished externally with the utmost elegance of ornament, and we were informed that they were very rarely subject to crack. They did not give much heat, on account of the very low conducting power of the porous stucco; but we imagine that they would be abundantly warm for a moderate room in this country.

When fitted up in these situations, and with these precautions, the brick or pottery stoves are incomparably more sweet and pleasant than the iron ones.

But in the intense colds of Russia and Sweden, or even for very large rooms in this kingdom, stoves of these small dimensions are not sufficiently powerful, and we must follow the practice of those countries where they are made of great size, and very moderately heated. It is needless to describe their external form, which may be varied at pleasure. Their internal structure is the same in all, and is distinctly described in PNEUMATICS, n<sup>o</sup> 364. We shall only enlarge a little on the pecu-

**Stove.** peculiarities connected with the general principle of their construction.

The stove is intended as a sort of magazine, in which a great quantity of heat may be quickly accumulated, to be afterwards slowly communicated to the air of the room. The stove is therefore built extremely massive; and it is found that they are more powerful when coated with clay as wet as can be made to hang together. We imagine the reason of this to be, that very wet clay, and more particularly stucco, must be exceedingly porous when dry, and therefore a very slow conductor of heat. Instead of sticking on the glazed tiles with no more clay or stucco than is sufficient to attach them, each tile has at its back a sort of box baked in one piece about two or three inches deep. It is represented in fig. 2. This is filled with mortar, and then stuck on the brick-work of the stove, which has a great number of iron pins or hooks driven into the joints, which may sink into this clay and keep it firmly attached when dry. This coating, with the massive brick-work, forms a great mass of matter to be heated by the fuel. The lowest chamber, which is the fire-place, is somewhat wider, and considerably thicker than the stories above, which are merely flues. When the fire-place is finished and about to be arched over, a flat iron bar of small thickness is laid along the top of the side-wall on both sides, a set of finishing bricks being moulded on purpose with a notch to receive the iron bar. Cross bars are laid over these, one at each end and one or two between, having a bit turned down at the ends, which takes hold of the longitudinal bars, and keeps them from being thrust outwards either by the pressure of the arch or by the swelling in consequence of the heat. In fig. 3. A is the cross section of one of the long bars, and BC is part of one of the cross bars, and CD is the clench which confines the bar A. This precaution is chiefly necessary, because the contraction of the stove upwards obliges the walls of the other stories to bear a little on the arch of the fire-place. The building above is kept together in like manner by other courses of iron bars at every second return of the flue. The top of the stove is finished by a pretty thick covering of brick-work. The last passage for the air at H (see PNEUMATICS, fig. 62.) has a ring lining its upper extremity, and projecting an inch or two above it. The flat round it is covered with sand. When we would stop this passage, a cover shaped like a basin or cover for dishes at table is whelmed over it. The rim of this, resting on the sand, effectually prevents all air from coming through and getting up the vent. Access is had to this damper by a door which can be shut tight enough to prevent the heated air of the room from wafting itself up the vent. When the room is too warm, it may be very rapidly cooled by opening this door. The warm air rushes up with great rapidity, and is replaced by cool air from without.

The management of the stove is as follows. About eight o'clock in the morning the *pietchnik*, or servant who has the charge of the stoves, takes off the cover, shuts the damper-door, and opens the fire-place door. He then puts in a handful of wood shavings or straw, and kindles it. This warms the stove and vent, and begins a current of air through it. He then lays a few chips on the sole of the fire-place, immediately

**Stove.** within the door; and behind this he arranges the billets of birchwood, with their ends inwards. Then he lays on more wood in the front, till he thinks there is enough. He sets fire to the chips, shuts the door, and opens the small wicket at its bottom. The air blows the flame of the chips upon the billets behind them, and thus kindles them. They consume slowly, while the billets in front remain untouched by the fire. The servant, having made his first round of the rooms, returns to this stove, and opens the door above to admit air into the vent. This is to supply its draught, and thus to check the draught in the body of the stove, which is generally too strong at this time, and would consume the fuel too fast. By this time the billets in the front are burning, first at the bottom, and the rest in succession as they sink down on the embers and come opposite to the wicket. The room does not yet feel any effect from the fire, the heat of which has not yet reached its external surface; but in about half an hour this grows warm. The upper door is shut again, that no heat may now be wasted. The *pietchnik* by and by spreads the embers and ashes over the whole bottom of the fire-place with a rake, by which the bottom is greatly heated, and heats the air contiguous to it externally (for it stands on little pillars) very powerfully. He takes care to bring up to the top of the ashes every bit of wood or coal that is not yet consumed, that all may be completely expended. He does this as briskly as possible, that the room may not lose much warmed air by keeping open the fire-place door. At his last visit, when he observes no more glowing embers, he shuts the fire-place door and wicket, and puts the damper on the passage above, and shuts its door.—All this is over in about an hour and a half after kindling the fire. All current of air is now at an end within the stove, and it is now a great mass of brick-work, heated to a great degree within, but only about blood-warm externally. The heat gradually spreads outwards, and the external surface of the stove acquires its greatest heat about three o'clock in the afternoon; after which it gradually cools till next morning.

This heat seldom is so great that one cannot bear to touch the stove with his cheek, and to keep it there. In consequence of this it can burn none of the dust which unavoidably falls on the stove, and we are never troubled with the sickening smells that are unavoidable when we employ the small cast iron stoves much heated. The great expence of heat in a room arises from the glass windows. The pane is so thin that the external air keeps it continually cold, and thus the windows are continually robbing the air of the room of its heat. This expence of heat is reduced to less than one third by double casements. The inner casement is about as much colder than the room as the outer casement is warmer than the air of the fields; and we have the singular advantage of having no ice formed on the glasses. But to ensure this last advantage, the seams of the inner casement must be pasted with paper, and those of the outer casement must be left unpasted. If we do the contrary, we shall certainly have ice on the outer casement; the reason of which is easily seen.

We have been thus particular in our description of the management, because the reasons of some particulars are not very obvious, and the practice would not readily occur to us in this country; so that a person who, on the

Stove.

faith of our recommendation, should prefer one of these stoves to the German stove, whose management is simple and obvious, might be greatly disappointed. But by following this method, we are confident that the Russian stove will be found much superior both in warmth and agreeable air. The spreading out of the embers, and waiting till all is reduced to ashes before the doors are shut, is also absolutely necessary, and a neglect of it would expose us to imminent danger of suffocation by fixed air; and this is the only inconvenience of the Russian stove, from which the other stove is free. The fixed air has no smell; and the first indication of its presence is a slight giddiness and lassitude, which disposes us to sit down and to sleep. This would be fatal; and we must immediately open the upper passage and the fire-place door, so as to produce a strong current to carry the vitiated air of the room up the chimney. Throwing up the sashes, or at least opening all the doors, is proper on such an occasion.

If we burn pit-coal, either raw or charred, this precaution is still more necessary; because the cinder is not so easily or so soon completely consumed. This fuel will require a little difference in the management from wood fuel, but which is easily seen by any person of reflection. The safe way would be to rake out all half-burnt coal before shutting up the doors.

If we use raw pit-coal, great care is necessary to prevent the accumulation of soot in the upper part of the stove. It is an inaccessible place for the chimney sweep; and if we attempt to burn it out, we run a great risk of splitting that part of the stove which is the most slightly constructed. It is advisable therefore to burn it away every day, by giving a brisk draught with an open door for five minutes. With wood or coak there is no danger.

It will not be improper in this place to give some instructions for the construction of stoves for warming several floors in a great manufactory, such as a cotton-mill, or a public library or museum.

In such situations we think cleanliness, wholesomeness, and sweetness of air, no less necessary than in the drawing room of a man of opulence. We therefore recommend the brick-stove in preference to the iron one; and though it would not be the best or most economical practice to heat it but once a-day, and we should rather prefer the German practice of constant feeding, we still think it highly proper to limit the heat to a very moderate degree, and employ a large surface.

If the disposition of the rooms allows us the convenience of a thick party-wall, we would place the stove in the middle of this wall, in an arch which pierces through the wall. Immediately above this arch we would carry up a very wide chimney through the whole height. This chimney must have a passage opening into each floor on both sides, which may be very accurately shut up by a door. The stove being set up under the arch, it must have a pipe communicating with its flue, and rising up through this chimney. Could an earthen pipe be properly supported, and secured from splitting by hoops, we should prefer it for the reasons already given. But as this is perhaps expecting too much, we must admit the use of a cast iron pipe. This is the real chimney or flue of the stove, and must be of as great diameter as possible, that it may act, by an extensive surface, all the way up.

VOL. XVII. Part II.

Stove.

The stove stands under the arch in the wall; but the air that is warmed by its surface would escape on both sides, and would be expended in that single floor. To prevent this, the stove must be inclosed in a case: this may be of brick-work, at the distance of two or three inches from the stove all round. It must be well shut in above, and at the foundation must have a row of small holes to admit the air all around it. This air will then be warmed over the whole space between the stove and the case, pass up the chimney, and there receive additional heat from the flue-pipe which is in the middle. Great care must be taken that the fire-place door have no communication with the space between the stove and its case, but be inclosed in a mouth-piece which comes through the case, and opens into the feeding room. Thus all the air which goes up to the rooms will be pure and wholesome, provided we take care that every thing be kept clean and sweet about the air holes below. Observe that those air-holes which are near the furnace door must be inclosed in a wooden trunk which takes in its air at some distance from this door; for since the current between the stove and case may be almost as great as the current within the stove (nay, when a puff of wind beats down the chimney, it may even exceed it), there is a risk of some vitiated air and smoke being drawn into the case.

If the stove cannot be placed in the arch of a party-wall, it may be set adjoining to a side or outer wall, and furnished with a case, a large chimney, and a flue-pipe, in the same manner. But in this case a great deal of heat is wasted on this outer wall, and carried off by the external air. In this situation we would recommend to line that part of the wall which is behind the stove (at two or three inches distance), and the whole of the chimney, with plaster on laths. These should be nailed on battens properly fastened on the wall, leaving a space of an inch between the laths and the wall. The plaster should be of the most spongy kind, having in it a quantity of clay in powder instead of the full proportion of sand. Horse-dung, washed with water and strained through coarse flannel, leaves a great portion of unassimilated vegetable fibre, which will mix very intimately in the plaster, and make it a substance very unfit for conducting heat. There is no danger of catching fire by this lining. We have seen a most tremendous fire rage for three hours, in contact with a partition of lath and plaster (on the plaster-side however), without discolouring the thin laths on the other side. We once saw a cottage chimney on fire, and burn till the soot was consumed. This chimney was nothing but a pipe of a foot wide, made of laths, and plastered on the inside and outside; and it passed through a thatched roof. We therefore recommend this in place of the brick-case for inclosing the stove. It would save heat; and as it might be made in pieces on detached frames, which could be joined by iron straps and hinges, any part of the stove could be laid open for repairs at pleasure.

We have no hesitation in saying that a stove constructed in this manner would be greatly superior in power to any we have seen, and would be free from many of their disgusting defects. We beg leave therefore to conclude this part of the subject by describing one which was to have been erected in one of the churches of the city of Edinburgh.

Fig. 4. is a sketch of the plan of the church contain-

Stove.

ed in the parallelogram AFED. P marks the place of the pulpit, and LMNO the front of the galleries. These are carried back to the side walls AB and DC. But at the end opposite to the pulpit they do not reach so far, but leave a space BFEC about 12 feet wide. Below the back of the galleries, on each side, there is a passage ABGH, KICD, separated from the seated part of the church by partitions which reach from the floor to the galleries, so that the space HGIK is completely shut in. The church is an ancient Gothic building, of a light and airy structure, having two rows of large windows above the arcades, and a spacious window in the east end above the pulpit. The congregation complain of a cold air, which they feel pouring down upon their heads. This is more particularly felt by those sitting in the fronts of the galleries. We imagine that this arises chiefly from the extensive surface of the upper row of windows, and of the cold stone-walls above, which robs the air of its heat as it glides up along the sides of the church. It becomes heavier by collapsing, and in this state descends in the middle of the church.

The stove S is placed against the middle of the west wall at the distance of a few inches, and is completely inclosed in a case of lath and plaster. The vent, which is to carry off the smoke and burnt air, is conveyed up or along the wall, and through the roof or side-wall, but without any communication with the case. In like manner the fire-place door is open to the passage, without communicating with the case; and care is taken that the holes which admit the air into the case are so disposed that they shall run no risk of drawing in any air from the fire-place door.

From the top of this case proceed two trunks Q, R, each of which is two feet broad and six inches deep, coated within and without with the most spongy plaster that can be composed. For this purpose we should recommend a composition of powdered charcoal and as much clay and quicklime as will give it a very slight cohesion. We know that a piece of this may be held in the hand, without inconvenience, within an inch of where it is of a glowing red heat.—These trunks open into another trunk XVTYZ, which ranges along the partition immediately under the galleries, and may be formed externally into a cornice, a little massive indeed, but not unsightly in a building of this style. This trunk is coated in the same manner. It has several openings a, a, &c. which have sliders that can be drawn aside by means of handles accessible from the outer passage.—At the extremities X and Z of this trunk are two perpendicular trunks which come up through the galleries, and are continued to a considerable height. At their junction with the horizontal trunk are two doors large enough to admit a lamp. Each perpendicular trunk has also a valve by which it can be completely stopped.

The stove is managed as follows: Early in the morning the superintendant shuts all the sliders, and sets a lamp (burning) in each of the trunks X and Z, and shuts the doors. He then puts on and kindles the fire in the stove, and manages it either in the Russian or German method. Perhaps the latter is preferable, as being liable to fewer accidents from mistake or neglect.

The lamps set in the lower ends of the upright trunks presently warm them, and produce a current of air upwards. This must be supplied by the horizontal trunk,

which must take it from the case round the stove. Thus a current is begun in the direction we wish. By and by the air in the case acquires heat from the stove, and the current becomes extremely brisk. When the manager perceives this, he removes the lamps, shuts the valves, and opens the holes a, a, &c. beginning with the most remote, and proceeding slowly towards the stove from each extremity of the horizontal branches. The heated air now issues by these holes, glides along the ceiling below the galleries, and escapes, by rising up along the fronts of the galleries, and will be sensibly felt by those sitting there, coming on their faces with a gentle warmth. It will then rise (in great part) straight up, while some of it will glide backwards, to the comfort of those who sit behind.

The propriety of shutting the valves of the upright trunks is evident. If they were left open, no air would come out by the holes a, a, &c.; but, on the contrary, the air would go in at these holes to supply the current, and the stove be rendered useless. The air delivered by these holes will keep close to the ceiling, and will not, as we imagine, incommode those who sit below the galleries. But if it should be found to render these parts too warm, holes may be pierced through the ceiling, by which it will rise among the people above, and must be very comfortable. It will require the careful attention of some intelligent person to bring all this into a proper train at first, by finding the proper apertures of the different holes, so as to render the heat equable through the whole space. But this being once ascertained the difficulty is over.

The air trunks must be very capacious, but may be contracted towards the extremities as their lateral discharges diminish; and the row of holes which admit the air to the case round the stove must be fully able to supply them.

It must be observed, that in this construction the ascensional force is but small. It is only the height of a short column of warm air from the ground to the galleries. At first indeed it is great, having the unlimited height of the perpendicular trunks at X and Z; but during the use of the stove it is reduced to nine or ten feet. It is necessary, therefore, that the stove be highly heated, perhaps considerably beyond the Russian practice, but yet inferior to the heat of the German iron stoves. But still we strongly recommend the brick or pottery stoves, on account of the wholesome sweetness of the air which they furnish; and we are certain that a stove of moderate dimensions, eight feet long, for instance, by eight feet high, will be sufficient for warming a church holding 1200 or 1500 people. If the stove could be placed lower, which in many situations is very practicable, its effect would be proportionally greater, because all depends on the rapidity of the current. When we are limited in height, we must extend the stove so much the more in length, and make the air trunks more capacious. These and many other circumstances of local modification must be attended to by the erector of the stove; and without the judicious attention of an intelligent artist, we may expect nothing but disappointment. It is hardly possible to give instructions suited to every situation; but a careful attention to the general principle which determines the ascensional force will free the artist from any great risk of failure.

Stove.

Stove,  
Stour-  
bridge.

We may say the same thing of stoves for conservatories, hot houses, hot walls, &c. and can hardly add any thing of consequence to what we have already said on these heads in the article PNEUMATICS.

We must not, however, dismiss the subject without taking notice of the very specious projects which have been frequently offered for drying malt by stoves. Many of these are to be seen in the publications of the Academies of Stockholm, Upsal, Copenhagen, and some have been erected in this kingdom; but they have not been found to answer.

We apprehend that they cannot answer. To dry malt, and make it fit for the ales and beers for which this island is so famous, it is by no means enough that we give it a proper and an equable supply of heat.— This alone would bake it and make it stinty, causing the moisture to penetrate the mealy particles of the grain; and, by completely dissolving the soluble parts, would render each kernel an uniform mass, which would dry into a stinty grain, breaking like a piece of glass.— A grain of malt is not an inert pulp. It is a SEED, in an active state, growing, and of an organized structure. We wish to stop it in this state, and kill it, not by heating it, but by abstracting its moisture. We thus leave it in its granulated or organized form, spongy, and fit for imbibing water in the mash tub, without running into a paste.

To accomplish these purposes, the construction of our malt kilns seems very well adapted. The kiln is the only flue of the furnace, and a copious current of air is formed through among the grains, carrying off with it the water which is evaporating by the heat. But this evaporation, being chiefly in consequence of the vapour being immediately dissolved by the passing air, will stop as soon as the current of air stops. This current has to make its way through moist grain, laid in a pretty thick bed, and matted together. Some force, therefore, is necessary to drive it through. This is furnished by the draught of the kiln. Substituting a stove, immediately applied to the malt, will not have this effect. The only way in which we think this can be done different from the present, is to have a horizontal flue, as has been proposed in these projects, spread out at a small distance below the grate on which the malt is laid, and to cover the whole with a high dome, like a glass house dome. This being filled with a tall column of hot air, and having no passage into it but through the malt, would produce the current which we want. We are convinced that this will make much less fuel serve; but we are by no means certain that the sulphureous and carbonic acid which accompanies the air in our common kiln is not a necessary or a useful ingredient in the process. It is well known that different coaks, cinders, or charcoals, impart different qualities to the malts, and are preferred *each for its own purpose*. Were this a matter of indifference, we know a method of rapidly drying malt much more economical and expeditious than by either kiln or stove. But this has nothing to do with our present subject, of which we now take leave.

STOURBRIDGE, or STURBICH, the name of a field near Cambridge, noted for its famous fair kept annually on the 7th of September, and which continues for a fortnight. The commodities are, horses, hops, iron, wool, leather, cheese, &c. This place is also noted for an excellent species of clay capable of resist-

ing an intense heat. It is used in making pots for glass-houses, fire-bricks, &c. and is sold at an high price.

STOW, the name of a market-town in Gloucestershire in England, situated in W. Long 1. 50. N. Lat. 51. 54. It is also the name of a fine seat of the Marquis of Buckingham in Buckinghamshire. Here are the best gardens in England, adorned with busts, statues, obelisks, pavilions, and temples. It is two miles from the town of Buckingham.

STOW (John), the industrious historian, son of Thomas Stow merchant taylor of St Michael's, Cornhill, in London, was born about the year 1525. Of the early part of his life we know very little, except that he was bred to his father's business, which in the year 1560 he relinquished, devoting himself entirely to the study of our ancient historians, chronicles, annals, charters, registers, and records. Of these he made a considerable collection, travelling for that purpose to different parts of the kingdom, and transcribing such manuscripts as he could not purchase. But this profession of an antiquary being attended with no present emolument, he was obliged for subsistence to return to his trade.— It happened, however, that his talents and necessities were made known to Dr Parker archbishop of Canterbury; who being himself an antiquary, encouraged and enabled Mr Stow to prosecute his darling study. In those times of persecution, though Elizabeth was then upon the throne, honest John Stow did not escape danger. His collection of Popish records was deemed cause of suspicion. His younger brother Thomas preferred no less than 140 articles against him before the ecclesiastical commission; but the proof being insufficient, he was acquitted. In 1565 he first published his Summary of the Chronicles of England. About the year 1581 he began his Survey of London. In 1585 he was one of the two collectors for a great muster of Limestreet ward: in the same year he petitioned the corporation of London to bestow on him the benefit of two freemen, to enable him to publish his survey; and in 1589 he petitioned again for a pension. Whether he succeeded, is not known. He was principally concerned in the second edition of Holinshed's chronicle, published in 1587. He also corrected, and twice augmented, Chaucer's works, published in 1561 and in 1597. His survey of London was first published in 1598. To these laborious works he would have added his large Chronicle, or History of England; but he lived only to publish an abstract of it, under the title of *Flores Historiarum*. The folio volume, which was printed after his death, with the title of *Stow's Chronicle*, was taken from his papers by Edmund Howes. Having thus spent his life and fortune in these laborious pursuits, he was at last obliged to solicit the charitable and well disposed for relief. For this purpose, king James I. granted him, in 1603, a brief, which was renewed in 1604, authorising him to collect in churches the benefactions of his fellow-citizens. He died in April 1605, aged 80; and was buried in his parish church of St Andrews, Underbass, where his widow erected a decent monument to his memory. John Stow was a most indefatigable antiquarian, a faithful historian, and an honest man.

STOWMARKET, a town of Suffolk, in England, situated in E. Long. 1. 6. N. Lat. 52. 16. It is a large

Stow  
||  
Stow-  
market.

Stowage  
||  
Strabo.

handsome place, situated between the branches of the rivers Gypping and Orwell, and is remarkable for having the best cherries in England.

**STOWAGE**, the general disposition of the several materials contained in a ship's hold, with regard to their figure, magnitude, or solidity.

In the stowage of different articles, as ballast, casks, cases, bales, and boxes, there are several general rules to be observed, according to the circumstances or qualities of those materials. The casks which contain any liquid are, according to the sea phrase, to be *burg-up* and *bilge-free*, i. e. closely wedged up in an horizontal position, and resting on their quarters: so that the bilges where they are thickest being entirely free all round, cannot rub against each other by the motion of the vessel. Dry goods, or such as may be damaged by the water, are to be carefully inclosed in casks, bales, cases, or wrappers; and wedged off from the bottom and sides of the ship, as well as from the bow, masts, and pump-well. Due attention must likewise be had to their disposition with regard to each other, and to the trim and centre of gravity of the ship; so that the heaviest may always be nearest the keel, and the lightest gradually above them.

**STRABISMUS**, squinting. See *MEDICINE-Index*.

**STRABO**, a celebrated Greek geographer, philosopher, and historian, was born at Amasia, and was descended from a family settled at Gnosus in Crete. He was the disciple of Xenarchus, a Peripatetic philosopher, and at length attached himself to the Stoics. He contracted a strict friendship with Cornelius Gallus, governor of Egypt, and travelled into several countries to observe the situation of places, and the customs of nations. He flourished under Augustus, and died under Tiberius about the year 25, in a very advanced age.— He composed several works, all of which are lost except his Geography in 17 books; which are justly esteemed very precious remains of antiquity. The two first books are employed in showing, that the study of geography is not only worthy of, but even necessary to, a philosopher; the third describes Spain; the fourth, Gaul and the Britannic isles; the fifth and sixth, Italy and the adjacent isles; the seventh, which is imperfect at the end, Germany, the countries of the Getæ and Illyrii, Taurica Chersonesus, and Epirus; the eighth, ninth, and tenth, Greece with the neighbouring isles; the four following, Asia within Mount Taurus; the fifteenth and sixteenth, Asia without Taurus, India, Persia, Syria, Arabia; and the seventeenth, Egypt, Æthiopia, Carthage, and other places of Africa. Strabo's work was published with a Latin version by Xylander, and notes by Isaac Casaubon (or rather by Henry Scrimzeer, from whom Casaubon chiefly stole them), at Paris, 1620, in folio. But the best edition is that of Amsterdam in 1707, in two volumes folio, by the learned Theodore Janfowius ab Almelooveen, with the entire notes of Xylander, Casaubon, Meurfius, Cluver, Holstenius, Salmassius, Bochart, Ez. Spanheim, Cellarius, and others. To this edition is subjoined the *Chrestomathia*, or epitome of Strabo; which according to Mr Dodwell, who has written a very elaborate and learned dissertation about it, was made by some unknown person between the years of Christ 676 and 996. It has been found of some use, not only in helping to correct the original, but in supplying in some measure the

defect in the seventh book. Mr Dodwell's dissertation is prefixed to this edition.

**STRADA** (Famianus), a very ingenious and learned Jesuit, was born at Rome the latter end of the 16th century, and taught rhetoric there, in a public manner, for fifteen years. He wrote several pieces upon the art of oratory, and published some orations with a view of illustrating by example what he had inculcated by precept. But his *Profusiones Academicæ* and his *Historia de Bello Belgico* are the works which raised his reputation, and have preserved his memory. His history of the war of Flanders was published at Rome; the first deced in 1642, the second in 1647; the whole extending from the death of Charles V. which happened in 1558, to the year 1590. It is written in good Latin, as all allow; but its merit in other respects has been variously determined. His *Profusiones Academicæ* show great ingenuity, and a masterly skill in classical literature; that profusion especially in which he introduces Lucan, Lucretius, Claudian, Ovid, Statius, and Virgil, each of them versifying according to his own strain. They have been often printed. We know not the year of Strada's birth or of his death.

**STRAHAN** (William), an eminent printer, was born at Edinburgh in the year 1715. His father, who had a small appointment in the customs, gave his son the education which every one of decent rank then received in a country where the avenues to learning were easy, and open to men of the most moderate circumstances. After having passed through the tuition of a grammar-school, he was put apprentice to a printer; and when a very young man, removed to a wider sphere in that line of business, and went to follow his trade in London. Sober, diligent, and attentive, while his emoluments were for some time very scanty, he contrived to live rather within than beyond his income; and though he married early, and without such a provision as prudence might have looked for in the establishment of a family, he continued to thrive, and to better his circumstances. This he would often mention as an encouragement to early matrimony; and used to say, that he never had a child born that Providence did not send some increase of income to provide for the increase of his household. With sufficient vigour of mind, he had that happy flow of animal spirits that is not easily discouraged by unpromising appearances.

His abilities in his profession, accompanied with perfect integrity and unabating diligence, enabled him, after the first difficulties were overcome, to advance with rapid success. And he was one of the most flourishing men of the trade, when, in the year 1770, he purchased a share of the patent for king's printer of Mr Eyre, with whom he maintained the most cordial intimacy during the rest of his life. Beside the emoluments arising from this appointment, as well as from a very extensive private business, he now drew largely from a field which required some degree of speculative sagacity to cultivate on account of the great literary property which he acquired by purchasing the copy-rights of the most celebrated authors of the time. In this his liberality kept equal pace with his prudence, and in some cases went perhaps rather beyond it. Never had such rewards been given to the labours of literary men as now were received from him and his associates in those purchases of copy-rights from authors.

Having

Strada,  
Strabon.

Strahan.

Having now attained the first great object of business, wealth, Mr Strahan looked with a very allowable ambition on the stations of political rank and eminence. Politics had long occupied his active mind, which he had for many years pursued as his favourite amusement, by corresponding on that subject with some of the first characters of the age. Mr Strahan's queries to Dr Franklin in the year 1769, respecting the discontents of the Americans, published in the London Chronicle of 28th July 1778, show the just conception he entertained of the important consequences of that dispute, and his anxiety as a good subject to investigate, at that early period, the proper means by which their grievances might be removed, and a permanent harmony restored between the two countries. In the year 1775 he was elected a member of parliament for the borough of Malmesbury in Wiltshire, with a very illustrious colleague, the Hon. C. J. Fox; and in the succeeding parliament, for Wootton Bassett, in the same county. In this station, applying himself with that industry which was natural to him, he was a useful member, and attended the house with a scrupulous punctuality. His talents for business acquired the consideration to which they were intitled, and were not unnoticed by the minister.

In his political connections he was constant to the friends to whom he had first been attached. He was a steady supporter of that party who were turned out of administration in spring 1784, and lost his seat in the house of commons by the dissolution of parliament with which that change was followed: a situation which he did not show any desire to resume on the return of the new parliament; arising from a feeling of some decline in his health, which had rather suffered from the long sittings and late hours with which the political warfare in the preceding had been attended. Without any fixed disease, his strength visibly declined; and though his spirits survived his strength, yet the vigour and activity of his mind were also considerably impaired. Both continued gradually to decline till his death, which happened on the 9th of July 1785 in the 71st year of his age.

Endued with much natural sagacity, and an attentive observation of life, he owed his rise to that station of opulence and respect which he attained, rather to his own talents and exertion, than to any accidental occurrence of favourable or fortunate circumstances. His mind was not uninformed by letters; and from a habit of attention to style, he acquired a considerable portion of critical acuteness in the discernment of its beauties and defects. In one branch of writing he particularly excelled—the epistolary; in which he not only showed the precision and clearness of business, but possessed a neatness as well as a fluency of expression which few letter-writers have been known to surpass. Letter-writing was one of his favourite amusements; and among his correspondents were men of such eminence and talents as well repaid his endeavours to entertain them. Among these, as before-mentioned, was the justly celebrated Dr Franklin, originally a printer like Mr Strahan, whose friendship and correspondence, notwithstanding the difference of their sentiments in political matters, he continued to enjoy till his death. One of the latest letters which he received from his illustrious and venerable friend, contained a humorous allegory of the state

of politics in Britain, drawn from the profession of printing; of which, though the Doctor had quitted the exercise, he had not forgotten the terms.

The judicious disposition which Mr Strahan made of his property, affords an evident proof of his good sense and propriety. After providing munificently for his widow and children, his principal study seems to have been to mitigate the affliction of those (and many there were) who would more immediately have felt his loss, by bequeathing them liberal annuities for their lives; and (recollecting that all of a profession are not equally provident) he left 1000 l. to the Company of Stationers, the interest to be divided among infirm old printers.

As the virtuous connections of the life and the heart are always pleasing to trace—of Mr Strahan it may briefly be said, that his capacity, diligence, and probity, raised him to the head of his profession. The good humour and obliging disposition which he owed to nature, he cultivated with care, and confirmed by habit. His sympathetic heart beat time to the joy and sorrow of his friends. His advice was always ready to direct youth, and his purse open to relieve indigence. Living in times not the purest in the English annals, he escaped unscathed through the artifices of trade and the corruption of politics. In him a strong natural sagacity, improved by an extensive knowledge of the world, served only to render respectable his unaffected simplicity of manners, and to make his Christian philanthropy more discerning and useful. The uninterrupted health and happiness which accompanied him for half a century in the capital, proves honestly to be the best policy, temperance the greatest luxury, and the essential duties of life its most agreeable amusement. In his elevated fortune, none of his former acquaintance ever accused him of neglect. He attained prosperity without envy, enjoyed wealth without pride, and dispensed bounty without ostentation.

**STRAIKS**, in the military art, are strong plates of iron, six in number, fixed with large nails called *straike-nails*, on the circumference of a cannon-wheel, over the joints of the fellows; both to strengthen the wheel, and to save the fellows from wearing on hard ways or streets.

**STRAIN**, a pain occasioned by the violent extension of some membranous or tendinous part.

**STRAIN**, *Stress*, in mechanics, are terms indiscriminately used to express the force which is *exerted* in any part of a machine or structure of any kind tending to break it in that part. Thus every part of a rope is *equally* strained by the weight which it supports. Every part of a pillar is *equally* strained by the load which it supports. A mill axle is *equally* twisted and strained in every part which lies between the part of the wheel actuated by the moving power and the part which is resisted by the work to be performed. Every part of a lever or joint is *different* strained by a force acting on a distant part.

It is evident that we cannot make the structure fit for its purpose, unless the strength in every part be at least equal to the stress laid on, or the strain excited in that part. It is no less plain, that if we are ignorant of the principles which determine this strain, both in intensity and direction, in relation to the magnitude and the situation of its remote cause, the only security we have for success is to give to every part of the assemblage

Strahan  
||  
Strain.

Strain  
||  
Strain.

blage such solidity that we can leave no doubt of its sufficiency. But daily experience shows us that this vague security is in many cases uncertain, if we are thus ignorant. In all cases it is slovenly, unlike an artist, attended with useless expence, and in machines is attended with a loss of power which is wasted in changing the motions of a needless load of matter.

It must therefore greatly tend to the improvement of all professions occupied in the erection or employment of such structures to have a distinct notion of the strains to which their parts are exposed. Frequently, nay generally, these strains are not immediate, but arise from the action of forces on distant parts, by which the assemblage is strained, and there is a tendency to rupture in every part. This strain is *induced* on every part, and is there modified by fixed mechanical laws. These it is our business to learn; but our chief object in this investigation is to determine the strength of materials which it is necessary to oppose in every part to this strain; and how to oppose this strength in such a manner that it shall be exerted to the best advantage. The notions of strain and strength therefore hardly admit of separation; for it is even by means of the strength of the intermediate parts that the strain is propagated to, or excited in, the part under consideration. It is proper therefore to consider the whole together under the article *STRENGTH of Materials* in mechanics.

*STRAINING*, is the clarification of a liquor, by passing it through a sieve or filter. The word is derived from the French, *estreindre*; which is formed from *ex*, "out of," and *stringere*, "to press."

*STRAIT*, a narrow channel or arm of the sea, shut up between lands on either side, and affording a passage out of one great sea into another.

There are three kinds of straits. 1. Such as join one ocean to another. Of this kind are the straits of Magellan and Le Maire. 2. Those which join the ocean to a gulf: the straits of Gibraltar and Babelmandel are of this kind, the Mediterranean and Red Sea being only large gulfs. 3. Those which join one gulf to another; as the straits of Caffa, which join the Palus Mæotis to the Euxine or Black Sea. The passage of straits is commonly dangerous, on account of the rapidity and opposite motion of currents. The most celebrated strait in the world is that of Gibraltar, which is about from 24 to 35 miles long, and from 15 to 24 broad, joining the Mediterranean sea with the Atlantic ocean. The straits of Magellan, discovered in 1520 by F. Magellan, were used some time as a passage out of the North into the South Sea; but since the year 1616, that the strait of Le Maire has been discovered, the former has been disused; both because of its length, which is full three hundred miles, and because the navigation thereof is very dangerous, from the waves of the North and South Seas meeting in it and clashing. The strait at the entrance of the Baltic is called the *Sound*. That between England and France, *Le pas de Calais*, or the *Channel*. There are also the straits of Weigats, of Jesso, of Anian, of Davis, and Hudson, &c.

*STRAKES*, or *STREAKS*, in a ship, the uniform

ranges of planks on the bottom and sides of a ship, or the continuation of planks joined to the ends of each other, and reaching from the stem to the stern-post and fashion-pieces; the lowest of these, which is called the *garboard-streak*, is let into the keel below, and into the stem and stern-post. They say also a ship *heels a strake*, that is, hangs or inclines to one side the quantity of a whole plank's breadth.

*STRAKES*, or *streaks*, in mining, are frames of boards fixed on or in the ground, where they wash and dress the small ore in a little stream of water, hence called *straked ore*.

*STRALSUND*, a strong and rich sea-port town of Germany, in Hither Pomerania, and was formerly an important trading-place. In 1678 it was forced to surrender to the elector of Brandenburg, after 1800 houses had been burnt to ashes in one night's time. After this the Swedes defended it to the last extremity; and Charles XII. in 1714, came hither after its return out of Turkey. But the crown of Sweden not being able to hold out against five great powers, it was forced to submit in 1715. In 1720 it was rendered back to Sweden, but in a very poor condition. It is almost surrounded by the sea and the lake Francen, and has a harbour separated from the isle of Rugen by a narrow strait. It is 15 miles north-west of Grippswald, and 40 north-east of Gullrow. E. Long. 13. 28. N. Lat. 54. 17.

*STRAMONIUM*, in botany; a species of *Datura*.

*STRAND* (*Saxon*), any shore or bank of a sea or great river. Hence the street in the west suburbs of London, which lay next the shore or bank of the Thames, was called the *Strand*. An immunity from custom, and all impositions upon goods or vessels by land or water, was usually expressed by *strand* or *stream*.

*STRANDED* (from the Saxon *strand*), is when a ship is by tempest, or by ill steering, run on ground, and so perishes. Where a vessel is stranded, justices of the peace, &c. shall command constables near the sea-coasts to call assistance for the preservation of the ship; and officers of men of war are to be aiding and assisting thereto.

*STRANGE* (Sir Robert), who carried the art of engraving to so great perfection in this country, was a man of such general merit, that a life of him, not merely estimating his character as an artist, but also portraying his private virtues and domestic habits, would be both useful and entertaining. Such a life, we have reason to believe, will be presented to the public. Modest as he was ingenious, he used indeed to say that the works of an artist should serve for a life and monument to him. His works no doubt will perpetuate his name whilst any taste for the fine arts remains. In the mean time, we cannot but here give a short sketch of his history, the accuracy of which may be depended on.

Sir Robert Strange was born in the island of Pomona in Orkney, July the 14th 1721; and died at London July the 5th 1792. He was lineally descended from David Strange or Strang, a younger son of the family of the Stranges or Strangs (A) of Balcaisky, in the county

Strakes  
||  
Strange.

(A) The name of *Strange* or *Strang* is indiscriminately used in the old charters and deeds of the Balcaisky family, now in the possession of Sir Robert Anstruther of Balcaisky, baronet.



*Strange.* ty of Fife, who settled in Orkney at the time of the Reformation. But as there were no males remaining of the elder branch of the Stranges of Balcauky, Sir Robert became the male representative of it, and was found by a legal investigation to have a right to the armorial bearings and every other mark of honour belonging to that ancient family.

He received his classical education at Kirkwall in Orkney under the care of a learned, worthy, and much respected gentleman, Mr Murdoch Mackenzie, still alive (1795), who has rendered infinite service to his country by the accurate surveys and charts he has given of the islands of Orkney and of the British and Irish coasts.

Originally intended for the law, Mr Strange soon became tired of that profession, and perceived that his genius decisively led him to the arts of drawing and engraving. For this purpose he was introduced to the late Mr Richard Cooper at Edinburgh, the only person there who had then any taste in that line of the fine arts. He was bound with him as an apprentice for six years; during which time he made such progress in his new profession, that his friends entertained the highest expectation of his success; nor were they disappointed.

In the year 1747 he married Isabella, only daughter of William Lumisden, son of Bishop Lumisden; and soon after his marriage he went to France, where with the most ardent application he prosecuted his studies, chiefly at Paris, under the direction of the celebrated Le Bas, who engraved many excellent prints from the Dutch painters. It was from Le Bas he had the first hint of the use of the instrument commonly called *the dry needle*; but which he afterwards greatly improved by his own genius, and which has added such superior beauties to his engravings.

In the year 1751 Mr Strange removed with his family from Edinburgh and settled at London, where he engraved several fine historical prints, which justly acquired to him great reputation. At this period historical engraving had made little progress in Britain, and he may be properly considered as its father.

The admiration he always had for the works of the great Italian painters made him long desire to visit Italy, the seat of the fine arts; and the farther he advanced in life, he became the more persuaded that a journey to that country was essential to an artist who had the laudable ambition to excel in his profession. He therefore undertook this journey in the year 1760. In Italy he made many admirable drawings, several of which he afterwards engraved. These drawings are now in the possession of Lord Dundas.

Everywhere in Italy singular marks of attention were bestowed on Mr Strange; not only by great personages, but by the principal academies of the fine arts in that country. He was made a member of the academies of Rome, Florence, and Bologna, and professor in the royal academy at Parma.

To show the estimation in which his talents were held

at Rome, we cannot but record the following anecdote. The ceiling of the room of the Vatican library, in which the collection of engravings are kept, is elegantly painted by Signor Rotfanelli. It represents the progress of engraving; and the portraits of the most eminent artists in that line are there introduced, among which is that of our artist. Under his arm he holds a portfolio, on which his name is inscribed. He is the only British artist on whom this honour has been conferred.

In France, where he resided many years at different periods, his talents likewise received every mark of attention that could be bestowed on a foreigner. He was made a member of the royal academy of painting at Paris.

His majesty King George III. ever attentive to the progress of the fine arts in Britain, and sensible of the advantages of which engraving particularly has been to this country, even in a commercial light; and desirous to give a mark of his royal approbation of the merit of Mr Strange, whom he considered as at the head of his profession and the great improver of it—was graciously pleased to confer the honour of knighthood on him the 5th of January 1787.

Such was Sir Robert Strange as an artist; nor was he less distinguished by his truly amiable moral qualities, which endeared him to all who had the happiness to know him.

With regard to his works, he left fifty capital plates, still in good condition, which are carefully preserved in his family. They are engraved from pictures by the most celebrated painters of the Roman, Florentine, Lombard, Venetian, and other schools. They are historical, both sacred and profane, poetical, allegorical.

From his earliest establishment in life, Sir Robert carefully preserved about eighty copies of the finest and most choice impressions of each plate he engraved; which, from length of time, have acquired a beauty, mellowness, and brilliancy, easier seen than described. He did this with a view of presenting them to the public at a period when age should disable him from adding to their number. These he collected into as many volumes, and arranged them in the order in which they were engraved. To each volume he prefixed two portraits of himself, on the same plate, the one an etching, the other a finished proof, from a drawing by John Baptiste Greuse. This is the last plate he engraved; and which is a proof that neither his eyes nor hand were impaired by age. It likewise shows the use he made both of aquatortis and the graver. Each volume, besides a dedication to the king, contains an introduction on the progress of engraving, and critical remarks on the pictures from which his engravings are taken. These volumes were ready to be given to the public, when Sir Robert's death and consequent circumstances delayed this magnificent publication; a publication which does so much honour to the artist, and to the country which gave him birth (B)

STRANGER;

(B) Solicitous to make all our biographical articles the vehicles of truth, and particularly desirous to do justice to the memory of our illustrious countryman Sir Robert Strange, we applied for information respecting him to the person whom we considered as the most capable of furnishing it, and to whom we imagined that our application would be in a high degree grateful. With some difficulty we obtained, as a favour to ourselves, the sketch

Stranger  
||  
Strasbourg

**STRANGER**, in law, denotes a person who is not privy or party to an act. Thus a stranger to a judgment is he to whom a judgment does not belong; in which sense the word stands directly opposed to party or privy.

**STRANGLES**, in FARRIERY. See that article, § xiv.

**STRANGURY**, a suppression of urine. See MEDICINE, u<sup>o</sup> 119

**STRAP**, among surgeons, a sort of band used to stretch out limbs in the setting of broken or disjointed bones.

**STRAP**, in a ship, the rope which is spliced about any block, and made with an eye to fasten it anywhere on occasion.

**STRAPS**, in the manege. The straps of a saddle are small leather straps, nailed to the bows of the saddle, with which we make the girths fast to the saddle.

**STRAPADO**, or **STRAPPADO**, a kind of military punishment, wherein the criminals hands being tied behind him, he is hoisted up with a rope to the top of a long piece of wood, and let fall again almost to the ground; so that, by the weight of his body in the shock, his arms are dislocated. Sometimes he is to undergo three strapadoes or more.

**STRASBURG**, an ancient, large, handsome, populous, and strong city of France in Alsace. It contains about 200 streets, part of which are very narrow, and most of the houses are built after the ancient taste. However, there are a great number of handsome buildings, such as the hotel of the marshal of France, who is commander of the city; the hotel of the cardinal of Rouen, the bishops palace, the Jesuits college, the royal hospital, the hotel of Hesse-Darmstadt, the arsenal, the

town-house, and the cathedral. It has a wooden bridge over the Rhine, which is thought to be one of the finest in Europe; as is likewise the cathedral church, whose tower is the handsomest in Germany, and the clock is greatly admired by all travellers. Some look upon it as one of the wonders of the world, and the steeple is allowed to be the highest in Europe. The clock not only shows the hours of the day, but the motion of the sun, moon, and stars. Among other things there is an angel, which turns an hour-glass every hour; and the twelve apostles proclaim noon, by each of them striking a blow with a hammer on a bell. There is likewise a cock, which is a piece of clock-work, that crows every hour. There are 700 steps up to the tower or steeple, it being 500 feet high. It was a free and imperial city; but the king of France became master of it in 1681, and greatly augmented the fortifications, though before it had as many cannon as there are days in the year. The inhabitants were formerly Protestants, and carried on a great trade; but most of them have been obliged to embrace the Romish superstition, though there is still a sort of toleration. Such was Strasburg before the French revolution; what it is now we have not leisure to inquire. It is seated on the river Ill, 55 miles north of Basle, 112 south-west of Mentz, and 255 east of Paris. E. Long. 7. 51. N. Lat. 48. 35.

Strasbourg,  
S rata.

**STRATA**, in natural history, the several beds or layers of different matters whereof the earth is composed. See QUARRY.

The strata whereof the earth is composed are so very different in different countries, that it is impossible to say any thing concerning them that may be generally applicable: and indeed the depths to which we can penetrate are so small, that only a very few can be known to

of his life, which we have laid before our readers, upon the express condition that we should not alter a *single word of it*; as the composition, we were told, would do *honour to our work*. We have observed the condition, and therefore cannot claim this honour to any of the usual writers in the Encyclopædia Britannica. If Sir Robert's more intimate friends shall be pleased with the article, their gratitude will be due not to us, but to some of his nearest relations; and what may appear its defects to others (for the tastes of mankind are very different), we trust will be supplied by the following authentic catalogue of his works: Plate 1. Two Heads of the author—one an etching, the other a finished proof, from a drawing by John Baptiste Greuse; 2. The Return from Market, by Wouvermans; 3. Cupid, by Vanloo; 4. Mary Magdalen, by Guido; 5. Cleopatra, by the same; 6. The Madonna, by the same; 7. The Angel Gabriel, by the same; 8. The Virgin, holding in her hand a book, and attended by angels, by Carlo Maratt; 9. The Virgin with the Child asleep, by the same; 10. Liberality and Modesty, by Guido; 11. Apollo rewarding Merit and punishing Arrogance, by Andrea Sacchi; 12. The Finding of Romulus and Remus, by Pietro da Cortona; 13. Cæsar repudiating Pompeia, by the same; 14. Three Children of King Charles I. by Vandyke; 15. Belisarius, by Salvator Rosa; 16. St Agnes, by Dominichino; 17. The Judgment of Hercules, by Nicolas Poussin; 18. Venus attired by the Graces, by Guido; 19 and 20. Justice and Meekness, by Raphael; 21. The Offspring of Love, by Guido; 22. Cupid sleeping, by the same; 23. Abraham giving up the Handmaid Hagar, by Guercino; 24. Esther a Suppliant before Ahasuerus, by the same; 25. Joseph and Potiphar's Wife, by Guido; 26. Venus Blinding Cupid, by Titian; 27. Venus, by the same; 28. Danae, by the same; 29. Portrait of King Charles I. by Vandyke; 30. The Madonna, by Correggio; 31. St Cæcilia, by Raphael; 32. Mary Magdalen, by Guido; 33. Our Saviour appearing to his Mother after his Resurrection, by Guercino; 34. A Mother and Child, by Parmegiano; 35. Cupid Meditating, by Schidoni; 36. Laomedon King of Troy detected by Neptune and Apollo, by Salvator Rosa; 37. The Death of Dido, by Guercino; 38. Venus and Adonis, by Titian; 39. Fortune, by Guido; 40. Cleopatra, by the same; 41. Two Childrea at School, by Schidoni; 42. Mary Magdalen, by Correggio; 43. Portrait of King Charles I. attended by the Marquis of Hamilton, by Vandyke; 44. Queen Henrietta, attended by the Prince of Wales, and holding in her Arms the Duke of York, by the same; 45. Apotheosis of the Royal Children, by West; 46. The Annunciation, by Guido; 47. Portrait of Raphael Sancio D'Urbino, by himself; 48. Sappho, by Carlo Dolci; 49. Our Saviour asleep, by Vandyke; 50. St John in the Desert, by Murillo.

Strata.

to us at any rate; those that lie near the centre, or even a great way from it, being for ever hid. One reason why we cannot penetrate to any great depth is, that as we go down the air becomes foul, loaded with pernicious vapours, inflammable air, fixed air, &c. which destroy the miners, and there is no possibility of going on. In many places, however, these vapours become pernicious much sooner than in others, particularly where sulphureous minerals abound, as in mines of metal, coal, &c.

But however great differences there may be among the under strata, the upper one is in some respects the same all over the globe, at least in this respect, that it is fit for the support of vegetables, which the others are not, without long exposure to the air. Properly speaking, indeed, the upper stratum of the earth all round, is composed of the pure vegetable mold, though in many places it is mixed with large quantities of other strata, as clay, sand, gravel, &c.; and hence proceed the differences of soils so well known to those who practise agriculture.

It has been supposed, by some naturalists, that the different strata of which the earth is composed were originally formed at the creation, and have continued in a manner immutable ever since: but this cannot possibly have been the case, since we find that many of the strata are strangely intermixed with each other; the bones of animals both marine and terrestrial are frequently found at great depths in the earth; beds of oyster-shells are found of immense extent in several countries; and concerning these and other shell-fish, it is remarkable, that they are generally found much farther from the surface than the bones or teeth either of marine or terrestrial animals. Neither are the shells or other remains of fish found in those countries adjoining to the seas where they grow naturally, but in the most distant regions. Mr Whitehurst, in his Inquiry into the Original State and Formation of the Earth, has given the following account of many different kinds of animals, whose shells and other remains or *exuvia* are found in England; though at present the living animals are not to be found except in the East and West Indies.

*A CATALOGUE of EXTRANEIOUS FOSSILS, showing where they were dug up; also their native Climates. Mostly selected from the curious Cabinet of Mr NELSON, in King-street, Red-Lion Square.*

Their names, and Places where found.	Native Climates.
CHAMBERED NAUTILUS. Sheppy Islands; Richmond in Surrey; Sherbone in Dorsetshire, -	} <i>Chinese Ocean, and other Parts of that great sea.</i>
TEETH OF SHARKS. Sheppy Island, Oxfordshire, Middlesex, Surrey, Northamptonshire, -	
SEA-TORTOISE, several kinds; the Hawk-bill, Loggerhead, and Green species. Sheppy Island, -	} <i>East and West Indies.</i>
MANGROVE-TREE OYSTERS. Sheppy Island, -	
COXCOMB-TREE OYSTERS. Oxfordshire, Gloucestershire, Dorsetshire, and Hanover, -	} <i>West Indies.</i>
VERTEBRÆ and PALATES of the ORBES. Sheppy Islands, and many other parts of England, -	

Their names, and Places where found.	Native Climates.	Strata.
CROCODILE. Germany, Derbyshire, Nottinghamshire, Oxfordshire, and Yorkshire, -	} <i>East and West Indies.</i>	}
ALLIGATOR'S TEETH. Oxfordshire, Sheppy Island, -		
THE BANDED BUCCINUM. Oxfordshire, and the Alps, -	} <i>West Indies.</i>	}
THE DIPPING-SNAIL, and STAR-FISH. Sheppy Island, -		
TAIL BUCCINUM. Sheppy Island, Hordel Cliff, Hampshire, -	} <i>East Indies.</i>	}

Nothing has more perplexed those who undertake to form theories of the earth than these appearances. Some have at once boldly asserted, from these and other phenomena, that the world is eternal. Others have had recourse to the universal deluge. Some, among whom is the Count de Buffon, endeavour to prove that the ocean and dry land are perpetually changing places; that for many ages the highest mountains have been covered with water, in consequence of which the marine animals just mentioned were generated in such vast quantities, that the waters will again cover these mountains, the habitable part of the earth become sea, and the sea become dry land as before, &c. Others have imagined that they might be occasioned by volcanoes, earthquakes, &c. which confound the different strata, and often intermix the productions of the sea with those of the dry land.

These subjects have been discussed under the article EARTH, to which therefore we refer the reader; and shall conclude with some account of the strata in those places where they have been most particularly observed.

Under the article NATURAL HISTORY, Sect. I. it is observed, that the upper strata of the earth and mountains generally consist of rag stone, the next of slate, the third of marble filled with petrifications, the fourth again of slate, and the next of free stone. But we are far from considering this as a rule which holds universally. The strata differ exceedingly in a great number of places; some instances of which we shall give from Mr Whitehurst.—At Alfreton Common in Derbyshire, the strata are,

*A TABLE of the STRATA at ALFRETON COMMON.*

Numb.	Feet.	Inch.	Earth, P.
1 CLAY	7	0	211.
2 RATCHELL, fragments of stone	9	0	
3 BIND indurated clay	13	4	
4 STONE, argillaceous concreted clay	6	0	
5 BIND	8	8	
6 BIND	25	0	
7 STONE, a black colour	5	0	
8 BIND	2	0	
9 STONE	2	0	
10 BIND	5	0	
11 BIND	5	0	
12 COAL	1	6	
13 BIND	1	6	
14 STONE	23	0	
15 STONE	14	0	
16 BIND	7	0	
17 SMUTT, a black substance, resembling a stratum of coal-dust	3	0	

Strata.	Numb.	Brought over	Feet.	Inch.
			138	0
18	BIND	-	3	0
19	STONE	-	20	0
20	BIND	-	16	0
21	COAL	-	7	4
			<hr/>	
			184	4

A TABLE of the STRATA at WEST HALLAM.

Numb.	Feet.	Inch.	
1 CLAY	7	6	
2 BIND	48	0	
3 SMUTT	1	6	
4 CLUNCH, or indurated clay	4	0	
5 BIND	3	0	
6 STONE	2	3	
7 BIND	1	0	
8 STONE	1	0	
9 BIND	3	0	
10 STONE	1	0	
11 BIND	16	0	
12 SHALE	2	0	
13 BIND	12	0	
14 SHALE	3	0	
15 CLUNCH, stone and sometimes cank	54	0	
16 SOFT COAL	4	0	
17 CLAY	0	6	
18 SOFT COAL	4	6	
19 CLUNCH and BIND	21	0	
20 COAL	1	0	
21 BIND	1	0	
22 Strong, broad BIND	25	0	
23 COAL	6	0	
		<hr/>	
		222	3

Mr Forster has given an account of some of the strata of the South-Sea islands, the substance of which may be seen in the following table.

SOUTH GEORGIA.

1. No soil, except in a few crevices of the rocks.
2. Ponderous slate, with some iron particles, in horizontal strata, perpendicularly intersected with veins of quartz.

Southern Isle of NEW ZEALAND.

1. Fine light black mould, in some places nine inches deep, but generally not so much.
2. An argillaceous substance, nearly related to the class of TALCONS, turned into earth by the action of the air.
3. The same substance farther indurated, in oblique strata, generally dipping to the south.

EASTER ISLAND.

1. Reddish-brown dusty mould, looking as if it had been burnt.
2. Burnt rocks, resembling flags or dross and other volcanic matters.

MARQUESAS.

1. Clay mixed with mould.
2. An earthy argillaceous substance mixed with tarras and puzzolana.

OTAKEITE.

The shores are coral rock, extending from the reef encircling these isles to the very high water-mark.

There begins the sand, formed in some places from small shells and rubbed pieces of coral; but in others the shores are covered with blackish sand, consisting of the former sort mixed with black, sometimes glittering, particles of mica, and here and there some particles of the refractory iron ores called in England SKIM, the *ferrum micaceum* of Linnæus, and KALL the *molybdenum spuma lupi* of the same author. The plains from the shores to the foot of the hills are covered with a very fine thick stratum of black mould, mixed with the above-mentioned sand, which the natives manure with shells. The first and lower range of hills are formed of a red ochreous earth, sometimes so intensely red, that the natives use it to paint their canoes and cloth. The higher hills consist of a hard, compact, and stiff clayey substance, hardening into stone when out of the reach of the sun and air. At the top of the valleys, along the banks of the rivers, are large masses of coarse granite stones of various mixtures; in one place are pillars of a grey, solid basalt; and, in several others, fragments of black basalt.

FRIENDLY ISLANDS and NEW HEBRIDES.

The same with the above.

MALLICOLLO.

Yellowish clay mixed with common sand.

TANNA, a Volcanic Island.

The chief strata here are clay mixed with aluminous earth, interspersed with lumps of pure chalk. The strata of the clay are about six inches, deviating very little from the horizontal line.

NEW CALEDONIA and the adjacent Isles.

The shores consist of shell-sand, and particles of quartz; the soil in the plains a black mould mixed with this sand. The sides of the hills composed of a yellow ochreous clay, richly spangled with small particles of cat-silver, or a whitish kind of daze, the *mica argentea* of Linnæus. The higher parts of the hills consist of a stone called by the German miners *gestelstein*, composed of quartz and great lumps of the above cat-silver. The latter is sometimes of an intensely red or orange colour, by means of an iron ochre.

“From the above account, says Mr Forster, it appears, I think, evidently, that all the high tropical isles of the South-Sea have been subject to the action of volcanoes. Pyritical and sulphureous substances, together with a few iron-stones, and some vestiges of copper, are no doubt found in several of them; but the mountains of New Caledonia are the most likely to contain the richest metallic veins; and the same opinion, I suspect, may be formed of the mountains in New Zealand.”

In the city of Modena in Italy, and for some miles round that place, there is the most singular arrangement of strata perhaps in the whole world. From the surface of the ground to the depth of 14 feet, they meet with nothing but the ruins of an ancient city. Being come to that depth, they find paved streets, artificers shops, floors of houses, and several pieces of inlaid work. After these ruins they find a very solid earth, which one would think had never been removed; but a little lower they find it black and marshy, and full of briars. Signior Ramazzini in one place found a heap of wheat entire at the depth of 24 feet; in another, he found

silbert-

**Strata** ||  
**Strategus.** ||  
 filbert-trees with their nuts. At the depth of about 28 feet, they find a bed of chalk, about 11 feet deep, which cuts very easily; after this a bed of marshy earth of about two feet, mixed with rushes, leaves, and branches. After this bed comes another of chalk, nearly of the same thickness; and which ends at the depth of 42 feet. This is followed by another bed of marshy earth like the former; after which comes a new chalk-bed, but thinner, which also has a marshy bed underneath it. This ends at the depth of 63 feet; after which they find sand mingled with small gravel, and several marine shells. This stratum is usually about five feet deep, and underneath it is a vast reservoir of water. It is on account of this water that the soil is so frequently dug, and the strata so well known in this part of the world. After coming to the sandy bottom above-mentioned, the workmen pierce the ground with a terebra or auger, when the water immediately springs up with great force, and fills the well to the brim. The flow is perpetual, and neither increases by rain, nor decreases by drought. Sometimes the auger meets with great trees, which give the workmen much trouble; they also sometimes see at the bottom of these wells great bones, coals, flints, and pieces of iron.

It has been asserted by some, that the specific gravity of the strata constantly increased with the depth from the surface. But Dr Leigh, in his Natural History of Lancashire, speaking of the coal-pits, denies the strata to lie according to the laws of gravitation; observing, that the strata there are first a bed of marl, then free-stone, next iron-stone, then coal, or channel mire, then some other strata, then coal again, &c. This determined Mr Derham to make a nicer inquiry into the matter: accordingly, in 1712, he caused divers places to be bored, laying the several strata by themselves; and afterwards determined very carefully their specific gravity. The result was, that in his yard the strata were gradually specifically heavier and heavier the lower and lower they went; but in another place in his fields, he could not perceive any difference in the specific gravities.

Acquainting the Royal Society therewith, their operator Mr Hauksbee was ordered to try the strata of a coal pit, which he did to the depth of 30 strata: the thickness and specific gravity of each whereof he gives us in a table in the Philosophical Transactions; and from the whole makes this inference, that it evidently appears the gravities of the several strata are in no manner of order, but purely casual, as if mixed by chance.

**STRATAGEM**, in the art of war, any device for deceiving and surprising an enemy. The ancients dealt very much in stratagems; the moderns wage war more openly, and on the square. Frontinus has made a collection of the ancient stratagems of war.

**STRATEGUS**, στρατηγός, in antiquity, an officer among the Athenians, whereof there were two chosen yearly, to command the troops of the state.

Plutarch says, there was one chosen from out of each tribe; but Pollux seems to say they were chosen indifferently out of the people. The people themselves made the choice; and that on the last day of the year,

in a place called *Pnyx*. The two *strategi* did not command together, but took their turns day by day; as we find from Herodotus and Cornelius Nepos. Sometimes indeed, as when a person was found of merit vastly superior, and exceedingly famed in war, the command was given to him alone: but it was ever a rule, not to put any person in the office but whose estate was in Attica, and who had children, that there might be some hostages and securities for his conduct and fidelity. Constantine the Great, besides many other privileges granted to the city of Athens, honoured its chief magistrate with the title of *M. C. C. Strategus, Magnus Dux*.

**STRATH**, in the Scottish language, signifies a long narrow valley, with a river running along the bottom.

**STRATHHEARN**, a beautiful and extensive valley in Perthshire, bounded on the north by the lofty ridge of mountains called the *Grampians*, and on the south by the Ochils, which are rounded on the tops and covered with verdure. It is called *Strathhearn* from the river Earn, which runs through the middle of it from west to east for about 30 miles. On each side of the banks of this beautiful stream are many villages and country-seats distinguished for romantic situations. Were we to single out any of the villages, we would mention Crieff, which stands on a fine sloping ground on the north side of the Earn, and has been much admired by travellers for its situation, and the variety, contrast, singularity, and beauty of the prospect which it affords.

**STRATHNAVER**, a subdivision or district of the county of Sutherland in Scotland; bounded on the north by the ocean, on the east by Caithness, on the south by Sutherland properly so called, and on the west partly by Ross and partly by the ocean.

**STRATIOTES**, **WATER-SOLDIER**, in botany: A genus of plants belonging to the class of *polyandria*, and to the order of *hexagynia*; and in the natural system ranging under the first order, *palmæ*. The spathe is diöhyllous: the perianthium is trifid. There are three petals, and the berry is six-celled and inferior. There are three species, the aloides, the acrooides, and alismoides. The *aloides* alone is of British extraction, which is also called the *water aloe*, or *fresh-water soldier*. The root consists of long fibres tufted at the ends. The leaves are thick, triangular, pointed, and prickly at the edges. The flowers are white and floating on the water, and blossom in June. This plant may be seen in slow rivers and fens.

**STRATO**, a philosopher of Lampsaecus, disciple and successor in the school of Theophrastus, about 248 years before the Christian era. He applied himself with uncommon industry to the study of nature; and after the most mature investigations, he supported that nature was inanimate, and that there was no god but nature. (See *PLASTIC NATURE*). He was appointed preceptor to Ptolemy Philadelphus, who not only revered his abilities and learning, but also rewarded his labours with unbounded liberality. He wrote different treatises, all now lost.

**STRAWBERRY**, in botany. See *FRAGARIA*.  
**STRAWBERRY-Tree**. See *ARBUTUS*.

Strath  
 ||  
 Strawberry.

E R R A T A :

- VOL. III. p. 124. col. 2. l. 11. For "yet brought," read "not yet brought."  
 p. 258. col. 1. l. 20. For "in the 50th," read "in the 57th."
- VOL. IX. p. 470. col. 1. l. 20. A correspondent says, for "summer assizes," read "spring assizes."
- VOL. X. p. 7. col. 2. l. 22. from bottom. For "isofceles rectangle," read "isofceles triangle."  
 p. 119. col. 1. l. 13. from bottom. For "αριθμηθη," read "αριθμοι."  
 p. 471. col. 2. l. 27. For "prevents," read "perverts."  
 p. 542. col. 1. l. 1. from bottom. Erase the sentence beginning with "It is an earldom."  
 p. 549. col. 2. l. 37. For "him," read "he."
- VOL. XIII. p. 204. col. 2. l. 17. For "after the 364th, in the year 440," read "in the year 312, or, as Cc-  
 drenus says, in the year 393."
- VOL. XIV. p. 67. col. 2. l. 27. For "St Claget," read "Dr Claget."
- VOL. XVI. p. 196. col. 2. l. 23. Instead of the sentence beginning with "In the mean time," read "On  
 the 9th June Admiral Montague fell in with the French fleet returning  
 to port, amounting to 19 fail of the line."  
 p. 682. col. 1. l. 37. For "Milan," read "Misnaw."  
 p. 696. col. 2. l. 3. For "σκηπτικος," read "σκηπτικος;" and for "σκηπτομαν," read "σκηπτομαι."
- VOL. XVII. p. 180. col. 2. l. 16. from bottom. For "covers them," read "it covers."  
 p. 524. col. 2. l. 12. For "where," read "when."  
 p. 533. col. 2. l. 30. After the word "likewise" add "possible."  
 p. 556. col. 2. l. 18. from bottom. Erase the sentence beginning with the word "Candidates."  
 p. 671. col. 2. l. 23. Erase the word "regius."  
 p. 678. col. 2. l. 12. For "αγγιλος," read "αγγιλος."  
 p. 728. col. 2. l. 18. For "Balydrene," read "Balydrone."  
 p. 729. col. 1. l. 41. For "1669," read "1769."

DIRECTIONS FOR PLACING THE PLATES OF VOL. XVII.

PART I.			
Plate	CCCCXLVII. to face	-	Page 220
	CCCCXLVIII.	-	240
	CCCCXLIX.	-	300
	CCCCL. } CCCCLI. } CCCCLII. }	- - -	368
	CCCCLIII.	-	370
	CCCCLIV.	-	379
	CCCCLV.	-	382
	CCCCLVI. } CCCCLVII. }	- -	384
	CCCCLVIII.	-	386
	CCCCLIX.	-	388
	CCCCLX.	-	392
	CCCCLXI.	-	396
PART II.			
	CCCCLXII. } CCCCLXIII. } CCCCLXIV. }	- - -	424
Plate	CCCCLXV. to face	-	Page 424
	CCCCLXVI.	-	488
	CCCCLXVII. } CCCCLXVIII. } CCCCLXIX. }	- - -	502
	CCCCLXX.	-	558
	CCCCLXXI.	-	659
	CCCCLXXII.	-	619
	CCCCLXXIII.	-	691
	CCCCLXXIV.	-	708
	CCCCLXXV.	-	713
	CCCCLXXVI.	-	768
	CCCCLXXVII. } CCCCLXXVIII. } CCCCLXXIX. }	- - -	770
	CCCCLXXX.	-	784
	CCCCLXXXI.	-	790
	CCCCLXXXII. } CCCCLXXXIII. }	- -	790

